

CBR04C919C2GAC

CBR-SMD RF COG, Ceramic, 9.1 pF, +/-0.25 pF, 200 VDC, COG, SMD, Fixed, RF, Ultra High Q, Low ESR, Class I, 0402

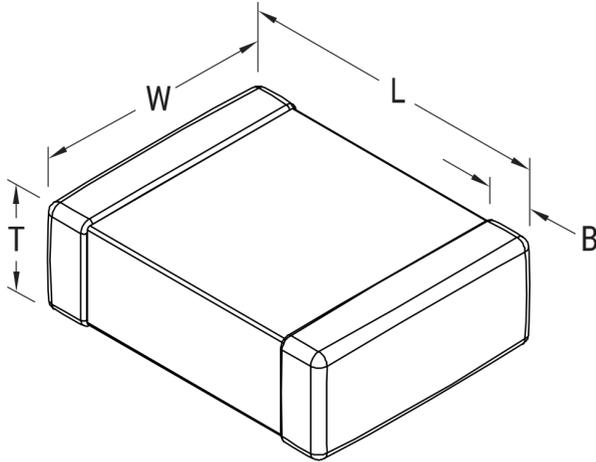

Click [here](#) for the 3D model.

Dimensions	
Chip Size	0402
L	1mm +/-0.05mm
W	0.5mm +/-0.05mm
T	0.5mm +/-0.05mm
B	0.25mm +0.05/-0.1mm

Packaging Specifications	
Packaging	T&R, 180mm, Plastic Tape
Packaging Quantity	10000

General Information	
Series	CBR-SMD RF COG
Style	SMD Chip
Description	SMD, Fixed, RF, Ultra High Q, Low ESR, Class I
Features	Ultra High Q, Low ESR, Class I
RoHS	Yes
Termination	Tin
Marking	No
AEC-Q200	No
Component Weight	1.4 mg
Notes	Solder Reflow Only.
Shelf Life	78 Weeks
MSL	1

Specifications	
Capacitance	9.1 pF
Capacitance Tolerance	+/-0.25 pF
Voltage DC	200 VDC
Dielectric Withstanding Voltage	500 VDC
Temperature Range	-55/+125°C
Temperature Coefficient	COG
Aging Rate	0% Loss/Decade Hour
Insulation Resistance	10 GOhms
Quality Factor	582

Statements of suitability for certain applications are based on our knowledge of typical operating conditions for such applications, but are not intended to constitute - and we specifically disclaim - any warranty concerning suitability for a specific customer application or use. This information is intended for use only by customers who have the requisite experience and capability to determine the correct products for their application. Any technical advice inferred from this information or otherwise provided by us with reference to the use of our products is given gratis, and we assume no obligation or liability for the advice given or results obtained.