

Overview

The KEMET ALC10 snap-in capacitors covers a wide range of case sizes and voltage ratings. The ALC10 is designed for high voltage, it is up to 600 VDC, has high ripple current applications and features surge voltage capability and very long-life performance.

Applications

The KEMET ALC10 capacitors are ideally suited for industrial and commercial applications demanding high reliability and long life expectancy. Typical applications include frequency converters, uninterruptible power supply (UPS) systems and switch mode power supplies (SMPS).

Benefits

- Compact size
- Long life, up to 18,000 hours at +85°C (V_R, I_R applied)
- High ripple current
- High voltage
- Excellent surge voltage capability
- Optimized designs available upon request

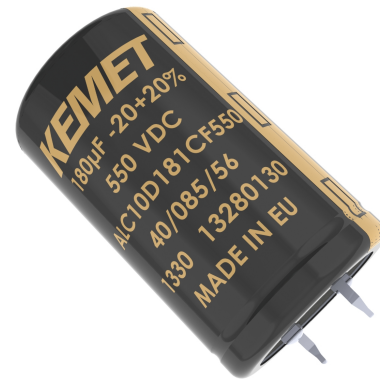

Part Number System

ALC10	A	392	BB	040	
Series	Termination	Capacitance Code (µF)	Size Code	Rated Voltage (VDC)	
Snap-In Aluminum Electrolytic	See Termination Table	First two digits represent significant figures. Third digit specifies number of zeros.	See Dimension Table	035 = 35 040 = 40 063 = 63 100 = 100 200 = 200 250 = 250	350 = 350 400 = 400 450 = 450 500 = 500 550 = 550 600 = 600

Performance Characteristics

Item	Performance Characteristics		
Capacitance Range	47 – 100,000 μ F		
Rated Voltage	35 – 600 VDC		
Operating Temperature	-40 to +85°C		
Capacitance Tolerance	\pm 20% at 100 Hz/+20°C		
Operational Lifetime	D (mm)	Rated Voltage and Ripple Current at +85°C (hours)	Rated Voltage at +85°C (hours)
	25	10,000	16,000
	30	13,000	21,000
	35	15,000	24,000
	40 – 50	18,000	29,000
End of Life Requirement	Δ C/C < \pm 10%, ESR < 2 x initial ESR value, IL < initial specified limit		
Shelf Life	2,000 hours at +85°C or 30,000 hours at +40°C 0 VDC		
Leakage Current	I = 0.006 CV or 6,000 (μ A, whichever is smaller)		
	C = rated capacitance (μ F), V = rated voltage (VDC). Voltage applied for 5 minutes at +20°C.		
Vibration Test Specifications		Procedure	Requirements
	D \leq 40 mm	0.75 mm displacement amplitude or 10 G maximum acceleration. Vibration applied for three 2-hour sessions at 10 – 500 Hz (capacitor clamped by body).	No leakage of electrolyte or other visible damage. Deviations in capacitance from initial measurements must not exceed: Δ C/C < 5%
D > 40 mm	0.35 mm displacement amplitude or 5 G maximum acceleration. Vibration applied for three 0.5-hour sessions at 10 – 55 Hz (capacitor clamped by body).		
Standards	IEC 60384-4 long life grade 40/85/56		

Surge Voltage

Condition	Voltage (VDC)											
	35	40	63	100	200	250	350	400	450	500	550	600
\leq 30s Surge followed by a no load period of 330s, 1,000 cycles at +85°C	40.25	46	72.5	115	230	288	385	440	495	550	605	660

Test Method & Performance

Endurance Life Test		
Conditions	Performance	
Temperature	+85°C	
Test Duration	2,000 hours	
Ripple Current	Rated ripple current in specified table	
Voltage	The sum of DC voltage and the peak AC voltage must not exceed the rated voltage of the capacitor	
Performance	The following specifications will be satisfied when the capacitor is tested at +20°C:	
Capacitance Change	≤ 160 V	Within 15% of the initial value
	≥ 160 V	Within 10% of the initial value
Equivalent Series Resistance	Does not exceed 200% of the initial value	
Leakage Current	Does not exceed leakage current limit	

Dimensions – Millimeters

Size Code	Dimensions in mm		Approximate Weight Grams
	D	L	
	-0/+1	±2	
BB	25	30	28
BC	25	35	30
BD	25	40	35
CB	30	30	35
CC	30	35	40
CD	30	40	45
CE	30	45	50
CF	30	50	55
DB	35	30	42
DC	35	35	50
DD	35	40	55
DE	35	45	65
DF	35	50	70
DG	35	55	75
DH	35	60	80
DL	35	80	105
EB	40	30	49
EC	40	35	57
ED	40	40	65
EE	40	45	80
EF	40	50	82
EG	40	55	95

Note: Dimensions include sleeving

Size Code	Dimensions in mm		Approximate Weight Grams
	D	L	
	-0/+1	±2	
EH	40	60	98
EJ	40	70	113
EL	40	80	131
EP	40	105	170
FB	45	30	62
FC	45	35	72
FD	45	40	82
FE	45	45	92
FF	45	50	103
FG	45	55	113
FH	45	60	123
FL	45	80	164
FP	45	105	215
KB	50	30	75
KC	50	35	88
KD	50	40	100
KE	50	45	113
KF	50	50	126
KG	50	55	138
KH	50	60	151
KL	50	80	201
KP	50	105	264

Note: Dimensions include sleeving

Termination Tables

Termination Code	A	D	F	C	E	G	H
Diameter (mm)							
25	•	•	•				
30	•	•	•				
35	•	•	•	•	•		
40	•	•	•	•	•	•	•
45				•	•	•	•
50				•	•	•	•

Mounting: These capacitors are designed to be mounted by their terminations alone and may be used in any position. Dummy pins must be isolated on 4 and 5 pin styles.

Termination Code	Termination Style	LL
		±1
Standard Termination Option		
A	2 Pin	6.3
G (D ≥ 45)	5 Pin	6.3
Other Termination Options		
D	2 Pin	4.0
F	3 Pin	4.0
C	4 Pin	6.3
E	4 Pin	4.0
H	5 Pin	4.0
Dimensions in mm		

Termination Tables cont.

Style A/D

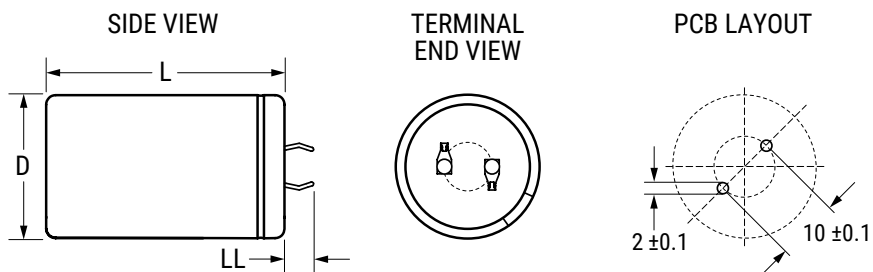

Style F

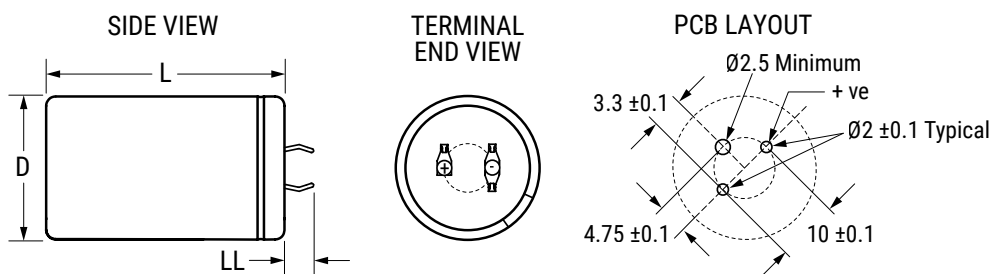

Style C/E

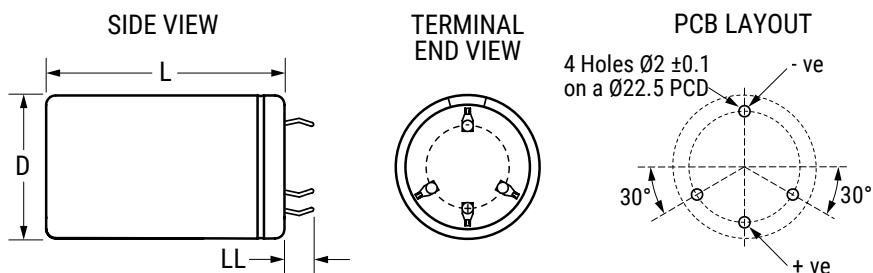

Style G/H

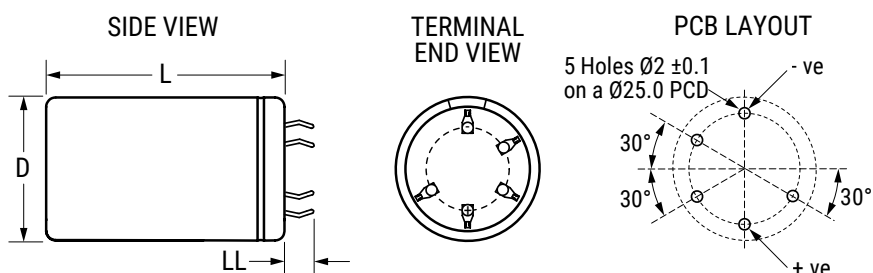

Shelf Life

The capacitance, ESR and impedance of a capacitor will not change significantly after extended storage periods, however, the leakage current will very slowly increase. KEMET products are particularly stable and allow a shelf life in excess of three years at 40°C. See sectional specification under each product for specific data.

Re-age (Reforming) Procedure

Apply the rated voltage to the capacitor at room temperature for a period of one hour, or until the leakage current has fallen to a steady value below the specified limit. During re-aging, a maximum charging current of twice the specified leakage current or 5 mA (whichever is greater) is suggested.

Reliability

The reliability of a component can be defined as the probability that it will perform satisfactorily under a given set of conditions for a given length of time.

In practice, it is impossible to predict with absolute certainty how any individual component will perform. Therefore, we must utilize probability theory. It is also necessary to clearly define the level of stress involved (e.g., operating voltage, ripple current, temperature and time.) Finally, the meaning of satisfactory performance must be defined by specifying a set of conditions which determine the end of life of the component.

Reliability as a function of time, $R(t)$, is normally expressed as: $R(t) = e^{-\lambda t}$, where $R(t)$ is the probability that the component will perform satisfactorily for time t , and λ is the failure rate.

Failure Rate

The failure rate is the number of components failing per unit of time. The failure rate of most electronic components follows the characteristic pattern:

- Early failures are removed during the manufacturing process.
- The operational life is characterized by a constant failure rate.
- The wear out period is characterized by a rapidly increasing failure rate.

The failures in time (FIT) are given with a 60% confidence level for the various type codes. By convention, FIT is expressed as 1×10^{-9} failures per hour. Failure rate is also expressed as a percentage of failures per 1,000 hours, e.g., 100 FIT = 1×10^{-7} failures per hour = 0.01%/1,000 hours.

End of Life Definition

Catastrophic Failure: short circuit, open circuit or safety vent operation

Parametric Failure:

- Change in capacitance > $\pm 10\%$
- Leakage current > specified limit
- ESR > 2 x initial ESR value

MTBF

The mean time between failures (MTBF) is simply the inverse of the failure rate.

$MTBF = 1/\lambda$

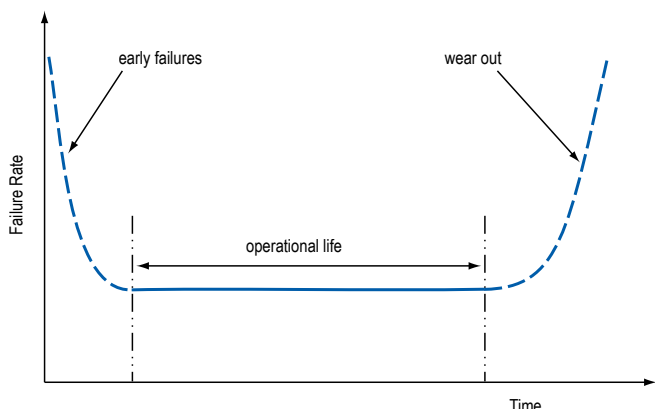

The failure rate is derived from our periodic test results. The failure rate (λ_R) is, therefore, only given at test temperature for life tests. An estimation is also given at 40°C. The expected failure rate for this capacitor range is based on our periodic test results for capacitors with structural similarity. Failure rate is frequently quoted in FIT (Failures In Time) where 1 FIT = 1 x 10⁻⁹ failures per hour. Failure rate per hour includes both catastrophic and parametric failures.

T _a	Failure Rate per Hour
85°C	250 FIT
40°C	12 FIT

Environmental Compliance



All Part Numbers in this datasheet are Reach and RoHS compliant.

As an environmentally conscious company, KEMET is working continuously with improvements concerning the environmental effects of both our capacitors and their production.

In Europe (RoHS Directive) and in some other geographical areas such as China, legislation has been put in place to prevent the use of some hazardous materials, such as lead (Pb), in electronic equipment. All products in this catalog are produced to help our customers' obligations to guarantee their products and fulfill these legislative requirements. The only material of concern in our products has been lead (Pb), which has been removed from all designs to fulfill the requirement of containing less than 0.1% of lead in any homogeneous material. KEMET will closely follow any changes in legislation worldwide and make any necessary changes in its products, whenever needed.

Some customer segments such as medical, military and automotive electronics may still require the use of lead in electrode coatings. To clarify the situation and distinguish products from each other, a special symbol is used on the packaging labels for RoHS compatible capacitors.

Due to customer requirements, there may appear additional markings such as lead-free (LF), or lead-free wires (LFW) on the label.

Table 1 – Ratings & Part Number Reference

VDC	Rated Capacitance	Size Code	Case Size	Ripple Current		ESR Maximum	Impedance Maximum	Part Number
	100 Hz 20°C (µF)		D x L (mm)	100 Hz 85°C (A)	10 kHz 85°C (A)	100 Hz 20°C (mΩ)	10 kHz 20°C (mΩ)	
35	33000	EF	40 x 50	7.16	10.03	42	38	ALC10(1)333EF035
35	56000	EL	40 x 80	11.68	12.92	23	21	ALC10(1)563EL035
35	100000	EP	40 x 105	14.18	15.39	17	16	ALC10(1)104EP035
40	3900	BB	25 x 30	2.33	2.53	125	103	ALC10(1)392BB040
40	4700	BC	25 x 35	2.77	3.01	99	81	ALC10(1)472BC040
40	5600	CB	30 x 30	2.74	2.98	115	94	ALC10(1)562CB040
40	5600	BD	25 x 40	3.14	3.42	85	70	ALC10(1)562BD040
40	6800	CC	30 x 35	3.26	3.55	90	74	ALC10(1)682CC040
40	8200	CD	30 x 40	3.70	4.03	77	63	ALC10(1)822CD040
40	10000	DC	35 x 35	3.69	4.01	86	71	ALC10(1)103DC040
40	12000	CF	30 x 50	4.59	4.99	59	48	ALC10(1)123CF040
40	12000	DD	35 x 40	4.14	4.50	75	62	ALC10(1)123DD040
40	15000	EB	40 x 30	4.42	4.51	89	79	ALC10(1)153EB040
40	18000	DF	35 x 50	5.23	5.69	55	45	ALC10(1)183DF040
40	18000	EC	40 x 35	4.88	4.97	78	70	ALC10(1)183EC040
40	22000	ED	40 x 40	5.81	5.92	62	56	ALC10(1)223ED040
40	27000	EF	40 x 50	7.23	7.36	43	38	ALC10(1)273EF040
40	33000	EH	40 x 60	8.74	8.91	33	30	ALC10(1)333EH040
40	47000	EL	40 x 80	10.96	11.17	23	21	ALC10(1)473EL040
40	82000	EP	40 x 105	12.63	13.44	18	17	ALC10(1)823EP040
63	2200	BB	25 x 30	2.13	2.37	149	118	ALC10(1)222BB063
63	2700	BC	25 x 35	2.43	2.70	128	101	ALC10(1)272BC063
63	3300	CB	30 x 30	2.77	3.08	112	88	ALC10(1)332CB063
63	3300	BD	25 x 40	2.73	3.04	112	88	ALC10(1)332BD063
63	4700	CC	30 x 35	3.24	3.61	91	72	ALC10(1)472CC063
63	5600	CD	30 x 40	3.56	3.96	83	66	ALC10(1)562CD063
63	6800	DC	35 x 35	3.95	4.40	75	59	ALC10(1)682DC063
63	6800	CF	30 x 50	4.07	4.53	75	59	ALC10(1)682CF063
63	8200	DD	35 x 40	4.31	4.80	69	55	ALC10(1)822DD063
63	8200	EB	40 x 30	3.95	4.03	82	72	ALC10(1)822EB063
63	10000	DF	35 x 50	4.85	5.40	64	51	ALC10(1)103DF063
63	10000	EC	40 x 35	4.58	4.67	80	72	ALC10(1)103EC063
63	12000	ED	40 x 40	5.42	5.55	64	57	ALC10(1)123ED063
63	15000	EF	40 x 50	7.02	7.18	44	39	ALC10(1)153EF063
63	18000	EH	40 x 60	8.54	8.75	35	31	ALC10(1)183EH063
63	27000	EL	40 x 80	10.53	10.78	24	21	ALC10(1)273EL063
63	39000	EP	40 x 105	12.23	13.51	19	17	ALC10(1)393EP063
100	1000	BB	25 x 30	1.67	2.04	243	182	ALC10(1)102BB100
100	1200	BC	25 x 35	1.93	2.36	203	152	ALC10(1)122BC100
100	1500	CB	30 x 30	2.30	2.81	163	122	ALC10(1)152CB100
100	1500	BD	25 x 40	2.27	2.78	163	122	ALC10(1)152BD100
100	1800	CC	30 x 35	2.64	3.23	137	103	ALC10(1)182CC100
100	2200	CD	30 x 40	3.05	3.73	113	85	ALC10(1)222CD100
100	2700	DC	35 x 35	3.57	4.37	92	69	ALC10(1)272DC100
100	2700	EB	40 x 30	3.72	3.88	121	104	ALC10(1)272EB100
100	3300	CF	30 x 50	4.05	4.95	76	57	ALC10(1)332CF100
100	3300	DD	35 x 40	4.11	5.03	76	57	ALC10(1)332DD100
100	3300	EC	40 x 35	4.09	4.24	106	92	ALC10(1)332EC100
100	3900	ED	40 x 40	4.88	5.08	85	74	ALC10(1)392ED100
100	4700	DF	35 x 50	5.23	6.40	55	41	ALC10(1)472DF100
100	4700	EE	40 x 45	5.60	5.83	70	61	ALC10(1)472EE100
100	5600	EF	40 x 50	6.41	6.68	59	51	ALC10(1)562EF100
100	6800	EG	40 x 55	6.61	6.84	53	46	ALC10(1)682EG100
100	8200	EH	40 x 60	7.36	7.61	44	39	ALC10(1)822EH100
100	12000	EL	40 x 80	9.14	9.45	31	27	ALC10(1)123EL100
100	18000	EP	40 x 105	11.34	12.61	19	17	ALC10(1)183EP100
200	330	BB	25 x 30	1.18	1.63	486	340	ALC10(1)331BB200
200	390	BC	25 x 35	1.36	1.87	412	288	ALC10(1)391BC200
200	470	CB	30 x 30	1.58	2.18	343	240	ALC10(1)471CB200
200	470	BD	25 x 40	1.56	2.15	343	240	ALC10(1)471BD200

(1) Termination code: See Termination Tables for available options.

Table 1 – Ratings & Part Number Reference cont.

VDC	Rated Capacitance	Size Code	Case Size	Ripple Current		ESR Maximum	Impedance Maximum	Part Number
	100 Hz 20°C (µF)		D x L (mm)	100 Hz 85°C (A)	10 kHz 85°C (A)	100 Hz 20°C (mΩ)	10 kHz 20°C (mΩ)	
200	560	CC	30 x 35	1.82	2.51	288	202	ALC10(1)561CC200
200	680	CD	30 x 40	2.10	2.89	238	167	ALC10(1)681CD200
200	820	DC	35 x 35	2.43	3.35	198	139	ALC10(1)821DC200
200	820	EB	40 x 30	3.06	3.63	178	142	ALC10(1)821EB200
200	1000	CF	30 x 50	2.76	3.80	163	114	ALC10(1)102CF200
200	1000	DD	35 x 40	2.81	3.87	163	114	ALC10(1)102DD200
200	1000	EC	40 x 35	3.43	3.99	153	124	ALC10(1)102EC200
200	1200	DF	35 x 50	3.06	4.01	135	82	ALC10(1)122DF200
200	1200	ED	40 x 40	4.02	4.69	124	99	ALC10(1)122ED200
200	1500	DF	35 x 50	3.70	5.10	110	77	ALC10(1)152DF200
200	1500	EE	40 x 45	4.61	5.38	101	81	ALC10(1)152EE200
200	1800	EF	40 x 50	5.27	6.15	84	68	ALC10(1)182EF200
200	2200	EH	40 x 60	6.29	7.43	67	53	ALC10(1)222EH200
200	3300	EL	40 x 80	7.83	9.17	46	37	ALC10(1)332EL200
200	4700	EP	40 x 105	8.08	11.73	45	32	ALC10(1)472EP200
200	5600	FP	45 x 105	8.51	12.16	42	29	ALC10(1)562FP200
200	8200	KP	50 x 105	9.17	11.76	33	25	ALC10(1)822KP200
250	220	BB	25 x 30	0.97	1.41	727	473	ALC10(1)221BB250
250	270	BC	25 x 35	1.13	1.65	593	385	ALC10(1)271BC250
250	330	CB	30 x 30	1.33	1.94	486	316	ALC10(1)331CB250
250	330	BC	25 x 35	1.34	1.95	490	320	ALC10(1)331BC250
250	330	BD	25 x 40	1.31	1.91	486	316	ALC10(1)331BD250
250	470	CC	30 x 35	1.67	2.43	343	223	ALC10(1)471CC250
250	560	CD	30 x 40	1.91	2.78	288	187	ALC10(1)561CD250
250	680	DC	35 x 35	2.22	3.23	238	155	ALC10(1)681DC250
250	680	CF	30 x 50	2.29	3.34	238	155	ALC10(1)681CF250
250	680	EB	40 x 30	2.79	3.56	187	144	ALC10(1)681EB250
250	820	DD	35 x 40	2.55	3.72	198	129	ALC10(1)821DD250
250	820	ED	40 x 40	3.80	4.91	153	116	ALC10(1)821ED250
250	1000	DF	35 x 50	3.26	4.75	163	106	ALC10(1)102DF250
250	1000	EE	40 x 45	4.33	5.58	126	96	ALC10(1)102EE250
250	1200	DH	35 x 60	3.76	5.48	140	100	ALC10(1)122DH250
250	1200	EF	40 x 50	4.94	6.37	104	80	ALC10(1)122EF250
250	1500	EG	40 x 55	5.29	6.58	89	69	ALC10(1)152EG250
250	1800	DL	35 x 80	4.60	6.69	100	82	ALC10(1)182DL250
250	1800	EH	40 x 60	5.92	7.34	74	58	ALC10(1)182EH250
250	2200	EL	40 x 80	7.33	9.49	57	43	ALC10(1)222EL250
250	3900	EP	40 x 105	7.78	11.71	46	32	ALC10(1)392EP250
250	4700	FP	45 x 105	8.22	12.11	42	29	ALC10(1)472FP250
250	5600	KP	50 x 105	8.63	12.03	38	27	ALC10(1)562KP250
350	120	BB	25 x 30	0.83	1.75	1139	736	ALC10(1)121BB350
350	150	BC	25 x 35	0.99	2.07	912	589	ALC10(1)151BC350
350	180	BD	25 x 40	1.13	2.37	761	492	ALC10(1)181BD350
350	180	CB	30 x 30	1.11	2.19	776	506	ALC10(1)181CB350
350	270	CC	30 x 35	1.41	2.65	527	346	ALC10(1)271CC350
350	330	CD	30 x 40	1.65	3.07	432	284	ALC10(1)331CD350
350	330	EB	40 x 30	2.02	3.97	424	277	ALC10(1)331EB350
350	390	CF	30 x 50	1.92	3.65	364	238	ALC10(1)391CF350
350	390	DC	35 x 35	1.82	3.07	386	259	ALC10(1)391DC350
350	390	EC	40 x 35	2.33	4.50	361	236	ALC10(1)391EC350
350	470	DD	35 x 40	2.07	3.47	321	216	ALC10(1)471DD350
350	470	ED	40 x 40	2.69	5.22	299	195	ALC10(1)471ED350
350	560	DF	35 x 50	2.80	4.80	268	180	ALC10(1)561DF350
350	560	EE	40 x 45	3.04	5.88	251	164	ALC10(1)561EE350
350	680	EF	40 x 50	3.46	6.65	207	136	ALC10(1)681EF350
350	820	DH	35 x 60	3.40	5.50	190	130	ALC10(1)821DH350
350	820	EG	40 x 55	3.84	7.16	174	114	ALC10(1)821EG350
350	820	EH	40 x 60	3.99	7.67	172	112	ALC10(1)821EH350
350	1000	DL	35 x 80	3.90	6.40	154	104	ALC10(1)102DL350
350	1200	EL	40 x 80	4.95	9.20	119	78	ALC10(1)122EL350
VDC	Rated Capacitance	Size Code	Case Size	Ripple Current		ESR	Impedance	Part Number

(1) Termination code: See Termination Tables for available options.

Table 1 – Ratings & Part Number Reference cont.

VDC	Rated Capacitance	Size Code	Case Size	Ripple Current		ESR Maximum	Impedance Maximum	Part Number
	100 Hz 20°C (µF)		D x L (mm)	100 Hz 85°C (A)	10 kHz 85°C (A)	100 Hz 20°C (mΩ)	10 kHz 20°C (mΩ)	
350	1800	EP	40 x 105	6.14	10.73	81	54	ALC10(1)182EP350
350	2700	FP	45 x 105	7.00	11.44	63	42	ALC10(1)272FP350
350	3300	KP	50 x 105	7.54	11.57	54	36	ALC10(1)332KP350
400	100	BB	25 x 30	0.77	1.60	1400	943	ALC10(1)101BB400
400	120	BC	25 x 35	0.90	1.87	1166	785	ALC10(1)121BC400
400	150	CB	30 x 30	1.04	2.03	950	645	ALC10(1)151CB400
400	150	BD	25 x 40	1.06	2.18	935	630	ALC10(1)151BD400
400	180	CC	30 x 35	1.20	2.36	791	536	ALC10(1)181CC400
400	220	CC	30 x 35	1.31	2.47	650	400	ALC10(1)221CC400
400	220	CD	30 x 40	1.41	2.74	648	440	ALC10(1)221CD400
400	270	DC	35 x 35	1.61	2.88	547	376	ALC10(1)271DC400
400	270	EB	40 x 30	1.85	3.67	441	284	ALC10(1)271EB400
400	330	DC	35 x 35	1.73	2.92	461	320	ALC10(1)331DC400
400	330	CF	30 x 50	1.82	3.42	438	299	ALC10(1)331CF400
400	330	DD	35 x 40	1.84	3.27	449	309	ALC10(1)331DD400
400	330	EC	40 x 35	2.29	4.21	378	252	ALC10(1)331EC400
400	390	DF	35 x 50	2.19	3.96	377	226	ALC10(1)391DF400
400	390	ED	40 x 40	2.62	4.86	312	203	ALC10(1)391ED400
400	470	DE	35 x 45	2.40	4.10	360	246	ALC10(1)471DE400
400	470	DF	35 x 50	2.62	4.41	321	223	ALC10(1)471DF400
400	470	ED	40 x 40	2.74	5.21	230	156	ALC10(1)471ED400
400	470	EE	40 x 45	3.00	5.49	258	168	ALC10(1)471EE400
400	560	DF	35 x 50	2.57	4.04	278	180	ALC10(1)561DF400
400	560	DH	35 x 60	3.01	5.11	264	184	ALC10(1)561DH400
400	560	EF	40 x 50	3.41	6.19	216	141	ALC10(1)561EF400
400	680	DH	35 x 60	2.90	4.73	232	142	ALC10(1)681DH400
400	680	EH	40 x 60	3.99	7.14	177	114	ALC10(1)681EH400
400	820	DL	35 x 80	3.70	6.09	181	127	ALC10(1)821DL400
400	1000	DL	35 x 80	3.98	6.32	112	77	ALC10(1)102DL400
400	1000	EL	40 x 80	5.00	8.82	120	78	ALC10(1)102EL400
400	1500	EP	40 x 105	5.79	10.16	99	68	ALC10(1)152EP400
400	2200	FP	45 x 105	6.56	10.90	77	53	ALC10(1)222FP400
400	2700	KP	50 x 105	7.11	11.13	66	45	ALC10(1)272KP400
450	68	BB	25 x 30	0.69	1.50	1708	1135	ALC10(1)680BB450
450	100	BC	25 x 35	0.88	1.90	1167	777	ALC10(1)101BC450
450	120	CB	30 x 30	1.00	2.03	989	663	ALC10(1)121CB450
450	120	BD	25 x 40	1.01	2.18	973	648	ALC10(1)121BD450
450	150	BD	25 x 40	1.12	2.35	785	524	ALC10(1)151BD450
450	150	CB	30 x 30	1.10	2.12	805	543	ALC10(1)151CB450
450	150	CC	30 x 35	1.17	2.38	792	531	ALC10(1)151CC450
450	180	CD	30 x 40	1.36	2.76	661	443	ALC10(1)181CD450
450	220	DC	35 x 35	1.56	2.89	559	379	ALC10(1)221DC450
450	220	CF	30 x 50	1.61	3.27	540	362	ALC10(1)221CF450
450	220	EB	40 x 30	1.77	3.68	517	311	ALC10(1)221EB450
450	270	CF	30 x 50	1.76	3.43	446	301	ALC10(1)271CF450
450	270	DC	35 x 35	1.68	2.91	470	322	ALC10(1)271DC450
450	270	DD	35 x 40	1.78	3.27	458	311	ALC10(1)271DD450
450	270	EC	40 x 35	2.07	4.22	427	259	ALC10(1)271EC450
450	330	CF	30 x 50	1.91	3.54	373	253	ALC10(1)331CF450
450	330	DD	35 x 40	2.20	3.68	364	242	ALC10(1)331DD450
450	330	DF	35 x 50	2.41	4.38	373	253	ALC10(1)331DF450
450	330	ED	40 x 40	2.47	4.91	348	210	ALC10(1)331ED450
450	390	DF	35 x 50	2.60	4.41	240	166	ALC10(1)391DF450
450	390	EE	40 x 45	2.70	5.53	293	177	ALC10(1)391EE450
450	470	DF	35 x 50	2.43	4.03	252	155	ALC10(1)471DF450
450	470	DH	35 x 60	2.95	5.12	270	185	ALC10(1)471DH450
450	470	EF	40 x 50	3.08	6.25	243	147	ALC10(1)471EF450
450	560	DF	35 x 50	2.70	4.74	266	172	ALC10(1)561DF450
450	560	EH	40 x 60	3.56	7.04	202	121	ALC10(1)561EH450
450	680	DL	35 x 80	3.61	6.09	190	131	ALC10(1)681DL450
VDC	Rated Capacitance	Size Code	Case Size	Ripple Current		ESR	Impedance	Part Number

(1) Termination code: See Termination Tables for available options.

Table 1 – Ratings & Part Number Reference cont.

VDC	Rated Capacitance	Size Code	Case Size	Ripple Current		ESR Maximum	Impedance Maximum	Part Number
	100 Hz 20°C (µF)		D x L (mm)	100 Hz 85°C (A)	10 kHz 85°C (A)	100 Hz 20°C (mΩ)	10 kHz 20°C (mΩ)	
450	820	EL	40 x 80	4.47	8.78	138	83	ALC10(1)821EL450
450	1000	EL	40 x 80	4.95	9.32	114	75	ALC10(1)102EL450
450	1000	EJ	40 X 70	4.42	8.42	142	93	ALC10(1)102EJ450
450	1200	EP	40 x 105	5.57	10.15	103	70	ALC10(1)122EP450
450	1500	EP	40 x 105	5.77	10.50	96	62	ALC10(1)152EP450
450	1800	FP	45 x 105	6.27	10.87	82	55	ALC10(1)182FP450
450	2200	KP	50 x 105	6.81	11.12	70	47	ALC10(1)222KP450
500	56	BB	25 x 30	0.74	1.44	2365	1642	ALC10(1)560BB500
500	68	BC	25 x 35	0.87	1.70	1816	1351	ALC10(1)680BC500
500	82	BD	25 x 40	1.00	1.95	1507	1120	ALC10(1)820BD500
500	82	CB	30 x 30	0.99	1.84	1527	1140	ALC10(1)820CB500
500	100	CB	30 x 30	1.08	1.94	1000	765	ALC10(1)101CB500
500	100	CC	30 x 35	1.15	2.16	1220	840	ALC10(1)101CC500
500	120	CC	30 x 35	1.25	2.28	1052	786	ALC10(1)121CC500
500	150	CD	30 x 40	1.48	2.67	895	631	ALC10(1)151CD500
500	180	CF	30 x 50	1.78	3.27	699	522	ALC10(1)181CF500
500	180	DC	35 x 35	1.70	2.84	728	549	ALC10(1)181DC500
500	180	EB	40 x 30	1.76	3.22	699	522	ALC10(1)181EB500
500	220	DD	35 x 40	1.96	3.26	622	450	ALC10(1)221DD500
500	220	EC	40 x 35	2.07	3.82	571	426	ALC10(1)221EC500
500	270	DF	35 x 50	2.34	3.97	505	362	ALC10(1)271DF500
500	270	ED	40 x 40	2.41	4.42	466	348	ALC10(1)271ED500
500	330	DF	35 x 50	2.14	3.75	492	366	ALC10(1)331DF500
500	330	EE	40 x 45	2.74	5.00	405	286	ALC10(1)331EE500
500	390	DH	35 x 60	2.87	4.67	355	258	ALC10(1)391DH500
500	390	EF	40 x 50	3.09	5.59	345	242	ALC10(1)391EF500
500	470	EH	40 x 60	3.56	6.43	285	201	ALC10(1)471EH500
500	560	DL	35 x 80	3.50	5.57	250	182	ALC10(1)561DL500
500	680	DL	35 x 80	3.65	6.45	244	178	ALC10(1)681DL500
500	680	EL	40 x 80	4.40	7.77	200	140	ALC10(1)681EL500
500	1000	EP	40 x 105	5.43	9.18	140	98	ALC10(1)102EP500
500	1500	FP	45 x 105	5.97	9.76	110	82	ALC10(1)152FP500
500	1800	KP	50 x 105	6.45	10.09	94	70	ALC10(1)182KP500
550	56	BB	25 X 30	0.68	1.13	6118	5330	ALC10(1)560BB550
550	68	BC	25 X 35	0.77	1.29	5038	4388	ALC10(1)680BC550
550	82	BD	25 X 40	0.87	1.46	4178	3640	ALC10(1)820BD550
550	82	CB	30 X 30	0.91	1.49	4196	3656	ALC10(1)820CB550
550	120	CC	30 X 35	1.14	1.86	2874	2506	ALC10(1)121CC550
550	150	CD	30 X 40	1.32	2.14	2302	2008	ALC10(1)151CD550
550	180	CF	30 X 50	1.52	2.47	1914	1670	ALC10(1)181CF550
550	180	DC	35 X 35	1.50	2.34	1940	1694	ALC10(1)181DC550
550	220	DD	35 X 40	1.72	2.67	1588	1388	ALC10(1)221DD550
550	270	DF	35 X 50	2.01	3.15	1290	1126	ALC10(1)271DF550
550	330	DH	35 X 60	2.30	3.60	1058	924	ALC10(1)331DH550
550	470	DL	35 X 80	2.87	4.43	746	650	ALC10(1)471DL550
550	180	EB	40 X 30	1.60	2.62	1936	1688	ALC10(1)181EB550
550	220	EC	40 X 35	1.84	3.01	1584	1380	ALC10(1)221EC550
550	270	ED	40 X 40	2.11	3.44	1290	1124	ALC10(1)271ED550
550	330	EE	40 X 45	2.40	3.90	1056	920	ALC10(1)331EE550
550	390	EF	40 X 50	2.67	4.33	894	780	ALC10(1)391EF550
550	470	EH	40 X 60	3.05	4.93	742	648	ALC10(1)471EH550
550	680	EL	40 X 80	3.87	6.18	514	450	ALC10(1)681EL550
550	1000	EP	40 X 105	4.86	7.59	352	308	ALC10(1)102EP550
550	1200	FP	45 X 105	5.60	8.59	296	258	ALC10(1)122FP550
550	1500	KP	50 X 105	6.50	9.63	242	212	ALC10(1)152KP550
600	47	BB	25 X 30	0.69	1.44	2707	1867	ALC10(1)470BB600
600	56	BC	25 X 35	0.81	1.93	2270	1565	ALC10(1)560BC600
600	82	BD	25 X 40	1.01	2.36	1556	1074	ALC10(1)820BD600
600	82	CB	30 X 30	1.03	2.27	1577	1094	ALC10(1)820CB600
600	100	CC	30 X 35	1.19	2.63	1291	895	ALC10(1)101CC600
VDC	Rated Capacitance	Size Code	Case Size	Ripple Current		ESR	Impedance	Part Number

(1) Termination code: See Termination Tables for available options.

Table 1 – Ratings & Part Number Reference cont.

VDC	Rated Capacitance	Size Code	Case Size	Ripple Current		ESR Maximum	Impedance Maximum	Part Number
	100 Hz 20°C (µF)		D x L (mm)	100 Hz 85°C (A)	10 kHz 85°C (A)	100 Hz 20°C (mΩ)	10 kHz 20°C (mΩ)	
600	120	CD	30 X 40	1.35	2.99	1076	746	ALC10(1)121CD600
600	150	CF	30 X 50	1.60	3.57	859	595	ALC10(1)151CF600
600	150	DC	35 X 35	1.56	3.11	884	618	ALC10(1)151DC600
600	180	DD	35 X 40	1.77	3.54	736	515	ALC10(1)181DD600
600	220	DF	35 X 50	2.09	4.27	599	418	ALC10(1)221DF600
600	270	DH	35 X 60	2.41	4.87	490	342	ALC10(1)271DH600
600	390	DL	35 X 80	3.01	5.90	342	120	ALC10(1)391DL600
600	150	EB	40 X 30	1.67	3.74	869	600	ALC10(1)151EB600
600	180	EC	40 X 35	1.91	4.30	723	499	ALC10(1)181EC600
600	220	ED	40 X 40	2.18	4.90	592	409	ALC10(1)221ED600
600	270	EE	40 X 45	2.48	5.51	483	334	ALC10(1)271EE600
600	330	EF	40 X 50	2.81	6.15	397	274	ALC10(1)331EF600
600	390	EH	40 X 60	3.19	6.95	336	232	ALC10(1)391EH600
600	560	EL	40 X 80	4.04	8.57	236	163	ALC10(1)561EL600
600	820	EP	40 X 105	5.00	10.10	163	113	ALC10(1)821EP600
600	1000	FP	45 X 105	5.74	10.99	136	95	ALC10(1)102FP600
600	1000	KL	50 X 80	5.69	10.33	140	98	ALC10(1)102KL600
600	1200	KP	50 X 105	6.57	11.96	117	82	ALC10(1)122KP600
VDC	Rated Capacitance	Size Code	Case Size	Ripple Current		ESR	Impedance	Part Number

(1) Termination code: See Termination Tables for available options.

Mechanical Data

Polarity and Reversed Voltage

Aluminium Electrolytic capacitors manufactured for use in DC applications contain an anode foil and a cathode foil. As such, they are polarized devices and must be connected with the +ve to the anode foil and the -ve to the cathode foil. If this were to be reversed, then the electrolytic process that took place in forming the oxide layer on the anode would be recreated in trying to form an oxide layer on the cathode. In forming the cathode foil in this way, heat would be generated and gas given off within the capacitor, usually leading to catastrophic failure.

The cathode foil already possesses a thin stabilized oxide layer. This thin oxide layer is equivalent to a forming voltage of approximately 2 V. As a result, the capacitor can withstand a voltage reversal of up to 2 V for short periods. Above this voltage, the formation process will commence. Aluminium Electrolytic capacitors can also be manufactured for use in intermittent AC applications by using two anode foils in place of one anode and one cathode.

Mounting Position

The capacitor can be mounted upright or inclined to a horizontal position.

Insulating Resistance

≥ 100 MΩ at 100 VDC across insulating sleeve.

UL recognized sleeving is available for custom parts in this range, upon request (UL No. E358957).

Voltage Proof

≥ 2,500 VDC across insulating sleeve.

Safety Vent

A safety vent for overpressure is featured on either the base (opposing end to the terminals) or the side of the can. This appears in the form of a grooved section on the surface of the can, which is a weakened area and designed to relieve build-up of internal pressure due to overstress or catastrophic failure.

Marking

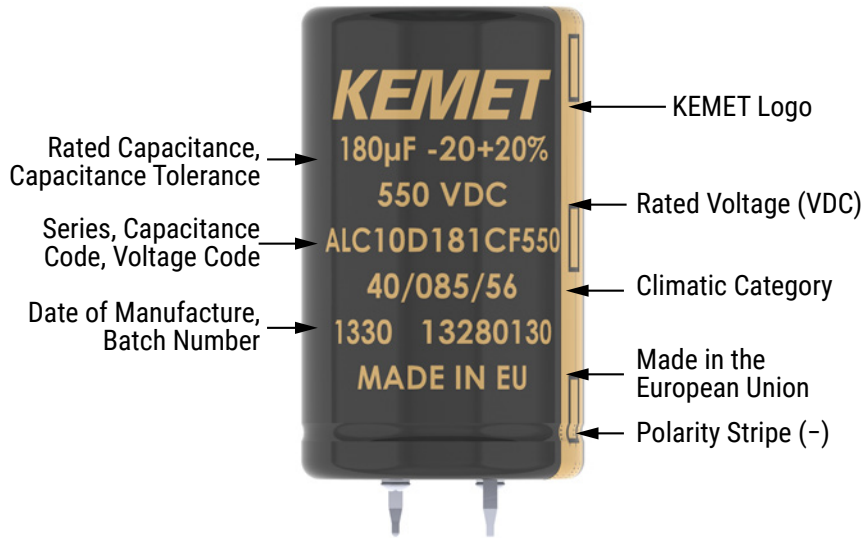

Construction

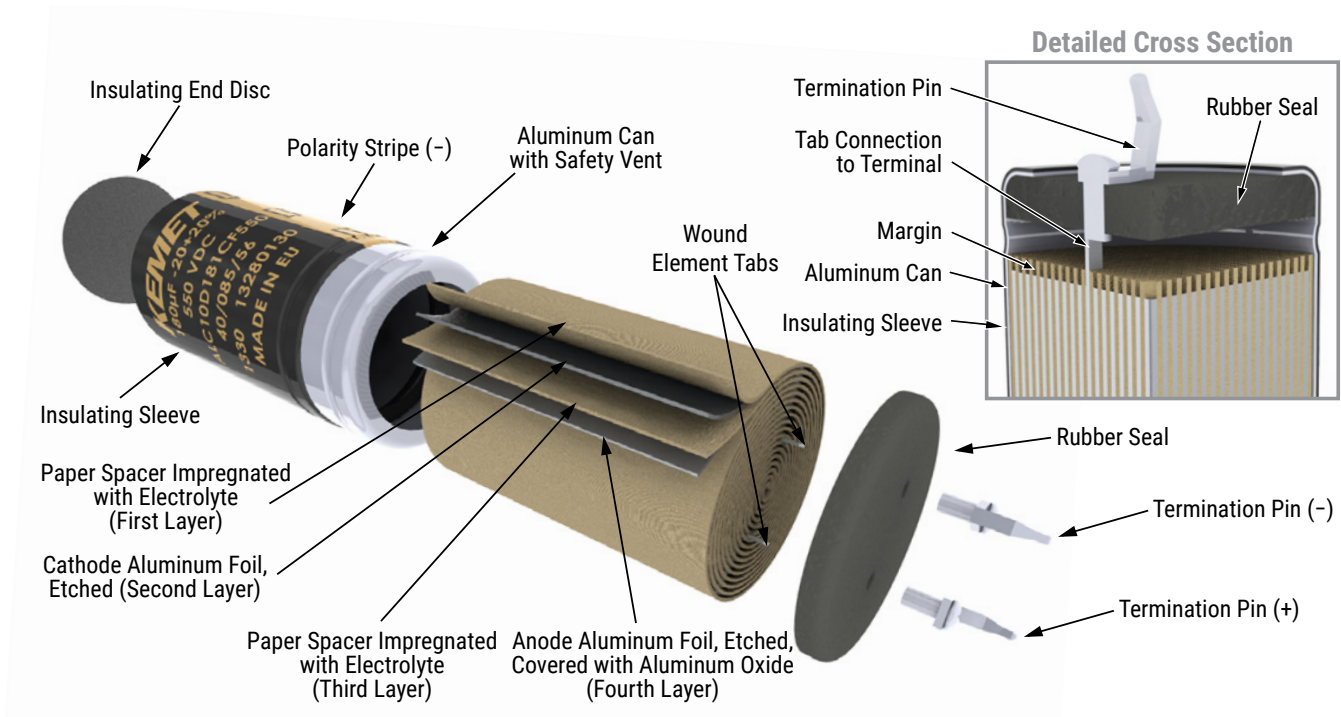

Construction Data

The manufacturing process begins with the anode foil being electrochemically etched to increase the surface area and then “formed” to produce the aluminum oxide layer. Both the anode and cathode foils are then interleaved with absorbent paper and wound into a cylinder. During the winding process, aluminum tabs are attached to each foil to provide the electrical contact.

The deck, complete with terminals, is attached to the tabs and then folded down to rest on top of the winding. The complete winding is impregnated with electrolyte before being housed in a suitable container, usually an aluminum can, and sealed. Throughout the process, all materials inside the housing must be maintained at the highest purity and be compatible with the electrolyte.

Each capacitor is aged and tested before being sleeved and packed. The purpose of aging is to repair any damage in the oxide layer and thus reduce the leakage current to a very low level. Aging is normally carried out at the rated temperature of the capacitor and is accomplished by applying voltage to the device while carefully controlling the supply current. The process may take several hours to complete.

Damage to the oxide layer can occur due to variety of reasons:

- Slitting of the anode foil after forming
- Attaching the tabs to the anode foil
- Minor mechanical damage caused during winding

A sample from each batch is taken by the quality department after completion of the production process. This sample size is controlled by the use of recognized sampling tables defined in BS 6001.

The following tests are applied and may be varied at the request of the customer. In this case the batch, or special procedure, will determine the course of action.

Electrical:

- Leakage current
- Capacitance
- ESR
- Impedance
- Tan Delta

Mechanical/Visual:

- Overall dimensions
- Torque test of mounting stud
- Print detail
- Box labels
- Packaging, including packed quantity



KEMET Electronics Corporation Sales Offices

For a complete list of our global sales offices, please visit www.kemet.com/sales.

Disclaimer

All product specifications, statements, information and data (collectively, the "Information") in this datasheet are subject to change. The customer is responsible for checking and verifying the extent to which the Information contained in this publication is applicable to an order at the time the order is placed. All Information given herein is believed to be accurate and reliable, but it is presented without guarantee, warranty, or responsibility of any kind, expressed or implied.

Statements of suitability for certain applications are based on KEMET Electronics Corporation's ("KEMET") knowledge of typical operating conditions for such applications, but are not intended to constitute – and KEMET specifically disclaims – any warranty concerning suitability for a specific customer application or use. The Information is intended for use only by customers who have the requisite experience and capability to determine the correct products for their application. Any technical advice inferred from this Information or otherwise provided by KEMET with reference to the use of KEMET's products is given gratis, and KEMET assumes no obligation or liability for the advice given or results obtained.

Although KEMET designs and manufactures its products to the most stringent quality and safety standards, given the current state of the art, isolated component failures may still occur. Accordingly, customer applications which require a high degree of reliability or safety should employ suitable designs or other safeguards (such as installation of protective circuitry or redundancies) in order to ensure that the failure of an electrical component does not result in a risk of personal injury or property damage.

Although all product-related warnings, cautions and notes must be observed, the customer should not assume that all safety measures are indicated or that other measures may not be required.

KEMET is a registered trademark of KEMET Electronics Corporation.