



RFM Integrated Device, Inc.

## PRODUCT SPECIFICATION

Part Number: ANT1032

Antenna, Ceramic Patch  
(47.5×47.5×4.0mm)

L1:1575.42MHz

L2:1227.60MHz

Gain @ Zenith, dBi 4.0/1.0

## 1. SCOPE

This specification covers the dielectric Patch antenna for **GPS(L1+L2)**.

## 2. Name of the product

This product is named "Dielectric Antenna".



## 3. Electrical characteristics

### 3-1 Electrical characteristics of antenna

The antenna has the electrical characteristics given in Table 1 under the manufacturer's standard installation conditions shown in the figure.

Table 1

No	Parameter	Specification	Notes
1	Range Of Receiving Frequency	L1 : 1575.42MHz L2 : 1227.60MHz	
2	Center Frequency	L1 : 1574MHz ±10MHz L2 : 1224MHz ±10MHz	L1/L2 : With 70×70mm test fixture
3	Return Loss	L1 : <-10dB L2 : <-10dB	
4	Gain at Zenith	L1 : +4.0dB L2 : +1.0dB	Customer Prototype
5	Gain at 10° Elevation	- - -	
6	Axial Ratio	- - -	
7	Polarization	Linear	
8	Impedance	50 Ohm	
9	Frequency Temperature Coefficient (ƒf)	-40°C to +105°C	0 ± 20ppm / °C
10	Operating Temperature	-40°C to +105°C	

※ Please follow the Golden Sample characteristics and compensation the instrument measurement value when IQC Inspection.

## 4. Environmental conditions

### 4-1 Operating conditions

The antenna has the electrical characteristics given in Tables 1 in the temperature range of -40°C to +105°C and under the environmental conditions of +40°C and 0-95% r.h..

### 4-2 Storage temperature range

The storage temperature range of product is -40°C to +105°C.

#### 4-3 Feed pin temperature range

Maximum temperature for soldering of feed pin is +400°C for 6 second.

### 5. Reliability tests

#### 5-1 Low-temperature test

Expose the specimen to -45°C for 400 hours and then to normal temperature/humidity for 24 hours or more. After this test, examine its appearance and functions.

#### 5-2 High-temperature test

Expose the specimen to +105°C for 400 hours and then to normal temperature/humidity for 24 hours or more. After this test, examine its appearance and functions.

#### 5-3 High-temperature/high-humidity test

Subject the object to the environmental conditions of +85°C and 90-95% r.h. for 96 hours, then expose to normal temperature/humidity for 24 hours or more. After this test, examine its appearance and functions.

#### 5-4 Thermal shock test

Subject the object to cyclic temperature change (-30°C, 30 minutes  $\leftrightarrow$  +80°C, 30 minutes ) for 1500 cycles, the expose to normal temperature/humidity for 24 hours or more.

#### 5-5 Vibration test

##### 5-5-1 Sinusoidal vibration test

Subject the object to vibrations of 5 to 200 to 5Hz swept in 10 minutes, 4.5G at maximum (2mm amplitude), in X and Y directions for two hours each and in Z direction for four hours. After this test, examine its appearance and functions.

##### 5-5-2 Vibration test in packaged condition

Subject the object, which is packaged as illustrated, to vibrations of 15 to 60 to 15Hz swept in 6 minutes, 4G at maximum (2mm amplitude at maximum), applied in X, Y and Z directions for two hours each, i.e. six hours in total. After this test, examine its appearance and functions.

#### 5-6 Free fall test in packaged condition

Drop the object, which is packaged as illustrated, to a concrete surface from the height of 90 cm, on one corner, three edges and six faces once each, i.e. 10 times in total. After this test, examine its appearance and functions.

#### 5-7 Soldering heat resistance test

The lead pins of the unit are soaked in solder bath at  $260 \pm 5^\circ\text{C}$  for 10 seconds. After this test, examine its appearance and functions.

#### 5-8 Adhesion test

The device is subjected to be soldered on test PCB. Then apply 0.5Kg (5N) of force for  $5\pm 1$  seconds in the direction parallel to the substrate. (The soldering should be done by reflow and be conducted with care so that the soldering is uniform and free of defect by stress such as heat shock).

### 6. Inspection

As for the examination during mass production, we place the antenna in the production fixture individually, using the network analyzer to compare its central frequency, bandwidth, and return loss with that of the golden sample.

### 7. Test Record

A Copy of test record filled with following contents shall be provided at time of delivery.

7-1 Quantity of delivery

7-2 Measurement of electrical characteristics

Following data at normal temperature obtained by the method described in section 17.

7-3 Temperature and humidity of test

Quantity for sampling inspection shall be  $n=5$  for any lot. In case quantity per lot is less than 5, the whole lot shall be inspected.

### 8. Warranty

If any defect occurs from the product during proper use within a year after delivery, it will be repaired or replaced free of charge.

### 9. Others

Any question arising from this specification manual shall be solved by arrangement made by both parties.

### 10. Precautions for Use

- Antenna pattern use a silver electrode.
- Please don't use the corrosion gas (sulfur gas, chlorine gas) in the atmosphere.
- Please don't direct solder onto the silver electrode of Antenna pattern.



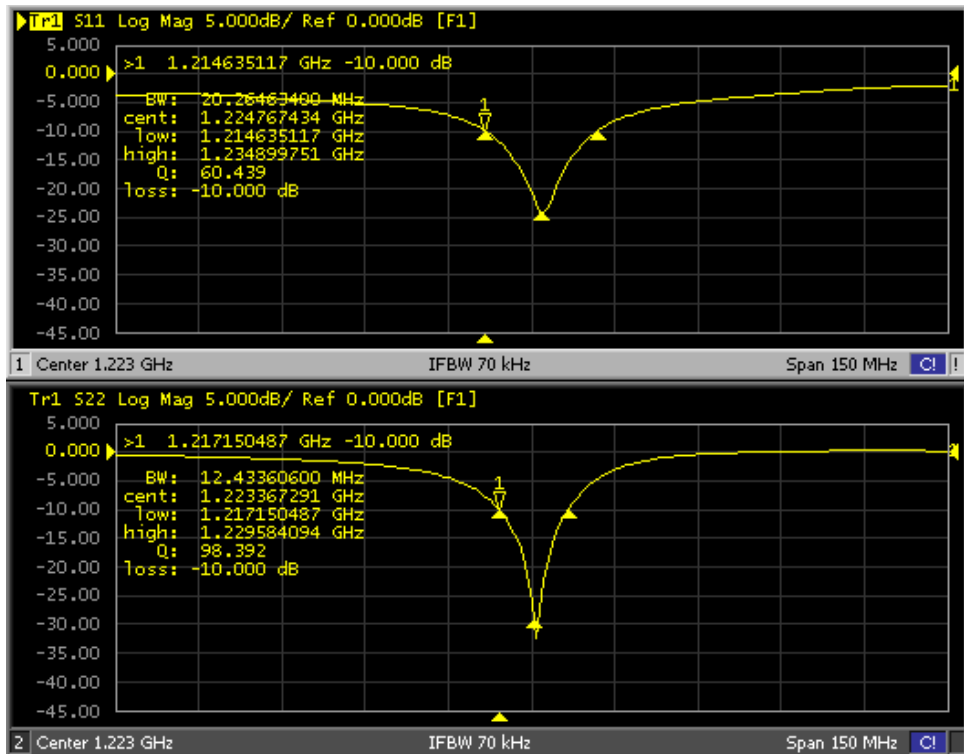

L2 : port1 與 port2

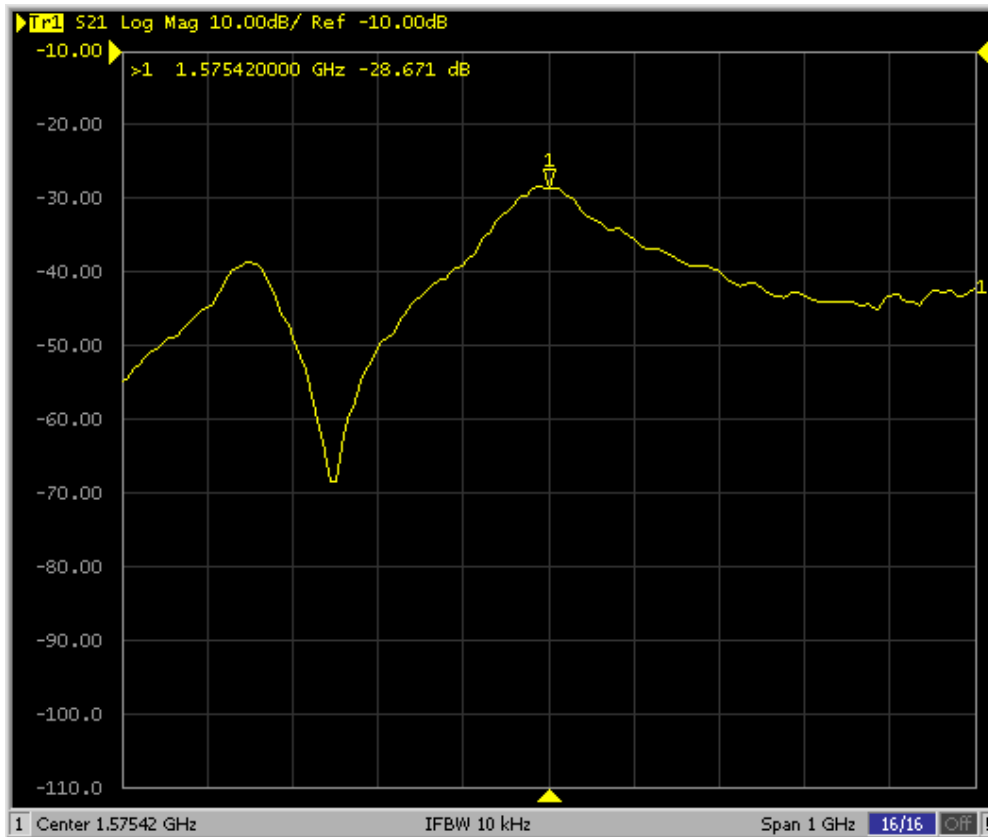

L1 on 70x70 Ground +Hybrid Coupler in Antenna Chamber S21 Log Mag Data

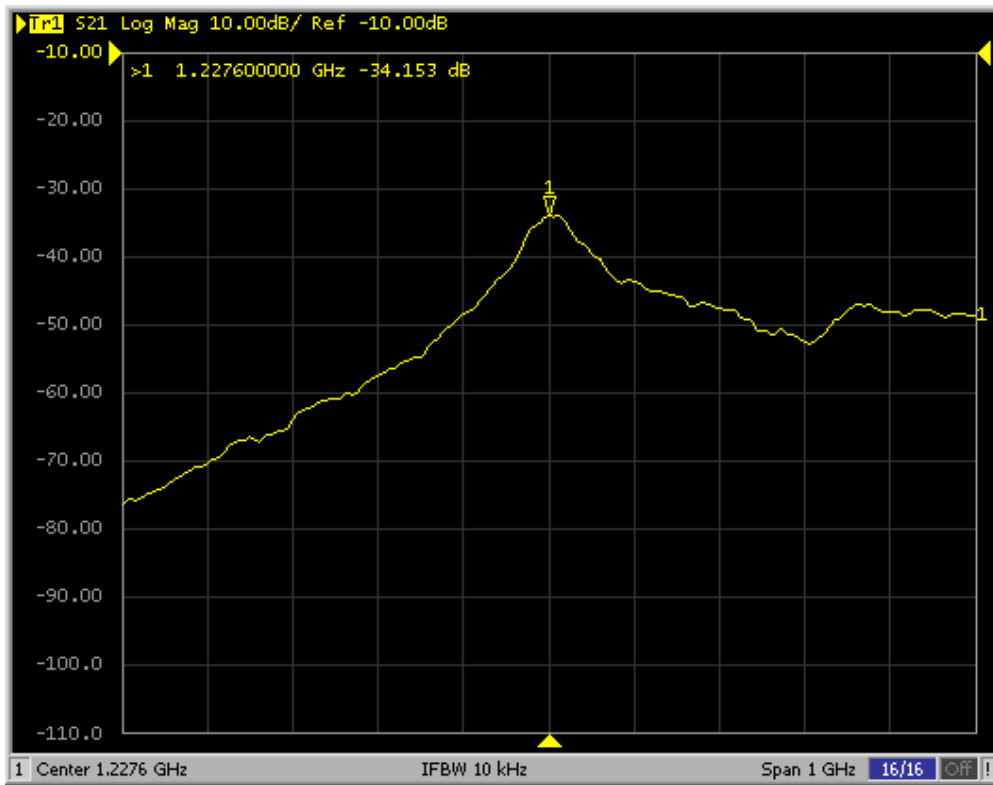

L2 on 70x70 Ground +Hybrid Coupler in Antenna Chamber S21 Log Mag Data

### 13. Radiation Pattern

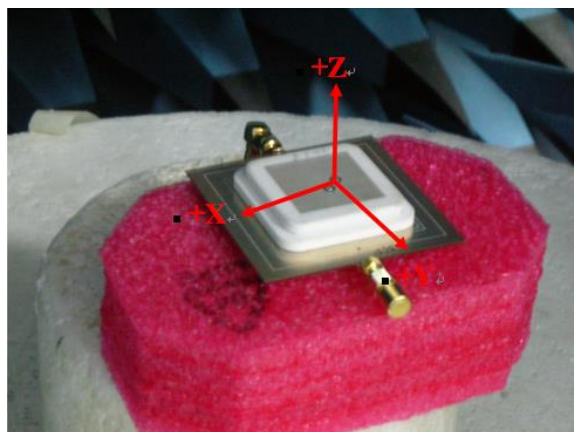

L1/L2

### L1 : Efficiency

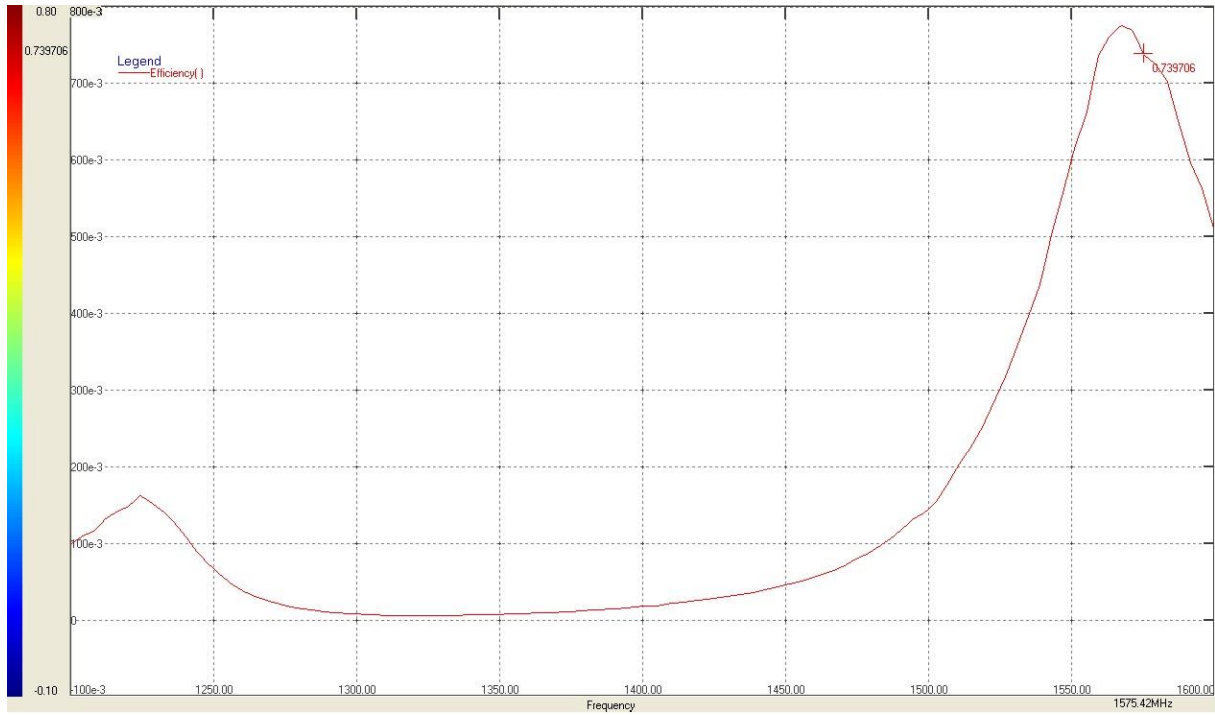

### L1 : Average Gain

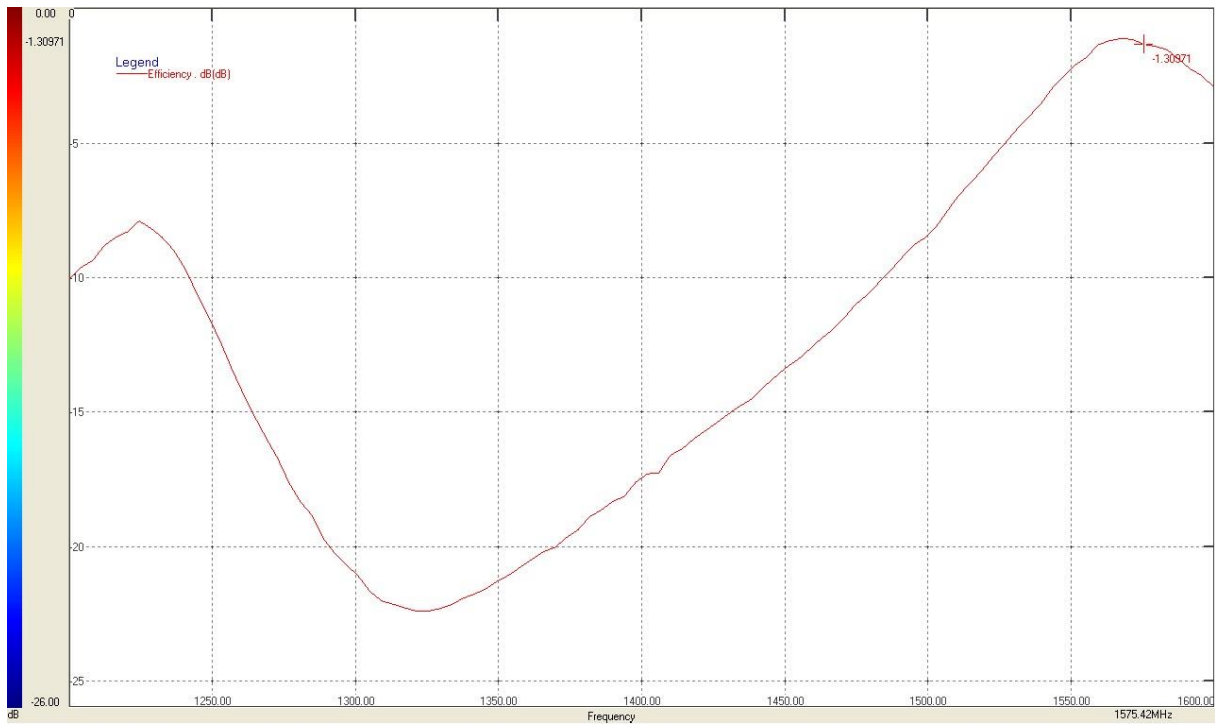



### L1 : Peak Gain

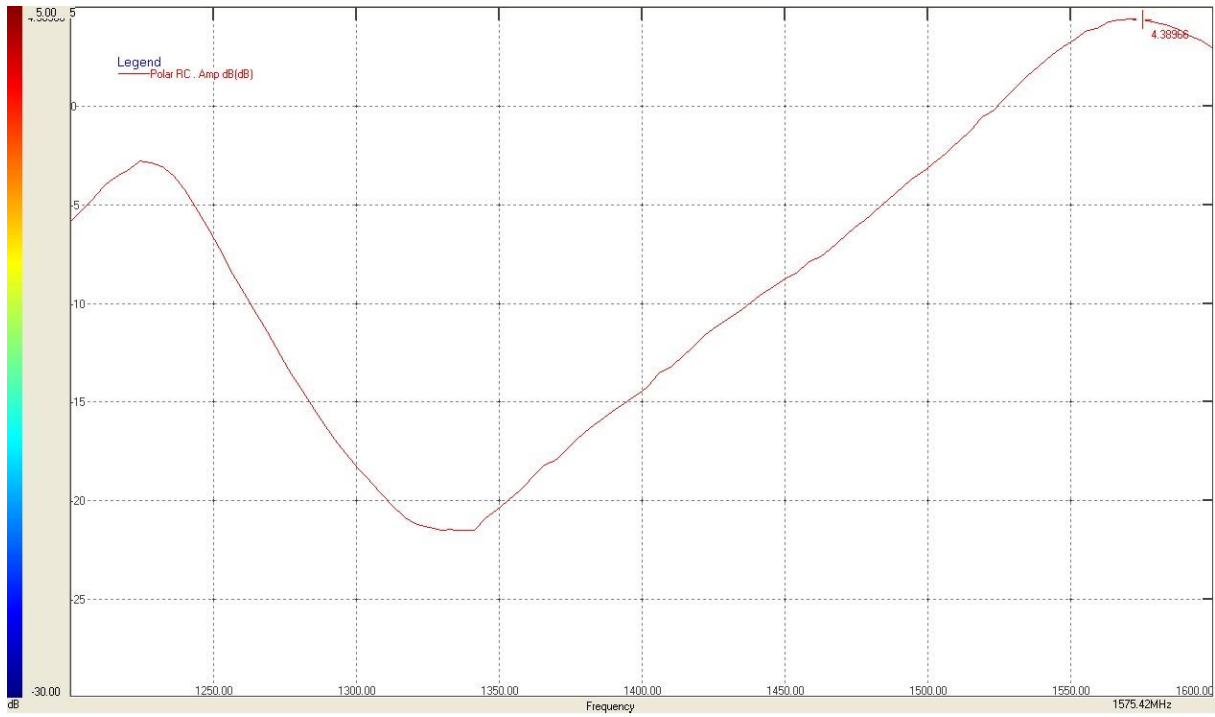

### L1 : 3D Radiation Pattern (1575.42 MHz)

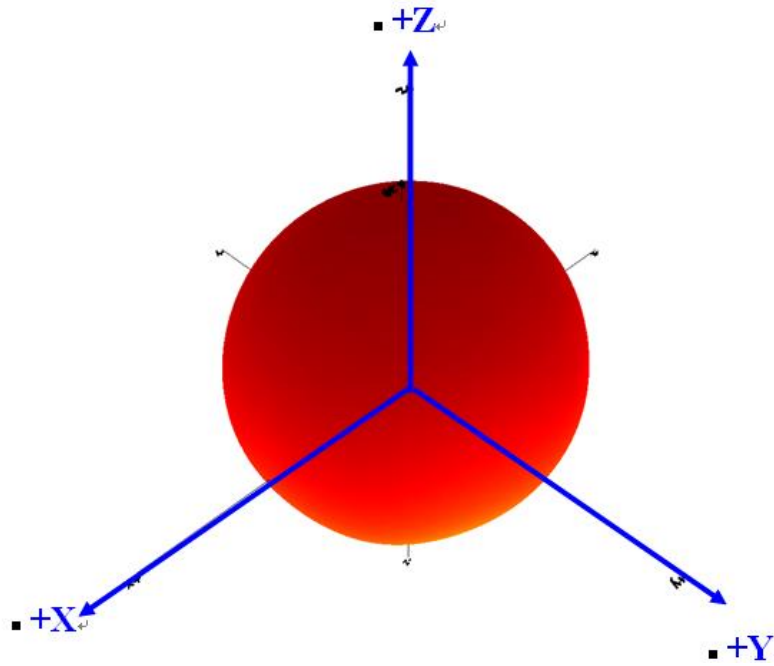

## L2 : Efficiency

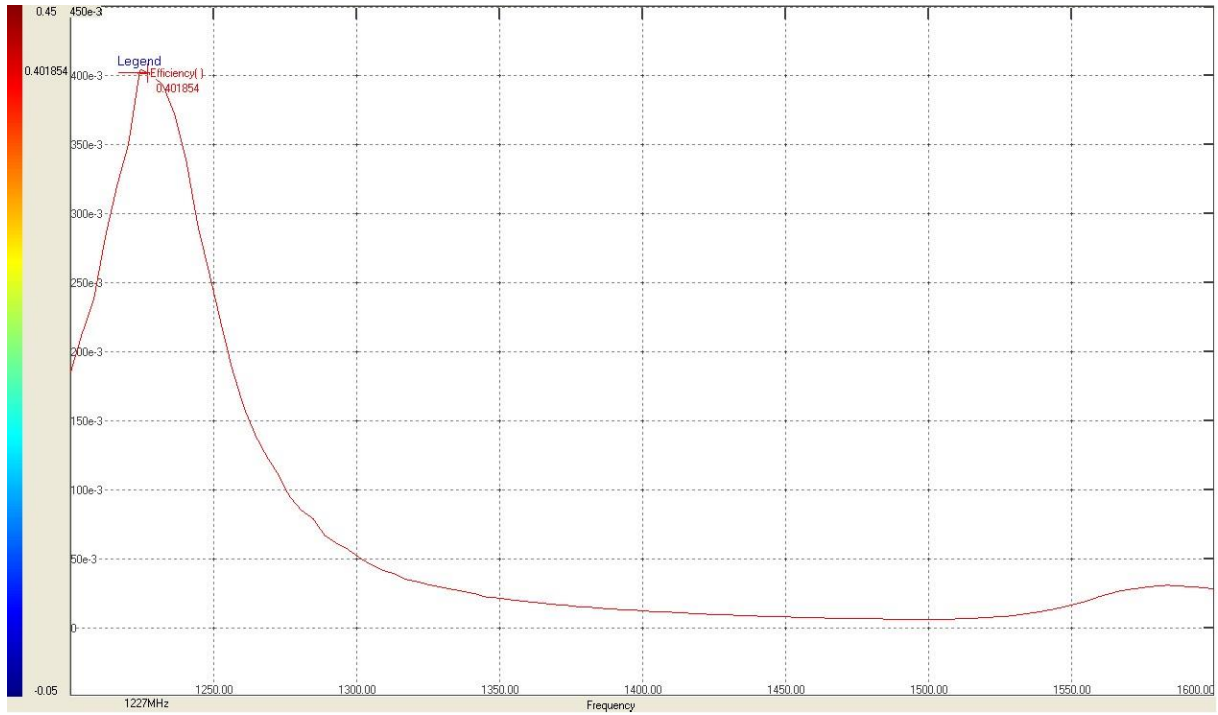

## L2 : Average Gain

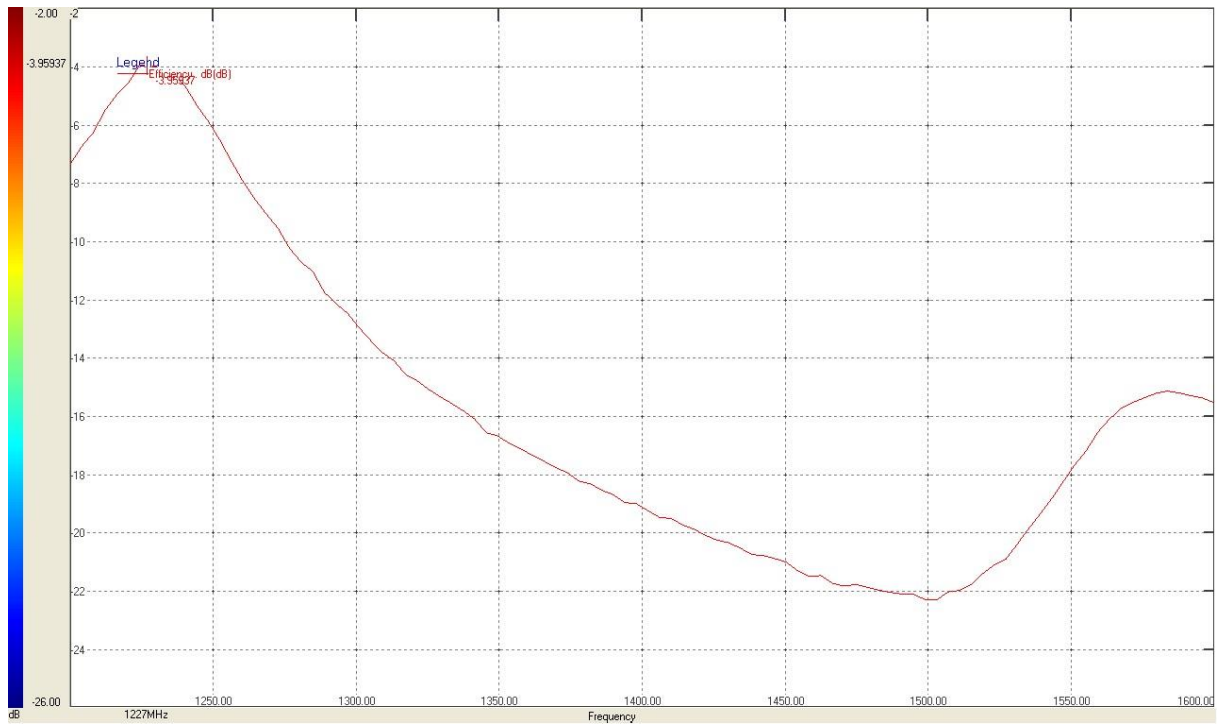

## L2 : Peak Gain

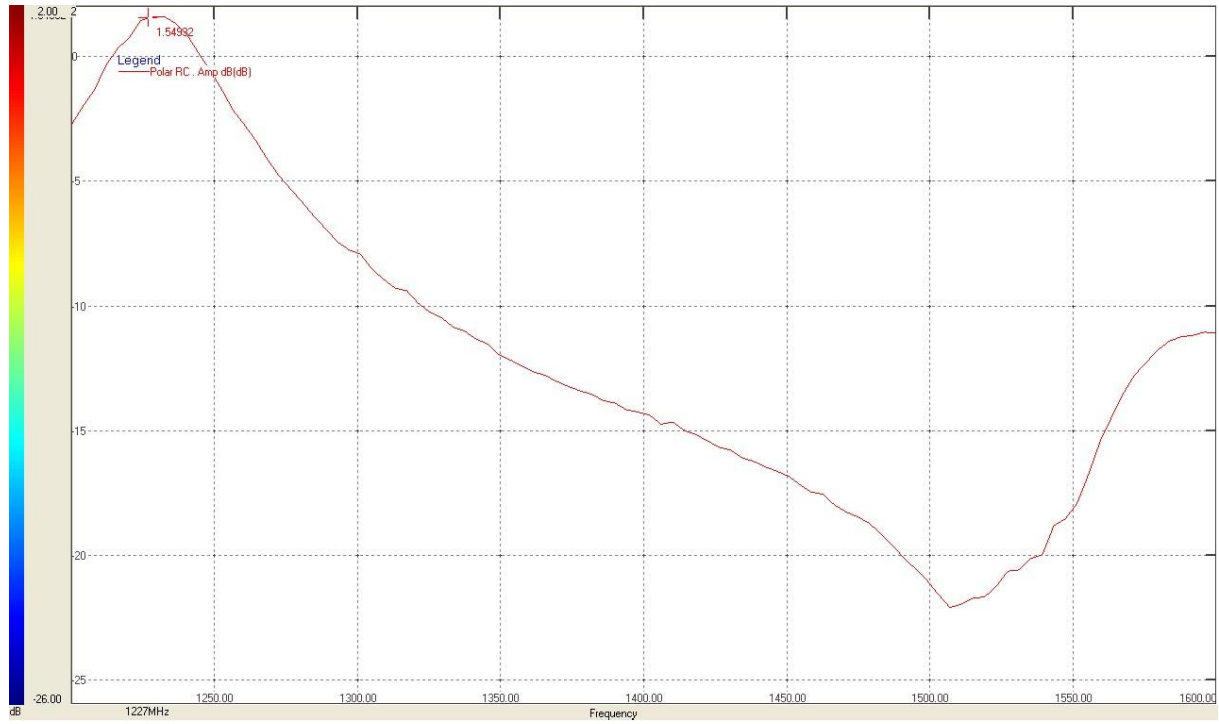

## L2 : 3D Radiation Pattern (1227.6 MHz)

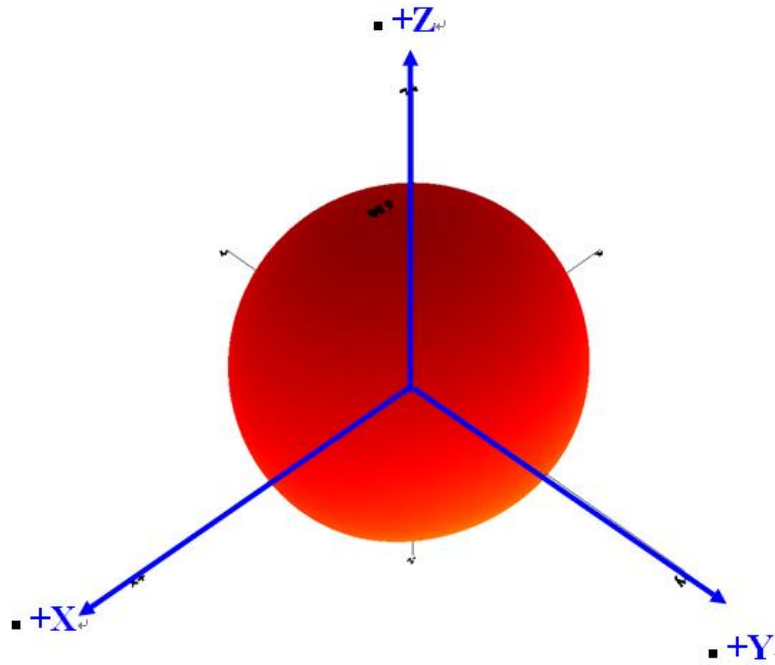

## 14. Axial-Ratio

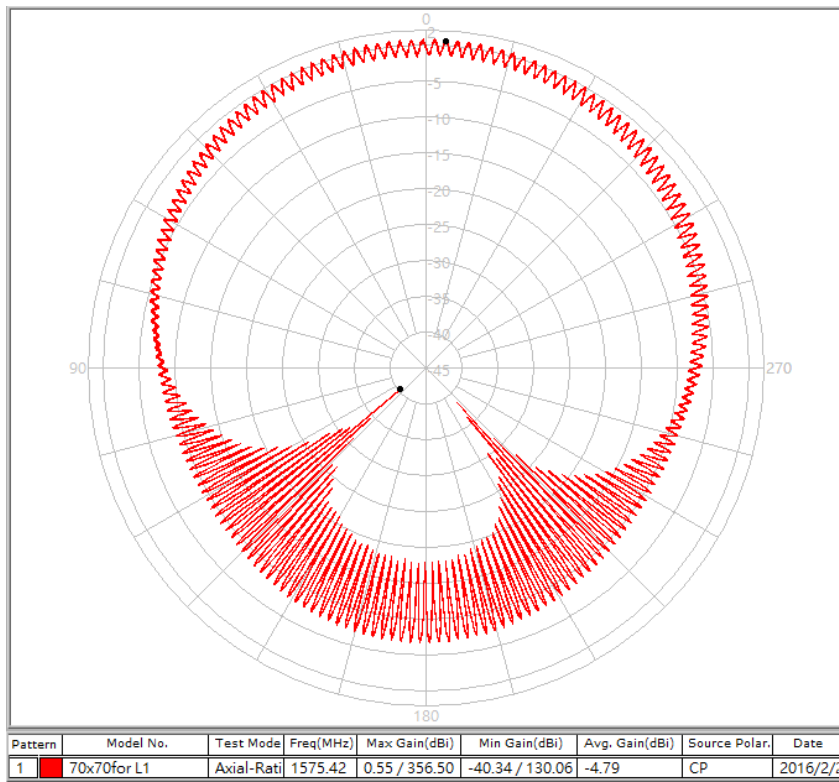

L1 : 1575.42 MHz

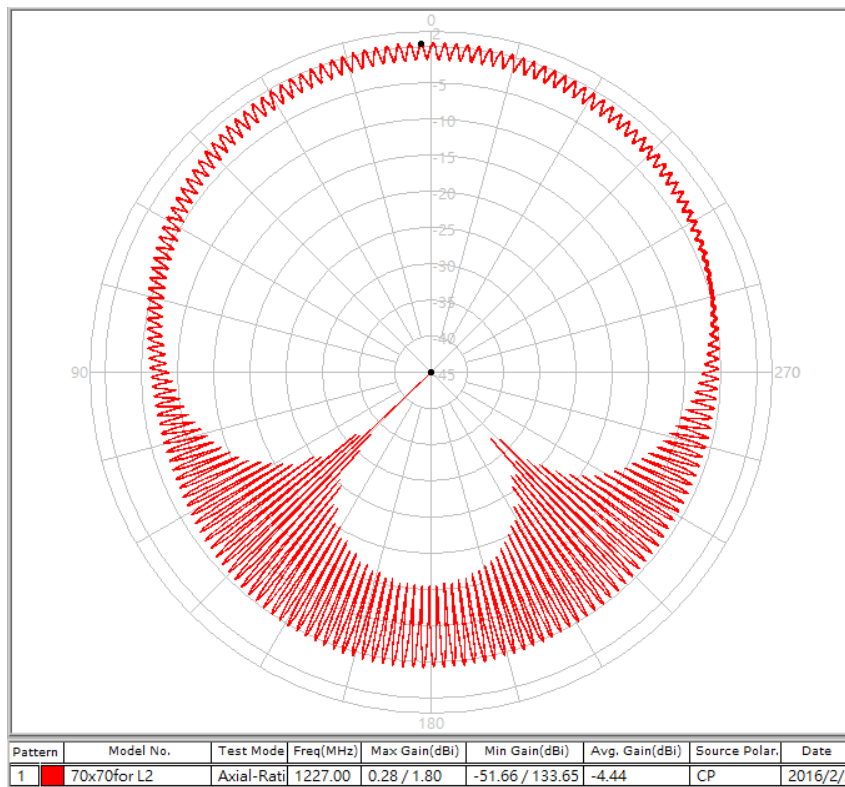

L2: 1227.00 MHz

## 15. Tape Dimension

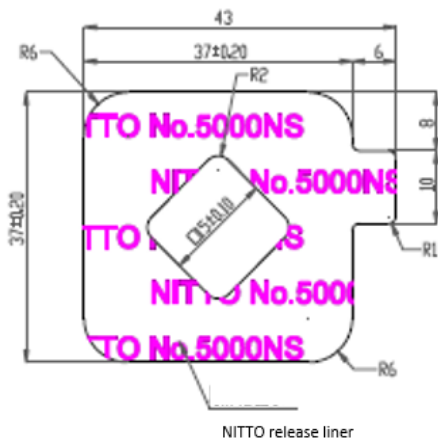

Remove adhesive from this area

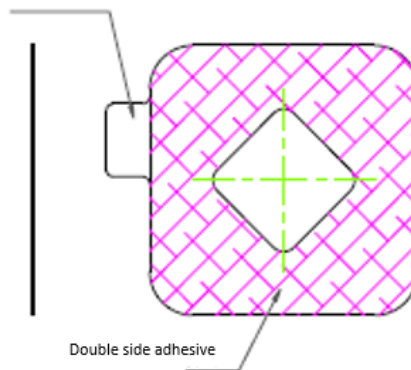

1. NITTO No. 5000NS
2. Double coated adhesive
3. Thickness: 0.16mm
4. Adhesive is in the up side.
5. All tolerance is  $\pm 0.2\text{mm}$

L1 Use

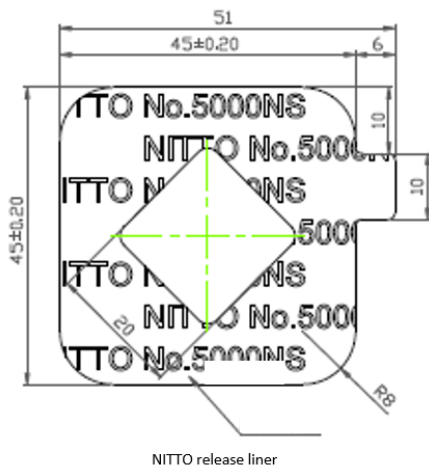

Remove adhesive in this area

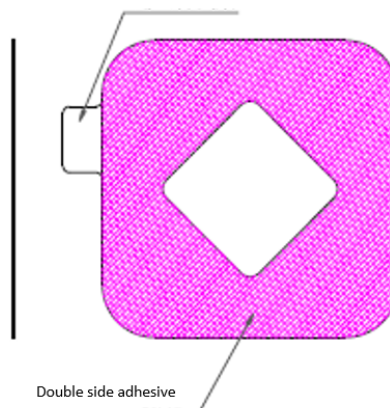

L2 Use

## 16. Marking

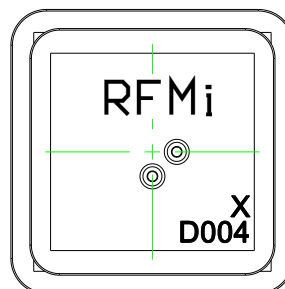

**NOTE:**  
X: manufacture location

## 17. Test fixture Dimension

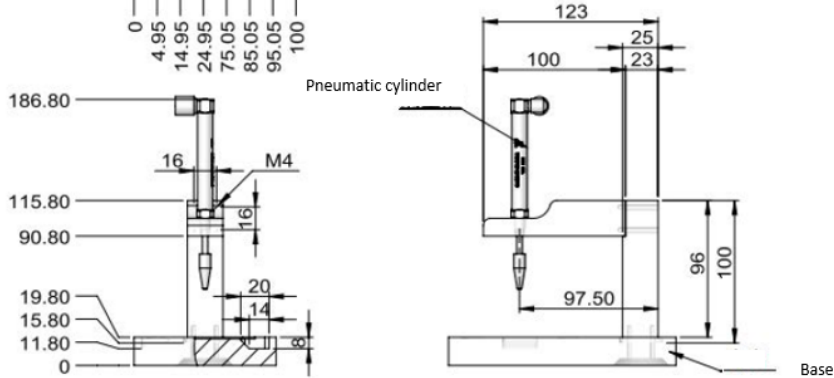
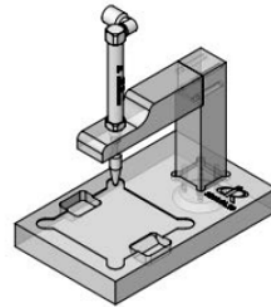
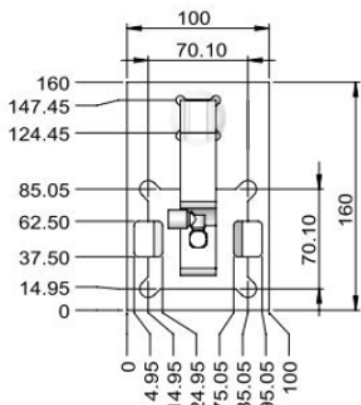
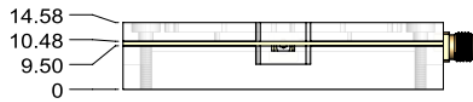
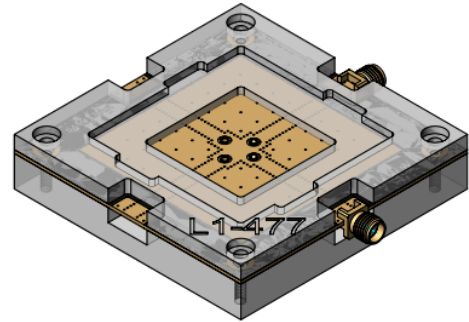
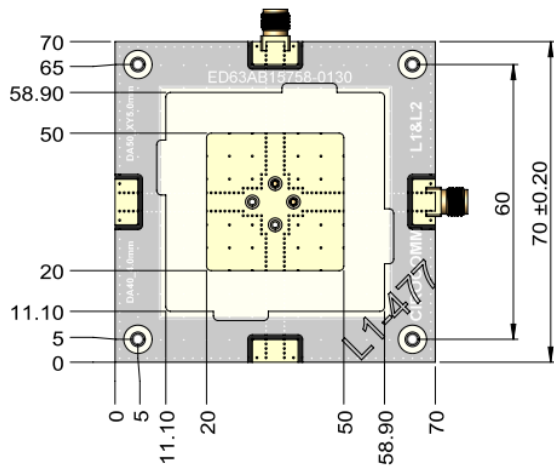

## 18. DA package disassembly

