

Device Features

- OIP3 = 41.0 dBm @ 140 MHz
- Gain = 20.5 dB @ 140 MHz
- Output P1 dB = 20.5 dBm @ 140 MHz
- NF = 2.7 @ 140MHz at Demo Board
- RoHS2-compliant SOT-89 SMT package



Product Description

BeRex's BIG4 is a high performance InGaP/ GaAs HBT MMIC amplifier, internally matched to 50 Ohms. The BIG4 is designed for high linearity IF amplifier that require excellent gain ,high OIP3 and flatness. It is packaged in a RoHS2-compliant with SOT-89 surface mount package.

Applications

- Base station Infrastructure/RFID
- Commercial/Industrial/Military wireless system

Applications Circuit

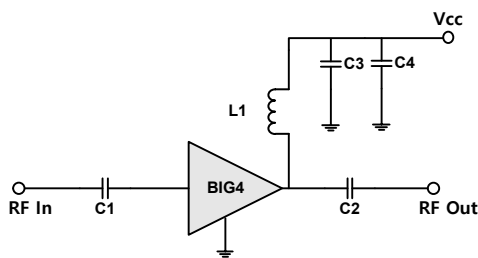

*30 ~ 180 MHz BOM

*C1, C2, C4 = 1000pF ± 5%; C3= 100 pF ± 5%

*L4 = 820 nH ± 10%

*180 ~ 600 MHz BOM

* C1, C2, = 330 pF ± 5%; C3= 100 pF ± 5%; C4 = 1000 pF ± 5%

* L1 = 470nH ±10%

Electrical Specifications

Device performance _ measured on a BeRex evaluation board at 25°C, Vc=5V, 50 Ω system.

Parameter	Conditions	Min	Typ	Max	Unit
Operational Frequency Range		30		600	MHz
Test Frequency			140		MHz
Gain		19.2	20.7		dB
Input Return Loss			-17.0		dB
Output Return Loss			-14.0		dB
Output IP3	8 dBm / tone , Δf=1 MHz	38.0	41.0		dBm
Output P1dB		19.5	20.5		dBm
Noise Figure			2.9		dB

Recommended Operating Conditions

Parameter	Min	Typ	Max	Unit
Bandwidth	30		600	MHz
I _c @ (V _c = 5V)	68	85	102	mA
V _c	4.0	5.0	5.25	V
dG/dT		-0.004		dB/°C
R _{TH}		45.6		°C/W
Operating Case Temperature	-40		+85	°C

Electrical specifications are measured at specified test conditions.

Specifications are not guaranteed over all recommended operating conditions.

Absolute Maximum Ratings

Parameter	Rating	Unit
Storage Temperature	-55 to +155	°C
Junction Temperature	+170	°C
Supply Voltage	+7.0	V
Supply Current	220	mA
Input RF Power	24	dBm

Operation of this device above any of these parameters may result in permanent damage.

Application Circuit: 70-500 MHz

Typical Performance (Vd = 5V, Ic = 85mA, T = 25°C)

Freq	MHz	70	140	200	500
S21	dB	20.9	20.7	20.2	19.5
S11	dB	17.2	17.0	16.3	15.2
S22	dB	14.1	13.8	13.8	13.7
P1	dBm	21.0	20.6	20.4	20.3
OIP3	dBm	40.5	41.0	41.0	41.3
NF	dB	2.7	2.9	3.0	3.1

Typical Performance (Vd = 4.7V, Ic = 76mA, T = 25°C)

Freq	MHz	70	140	200	500
S21	dB	20.9	20.6	20.1	19.3
S11	dB	17.7	17.5	16.7	15.3
S22	dB	13.8	13.5	13.5	13.4
P1	dBm	19.9	19.8	19.6	20.1
OIP3	dBm	39.3	40.3	40.2	40.0
NF	dB	2.7	2.9	3.0	3.1

Typical Performance (Vd = 4.5V, Ic = 69mA, T = 25°C)

Freq	MHz	70	140	200	500
S21	dB	20.8	20.5	20.0	19.2
S11	dB	18.1	17.9	17.0	15.2
S22	dB	13.4	13.1	13.2	13.2
P1	dBm	19.3	19.1	18.9	18.8
OIP3	dBm	38.9	39.1	39.0	39.0
NF	dB	2.6	2.8	2.9	3.0

Typical Performance (Vd = 4V, Ic = 50mA, T = 25°C)

Freq	MHz	70	140	200	500
S21	dB	20.6	20.4	19.9	19.1
S11	dB	19.8	19.5	18.4	16.1
S22	dB	11.9	12.5	12.7	12.6
P1	dBm	16.9	17.1	16.8	16.6
OIP3	dBm	34.4	34.0	33.7	34.7
NF	dB	2.6	2.8	2.9	3.0

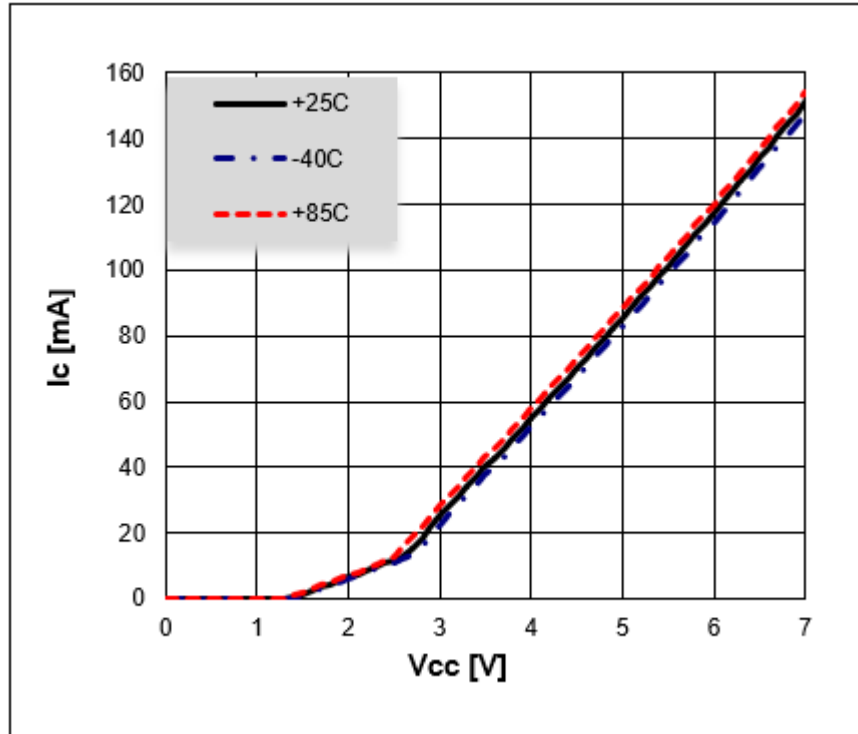
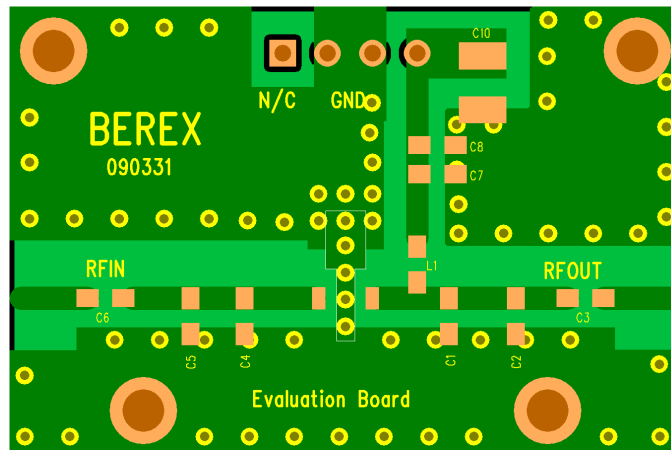
V-I Characteristics

BeRex SOT89 Evaluation Board

*Dielectric constant _ 4.2 *RF pattern width 52mil *31mil thick FR4 PCB

Typical Device Data

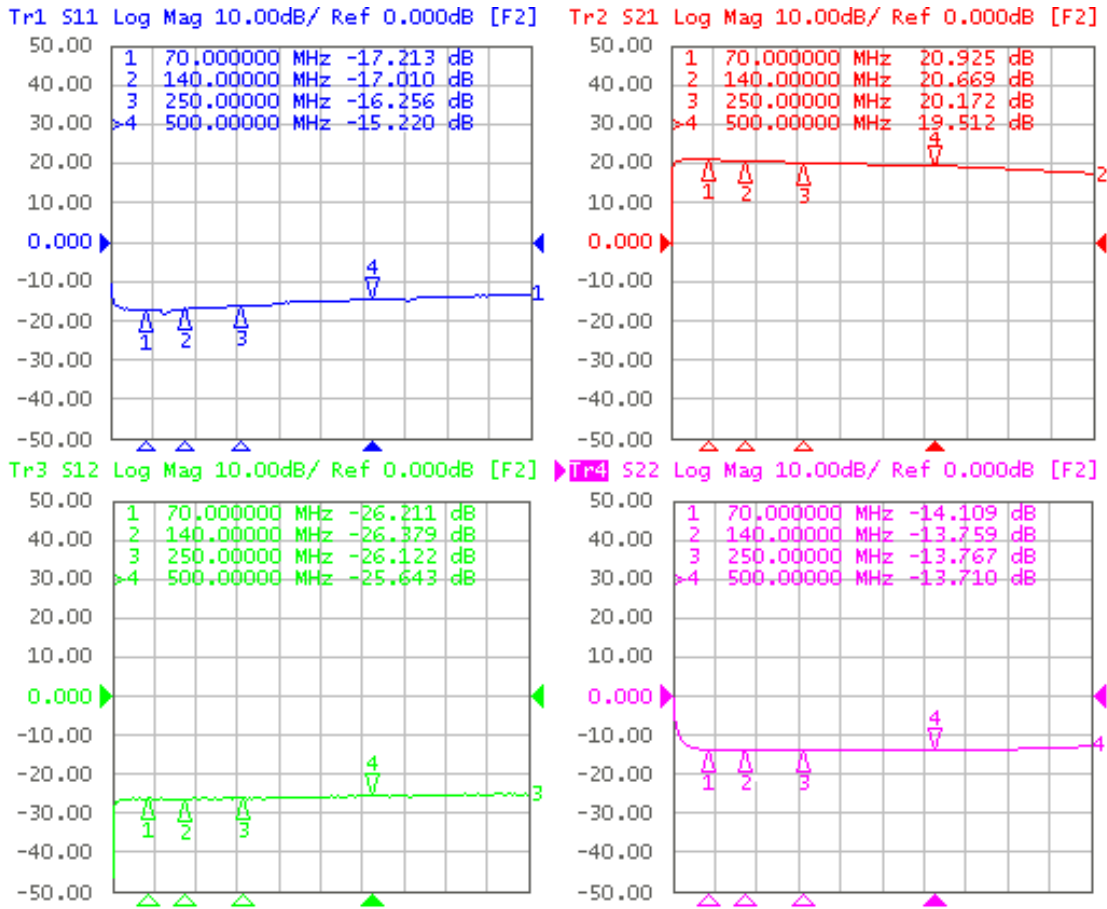
S-parameters (Vc=5V, Ic=85mA, T=25°C)



S-Parameter

(Vdevice = 5.0V, Icc = 85mA, T = 25 °C, calibrated to device leads)

Freq	S11		S21		S12		S22	
	[Mag]	[Ang]	[Mag]	[Ang]	[Mag]	[Ang]	[Mag]	[Ang]
100	0.128	173.348	10.815	161.017	0.047	-8.112	0.212	-22.446
200	0.146	166.542	10.500	143.841	0.049	-11.844	0.211	-36.578
300	0.162	156.423	9.827	126.897	0.050	-18.816	0.197	-54.376
400	0.175	140.352	9.170	109.469	0.052	-26.778	0.208	-74.685
500	0.184	124.571	8.415	94.048	0.053	-36.395	0.211	-91.510
600	0.199	111.317	7.779	80.185	0.054	-42.302	0.206	-103.288

Typical Performance

(Vc=5V, Ic=85mA, T=25°C)

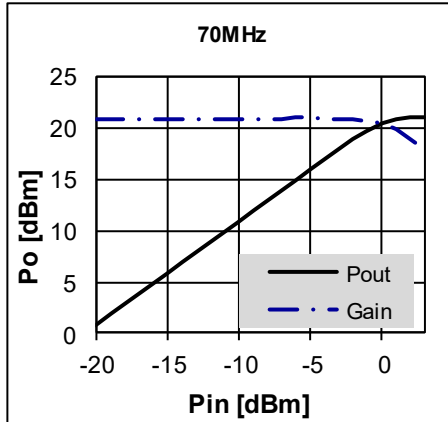
Pin-Pout-Gain

70MHz, 5V/85mA

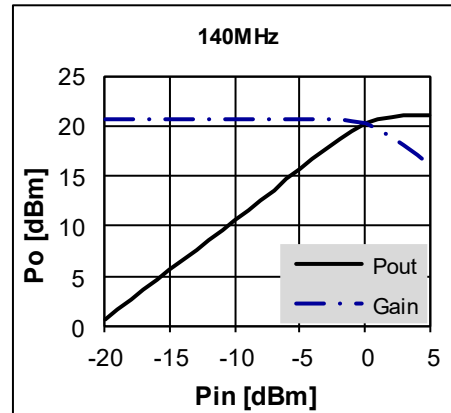

140MHz, 5V/85mA

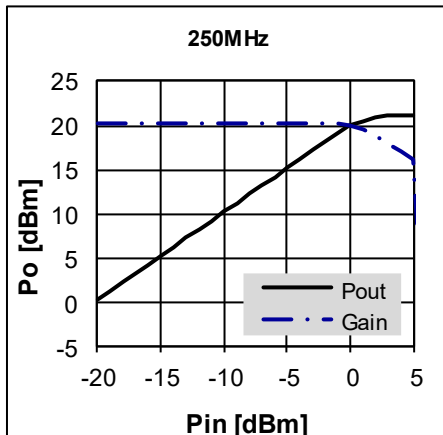

250MHz, 5V/85mA

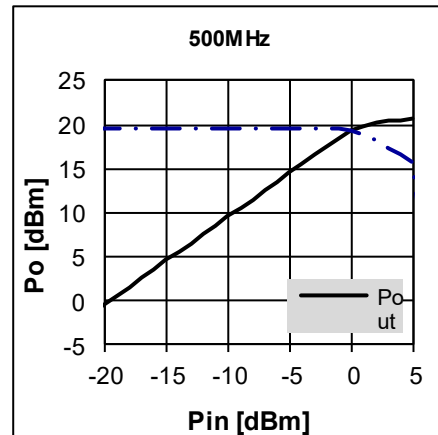

500MHz, 5V/85mA

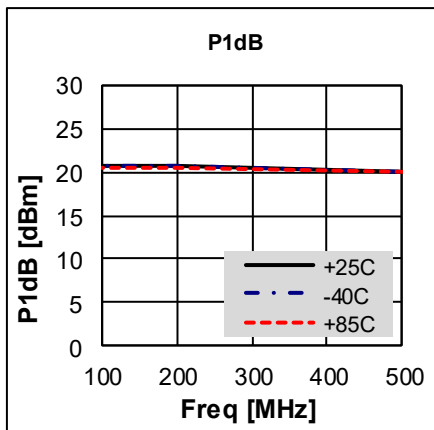

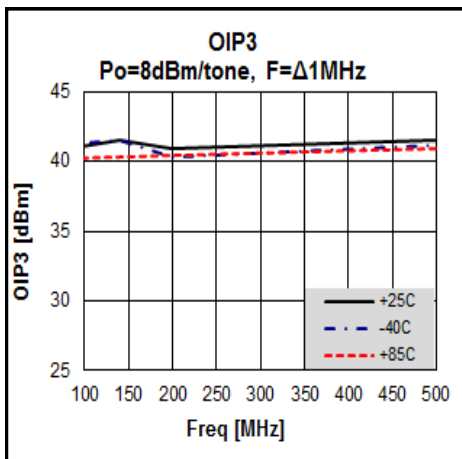
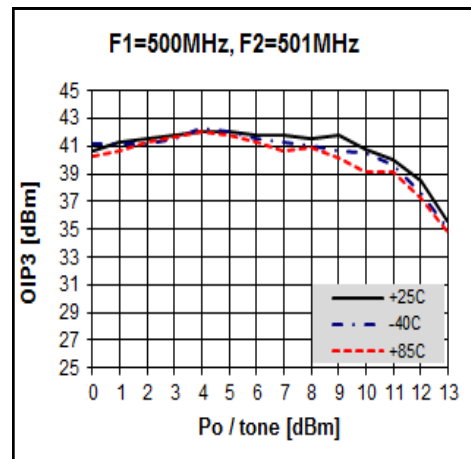
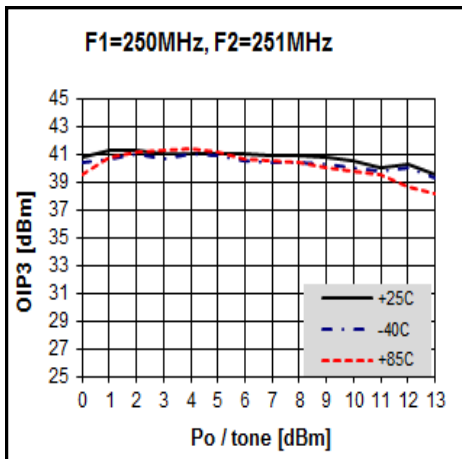
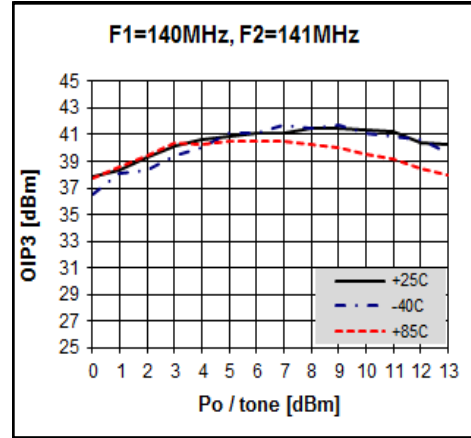
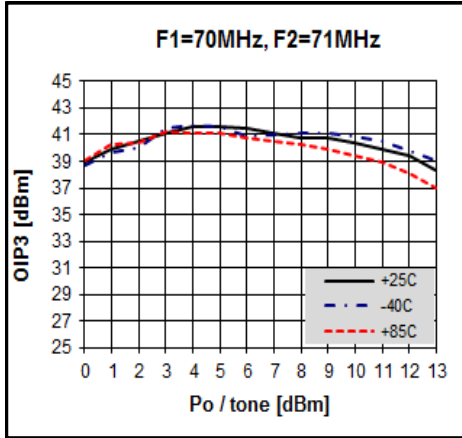
OIP3

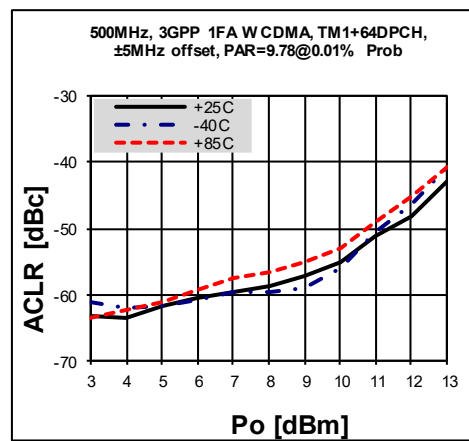
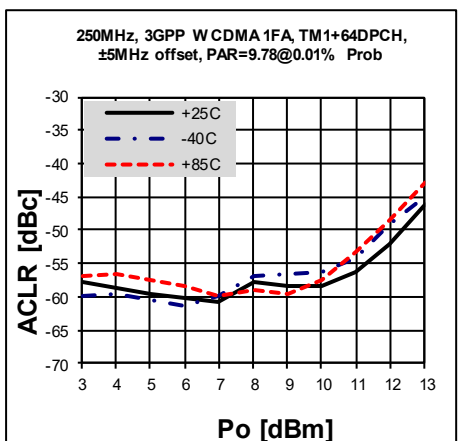
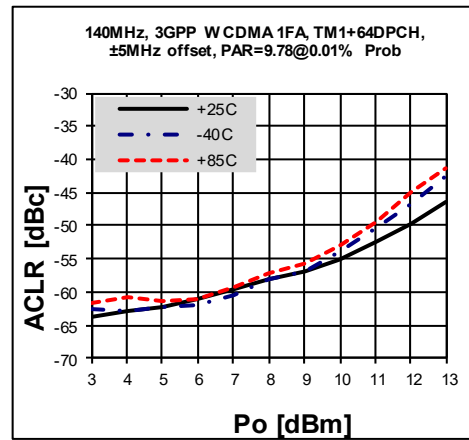
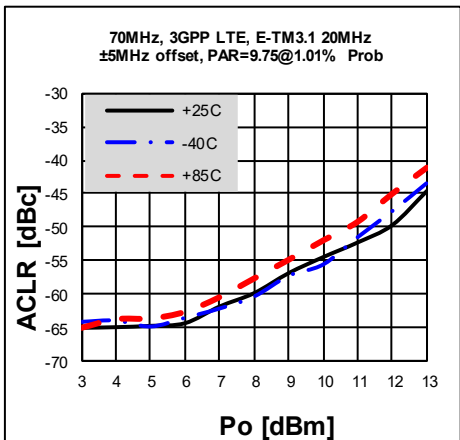
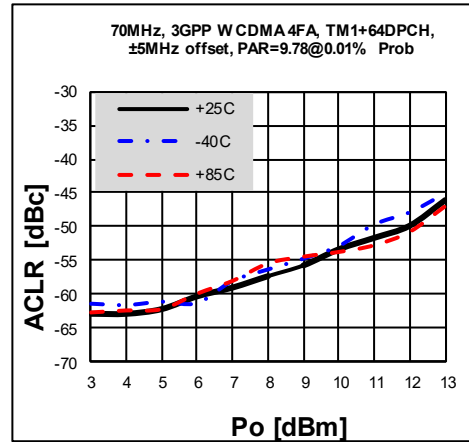
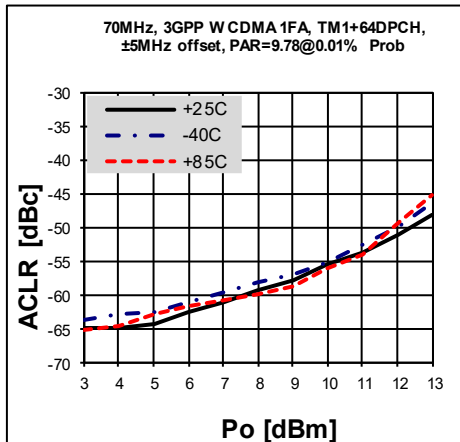
ACLR / LTE

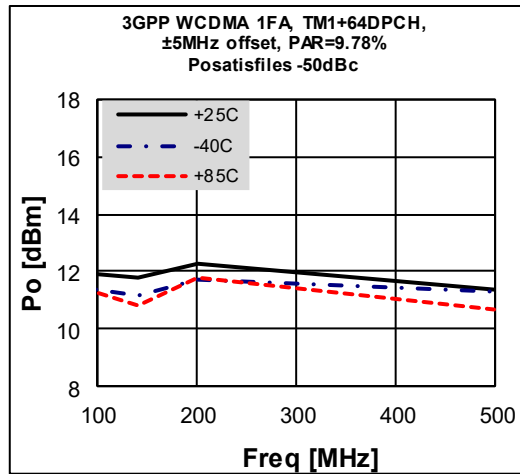

S-Parameters over Temperature

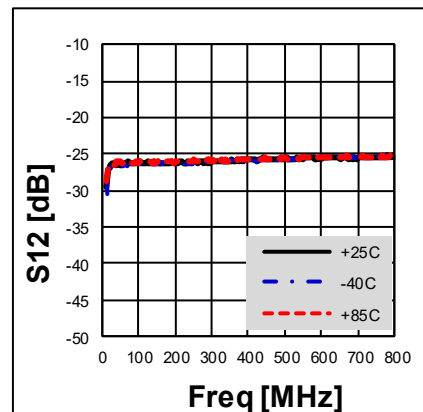
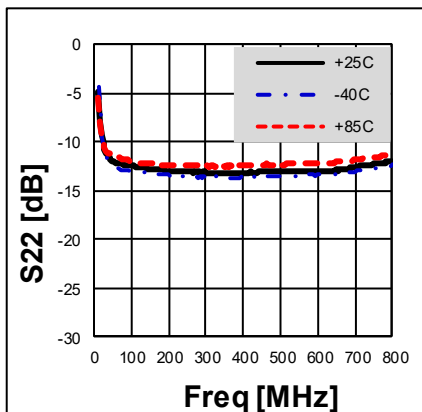
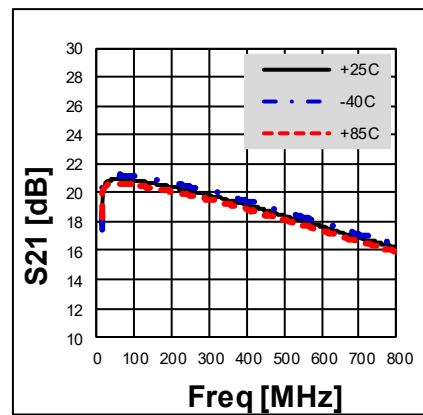
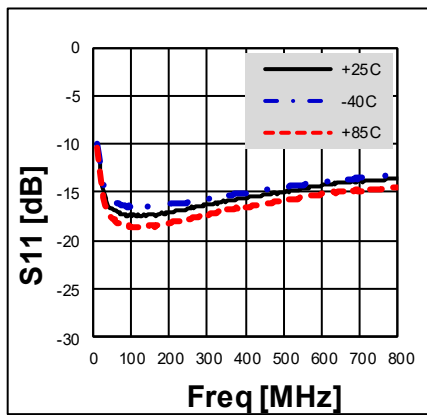

Package Outline Dimension

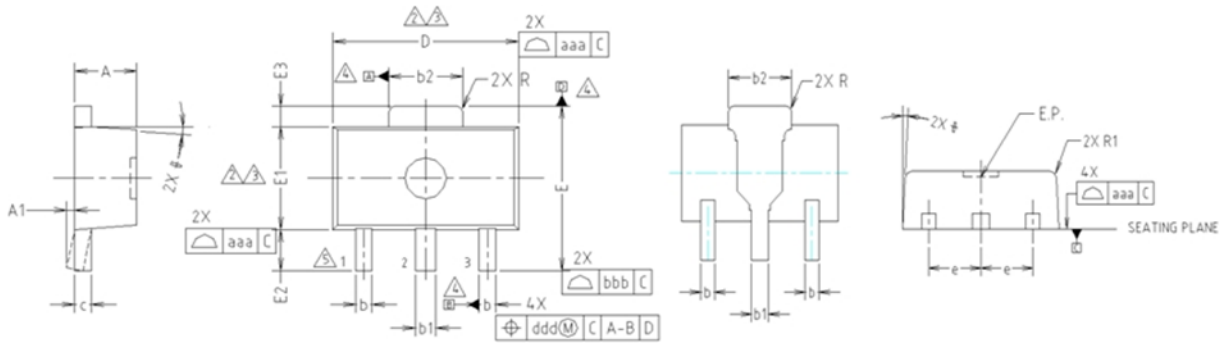

- NOTE:**
 1. DIMENSIONS IN MILLIMETERS.
- ⚠ DIMENSION D DOES NOT INCLUDE MOLD FLASH, PROTRUSIONS OR GATE BURRS. MOLD FLASH, PROTRUSIONS OR GATE BURRS SHALL NOT EXCEED 0.5mm PER END. DIMENSION E1 DOES NOT INCLUDE INTERLEAD FLASH OR PROTRUSION. INTERLEAD FLASH OR PROTRUSION SHALL NOT EXCEED 0.5mm PER SIDE.
 - ⚠ DIMENSIONS D AND E1 ARE DETERMINED AT THE OUTMOST EXTREMES OF THE PLASTIC BODY EXCLUSIVE OF MOLD FLASH, TIE BAR BURRS, GATE BURRS AND INTERLEAD FLASH, BUT INCLUDING ANY MISMATCH BETWEEN THE TOP AND BOTTOM OF THE PLASTIC BODY.
 - ⚠ DATUMS A, B AND D TO BE DETERMINED 0.18mm FROM THE LEAD TIP.
 - ⚠ TERMINAL NUMBERS ARE SHOWN FOR REFERENCE ONLY.

SYMBOL	MILLIMETERS			NOTE
	MINIMUM	NOMINAL	MAXIMUM	
A	1.40	1.50	1.60	
A1	0.00	—	0.10	
b	0.38	0.42	0.48	
b1	0.48	0.52	0.58	
b2	1.79	1.82	1.87	
c	0.40	0.42	0.46	
D	4.40	4.50	4.70	2,3
E	3.70	4.00	4.30	
E1	2.40	2.50	2.70	2,3
E2	0.80	1.00	1.20	
E3	0.40	0.50	0.60	
e	1.50 TYP.			
φ	4° TYP.			
R	0.15 TYP.			
R1	—	—	0.20	
SYMBOL	TOLERANCES OF FORM AND POSITION		NOTE	
aaa	0.15			
bbb	0.20			
ccc	0.10			
ddd	0.10			

Suggested PCB Land Pattern and PAD Layout

PCB Land Pattern

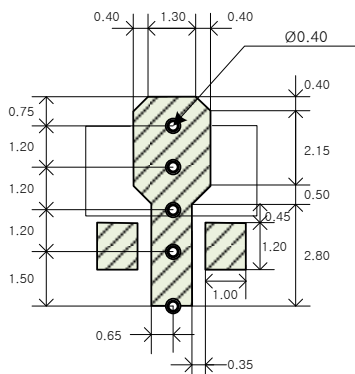

Note : All dimension _ millimeters

PCB lay out _ on BeRex website

PCB Mounting

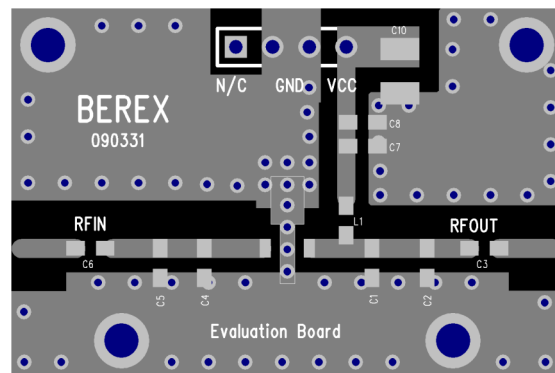

Package Marking

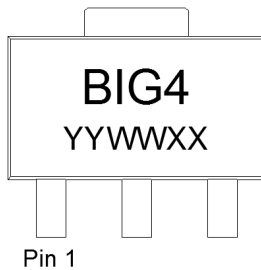

YY = Year, WW = Working Week,
XX = Wafer No.

Tape & Reel

SOT89

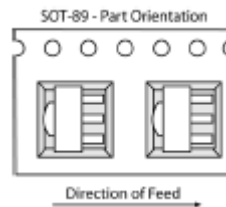

Packaging information:

Tape Width (mm): 12
Reel Size (inches): 7
Device Cavity Pitch (mm): 8
Devices Per Reel: 1000

Lead plating finish

100% Tin Matte finish

(All BeRex products undergoes a 1 hour, 150 degree C, Anneal bake to eliminate thin whisker growth concerns.)

MSL / ESD Rating

ESD Rating: Class 1C
Value: Passes <2000V
Test: Human Body Model (HBM)
Standard: JEDEC Standard JS-001-2012

MSL Rating: Level 1 at +260°C convection reflow
Standard: JEDEC Standard J-STD-020



Proper ESD procedures should be followed when handling this device.

RoHS Compliance

This part is compliant with Restrictions on the Use of Certain Hazardous Substances in Electrical and Electronic Equipment (RoHS) Directive 2011/65/EU as amended by Directive 2015/863/EU.

This product also is compliant with a concentration of the Substances of Very High Concern (SVHC) candidate list which are contained in a quantity of less than 0.1%(w/w) in each components of a product and/or its packaging placed on the European Community market by the BeRex and Suppliers.

NATO CAGE code:

2	N	9	6	F
---	---	---	---	---