

TINA3-WWW

~70° wide beam optimized for CREE XP-E.
Assembly with holder, installation tape and
location pins.

SPECIFICATION:

Dimensions	Ø 16.1 mm
Height	7 mm
Fastening	tape, pin
ROHS compliant	yes ⓘ

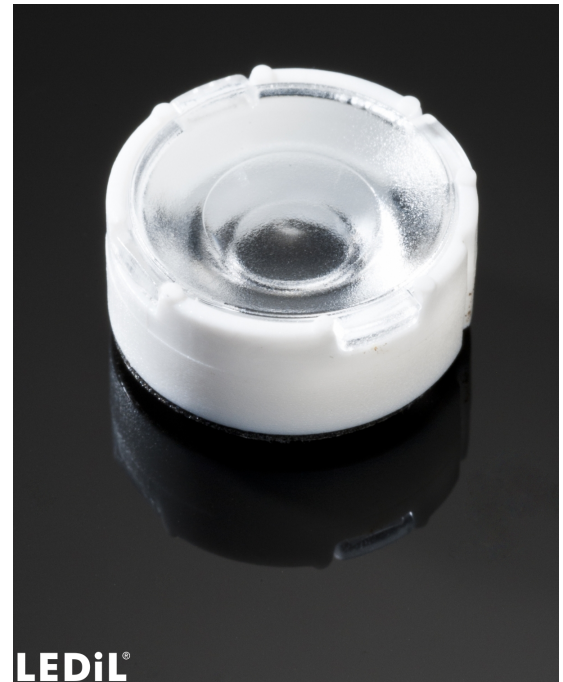

MATERIALS:

Component	Type	Material	Colour	Finish
TINA3-WWW	Single lens	PMMA	clear	
TINA3-HLD-PIN-TAPE-XP	Holder	PC	white	
TINA-TAPE3	Tape	Acrylic foam	black	

ORDERING INFORMATION:

Component		Qty in box	MOQ	MPQ	Box weight (kg)
FA11904_TINA3-WWW	Single lens	2016	288	288	3.0
» Box size:					

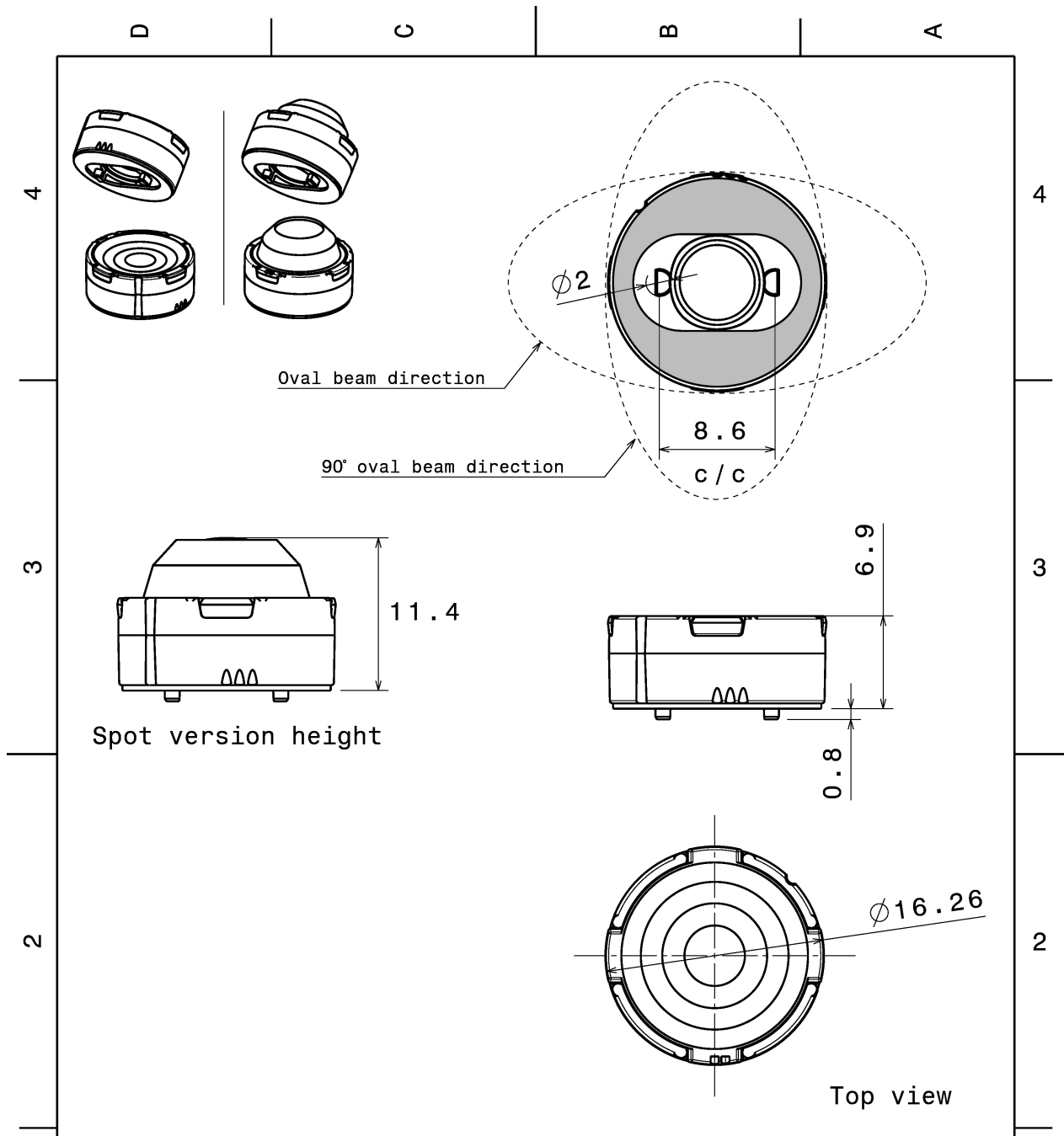

Tolerances if not otherwise shown
According to DIN ISO 2768-1
Linear measures:
Up to 30mm class F, otherwise class M.
According to DIN ISO 2768-2
Form and position: class K

LEDiL LediL Oy
Salorankatu 10
FIN 24240 SALO
Finland

THIRD ANGLE PROJECTION:

DRAWING TITLE
TINA3 Datasheet

This drawing is the property of LEDiL Oy. It may not be reproduced, copied or communicated without a written agreement with LEDiL Oy."

SIZE	PART NUMBER
A4	-

SCALE	4:3	WEIGHT	-	SHEET	1/1
-------	-----	--------	---	-------	-----

See also our general installation guide: www.ledil.com/installation_guide

OPTICAL RESULTS (MEASURED):

CREE LED

LED XM-L
 FWHM / FWTM 70.0° / 122.0°
 Efficiency 89 %
 Peak intensity 0.6 cd/m
 LEDs/each optic 1
 Light colour White
 Required components:

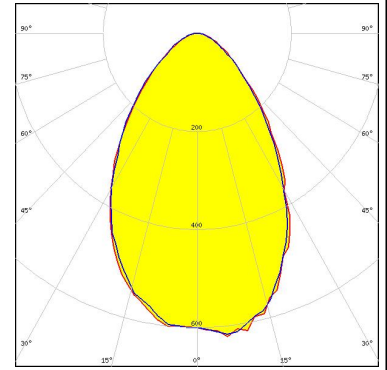

CREE LED

LED XM-L2
 FWHM / FWTM 71.0° / 110.0°
 Efficiency 88 %
 Peak intensity 0.7 cd/m
 LEDs/each optic 1
 Light colour White
 Required components:

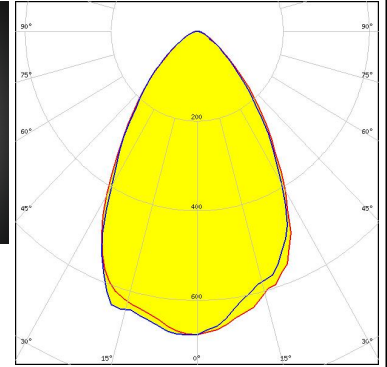

CREE LED

LED XP-G2
 FWHM / FWTM 67.0° / 107.0°
 Efficiency 90 %
 Peak intensity 0.7 cd/m
 LEDs/each optic 1
 Light colour White
 Required components:

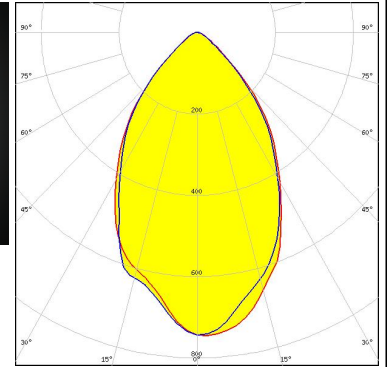
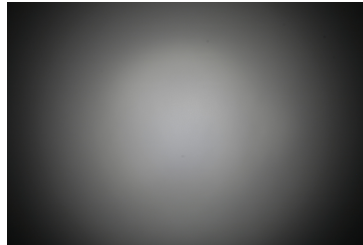

CREE LED

LED XP-L HD
 FWHM / FWTM 65.0° / 112.0°
 Efficiency 89 %
 Peak intensity 0.7 cd/m
 LEDs/each optic 1
 Light colour White
 Required components:

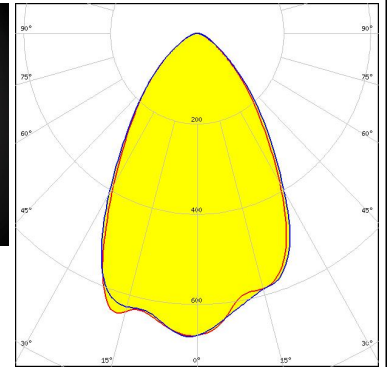
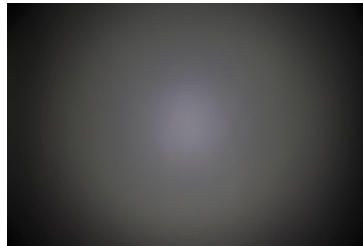

OPTICAL RESULTS (MEASURED):



LED XP-L HI
 FWHM / FWTM 67.0° / 101.0°
 Efficiency 90 %
 Peak intensity 0.8 cd/lm
 LEDs/each optic 1
 Light colour White
 Required components:

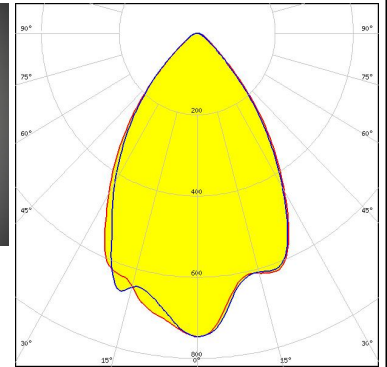

LED XT-E
 FWHM / FWTM 60.0° / 110.0°
 Efficiency 88 %
 Peak intensity 0.8 cd/lm
 LEDs/each optic 1
 Light colour White
 Required components:

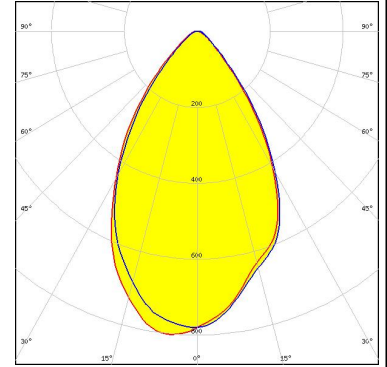

LED NS9x383
 FWHM / FWTM 72.0° / 114.0°
 Efficiency 87 %
 Peak intensity 0.6 cd/lm
 LEDs/each optic 1
 Light colour White
 Required components:

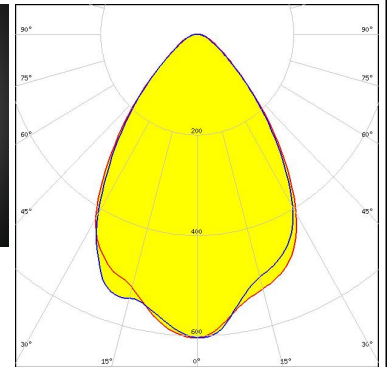
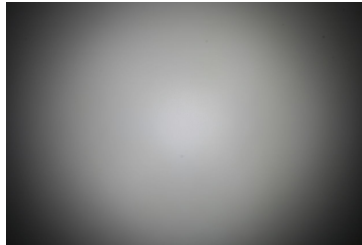

LED NVSW219F
 FWHM / FWTM 64.0° / 107.0°
 Efficiency 90 %
 Peak intensity 0.7 cd/lm
 LEDs/each optic 1
 Light colour White
 Required components:

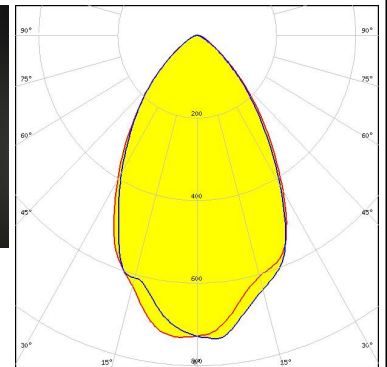
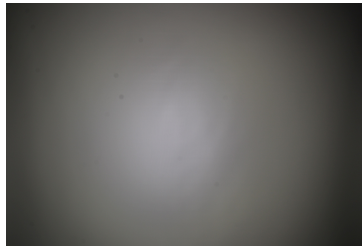

OPTICAL RESULTS (MEASURED):



OPTICAL RESULTS (SIMULATED):

CREE LED

LED: XD16
 FWHM / FWTM: 77.0° / 116.0°
 Efficiency: 87 %
 Peak intensity: 0.5 cd/lm
 LEDs/each optic: 4
 Light colour: White
 Required components:

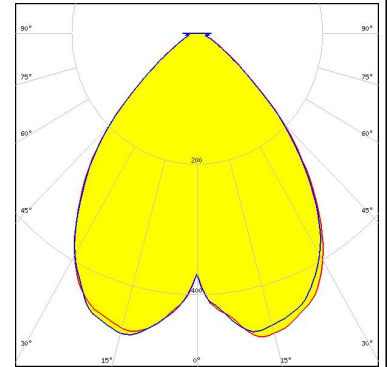

CREE LED

LED: XHP35 HD
 FWHM / FWTM: 67.0° / 120.0°
 Efficiency: 84 %
 Peak intensity: 0.6 cd/lm
 LEDs/each optic: 1
 Light colour: White
 Required components:

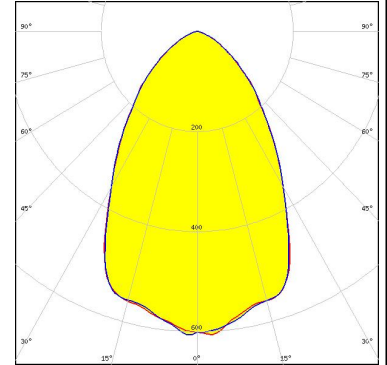

CREE LED

LED: XHP35 HI
 FWHM / FWTM: 75.0° / 109.0°
 Efficiency: 94 %
 Peak intensity: 0.7 cd/lm
 LEDs/each optic: 1
 Light colour: White
 Required components:

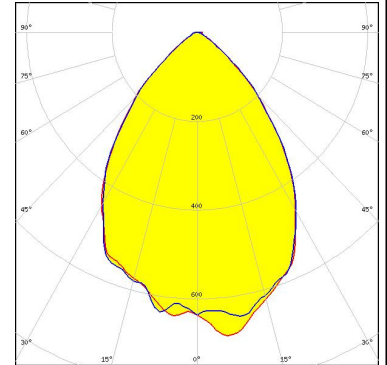

CREE LED

LED: XHP35.2 HD
 FWHM / FWTM: 79.0° / 120.0°
 Efficiency: 86 %
 Peak intensity: 0.5 cd/lm
 LEDs/each optic: 1
 Light colour: White
 Required components:

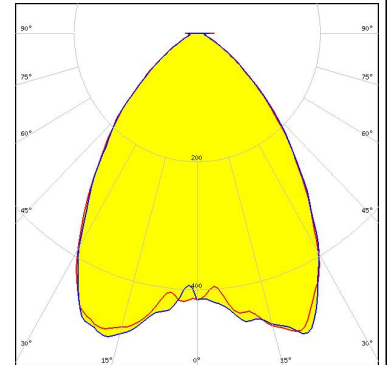

OPTICAL RESULTS (SIMULATED):



LED XM-L HVW
 FWHM / FWTM 80.0°
 Efficiency %
 LEDs/each optic 1
 Light colour White
 Required components:



LED XP-G3
 FWHM / FWTM 76.0° / 113.0°
 Efficiency 91 %
 Peak intensity 0.6 cd/lm
 LEDs/each optic 1
 Light colour White
 Required components:

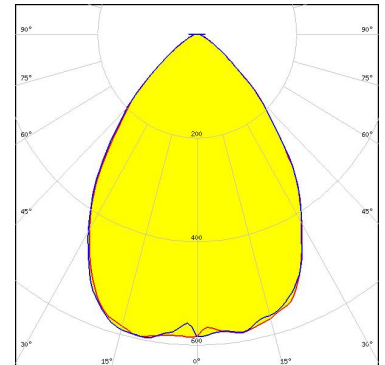

LED LUXEON HL2X
 FWHM / FWTM 81.0° / 113.0°
 Efficiency 93 %
 Peak intensity 0.6 cd/lm
 LEDs/each optic 1
 Light colour White
 Required components:

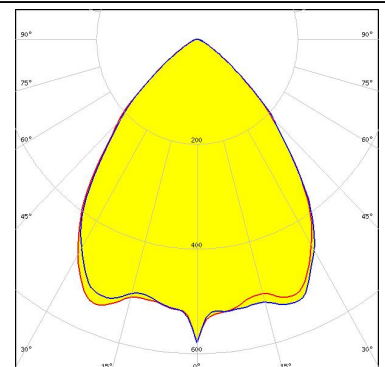

LED SST-10-IR-B90
 FWHM / FWTM 72.0° / 99.0°
 Efficiency 92 %
 LEDs/each optic 1
 Light colour IR
 Required components:

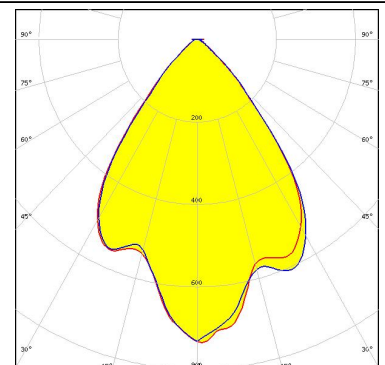
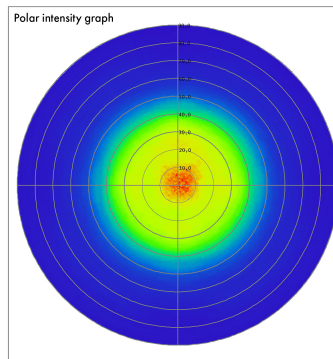

OPTICAL RESULTS (SIMULATED):



LED	NVSW3x9A
FWHM / FWTM	79.0° / 117.0°
Efficiency	92 %
Peak intensity	0.6 cd/lm
LEDs/each optic	1
Light colour	White
Required components:	

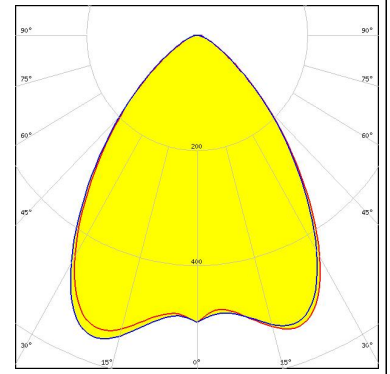

GENERAL INFORMATION:

NOTE: The typical beam angle will be changed by different color, chip size and chip position tolerance. The typical total beam angle is the full angle measured where the luminous intensity is half of the peak value.

MATERIALS:

As part of our continuous research and improvement processes, and to ensure the best possible quality and availability of our products, LEDiL reserves the right to change material grades without notice.

PRODUCT DATA USER AGREEMENT AND DISCLAIMER:

The measured data in the provided downloadable LEDiL Product Datasheets and Mechanical 2D-Drawings is rounded and provided as reference for planning. LEDiL Oy's optical specifications have been verified by conducting performance testing of the products in accordance with the company's quality system. The reported data are averaged results of multiple measurements with typical variation. LEDiL Oy reserves the right to without prior notification make changes and improvements to its products.

LEDiL Oy assumes neither warranty, nor guarantee nor any other liability of any kind for the contents and correctness of the provided data. The provided data has been generated with highest diligence but the provided data may in reality not represent the complete possible variation range of all intrinsic parameters. Therefore, in certain cases a deviation from the provided data could occur.

LEDiL Oy reserves the right to undertake technical changes of its products without further notification which could lead to changes in the provided data. LEDiL Oy assumes no liability of any kind for the possible deviation from any provided data or any other damage resulting from the usage of the provided data.

The user agrees to this disclaimer and user agreement with the download or usage of the provided files.

LEDiL Oy

Joensuunkatu 13
FI-24240 SALO
Finland

LEDiL Inc.

228 West Page Street
Suite D
Sycamore IL 60178
USA

Ledil Optics Technology (Shenzhen) Co., Ltd.

405 , Block B
Casic Motor Building
Shenzhen 518057
P.R.CHINA

Local sales and technical support

[www.ledil.com/
where_to_buy](http://www.ledil.com/where_to_buy)

Shipping locations

Salo, Finland
Hong Kong, China

Distribution Partners

[www.ledil.com/
where_to_buy](http://www.ledil.com/where_to_buy)