

## MAX17852 Evaluation Kit

Evaluates: MAX17852

### General Description

The MAX17852 evaluation kit (EV kit) is used to demonstrate the features and capabilities of the MAX17852 14-channel high-voltage smart sensor data-acquisition interface IC. The EV kit is coupled with a MAX17841B EV kit to establish communication to a host PC. With communication established, control of the MAX17852 EV kit is executed through the EV kit graphical user interface (GUI) on the host PC. The GUI is Windows XP®, Windows Vista®, Windows® 7, and Windows 10 compatible and is available through your local Maxim Integrated sales office. **Note:** References to the MAX17841 in this data sheet pertain equally to the MAX17841B as well.

The MAX17852 EV kit design provides a convenient platform for evaluating the features and functions of the IC, in addition to the IC's electrical parameters. The EV kit with vertical communication connectors (P2, P3, P5, and P6) and snap and lock battery pack connector enable the user to quickly build and evaluate a system with up to 32 daisy-chain devices.

**Ordering Information** appears at end of data sheet.

### Features

- Provides a Convenient Platform for Evaluating the Features and Functions of the MAX17852
- Versatile GUI Interface for Features Evaluation
- Plug-and-Play Architecture for Rapid System Prototyping
- Force and Sense Pin Headers for Precision Measurement Assessment
- Built-In Resistor Stack for Battery Emulation
- Proven PCB Layout
- Fully Assembled and Tested

### MAX17852 EV Kit Files

FILE	DESCRIPTION
MAX17853_EV kit_Installer.exe	Software: Graphical User Interface (GUI)
MAX1785X_EVKIT_A.pdf	Schematic File pdf
MAX1785X_EVKIT_A.pdf	PCB Layout File pdf

*Windows, Windows XP, and Windows Vista are registered trademarks and registered service marks of Microsoft Corporation.*

## Quick Start (Single UART)

This procedure describes the setup and initialization of a two-module distributed daisy-chained system using the MAX17852 in a single UART with external loopback communication mode. The user may choose to expand the system with additional EV kit modules depending on their requirements and testing needs.

### Required Hardware

- Two MAX17852 EV kits (cables included)
- One Single UART MAX17841B EV kit (includes the MINIUSB+ interface board)
- 9V to 65V DC power supplies (refer to the MAX17852 IC data sheet for recommended operating range)
- User-supplied Windows XP-, Windows Vista-, Windows 7-, or Windows 10-compatible PC with a spare USB port

**Note:** In the following sections, software-related items are identified by bolding. Text in **bold** refers to items directly from the EV kit software. Text in **bold and underlined** refers to items from the Windows operating system.

### Procedure

The MAX17852 EV kit is fully assembled and functionally tested prior to shipment. Follow the steps below to become acquainted with the MAX17852 EV kit and initialize the single-UART EV kit communication. Enable power supplies only after all connections have been completed:

- 1) Install the MAX17852 EV kit software on your computer by running the MAX17853\_EV kit\_Installer.exe.
- 2) Connect the MINIUSB+ to the J3 and J4 headers on the single-UART MAX17841B EV kit.
- 3) Connect the USB cable from the PC to the MINIUSB+ board. A **Building Driver Database** window pops up in addition to a **New Hardware Found** message if this is the first time the EV kit board is connected to the PC. If a window is not seen like the one described above after 30s, remove the USB cable from the MINIUSB+ and reconnect again. Administrator privileges are required to install the USB device driver on Windows XP, Windows Vista, Windows 7, and Windows 10.
- 4) Follow the directions of the **Add New Hardware Wizard** to install the USB device driver. Choose the

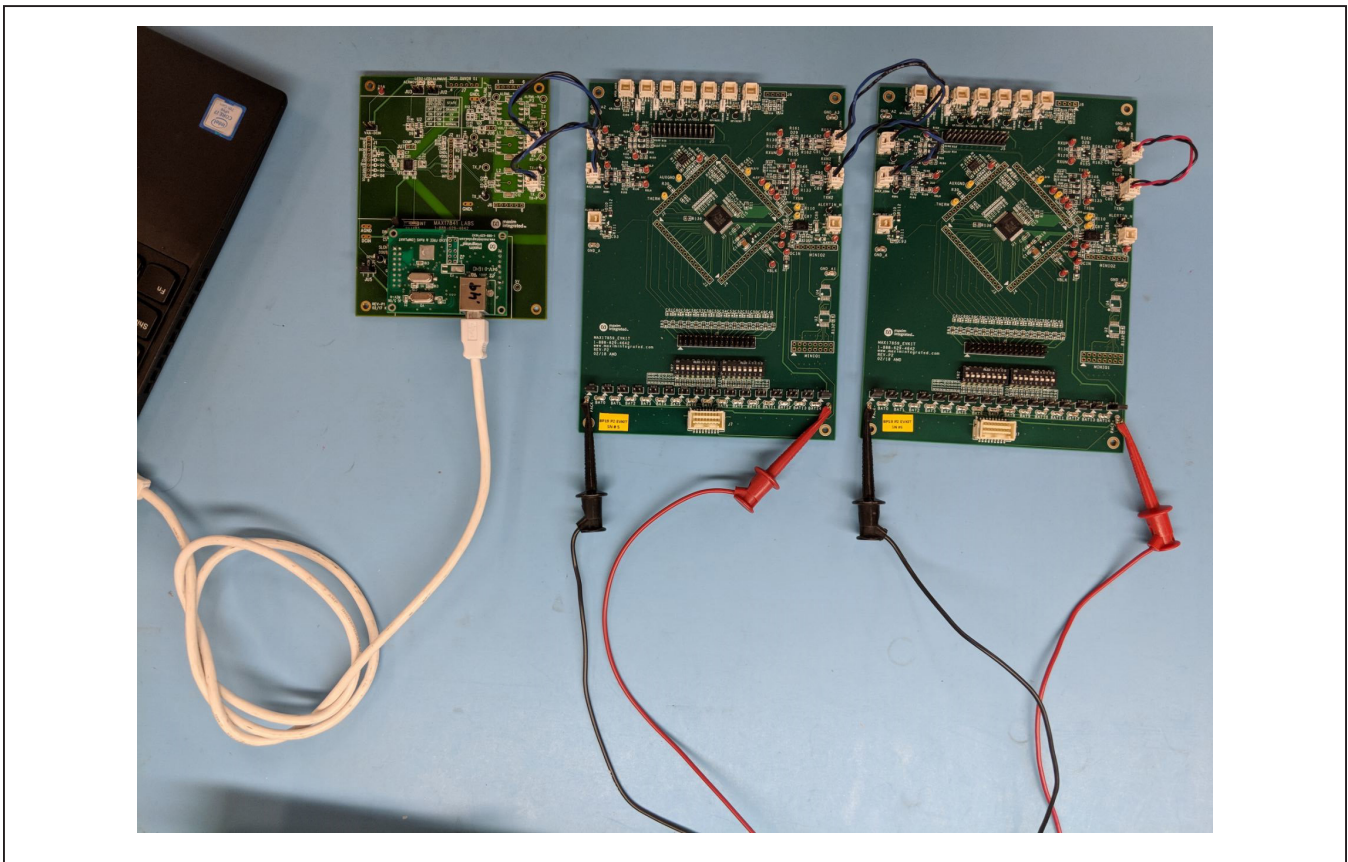

Figure 1. MAX17852 EV Kit System for Single UART

**Search for the Best Driver for Your Device** option. Specify the location of the device driver to be C:\Program Files\MAX17852 (default installation directory) using the Browse button. Refer to the USB\_Driver\_Help.pdf document included with the software for additional information.

- 5) Download and install the appropriate FTDI drivers from <https://www.ftdichip.com/Drivers/D2XX.htm> if required.
- 6) Ensure that all jumper shunts and switches are configured as listed in [Table 1](#), [Table 2](#), and [Table 3](#).
- 7) For purposes of evaluation a single power supply can be used to power all MAX17852 EV kits in a system with a common ground. Configure the DC power supply and disable the output.
- 8) Connect each MAX17852 EV kit PACK+ and PACK- to the power-supply output. Terminate PACK+ to the power-supply positive output and PACK- to the power-supply negative output.
- 9) Connect the four 2-wire black/blue crossover cables, as described below:
  - a) Connect P1 on the MAX17841B EV kit to RXLP\_CONN on the first MAX17852 EV kit
  - b) Connect P2 on the MAX17841B EV kit to TXLP\_CONN on the first MAX17852 EV kit
  - c) Connect TXUP\_CONN on the first MAX17852 EV kit to RXLP\_CONN on the second MAX17852 EV kit
  - d) Connect RXUP\_CONN on the first MAX17852 EV kit to TXLP\_CONN on the second MAX17852 EV kit

**Note:** The connections mentioned in steps 1–4 can be generalized for any number of devices within a daisy-chain (up to 32). These connections are also illustrated within the GUI for quick reference.

- 10) On the second MAX17852 EV kit, connect the 2-wire red/black loopback cable from TXUP\_CONN to RXUP\_CONN.
- 11) Enable the DC power supply.
- 12) Start the MAX17852 EV kit software by opening its icon in the Start Programs menu. The EV kit GUI software automatically establishes communication with the Maxim MINIQUSB+ interface. The status bar at the bottom of the GUI displays **Maxim MINIQUSB+ V02.05.xx** and **UART Not Initialized** (see [Figure 8](#)). With the MINIQUSB detected, the user can proceed to the next step.

- 13) In the **Communication** tab ([Figure 8](#)), click on the **Single UART with External Loopback** radio button.
- 14) Select the **Initialization** tab ([Figure 13](#)).
- 15) Click the **Wakeup** button.
- 16) Click the **Hello ALL** button.
- 17) In the bottom-right side of status bar, verify communication is established with the UART. Status reads **Single UART Connected**.  
In the **Event Log** group box, verify:  
18-08-13 14:22:20 HelloAll Successful  
18-08-13 14:22:20 Dev0 MAX17852 Ver 4  
18-08-13 14:22:20 Dev1 MAX17852 Ver 4  
18-08-13 14:22:20 UART device ready
- 18) The EV kit is now ready for further evaluation.

**Table 1. MAX17852 EV Kit Default Jumper Settings**

JUMPER	SHUNT POSITION
P+B14, B0P-	Installed
THERM1–THERM6	On one pin only

**Table 2. MAX17841B EV Kit Default Jumper Settings**

JUMPER	SHUNT POSITION
JU1–JU4, JU6, JU7	On one pin only
JU5	1-2

**Table 3. MAX17841B EV Kit Default Switch Settings**

SWITCH	SETTING
SW1, SW2	ON position

**Notes:**

- 1) The default position of the SW1 and SW2 battery-emulation resistor ladder is OFF (actuators toward battery connector J7), and the setup is for a battery-pack supply.
- 2) The optional position of SW1 and SW2 is ON (actuators toward MAX17852), and the setup is for an external power-supply input between PACK+ and PACK- with the 2kΩ resistor ladder.

### MAX17852 EV Kit Hardware Description

The MAX17852 EV kit PCB is designed with headers, test points, and jumpers, providing convenient access to circuit nets where measurements can be made, and signals monitored.

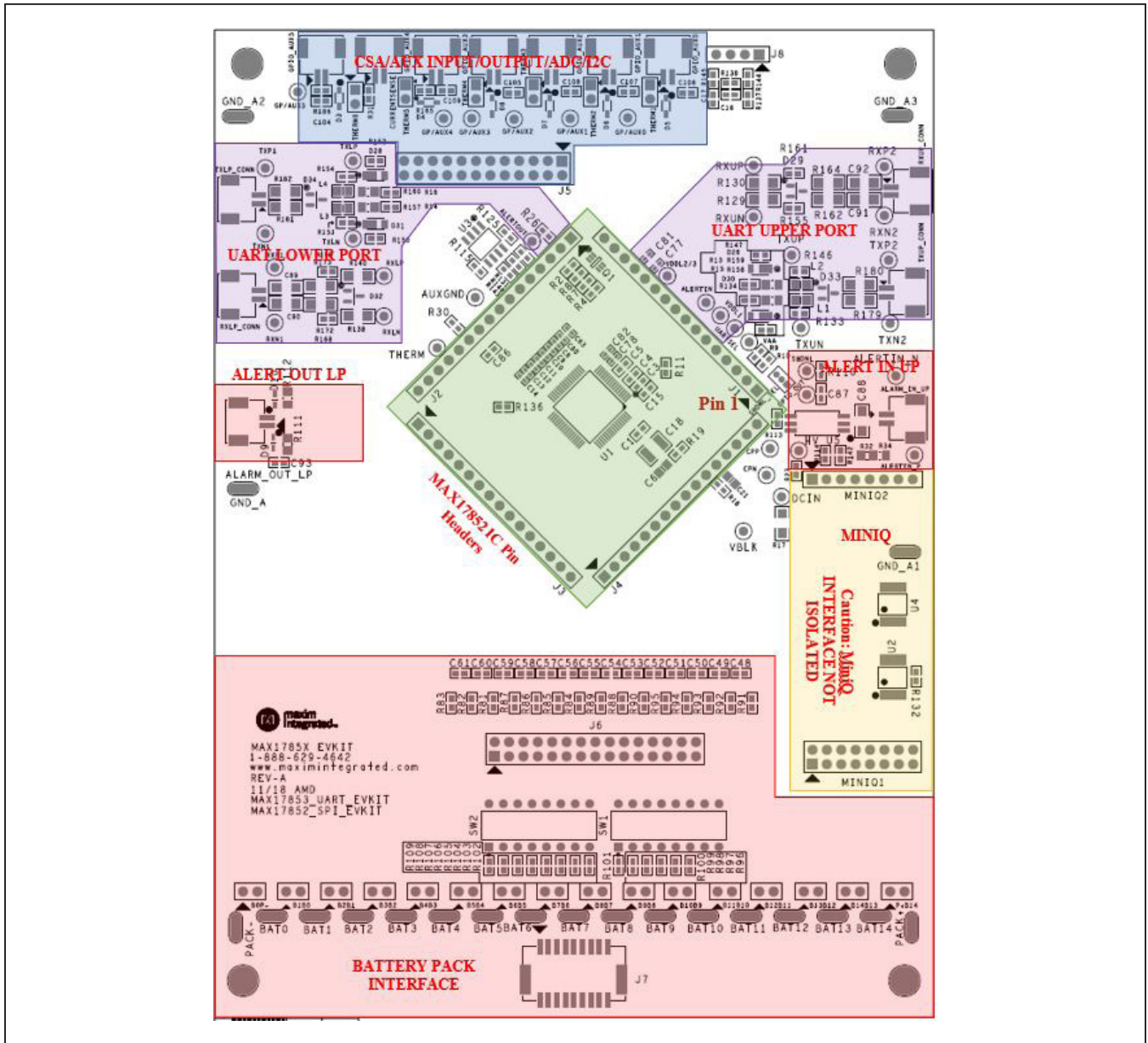

Figure 2. MAX17852 EV Kit PCB

**Battery-Pack Connector (J7)**

Power is applied to the MAX17852 EV kit through the J7 battery-pack connector, or the PACK+ and PACK- test points. The PACK+ and PACK- test points are provided should the user prefer to source power from a laboratory power supply. **Caution:** Only apply a jumper to B0P- and P+B14 when using a battery pack. Placing a jumper on any battery pin header with a battery pack connected places a direct short on the battery-pack cell.

To power the MAX17852 EV kit using a bench power supply, terminate PACK+ to the positive post and PACK- to the negative post of the power supply and install the P+B14 and B0P- jumpers.

**Battery-Cell Emulation**

For convenience, the MAX17852 EV kit PCB is equipped with a 2kΩ resistor ladder to emulate a battery pack when using a bench power supply. To apply the emulated battery-pack resistor ladder voltages to the MAX17852 cell-voltage measurement inputs (C0–C14), place all SW1 and SW2 switches in the closed or ON position. Pack voltage from a bench power supply applied to the 2kΩ resistor ladder divides equally across the resistors and is measured by the MAX17852.

The battery interface includes a battery force and sense pin header (J6) that can be used for precision measurement testing. A forced simulated-battery voltage between adjacent pins on the J6 pin header can be measured at the pin header and compared with the data conversion values of the MAX17852 IC.

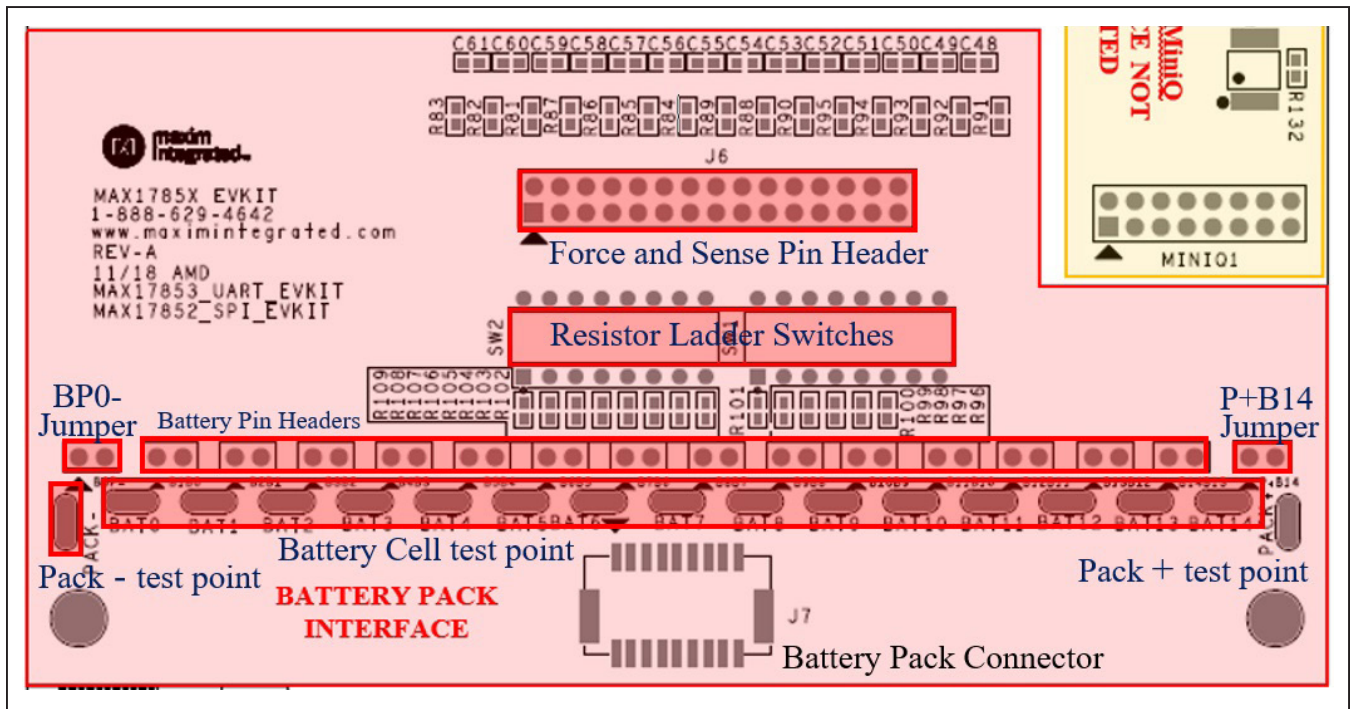

Figure 3. MAX17852 Battery Interface

### AUX Input/Output/ADC

The auxiliary (AUX) input/output/ADC section of the EV kit PCB (see Figure 4) gives the user access to the MAX17852 AUX GPIO pins and THRM pin. Each GPIO\_AUX connector is equipped to interface directly to NTC thermistors for external temperature measurement. With the THERMn jumper installed, the NTC sensor is pulled up through a 10kΩ resistor to the THRM pin on the MAX17852. This feature allows the user to turn on or off the 10kΩ pullup through the THRM pin for energy conservation.

The AUXIN[1:0] pins on the MAX17852 can be configured as an I<sup>2</sup>C master interface using the I2CEN bit in the AUXGPIOCFG register. When the I2CEN bit is high, AUXIN0 operates as the SDA pin and AUXIN1 operates as the SCL pin. In this configuration, the device is capable of functioning as an I<sup>2</sup>C-compatible master and is able to read and write to any number of associated I<sup>2</sup>C-compatible slave devices connected to the 2-wire bus at clock rates of 100kHz or 400kHz. By default, I2CEN is low and the I<sup>2</sup>C master is disabled.

The CSAP and CSAN inputs on the MAX17852 measure the differential voltage across an external precision current shunt resistor to provide an accurate current measurement. To grant the ability to sense finer current resolutions, the current shunt voltage is input to a current sense amplifier (CSA) which scales this voltage to the full-scale voltage of the ADC. The CSA provides battery pack current measurements while enabled (CSAEN = 1). These are stored in the CSA register as 14-bit values. The current measurement is initiated at the start of the scan in parallel with the voltage measurement to allow for optimization of the acquisition time during the required CSA settling time.

GPIO\_AUX is instrumented with a block header (J5) that allows the user to perform AUX\_GPIO force and sense accuracy measurements. To perform accuracy measurement through the J5 header, a voltage is forced onto a pin header and can be sensed through the adjacent pin on the header. The measurement can then be compared to the conversion measurement of the MAX17852.

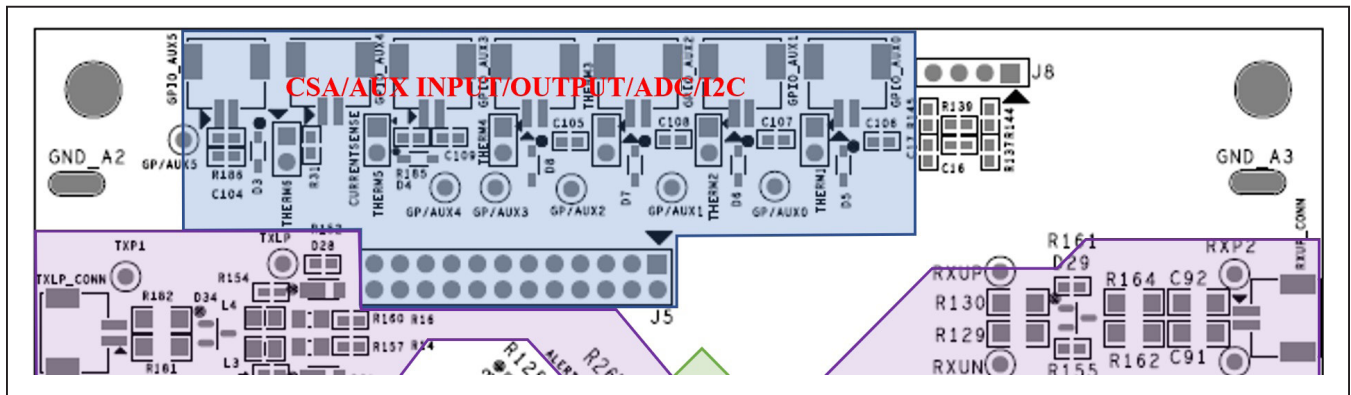

Figure 4. I<sup>2</sup>C CSA GPIO\_AUX Port Access

### UART Ports

The UART communication ports are identified as the upper port (RXU/TXU) and the lower port (RXL/TXL), with reference to the MAX17852 device on the EV kit PCB (see Figure 5). Each UART port comprises a differential transmitter and a differential receiver.

Communication data received on the lower receiver is retransmitted through the upper transmitter to the next EV kit in the daisy-chain. Communication received on the upper receiver is retransmitted through the lower transmitter and downward through the chain. Each differential pair includes four test points for observing the communication

signals. It is critical to note that the upper port (RXP2, RXN2, TXP2, TXN2) test points are referenced to the next higher ground-potential EV kit.

The EV kit UART network and components are designed for the automotive environment and are capable of enduring battery-management-system compliance testing. This includes BCI, ESD, radiated emission, pulse testing, and deactivation of the service-disconnect switch. The PCB and UART components are designed and selected for 630VDC (max) isolation between each MAX17852 EV kit in the daisy-chained system; however, isolation capability has not been tested on the MAX17852 EV kit.

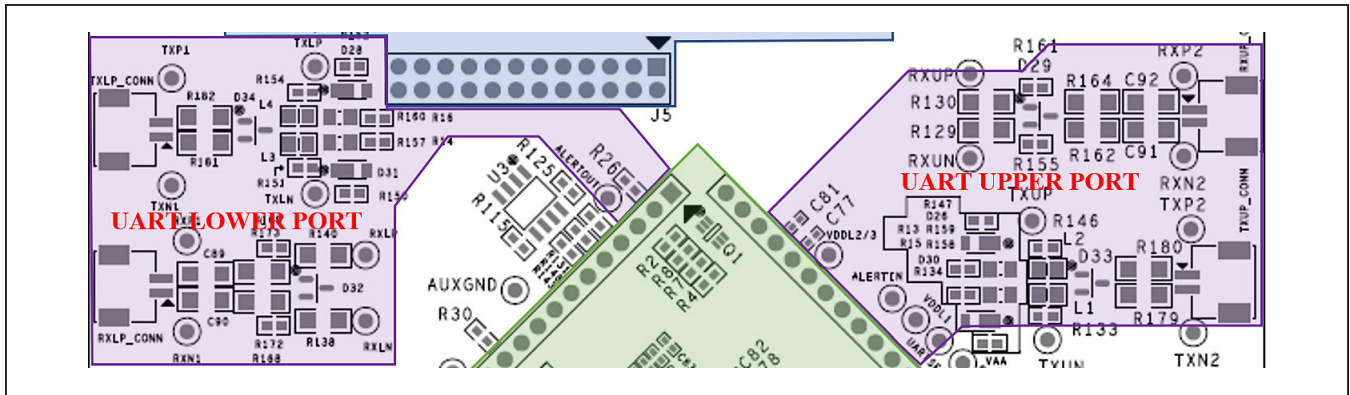

Figure 5. UART Ports

### MAX17852 IC Pin Headers (J1–J4)

Each pin on the MAX17852 is available for easy monitoring through the J1 IC pin header (see [Figure 6](#)). Header J1 is terminated to pins 1–16 on the MAX17852, J2 is terminated to pins 17–32, J3 is terminated to pins 33–48, and J4 is terminated to pins 49–64.

For convenience, certain IC pins are terminated to test points for monitoring frequently observed device signals. Examples include: VBLK, DCIN, HV, CPP, CPN, SHDNL, VAA, UARTSEL, VDDL1, ALERTIN, ALERTOUT, and THERM.

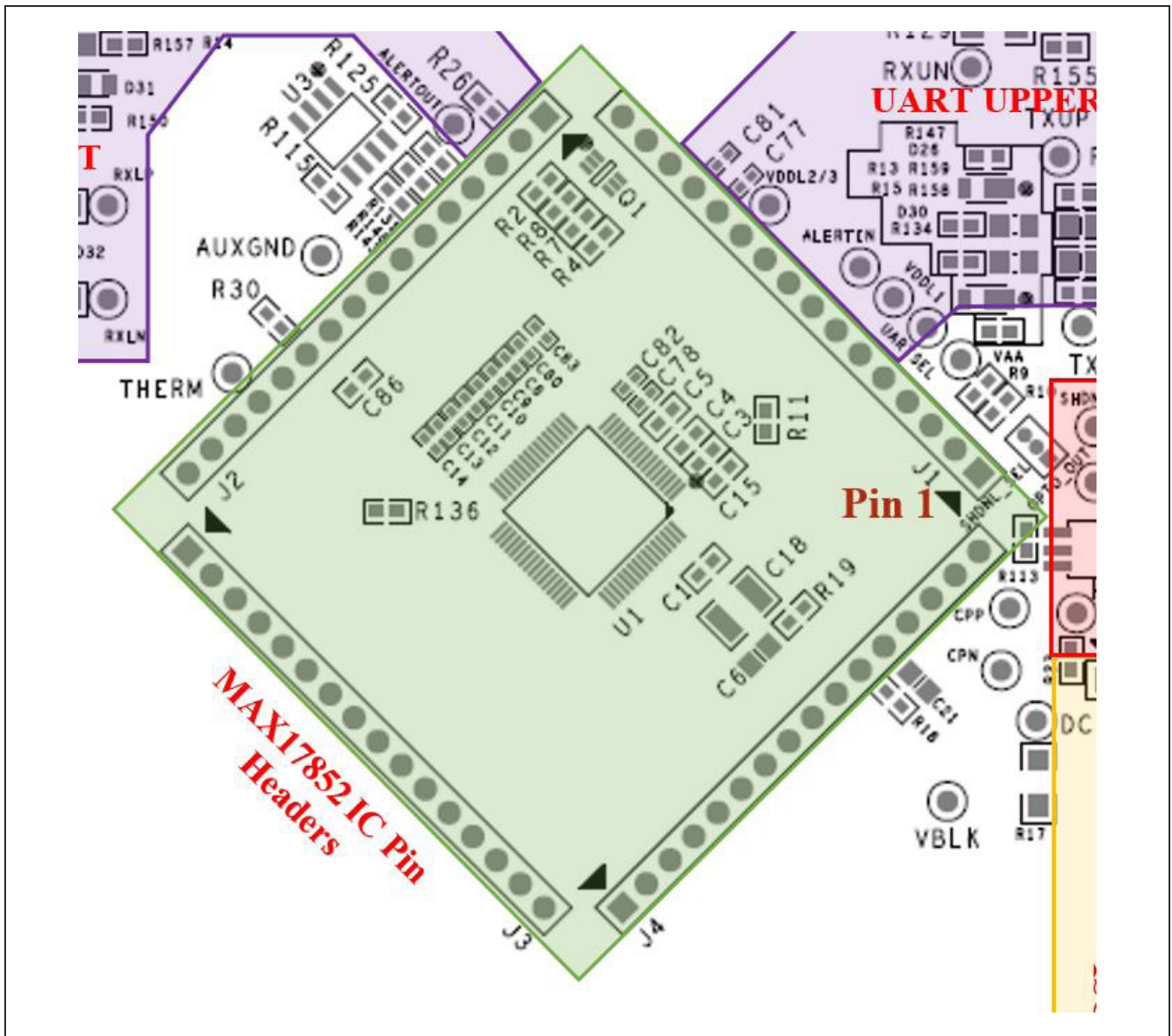

Figure 6. MAX17852 IC Pin Header (J1)



**MAX17841B EV Kit and MINIUSB+**

To complete the Maxim EV kit battery-management evaluation system, it is essential to include the MAX17841B EV kit. The MAX17841B EV kit contains the MAX17841B base board and the PC USB interface board (MINIUSB+). Power and ground for the MAX17841B is derived through the MINIUSB+ and require no other power source. It is critical to note that the MAX17841B EV kit provides the battery-management evaluation system with capacitive isolation on connectors P1 and P2. See [Figure 7](#) for the MAX17841B EV kit PCB.

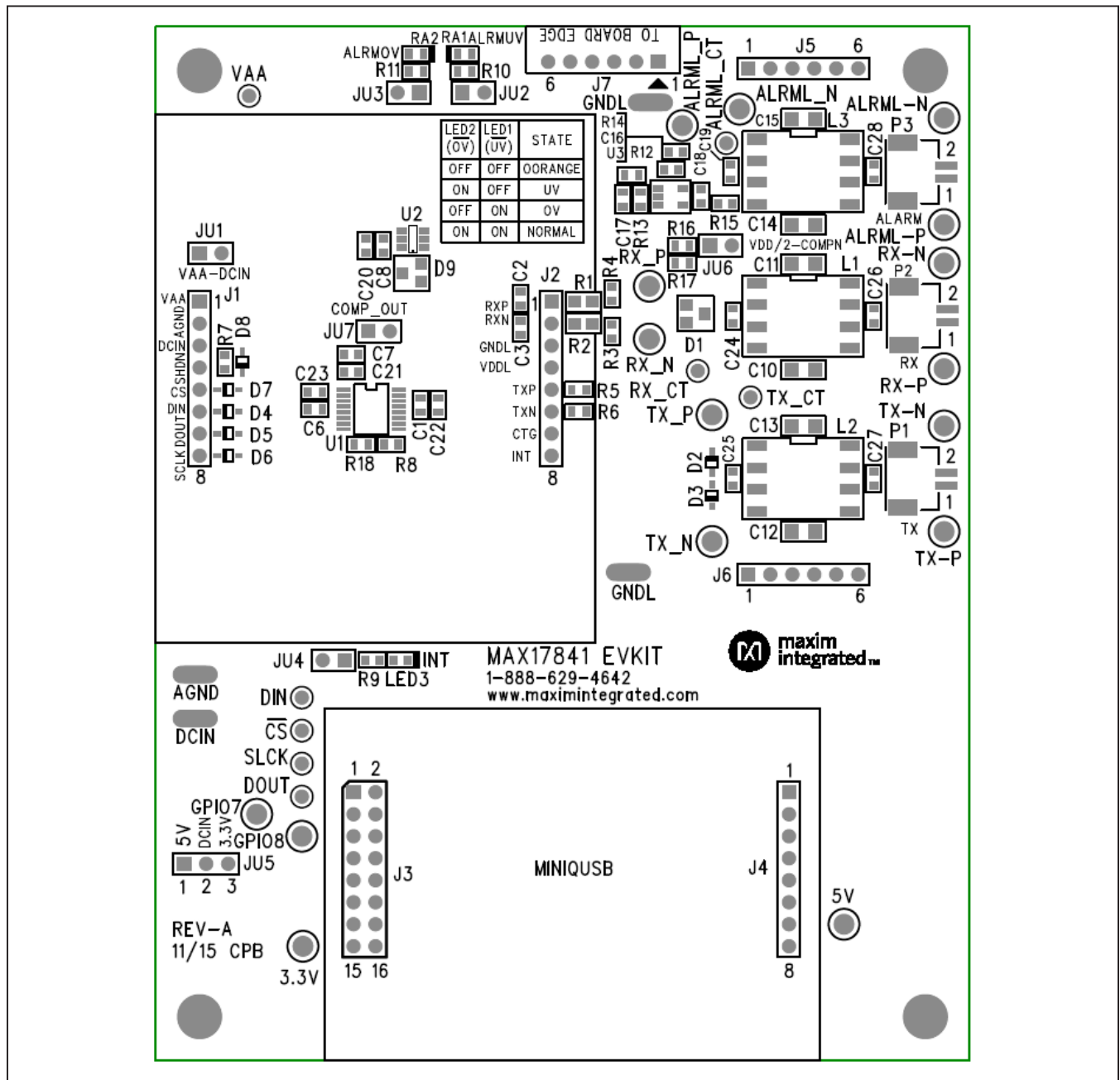

Figure 7. MAX17841B EV Kit PCB

### Using the Graphical User Interface

The MAX17852 EV kit is evaluated in conjunction with the MAX17852 evaluation software. The graphical user interface (GUI) provides a friendly environment for reading and writing to all device registers, as well as executing device commands.

### Communication Tab

The GUI startup cockpit is designed to guide the user through hardware setup and provides overall startup system information. At startup, the GUI automatically initializes and establishes communication with the Maxim MINIUSB+ interface board and places the user on the **Communication** tab (see [Figure 8](#)). UART status is shown in the lower-right corner of the cockpit.

The GUI is preset to UART communication with a dual UART interface (see [Figure 8](#)). When selecting the UART configuration, the hardware graphic updates to reflect the

proper wiring interface for the selected UART. For communication to be established between the MAX17841B EV kit and MAX17852 EV kit, it is imperative that system wiring match the UART configuration selected.

The MAX17852 EV kit is designed to support **Single UART Interface with External Loopback**, as shown in [Figure 10](#). Follow the UART wiring changes shown in [Figure 9](#), [Figure 11](#), and [Figure 12](#) for alternative UART configurations.

Located in the **Communication** tab ([Figure 8](#)) is the **UART Options** group box. Options set in the **UART Options** group box control TXL and TXU idle state impedance, adaptive transmission setting, and packet error check (PEC). The user can also enable and evaluate the alert function, double-buffer feature, UART DC diagnostic test, and control the alive-counter bit (ALIVECNTEN).

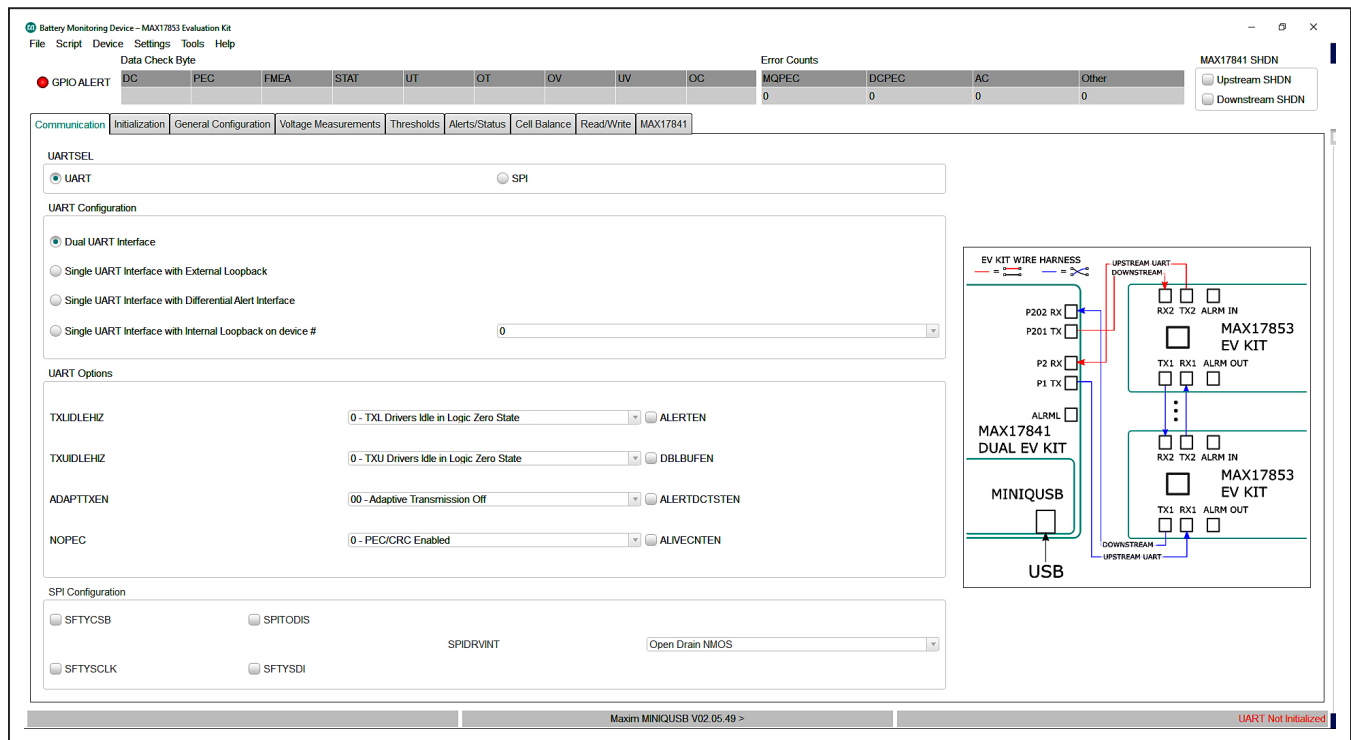

Figure 8. Communication Tab

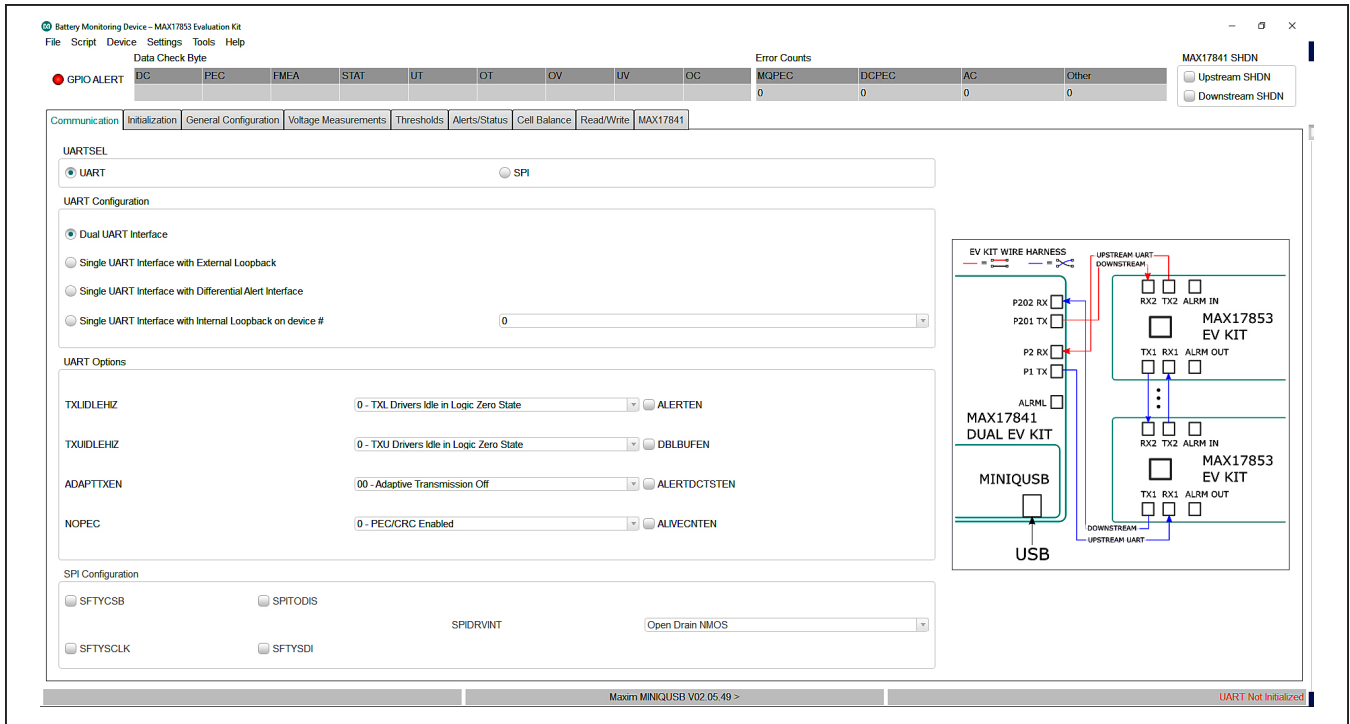

Figure 9. Dual UART Interface

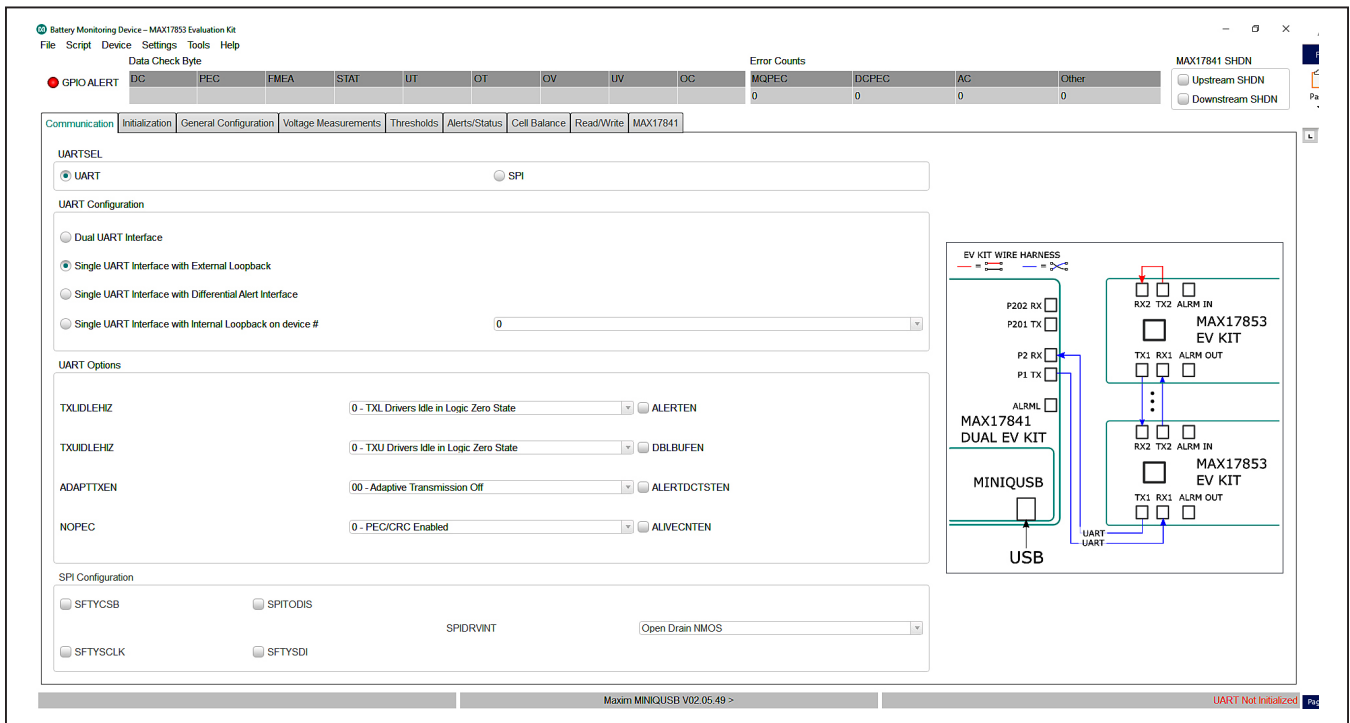

Figure 10. Single UART Interface with External Loopback

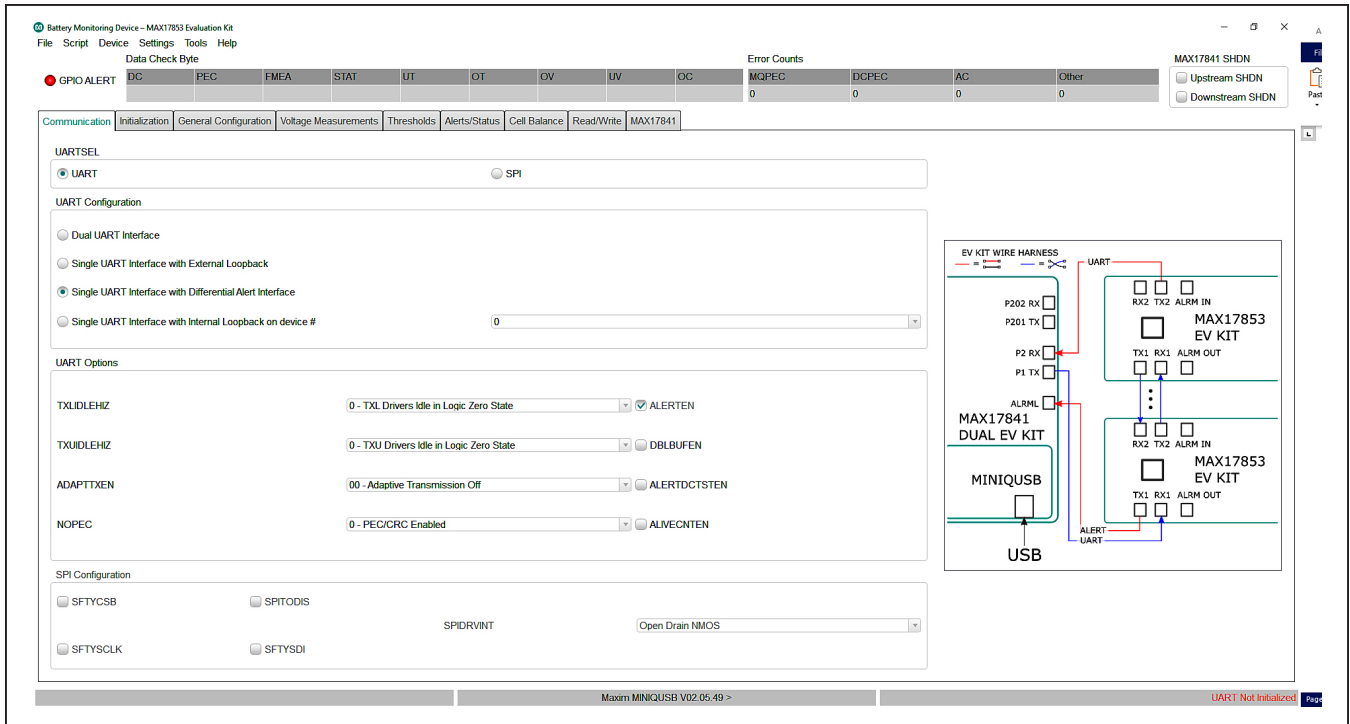

Figure 11. Single UART Interface with Differential Alert Interface

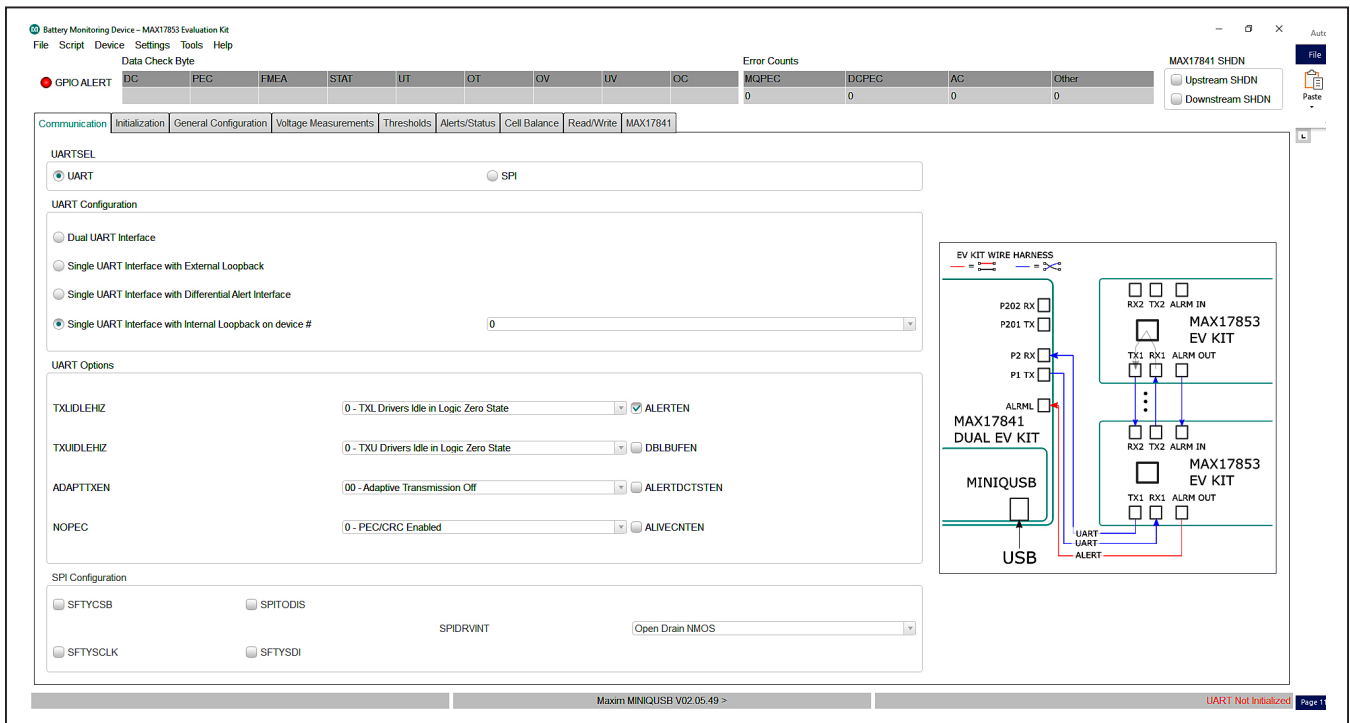

Figure 12. Single UART Interface with Internal Loopback on Device#

### Initialization Tab

The **Initialization** tab (see [Figure 13](#)) is used to initialize the system and assign addresses to each device in the daisy-chain. The correct **Single UART Interface** or **Dual UART Interface** radio button must be selected for the hardwired system. Communication is only established when the wired system aligns with the interface chosen from the **UARTCFG** group box. With the **Dual UART Interface** radio button selected, the user has the option of selecting **UPHOST** or **DOWNHOST**. Further information on UPHOST and DOWNHOST communication is available in the MAX17852 IC data sheet. The **Wakeup** button initiates the communication process and the **Hello All** button assigns the device addresses.

Along with establishing communication, the **Initialization** tab provides a method to log detailed communication events. The event and detailed logs can be enabled or

disabled by clicking the checkboxes in the lower-left corner of the GUI.

**Note:** The **FORCEPOR** button commands a soft-reset to all MAX17852 devices in the daisy-chained system.

### General Configuration Tab

The **General Configuration** tab (see [Figure 14](#)) is used for programming settling times for **AUXTIME**, **CELLDLY** and **SWDLY**. The FlexPack feature enable and programming is easily controlled through drop-down menus in the **General Configuration** tab. Parameters such as **TOPCELL** and **TOPBLOCK**, required for FlexPack programming, can be directly entered.

Information on each of the parameters on the **General Configuration** tab is available in the MAX17852 IC data sheet.

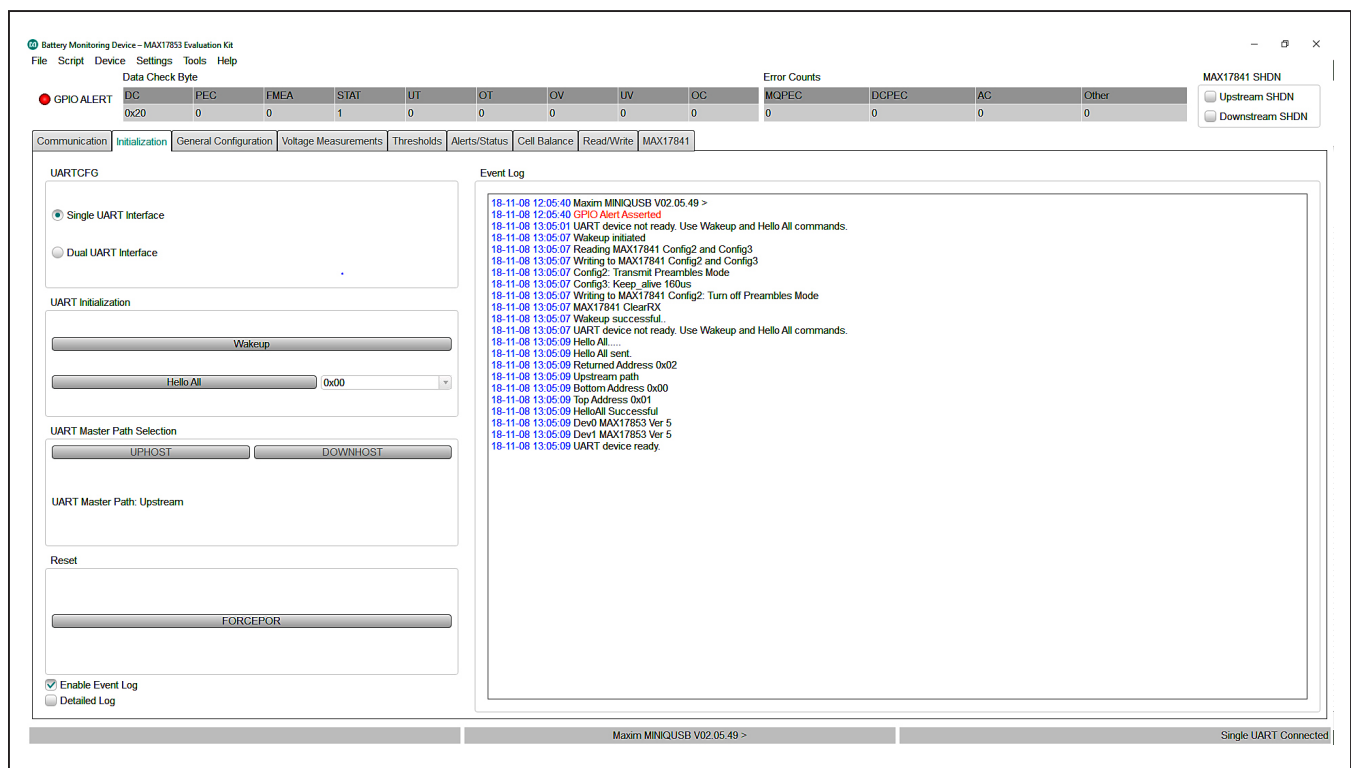

Figure 13. Initialization Tab

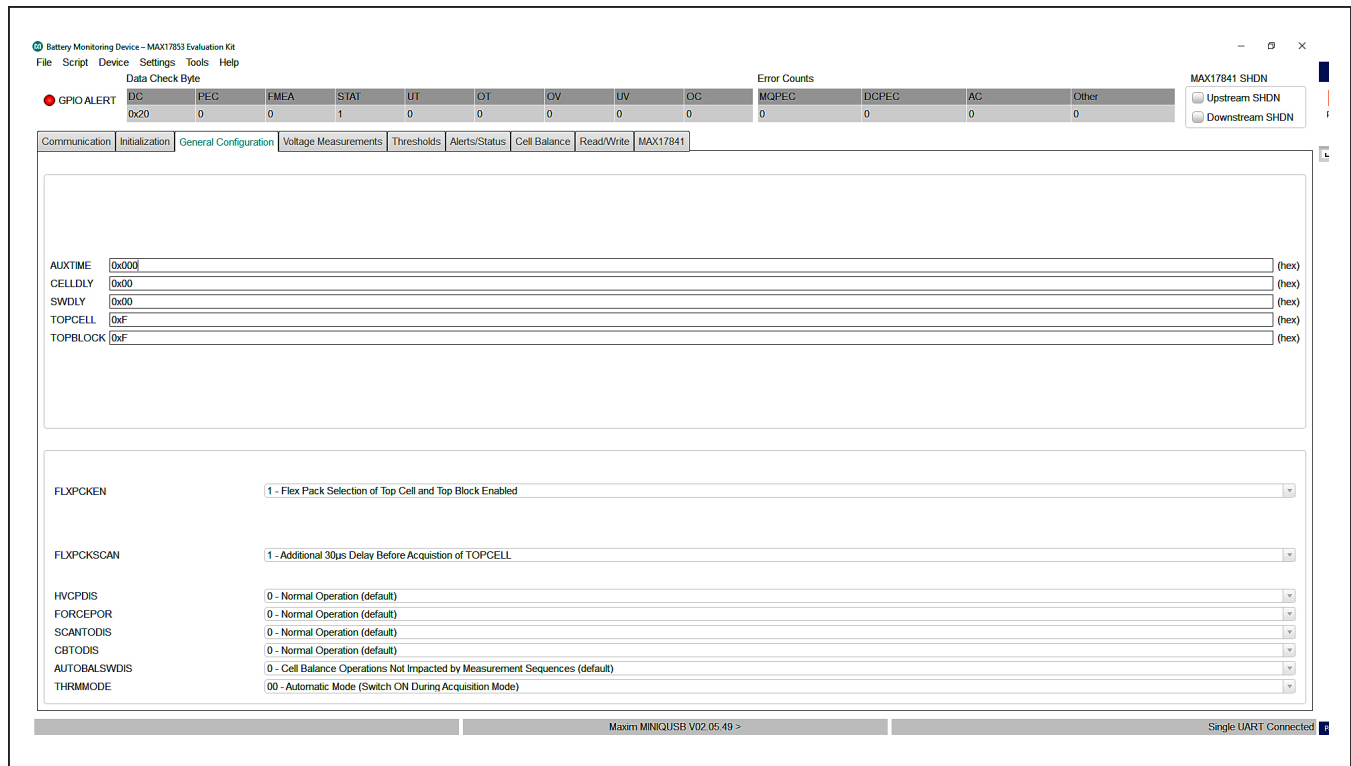

Figure 14. General Configuration Tab

### Voltage Measurements Tab

The **Voltage Measurements** tab (see [Figure 15](#)) is the user interface for visually monitoring all cell measurement and AUX conversion values in the battery monitoring system. In addition, the **Voltage Measurements** tab can be constructed to display a visual indication of cell ADC OV/UV, comparator OV/UV, and communication alerts.

In the **Voltage Measurements** tab, the **Scan Settings** and **Diag Settings** buttons in the **Settings** group box on the right side of the GUI open into individual settings panels (see [Figure 16](#) and [Figure 17](#)).

The lower right-hand corner in the **Voltage Measurements** tab displays a legend that indicates visually the state of each voltage measurement and comparator alert. For the visual alert to be active, the thresholds must be set and enabled in the **Thresholds** tab ([Figure 18](#)).

In the **Scan Settings** panel, the user can set monitoring and control properties for Cell and AUX inputs, in addition to ADC oversample setting/frequency and ADC scan mode.

**Note:** The user must click the **Confirm Settings** button at the bottom of the panel for the selections to take effect. Selections made in the **Scan Settings** panel are applied to each MAX17852 device in the system.

For cell voltages to be displayed on the **Voltage Measurements** tab, simply enable the cells to be monitored on the **Scan Settings** panel and press the **Confirm Settings** button. Pressing the **Confirm Settings** button closes the **Scan Settings** panel and places the user back in the **Voltage Measurements** tab. To have the MAX17852 perform the scan settings operation, select the **Scan Type** from the drop-down list and the number of scans to be performed (**Single Scan**, **N Scans**, or **Scan Continuously**).

The **IIR Filter** settings are also located in the **Voltage Measurements** tab and are enabled by selecting the **IIR Filter Enable** checkbox. The user selects the desired filter from the **Coefficient Selection** drop-down list. The smaller the coefficient is, the more it improves noise rejection at a cost of increased settling time. Pressing the **RDFILT** checkbox commands the GUI to read the IIR filter output.

The **Diag Settings** button in the **Voltage Measurements** tab gives the user control of diagnostic current sources and diagnostic terminations within the MAX17852 device. The user can update diagnostic control for one device or for all devices in the system.

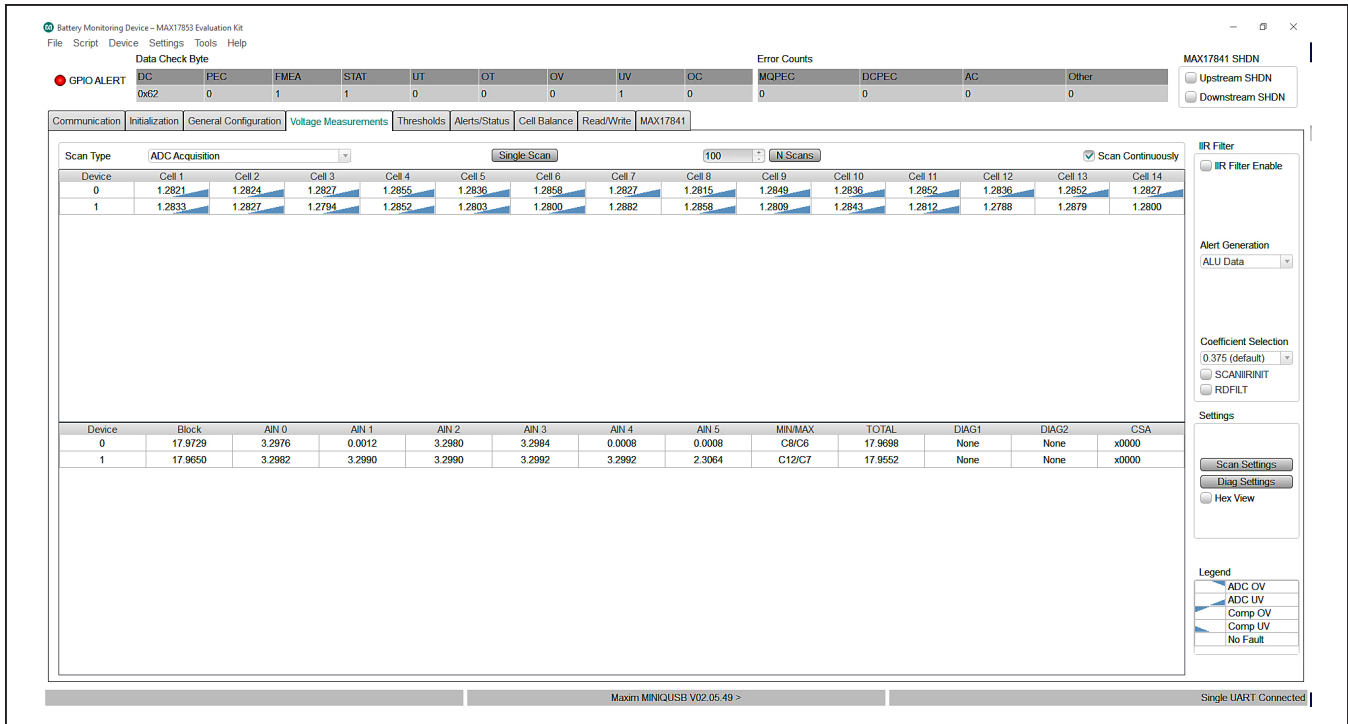

Figure 15. Voltage Measurements Tab

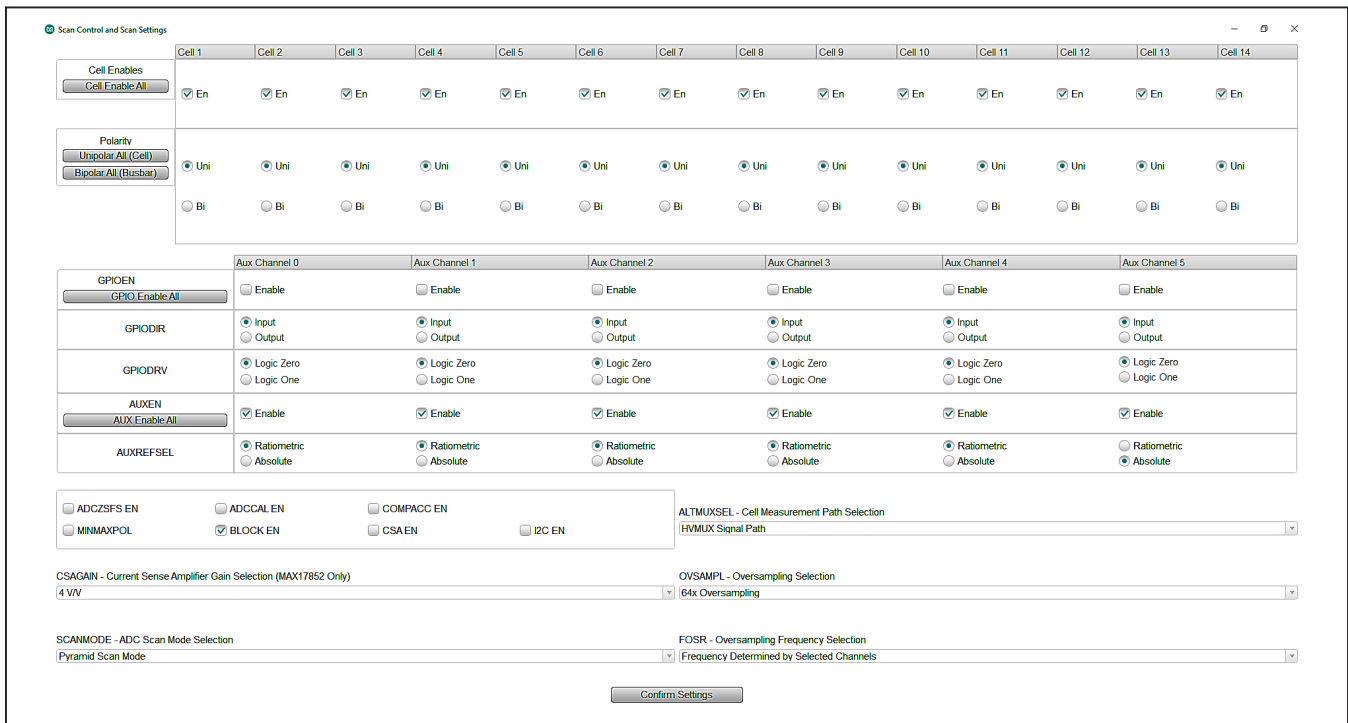

Figure 16. Scan Settings Panel

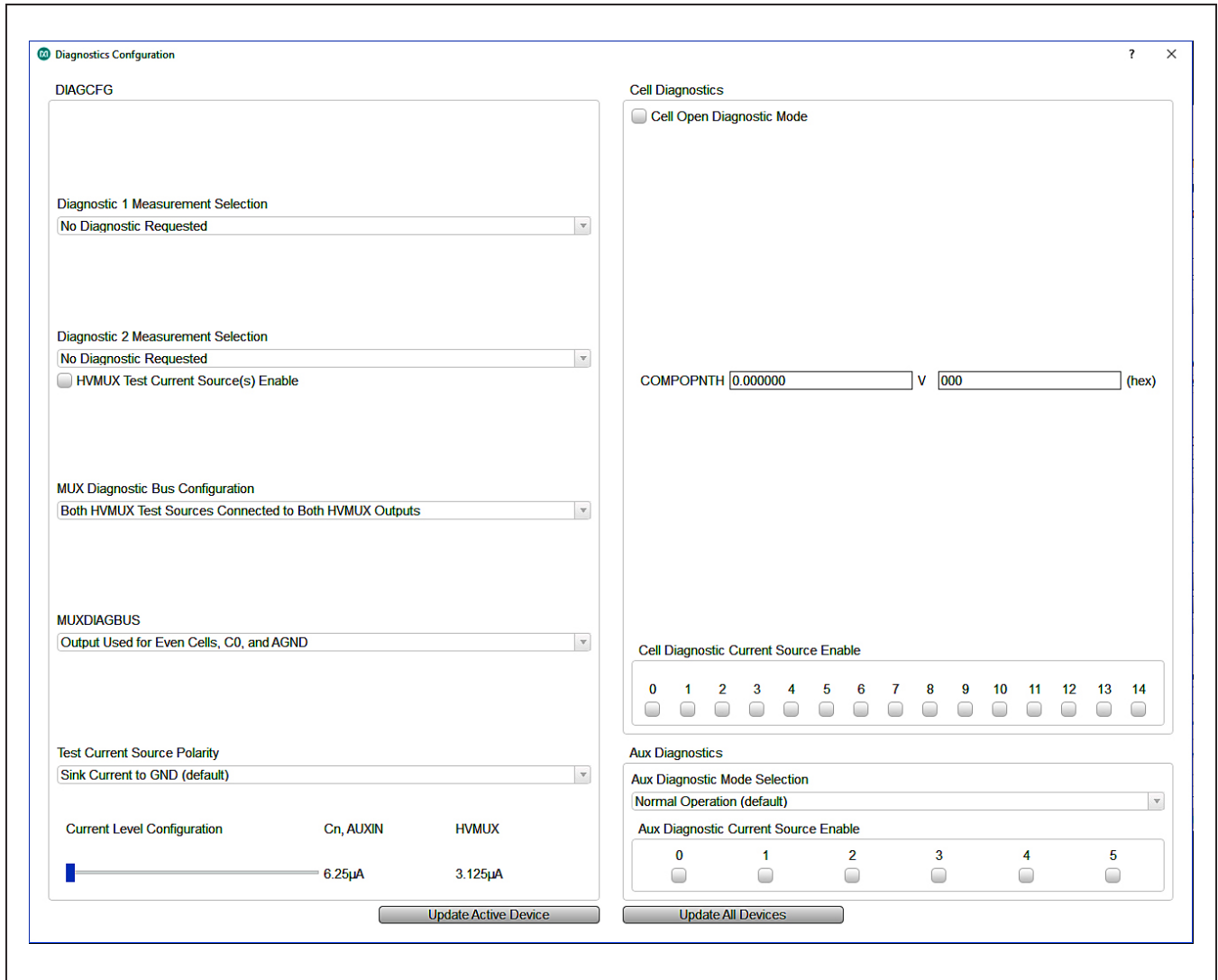

Figure 17. Diagnostic Settings Panel



### Thresholds Tab

Clicking on the **Thresholds** tab (see [Figure 18](#)) opens the panel where users can enter OV/UV and fault thresholds in hex value or voltage (see [Figure 19](#)).

Clicking the **Alert Enables** button in the top-right corner of the **Thresholds** tab opens the **Alert Enable** panel (see [Figure 19](#)).

### Alerts/Status Tab

By selecting the **Active Device** from the drop-down list, the **Alerts/Status** tab (see [Figure 20](#)) displays the fault status of the MAX17852 in the system.

The user can use the **Clear Active Device Alerts** or the **Clear All Device Alerts** to clear the faults logged in the system. Above the cockpit tabs, the GUI shows the **Data Check Byte** faults and **Error Counts**. Resetting the error count is done through the **Device** drop-down at the top left of the GUI. Click Device and select **Reset Error Counts**.

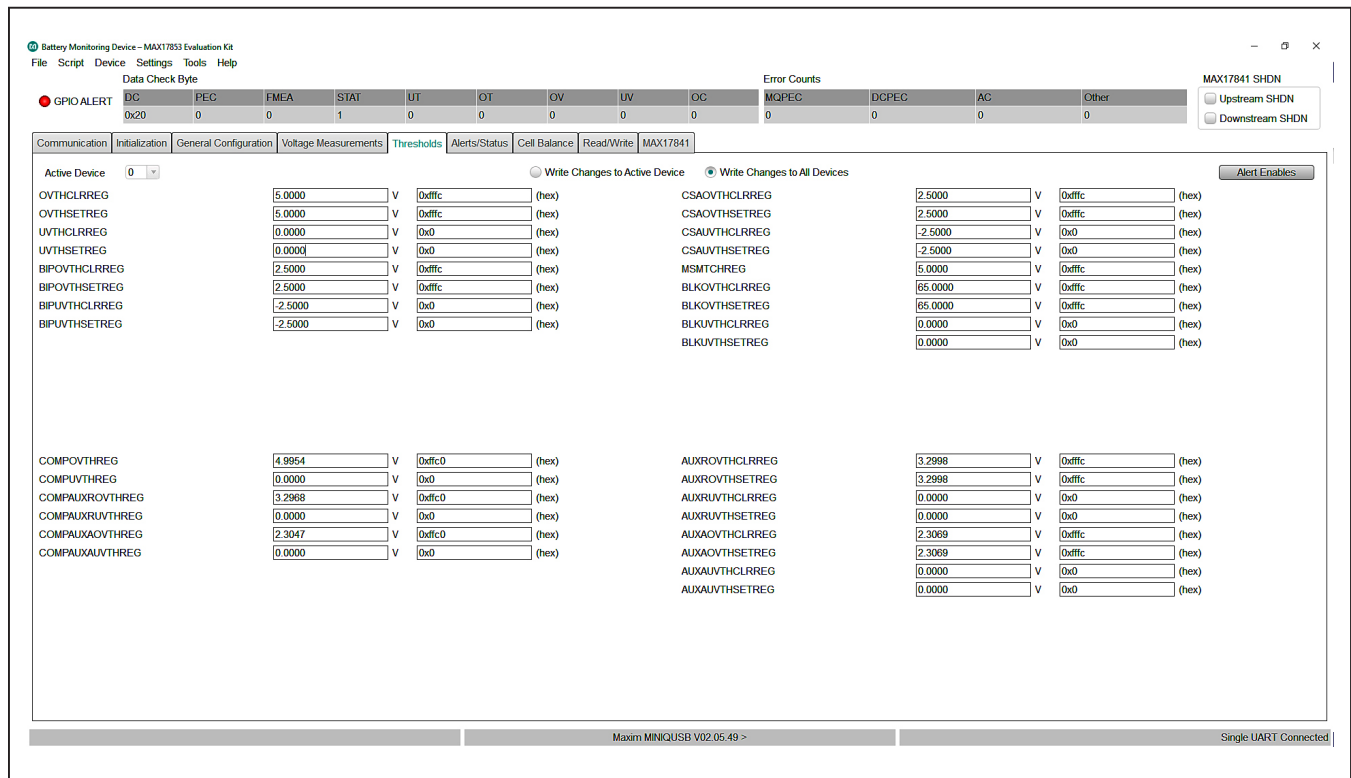

Figure 18. Thresholds Tab

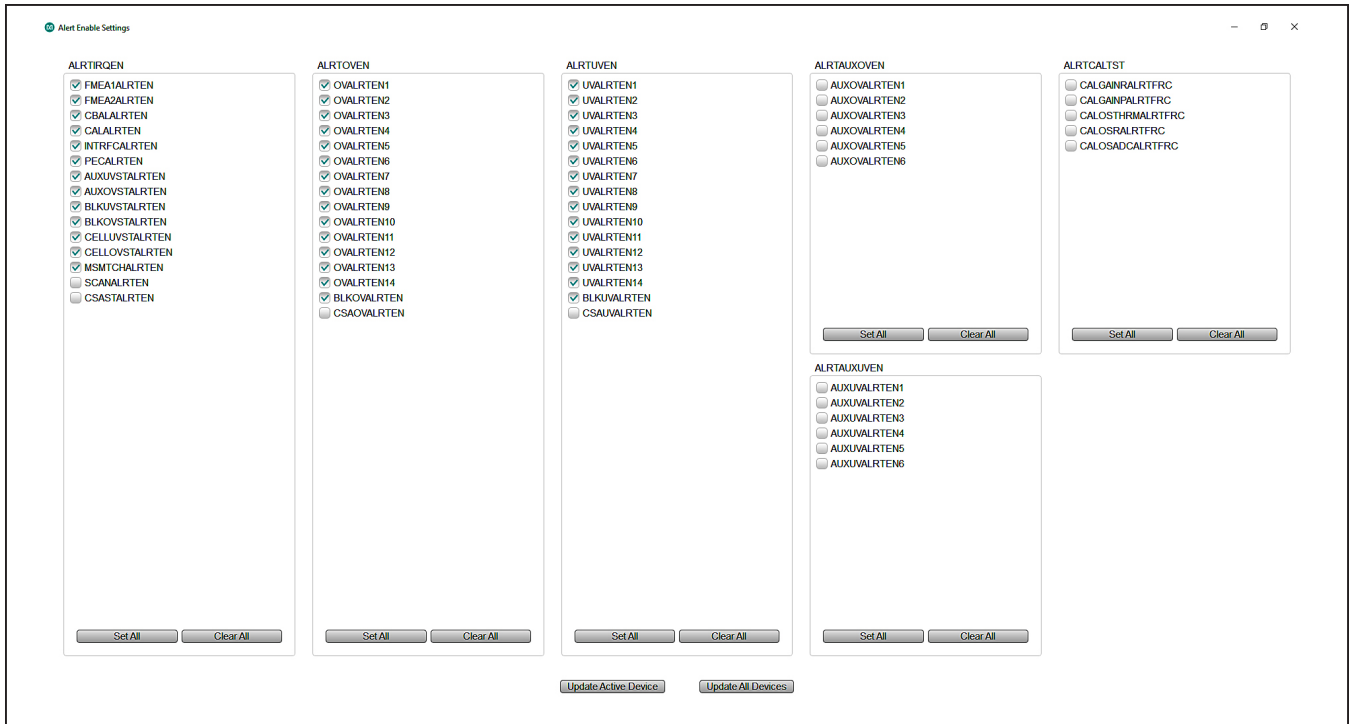

Figure 19. Alert Enable Panel

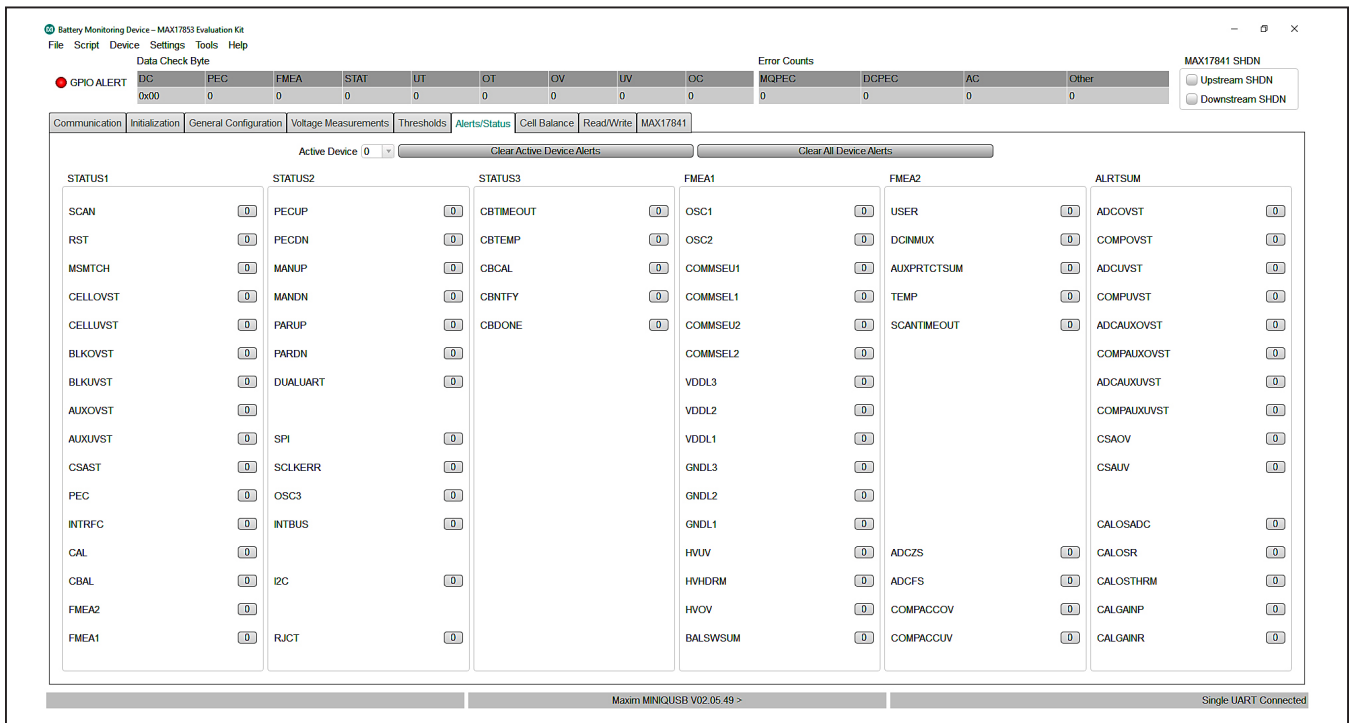

Figure 20. Alerts/Status Tab

### Cell Balance Tab

The **Cell Balance** tab (see [Figure 21](#)) gives the user the flexibility for manual and automatic control of the MAX17852 cell-balance feature. The **Device Selection** drop-down list programs the balancing settings to one or more devices in the system. The **Balance Switch Control** group box includes a drop-down list for the desired operational balance mode. **Note:** To update parameters in the **Cell Balance** tab, select **Cell Balancing Disabled** from the **Mode** drop-down list prior to selecting the desired balancing mode.

To activate a cell-balance switch, use the **Balance Switch Enable** group box to enable the desired balance switch and set the **Balancing Expiration Time #1** to the number of seconds or minutes to perform the balance. In the **Alerts/Status** tab ([Figure 20](#)), be sure to click the **Clear All Device Alerts** button (the interface-specific error alert (INTRFC) must be clear). Next, select **Manual Cell Balancing by Second** from the **Mode** drop-down

list in the **Balance Switch Control** group box, and the cell balance immediately becomes active and the timer is started. Manual mode allows the user total control over the cell-balance switches. **Caution:** Prevent accidental activation of adjacent cell-balance switches or the activation of all cell-balance switches when using **Manual Cell Balancing Mode**.

**Note:** In **Manual Cell Balancing by Second** or **Minute**, only the Cell 1 timer is recognized by the system, with all switches deactivated when the Cell 1 timer expires.

For **Automatic Balance** modes, the user can enable all balance switches and allow the MAX17852 to control the activation according to the user-set parameters. From the **Cell Balance** tab ([Figure 21](#)), in **Automatic** mode, the user can set the cell-balance **Duty Cycle** using the slider and other key parameters like **UV Threshold** and **Balance Switch Diagnostic Thresholds**. The **Cell Balance** tab also includes **Balance Switch Fault Alert** and **CBUVTHR Check Status** indicators.

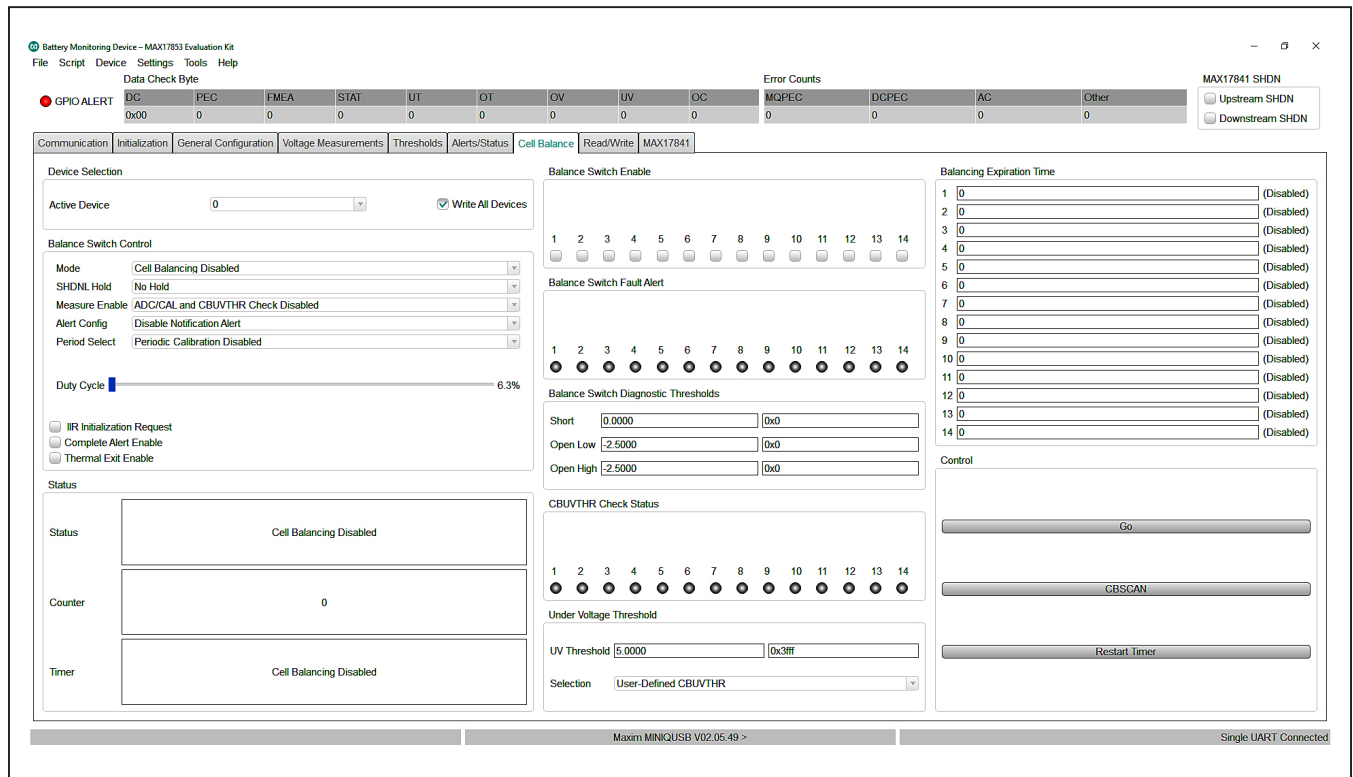

Figure 21. Cell Balance Tab

### Read/Write Tab

The **Read/Write** tab (Figure 22) provides direct access to the read and write registers of the MAX17852. In the **Read/Write** tab, the GUI offers several read/write options to the user. The **Select Register** group box allows the user to read register contents by highlighting the desired register and clicking the **Read All** button. For example, if the user wants to read the unique ID assigned to each device, scroll down the list and highlight the ID1 (0x8C) register and click the **Read All** button, then highlight the ID2 (0x8D) register and click the **Read All** button. The contents of the registers are then displayed in the **Read Output** group box.

Blocks of data in packets of  $\leq 28$  registers can be requested through the **Read Block** group box. Enter the **Start Address** and set the **Block Size**, then click the **Read Block** button. The **Read All** group box, **Write All** group box provide alternative methods to write to specific registers in specific addressed devices.

### MAX17841 Tab

The MAX17841B registers can be directly modified using the **MAX17841 Register Map** sub-tab (see Figure 23). A pull-down arrow to the left of the address number allows the user to identify register content. As an example, Figure 23 shows register 0x11 content and has the **Keep-Alive [3:0]** highlighted. To alter the keep-alive timing, the user must type the desired hex value of the period directly in the **Update Field** edit box and then click the **Set** button on the right. Selecting a parameter in a register automatically highlights the bit values of the parameter and provides a description of the parameter in the **Field Description** group box.

Similarly, the **SPI Commander** sub-tab shown in Figure 24 can be used to send SPI commands to the MAX17841B in an SPI-controlled system.

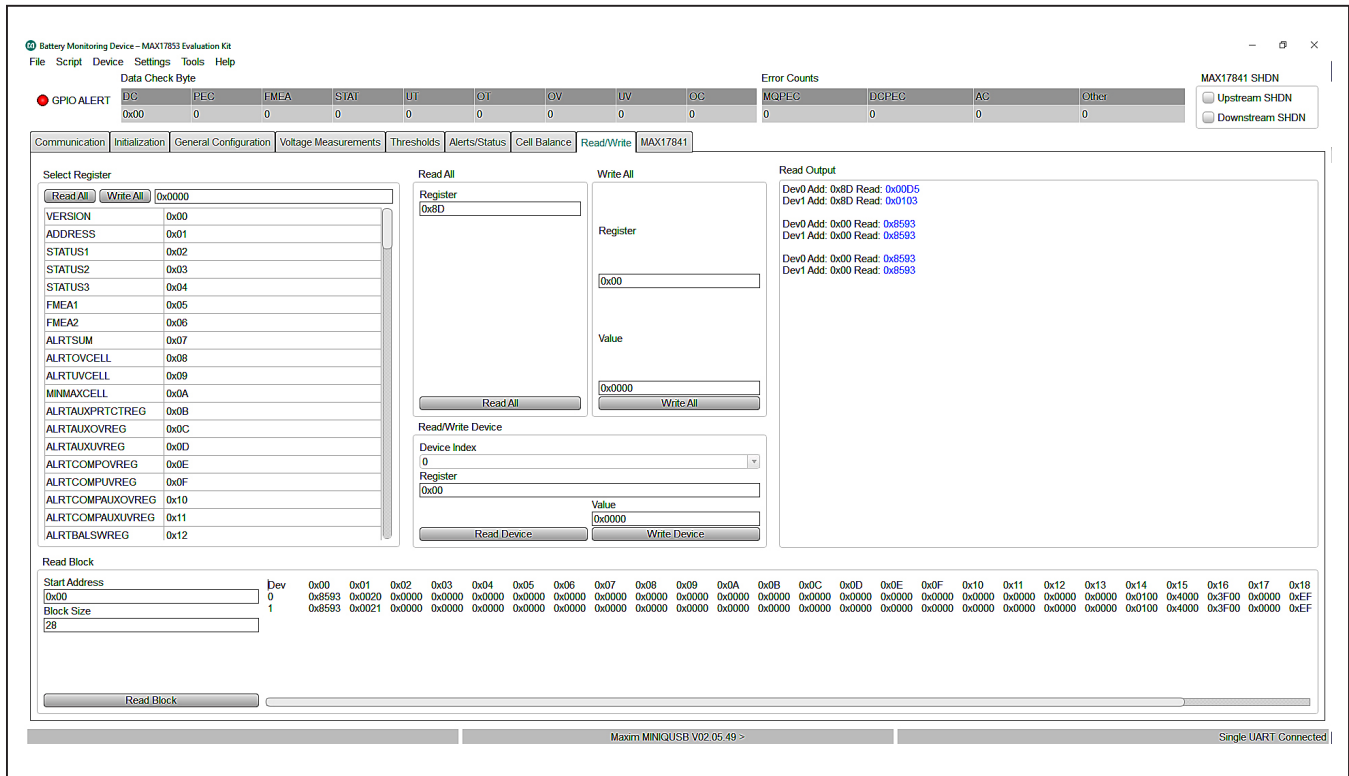

Figure 22. Read/Write Tab

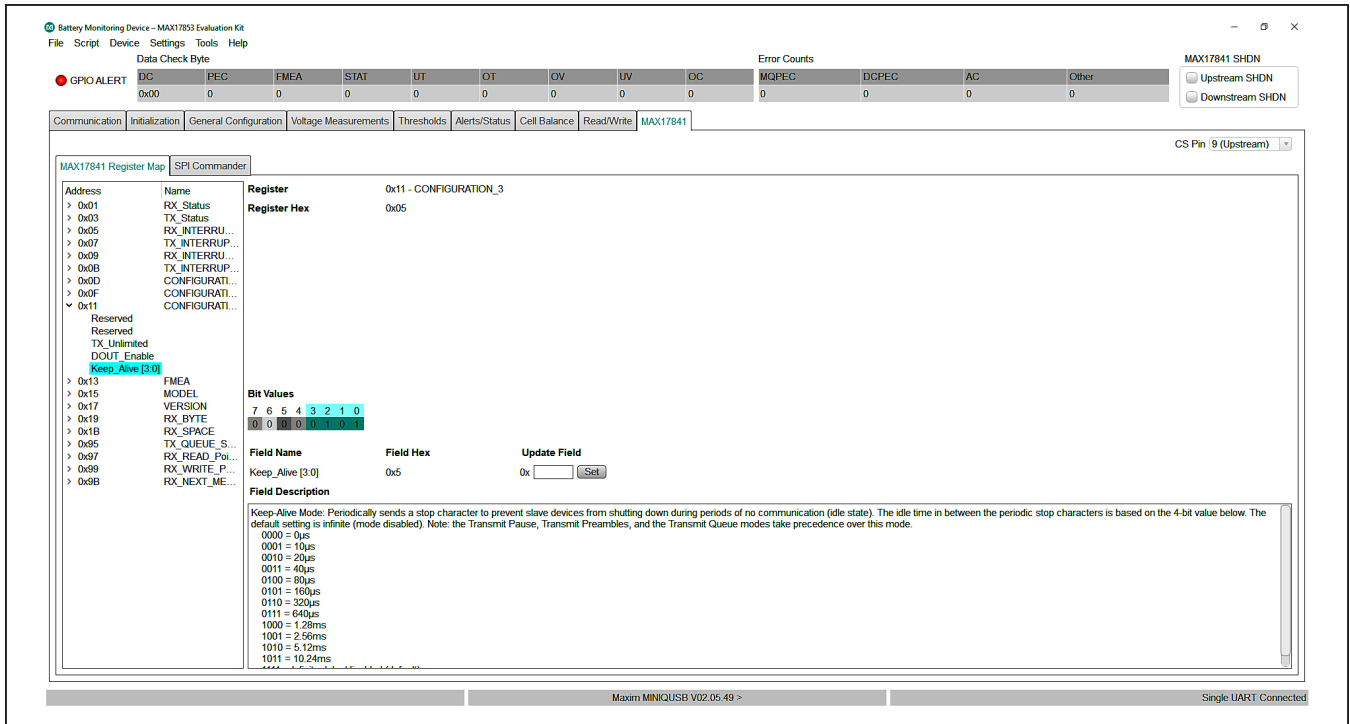

Figure 23. MAX17841 Tab (Register Map Panel)

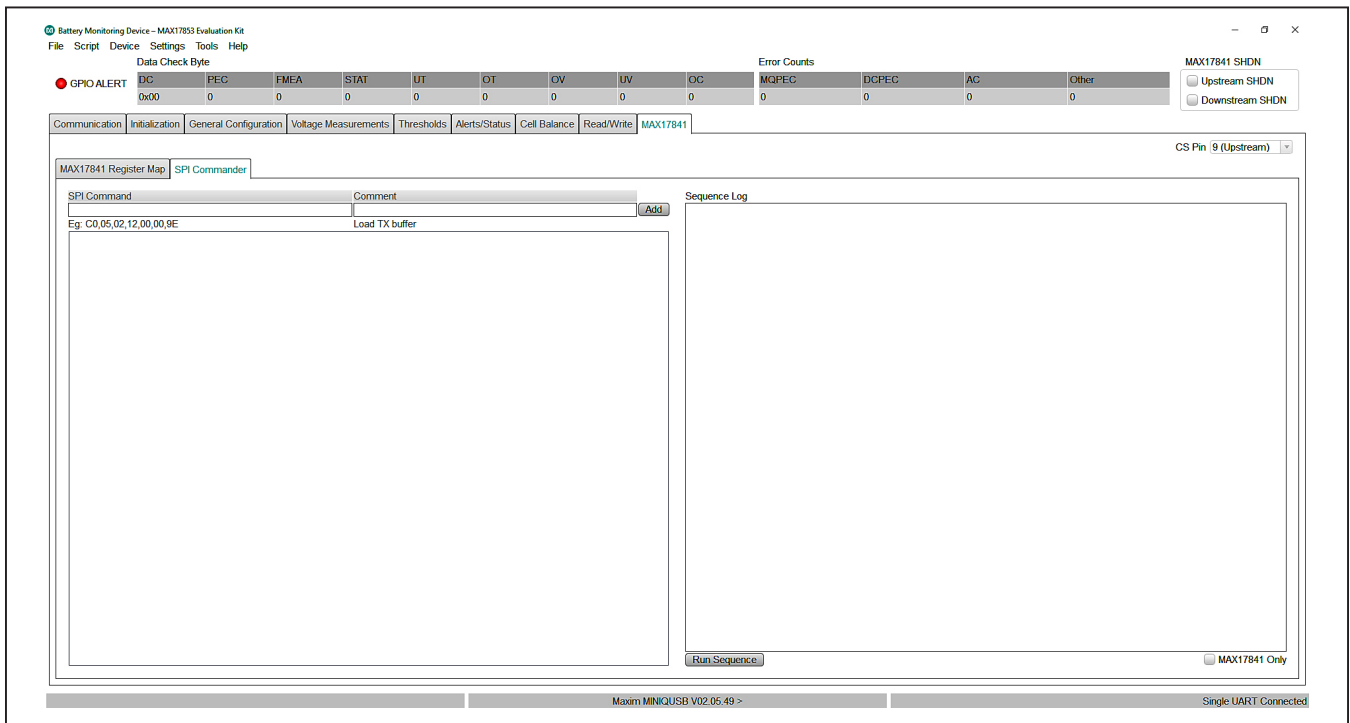

Figure 24. MAX17841 Tab (SPI Commander Panel)

### GUI File Options

The **File** menu drop-down list on the GUI (see [Figure 25](#)) offers powerful tools such as **Log Scan Data**, **Save Register Configuration**, **Load Register Configuration**, as well as **Restart** and **Exit**.

### Log Scan Data

For collecting conversion data for later analysis, select **Log Scan Data** from the **File** menu drop-down list.

The **Log Scan Data** window pops up and requests the **Number of ADC Scans to Log** and the **File Path and Root Name** of the location where the data should be stored. Conversion data is taken according to user-set parameters like **Oversample** settings and **IIR Filter Enable**.

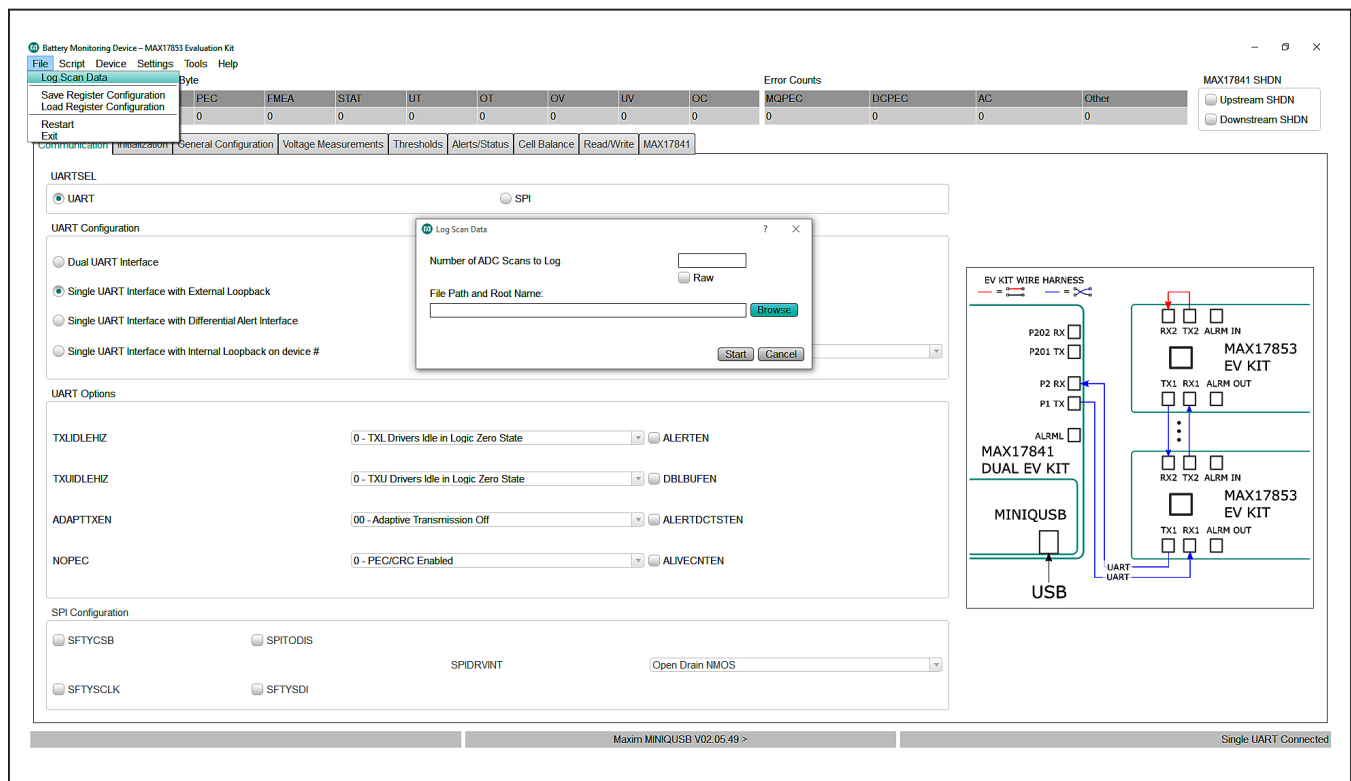

Figure 25. Log Scan Data

## Device Register Configuration Files

During evaluation, the user may want to save the device register content for later use. Saving device register content is performed by selecting **Save Register Configuration** from the **File** menu drop-down list, as shown in [Figure 25](#). The register file is saved in standard .csv format. Registers can be loaded from a saved register file by selecting the **Load Register Configuration** option from the list and selecting the previously saved register.csv file.

## Scripting

A script file can be used to set up the GUI and device to operate in specific modes, or to evaluate a sequence of commands for device functionality. Commands for writing scripts can be found in the **Command Reference** menu item under the **Help** menu bar drop-down list. Detailed information on the Register Map is available in the MAX17852 IC data sheet.

Before running scripts, follow the [Quick Start \(Single UART\)](#) section. **HelloAll Successful** and **UART device ready** response must be displayed in the **Event Log** on the **Initialization** tab ([Figure 13](#)). Set the PCB resistor ladder DIP switches (SW1, SW2) to the ON position (closed). Verify P+B14 and B0P- jumpers are installed. Select the **Voltage Measurements** tab ([Figure 15](#)) and click on the **Scan Settings** button in the **Settings** group box to open the **Scan Settings** panel ([Figure 16](#)). Select **Cell Enable All** and click **Confirm Settings** at the bottom of the panel. Back in the **Voltage Measurements** tab, click on the **Scan Continuously** checkbox. [Figure 26](#) shows a sample script that programs the cell overvoltage to 1.099V and the undervoltage to 0.9V.

To run a script, select **Run Script** from the **Script** menu drop-down list. The **Open Script** window pops up and requests the location where the Script file is stored. After the script is run, the OV/UV is indicated in the updated **Voltage Measurements** tab shown in [Figure 27](#), according to the **Legend** group box in the lower-right corner.

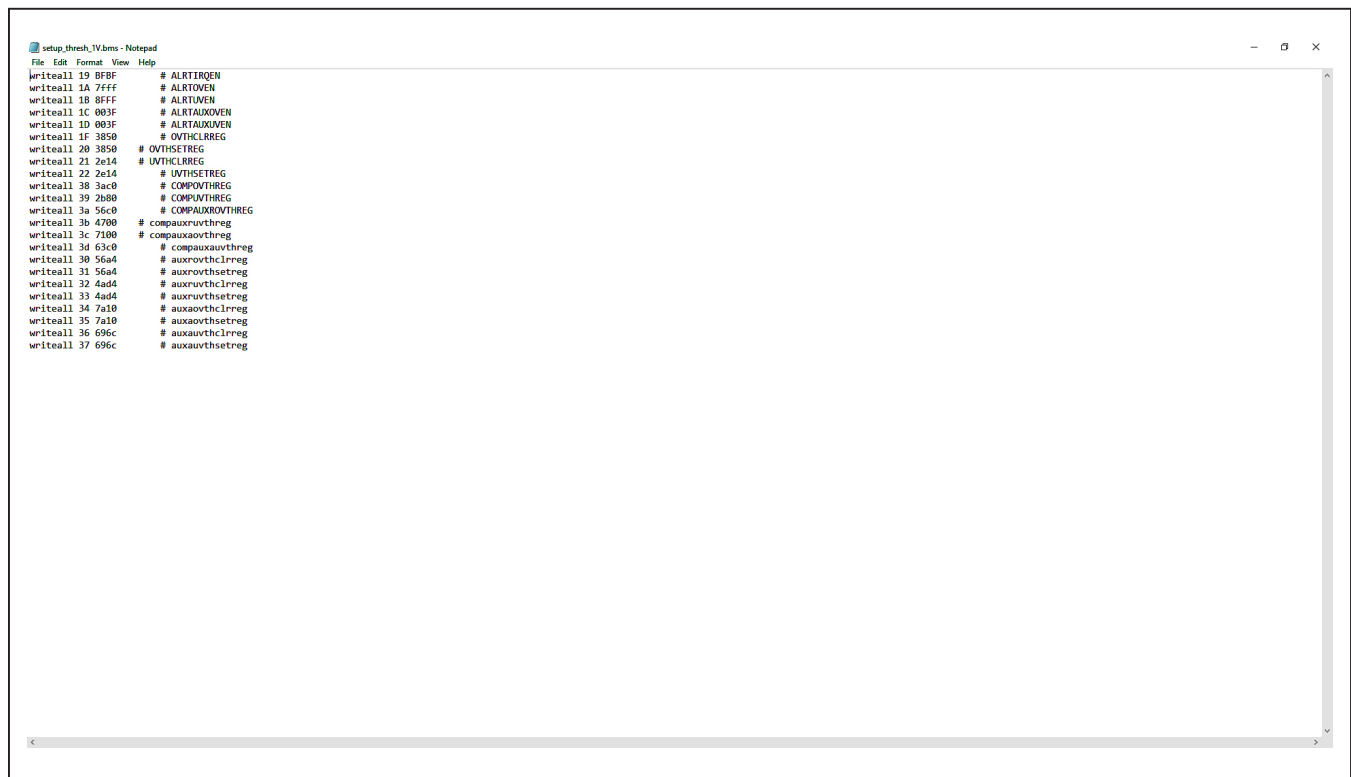

```

setup_thresh_VVbms - Notepad
File Edit Format View Help
writeall 19 BFBF # ALRTI0EN
writeall 1A 7FFF # ALRTI0EN
writeall 1B 8FFF # ALRTI0EN
writeall 1C 003F # ALRTAUX0EN
writeall 1D 003F # ALRTAUX0EN
writeall 1F 3850 # OVTHCLRREG
writeall 20 3850 # OVTHSETREG
writeall 21 2e14 # UVTHCLRREG
writeall 22 2e14 # UVTHSETREG
writeall 38 3ac0 # COMPOVTHREG
writeall 39 2b80 # COMPUNTHREG
writeall 3a 56c0 # COMPAUXOVTHREG
writeall 3b 4700 # compauxuvthreg
writeall 3c 7100 # compauxaovthreg
writeall 3d 63c0 # compauxuvthreg
writeall 3e 56a4 # auxrovthclrreg
writeall 31 56a4 # auxrovthsetreg
writeall 32 4ad4 # auxruvthclrreg
writeall 33 4ad4 # auxruvthsetreg
writeall 34 7a10 # auxaovthclrreg
writeall 35 7a10 # auxaovthsetreg
writeall 36 696c # auxauvthclrreg
writeall 37 696c # auxauvthsetreg

```

Figure 26. OV/UV Sample Script

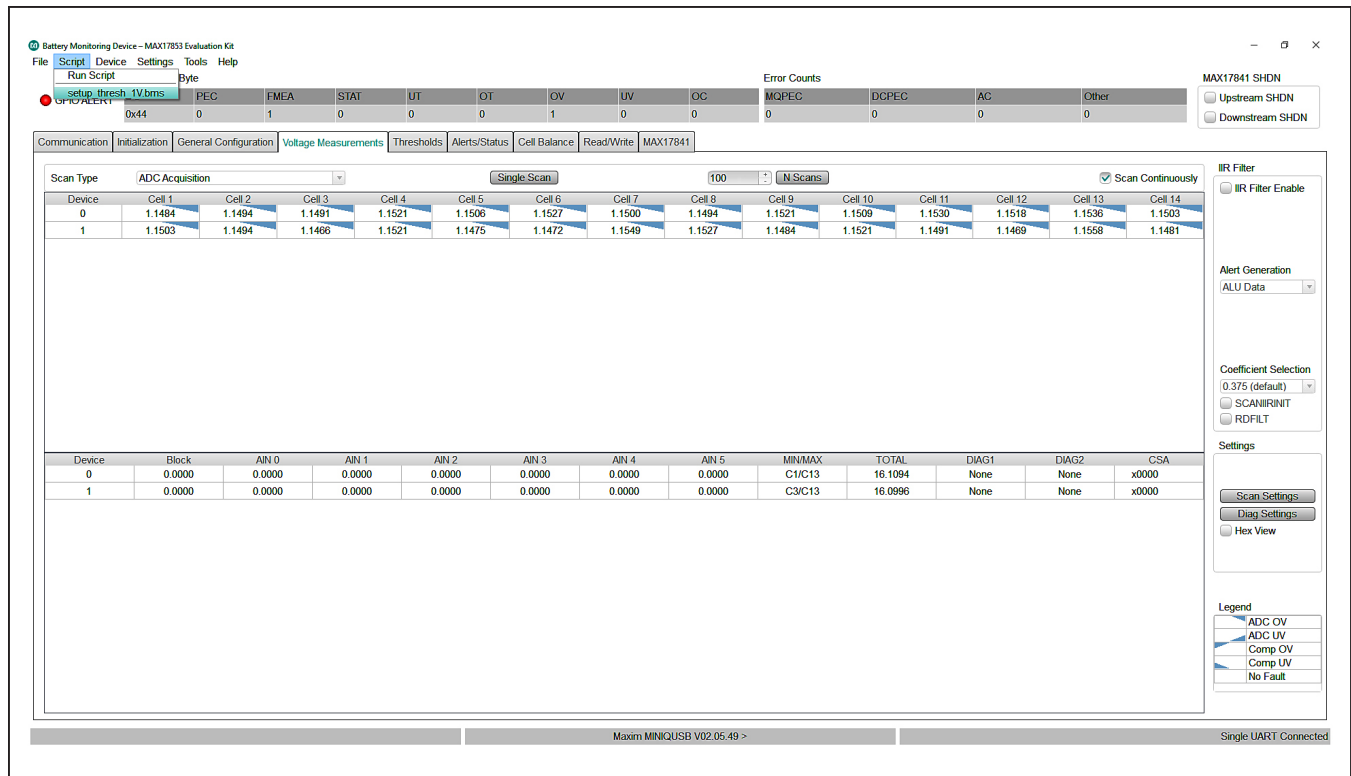

Figure 27. Voltage Measurements Tab (Updated)

### Evaluation Procedures

This section gives the user step-by-step procedures for functional evaluation of the MAX17852 using the software interface GUI.

#### Cell Voltage and Comparator Measurements

The following procedure describes how to use the GUI and EV kit to make **Cell Voltage** measurements and observe measurement and comparator OV/UV alerts in the **Voltage Measurements** tab (Figure 15).

##### Procedure:

- 1) Set up hardware and run GUI according to the [Quick Start \(Single UART\)](#) section. **HelloAll Successful** and **UART device ready** response must be displayed in the **Event Log** on the **Initialization** tab (Figure 13). Be sure to set the supply voltage to 18.0V for this procedure.
- 2) Set the PCB resistor ladder DIP switches (SW1, SW2) to the ON position (closed). Verify that the P+B14 and B0P- jumpers are installed.

- 3) Select the **Voltage Measurements** tab (Figure 15) and click on the **Scan Settings** button in the **Settings** group box to open the **Scan Settings** panel (Figure 16). First click the **Cell Enable All**, **Unipolar All (Cell)**, **BLOCK EN** checkboxes, and select **64x OVSAMPL** from the OVSAMPL a drop-down list at the bottom of the panel, and then click the **Confirm Settings** button.
- 4) Select the **Voltage Measurements** tab (Figure 15) and in the upper left corner, set the **Scan Type** to **ADC and Comparator Acquisition**, and then select the **Scan Continuously** checkbox. Observe that cell voltage levels are approximately equal in value. At this point, the MAX17852 is continuously reading the voltages across each of the 2kΩ resistors in the resistor ladder. Increasing the power-supply voltage increases the voltage across each of the 2kΩ resistors in the ladder.
- 5) Select the **Thresholds** tab (Figure 18) and set the comparator and cell voltage threshold. Set **OVTHSETREG** to 1.41V, **UVTHSETREG** to 1.2V, **COMPOVTHREG** to 1.5V, and **COMPUVTHREG** to 1.1V (threshold values automatically adjust to the closest hex value).



- 6) In the **Thresholds** tab, click the **Write Changes to All Devices** radio button, and then open the Alert Enables panel (Figure 19) by clicking the **Alert Enables** button. Click the **Set All** button for **ALRTOVEN** and **ALRTUVEN** to command the MAX17852 to check the OV/UV condition. In the **Alert Enables** panel, the user can mask OV/UV faults. The user can also mask faults from generating an alert output activation by unchecking the appropriate checkboxes in the **ALRTIRQEN** group box. Finally, click the **Update All Devices** button at the bottom and close the panel.
- 7) Select the **Voltage Measurements** tab (Figure 15). Verify that voltage measurements are approximately 1.28V and no OV/UV voltage measurements or OV/UV comparator measurements are indicated. Slowly increase the power-supply voltage from 18.0V to 22.0V. Verify that OV voltage and comparator measurements are detected at the user-programmed OV thresholds by comparing the triangular indicator with the **Legend** on the lower right side of the window. The UV voltage and comparator measurements can be verified similarly by decreasing the supply voltage from 18.0V to 14.0V.

In addition to the oversampling filter, the MAX17852 has implemented an IIR noise filter to further reduce noise in the conversion result. Take the following steps in the GUI to become familiar with the IIR filter:

- 1) From the **Voltage Measurements** tab (Figure 15), in the **IIR Filter** group box, click on the **IIR Filter Enable** checkbox.
- 2) Select the desired filter from the **Coefficient Selection** drop-down list (0.125 for maximum filter effect).
- 3) To see the dynamic effect of the IIR filter, set the **OVSAMPL** drop-down list in the **Scan Settings** panel (Figure 16) to **Single Acquisition**, and click the **Confirm Settings** button.
- 4) Back in the **Voltage Measurements** tab, in the **IIR Filter** group box, click the **RDFILT** checkbox in the **Coefficient Selection** group box to command the GUI to read the IIR filter output. Notice numerically the noise reduction in voltage readings.

### Auxiliary General-Purpose Input/Output Port

The following procedure demonstrates the use of the auxiliary (AUX) channels as a general-purpose input/output (GPIO) port.

#### Procedure:

- 1) Set up hardware and run GUI according to the [Quick Start \(Single UART\)](#) section. **HelloAll Successful** and **UART device ready** response must be displayed in the **Event Log** on the **Initialization** tab (Figure 13).
- 2) Set the PCB resistor ladder DIP switches (SW1, SW2) to the ON position (closed). Verify that P+B14 and B0P- jumpers are installed.
- 3) Select the **Voltage Measurements** tab (Figure 13) and click on the **Scan Settings** button in the **Settings** group box to open the **Scan Settings** panel (Figure 16). Click the **GPIO Enable All** button and set the **GPIODIR** to Output. Set the **GPIODRV** to the desired high or low level.
- 4) Click the **Confirm Settings** button at the bottom of the panel and then verify with an oscilloscope that the digital voltage is present at the GP/AUXn test pin on the PCB.
- 5) To command the GPIO as an input, on the **Scan Settings** panel, click the **GPIO Enable All** button and set the **GPIODIR** as Input.
- 6) The EV kit contains a 10kΩ pullup resistor on each of the GP/AUXn pins. To pull up each of the GP/AUXn pins, select the **Read/Write** tab (Figure 22). Using the **Read All** group box, read register 0x62. Set THRM-MODE bit 9 and bit 10 (e.g., if register 0x62 is 0x0000, use the **Write All** box and send 0x0600). Setting the THRM-MODE bit activates the THRM pin on the device (pin no. 29). The EV kit terminates THRM to the 10kΩ pullup resistors.
- 7) Populate the THERMx jumpers in the CSA/AUX INPUT/OUTPUT/ADC I<sup>2</sup>C block on the PCB (see Figure 4) and verify the logical state of the **GP/AUX0–GP/AUX3** pins on the MAX17852 by reading register GPIOCFG (0x17). Verify the GPIORD bits are set to logic 1.

#### AUX Absolute/Ratiometric Measurement

The software GUI and the MAX17852 EV kit are developed with features that allow the user to evaluate the performance of the AUX channels when configured as analog absolute measurements or analog ratiometric measurements. The following procedure shows how to configure the AUXIN0–AUXIN3 pins on the MAX17852 for analog measurement.

**Key Points to Consider:**

- AUX GPIO can be used in mixed-mode applications
- Each port can be independently configured for GPIO, AUX ratiometric, or AUX absolute measurement

**Procedure:**

- 1) Set up hardware and run GUI according to the [Quick Start \(Single UART\)](#) section. **HelloAll Successful** and **UART device ready** response must be displayed in the **Event Log** on the **Initialization** tab ([Figure 13](#)).
- 2) Set the PCB resistor ladder DIP switches (SW1, SW2) to the ON position (closed). Verify that P+B14 and B0P- jumpers are installed.
- 3) Select the **Voltage Measurements** tab ([Figure 15](#)) and click on the **Scan Settings** button in the **Settings** group box to open the **Scan Settings** panel ([Figure 16](#)). Click the **AUX Enable All** button to enable the AUX channels as analog. Set the **AUXREFSEL** to **Absolute** when absolute measurements are desired or set to **Ratiometric** when ratiometric measurements are to be evaluated. Temperature measurements using NTC are generally ratiometric for improved temperature accuracy.
- 4) Other conversion characteristics available to the user in the **Scan Settings** panel are **OVSAMPL**, **FOSR**, **SCANMODE** and **BLOCK EN**. From the **OVSAMPL** drop-down list, select **64x Oversampling**. Click **Confirm Settings** at the bottom of the window.
- 5) From the hardware perspective, it is necessary to verify the THRM switch is active during conversion (bits 9 and 10 of register 0x62). Setting the THRMODE bit to **Automatic** activates the THRM switch only during conversion. In **Manual On** mode, the THRM switch is always active. With the filter on, the MAX17852 EV kit AUXIN0–AUXIN3 pins, **Manual** mode is recommended. With the THRM output active,  $V_{AA}$  reference is applied to each AUXn 10k $\Omega$  pullup resistor. Verify that PCB THERMn jumpers are installed.
- 6) Back on the **Voltage Measurements** tab, click the **Scan Continuously** checkbox. Observe from the **GP/AUX0–GP/AUX3** test points on the MAX17852 ([Figure 4](#)) that AUX levels are approximately 3.3V in value. Terminate a 10k $\Omega$  NTC thermistor to each of the GPIO\_AUXn connectors and the conversion values update accordingly.

**Cell Balancing****Manual Cell Balancing with CBTIMER Shutoff**

This procedure details a simple process for using the GUI to set up and run manual cell balancing with shutoff from the programmable CBTIMER register.

**Key Points to Consider:**

- User must set mode to **Disable Cell Balancing** prior to updating cell-balance parameters.
- In manual mode, the user can enable and disable balance switches at any time before the timer expires.
- **AUTOBALSWDIS** affects cell-balance switch behavior in manual cell-balancing modes only.
- In manual cell-balancing mode, the user should avoid activation of adjacent cell-balance switches or activation of all switches at the same time.
- **Duty Cycle** sidebar is not functional in manual cell-balancing mode.

**Procedure:**

- 1) Set up hardware and run GUI according to the [Quick Start \(Single UART\)](#) section. **HelloAll Successful** and **UART device ready** response must be displayed in the **Event Log** on the **Initialization** tab ([Figure 13](#)).
- 2) Set the PCB resistor ladder DIP switches (SW1, SW2) to the ON position (closed). Verify that P+B14 and B0P- jumpers are installed.
- 3) Select the **Voltage Measurements** tab ([Figure 15](#)) and click on the **Scan Settings** button in the **Settings** group box to open the **Scan Settings** panel ([Figure 16](#)). Select **Cell Enable All** and click **Confirm Settings** at the bottom of the panel.
- 4) Back in the **Voltage Measurements** tab, click on the **Scan Continuously** checkbox. Observe that cell voltage levels are approximately equal in value. At this point, the MAX17852 is continuously reading the voltage across each of the 2k $\Omega$  resistors in the resistor ladder. Increasing the power-supply voltage increases the voltage across each of the 2k $\Omega$  resistors in the ladder.
- 5) Select the **Alerts/Status** tab ([Figure 20](#)) and click the **Clear All Device Alerts** button. The INTRFC alert is set when the user tries to make changes to the **Balancing Expiration Time** when a timer is established for a cell-balance mode or other command faults. The user must select **Cell Balancing Disabled** in the **Balance Switch Control** group box ([Figure 21](#)) to update the **Balancing Expiration Time**.

- 6) Select the **Cell Balance** tab (Figure 21) and enable odd balance switches by clicking the checkboxes in the **Balance Switch Enable** group box.
- 7) Set the **Balancing Expiration Time** in row 1 to the desired timer value (e.g., 100 or a value up to 1023).
- 8) In the **Balance Switch Control** group box, select **Manual Cell Balancing by Second** from the **Mode** drop-down list. Observe in the lower left corner of the **Cell Balance** tab that the **Counter** box increments and the **Timer** is activated.
- 9) Select the **Voltage Measurements** tab again and observe the change in resistor stack cell voltage due to the activation of the odd-cell balance switches.
- 10) In the **Cell Balance** tab, select the **Mode** drop-down and click on **Cell Balancing Disabled** to disable manual cell balancing.

The same procedure can be used to verify functionality of the even-cell balance switches. In manual cell-balancing mode, the cell-balance switch can be set to automatically disable when a conversion is executed. To enable the automatic cell-balance switch-disable feature, set AUTOBALSWDIS bit 12 in the SCANCTRL register (0x66) to logic 1. When using the auto cell-balance switch-disable feature, set the time delay before the ADC conversion value:

- 1) Use the **Read/Write** tab (Figure 22) to read register 0x66.
- 2) Rewrite the SCANCTRL register (0x66) with bit 12 set.
- 3) Program the BALSWDLY register (0x63) with the necessary **CELLDLY** delay time from when a balance switch opens to when the MAX17852 performs the conversion. Setting the BALSWDLY register to 0x0F0F sets the cell and switch delay to 1.44ms. Alternatively, the parameters can be programmed using the **General Configuration** tab (Figure 14).

Detailed information on manual cell-balancing features is available in the MAX17852 IC data sheet.

### Current Measurement

The following procedure demonstrates the use of the CSAP and CSAN inputs to provide an accurate current measurement. To augment the accuracy performance over multiple measurement cycles, the user can enable the embedded IIR filter and Oversampling. The Oversampling and IIR filter provide a means to implement

noise rejection and effectively increase the resolution of each acquisition at a cost of increased settling time. It is a trade-off between response times to changing input values versus the noise attenuation.

#### Procedure:

- 1) Set up hardware and run GUI according to the [Quick Start \(Single UART\)](#) section. **HelloAll Successful** and **UART device ready** response must be displayed in the **Event Log** on the **Initialization** tab (Figure 13).
- 2) Set the PCB resistor ladder DIP switches (SW1, SW2) to the ON position (closed). Verify that the P+B14 and B0P- jumpers are installed.
- 3) Connect a precision voltage source to the CSAP and CSAN inputs of the MAX17852 EV kit to emulate the voltage across a shunt resistor. Terminate CSAP to the precision voltage source positive output and CSAN to the precision voltage source negative output. Terminate CSAP to the AGND port to allow CSAN to go above or below AGND, depending on the direction of the current flow.
- 4) Select the **Voltage Measurements** tab (Figure 15) and click on the **Scan Settings** button in the **Settings** group box to open the **Scan Settings** panel (Figure 16). Click the **CSA EN** button to enable the current sense amplifier inputs (CSAP, CSAN). Select the **4V/V** Current Sense Amplifier Gain from the **CS-AGAIN – Current Sense Amplifier Gain Selection** drop-down list at the bottom of the panel. Select **64x OVSAMPL** from the OVSAMPL drop-down list. Click the **Confirm Settings** button.
- 5) Back in the **Voltage Measurements** tab (Figure 15), in the IIR Filter group box, click on the **IIR Filter Enable** checkbox.
- 6) Select the desired filter from the **Coefficient Selection** drop-down list (0.125 for maximum filter effect). Click the **RDFILT** checkbox in the **Coefficient Selection** group box to command the GUI to read the IIR filter output.
- 7) From the **Voltage Measurements** tab (Figure 15), set the **Scan Type** to **ADC Acquisition**, and then select the **Scan Continuously** checkbox. Verify that the CSA cell reads x8000 when the precision voltage source connected to CSAP and CSAN is at 0V. Slowly increase the power-supply voltage from a minimum of -300mV to a maximum of +300mV and observe the CSA cell provide voltage measurements from the battery pack.

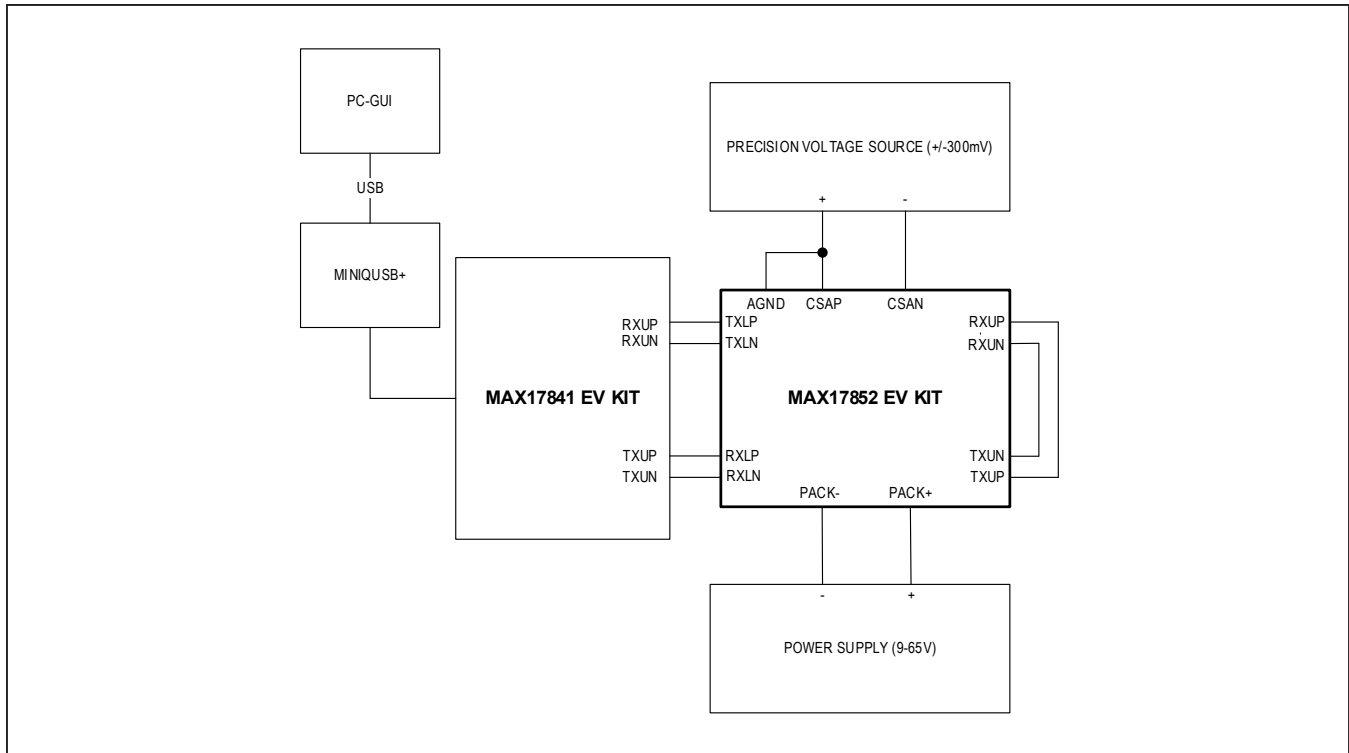

Figure 28. CSA Configuration Diagram

## I<sup>2</sup>C Master

The following procedure demonstrates the use of the auxiliary channels (AUXIN0, AUXIN1) as SDA and SCL for I<sup>2</sup>C interface. Prior to the use, the I<sup>2</sup>C Master must be configured by writing data to the registers described below. Detailed descriptions of the Register Map are available in the MAX17852 IC data sheet.

To evaluate the I<sup>2</sup>C Master interface, the user must make the following hardware changes to the MAX17852 EV kit:

- Populate R26 (0Ω)
- Populate R143 (0Ω)
- Populate R148 (0Ω)
- Do not populate R116 (1kΩ)
- Do not populate R117 (1kΩ)

See the [MAX1785x EV Kit Schematics](#) for further details on the location of the resistors.

### Procedure:

- 1) Set up hardware and run GUI according to the [Quick Start \(Single UART\)](#) section. **HelloAll Successful** and **UART device ready** response must be displayed in the **Event Log** on the **Initialization** tab ([Figure 13](#)).
- 2) Set the PCB resistor ladder DIP switches (SW1, SW2) to the ON position (closed). Verify that the P+B14 and B0P- jumpers are installed.
- 3) Select the **Voltage Measurements** tab ([Figure 15](#)) and click on the **Scan Settings** button in the **Settings** group box to open the **Scan Settings** panel ([Figure 16](#)). Click the **I<sup>2</sup>C EN** button to enable the I<sup>2</sup>C Master pins (SDA, SCL).
- 4) Click the **Confirm Settings** button at the bottom of the panel and then verify with an oscilloscope that SDA and SCL are idle high at the AUXIN0 and AUXIN1 IC pins 21 and 22 on the EV kit.
- 5) Select the **Read/Write** tab ([Figure 22](#)). Using the **Write All** group box, send 0x0000 to register STATUS1 (0x02). This resets the STATUS1 register.
- 6) Using the **Write All** group box, send 0x0004 to register I2CPNTR (0x84). This writes a pointer to address 0x0004.
- 7) Write 0xAA55 to register I2CWDATA1 (0x85). This register stores the upper data bytes for I<sup>2</sup>C Master Write Mode transaction.

- 8) Write 0x9669 to register I2CWDATA2 (0x86). This register stores the lower data bytes for I<sup>2</sup>C Master Write Mode transaction.
- 9) Configure the I<sup>2</sup>C Master mode to a simple write transaction by writing 0x2000 to register I2CCFG (0x89).
- 10) Clear the current status of the I<sup>2</sup>C Master by writing 0x0000 to register I2CSTAT (0x8A).
- 11) Initiate an I<sup>2</sup>C Master transaction by writing 0x78A8 to register I2CSEND (0x8B). User may observe the I<sup>2</sup>C communication with EV kit Flash by probing IC pins 21 and 22 during data transfer.
- 12) Using the **Read All** group box, read register I2C-STAT (0x8A) to access the current status of the I<sup>2</sup>C Master. An output of 0xC000 indicates that the transaction was completed with no errors.

### Automated Cell Balancing with CBUVTHR and CBTIMER (Host Sleep Mode)

This procedure details a simple process for using the GUI to set up and run the Automated Cell Balance with shutoff threshold set by the programmable CBUVTHR register.

#### Key Points to Consider:

- User **must** set Mode in the **Balance Switch Control** group box to **Cell Balancing Disabled** prior to updating the parameters in the **Cell Balance** tab (Figure 21)
- Enable or disable cell-balance parameters in **Auto Cell Balancing** mode triggers an INTRFC alert in the **Alerts/Status** tab (Figure 20)
- User must uncheck the **Scan Continuously** checkbox in the **Cell Measurement** (Figure 15) to prevent an INTRFC alert from being set when **Auto Cell Balancing** mode is activated
- In **Auto Cell Balancing** mode, the IC state machine prevents adjacent cell-balance switches from being activated simultaneously
- The **Duty Cycle** sliderbar is not functional in Manual Cell Balancing
- The UV threshold can be used independently or in conjunction with cell balancing timer(s) (CBEXP1 or CBEXPn)

#### Procedure:

- 1) Set up hardware and run GUI according to the [Quick Start \(Single UART\)](#) section. **HelloAll Successful** and **UART device ready** response must be displayed in the **Event Log** on the **Initialization** tab.
- 2) Set the PCB resistor ladder DIP switches (SW1, SW2) to the ON position (closed). Verify P+B14 and B0P- jumpers are installed.
- 3) Select the **Voltage Measurements** tab (Figure 15) and click on the **Scan Settings** button in the **Settings** group box to open the **Scan Settings** panel (Figure 16). Select **Cell Enable All** and **Unipolar All (Cell)**. Select 32x Oversampling from the **OVSAMPL** drop down then click **Confirm Settings** at the bottom of the window.
- 4) In the **Voltage Measurements** tab, set the **Scan Continuously** button. Observe that cell voltage levels are approximately equal in value. At this point, the MAX17852 is continuously reading the voltages across each of the 2kΩ resistors in the resistor ladder. Increasing the power-supply voltage increases the voltage across each of the 2kΩ resistors in the ladder. With the power supply set to 18.0V, each resistor ladder simulated cell voltage reads approximately 1.286V.
- 5) The INTRFC alert is generated when an improper communication action is taken. Select the **Alerts/Status** tab (Figure 20) and click the **Clear All Device Alerts** button to clear the INTRFC alert and all other alerts in the system.
- 6) Select the **Cell Balance** tab (Figure 21) and enable ALL balance switches by clicking the 14 checkboxes in the **Balance Switch Enable** group box.
- 7) Set the **Balancing Expiration Time** in rows 1–14 to the desired timer value for each cell balance (e.g., 100 or a value up to 1023).
- 8) In the **Under Voltage Threshold** group box, if using a benchtop power supply, select the **User-Defined CBUVTHR** from the drop-down list and set the **UV Threshold** to 1.5V. If using a battery pack, set the voltage to the desired undervoltage level.
- 9) In the **Balance Switch Control** group box, select **ADC/CAL and CBUVTHR Check Enabled** from the **Measure Enable** drop-down list.
- 10) In **Auto Cell Balance** mode, the state machine enables even and odd switches inversely. Using the sliderbar, set the **Duty Cycle** to 100% to effectively control a 50% duty cycle for each switch.
- 11) Use the **Mode** drop-down and select one of the **Automated Cell Balancing** modes to activate the **Balancing Expiration Timer**. Immediately the

**CBUVTHR Check Status** buttons illuminates red (CBUVTHR set to 1.5V in step 8 is greater than cell-voltage measurement) and the driver shuts off.

- 12) Observe in the lower left corner of the **Cell Balance** tab, the **Counter** box increments and **Timer** box count continues until the timer is expired.
- 13) From the **Mode** drop-down list in the **Cell Balance** tab, click on **Cell Balancing Disabled** to disable automated cell balancing.

### Automated Cell Balancing with MINCELL Threshold (Host Sleep Mode)

This procedure details the process for using the GUI to set up and run the automated cell balance with shutoff threshold set by the cell with the minimum cell voltage.

#### Procedure:

- 1) Set up hardware and run GUI according to the [Quick Start \(Single UART\)](#) section. **HelloAll Successful** and **UART device ready** response must be displayed in the **Event Log** on the **Initialization** tab ([Figure 13](#)).
- 2) Set the PCB resistor ladder DIP switches (SW1, SW2) to the ON position (closed). Verify P+B14 and B0P- jumpers are installed.
- 3) Select the **Voltage Measurements** tab ([Figure 15](#)) and click on the **Scan Settings** button in the **Settings** group box to open the **Scan Settings** panel ([Figure 16](#)). Click the **Cell Enable All** and **Unipolar All (Cell)** buttons. Select **64x Oversampling** from the **OVSAMPL** drop-down list, and then click the **Confirm Settings** button at the bottom of the window.
- 4) In the **Voltage Measurements** tab, click on the **Scan Continuously** checkbox. Observe that cell-voltage levels are approximately equal in value. At this point, the MAX17852 is continuously reading the voltages across each of the 2kΩ resistors in the resistor ladder. Increasing the power-supply voltage increases the voltage across each of the 2kΩ resistors in the ladder. With the power supply set to 24.0V each resistor ladder simulated cell voltage reads approximately 1.72V.
- 5) The INTRFC alert is generated when an improper communication action is taken. Select the **Alerts/Status** tab ([Figure 20](#)) and click the **Clear All Device Alerts** button to clear the INTRFC alert and all other alerts in the system.
- 6) Select the **Cell Balance** tab ([Figure 21](#)) and enable ALL balance switches by clicking the 14 checkboxes in the **Balance Switch Enable** group box. Set the **Balancing Expiration Timer** in rows 1–14 to the desired timer value for each cell balance (e.g., 100 or a value up to 1023).
- 7) In the **Under Voltage Threshold** group box, select **MINCELL-Defined CBUVTHR** from the drop-down list.
- 8) In the **Balance Switch Control** group box, set the **Measure Enable** drop-down to **ADC/CAL and CBUVTHR Check Enabled**.
- 9) In **Auto Cell Balance Mode**, the state machine enables even and odd switches inversely. Using the **Duty Cycle** sidebar, set to 100% to effectively control a 50% duty cycle for each switch.
- 10) Use the **Mode** drop-down list and select any one of the **Automated Cell Balancing** modes to activate the **Balancing Expiration Time**. Immediately, the CBUVTHR register becomes loaded with the lowest cell voltage, setting the **UV Threshold**. Due to the PCB resistor ladder cell emulation, some of the CBUVTHR Status buttons illuminate red as the cell-balance switches (SWn) are activated. Lowering the power-supply voltage illuminates all **CBUVTHR Check Status** indicators.
- 11) Observe in the lower left corner of the **Cell Balance** tab, that the **Counter** box increments and **Timer** box counts continue until the timer is expired.
- 12) Select the **Alerts/Status** tab and observe that **CBDONE** is activated. Click on the **Clear All Device Alerts** button.
- 13) Select the **Mode** drop-down list in the **Cell Balance** tab and click on **Cell Balancing Disabled** to disable automated cell balancing.

The graph in [Figure 29](#) displays an actual automated cell-balance cycle on a 14-cell ICR18650-26 battery pack using MINCELL as the shutoff mechanism. As seen in the graph, each cell continues to discharge through the MAX17852 cell-balance switch until the MINCELL threshold is achieved.

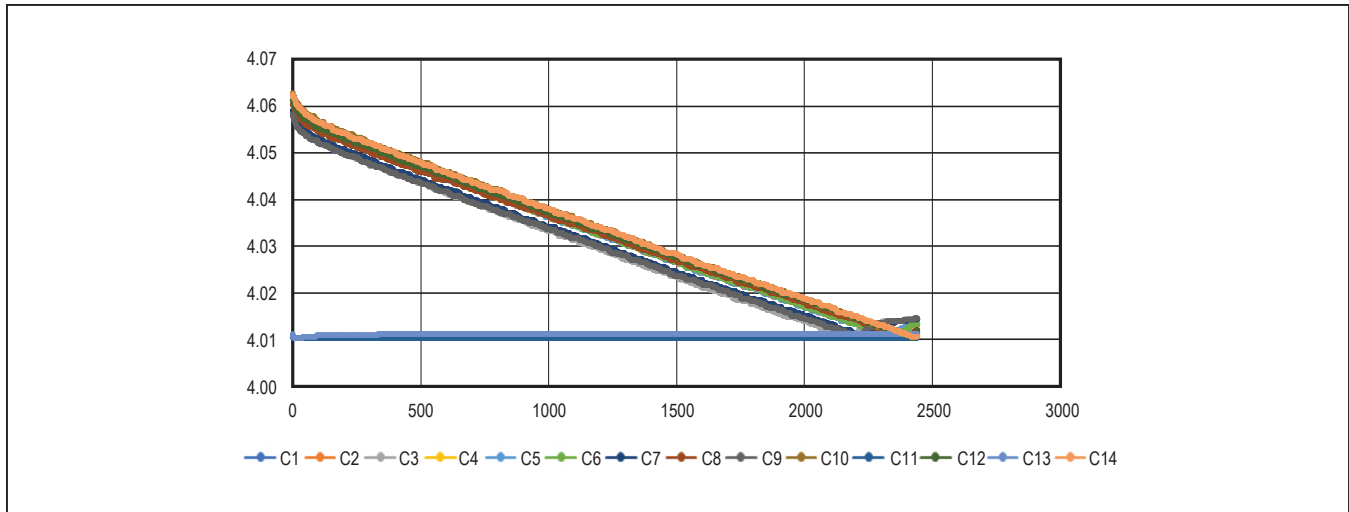

Figure 29. Automated Cell Balance

### Flexible Battery-Pack Connectivity

The flexible battery pack feature allows the user to optimize the battery pack system while maintaining hardware consistency across the pack's battery modules with variable number of cells. The following procedure demonstrates the default state of flexible battery pack and the proper activation.

#### Key Points to Consider:

- The FlexPack feature is considered partially enabled at power-up and must be fully enabled when the less than 14 cells are terminated to the MAX17852.
- When fully enabled, FlexPack uses internal MOSFETs to route power from the highest voltage switches input pin (SW8–SW14) to the DCIN pin.
- Programming FlexPack **TOPCELL** to a lower number cell than terminated to the device places a low ohmic short between the higher SWn input and the lower programmed **TOPCELL** SWn input. Caution must be exercised.

#### Procedure:

- 1) Set up hardware and run GUI according to the [Quick Start \(Single UART\)](#) section, with a few exceptions.
  - a) Connect power to both EV kits through terminal BAT12 to represent a 12-cell pack.
  - b) For both EV kits, set the PCB Resistor Ladder DIP Switches (SW1) to the ON position (closed). Close ladder DIP switches 1–5 on SW2.
  - c) Verify B0P- jumper is installed. Remove the P+B14 jumper.
- 2) Apply 18.0V power to the system, Initialize with Single UART Interface. Use **Wakeup** and **Hello All** to establish communication. Verify that **HelloAll Successful** and **UART device ready** response is displayed in the **Event Log** on the **Initialization** tab.
- 3) Select the **Voltage Measurements** tab ([Figure 15](#)) and click on the **Scan Settings** button in the **Settings** group box to open the **Scan Settings** panel ([Figure 16](#)). Select **Cell Enable** for Cell 1–Cell 12. Click **Confirm Settings** at the bottom of the window.

- 4) In the **Voltage Measurements** tab, click on the **Scan Continuously** checkbox. Observe that the cell voltage levels are approximately equal in value. At this point, the MAX17852 is continuously reading the differential voltages across the Cell 1–Cell 12 2kΩ emulation resistors. Increasing the power-supply voltage increases the voltage across each of the 2kΩ resistors in the ladder.
- 5) To fully activate the FlexPack, select the **General Configuration** tab (Figure 14). Set **TOPCELL** to the corresponding hex number of cells. Set **TOPCELL** to 0xC.
- 6) Generally, **TOPBLOCK** is programmed the same as **TOPCELL** unless bus bar measurement is desired. Refer to the MAX17852 IC data sheet for details on **TOPBLOCK** feature and operation. For the FlexPack exercise, Set **TOPBLOCK** to 0xC.
- 7) Programming **TOPCELL** to battery cell 12 terminates DCIN pin to battery cell 12. To verify operation, the user can connect a voltmeter between IC pin 55

(SW12) and test point DCIN. Set **TOPCELL** to hex 0xF to deactivate and observe the forward biased diode (~820mV) between IC pin 55 (SW12) and DCIN. Set **TOPCELL** to hex 0xC to activate the internal cell 12-FlexPack MOSFET and observe the internal MOSFET forward voltage. (~100mV).

The MAX17852 EV kit provides the user with an introduction to the features and functions of the MAX17852 device. Refer to the MAX17852 IC data sheet for detailed explanations of the product features, register set, and modes of operation.

**MAX17852 UART-to-SPI Hardware**

To communicate directly to the IC through the SPI interface, populate the components (see Table 4) and insert the MINIUSB+ to SPI converter directly into the MAX17852 EV kit. Additionally, the user must externally supply a voltage to the SHNDL pin on the EV kit.

**Table 4. UART-to-SPI Hardware Change**

ITEM	REF_DES	COMPONENT	COMMENTS
0Ω resistor (0603)	R13, R14, R15, R16	RC1608J000CS	Remove UART components from SPI signals
TRAN; PNP; SOT-363	Q1, Q2	BC857BS-7-F	Remove UART components from SPI signals
10kΩ ±1% resistors (0603)	R9	CRCW060310K0FK	Remove pullup from UARTSEL
10kΩ ±1% resistor (0603)	R10	CRCW060310K0FK	Populate pulldown on UARTSEL to select SPI
0Ω resistor (0603)	R141	RC1608J000CS	Populate to terminate ALERTOUT to level shifter
0Ω resistor (0603)	R1-R4	RC1608J000CS	Populate SPI components

**Ordering Information**

PART	TYPE
MAX17852EVKIT#	EV kit

#Denotes RoHS compliance.



MAX17852 EV Kit Bill of Materials (UART)

ITEM	QTY	REF DES	VAR STATUS	MAXNV	MFG PART #	MANUFACTURER	VALUE	DESCRIPTION	MAX17852 VARIANT COMMENT
1	11	ALARM_IN_UP_ALARM_OUT_LP_GPIO_AUX0-GPIO_AUX3, RXLP_CONN, RXUP_CONN, TXLP_CONN, TXUP_CONN, CURRENTSENSE	Pref	01-5025840270ZP-15	502584-0270	MOLEX	502584-0270	CONNECTOR, FEMALE; SMT; 502584 SERIES; STRAIGHT; 2PINS	Remove Connector GPIO_AUX4 and GPIO_AUX5. Place CURRENTSENSE Connector.
2	22	ALERTIN_ALERTIN_P_ALERTOUT_CPIN_CFP_DGIN_HV_RXLN_RXLP, RXP1_RXP2_RXUN_RXUP_TXLN_TXLP_TXP1_TXP2_TXUN_TXUP, UARTSEL_VAA_VBLK	Pref	02-TPMINI5000-00	5000	KEYSTONE	N/A	TEST POINT; PIN DIA=0.1IN, TOTAL LENGTH=0.3IN; BOARD HOLE=0.04IN; RED; PHOSPHOR BRONZE WIRE SILVER PLATE FINISH; RECOMMENDED FOR BOARD THICKNESS=0.062IN; NOT FOR COLD TEST	
3	9	ALERTIN_N_GPIOAUX0_GPIOAUX1_GPIOAUX2_GPIOAUX3_RXIN1_RXIN2, TXN1_TXN2	Pref	02-TPMINI5001-00	5001	KEYSTONE	N/A	TEST POINT; PIN DIA=0.1IN, TOTAL LENGTH=0.3IN; BOARD HOLE=0.04IN; BLACK; PHOSPHOR BRONZE WIRE SILVER PLATE FINISH; RECOMMENDED FOR BOARD THICKNESS=0.062IN; NOT FOR COLD TEST	Remove Test Point GPIOAUX4 and GPIOAUX5.
4	6	AUXGND_OPTO_OUT_SHDNL_THERM_VDD1_VDD2L3	Pref	02-TPMINI5004-00	5004	KEYSTONE	N/A	TEST POINT; PIN DIA=0.1IN, TOTAL LENGTH=0.3IN; BOARD HOLE=0.04IN; YELLOW; PHOSPHOR BRONZE WIRE SILVER PLATE FINISH; RECOMMENDED FOR BOARD THICKNESS=0.062IN; NOT FOR COLD TEST	
5	16	BOP_B1B0_B2B1_B3B2_B4B3_B5B4_B6B5_B7B6_B8B7_B9B8_B10B9, B11B10_B12B11_B13B12_B14B13_P-B14	Pref	01-PEC025AANZP-21	PEC025AAN	SULLINS ELECTRONICS CORP.	PEC025AAN	EVKIT PART-CONNECTOR, MALE, THROUGH HOLE, BREAKAWAY, STRAIGHT; 2PINS; NOTE: BOTH PINS ARE CIRCULAR	
6	21	BAT0-BAT14_GND_A_GND_A1-GND_A3_PACK+, PACK-	Pref	01-9020BUSS20AWG-00	9020 BUSS	WEICO WIRE	MAXIMPAD	EVKIT PARTS: MAXIM PAD, WIRE, NATURAL, SOLID, WEICO WIRE; SOFT DRAWN BUS TYPE-S; 20AWG	
7	1	C1	Pref	20-000U-101	CG2003R0X7R0BB104, GRM188R72A104KA55, GCJ188R72A104KA01	YAGEO, MURATA, MURATA	0.1UF	CAPACITOR: SMT (0603); CERAMIC CHIP; 0.1UF; 100V; TOL=10%; TC=+55 DEGC TO +125 DEGC, TC=X7R	
8	1	C2	Pref	20-1000P-BAB8	GCM155R72A102KA37	MURATA	1000PF	CAPACITOR: SMT (0402); CERAMIC CHIP; 1000PF; 100V; TOL=10%; TC=+55 DEGC TO +125 DEGC, TC=X7R; AUTO	
9	2	C3, C85	Pref	20-000U-R1	GRM188R70J105KA01, CL10B105K090NMC	MURATA, SAMSUNG ELECTRONICS	1.0UF	CAPACITOR: SMT (0603); CERAMIC; 1UF; 6.3V; TOL=10%; MODEL=GRM SERIES; TG=+55 DEGC TO +125 DEGC, TC=X7R; NOT RECOMMENDED FOR NEW DESIGN-USE 20-0001u#3	
10	3	C4, C5, C7	Pref	20-00U47-11C	GCM188R1C474KA55	TDK	0.47UF	CAPACITOR: SMT (0603); CERAMIC CHIP; 0.47UF; 16V; TOL=10%; TC=+55 DEGC TO +125 DEGC, TC=X7R; AUTO	
11	1	C6	Pref	20-00U47-DA51	GGA4J1X7R1E475K125AC	TDK	4.7UF	CAPACITOR: SMT (0805); CERAMIC CHIP; 4.7UF; 25V; TOL=10%; TC=+55 DEGC TO +125 DEGC, TC=X7R; AUTO	
12	1	C14	Pref	20-0100P-Y8	GRM1555C1E101GA01	MURATA	100PF	CAPACITOR: SMT (0402); CERAMIC CHIP; 100PF; 25V; TOL=2%; MODEL=GRM SERIES; TG=+55 DEGC TO +125 DEGC, TC=COG	
13	1	C15	Pref	20-3900P-26	C1608C0G1H392K080AA	TDK	3900PF	CAP-SMT (0603);3900PF;10%;50V;COG;CERAMIC CHIP	
14	1	C18	Pref	20-002U-2Q1	GRM32ER72A225KA35, CGA6N3X7R2A225P220, CG1C10KX7R068525	MURATA, TDK, YAGEO	2.2UF	CAPACITOR: SMT (1210); CERAMIC CHIP; 2.2UF; 100V; TOL=10%; MODEL=GRM SERIES; TG=+55 DEGC TO +125 DEGC, TC=X7R	
15	14	C20, C22-C23, C64	Pref	20-000U-1B82	CGA5H2XR2A104K115, C3216X8R2A104K115AA	TDK,TDK	0.1UF	CAPACITOR: SMT (1206); CERAMIC CHIP; 0.1UF; 100V; TOL=10%; MODEL=CGA SERIES; TG=+55 DEGC TO +150 DEGC, TC=X7R; AUTO	
16	1	C21	Pref	20-00U47-E9	GRM218R72A474KA73, 08051C474KA4A	MURATA, AVX	0.47UF	CAPACITOR: SMT (0805); CERAMIC CHIP; 0.47UF; 100V; TOL=10%; TG=+55 DEGC TO +125 DEGC, TC=X7R	
17	14	C34-C47	Pref	20-3900P-09	GRM319R72A392JA01	MURATA	3900PF	CAPACITOR: SMT (1206); CERAMIC CHIP; 3900PF; 100V; TOL=5%; TG=+55 DEGC TO +125 DEGC, TC=X7R	
18	16	C62-C75, C104, C109	Pref	20-000U-1P68	C1608C0R1E104K080AA	TDK	0.1UF	CAPACITOR: SMT (0603); CERAMIC CHIP; 0.1UF; 25V; TOL=10%; MODEL=C SERIES; TG=+55 DEGC TO +125 DEGC, TC=X7R	Populate C104 and C109 with 0.1uF.
19	4	C77, C80, C81, C83	Pref	20-0018P-27	C0402C180J5GAC, GRM1555C1H180JA01, C1005C0G1H180J050	KEMET, MURATA, TDK	18PF	CAPACITOR: SMT (0402); CERAMIC CHIP; 18PF; 50V; TOL=5%; TG=+55 DEGC TO +125 DEGC, TC=COG	
20	1	C87	Pref	20-0039P-E4	C0603C390K1GAC	KEMET	39PF	CAPACITOR: SMT (0603); CERAMIC CHIP; 39PF; 100V; TOL=10%; MODEL=COG; TG=+55 DEGC TO +125 DEGC, TC=X7R	
21	1	C88	Pref	20-0100P-22	C1206C101J1GAC	KEMET	1000PF	CAPACITOR: SMT (1206); CERAMIC; 1000PF; 100V; 5%; COG; 85deg/c; +125deg/c; 0 +/-30PPM/deg/c	
22	4	C89-C92	Pref	20-2200P-J7	CGA5H4C0G2J22J	TDK	2200PF	CAPACITOR: SMT (1206); CERAMIC CHIP; 2200PF; 50V; TOL=5%; MODEL=C SERIES; TG=+55 DEGC TO +125 DEGC, TC=COG	
23	1	C93	Pref	20-0015P-CA80	GCM1885CA150JA16	MURATA	15PF	CAPACITOR: SMT (0603); CERAMIC CHIP; 15PF; 100V; TOL=5%; TG=+55 DEGC TO +125 DEGC, TC=COG; AUTO	
24	5	C105, C106, C107, C108, C86	Pref	20-00U0-11	GRM188R71C103KA01, ECJ-1VB1C10, CL10B103K080NMC, GCJ188R71C103KA01	MURATA, PANASONIC, SAMSUNG, MURATA	0.01UF	CAPACITOR: SMT (0603); CERAMIC CHIP; 0.01UF; 16V; TOL=10%; TG=+55 DEGC TO +125 DEGC, TC=X7R	Populate C86 with 0.01uF
25	17	D3-D6, D11-D14, D16, D18-D21, D24, D25	Pref	30-SP402101FTG-00	SP4021-01FTG	LITTELFUSE	5V	DIODE, TVS; SMT (SOD-323); VRM=5V; PIV=25A	
26	2	D6, D10	Pref	30-PE5D3V3U1UB-00	PE5D3V3U1UB	NXP	3.3V	DIODE, TVS; SMT (SOD-523); PIV=3.3V; IF=0.1A	
27	4	D26, D28, D30, D31	Pref	30-DFLS11007-00	DFLS1100-7	DIODES INCORPORATED	DFLS1100-7	DIODE, SCHOTTKY; SMT; PIV=100V; IF=1A	
28	4	D28, D32-D34	Pref	30-SESDONCAN1L-00	SESDONCAN1LT1G	ON SEMICONDUCTOR	SESDONCAN1LT1G	DIODE, TVS; SMT (SOT-23); VRM=24V; PIV=2A	
29	1	J5	Pref	01-PEC12DAAN24P-19	PEC12DAAN	SULLINS ELECTRONICS CORP.	PEC12DAAN	CONNECTOR, MALE; THROUGH HOLE; BREAKAWAY, STRAIGHT; 24PINS	
30	1	J6	Pref	01-PBC15DAAN30P-21	PBC15DAAN	SULLINS ELECTRONICS CORP.	PBC15DAAN	CONNECTOR, MALE; THROUGH HOLE; BREAKAWAY, STRAIGHT; 30PINS	
31	1	J7	Pref	01-503154189018P-35	5031541890	MOLEX	5031541890	CONNECTOR, FEMALE; SMT; 1.5MM PITCH CLK/MATE; WIRE-TO-BOARD PCB RECEPTACLE; DUAL ROW; STRAIGHT; 18PINS	
32	4	L1-L4	Pref	51-00100-0AQ	MMZ20125601A	TDK	600	INDUCTOR; SMT (0805); FERRITE-BEAD; 600; TOL=+/-25%; 0.5A	
33	1	MINIG1	Pref	01-PEC08DAAN16P-21	PEC08DAAN	SULLINS ELECTRONICS CORP.	PEC08DAAN	CONNECTOR, MALE; THROUGH HOLE; BREAKAWAY, STRAIGHT; 16PINS; -65 DEGC TO +125 DEGC	
34	1	MINIG2	Pref	01-SSW10801TSBP-17	SSW-108-01-T-S	SAMTEC	SSW-108-01-T-S	CONNECTOR, FEMALE; THROUGH-HOLE 0.025IN POST SOCKET; STRAIGHT; 8PINS	
35	2	Q1, Q2	Pref	00-BC857BS-19	BC857BS-7-F	DIODES INCORPORATED	BC857BS-7-F	TRANS, PNP; SOT-363; PD=0.2W; (H=0.1A); V=45V	
36	20	R9, R14, R115, R122-R126, R131-R134, R146, R147, R150-R152, R154	Pref	80-0010K-24	CR0906031000FK, ERJ-3EKF1002	VISHAY DALE/PANASONIC	10K	RESISTOR; 0603; 10K OHM; 0.10W; THICK FILM	
37	13	R5-R8, R11, R13-R16, R28, R136, R165, R186	Pref	80-0000R-27A	RC1608J0002C, CR0603J-0000ELF, RC0603J9-0708L	SAMSUNG ELECTRONICS; BOURNS; YAGEO PH	0	RESISTOR; 0603; 0 OHM; 5%; JUMPER; 0.10W; THICK FILM	
38	1	R12	Pref	80-0100K-AA4	ERJ-3EKF1003	PANASONIC	100K	RESISTOR; 0603; 100K OHM; 1%; 100PPM; 0.1W; THICK FILM	
39	1	R17	Pref	80-0100R-AA39	RNCP1206FD100R	STACKPOLE ELECTRONICS INC	100K	RESISTOR; 1206; 100 OHM; 1%; 100PPM; 0.5W; THIN FILM	
40	1	R18	Pref	80-01K02-T1D	ERA-3AEB1021	PANASONIC	1.02K	RESISTOR; 0603; 1.02K OHM; 0.1%; 25PPM; 1W; METAL FILM	

MAX17852 EV Kit Bill of Materials (UART) (continued)

ITEM	QTY	REF DES	VAR STATUS	MAXXV	MFG PART #	MANUFACTURER	VALUE	DESCRIPTION	MAX17852 VARIANT COMMENT
41	1	R19	Pref	80-0010R-24A	ERJ-P03F10R0V	PANASONIC	10	RESISTOR, 0603, 10 OHM, 1%, 200PPM, 0.20W, THICK FILM	
42	5	R20, R27, R183, R184, R32	Pref	80-0000R-28A	RC0805JR-070RL	YAGEO PHYCOMP	0	RESISTOR, 0805, 0 OHM, 5%, JUMPER, 0.125W, THICK FILM	Populate R32
43	45	R21, R25, R29, R33, R35-R74, R77	Pref	80-0022R-48	ERJ-14NF22R0	PANASONIC	22	RES. SMT (1210), 22, 1%, +/-100PPM/DEGC, 0.5W	
44	6	R22, R110, R155, R161, R168, R169	Pref	80-0100K-53	ERJ-3GEYJ104V	PANASONIC	100K	RESISTOR, 0603, 100K OHM, 5%, 200PPM, 0.10W, THICK FILM	
45	15	R61-R95	Pref	80-0001K-24A	CR0603-FX-1001ELF	BOURNS	1K	RESISTOR, 0603, 1K OHM, 1%, 100PPM, 0.10W, THICK FILM	
46	14	R96-R109	Pref	80-0002K-24	CR0603-3K-1001V	VISHAY DALE: PANASONIC	2K	RESISTOR, 0603, 2K OHM, 1%, 100PPM, 0.10W, THICK FILM	
47	2	R111, R112	Pref	80-0360R-25	CR0603-360R-25	VISHAY DALE	360	RESISTOR, 0603, 360 OHM, 1%, 100PPM, 0.125W, THICK FILM	
48	1	R113	Pref	80-0001K-53	ERJ-3GEYJ102V	PANASONIC	1K	RESISTOR, 0603, 1K OHM, 5%, 200PPM, 0.10W, THICK FILM	
49	6	R116-R121	Pref	80-0001K-24	CR0603-1K-1001V	VISHAY DALE: PANASONIC	1K	RESISTOR, 0603, 1K, 1%, 100PPM, 0.10W, THICK FILM	
50	9	R129, R130, R138, R140, R179-R182	Pref	80-0000R-29	CR0603-12060000ZS, ERJ-3GEY0R00V	VISHAY DALE: PANASONIC	0	RESISTOR, 0603, 0 OHM, 0%, JUMPER, 0.25W, THICK FILM	
51	4	R157-R160	Pref	80-049R9-25	CR0603-49R9-25, ERJ-3GEY49R9	VISHAY DALE: PANASONIC	49.9	RESISTOR, 0603, 49.9 OHM, 1%, 100PPM, 0.125W, THICK FILM	
52	4	R162, R164, R172, R173	Pref	80-001K5-26	CR0603-12061K50FK	VISHAY DALE	1.5K	RESISTOR, 1206, 1.5K OHM, 1%, +/-100PPM, 14W, THICK FILM	
53	1	SHDML_SEL	Pref	01-FTS10301LS3P-21	FTS-103-01-L-S	SAMTEC		CONNECTOR, MALE, THROUGH HOLE, MICRO LOW PROFILE TERMINAL, STRIP, STRAIGHT, 3PINS	
54	2	SW1, SW2	Pref	11-ADE0804-00	ADE0804	TE CONNECTIVITY		SWITCH, SPST, DIP16, 24V, 0.1A, SLIDE ACTUATED PIANO-DIP, RC01L, OHM, BENSULATION OHM, TYCO ELECTRO	
55	4	THERM1-THERM	Pref	01-364445622P-21	3-644456-2	TYCO		CONNECTOR, HEADER STRIP, TH, STR, 2PINS, 1 ROW	Remove THERMS and THERM6 Jumper Header
56	1	U1	Pref	00-SAMPLE-02	MAX17852GCBV+	MAXIM		EVKIT PART-IC: MAX17852GCBV+, LOFP84, PACKAGE OUTLINE: 21-0883	
57	1	U2	Pref	10-MAX3378EUD-U	MAX3378EUD+	MAXIM		IC, TRANS -1.5KV ESD-PROTECTED, 1UA, 16MBPS, QUAD LOW-VOLTAGE LEVEL TRANSLATOR, TSSOP14	
58	1	U3	Pref	10-AT24CS08SSH-M	AT24CS08-SSH	ATMEL		IC, EPROM, 8K, COMPATIBLE TWO-WIRE SERIAL EEPROM, NSOIC8, 150ML	
59	1	U4	Pref	10-MAX3390EUD-U	MAX3390EUD+	MAXIM		IC, TRANS, 1.5KV ESD-PROTECTED, 1UA, 16MBPS, QUAD LOW-VOLTAGE LEVEL TRANSLATOR, TSSOP14	
60	1	U5	Pref	10-TL2770-W	TL2770	TOSHIBA		IC, PHOTO, 20MBPS LOW POWER PHOTOCOUPLER, WSOIC6	
61	1	PCB	-	EPCB1785X	MAX1785X	MAXIM		PCB, MAX1785X	
TOTAL 355									

DO NOT PURCHASE (DNP)

ITEM	QTY	REF DES	VAR STATUS	MAXXV	MFG PART #	MANUFACTURER	VALUE	DESCRIPTION	COMMENTS
1	4	C8-C11	DNP	20-000U1-B19	NMC0402X7R103K16TRP; GRM155R71C103KA01; CG0402KRXR7R78B103	NIC COMPONENTS CORP.; MURATA; YAGEO	0.01UF	CAPACITOR, SMT (0402), CERAMIC CHIP, 0.01UF, 18V, TOL=10%, MODEL= TG=55 DEGC TO +125 DEGC, TC=X7R	
2	2	C12, C13	DNP	20-000U1-B19	NMC0402X7R103K16TRP; GRM155R71C103KA01; CG0402KRXR7R78B103	NIC COMPONENTS CORP.; MURATA; YAGEO	0.01UF	CAPACITOR, SMT (0402), CERAMIC CHIP, 0.01UF, 18V, TOL=10%, MODEL= TG=55 DEGC TO +125 DEGC, TC=X7R	
3	1	C16	DNP	20-00U47-11C	GCM188R71C474KA55	TDK	0.47UF	CAPACITOR, SMT (0603), CERAMIC CHIP, 0.47UF, 18V, TOL=10%, TG=55 DEGC TO +125 DEGC, TC=X7R, AUTO	
4	1	C17	DNP	20-00U01-11	GRM188R71C103KA01; ECJ1Y8B1G10; CL10E103K08NNN; GCJ188R71C103KA01	MURATA/PANASONIC; SAMSUNG; MURATA	0.01UF	CAPACITOR, SMT (0603), CERAMIC CHIP, 0.01UF, 18V, TOL=10%, TG=55 DEGC TO +125 DEGC, TC=X7R	
5	1	C19	DNP	20-002U2-Q1	GRM32ER72A225KA35; CGA8N3X7R2A225K230; CG1210K0X7R0688225	MURATA; TDK; YAGEO	2.2UF	CAPACITOR, SMT (1210), CERAMIC CHIP, 2.2UF, 16V, TOL=10%, MODEL=KSM SERIES, TG=55 DEGC TO +125 DEGC, TC=X7R	
6	14	C48-C61	DNP	20-000U1-P98	C1068X7R1E104K080AA	TDK	0.1UF	CAPACITOR, SMT (0603), CERAMIC CHIP, 0.1UF, 25V, TOL=10%, MODEL=C SERIES, TG=55 DEGC TO +125 DEGC, TC=X7R	
7	4	C76, C78, C79, C82	DNP	20-0015P-27	C0402C0G500-150JNP; GRM1555C1H150JA01	VENKEL LTD.; MURATA	15PF	CAPACITOR, SMT (0402), CERAMIC CHIP, 15PF, 50V, TOL=10%, TG=55 DEGC TO +125 DEGC, TC=0G0	
8	0	C88	DNP	20-00U01-11	GRM188R71C103KA01; ECJ1Y8B1G10; CL10E103K08NNN; GCJ188R71C103KA01	MURATA/PANASONIC; SAMSUNG; MURATA	0.01UF	CAPACITOR, SMT (0603), CERAMIC CHIP, 0.01UF, 18V, TOL=10%, TG=55 DEGC TO +125 DEGC, TC=X7R	Move C88 from DNP to Populate.
9	2	CM1, CM2	DNP	50-005U1-SM5	ACT45B-510-2P-TL003	TDK		INDUCTOR, SMT (1812), WIREWOUND CHIP, 51UH, TOL=+50%/-20%, 2.2A	
10	2	CURRENTSENSE, GPIO_AUX4, GPIO_AUX5	DNP	01-50258402702P-15	502584-0270	MOLEX		CONNECTOR, FEMALE, SMT, 502584 SERIES, STRAIGHT, 2PINS	Remove CURRENTSENSE from DNP, Add GPIO_AUX4 and GPIO_AUX5 to DNP
11	3	D15, D22, D23	DNP	30-SP402101FTG-00	SP4021-01FTG	LITTELFUSE	6V	DIODE, TVS, SMT (SOD-323), VRM+6V, IPP=25A	
12	4	J1-J4	DNP	01-TSW11607GS16P-19	TSW-116-07-G-S	SAMTEC		CONNECTOR, MALE, SMT, 0.25INCH SQ POST, HEADER, STRAIGHT, 16PINS	
13	1	J8	DNP	01-SSW10401TS4P-19	SSW-104-01-T-S	SAMTEC		CONNECTOR, MALE, THROUGH HOLE, 0.025INCH SQ POST SOCKET, STRAIGHT, 4PINS	
14	7	R1-R4, R26, R143, R148	DNP	80-0000R-27A	RC1608J000CS; CR0603-J1-000ELF; RC0603JR-070RL	SAMSUNG ELECTRONICS;BOURNS;YAGEO PH	0	RESISTOR, 0603, 0 OHM, 0%, JUMPER, 0.10W, THICK FILM	
15	2	R10, R142	DNP	80-0010K-24	CR0603-10K-24	VISHAY DALE/PANASONIC	10K	RESISTOR, 0603, 10K, 1%, 100PPM, 0.10W, THICK FILM	
16	7	R23, R24, R30, R31, R141, R144, R145	DNP	80-0000R-27A	RC1608J000CS; CR0603-J1-000ELF; RC0603JR-070RL	SAMSUNG ELECTRONICS;BOURNS; YAGEO PH	0	RESISTOR, 0603, 0 OHM, 0%, JUMPER, 0.10W, THICK FILM	
17	1	R34, R32	DNP	80-0000R-28	CR0603-000000ZS; ERJ-3GEY0R00V; RC2012J000; RMCF08052TOR00	DIGI-KEY	0	RESISTOR, 0805, 0 OHM, JUMPER, 0.125W, THICK FILM	Move R32 from DNP to Populate.
18	2	R137, R139	DNP	80-0019K-53	ERJ-3GEYJ153V	PANASONIC	15K	RESISTOR, 0603, 15K OHM, 5%, 200PPM, 0.10W, THICK FILM	
19	0	R5-R8	DNP	80-0022R-24	CR0603-22R0R-24	VISHAY DALE	22	RESISTOR, 0603, 22 OHM, 1%, 100PPM, 0.10W, THICK FILM	(Alternate part for R5-R8)
20	2	GPIOAUX4, GPIOAUX5	DNP	02-TPMIN5001-00	5001	KEYSTONE	N/A	TEST POINT, PIN DIA=0.1IN, TOTAL LENGTH=0.3IN, BOARD HOLE=0.04IN, BLACK, PHOSPHOR BRONZE WIRE SILVER PLATE FINISH, RECOMMENDED FOR BOARD THICKNESS<=0.063IN, NOT FOR COLD TEST	DNP GPIOAUX4 and GPIOAUX5 test points
21	2	THERM5, THERM6	DNP	01-364445622P-21	3-644456-2	TYCO		CONNECTOR, HEADER STRIP, TH, STR, 2PINS, 1 ROW	DNP THERM5 and THERM6 Jumper Header
TOTAL 62									

MAX17852 EV Kit Bill of Materials (UART) (continued)

PACKOUT (These are purchased parts but not assembled on PCB and will be shipped with PCB)

ITEM	QTY	REF DES	VAR STATUS	MAXNV	MFG PART #	MANUFACTURER	VALUE	DESCRIPTION	COMMENTS
1	3	MISC1-MISC3	Pref	01-2844/19AWG24-00	2844/19 BK001	ALPHA WIRE COMPANY	N/A	WIRE: BLACK; 19/36; ALPHA WIRE COMPANY; HOOK-UP; MIL-W-16878E (TYPE E); AWG24	
2	2	MISC2, MISC3	Pref	01-2844/19AWG24-06	2844/19 BL001	ALPHA WIRE COMPANY	N/A	WIRE: BLUE; 19/36; ALPHA WIRE COMPANY; HOOK-UP; MIL-W-16878E (TYPE E); AWG24	
3	6	MISC1-MISC3	Pref	01-50257802002P-37	5025780200	MOLEX	N/A	CONNECTOR; FEMALE; WIREMOUNT; CLIK-MATE WIRE-TO-BOARD HOUSING; SINGLE ROW; POSITIVE LOCK ZPINS	
4	12	MISC1-MISC3	Pref	01-50257900001-22	5025790000	MOLEX	N/A	CONNECTOR; FEMALE; WIRE-TO-BOARD CRIMP TERMINAL; WIREMOUNT; 1PIN	
5	1	MISC1	Pref	01-2844/19AWG24-02	2844/19 RD001	ALPHA WIRE COMPANY	N/A	WIRE: RED; 19/36; ALPHA WIRE COMPANY; HOOK-UP; MIL-W-16878E (TYPE E); AWG24	
6	1	PACKOUT_BOX	Pref	88-00711-SML	88-00711-SML	N/A	N/A	BOX-SMALL BROWN 9 9/16X7X1 1/4 - PACKOUT	
7	1	PACKOUT_BOX	Pref	87-02162-00	87-02162-00	N/A	N/A	ESD BAG; BAG-STATIC SHIELD ZIP 44x66in; WESD LOGO - PACKOUT	
8	1	PACKOUT_BOX	Pref	85-MAXKIT-PNK	85-MAXKIT-PNK	N/A	N/A	PNK FOAM FOAMJANTS STATIC PE 12xX12xX5MM - PACKOUT	
9	1	PACKOUT_BOX	Pref	EVINSERT	EVINSERT	N/A	N/A	WEB INSTRUCTIONS FOR MAXIM DATA SHEET	
10	1	PACKOUT_BOX	Pref	85-84003-006	85-84003-006	N/A	N/A	LABEL(EV KIT BOX) - PACKOUT	
11	6	BUMP1-BUMP6	DNI	02-SJ5003-00	SJ-5003(BLACK)	3M ELECTRONIC SOLUTIONS DIVISION	SJ-5003(BLACK)	BUMPER; BLACK-HEMISPHERICAL SHAPE EWKIT EH0231; 0.44X0.28H; RESILIENT ELASTOMER POLYURETHANE	PACKOUT
12	1	MISC1	DNI	01-CLIKMATELOOP2PIN-10	CLIKMATE_2-PIN_LOOP-BACK	MAXIM	CLIK-MATE_2-PIN_LOOP-BACK	CABLE ASSEMBLY; TWO WIRE CLIK-MATE 2-WIRE LOOP CABLE WITH WIRE STRIPPER AND CRIMP TOOL; NOTE PURCHASE DIRECT FROM THE MANUFACTURER	PACKOUT
13	2	MISC2, MISC3	DNI	01-CLIKMATECABLE2WIRE-10	CLIKMATE-CABLE_2-WIRE	MAXIM	CLIK-MATE-CABLE_2-WIRE	CABLE ASSEMBLY; TWO WIRE CLIK-MATE CROSSOVER CABLE WITH WIRE STRIPPER AND CRIMP TOOL; NOTE PURCHASE DIRECT FROM THE MANUFACTURER	PACKOUT

TOTAL 38

MAX175x EV Kit Schematics

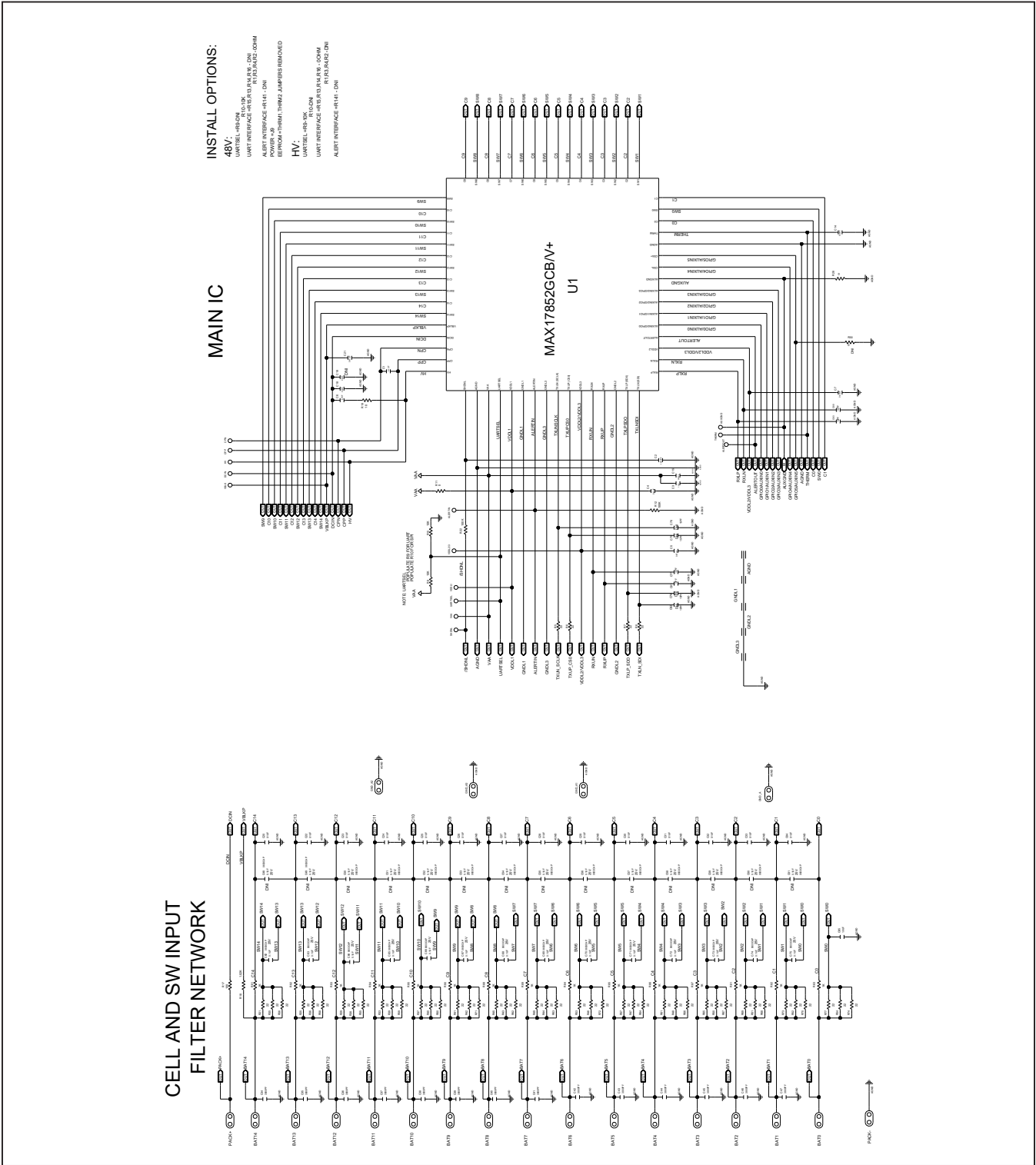

MAX1785x EV Kit Schematics (continued)

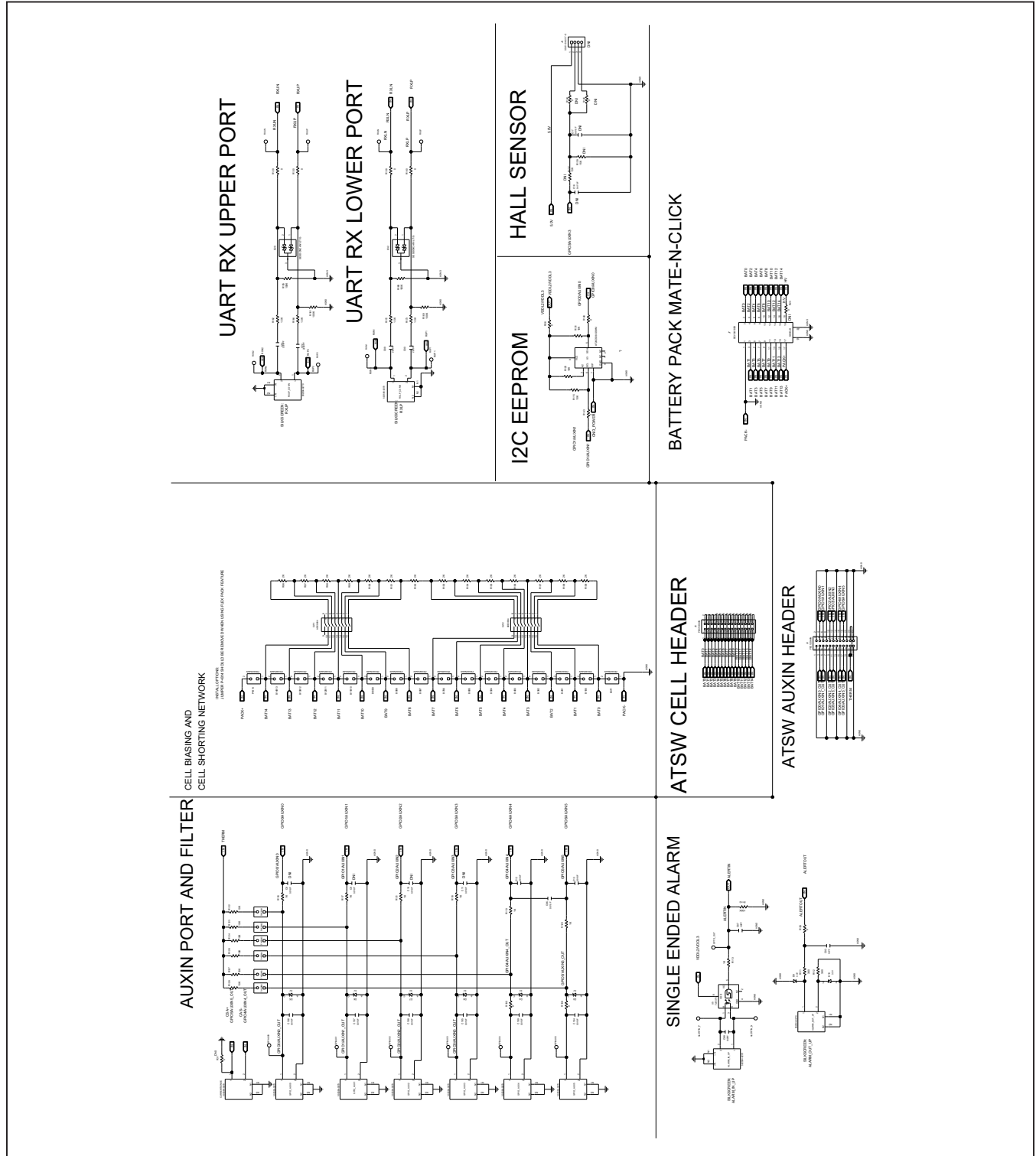

MMAX1785x EV Kit Schematics (continued)

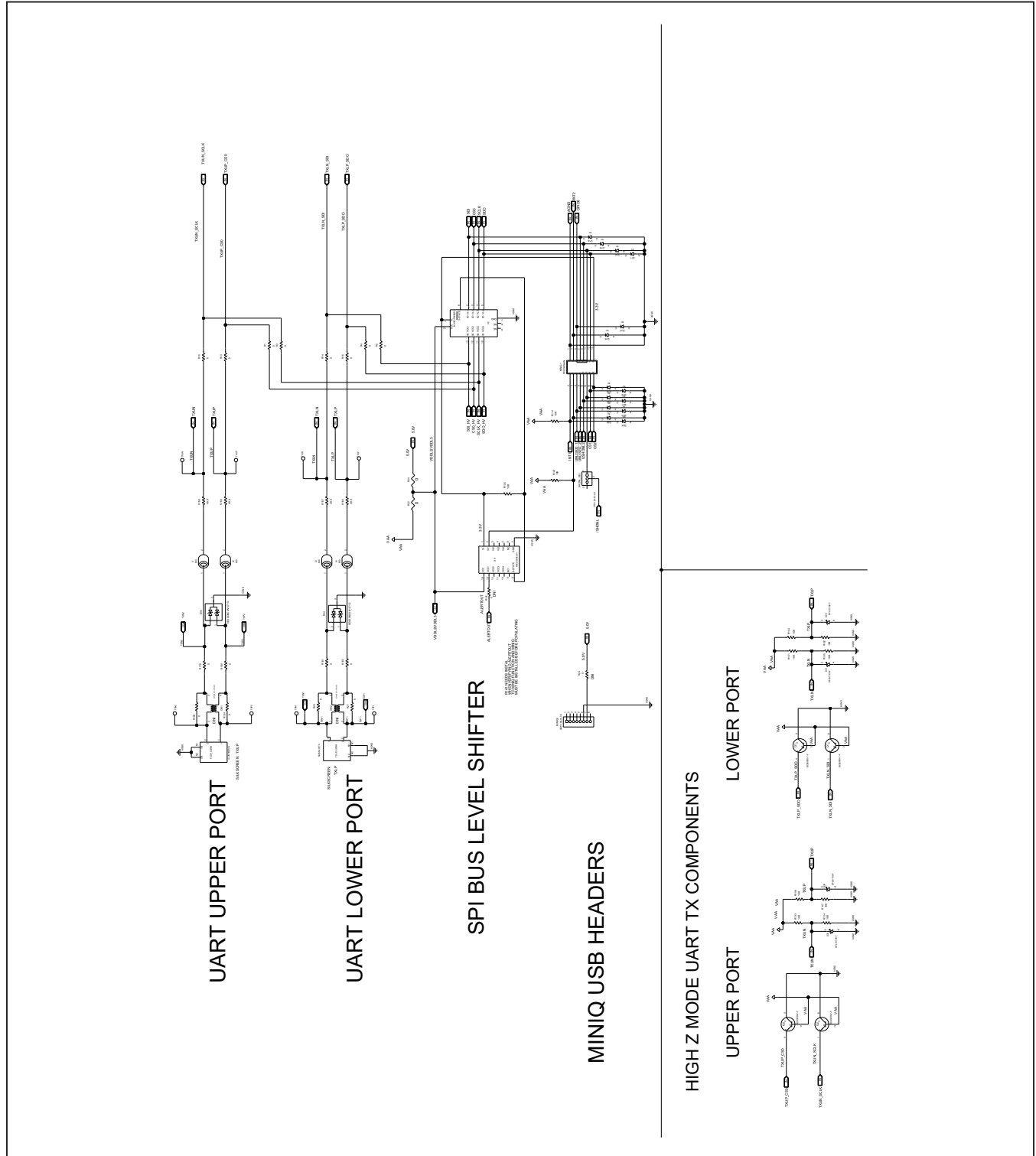

MAX1785x EV Kit Schematics (continued)

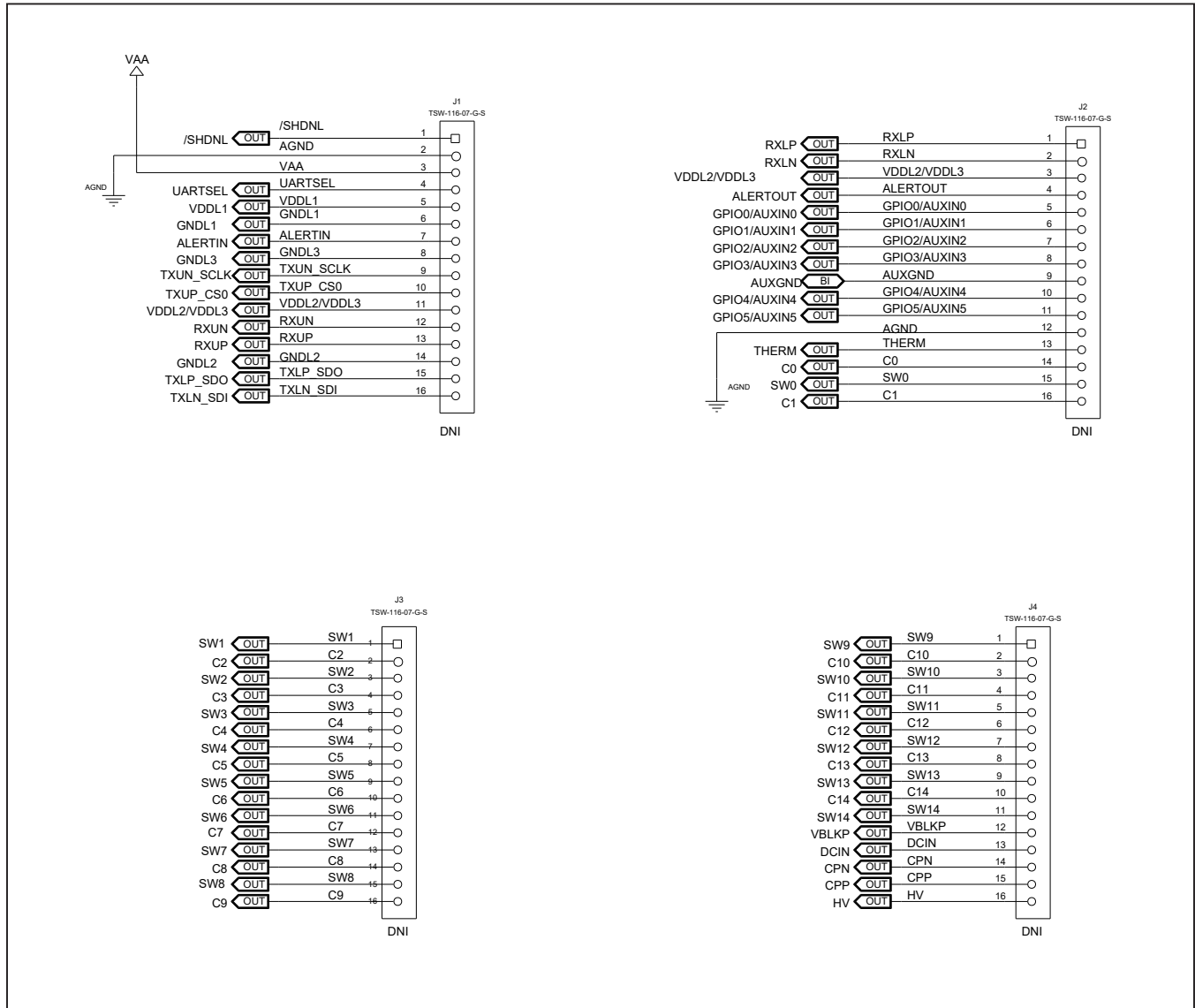

MAX1785x EV Kit PCB Layouts

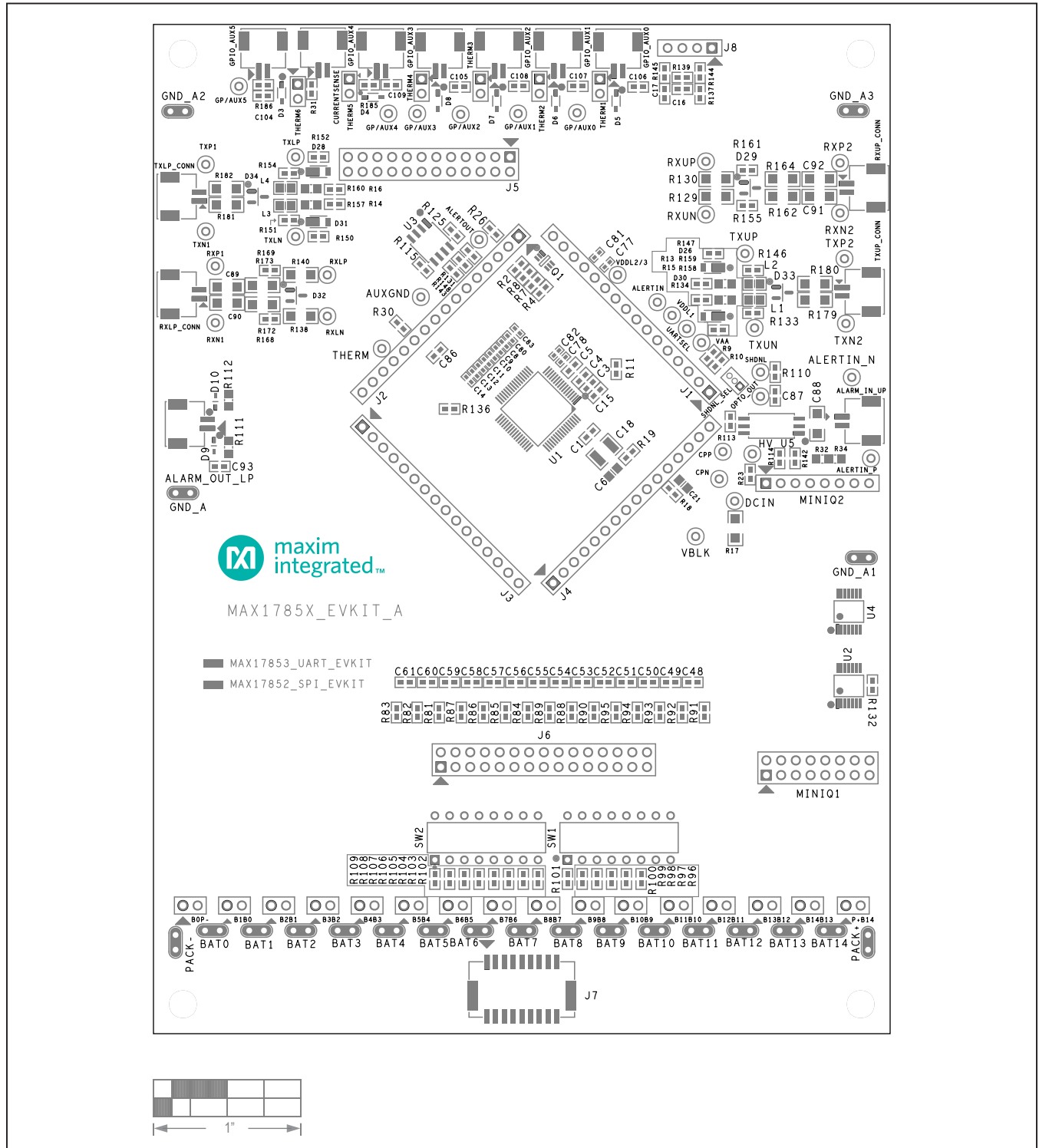

MAX17852 EV Kit PCB Layout—Top Layer Silkscreen



MAX1785x EV Kit PCB Layouts (continued)

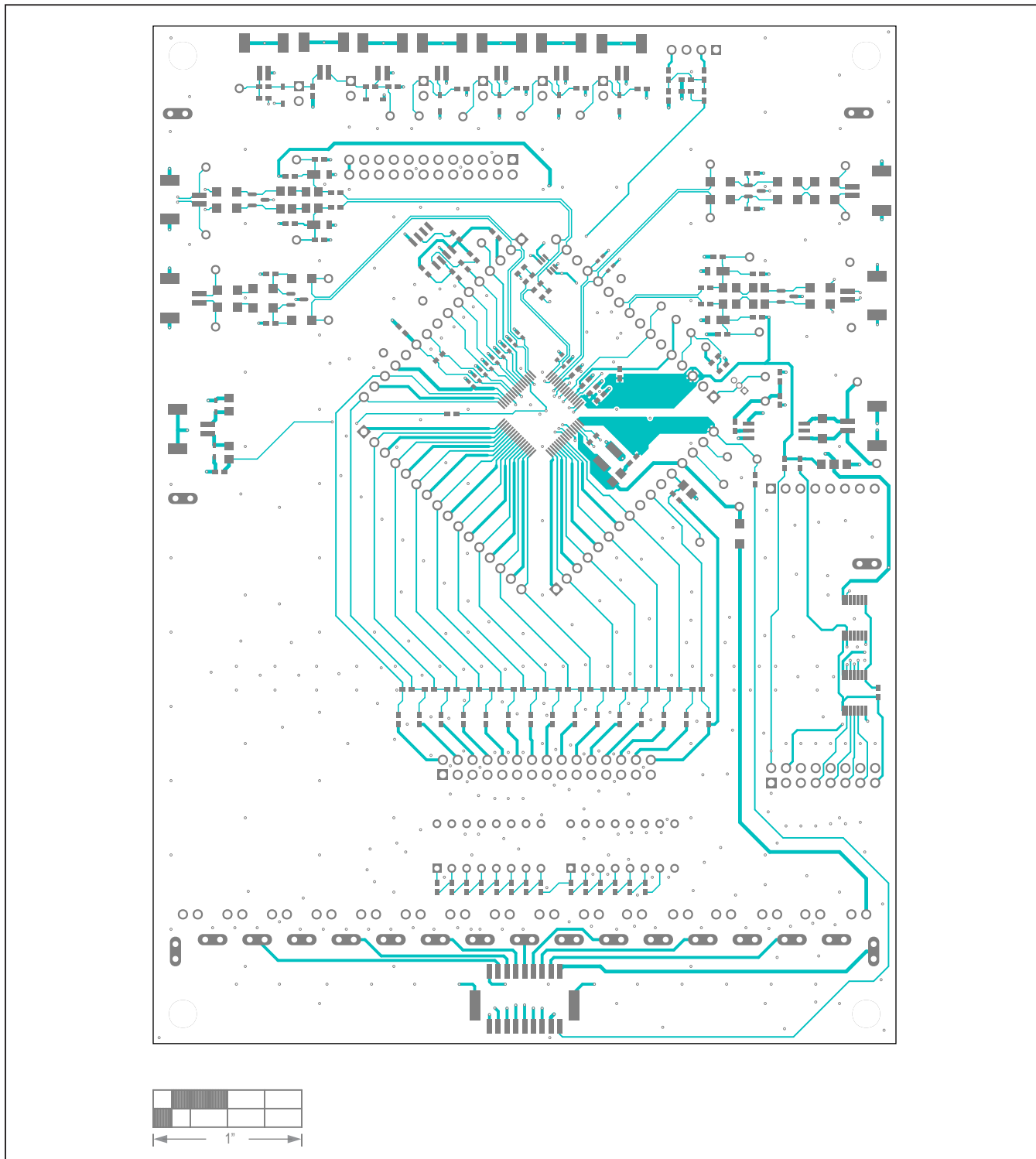

MAX17852 EV Kit PCB Layout—Top Layer Metal

MAX1785x EV Kit PCB Layouts (continued)

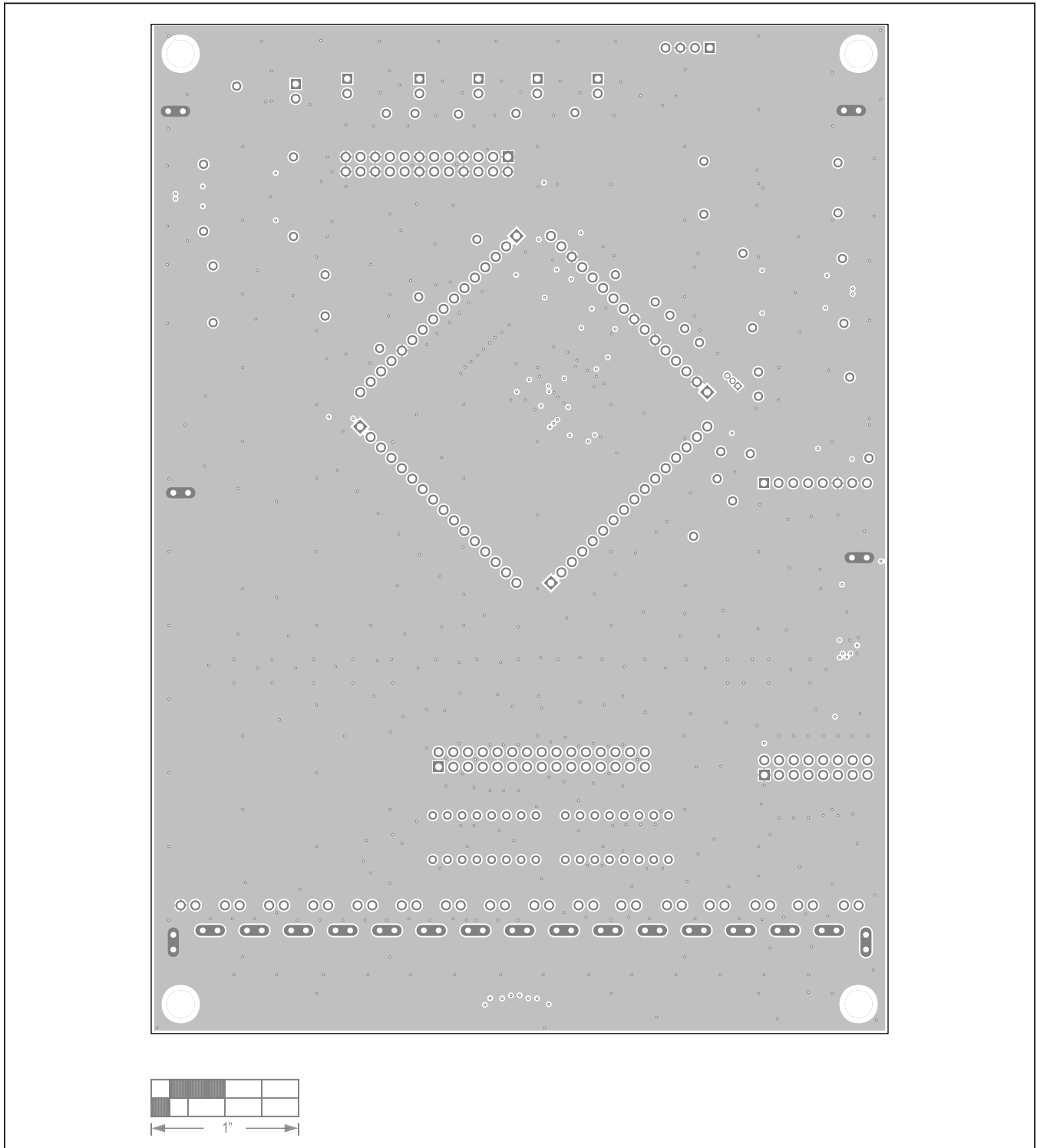

MAX17852 EV Kit PCB Layout—Layer Two Metal

MAX1785x EV Kit PCB Layouts (continued)

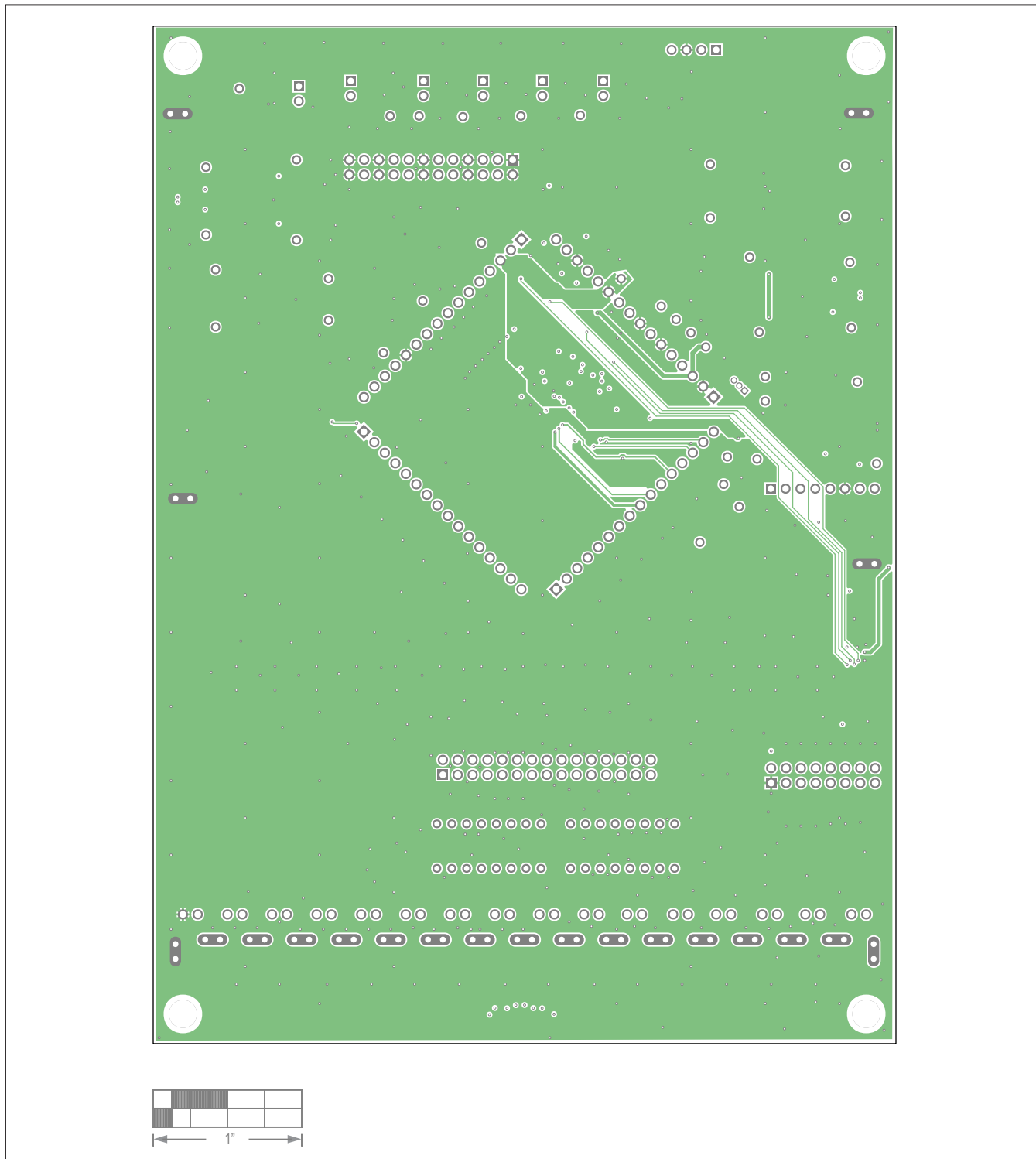

MAX17852 EV Kit PCB Layout—Layer Three Metal

MAX1785x EV Kit PCB Layouts (continued)

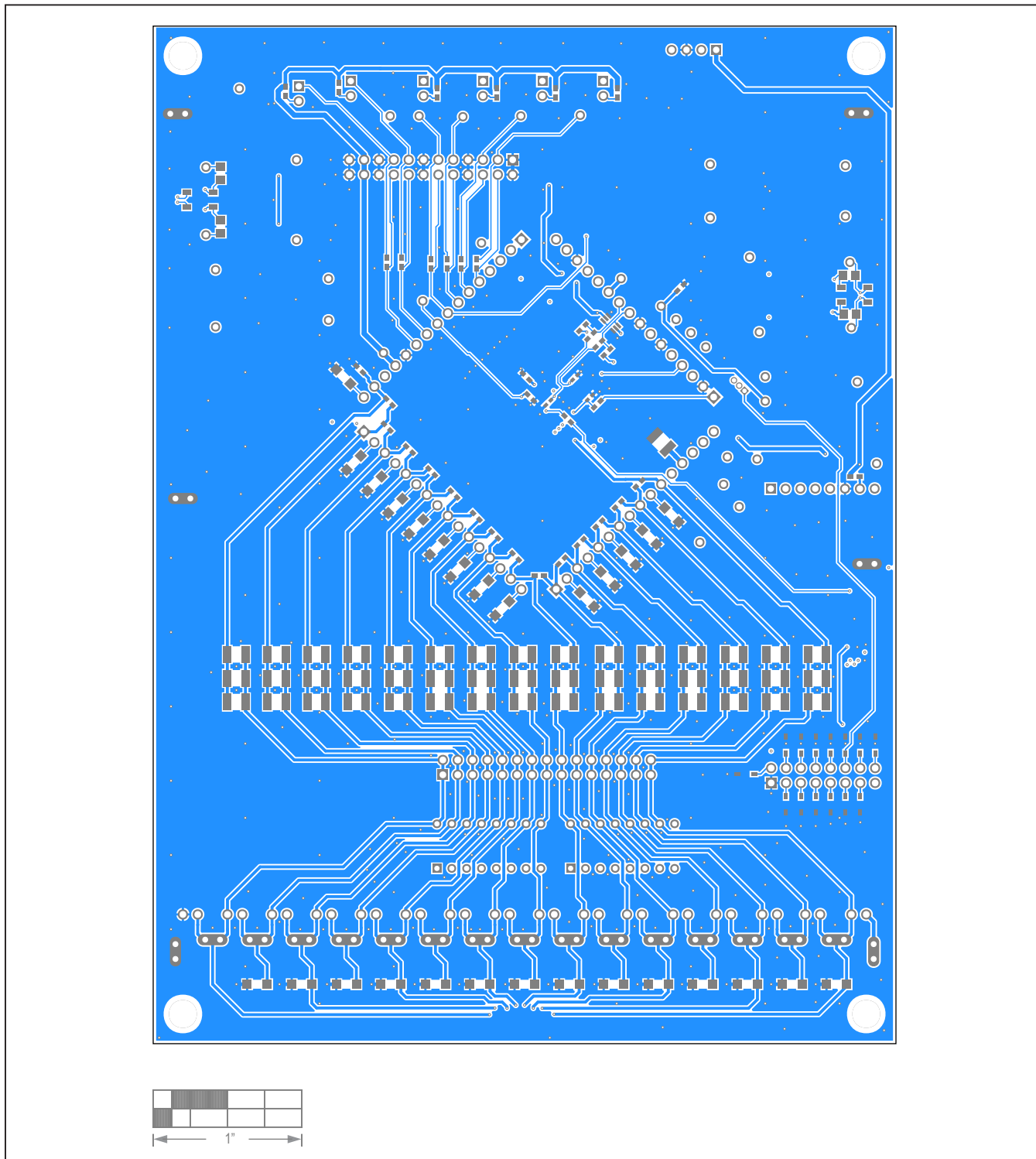

MAX17852 EV Kit PCB Layout—Bottom Layer Metal

MAX1785x EV Kit PCB Layouts (continued)

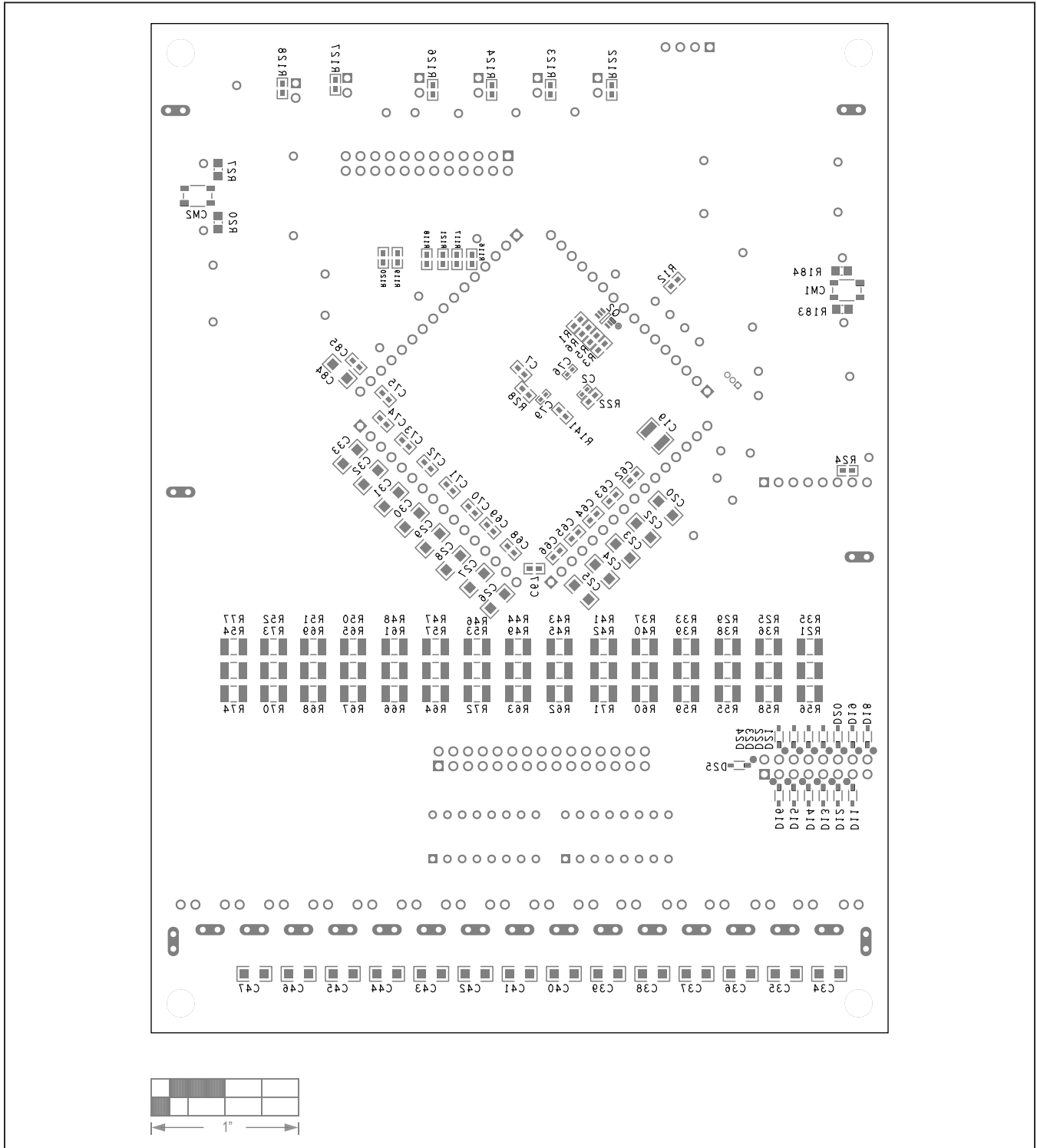

MAX17852 EV Kit PCB Layout—Bottom Layer Silkscreen

## Revision History

REVISION NUMBER	REVISION DATE	DESCRIPTION	PAGES CHANGED
0	12/20	Initial release	—

For pricing, delivery, and ordering information, please visit Maxim Integrated's online storefront at <https://www.maximintegrated.com/en/storefront/storefront.html>.

*Maxim Integrated cannot assume responsibility for use of any circuitry other than circuitry entirely embodied in a Maxim Integrated product. No circuit patent licenses are implied. Maxim Integrated reserves the right to change the circuitry and specifications without notice at any time.*