

SWITCH SCHEMATIC

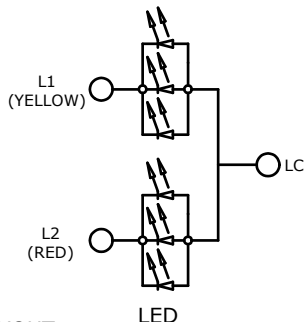

CIRCUIT LAYOUT

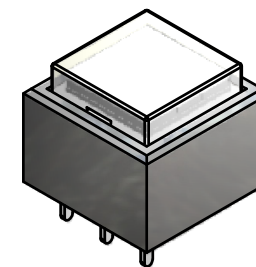
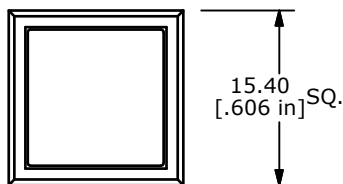

ISOMETRIC

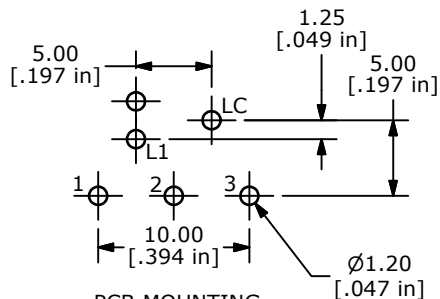

PCB MOUNTING

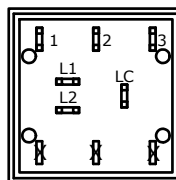
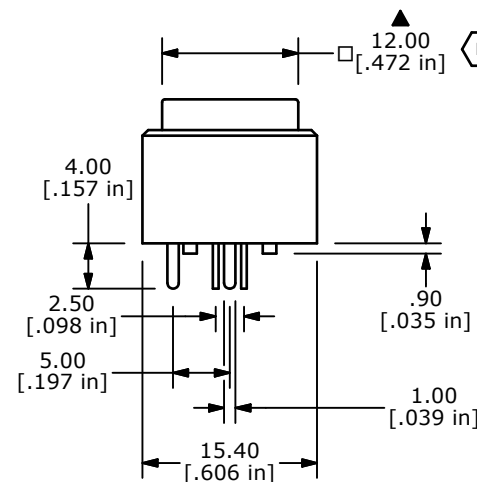
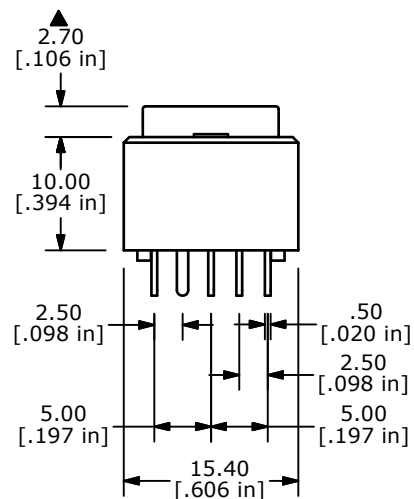

NOTES:

1. ALL DIMENSIONS IN MM
2. GENERAL TOLERANCE: X.X=±0.4
X.XX=±0.25
3. TERM. NOS. FOR REFERENCE ONLY.
- ▲ 4. CONTACT RATING: 0.4VA MAX. @ 28 V (AC OR DC)
5. CONTACT MATERIAL: SILVER
6. ELECTRICAL LIFE: 200,000 Typical
7. MECHANICAL LIFE:
1,000,000 CYCLES TYP.
8. OPERATING TEMP: -20°C TO +70°C
9. OPERATING FORCE: 200 ± 100 gf
10. CONTACT RESISTANCE:
50 MILLI-OHM INITIAL TYP. MAX.
11. DIELECTRIC STRENGTH:
1000 VAC FOR 1 MINUTE
12. TRAVEL TO MAKE: 2.20mm ± 0.2
13. 2002/95/EC (ROHS) COMPLIANT
14. ▲ DENOTES CRITICAL PARAMETER
- ▲ 15. LED COLOR: YEL: 3 CHIPS; 2.1VDC, @20mA TYP.
RED: 3 CHIPS; 1.7VDC, @20mA TYP.

LED SPECS	UNITS	YELLOW	RED
FORWARD CURRENT	mA	20	20
FORWARD VOLTAGE @ 20mA	V	1.95 TYP - 2.2 MAX	1.95 TYP - 2.2 MAX
LUMINOUS INTENSITY @ 20mA	mcd	232 TYP.	77 TYP.



B	20169	CORRECT CAP DIMENSION	09/21/11	BMA
A	20044	RELEASED FOR PRODUCTION	7/1/11	BGL
REV	PCR NO	DESCRIPTION	DATE	BY

TITLE ULP12EEP1QSFCL1YELRED				
SCALE	DATE	DR	DWG	REV
1.5:1	7/1/2011	BGL	B800015	B

THE INFORMATION CONTAINED IN THIS DOCUMENT IS PROPRIETARY TO E-SWITCH AND IS NOT TO BE COPIED OR TRANSFERRED