

**Technical Data Sheet****5 mm Cylindrical Shape**423-2ASURC/S400-A8**Features**

- Cylindrical lens with white Diffused color .
- I.C compatible.
- Available on tape and reel.
- Reliable and robust.
- The product itself will remain within RoHS compliant version.

**Descriptions**

- The series is specially designed for applications requiring higher brightness
- The LED lamps are available with different colors, intensities, epoxy colors, etc.

**Applications**

- TV set
- Monitor
- Telephone
- Computer

**Device Selection Guide**

Chip		Lens Color
Material	Emitted Color	
AlGaInN	Super Red	Water Clear

Technical Data Sheet

5 mm Cylindrical Shape

423-2ASURC/S400-A8

Package Dimensions

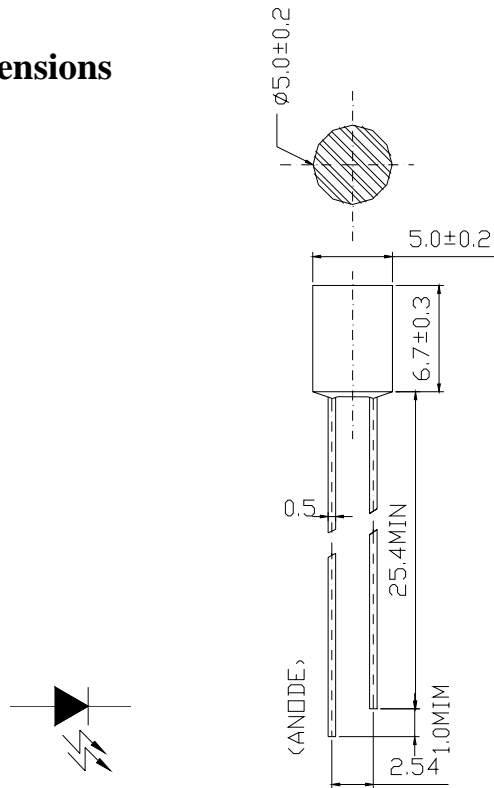

Notes:

- All dimensions are in millimeters, tolerance is 0.25mm except being specified.
- Lead spacing is measured where the lead emerges from the package.
- Protruded resin under flange is 1.5mm Max LED.

Absolute Maximum Ratings (Ta=25°C)

Parameter	Symbol	Rating	Units
Forward Current	I <sub>F</sub>	50	mA
Pulse Forward Current(Duty 1/10@ 1KHz)	I <sub>FP</sub>	100	mA
Operating Temperature	T <sub>opr</sub>	-40 ~ +85	°C
Storage Temperature	T <sub>stg</sub>	-40 ~ +100	°C
Electrostatic Discharge	ESD	2000	V
Soldering Temperature *2	T <sub>sol</sub>	260 ±5	°C
Power Dissipation	P <sub>d</sub>	115	mW
Reverse Voltage	V <sub>R</sub>	5	V

Notes: Soldering time ≤ 5 seconds.



## Technical Data Sheet

## 5 mm Cylindrical Shape

423-2ASURC/S400-A8

## Electro-Optical Characteristics (Ta=25°C)

Parameter	Symbol	Condition	Min.	Typ.	Max.	Units
Forward Voltage	$V_F$	$I_F=20mA$	--	2.0	2.5	V
Reverse Current	$I_R$	$V_R=5V$	--	--	10	$\mu A$
Luminous Intensity	$I_V$	$I_F=20mA$	140	200	--	mcd
Viewing Angle	$2\theta 1/2$	$I_F=20mA$	--	90	--	deg
Peak Wavelength	$\lambda_p$	$I_F=20mA$	--	632	--	nm
Dominant Wavelength	$\lambda_d$	$I_F=20mA$	--	624	--	nm
Spectrum Radiation Bandwidth	$\Delta \lambda$	$I_F=20mA$	--	20	--	nm

Rank Combination ( $I_F=20mA$ )

Rank	9	A	B	C	D
Luminous Intensity	140~170	170~200	200~240	240~285	285~360

\*Measurement Uncertainty of Luminous Intensity:  $\pm 15\%$ 

Unit:mcd

Rank	K	L	M	N
Forward Voltage	1.7~1.9	1.9~2.1	2.1~2.3	2.3~2.5

\*Measurement Uncertainty of Forward Voltage:  $\pm 0.1V$ 

Unit:V

Rank	1	2	3
Dominant Wavelength	618~620	620~624	624~628

\*Measurement Uncertainty of Dominant Wavelength  $\pm 1.0nm$ 

Unit:nm

Technical Data Sheet

5 mm Cylindrical Shape

423-2ASURC/S400-A8

Typical Electro-Optical Characteristics Curves

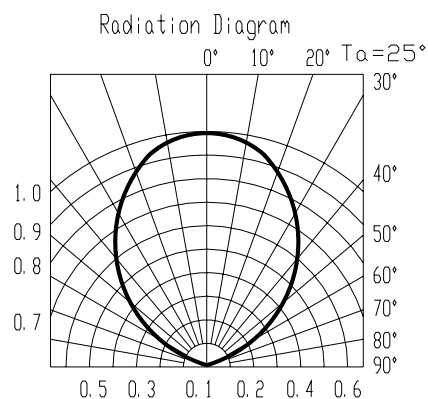
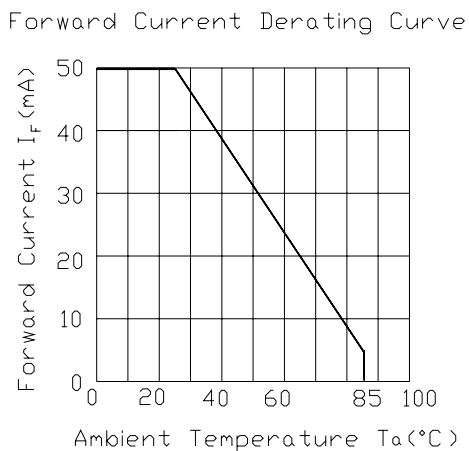
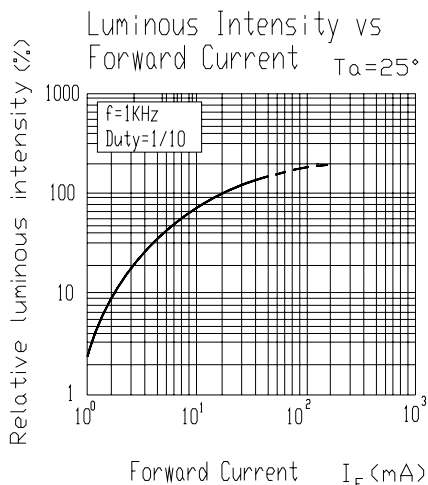
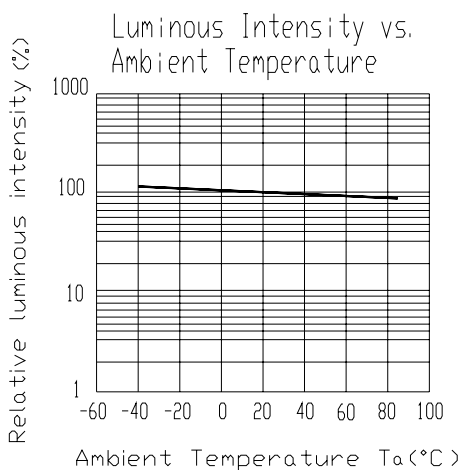
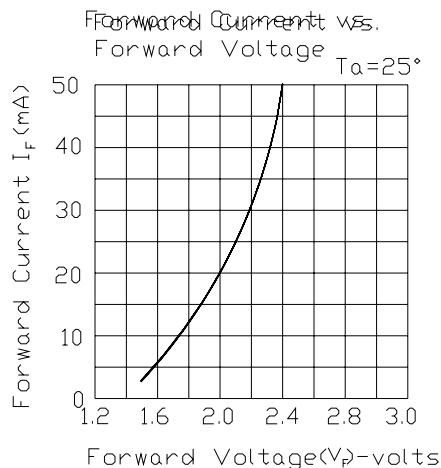
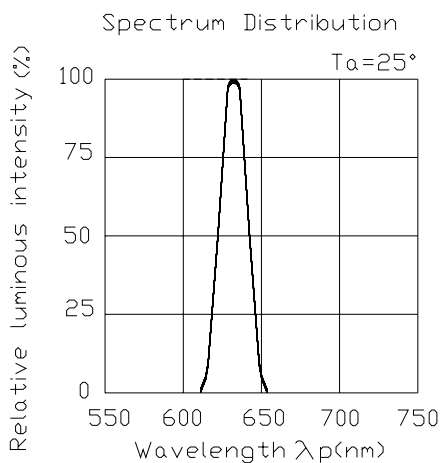



### Technical Data Sheet

## 5 mm Cylindrical Shape

423-2ASURC/S400-A8

#### Packing Quantity Specification

1.500PCS/1Bag , 5Bags/1Box

2.10Boxes/1Carton

#### Label Form Specification



CPN: Customer's Production Number

P/N : Production Number

QTY: Packing Quantity

CAT: Ranks of Luminous Intensity and Forward Voltage

HUE: Ranks of Dominant Wavelength

REF: Reference

LOT No: Lot Number

MADE IN TAIWAN: Production Place



Technical Data Sheet

5 mm Cylindrical Shape

423-2ASURC/S400-A8

Notes

1. Above specification may be changed without notice. EVERLIGHT will reserve authority on material change for above specification.
2. When using this product, please observe the absolute maximum ratings and the instructions for using outlined in these specification sheets. EVERLIGHT assumes no responsibility for any damage resulting from use of the product which does not comply with the absolute maximum ratings and the instructions included in these specification sheets.
3. These specification sheets include materials protected under copyright of EVERLIGHT corporation. Please don't reproduce or cause anyone to reproduce them without EVERLIGHT's consent.
4. Soldering Condition

Careful attention should be paid during soldering. When soldering, leave more then 3mm from solder joint to case, and soldering beyond the base of the tie bar is recommended.

Avoiding applying any stress to the lead frame while the LEDs are at high temperature particularly when soldering.

Recommended soldering conditions:

Hand Soldering		DIP Soldering	
Temp. at tip of iron	400°C Max. (30W Max.)	Preheat temp.	100°C Max. (60 sec Max.)
Soldering time	3 sec Max.	Bath temp.	265 Max.
Distance	3mm Min.(From solder joint to case)	Bath time.	5 sec Max.
		Distance	3mm Min.

**EVERLIGHT ELECTRONICS CO., LTD.**  
 Office: No 25, Lane 76, Sec 3, Chung Yang Rd,  
 Tucheng, Taipei 236, Taiwan, R.O.C

Tel: 886-2-2267-2000, 2267-9936  
 Fax: 886-2267-6244, 2267-6189, 2267-6306  
<http://www.everlight.com>