

MAX6226

Ultra-High-Precision, Ultra-Low-Noise, Series Voltage Reference

General Description

The MAX6226 is an ultra-low-noise, high-precision, low-dropout voltage reference. This family of voltage references feature curvature-correction circuitry and high-stability, laser-trimmed, thin-film resistors that result in 3ppm/°C (max) temperature coefficients and an excellent $\pm 0.02\%$ (max) initial accuracy. The proprietary low-noise reference architecture produces a low flicker noise of $1.45\mu\text{V}_{\text{P-P}}$ and wideband noise as low as $75\text{nV}/\sqrt{\text{Hz}}$ (2.5V output) without the increased supply current usually found in low-noise references. Improve wideband noise to $45\text{nV}/\sqrt{\text{Hz}}$ and AC power-supply rejection by adding a $0.1\mu\text{F}$ capacitor at the noise reduction pin. The MAX6226 series mode reference operates from a wide 2.7V to 12.6V supply voltage range and load-regulation specifications are guaranteed to be less than 0.25Ω and 0.05Ω for sink and source currents up to 10mA, respectively. These devices are available over the automotive temperature range of -40°C to $+125^\circ\text{C}$.

The MAX6226 typically draws $380\mu\text{A}$ of supply current and the output voltages are 2.5V and 5.0V. The MAX6226 also feature dropout voltages as low as 200mV. Unlike conventional shunt-mode (two-terminal) references that waste supply current and require an external resistor, the MAX6226 offers supply current that is virtually independent of supply voltage and does not require an external resistor. The MAX6226 is stable with $0.1\mu\text{F}$ to $10\mu\text{F}$ of load capacitance, and is available in an 8-pin ceramic package.

Benefits and Features

- 8-pin Hermetically Sealed Ceramic Package Reduces System Board Space
- Ultra-Low $1.45\mu\text{V}_{\text{P-P}}$ Noise (0.1Hz to 10Hz, 2.5V Output)
- Ultra-Low 3ppm/°C (Max) Temperature Coefficient
- $\pm 0.02\%$ (Max) Initial Accuracy
- Wide ($V_{\text{OUT}} + 200\text{mV}$) to 12.6V Supply Voltage Range
- Low 200mV (Max) Dropout Voltage
- $380\mu\text{A}$ Quiescent Supply Current
- 10mA Sink/Source-Current Capability
- Stable with $C_{\text{LOAD}} = 0.1\mu\text{F}$ to $10\mu\text{F}$
- Low 11ppm/1000hr Long-Term Drift
- 0.05Ω (Max) Load Regulation
- $25\mu\text{V}/\text{V}$ (Max) Line Regulation
- Force and Sense Outputs for Remote Sensing

Applications

- High-Resolution A/D and D/A Converters
- ATE Equipment
- High-Accuracy Reference Standard
- Precision Current Sources
- Digital Voltmeters
- High-Accuracy Industrial and Process Control

Ordering Information appears at end of data sheet.

Typical Operating Circuit

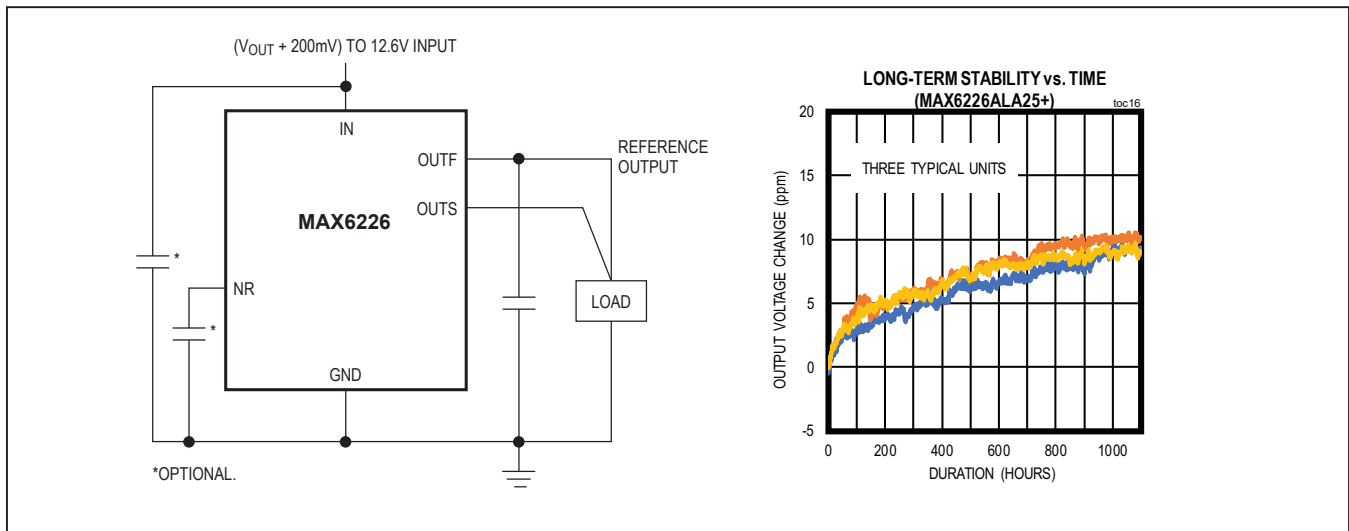

Absolute Maximum Ratings

(All voltages referenced to GND)

IN -0.3V to +13V
 OUTF, OUTS, NR..... -0.3V to the lesser of (V_{IN} + 0.3V) or +6V
 Output Short Circuit to GND or IN..... 60s
 Continuous Power Dissipation (T_A = +70°C)
 8-Pin LCC (derate 17.79mW/°C above +70°C)..... 1423.5mW

Operating Temperature Range..... -40°C to +125°C
 Junction Temperature..... +150°C
 Storage Temperature Range..... -65°C to +150°C
 Lead Temperature (soldering, 10s) +300°C
 Soldering Temperature (reflow)..... +260°C

Stresses beyond those listed under "Absolute Maximum Ratings" may cause permanent damage to the device. These are stress ratings only, and functional operation of the device at these or any other conditions beyond those indicated in the operational sections of the specifications is not implied. Exposure to absolute maximum rating conditions for extended periods may affect device reliability.

Package Information

LCC

PACKAGE CODE	L8+2
Outline Number	21-100289
Land Pattern Number	90-100097
Thermal Resistance, Four-Layer Board:	
Junction to Ambient (θ _{JA})	56.19°C/W
Junction to Case (θ _{JC})	8.11°C/W

For the latest package outline information and land patterns (footprints), go to www.maximintegrated.com/packages. Note that a "+", "#", or "-" in the package code indicates RoHS status only. Package drawings may show a different suffix character, but the drawing pertains to the package regardless of RoHS status.

Package thermal resistances were obtained using the method described in JEDEC specification JESD51-7, using a four-layer board. For detailed information on package thermal considerations, refer to www.maximintegrated.com/thermal-tutorial.

Electrical Characteristics—MAX6226_25 (V_{OUT} = 2.500V)(V_{IN} = 5V, C_{LOAD} = 0.1μF, I_{OUT} = 0, T_A = T_{MIN} to T_{MAX}, unless otherwise noted. Typical values are at T_A = +25°C . (Note 1))

PARAMETER	SYMBOL	CONDITIONS		MIN	TYP	MAX	UNITS
OUTPUT							
Output Voltage	V _{OUT}	T _A = +25°C		2.500			V
Output Voltage Accuracy		Referred to V _{OUT} , T _A = +25°C	A grade	-0.02		+0.02	%
Output Voltage Temperature Coefficient (Note 2)	T _{CVOUT}	T _A = -40°C to +125°C	A grade		1	3	ppm/°C
Line Regulation	ΔV _{OUT} / ΔV _{IN}	2.7V ≤ V _{IN} ≤ 12.6V	T _A = +25°C		5	25	μV/V
			T _A = -40°C to +125°C			45	
Load Regulation	ΔV _{OUT} / ΔI _{OUT}	Sourcing: 0 ≤ I _{OUT} ≤ 10mA			5	50	μV/mA
		Sinking: -10mA ≤ I _{OUT} ≤ 0			50	250	
Dropout Voltage (Note 3)	V _{IN} - V _{OUT}	ΔV _{OUT} = 0.1%	I _{OUT} = 5mA		0.06	0.2	V
			I _{OUT} = 10mA		0.12	0.4	
OUT Short-Circuit Current	I _{SC}	Short to GND			160		mA
		Short to IN			20		
Thermal Hysteresis (Note 4)	ΔV _{OUT} / cycle				5		ppm
Long-Term Stability	ΔV _{OUT} / time	1000hr at T _A = +25°C			11		ppm/ 1000hr
DYNAMIC CHARACTERISTICS							
Noise Voltage	e _{OUT}	f = 0.1Hz to 10Hz			1.45		μV _{P-P}
		f = 1kHz, C _{NR} = 0			75		nV/√Hz
		f = 1kHz, C _{NR} = 0.1μF			45		
Turn-On Settling Time	t _R	To V _{OUT} = 0.01% of final value	C _{NR} = 0		1		ms
			C _{NR} = 0.1μF		20		
Capacitive-Load Stability Range	C _{LOAD}	No sustained oscillations			0.1 to 10		μF
INPUT							
Supply Voltage Range	V _{IN}	Guaranteed by line-regulation test		2.7		12.6	V
Quiescent Supply Current	I _{IN}	T _A = +25°C			380	550	μA
		T _A = -40°C to +125°C				725	

Electrical Characteristics—MAX6226_50 (V_{OUT} = 5.000V)(V_{IN} = 5.5V, C_{LOAD} = 0.1μF, I_{OUT} = 0, T_A = T_{MIN} to T_{MAX}, unless otherwise noted. Typical values are at T_A = +25°C . (Note 1))

PARAMETER	SYMBOL	CONDITIONS		MIN	TYP	MAX	UNITS
OUTPUT							
Output Voltage	V _{OUT}	T _A = +25°C		5.000			V
Output Voltage Accuracy		Referred to V _{OUT} , T _A = +25°C	A grade	-0.02		+0.02	%
Output Voltage Temperature Coefficient (Note 2)	T _{CVOUT}	T _A = -40°C to +125°C	A grade		1	3	ppm/°C
Line Regulation	$\frac{\Delta V_{OUT}}{\Delta V_{IN}}$	5.2V ≤ V _{IN} ≤ 12.6V	T _A = +25°C T _A = -40°C to +125°C		9	40	μV/V
Load Regulation	$\frac{\Delta V_{OUT}}{\Delta I_{OUT}}$	Sourcing: 0 ≤ I _{OUT} ≤ 10mA Sinking: -10mA ≤ I _{OUT} ≤ 0			5	50	
Dropout Voltage (Note 3)	V _{IN} - V _{OUT}	ΔV _{OUT} = 0.1%	I _{OUT} = 5mA I _{OUT} = 10mA		0.06	0.2	V
OUT Short-Circuit Current	I _{SC}	Short to GND Short to IN			160	20	
Thermal Hysteresis (Note 4)	$\frac{\Delta V_{OUT}}{\text{cycle}}$				5		ppm
DYNAMIC CHARACTERISTICS							
Noise Voltage	e _{OUT}	f = 0.1Hz to 10Hz			2.85		μV _{P-P}
		f = 1kHz, C _{NR} = 0			145		nV/√Hz
		f = 1kHz, C _{NR} = 0.1μF			95		
Turn-On Settling Time	t _R	To V _{OUT} = 0.01% of final value	C _{NR} = 0 C _{NR} = 0.1μF		2		ms
Capacitive-Load Stability Range	C _{LOAD}	No sustained oscillations			0.1 to 10		
INPUT							
Supply Voltage Range	V _{IN}	Guaranteed by line-regulation test		5.2		12.6	V
Quiescent Supply Current	I _{IN}	T _A = +25°C T _A = -40°C to +125°C			380	580	μA
						725	

Note 1: All devices are 100% production tested at T_A = +25°C and are guaranteed by design for T_A = T_{MIN} to T_{MAX}, as specified.**Note 2:** Temperature coefficient is measured by the “box” method, i.e., the maximum ΔV_{OUT}/V_{OUT} is divided by the maximum ΔT.**Note 3:** Dropout voltage is defined as the minimum differential voltage (V_{IN} - V_{OUT}) at which V_{OUT} decreases by 0.1% from its original value at V_{IN} = 5.0V for V_{OUT} = 2.5V and V_{IN} = 5.5V for V_{OUT} = 5.0V).**Note 4:** Thermal hysteresis is defined as the change in +25°C output voltage before and after cycling the device from T_{MAX} to T_{MIN}.

Typical Operating Characteristics

($V_{IN} = 5.0V$ for $V_{OUT} = 2.5V$ and $V_{IN} = 5.5V$ for $V_{OUT} = 5.0V$, $C_{LOAD} = 0.1\mu F$, $I_{OUT} = 0$, $T_A = +25^\circ C$, unless otherwise specified.)

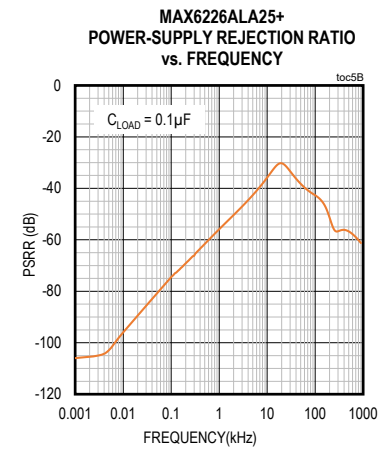
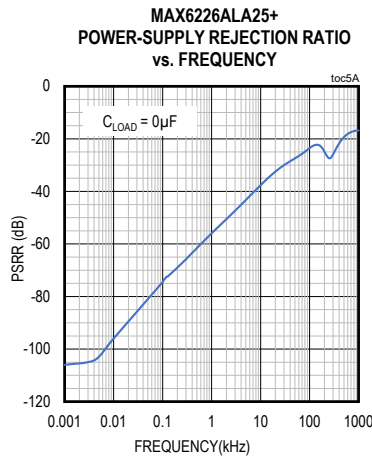
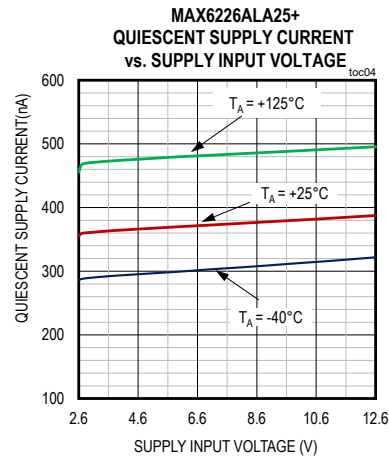
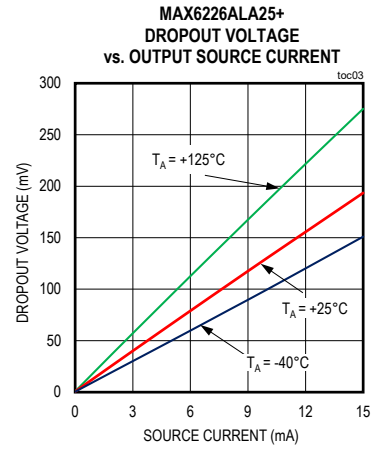
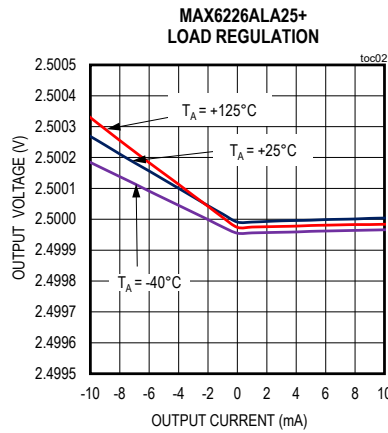
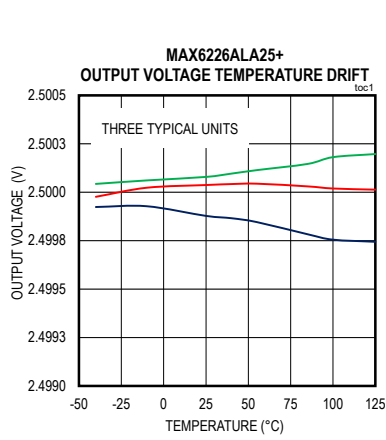

Typical Operating Characteristics (continued)

($V_{IN} = 5.0V$ for $V_{OUT} = 2.5V$ and $V_{IN} = 5.5V$ for $V_{OUT} = 5.0V$, $C_{LOAD} = 0.1\mu F$, $I_{OUT} = 0$, $T_A = +25^\circ C$, unless otherwise specified.)

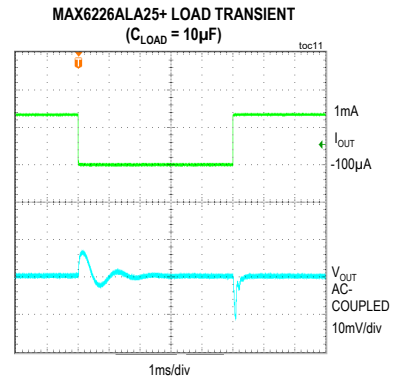
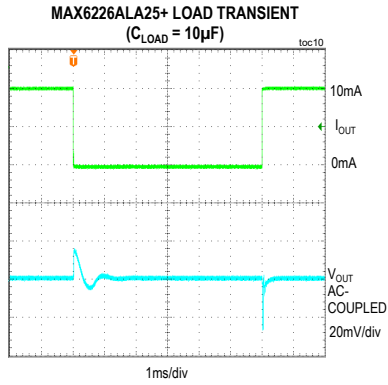
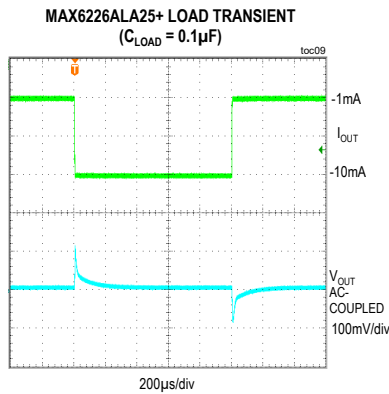
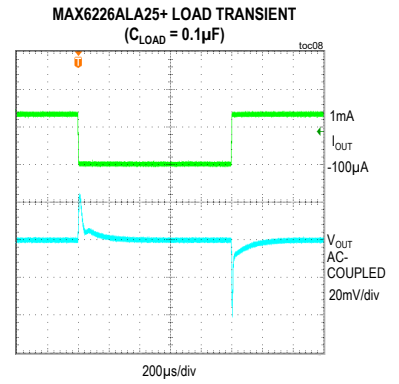
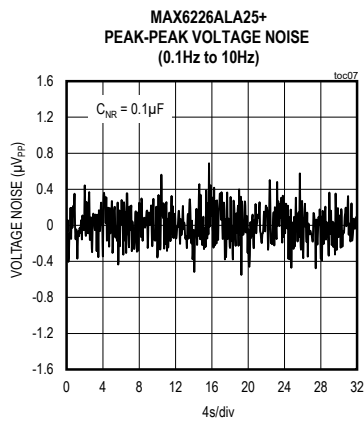
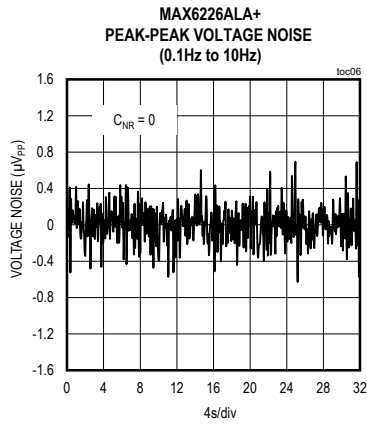

Typical Operating Characteristics (continued)

($V_{IN} = 5.0V$ for $V_{OUT} = 2.5V$ and $V_{IN} = 5.5V$ for $V_{OUT} = 5.0V$, $C_{LOAD} = 0.1\mu F$, $I_{OUT} = 0$, $T_A = +25^\circ C$, unless otherwise specified.)

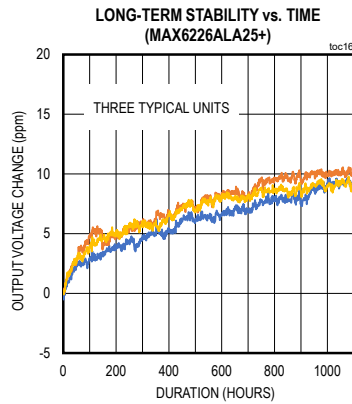
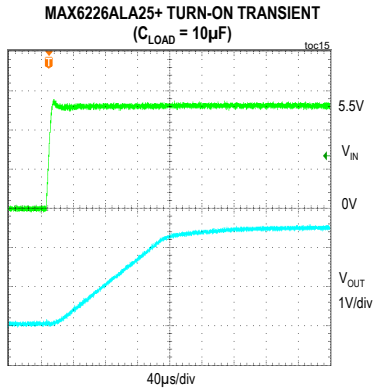
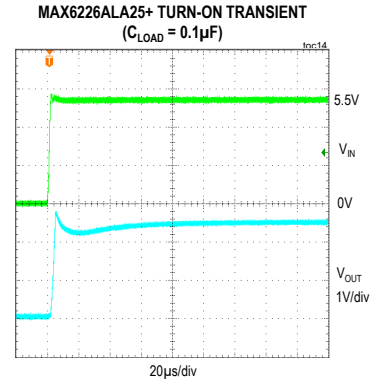
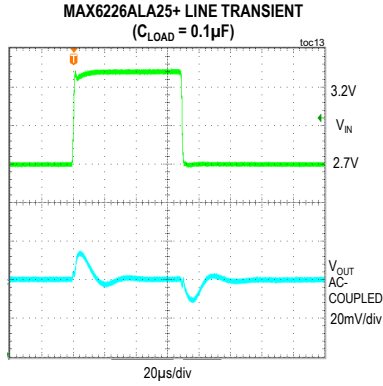
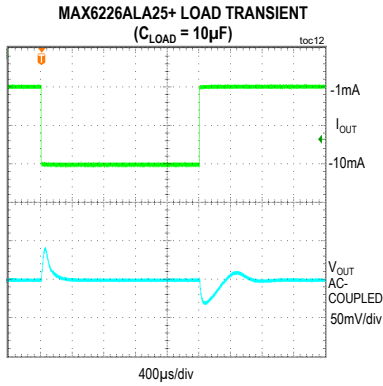

Typical Operating Characteristics

($V_{IN} = 5.0V$ for $V_{OUT} = 2.5V$ and $V_{IN} = 5.5V$ for $V_{OUT} = 5.0V$, $C_{LOAD} = 0.1\mu F$, $I_{OUT} = 0$, $T_A = +25^\circ C$, unless otherwise specified.)

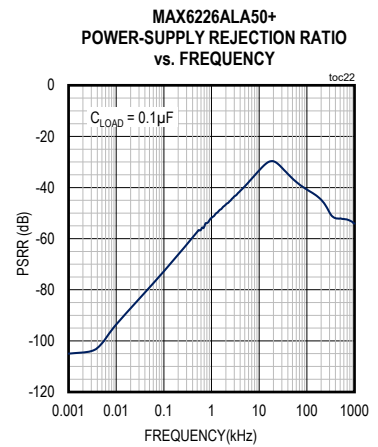
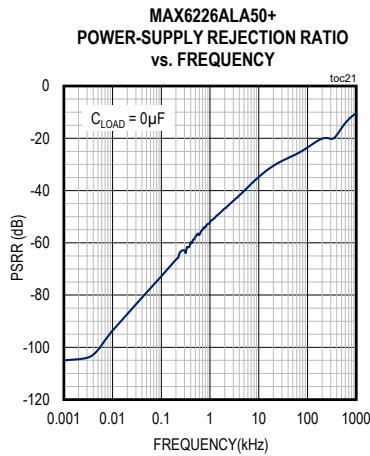
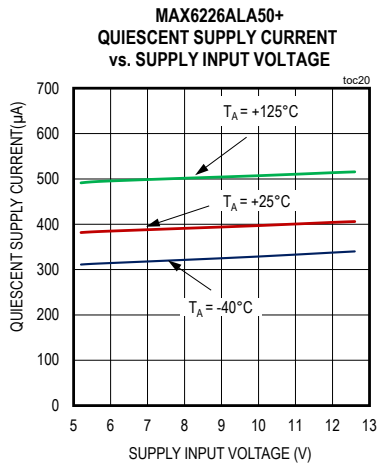
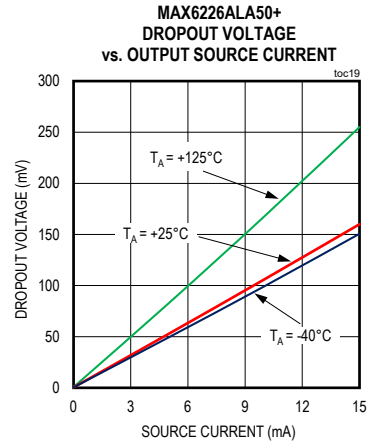
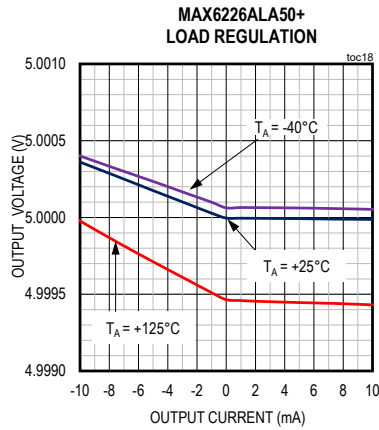
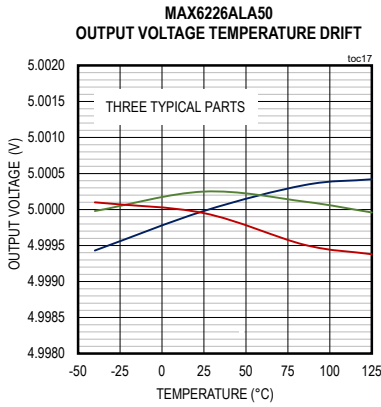

Typical Operating Characteristics (continued)

($V_{IN} = 5.0V$ for $V_{OUT} = 2.5V$ and $V_{IN} = 5.5V$ for $V_{OUT} = 5.0V$, $C_{LOAD} = 0.1\mu F$, $I_{OUT} = 0$, $T_A = +25^\circ C$, unless otherwise specified.)

MAX6226ALA50+
PEAK-PEAK VOLTAGE NOISE (0.1Hz TO 10Hz)

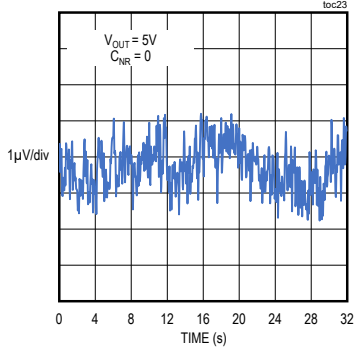

MAX6226ALA50+
PEAK-PEAK VOLTAGE NOISE (0.1Hz TO 10Hz)

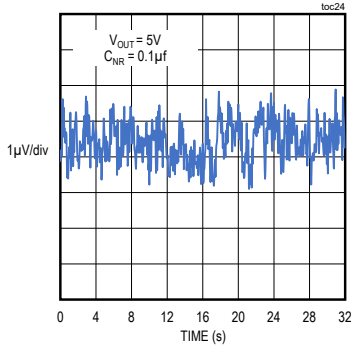

MAX6226ALA50+
LOAD TRANSIENT ($C_{LOAD} = 0.1\mu F$)

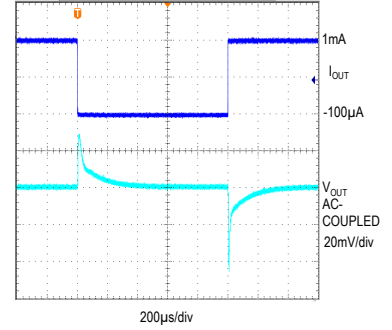

MAX6226ALA50+
LOAD TRANSIENT ($C_{LOAD} = 0.1\mu F$)

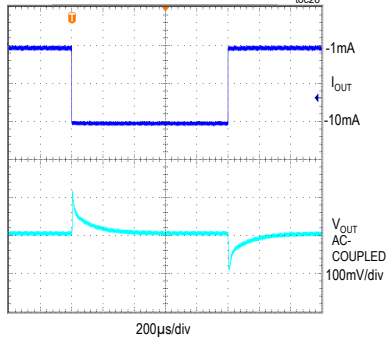

MAX6226ALA50+
LOAD TRANSIENT ($C_{LOAD} = 10\mu F$)

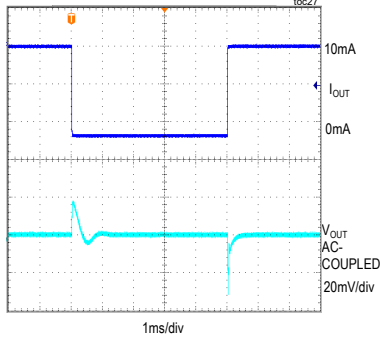

MAX6226ALA50+
LOAD TRANSIENT ($C_{LOAD} = 10\mu F$)

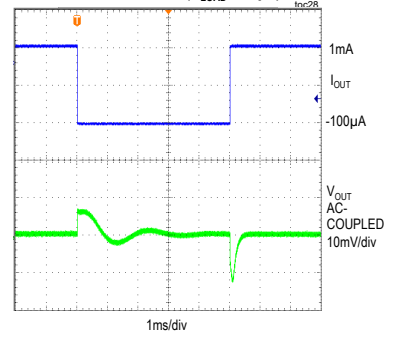

Typical Operating Characteristics (continued)

($V_{IN} = 5.0V$ for $V_{OUT} = 2.5V$ and $V_{IN} = 5.5V$ for $V_{OUT} = 5.0V$, $C_{LOAD} = 0.1\mu F$, $I_{OUT} = 0$, $T_A = +25^\circ C$, unless otherwise specified.)

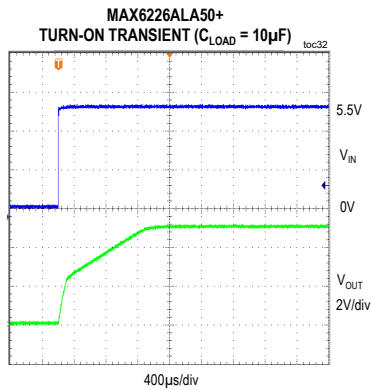
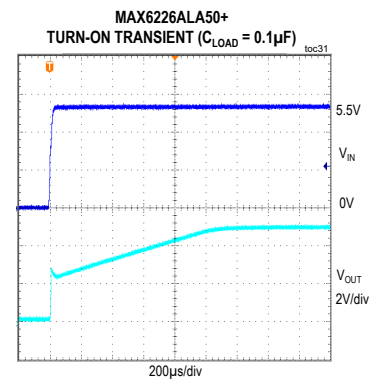
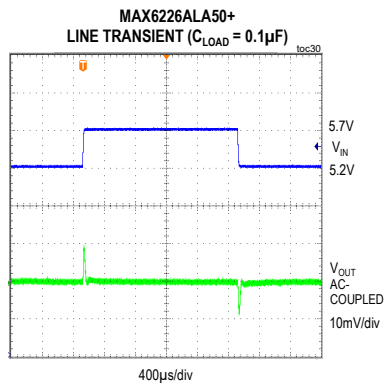
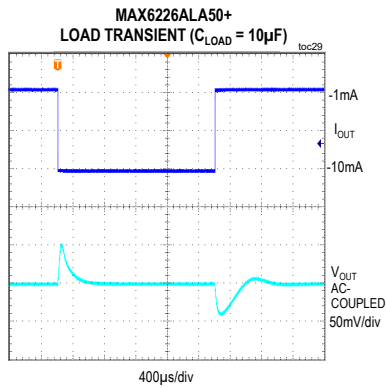

Pin Configuration

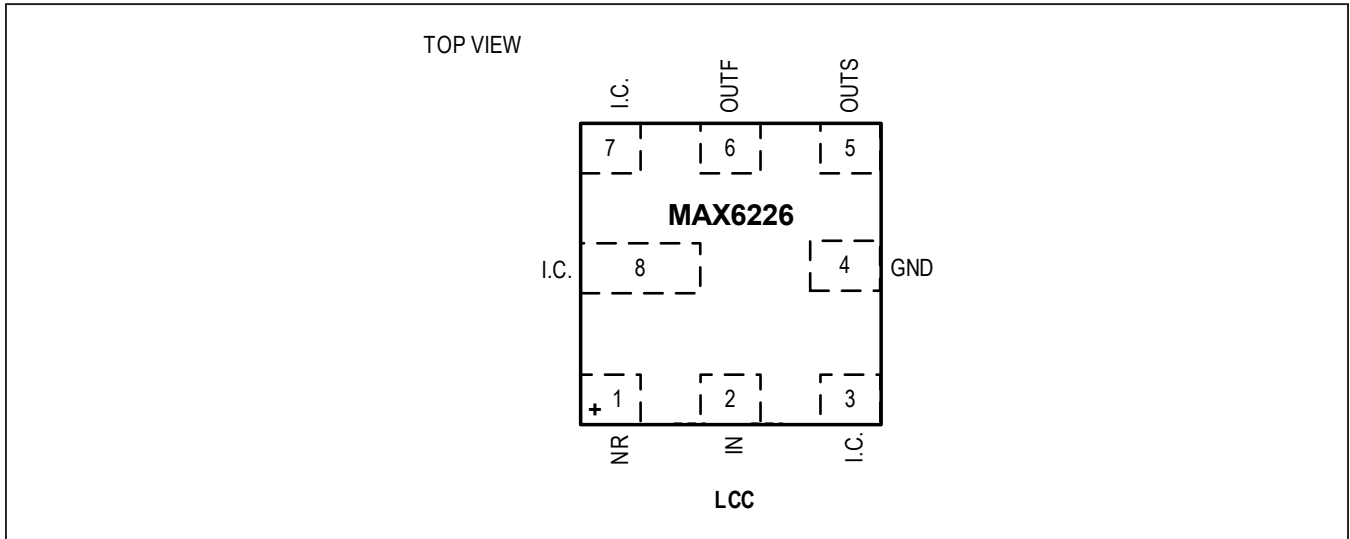

Pin Description

PIN	NAME	FUNCTION
1	NR	Noise Reduction. Connect a 0.1µF capacitor to improve wideband noise. Leave unconnected if not used (see Figure 1).
2	IN	Positive Power-Supply Input
4	GND	Ground
3, 7	I.C.	Internally Connected. Do not connect anything to these pins.
5	OUTS	Voltage Reference Sense Output
6	OUTF	Voltage Reference Force Output. Short OUTF to OUTS as close to the load as possible. Bypass OUTF with a capacitor (0.1µF to 10µF) to GND.
8	I.C.	Internally Connected. Do not connect anything to this pin (see MAX6226 in Ceramic LCC Package for more information.)

Detailed Description

Wideband Noise Reduction

To improve wideband noise and transient power-supply noise, add a $0.1\mu\text{F}$ capacitor to NR (Figure 1). A $0.1\mu\text{F}$ NR capacitor reduces the noise from $75\text{nV}/\sqrt{\text{Hz}}$ to $45\text{nV}/\sqrt{\text{Hz}}$. Noise in the power-supply input can affect output noise, but can be reduced by adding an optional bypass capacitor between IN and GND, as shown in the [Typical Operating Characteristics](#). The 0.1Hz to 10Hz noise when measured with a $0.1\mu\text{F}$ noise reduction capacitor (NR pin) is $1.45\mu\text{V}_{\text{p-p}}$.

Output Bypassing

The MAX6226 requires an output capacitor between $0.1\mu\text{F}$ and $10\mu\text{F}$. Locate the output capacitor as close to OUTF as possible. For applications driving switching capacitive loads or rapidly changing load currents, it is advantageous to use a $10\mu\text{F}$ capacitor in parallel with a $0.1\mu\text{F}$ capacitor. Larger capacitor values reduce transients on the reference output.

Supply Current

The quiescent supply current of the series-mode MAX6226 family is typically $380\mu\text{A}$ and is virtually independent of the supply voltage, with only a $2\mu\text{A}/\text{V}$ (max) variation with supply voltage.

When the supply voltage is below the minimum specified input voltage during turn-on, the device can draw up to $300\mu\text{A}$ beyond the nominal supply current. The input voltage source must be capable of providing this current to ensure reliable turn-on.

Thermal Hysteresis

Thermal hysteresis is the change of output voltage at $T_A = +25^\circ\text{C}$ before and after the device is cycled over its entire operating temperature range. The typical thermal hysteresis value is 5ppm .

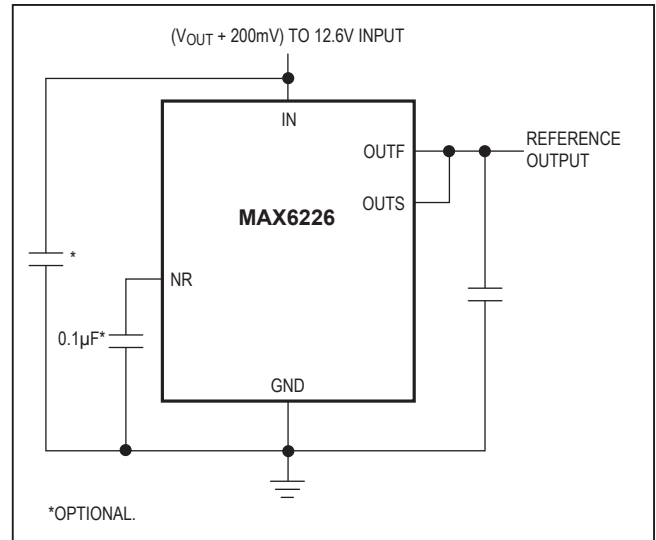

Figure 1. Noise-Reduction Capacitor

Turn-On Time

These devices typically turn on and settle to within 0.1% of their final value in $200\mu\text{s}$ to 2ms depending on the device. The turn-on time can increase up to 4ms with the device operating at the minimum dropout voltage and the maximum load. A noise reduction capacitor of $0.1\mu\text{F}$ increases the turn-on time to 20ms .

Output Force and Sense

The MAX6226 provides independent connections for the power-circuit output (OUTF) supplying current into a load, and for the circuit input regulating the voltage applied to that load (OUTS). This configuration allows for the cancellation of the voltage drop on the lines connecting the MAX6226 and the load. When using the Kelvin connection made possible by the independent current and voltage connections, take the power connection to the load from OUTF, and bring a line from OUTS to join the line from OUTF, at the point where the voltage accuracy is needed.

Applications Information

Precision Current Source

Figure 2 shows a typical circuit providing a precision current source. The OUTF output provides the bias current for the bipolar transistor. OUTS and GND sense the voltage across the resistor and adjust the current sourced by OUTF accordingly. For even higher precision, use a MOSFET to eliminate base current errors.

The voltage range of OUTF is set by the reference output voltage (OUTS) and the V_{BE} (BJT) or V_{GS} (MOS) of the output external device:

$$V_{OUTF} = V_{BE} + V_{REF}$$

where:

V_{OUTF} is voltage on OUTF pin

V_{BE} is base-emitter drop across BJT

V_{REF} is the actual voltage reference output this part is supposed to provide.

It translates to supply voltage requirement for voltage reference:

$$V_{IN} \geq V_{DROP} \text{ (dropout voltage)} + V_{BE_{max}} + V_{REF}$$

where:

V_{DROP} is dropout voltage of voltage reference

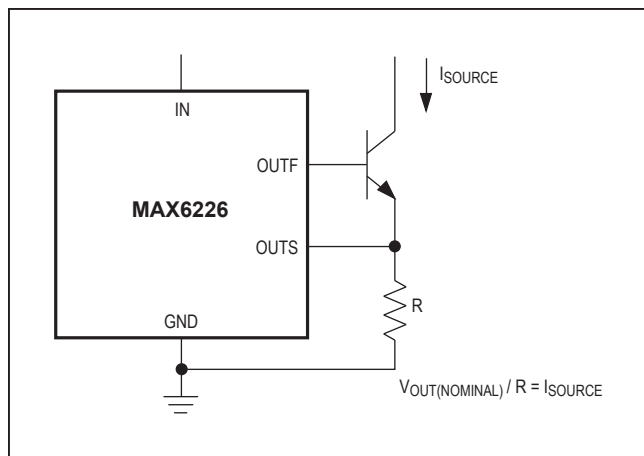

Figure 2. Precision Current Source

High-Resolution DAC and Reference from a Single Supply

Figure 3 shows a typical circuit providing the reference for a high-resolution, 16-bit MAX541 digital-to-analog converter.

Temperature Coefficient vs. Operating Temperature Range for a 1 LSB Maximum Error

In a data converter application, the reference voltage of the converter must stay within a certain limit to keep the error in the data converter smaller than the resolution limit through the operating temperature range. Figure 4 shows the maximum allowable reference voltage temperature coefficient to keep the conversion error to less than 1 LSB, as a function of the operating temperature range ($T_{MAX} - T_{MIN}$) with the converter resolution as a parameter. The graph assumes the reference voltage temperature coefficient as the only parameter affecting accuracy.

In reality, the absolute static accuracy of a data converter is dependent on the combination of many parameters such as integral nonlinearity, differential nonlinearity, offset error, gain error, as well as voltage reference changes.

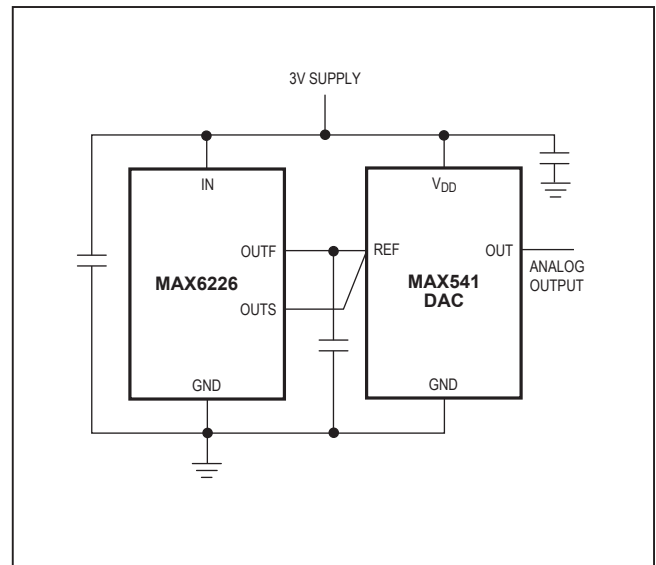

Figure 3. 14-Bit High-Resolution DAC and Positive Reference from a Single 3V Supply

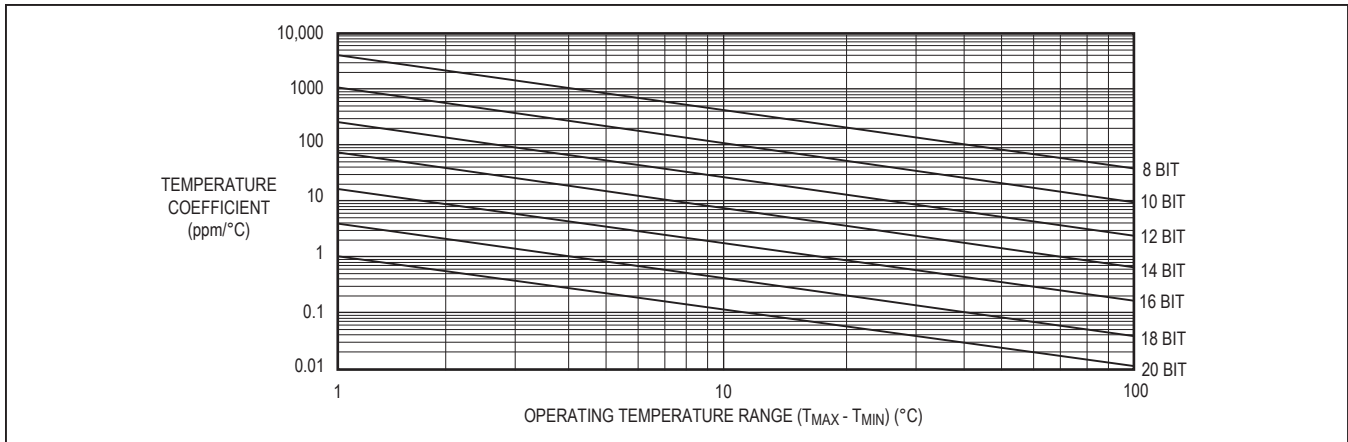

Figure 4. Temperature Coefficient vs. Operating Temperature Range for a 1 LSB Maximum Error

MAX6226 in Ceramic LCC Package

The MAX6226’s ceramic LCC package is a hermetic package that gives substantially better performance than plastic packages, while maintaining a small, surface-mount form factor. Conventional plastic packages are affected by humidity, stressing the die and cause the voltage reference’s output to vary as humidity changes. The MAX6226’s ceramic package eliminates this effect. In addition, the package reduces stress on the die that changes with time, thereby dramatically improving long-term drift. The MAX6226 exhibits excellent output voltage long-term drift performance (11ppm, typ), as illustrated in the *Long-Term Stability vs. Time* plot in the [Typical Operating Characteristics](#).

The ceramic package also enables the MAX6226 to exhibit improved thermal hysteresis. Thermal hysteresis is the change in the reference’s output voltage at +25°C as a result of being cycled over its full operating temperature range. The MAX6226 has a typical hysteresis value of 5ppm.

Note that although the MAX6226’s ceramic package prevents the output voltage from being affected by mechanical stresses due to humid environments, the PC board may be affected by humidity, and may in turn cause mechanical stress to the MAX6226 mounted on it. Take extra care with PC board layout. Power and ground planes should be avoided under the voltage reference IC for best stability. Closely follow the layout guidelines in the Output Bypassing and Output Force and Sense.

Pin 8 must be clear of any mechanical and electrical contact. Neither copper nor solder/paste mask must be placed underneath its land pattern. The absence of the mechanical contact will eliminate the possibility of paddle induced stress to the die. The absence of electrical contact will eliminate the possibility of any ground current redistribution.

Chip Information

PROCESS: BiCMOS

Ordering Information

PART	TEMP RANGE	PIN-PACKAGE	OUTPUT VOLTAGE (V)	MAXIMUM INITIAL ACCURACY (%)	MAXIMUM TEMPCO (-40°C to +125°C) (ppm/°C)
MAX6226ALA25+T	-40°C to +125°C	8LCC	2.500	0.02	3
MAX6226ALA50+T	-40°C to +125°C	8LCC	5.000	0.02	3

+Denotes a lead(Pb)-free/RoHS-compliant package.
T = Tape and reel.

Revision History

REVISION NUMBER	REVISION DATE	DESCRIPTION	PAGES CHANGED
0	12/18	Initial release	—
1	4/19	Correct LTD typical number	1, 3, 10
2	9/19	Updated <i>Pin Configuration</i> diagram and <i>Pin Description</i> table	7
3	11/19	Updated <i>MAX6226 in Ceramic LCC Package</i> section	10
4	12/19	Updated <i>Pin Description</i> table	7
5	1/20	Added $V_{OUT} = 5.000V$ <i>Electrical Characteristics</i> table and <i>Typical Operating Characteristics</i>	3, 7–10
6	11/20	Updated <i>General Description, Benefits and Features, Electrical Characteristics—MAX6226_25 ($V_{OUT} = 2.500V$), Electrical Characteristics—MAX6226_50 ($V_{OUT} = 5.000V$), and Ordering Information</i>	1, 3, 4, 14

For pricing, delivery, and ordering information, please visit Maxim Integrated's online storefront at <https://www.maximintegrated.com/en/storefront/storefront.html>.

Maxim Integrated cannot assume responsibility for use of any circuitry other than circuitry entirely embodied in a Maxim Integrated product. No circuit patent licenses are implied. Maxim Integrated reserves the right to change the circuitry and specifications without notice at any time. The parametric values (min and max limits) shown in the *Electrical Characteristics* table are guaranteed. Other parametric values quoted in this data sheet are provided for guidance.