

Withwave's Board Edge 2.92 mm connectors are specially designed for high frequency substrates to minimize electromagnetic transition effects from coaxial to Microstrip/CPW structure. We solve your performance and cost problems.

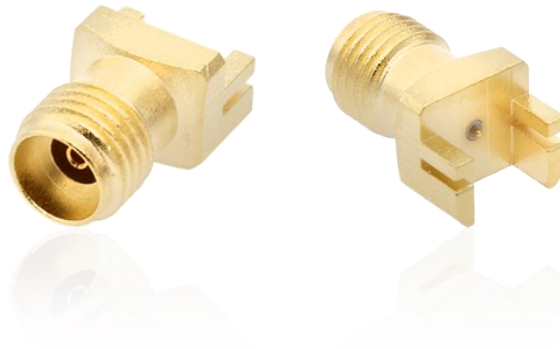

■ Features

- DC to 40 GHz
- Board Clearance : 0.6, 0.8, 1.0, 1.1, 1.2, 1.5, 1.6, 1.7, 2.1, 2.3 & 3.6 mm
- Easy Installation on designed substrate

■ Application

- RFIC Chip set evaluation board
- High data rate ASIC and SoC evaluation module test
- Substrate Characterization



■ Design Assistance

- 3D Model for Mechanical Layout (STEP file)
- **ANSYS HFSS models** (version 17.0 or newer) for 3D EM(Electromagnetic) Simulation

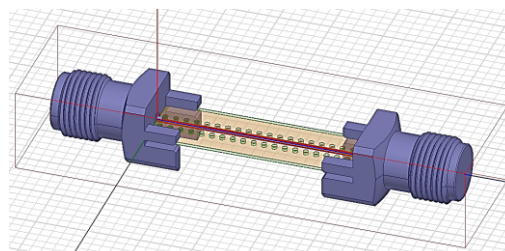
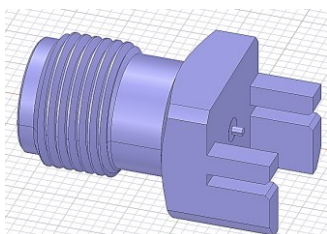

■ Specification

Scope	Items	Specification
Electrical	Freq. range	DC to 40 GHz
	Impedance	50 Ohm
	VSWR(Max)	1.20 : 1 (30 GHz) 1.40 : 1 (40 GHz)
Material	Connector type	2.92 mm(Female)
	Body	Brass (gold pated)
	Contact	BeCu (gold plated)

* RoHS Compliant

■ Ordering Information

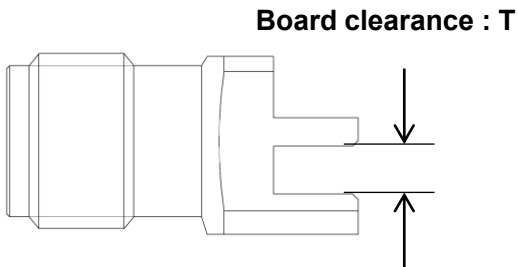

Board Clearance (T : mm)	Part No.
0.6	SM03FS007
0.8	SM03FS008
1.0	SM03FS009
1.1	SM03FS010
1.2	SM03FS011
1.5	SM03FS012
1.6	SM03FS013
1.7	SM03FS014
2.1	SM03FS015
2.3	SM03FS016
3.6	SM03FS017

■ Installation Procedure

STEP 1 :

Insert Board Edge 2.92 mm connector at the edge position of substrate.



STEP 2 :

Make sure contact pin is aligned with the center of the signal trace. and, solder contact pin on the signal trace and two legs on the ground plane while ensuring the connector is held in the correct position.

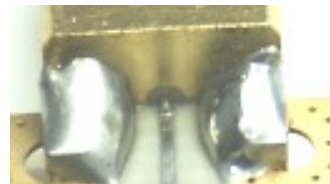
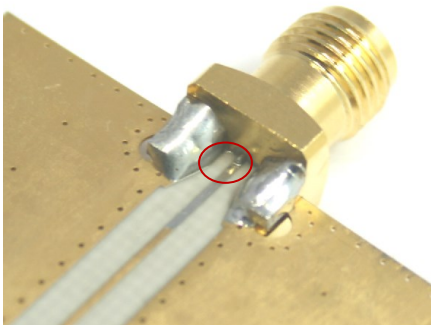

STEP 3 :

Solder two legs and connector body on the back side of substrate (ground plane) to improve RF performance. Remove any excess solder and clean all flux and other residues from trace area.

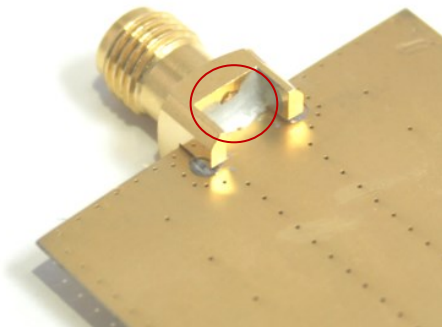

Measurement data

Microstrip type

Freq. : 10 MHz to 40 GHz

Substrate : RO4003C (8 mil)

Part No. : SM03FS007

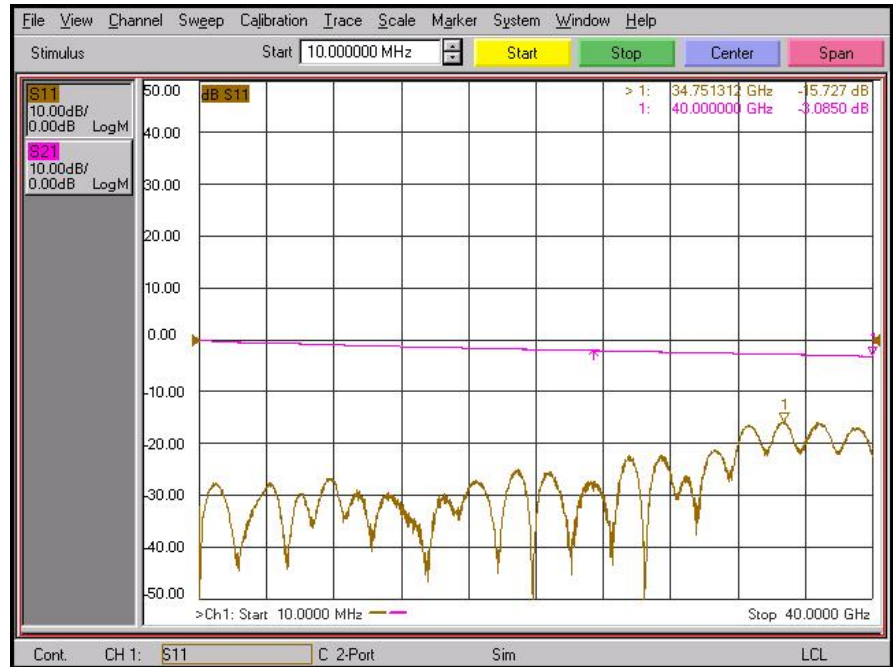
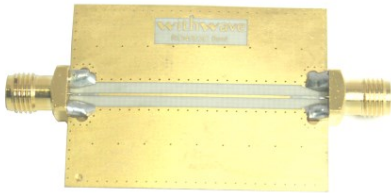

Freq. : 10 MHz to 40 GHz

Substrate : RO4003C (12 mil)

Part No. : SM03FS007

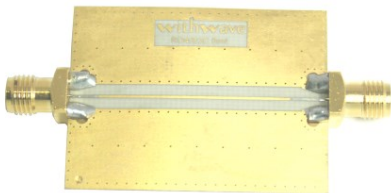

Measurement data

Microstrip type

Freq. : 10 MHz to 40 GHz

Substrate : RO4350B (10 mil)

Part No. : SM03FS007

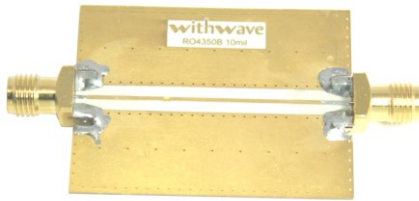

Freq. : 10 MHz to 40 GHz

Substrate : Du5880 (5 mil)

Part No. : SM03FS007



Measurement data

Microstrip type

Freq. : 10 MHz to 40 GHz

Substrate : Du5880 (10 mil)

Part No. : SM03FS007

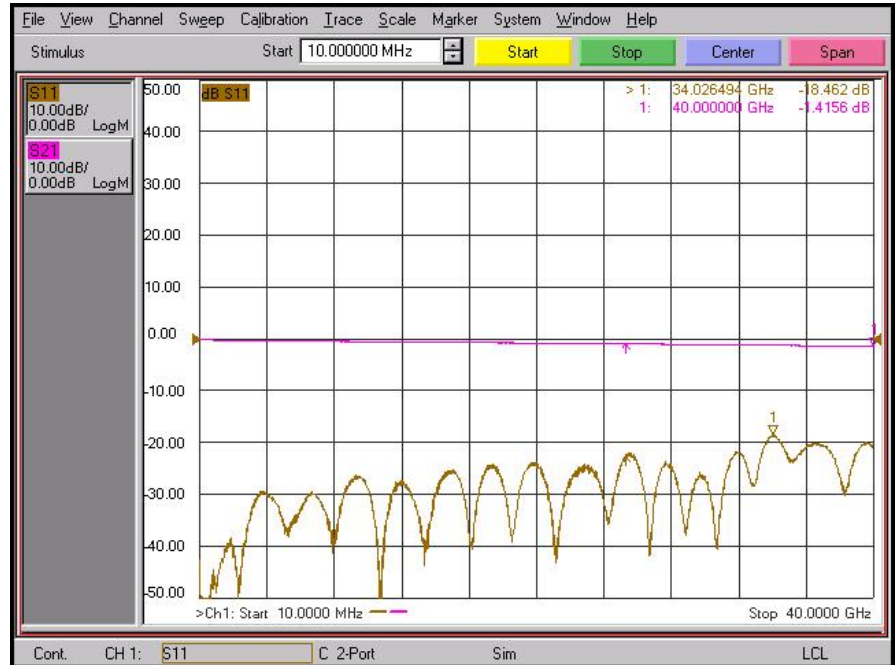

Measurement data

Top Ground Microstrip type

Freq. : 10 MHz to 40 GHz



Substrate : RO4003C (8 mil)

Part No. : SM03FS007



GCPWG type

Freq. : 10 MHz to 40 GHz

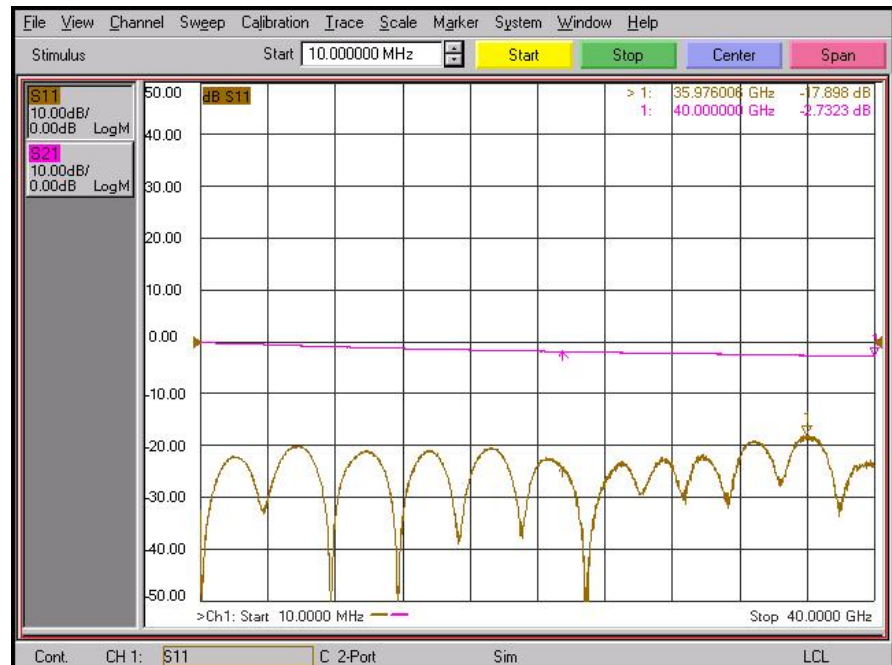

Substrate : RO4003C (8 mil)

Part No. : SM03FS007



Measurement data

Multilayer PCB (RO4003C 8 mil + FR4)

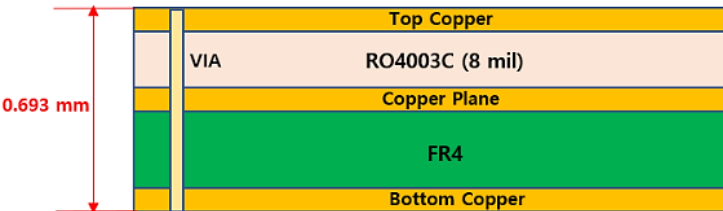

RO4003C (8 mil)
FR4

GCPWG type

Freq. : 10 MHz to 40 GHz

Substrate : RO4003C (8 mil)+FR4

Part No. : SM03FS007

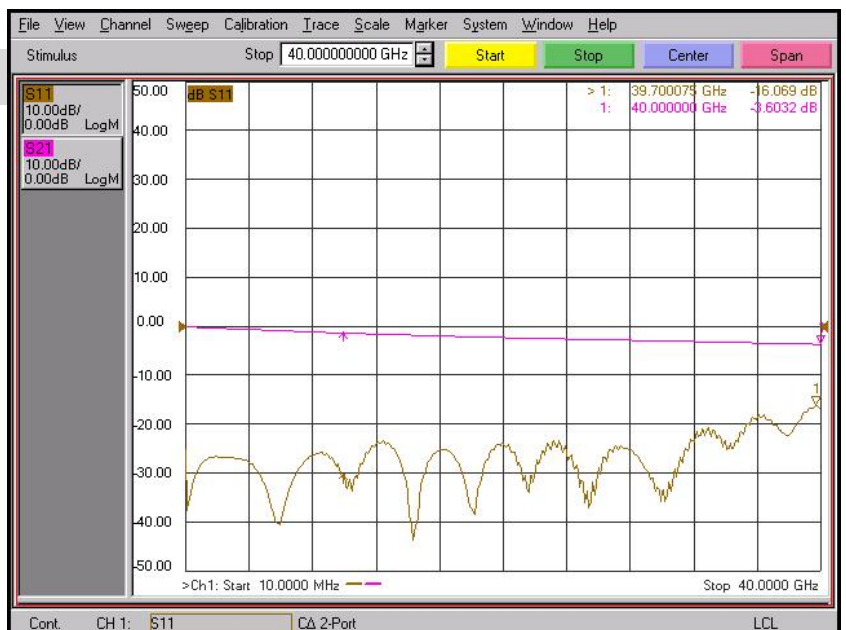

■ Drawing

Unit : mm

Board Clearance (T : mm)	Part No.
0.6	SM03FS007
0.8	SM03FS008
1.0	SM03FS009
1.1	SM03FS010
1.2	SM03FS011
1.5	SM03FS012
1.6	SM03FS013
1.7	SM03FS014
2.1	SM03FS015
2.3	SM03FS016

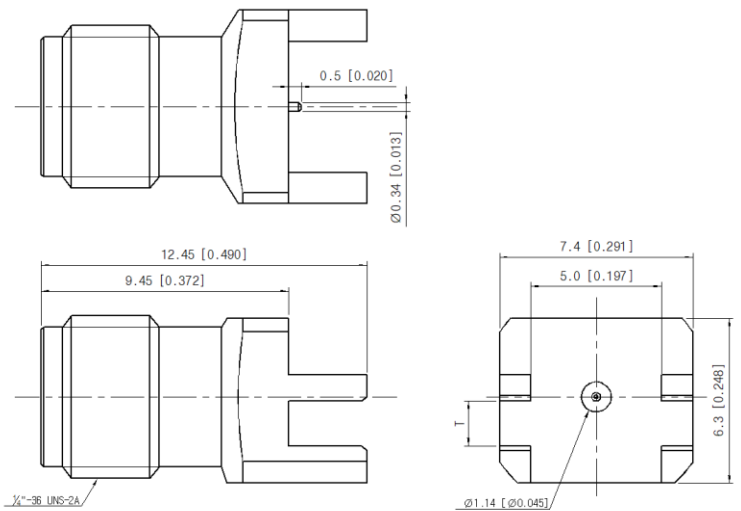

Unit : mm

Board Clearance (T : mm)	Part No.
3.6	SM03FS017

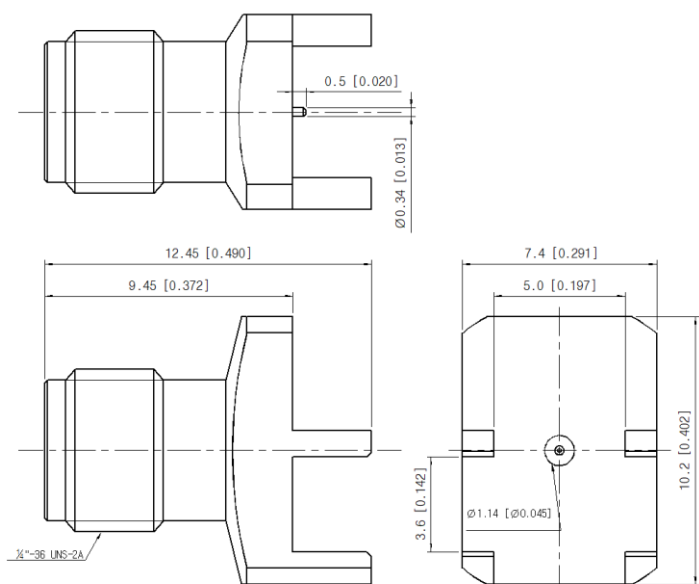

■ Recommended Patten

RO4003C 8 mil Microstrip type

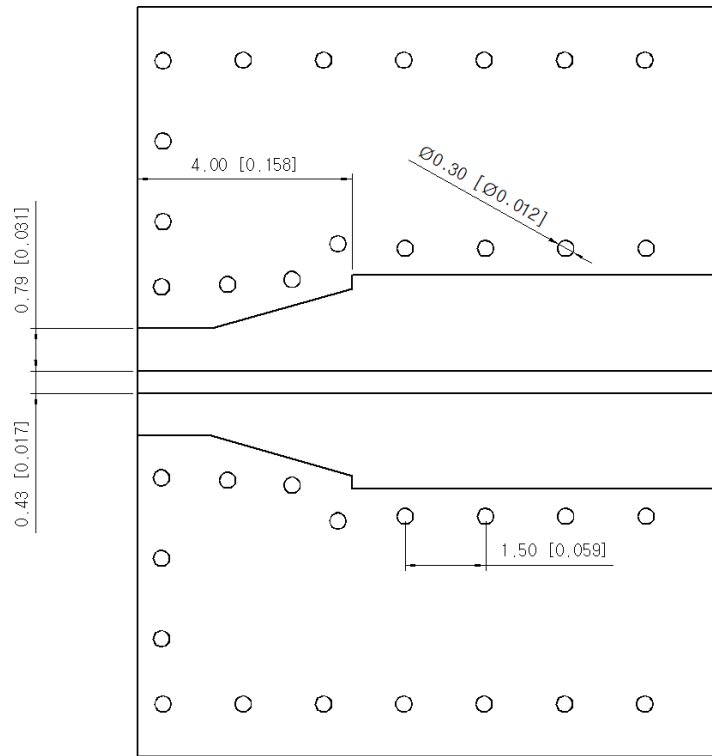

RO4003C 12 mil Microstrip type

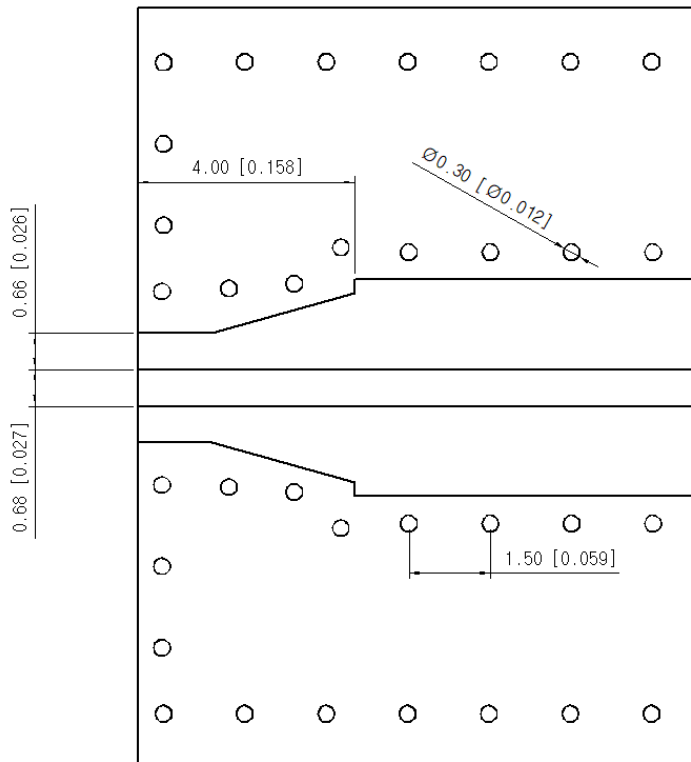

■ Recommended Patten

RO4350B 10 mil Microstrip type

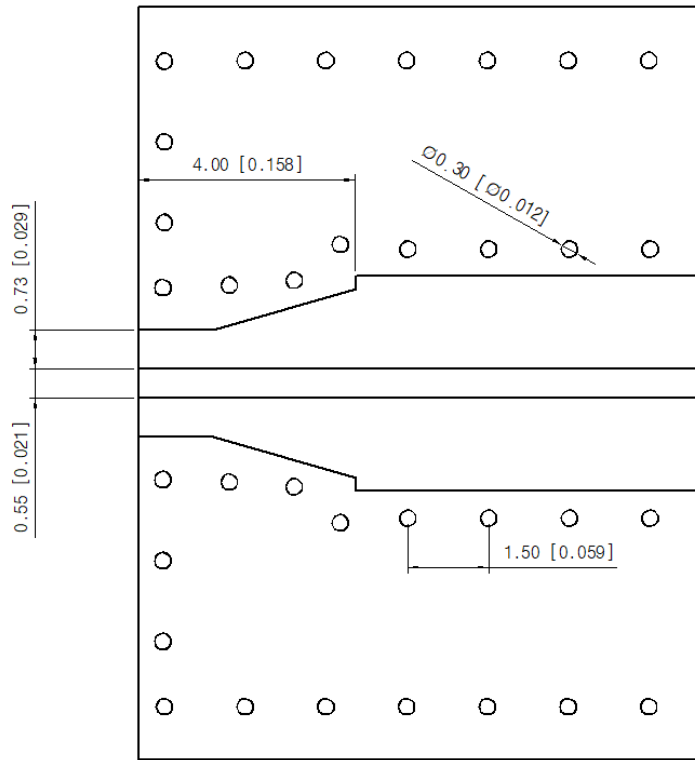

Du5880 5 mil Microstrip type

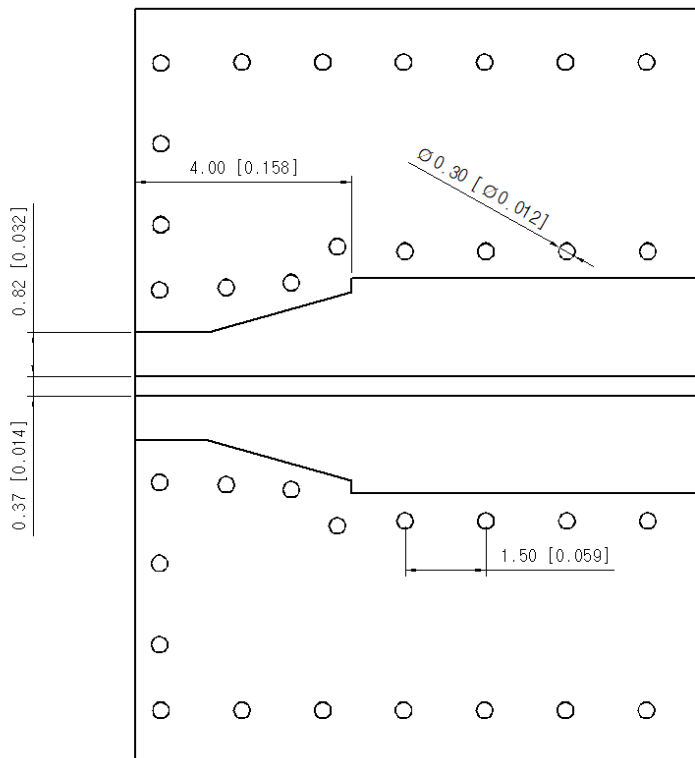

■ Recommended Patten

Du5880 10 mil Microstrip type

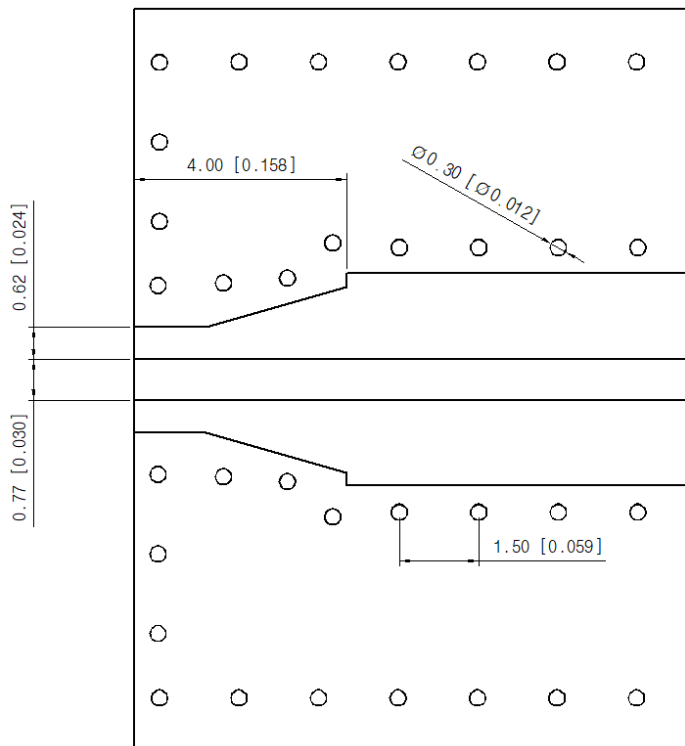

■ Recommended Patten

RO4003C 8 mil Top Ground Microstrip

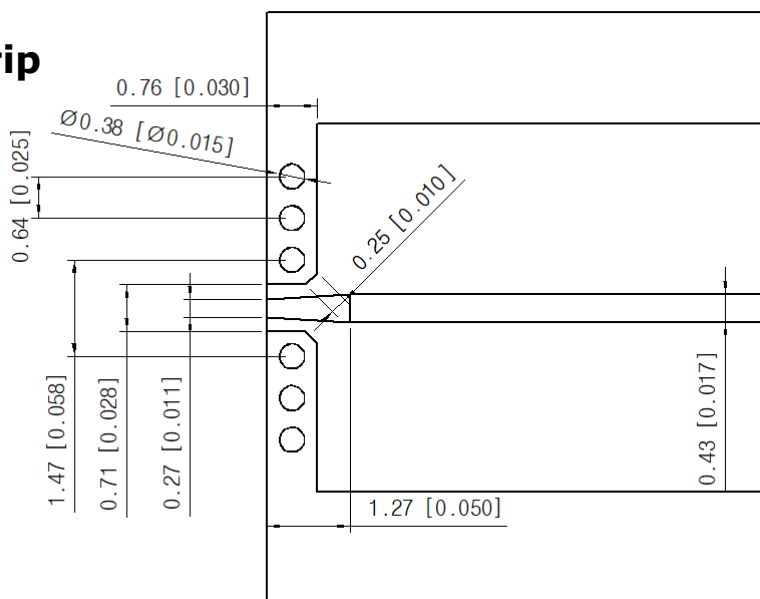

RO4003C 8 mil GCPWG

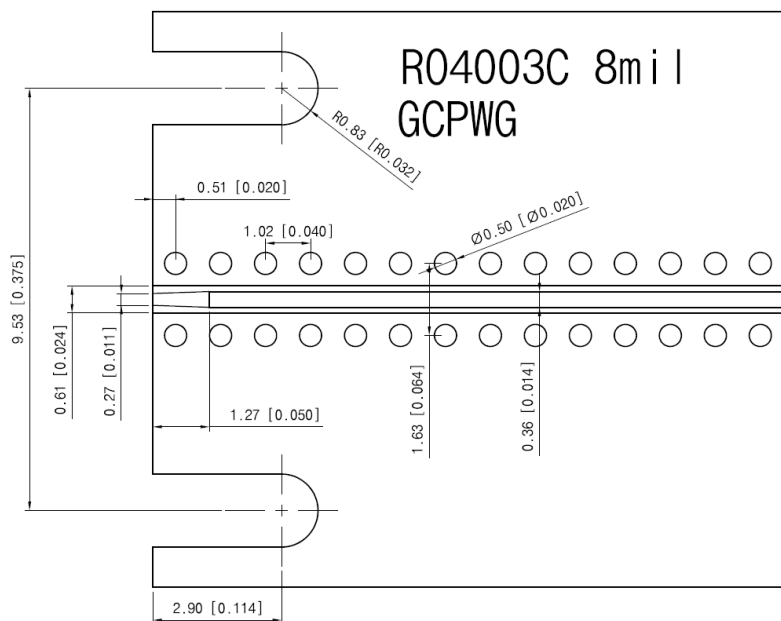

■ Revision History

Revision	Date	Changes
Ver 1.0	2018-11-15	Release Board Edge 2.92 mm Connectors
Ver 1.1	2019-12-03	Revised drawing
Ver 1.2	2020-03-01	Add Design Assistance for ANSYS HFSS 3D Simulation model
Ver 1.3	2020-11-05	Add Test Result on Multilayer PCB