

Features

- Fundamental Image Reject Mixer
- 7.0 dB Conversion Loss
- 20.0 dB Image Rejection
- +24 dBm Input Third Order Intercept
- 100% On-Wafer RF Testing
- 100% Visual Inspection to MIL-STD-883 Method 2010
- RoHS* Compliant and 260°C Reflow Compatible

Description

M/A-COM Tech's 34.0-46.0 GHz GaAs MMIC fundamental image reject mixer can be used as an up- or down-converter. The device has a conversion loss of 7.0 dB with a 20.0 dB image rejection across the band. I and Q mixer outputs are provided and an external 90 degree hybrid is required to select the desired sideband. This MMIC uses M/A-COM Tech's GaAs PHEMT device model technology, and is based upon electron beam lithography to ensure high repeatability and uniformity. The chip has surface passivation to protect and provide a rugged part with backside via holes and gold metallization to allow either a conductive epoxy or eutectic solder die attach process. This device is well suited for Millimeter-wave Point-to-Point Radio, LMDS, SATCOM and VSAT applications.

Chip Device Layout

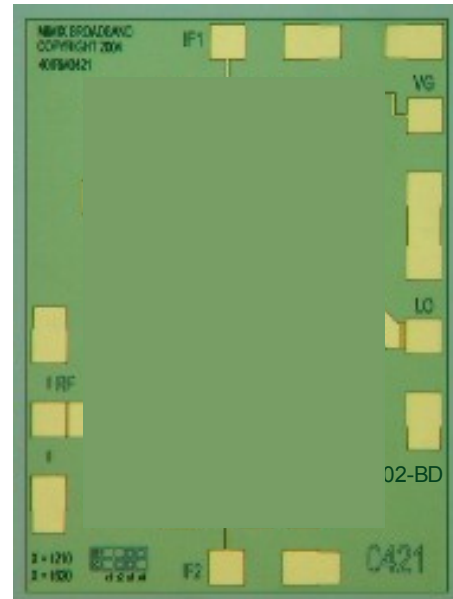

Absolute Maximum Ratings

Parameter	Absolute Max.
Gate Bias Voltage (Vg)	+0.3 VDC
Input Power (RF Pin)	+20.0 dBm
Input Power (IF Pin)	+20.0 dBm
Storage Temperature (Tstg)	-65 °C to +165 °C
Operating Temperature (Ta)	-55 °C to +125 °C

Ordering Information

Part Number	Package
XM1002-BD-000V	"V" - vacuum release gel paks
XM1002-BD-EV1	evaluation module

Electrical Specifications: 34-46 GHz (Upper Side Band) (Ambient Temperature T = 25°C)

Parameter	Units	Min.	Typ.	Max.
Frequency Range (RF) Lower Side Band	GHz	34.0	-	46.0
Frequency Range (LO)	GHz	30.0	-	50.0
Frequency Range (IF)	GHz	DC	-	4.0
RF Return Loss (S11)	dB	-	18.0	-
IF Return Loss (S22)	dB	-	10.0	-
LO Return Loss (S33)	dB	-	8.0	-
Conversion Loss (S21)	dB	-	7.0	8.0
LO Input Drive (P _{LO})	dBm	-	+12.0	-
Image Rejection	dBc	15.0	20.0	-
Isolation LO/RF	dB	-	11.0	-
Isolation LO/IF	dB	-	30.0	-
Isolation RF/IF	dB	-	30.0	-
Input Third Order Intercept (IIP3)	dBm	-	+24.0	-
Gate Bias Voltage (Vg1)	VDC	-2.0	-0.5	+0.1

Handling Procedures

Please observe the following precautions to avoid damage:

Static Sensitivity

Gallium Arsenide Integrated Circuits are sensitive to electrostatic discharge (ESD) and can be damaged by static electricity. Proper ESD control techniques should be used when handling these class 2 devices.

Typical Performance Curves

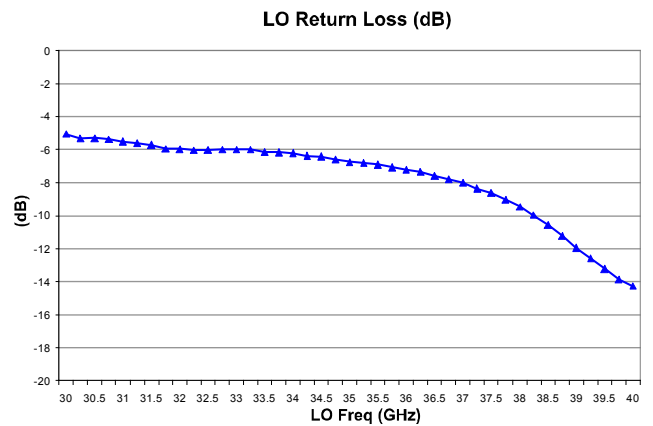
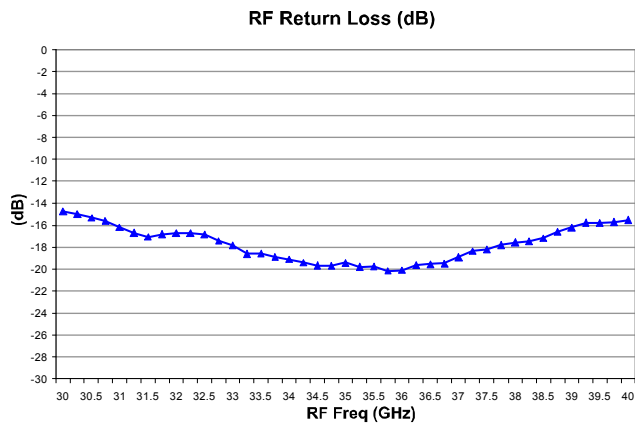
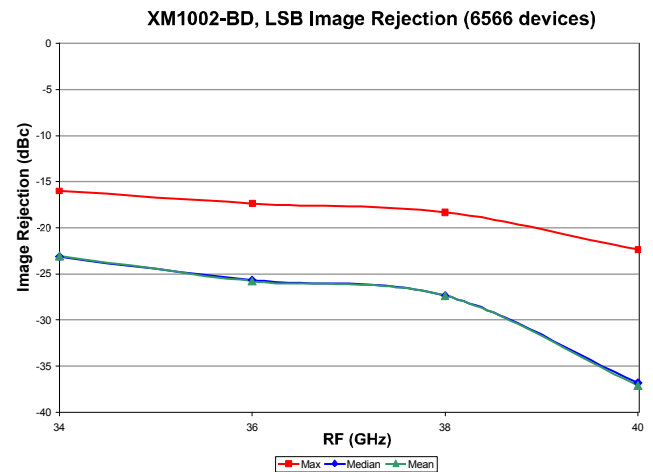
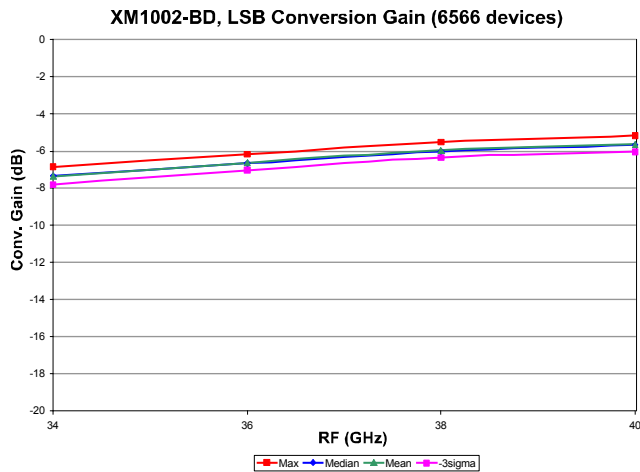
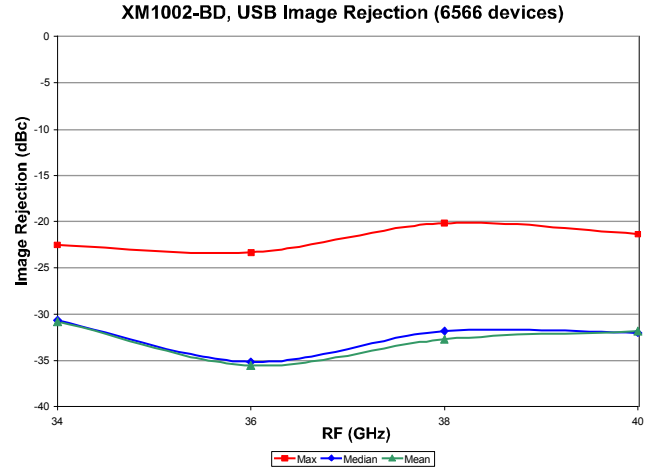
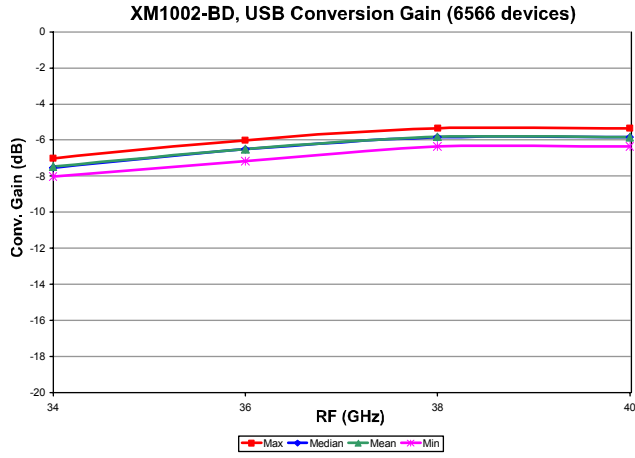

Typical Performance Curves (cont.)

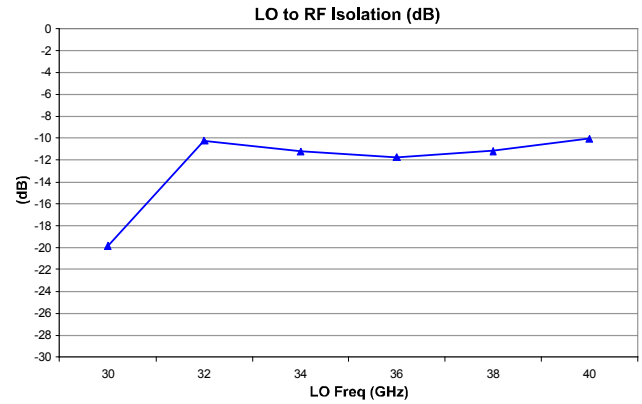
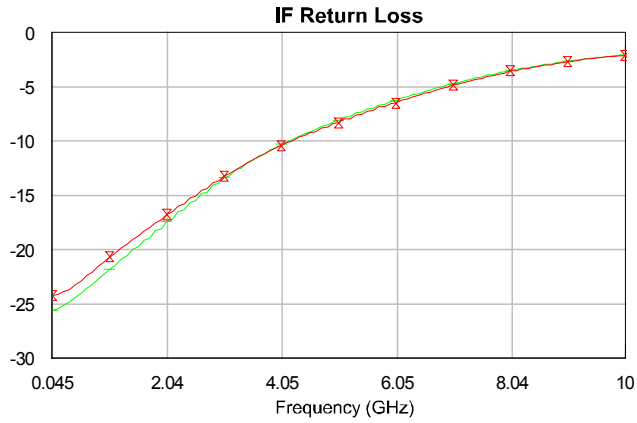
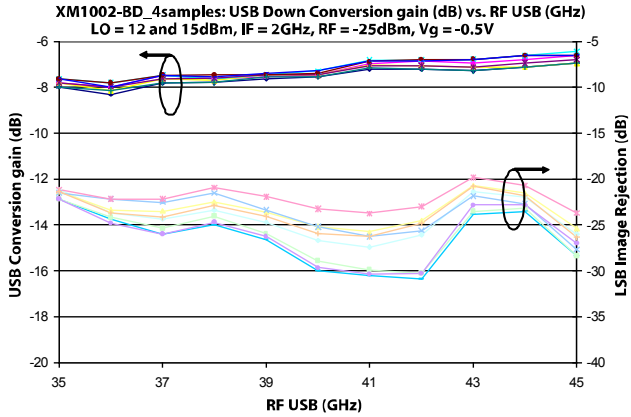

Image Reject Mixer 34 - 46 GHz

Rev. V1

Typical Performance Curves (cont.)



IF=2 GHz

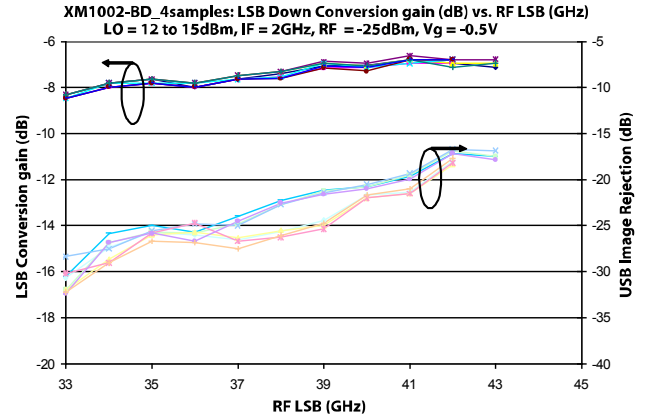

IF=2 GHz

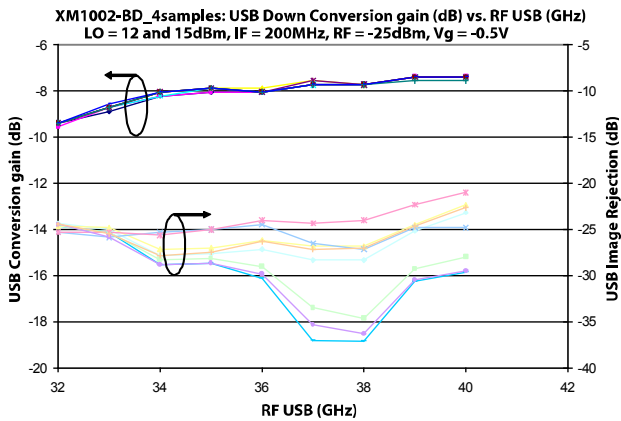

IF=200 MHz

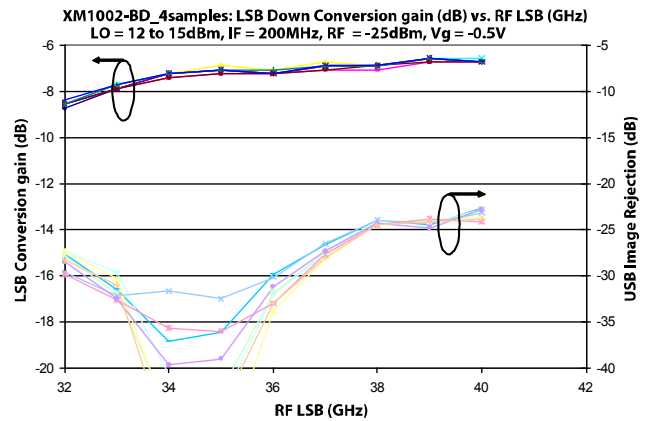

IF=200 MHz

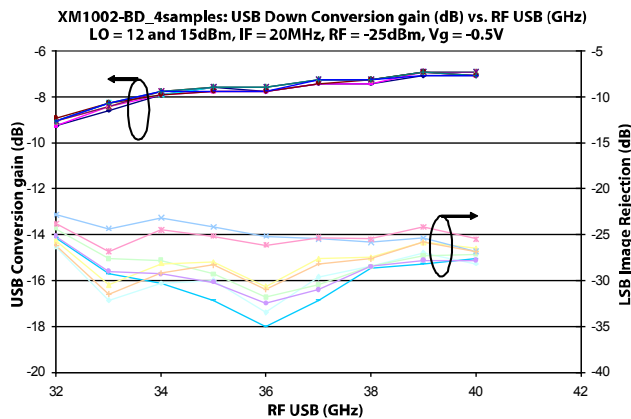

IF=20 MHz

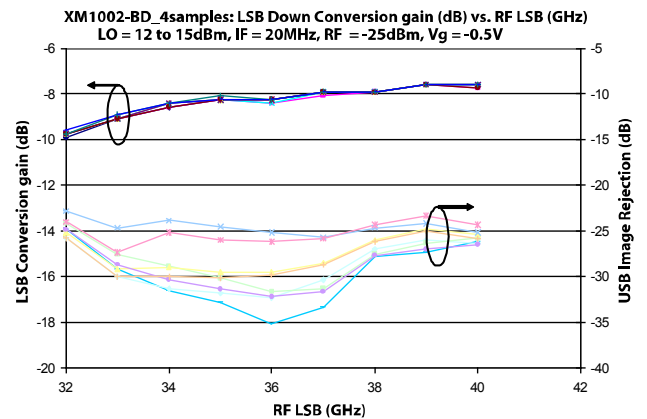

IF=20 MHz

Image Reject Mixer 34 - 46 GHz

Rev. V1

Typical Performance Curves (cont.)

XM1002-BD_4samples: USB Down Conversion gain (dB) vs. RF USB (GHz)
LO = 12 and 15dBm, IF = 2GHz, RF = -25dBm, Vg = -0.5V

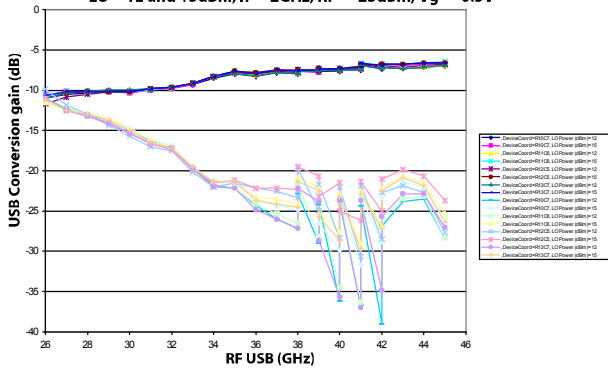

XM1002-BD_4samples: LSB Down Conversion gain (dB) vs. RF LSB (GHz)
LO = 12 to 15dBm, IF = 2GHz, RF = -25dBm, Vg = -0.5V

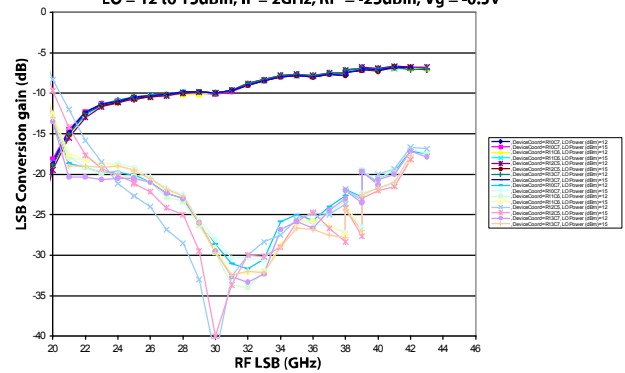

XM1002-BD_3_samples: IIP3 (dBm) in USB down-conversion vs. RF freq
LO = 15dBm, IF = 2GHz, IFout = -14dBm per Tone, 100MHz separation, Vg = -0.8V

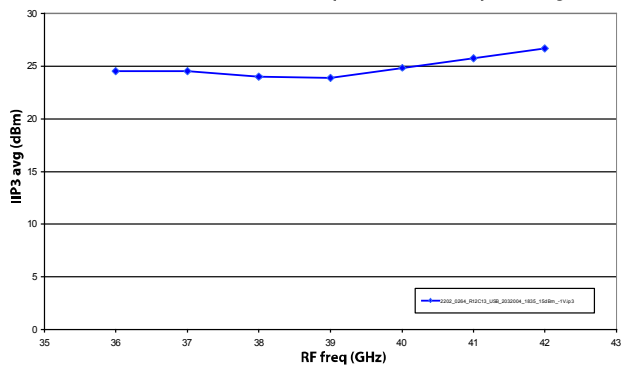

LO to IF Isolation (dB)

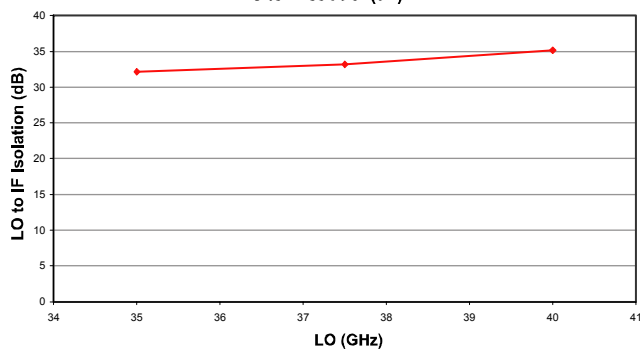

RF to IF Isolation (dB)

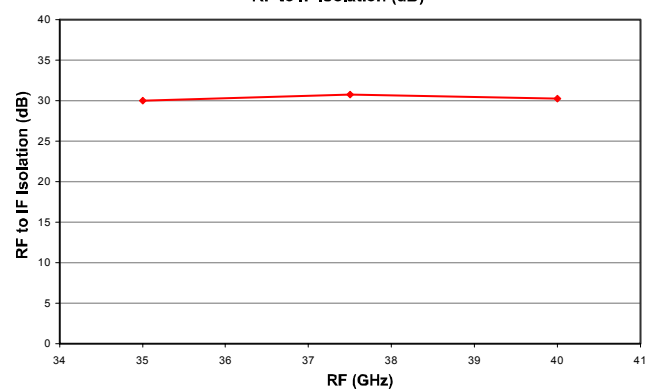

Mechanical Drawing

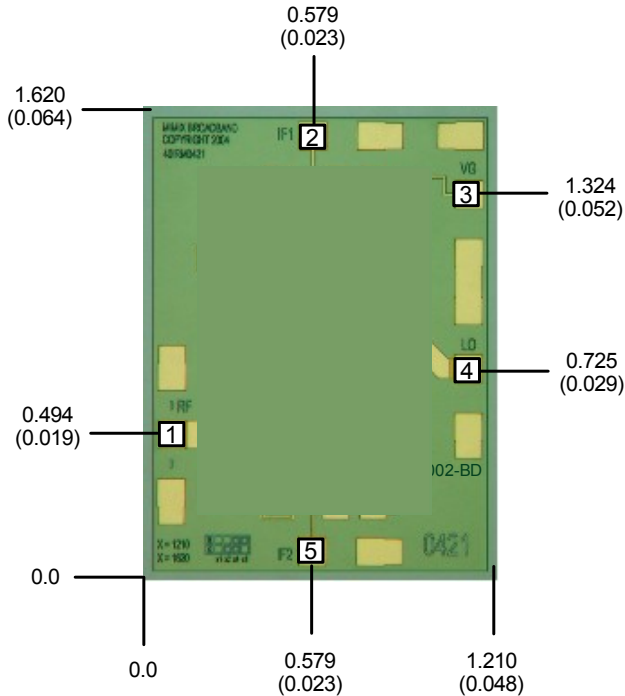

(Note: Engineering designator is 40IRM0421)

Units: millimeters (inches) Bond pad dimensions are shown to center of bond pad.
Thickness: 0.110 +/- 0.010 (0.0043 +/- 0.0004), Backside is ground, Bond Pad/Backside Metallization: Gold
All Bond Pads are 0.100 x 0.100 (0.004 x 0.004).

Bond pad centers are approximately 0.109 (0.004) from the edge of the chip.
Dicing tolerance: +/- 0.005 (+/- 0.0002). Approximate weight: 1.215 mg.

Bond Pad #1 (RF)	Bond Pad #3 (Vg)	Bond Pad #5 (IF2)
Bond Pad #2 (IF1)	Bond Pad #4 (LO)	

Bias Arrangement

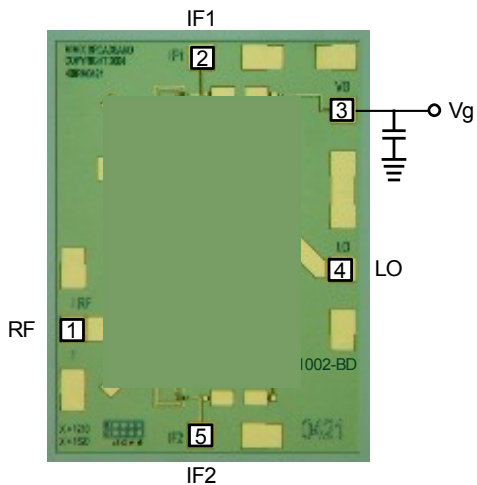

Bypass Capacitors - See App Note [2]

Image Reject Mixer 34 - 46 GHz

Rev. V1

App Note [1] Biasing - As shown in the bonding diagram, the pHEMT mixer devices are operated using a separate gate voltage V_{g1} . Set $V_{g1} = -0.5V$ for optimum conversion loss performance.

App Note [2] Bias Arrangement - Each DC pad (V_{g1}) needs to have DC bypass capacitance ($\sim 100-200$ pF) as close to the device as possible. Additional DC bypass capacitance (~ 0.01 uF) is also recommended.

App Note [3] USB/LSB Selection -

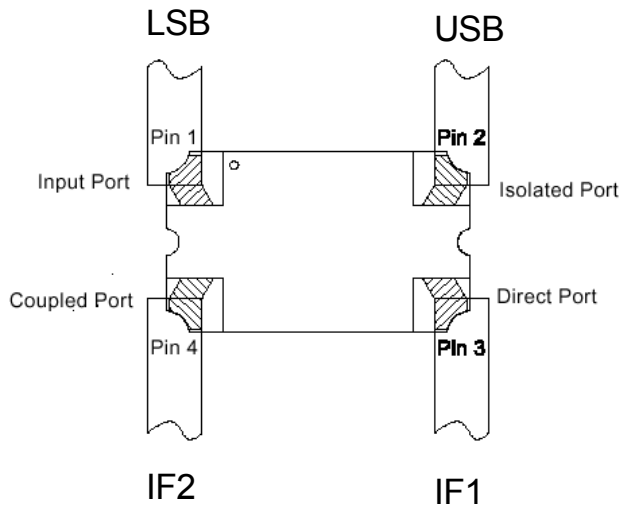

For Upper Side Band Operation (USB): With IF1 and IF2 connected to the direct port (0°) and coupled port (90°) respectively as shown in the diagram, the USB signal will reside on the isolated port. The input port must be loaded with 50 ohms.

For Lower Side Band Operation (LSB): With IF1 and IF2 connected to the direct port (0°) and coupled port (90°) respectively as shown in the diagram, the LSB signal will reside on the input port. The isolated port must be loaded with 50 ohms.

Note: The coupled port can be used as an alternative input but the port location of the Coupled and Direct ports reverse.

An alternate method of Selection of USB or LSB:

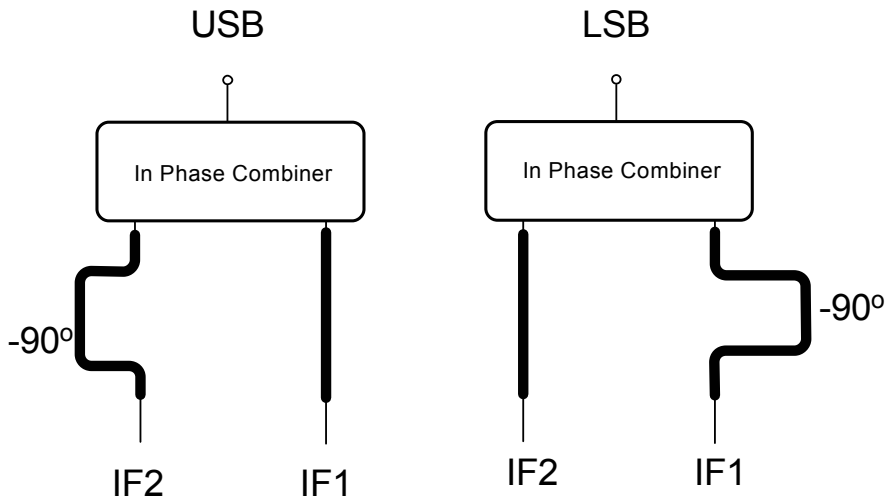

M/A-COM Technology Solutions Inc. All rights reserved.

Information in this document is provided in connection with M/A-COM Technology Solutions Inc ("MACOM") products. These materials are provided by MACOM as a service to its customers and may be used for informational purposes only. Except as provided in MACOM's Terms and Conditions of Sale for such products or in any separate agreement related to this document, MACOM assumes no liability whatsoever. MACOM assumes no responsibility for errors or omissions in these materials. MACOM may make changes to specifications and product descriptions at any time, without notice. MACOM makes no commitment to update the information and shall have no responsibility whatsoever for conflicts or incompatibilities arising from future changes to its specifications and product descriptions. No license, express or implied, by estoppel or otherwise, to any intellectual property rights is granted by this document.

THESE MATERIALS ARE PROVIDED "AS IS" WITHOUT WARRANTY OF ANY KIND, EITHER EXPRESS OR IMPLIED, RELATING TO SALE AND/OR USE OF MACOM PRODUCTS INCLUDING LIABILITY OR WARRANTIES RELATING TO FITNESS FOR A PARTICULAR PURPOSE, CONSEQUENTIAL OR INCIDENTAL DAMAGES, MERCHANTABILITY, OR INFRINGEMENT OF ANY PATENT, COPYRIGHT OR OTHER INTELLECTUAL PROPERTY RIGHT. MACOM FURTHER DOES NOT WARRANT THE ACCURACY OR COMPLETENESS OF THE INFORMATION, TEXT, GRAPHICS OR OTHER ITEMS CONTAINED WITHIN THESE MATERIALS. MACOM SHALL NOT BE LIABLE FOR ANY SPECIAL, INDIRECT, INCIDENTAL, OR CONSEQUENTIAL DAMAGES, INCLUDING WITHOUT LIMITATION, LOST REVENUES OR LOST PROFITS, WHICH MAY RESULT FROM THE USE OF THESE MATERIALS.

MACOM products are not intended for use in medical, lifesaving or life sustaining applications. MACOM customers using or selling MACOM products for use in such applications do so at their own risk and agree to fully indemnify MACOM for any damages resulting from such improper use or sale.