

- NOTES**
- MATERIAL:**
HSG: NYLON, GLASS-FILLED, UL94V-0 COLOR: BLACK
PIN: 0.64MM SQ, COPPER ALLOY
 - PLATING TYPE:**
 - GOLD FLASH OVER
1.25µm MIN. NICKEL OVERALL.
 - GOLD FLASH ON CONTACT AND
2.50µm MIN. TIN ON SOLDER TAIL OVER
1.25µm MIN. NICKEL OVERALL.
 - 0.38µm MIN. GOLD PLATE ON CONTACT AND
2.00µm MIN. TIN ON SOLDER TAIL OVER
1.25µm MIN. NICKEL OVERALL.
 - 0.75µm MIN. GOLD PLATE ON CONTACT AND
2.00µm MIN. TIN ON SOLDER TAIL OVER
1.25µm MIN. NICKEL OVERALL.
 - 2.50µm MIN TIN OVERALL
1.25µm MIN NICKEL OVERALL
 - PRODUCT SPECIFICATION:** PS-87920-019
 - PACKAGING TYPE:** SEE TABLE
 - WAFER TO BE FLAT WITHIN 0.003 mm/mm**
 - RECOMMENDED PCB THICKNESS IS 1.60mm ± 0.10**
 ∇ IRREGULAR CIRCUIT CUTOFF WITHIN BREAKAWAY SECTION IS PERMISSIBLE. CUTTING OR CHIPPING OF THE MAIN BODY IS NOT ACCEPTABLE
 - THE ABOVE CKT 6 IS FOR ILLUSTRATION PURPOSE ONLY**
 - PACKAGING SPECIFICATION:**
 TRAY: PK-89990-489
 BULK: PK-89990-491
 T&R : PK-87898-400
 TUBE: PK-89990-934
 - REFER SHEET 2 FOR CAP LOCATION.**

FUNCTIONAL SYMBOLS FA = 0 FE = 0 FP = 0	THIS DRAWING CONTAINS INFORMATION THAT IS PROPRIETARY TO MOLEX ELECTRONIC TECHNOLOGIES, LLC AND SHOULD NOT BE USED WITHOUT WRITTEN PERMISSION		CURRENT REV DESC:				
	DIMENSION UNITS	SCALE	CUSTOMER DRAWING				
	mm	NTS	2.54MM PITCH, SINGLE ROW SINGLE WAFER, T/H HEADER				
	GENERAL TOLERANCES (UNLESS SPECIFIED)		PRODUCT CUSTOMER DRAWING				
DIVISIONAL SYMBOLS		MM	INCH	EC NO: 741471	DOCUMENT NUMBER: SD-87891-001 DOC TYPE: PSD DOC PART: 000 REVISION: D19		
	4 PLACES	±	±	DRWN: SUAIFR 2023/03/07			
	3 PLACES	±	±	CHK'D: SUAIFR 2023/03/08			
	2 PLACES	±	0.2	±		APPR: MRAMAKRISHNA 2023/03/09	
	1 PLACE	±	±	INITIAL REVISION:			
	0 PLACES	±	±	DRWN: KCHO 2004/03/24			
	ANGULAR TOL	±	3.0°	APPR: SLOW 2004/04/08			
DRAFT WHERE APPLICABLE MUST REMAIN WITHIN DIMENSIONS		THIRD ANGLE PROJECTION	DRAWING	SERIES	MATERIAL NUMBER	CUSTOMER	SHEET NUMBER
			A3-SIZE	87891	SEE TABLE	GENERAL MARKET	1 OF 5

CAP INFORMATION- CAP OPTION A

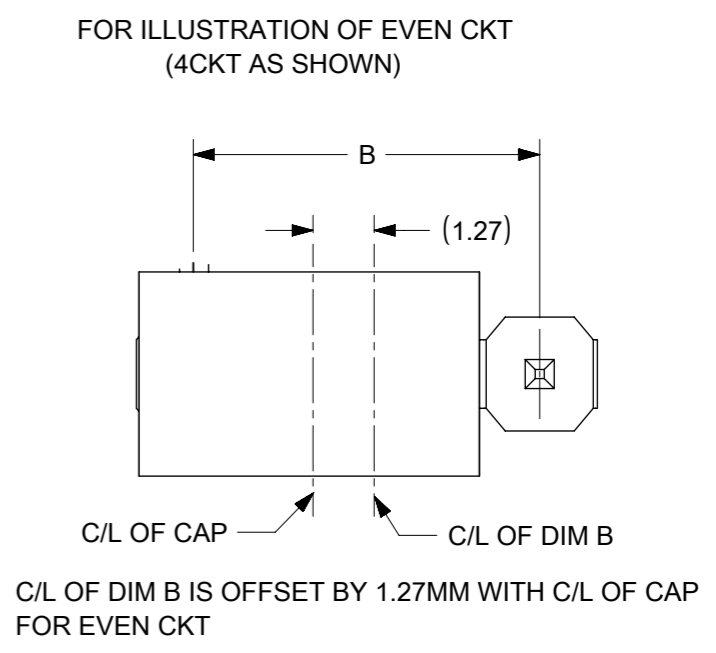
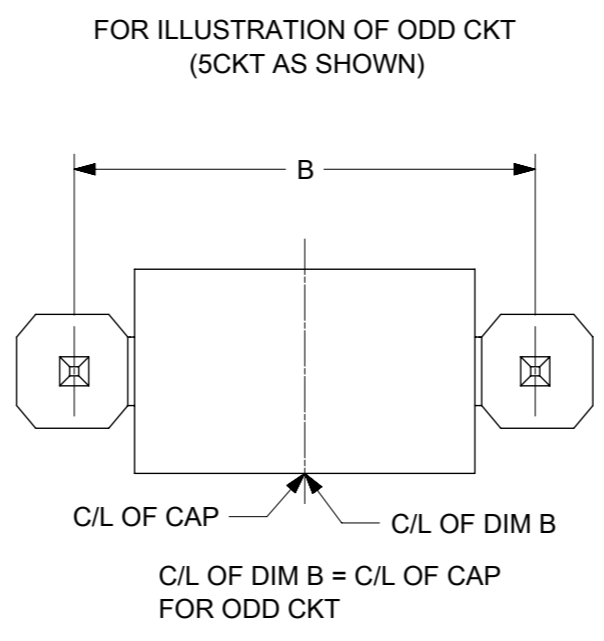
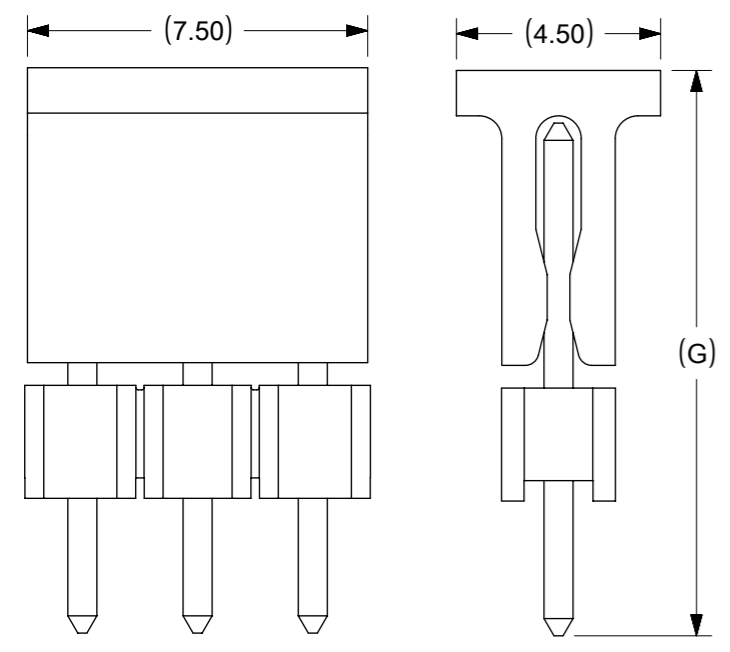

CAP INFORMATION- CAP OPTION B

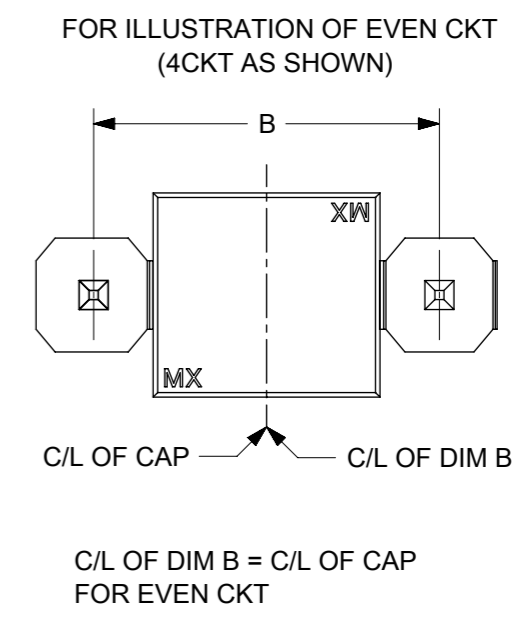
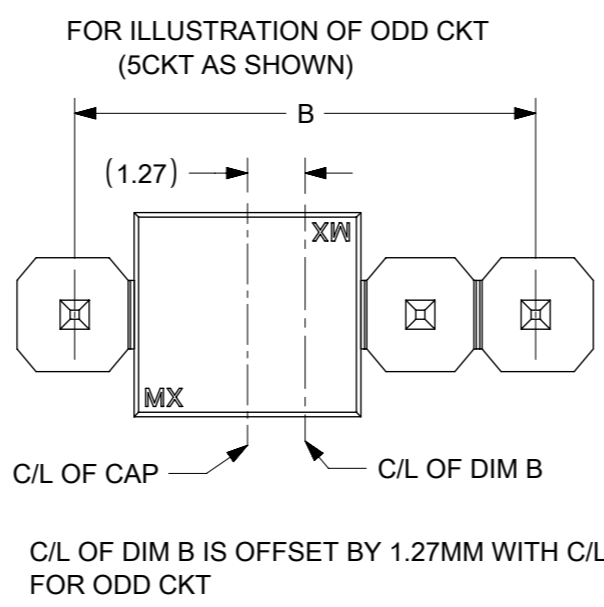
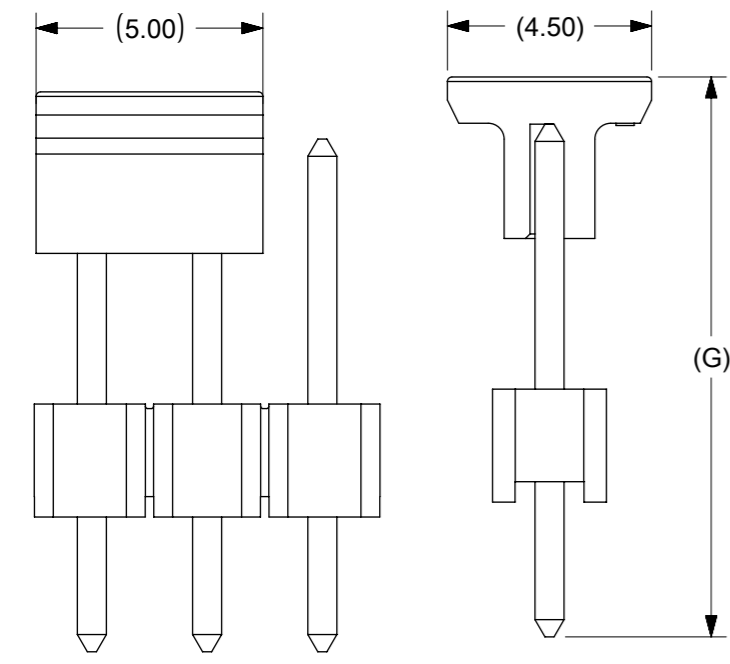

FUNCTIONAL SYMBOLS	THIS DRAWING CONTAINS INFORMATION THAT IS PROPRIETARY TO MOLEX ELECTRONIC TECHNOLOGIES, LLC AND SHOULD NOT BE USED WITHOUT WRITTEN PERMISSION		CURRENT REV DESC:									
	$\frac{F}{A} = 0$ $\frac{F}{E} = 0$ $\frac{F}{P} = 0$	DIMENSION UNITS mm							SCALE NTS	GENERAL TOLERANCES (UNLESS SPECIFIED)		
DIVISIONAL SYMBOLS	4 PLACES ±		MM	INCH	EC NO: 741471 DRWN: SUAIFR 2023/03/07 CHK'D: SUAIFR 2023/03/08 APPR: MRAMAKRISHNA 2023/03/09 INITIAL REVISION: DRWN: KCHO 2004/03/24 APPR: SLOW 2004/04/08							
	3 PLACES ±											
	2 PLACES ± 0.2											
	1 PLACE ±											
	ANGULAR TOL ± 3.0°		THIRD ANGLE PROJECTION		DRAWING	SERIES	MATERIAL NUMBER	CUSTOMER	DOCUMENT NUMBER	DOC TYPE	DOC PART	REVISION
DRAFT WHERE APPLICABLE MUST REMAIN WITHIN DIMENSIONS				A3-SIZE	87891	SEE TABLE	GENERAL MARKET	SD-87891-001	PSD	000	D19	
DOCUMENT STATUS		P1	RELEASE DATE	2023/03/09 04:23:59	SHEET NUMBER		2 OF 5					

10 9 8 7 6 5 4 3 2 1

CKT SIZE	DIMENSION		ASSY W/CAP IN T&R	ASSY W/O CAP IN T&R	ASSY W/O CAP IN TUBE	ASSY W/CAP IN TUBE	PART NO. W/O CAP IN TRAY PACKAGING	PART NO. IN BULK PACKAGING	CKT SIZE	VOID PIN	KINK PIN	(G)	DIMENSION			PLATING TYPE	CAP OPTION	REMARKS
	A	B											OAL	MATING END	SOLDIER TAIL			
													(F)	M	P			
01	2.54	---	-	-	-	-	87891-0108	-	01	-	-	-	10.80	5.08	3.23	5	-	-
02	5.08	2.54	-	-	-	-	87891-1017	-	01	-	-	-	12.29	6.80	3.00	3	-	-
03	7.62	5.08	-	-	-	-	87891-0200	-	02	-	-	-	11.76	6.09	3.18	5	-	-
04	10.16	7.62	-	-	-	-	87891-0205	-	02	-	-	-	11.30	5.84	2.97	4	-	-
05	12.70	10.16	-	-	-	-	87891-0206	-	02	-	-	-	11.30	5.84	2.97	5	-	-
06	15.24	12.70	-	-	-	-	87891-0211	-	02	-	-	-	11.30	5.84	2.97	5	-	-
07	17.78	15.24	-	-	-	-	87891-0207	-	02	-	-	-	9.80	4.00	3.31	5	-	-
08	20.32	17.78	-	-	-	-	87891-0208	-	02	-	-	-	7.49	4.00	1.00	2	-	-
09	22.86	20.32	-	-	-	-	87891-0209	-	02	-	-	-	10.80	5.08	3.23	5	-	-
10	25.40	22.86	-	-	-	-	87891-0210	-	02	-	-	-	31.00	25.54	2.97	5	-	-
11	27.94	25.40	-	-	-	-	87891-0216	-	02	-	-	-	7.29	2.40	2.40	5	-	-
12	30.48	27.94	-	-	-	-	87891-0212	-	02	-	-	-	18.37	12.68	3.20	5	-	-
13	33.02	30.48	-	-	-	-	87891-0211	-	02	-	-	-	26.49	20.80	3.20	5	-	-
14	35.56	33.02	-	-	-	-	87891-0214	-	02	-	-	-	19.49	13.00	4.00	5	-	-
15	38.10	35.56	-	-	-	-	87891-0215	-	02	-	-	14.98	13.98	7.49	4.00	5	A	-
16	40.64	38.10	-	-	-	-	87891-0213	-	02	-	-	-	12.14	5.84	3.81	4	-	-
17	43.18	40.64	-	-	-	-	87891-0306	-	03	-	-	-	11.30	5.84	2.97	5	-	-
18	45.72	43.18	-	-	-	-	87891-0308	-	03	-	-	-	11.30	5.84	2.97	5	-	-
19	48.26	45.72	-	-	-	-	87891-0307	-	03	-	-	-	22.73	18.74	1.50	5	-	-
20	50.80	48.26	-	-	-	-	87891-0003	-	03	2	-	-	13.72	9.65	1.78	6	-	-
21	53.34	50.80	-	-	-	-	87891-0312	-	03	-	-	-	11.30	5.84	2.97	4	-	-
22	55.88	53.34	-	-	-	-	87891-0311	-	03	-	-	12.34	11.30	5.84	2.97	5	B	REFER RPK-87891-0311 (FOR 87891-0311)
23	58.42	55.88	-	-	-	-	87891-0313	-	03	-	-	12.34	11.30	5.84	2.97	5	B	-
24	60.96	58.42	-	-	-	-	-	87891-0310	03	-	-	-	6.49	2.00	2.00	5	-	-
25	63.50	60.96	-	-	-	-	87891-0317	-	03	-	-	-	12.14	5.84	3.81	4	-	-
26	66.04	63.50	-	-	-	-	87891-0402	-	04	2	-	-	10.80	5.89	2.41	5	-	-
27	68.58	66.04	-	-	-	-	87891-0004	-	04	-	-	-	35.10	29.71	3.10	6	-	-
28	71.12	68.58	-	-	-	-	87891-0411	-	04	-	-	-	10.09	4.00	3.60	5	-	-
29	73.66	71.12	-	-	-	-	87891-0407	-	04	-	-	-	9.80	4.00	3.31	5	-	-
30	76.20	73.66	-	-	-	-	87891-0408	-	04	-	-	-	31.00	25.54	2.97	5	-	-
31	78.74	76.20	-	-	-	-	87891-0418	-	04	-	-	-	12.14	6.75	2.90	5	-	REFER 878910418-RPK (FOR 87891-0418)
32	81.28	78.74	-	-	-	-	87891-0409	-	04	-	-	-	12.14	6.75	2.90	4	-	-
33	83.82	81.28	-	-	-	-	87891-0417	-	04	-	-	16.31	15.11	9.01	3.61	5	A	-
34	86.36	83.82	-	-	-	-	87891-0432	-	04	-	-	-	18.03	13.54	2.00	5	-	-
35	88.90	86.36	-	-	-	-	87891-0430	-	04	-	-	-	13.09	8.00	2.80	5	A	-
36	91.44	88.90	-	-	-	-	-	-	-	-	-	-	-	-	-	-	-	-
37	93.98	91.44	-	-	-	-	-	-	-	-	-	-	-	-	-	-	-	-
38	96.52	93.98	-	-	-	-	-	-	-	-	-	-	-	-	-	-	-	-
39	99.06	96.52	-	-	-	-	-	-	-	-	-	-	-	-	-	-	-	-
40	101.60	99.06	-	-	-	-	-	-	-	-	-	-	-	-	-	-	-	-

FUNCTIONAL SYMBOLS		THIS DRAWING CONTAINS INFORMATION THAT IS PROPRIETARY TO MOLEX ELECTRONIC TECHNOLOGIES, LLC AND SHOULD NOT BE USED WITHOUT WRITTEN PERMISSION		CURRENT REV DESC:			
$\nabla_A = 0$ $\nabla_F = 0$ $\nabla_P = 0$		DIMENSION UNITS: mm SCALE: NTS GENERAL TOLERANCES (UNLESS SPECIFIED)		EC NO: 741471 DRWN: SUAIFR CHK'D: SUAIFR APPR: MRAMAKRISHNA			
DIVISIONAL SYMBOLS		4 PLACES ± MM INCH 3 PLACES ± ± 2 PLACES ± 0.2 ± 1 PLACE ± ± 0 PLACES ± ±		INITIAL REVISION: DRWN: KCHO APPR: SLOW		PRODUCT CUSTOMER DRAWING DOCUMENT NUMBER: SD-87891-001 DOC TYPE: PSD DOC PART: 000 REVISION: D19	
DRAFT WHERE APPLICABLE MUST REMAIN WITHIN DIMENSIONS		THIRD ANGLE PROJECTION		DRAWING: A3-SIZE SERIES: 87891		MATERIAL NUMBER: SEE TABLE CUSTOMER: GENERAL MARKET SHEET NUMBER: 3 OF 5	

F	ASSY W/CAP IN T&R	ASSY W/O CAP IN T&R	ASSY W/O CAP IN TUBE	ASSY W/CAP IN TUBE	PART NO. W/O CAP IN TRAY PACKAGING	PART NO. IN BULK PACKAGING	CKT SIZE	VOID PIN	KINK PIN	(G)			PLATING TYPE	CAP OPTION	REMARKS	
											OAL	MATING END				
											(F)	M				
-	-	-	-	-	87891-0500	-	05	-	-	-	11.94	6.10	3.30	5	-	-
-	-	-	-	-	87891-0505	-	05	-	-	-	11.94	6.10	3.30	5	-	-
-	-	-	-	-	87891-0501	-	05	-	-	-	13.62	8.08	3.05	5	-	-
-	-	-	-	-	87891-0502	-	05	2	-	-	10.80	5.89	2.41	5	-	-
-	-	-	-	-	87891-0503	-	05	2	-	-	45.00	13.51	29.00	5	-	-
-	-	-	-	-	87891-0504	-	05	2	-	-	45.00	13.51	29.00	3	-	-
-	-	-	-	-	87891-0507	-	05	4	-	-	10.92	5.84	2.59	3	-	-
-	-	-	-	-	-	87891-0508	05	2,4	-	-	11.38	5.84	3.05	5	-	-
-	-	-	-	-	87891-0522	-	05	2&4	-	-	19.49	13.00	4.00	5	-	-
-	-	-	-	-	87891-0516	-	05	-	-	-	32.49	16.00	14.00	4	-	-
-	-	-	-	-	87891-0517	-	05	-	-	-	23.62	17.32	3.81	5	-	-
-	-	-	-	-	87891-0523	-	05	-	-	-	7.29	2.40	2.40	5	-	-
-	87891-0521	-	-	-	-	-	05	-	-	10.10	9.89	2.80	4.60	5	A	-
-	-	-	-	-	87891-0601	-	06	-	-	-	11.30	5.84	2.97	1	-	-
-	-	-	-	-	87891-0602	-	06	-	-	-	12.80	8.00	2.31	5	-	-
-	-	-	-	-	87891-0606	-	06	-	-	-	11.30	5.84	2.97	5	-	-
-	-	-	-	-	87891-0610	-	06	-	-	-	11.30	5.84	2.97	5	-	-
-	-	-	-	-	87891-0607	-	06	-	-	-	13.75	8.08	3.18	5	-	-
-	-	-	-	-	87891-0608	-	06	-	-	-	18.03	13.54	2.00	5	-	-
-	-	-	-	-	87891-0609	-	06	-	-	-	28.30	22.16	3.65	5	-	-
-	-	-	-	-	87891-0611	-	06	-	-	-	28.30	22.16	3.65	5	-	-
87891-0613	-	-	-	-	-	-	06	-	-	22.99	21.99	16.00	3.50	5	A	-
-	-	-	-	-	87891-0615	-	06	-	-	-	14.49	10.00	2.00	1	-	-
-	-	-	-	-	87891-0624	-	06	-	-	-	26.10	19.81	3.80	5	-	-
-	-	-	-	-	87891-0700	-	07	-	-	-	11.94	6.10	3.30	5	-	-
-	-	-	-	-	87891-0702	-	07	-	-	-	11.94	6.10	3.30	5	-	-
-	-	-	-	-	87891-0751	-	07	-	-	-	13.74	8.00	3.25	5	-	-
87891-0007	-	-	-	-	-	-	07	-	-	-	13.72	9.65	1.78	6	-	-
-	-	-	-	-	87891-0851	-	08	-	-	-	13.74	8.00	3.25	5	-	-
87891-0807	-	-	-	-	-	-	08	-	-	13.59	12.59	7.90	2.20	5	A	-
-	-	-	-	-	87891-0808	-	08	-	-	-	20.53	13.72	4.32	3	-	-
-	-	-	-	-	87891-0809	-	08	-	-	-	11.30	5.84	2.97	5	-	-

<p>FUNCTIONAL SYMBOLS</p> <p>$\nabla_A = 0$</p> <p>$\nabla_F = 0$</p> <p>$\nabla_P = 0$</p> <p>DIVISIONAL SYMBOLS</p>										<p>THIS DRAWING CONTAINS INFORMATION THAT IS PROPRIETARY TO MOLEX ELECTRONIC TECHNOLOGIES, LLC AND SHOULD NOT BE USED WITHOUT WRITTEN PERMISSION</p> <p>SCALE: mm NTS</p> <p>GENERAL TOLERANCES (UNLESS SPECIFIED)</p> <table border="1"> <tr><th colspan="2">MM</th><th colspan="2">INCH</th></tr> <tr><td>4 PLACES</td><td>±</td><td></td><td>±</td></tr> <tr><td>3 PLACES</td><td>±</td><td></td><td>±</td></tr> <tr><td>2 PLACES</td><td>±</td><td>0.2</td><td>±</td></tr> <tr><td>1 PLACE</td><td>±</td><td></td><td>±</td></tr> <tr><td>0 PLACES</td><td>±</td><td></td><td>±</td></tr> </table> <p>ANGULAR TOL ± 3.0°</p> <p>DRAFT WHERE APPLICABLE MUST REMAIN WITHIN DIMENSIONS</p>										MM		INCH		4 PLACES	±		±	3 PLACES	±		±	2 PLACES	±	0.2	±	1 PLACE	±		±	0 PLACES	±		±	<p>CURRENT REV DESC:</p> <p>EC NO: 741471</p> <p>DRWN: SUAIFR</p> <p>CHK'D: SUAIFR</p> <p>APPR: MRAMAKRISHNA</p> <p>INITIAL REVISION:</p> <p>DRWN: KCHO</p> <p>APPR: SCLOW</p>										<p>molex</p> <p>CUSTOM HEADER</p> <p>2.54MM PITCH, SINGLE ROW SINGLE WAFER, T/H HEADER</p> <p>PRODUCT CUSTOMER DRAWING</p> <p>DOCUMENT NUMBER: SD-87891-001</p> <p>DOC TYPE: PSD</p> <p>DOC PART: 000</p> <p>REVISION: D19</p> <p>MATERIAL NUMBER: SEE TABLE</p> <p>CUSTOMER: GENERAL MARKET</p> <p>SHEET NUMBER: 4 OF 5</p>									
MM		INCH																																																													
4 PLACES	±		±																																																												
3 PLACES	±		±																																																												
2 PLACES	±	0.2	±																																																												
1 PLACE	±		±																																																												
0 PLACES	±		±																																																												

ASSY W/CAP IN T&R	ASSY W/O CAP IN T&R	ASSY W/O CAP IN TUBE	ASSY W/CAP IN TUBE	PART NO. W/O CAP IN TRAY PACKAGING	PART NO. IN BULK PACKAGING	CKT SIZE	VOID PIN	KINK PIN	(G)		PLATING TYPE	CAP OPTION	REMARKS		
									(F)	M					
-	-	-	-	-	87891-2601	26	4,7,17	-	-	11.13	5.59	3.05	3	-	-
87891-1817	-	-	-	-	-	18	-	-	18.36	17.20	13.21	1.50	5	A	-
87891-1819	-	-	-	-	-	18	-	-	18.36	17.20	13.21	1.50	5	A	-
87891-1818	-	-	-	-	-	18	-	-	18.36	17.20	13.21	1.50	3	A	-
-	-	-	-	87891-2007	-	20	-	-	-	21.49	9.50	9.50	1	-	-
87891-2817	-	-	-	-	-	28	-	-	18.36	17.20	13.21	1.50	5	A	-
87891-2819	-	-	-	-	-	28	-	-	18.36	17.20	13.21	1.50	5	A	-
87891-2818	-	-	-	-	-	28	-	-	18.36	17.20	13.21	1.50	3	A	-
-	-	-	-	-	87891-3007	30	-	-	-	11.30	5.84	2.97	5	-	-
-	-	-	-	-	87891-3600	36	-	-	-	11.56	6.09	3.18	2	-	-
-	-	-	-	-	87891-4008	40	-	-	-	11.30	5.84	2.97	5	-	-
-	-	87891-4007	-	-	-	40	-	-	-	12.14	5.84	3.81	3	-	-



FUNCTIONAL SYMBOLS		THIS DRAWING CONTAINS INFORMATION THAT IS PROPRIETARY TO MOLEX ELECTRONIC TECHNOLOGIES, LLC AND SHOULD NOT BE USED WITHOUT WRITTEN PERMISSION		CURRENT REV DESC:		molex	
DIMENSION UNITS		SCALE		EC NO: 741471			
mm		NTS		DRWN: SUAIFR		CUSTOM HEADER	
GENERAL TOLERANCES (UNLESS SPECIFIED)				2023/03/07		2.54MM PITCH, SINGLE ROW SINGLE WAFER, T/H HEADER	
				2023/03/08		PRODUCT CUSTOMER DRAWING	
				2023/03/09			
DIVISIONAL SYMBOLS		INITIAL REVISION:		DOCUMENT NUMBER		DOC TYPE	
4 PLACES ±		DRWN: KCHO		SD-87891-001		PSD	
3 PLACES ±		APPR: SCLOW		DOC PART		000	
2 PLACES ± 0.2		2004/03/24		REVISION		D19	
1 PLACE ±		2004/04/08		MATERIAL NUMBER		SEE TABLE	
0 PLACES ±		ANGULAR TOL ± 3.0°		CUSTOMER		GENERAL MARKET	
DRAFT WHERE APPLICABLE MUST REMAIN WITHIN DIMENSIONS		THIRD ANGLE PROJECTION		DRAWING		SHEET NUMBER	
				A3-SIZE		5 OF 5	

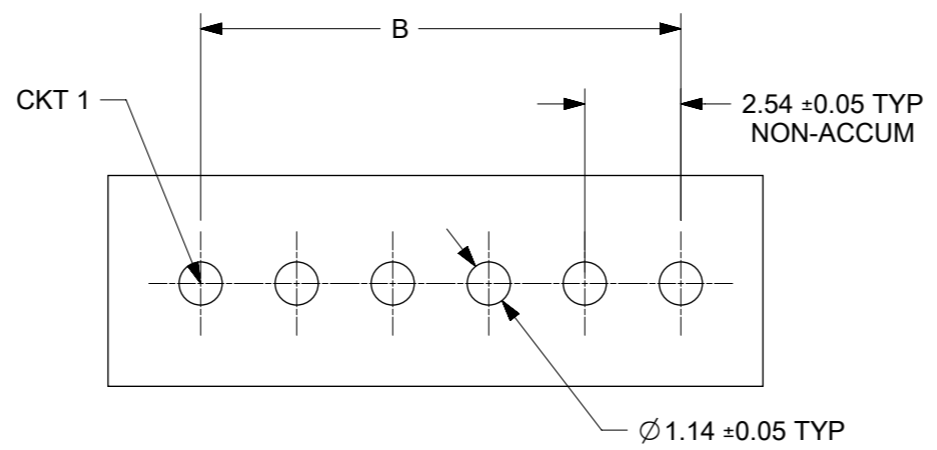
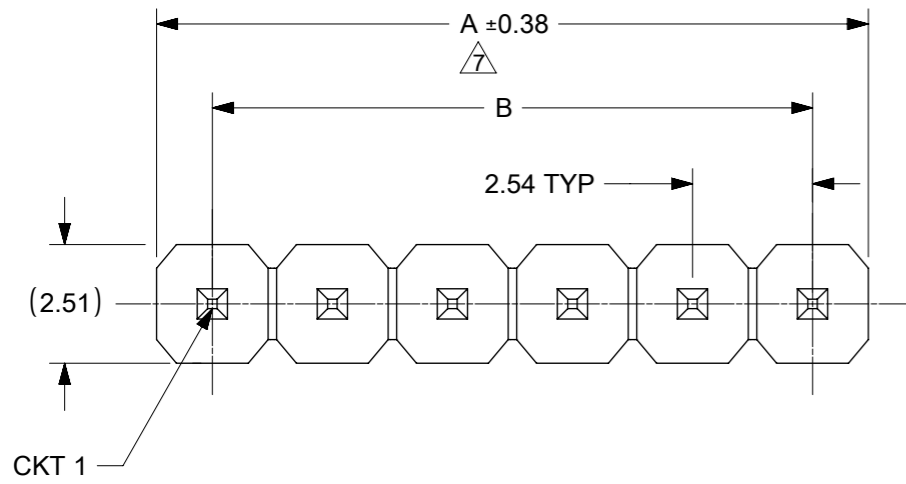

RECOMENDED P.C.B HOLE LAYOUT

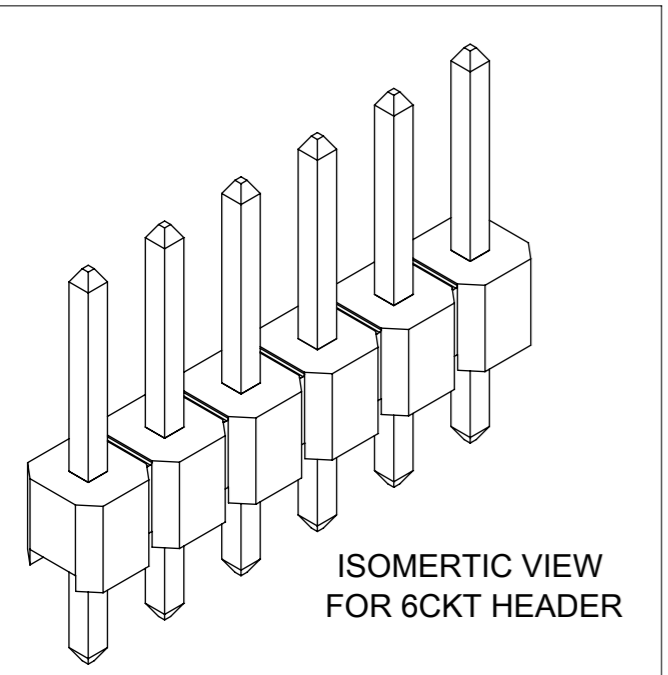
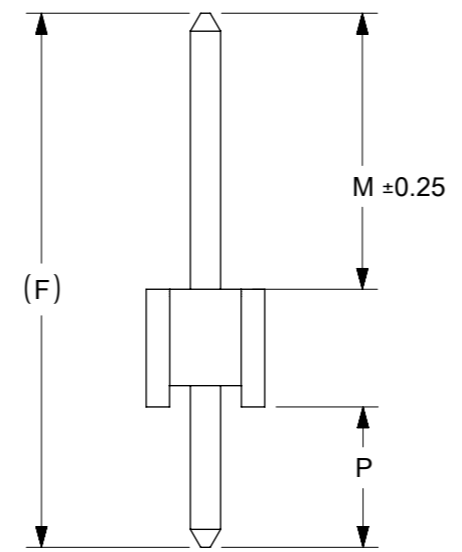
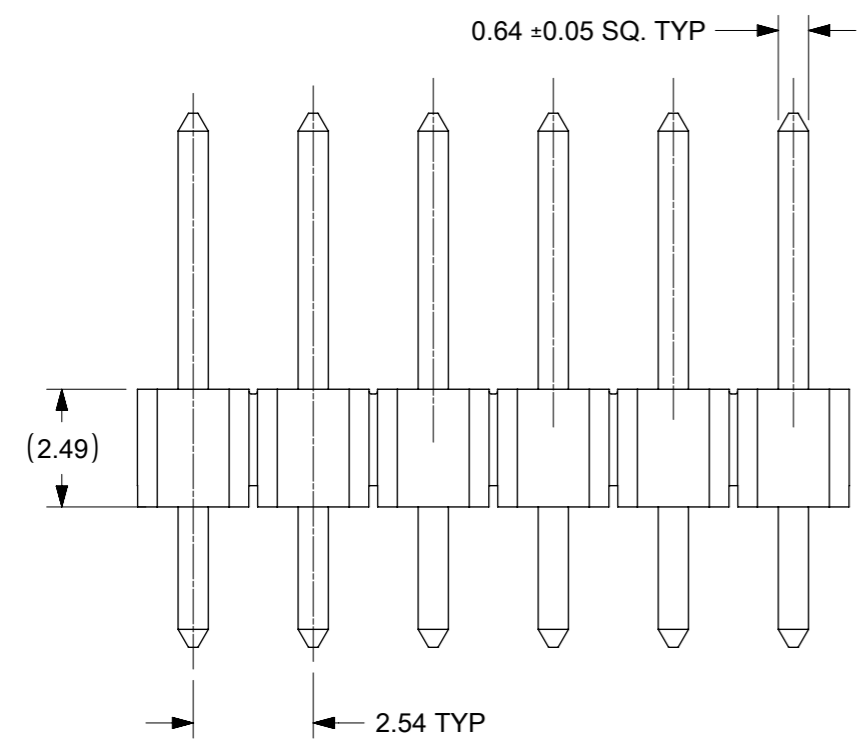

ISOMERTIC VIEW FOR 6CKT HEADER

NOTES

1. MATERIAL:
HSG: NYLON, GLASS-FILLED, UL94V-0 COLOR: BLACK
PIN: 0.64MM SQ, COPPER ALLOY
2. PLATING TYPE:
 - (1) GOLD FLASH OVER
1.270µm MIN. NICKEL OVERALL.
 - (2) GOLD FLASH ON CONTACT AND
1.905µm MIN. TIN ON SOLDERTAIL OVER
1.270µm MIN. NICKEL OVERALL.
 - (3) 0.254µm MIN. GOLD PLATE ON CONTACT AND
1.905µm MIN. TIN ON SOLDERTAIL OVER
1.270µm MIN. NICKEL OVERALL.
 - (4) 0.381µm MIN. GOLD PLATE ON CONTACT AND
1.905µm MIN. TIN ON SOLDERTAIL OVER
1.270µm MIN. NICKEL OVERALL.
 - (5) 0.762µm MIN. GOLD PLATE ON CONTACT AND
1.905µm MIN. TIN ON SOLDERTAIL OVER
1.270µm MIN. NICKEL OVERALL.
 - (6) 2.540µm/100µin MIN TIN OVERALL
1.270µm/50µin NICKEL OVERALL
3. PRODUCT SPECIFICATION: PS-87920-019
4. PACKAGING TYPE: SEE TABLE
5. WAFER TO BE FLAT WITHIN 0.003 mm/mm
6. RECOMMENDED PCB THICKNESS IS 1.60mm±0.10
- △ IRREGULAR CIRCUIT CUTOFF WITHIN BREAKAWAY SECTION IS PERMISSIBLE. CUTTING OR CHIPPING OF THE MAIN BODY IS NOT ACCEPTABLE
8. THE ABOVE CKT 6 IS FOR ILLUSTRATION PURPOSE ONLY
9. PACKAGING SPECIFICATION:
TRAY: PK-89990-489
BULK: PK-89990-491

THIS DRAWING CONTAINS INFORMATION THAT IS PROPRIETARY TO MOLEX ELECTRONIC TECHNOLOGIES, LLC AND SHOULD NOT BE USED WITHOUT WRITTEN PERMISSION		CURRENT REV DESC:		molex	
DIMENSION UNITS	SCALE				
mm	NTS			CUSTOM HEADER 2.54MM PITCH, SINGLE ROW SINGLE WAFER, T/H HEADER	
GENERAL TOLERANCES (UNLESS SPECIFIED)				PRODUCT CUSTOMER DRAWING	
ANGULAR TOL	± 3.0 °			DOCUMENT NUMBER	
4 PLACES	±	EC NO: 679909		SD-87891-013	
3 PLACES	±	DRWN: AKUMAR19	2021/10/08	DOC TYPE	DOC PART
2 PLACES	± 0.2	CHK'D: MRAMAKRISHNA	2021/10/11	PSD	001
1 PLACE	±	APPR: MRAMAKRISHNA	2021/10/11	REVISION	
0 PLACES	±	INITIAL REVISION:		B5	
DRAFT WHERE APPLICABLE MUST REMAIN WITHIN DIMENSIONS		DRWN: YLQIAO	2004/12/06	MATERIAL NUMBER	
THIRD ANGLE PROJECTION		APPR: SLOW	2004/12/07	CUSTOMER	
DRAWING		SERIES		SHEET NUMBER	
A3-SIZE		87891		1 OF 8	

DOCUMENT STATUS	P1	RELEASE DATE	2021/10/11	11:53:25
-----------------	----	--------------	------------	----------

10	9			8		7		6				
	PACKAGING OPTION PART NO.			CKT SIZE	VOID POSITION	PLATING TYPE	DIMENSION					
	TRAY	BULK	TUBE WITHOUT CAP				A	B	F	M	P	
F	87891-0101	---	---	1	---	1	2.54	---	11.30	5.84	2.97	
	87891-0102	---	---	1	---	2	2.54	---	11.30	5.84	2.97	
	87891-0103	---	---	1	---	3	2.54	---	11.30	5.84	2.97	
	87891-0104	---	---	1	---	4	2.54	---	11.30	5.84	2.97	
	87891-0105	---	---	1	---	5	2.54	---	11.30	5.84	2.97	
	87891-0106	---	---	1	---	6	2.54	---	11.30	5.84	2.97	
(B4)	87891-0109	---	---	1	---	6	2.54	---	11.30	5.84	2.97	
E	87891-0201	---	---	2	---	1	5.08	2.54	11.30	5.84	2.97	
	87891-0202	---	---	2	---	2	5.08	2.54	11.30	5.84	2.97	
	87891-0203	---	---	2	---	3	5.08	2.54	11.30	5.84	2.97	
	87891-0204	---	---	2	---	4	5.08	2.54	11.30	5.84	2.97	
	87891-0205	---	---	2	---	5	5.08	2.54	11.30	5.84	2.97	
	87891-0206	---	---	2	---	6	5.08	2.54	11.30	5.84	2.97	
(B4)	87891-0211	---	---	2	---	6	5.08	2.54	11.30	5.84	2.97	
D	87891-0301	---	---	3	---	1	7.62	5.08	11.30	5.84	2.97	
	87891-0302	---	---	3	---	2	7.62	5.08	11.30	5.84	2.97	
	87891-0303	---	---	3	---	3	7.62	5.08	11.30	5.84	2.97	
	87891-0304	---	---	3	---	4	7.62	5.08	11.30	5.84	2.97	
	87891-0305	---	---	3	---	5	7.62	5.08	11.30	5.84	2.97	
	87891-0306	---	---	3	---	6	7.62	5.08	11.30	5.84	2.97	
(B4)	87891-0308	---	---	3	---	6	7.62	5.08	11.30	5.84	2.97	

4	3			2		1					
	PACKAGING OPTION PART NO.			CKT SIZE	VOID POSITION	PLATING TYPE	DIMENSION				
	TRAY	BULK	TUBE WITHOUT CAP				A	B	F	M	P
F	87891-0401	---	---	4	---	1	10.16	7.62	11.30	5.84	2.97
	87891-0412	---	---	4	---	2	10.16	7.62	11.30	5.84	2.97
	87891-0403	---	---	4	---	3	10.16	7.62	11.30	5.84	2.97
	87891-0404	---	---	4	---	4	10.16	7.62	11.30	5.84	2.97
	87891-0405	---	---	4	---	5	10.16	7.62	11.30	5.84	2.97
	87891-0406	---	---	4	---	6	10.16	7.62	11.30	5.84	2.97
E	87891-0511	---	---	5	---	1	12.70	10.16	11.30	5.84	2.97
	87891-0512	---	---	5	---	2	12.70	10.16	11.30	5.84	2.97
	87891-0513	---	---	5	---	3	12.70	10.16	11.30	5.84	2.97
	87891-0514	---	---	5	---	4	12.70	10.16	11.30	5.84	2.97
	87891-0515	---	---	5	---	5	12.70	10.16	11.30	5.84	2.97
	87891-0506	---	---	5	---	6	12.70	10.16	11.30	5.84	2.97
(B4)	87891-0509	---	---	5	---	6	12.70	10.16	11.30	5.84	2.97
D	87891-0601	---	---	6	---	1	15.24	12.70	11.30	5.84	2.97
	87891-0612	---	---	6	---	2	15.24	12.70	11.30	5.84	2.97
	87891-0603	---	---	6	---	3	15.24	12.70	11.30	5.84	2.97
	87891-0604	---	---	6	---	4	15.24	12.70	11.30	5.84	2.97
	87891-0605	---	---	6	---	5	15.24	12.70	11.30	5.84	2.97
	87891-0606	---	---	6	---	6	15.24	12.70	11.30	5.84	2.97
(B4)	87891-0610	---	---	6	---	6	15.24	12.70	11.30	5.84	2.97

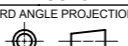
THIS DRAWING CONTAINS INFORMATION THAT IS PROPRIETARY TO MOLEX ELECTRONIC TECHNOLOGIES, LLC AND SHOULD NOT BE USED WITHOUT WRITTEN PERMISSION																	
DIMENSION UNITS		SCALE		CURRENT REV DESC:													
mm		NTS															
GENERAL TOLERANCES (UNLESS SPECIFIED)				EC NO: 679909 DRWN: AKUMAR19 2021/10/08 CHK'D: MRAMAKRISHNA 2021/10/11 APPR: MRAMAKRISHNA 2021/10/11 INITIAL REVISION: DRWN: YLQIAO 2004/12/06 APPR: SLOW 2004/12/07						CUSTOMER DRAWING							
ANGULAR TOL		± 3.0 °								DOCUMENT NUMBER		DOC TYPE		DOC PART		REVISION	
4 PLACES		±								SD-87891-013		PSD		001		B5	
3 PLACES		±								MATERIAL NUMBER		CUSTOMER		SHEET NUMBER			
2 PLACES		± 0.2								SEE TABLE		GENERAL MARKET		2 OF 8			
1 PLACE		±															
0 PLACES		±															
DRAFT WHERE APPLICABLE MUST REMAIN WITHIN DIMENSIONS				THIRD ANGLE PROJECTION		DRAWING		SERIES									
						A3-SIZE		87891									

PACKAGING OPTION PART NO.			CKT SIZE	VOID POSITION	PLATING TYPE	DIMENSION				
TRAY	BULK	TUBE WITHOUT CAP				A	B	F	M	P
87891-0711	---	---	7	---	1	17.78	15.24	11.30	5.84	2.97
87891-0702	---	---	7	---	2	17.78	15.24	11.30	5.84	2.97
87891-0703	---	---	7	---	3	17.78	15.24	11.30	5.84	2.97
87891-0704	---	---	7	---	4	17.78	15.24	11.30	5.84	2.97
87891-0705	---	---	7	---	5	17.78	15.24	11.30	5.84	2.97
87891-0706	---	---	7	---	6	17.78	15.24	11.30	5.84	2.97
87891-0801	---	---	8	---	1	20.32	17.78	11.30	5.84	2.97
87891-0802	---	---	8	---	2	20.32	17.78	11.30	5.84	2.97
87891-0803	---	---	8	---	3	20.32	17.78	11.30	5.84	2.97
87891-0804	---	---	8	---	4	20.32	17.78	11.30	5.84	2.97
87891-0805	---	---	8	---	5	20.32	17.78	11.30	5.84	2.97
87891-0806	---	---	8	---	6	20.32	17.78	11.30	5.84	2.97
87891-0901	---	---	9	---	1	22.86	20.32	11.30	5.84	2.97
87891-0902	---	---	9	---	2	22.86	20.32	11.30	5.84	2.97
87891-0903	---	---	9	---	3	22.86	20.32	11.30	5.84	2.97
87891-0904	---	---	9	---	4	22.86	20.32	11.30	5.84	2.97
87891-0905	---	---	9	---	5	22.86	20.32	11.30	5.84	2.97
87891-0906	---	---	9	---	6	22.86	20.32	11.30	5.84	2.97

PACKAGING OPTION PART NO.			CKT SIZE	VOID POSITION	PLATING TYPE	DIMENSION				
TRAY	BULK	TUBE WITHOUT CAP				A	B	F	M	P
87891-1001	---	---	10	---	1	25.40	22.86	11.30	5.84	2.97
87891-1002	---	---	10	---	2	25.40	22.86	11.30	5.84	2.97
87891-1003	---	---	10	---	3	25.40	22.86	11.30	5.84	2.97
87891-1004	---	---	10	---	4	25.40	22.86	11.30	5.84	2.97
87891-1005	---	---	10	---	5	25.40	22.86	11.30	5.84	2.97
87891-1006	---	---	10	---	6	25.40	22.86	11.30	5.84	2.97
87891-1101	---	---	11	---	1	27.94	25.40	11.30	5.84	2.97
87891-1102	---	---	11	---	2	27.94	25.40	11.30	5.84	2.97
87891-1103	---	---	11	---	3	27.94	25.40	11.30	5.84	2.97
87891-1104	---	---	11	---	4	27.94	25.40	11.30	5.84	2.97
87891-1105	---	---	11	---	5	27.94	25.40	11.30	5.84	2.97
87891-1106	---	---	11	---	6	27.94	25.40	11.30	5.84	2.97
87891-1201	---	---	12	---	1	30.48	27.94	11.30	5.84	2.97
87891-1202	---	---	12	---	2	30.48	27.94	11.30	5.84	2.97
87891-1203	---	---	12	---	3	30.48	27.94	11.30	5.84	2.97
87891-1204	---	---	12	---	4	30.48	27.94	11.30	5.84	2.97
87891-1205	---	---	12	---	5	30.48	27.94	11.30	5.84	2.97
87891-1206	---	---	12	---	6	30.48	27.94	11.30	5.84	2.97

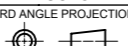
THIS DRAWING CONTAINS INFORMATION THAT IS PROPRIETARY TO MOLEX ELECTRONIC TECHNOLOGIES, LLC AND SHOULD NOT BE USED WITHOUT WRITTEN PERMISSION												
DIMENSION UNITS		SCALE		CURRENT REV DESC:								
mm		NTS										
GENERAL TOLERANCES (UNLESS SPECIFIED)				EC NO: 679909 DRWN: AKUMAR19 2021/10/08 CHK'D: MRAMAKRISHNA 2021/10/11 APPR: MRAMAKRISHNA 2021/10/11 INITIAL REVISION: DRWN: YLQIAO 2004/12/06 APPR: SCLOW 2004/12/07				CUSTOM HEADER				
ANGULAR TOL ± 3.0 °								2.54MM PITCH, SINGLE ROW SINGLE WAFER, T/H HEADER				
4 PLACES ±								PRODUCT CUSTOMER DRAWING				
3 PLACES ±								DOCUMENT NUMBER		DOC TYPE	DOC PART	REVISION
2 PLACES ±		0.2						SD-87891-013		PSD	001	B5
1 PLACE ±												
0 PLACES ±												
DRAFT WHERE APPLICABLE MUST REMAIN WITHIN DIMENSIONS				THIRD ANGLE PROJECTION		DRAWING	SERIES	MATERIAL NUMBER	CUSTOMER	SHEET NUMBER		
						A3-SIZE	87891	SEE TABLE	GENERAL MARKET	3 OF 8		

DOCUMENT STATUS	P1	RELEASE DATE	2021/10/11	11:53:25
-----------------	----	--------------	------------	----------

	PACKAGING OPTION PART NO.			CKT SIZE	VOID POSITION	PLATING TYPE	DIMENSION				
	TRAY	BULK	TUBE WITHOUT CAP				A	B	F	M	P
F	87891-1301	---	---	13	---	1	33.02	30.48	11.30	5.84	2.97
	87891-1302	---	---	13	---	2	33.02	30.48	11.30	5.84	2.97
	87891-1303	---	---	13	---	3	33.02	30.48	11.30	5.84	2.97
	87891-1304	---	---	13	---	4	33.02	30.48	11.30	5.84	2.97
	87891-1305	---	---	13	---	5	33.02	30.48	11.30	5.84	2.97
	87891-1306	---	---	13	---	6	33.02	30.48	11.30	5.84	2.97
E	87891-1401	---	---	14	---	1	35.56	33.02	11.30	5.84	2.97
	87891-1402	---	---	14	---	2	35.56	33.02	11.30	5.84	2.97
	87891-1403	---	---	14	---	3	35.56	33.02	11.30	5.84	2.97
	87891-1404	---	---	14	---	4	35.56	33.02	11.30	5.84	2.97
	87891-1405	---	---	14	---	5	35.56	33.02	11.30	5.84	2.97
	87891-1406	---	---	14	---	6	35.56	33.02	11.30	5.84	2.97
D	87891-1501	---	---	15	---	1	38.10	35.56	11.30	5.84	2.97
	87891-1502	---	---	15	---	2	38.10	35.56	11.30	5.84	2.97
	87891-1503	---	---	15	---	3	38.10	35.56	11.30	5.84	2.97
	87891-1504	---	---	15	---	4	38.10	35.56	11.30	5.84	2.97
	87891-1505	---	---	15	---	5	38.10	35.56	11.30	5.84	2.97
	87891-1506	---	---	15	---	6	38.10	35.56	11.30	5.84	2.97

	PACKAGING OPTION PART NO.			CKT SIZE	VOID POSITION	PLATING TYPE	DIMENSION				
	TRAY	BULK	TUBE WITHOUT CAP				A	B	F	M	P
F	87891-1601	---	---	16	---	1	40.64	38.10	11.30	5.84	2.97
	87891-1602	---	---	16	---	2	40.64	38.10	11.30	5.84	2.97
	87891-1603	---	---	16	---	3	40.64	38.10	11.30	5.84	2.97
	87891-1604	---	---	16	---	4	40.64	38.10	11.30	5.84	2.97
	87891-1605	---	---	16	---	5	40.64	38.10	11.30	5.84	2.97
	87891-1606	---	---	16	---	6	40.64	38.10	11.30	5.84	2.97
E	87891-1701	---	---	17	---	1	43.18	40.64	11.30	5.84	2.97
	87891-1702	---	---	17	---	2	43.18	40.64	11.30	5.84	2.97
	87891-1703	---	---	17	---	3	43.18	40.64	11.30	5.84	2.97
	87891-1704	---	---	17	---	4	43.18	40.64	11.30	5.84	2.97
	87891-1705	---	---	17	---	5	43.18	40.64	11.30	5.84	2.97
	87891-1706	---	---	17	---	6	43.18	40.64	11.30	5.84	2.97
D	87891-1801	---	---	18	---	1	45.72	43.18	11.30	5.84	2.97
	87891-1802	---	---	18	---	2	45.72	43.18	11.30	5.84	2.97
	87891-1803	---	---	18	---	3	45.72	43.18	11.30	5.84	2.97
	87891-1804	---	---	18	---	4	45.72	43.18	11.30	5.84	2.97
	87891-1805	---	---	18	---	5	45.72	43.18	11.30	5.84	2.97
	87891-1806	---	---	18	---	6	45.72	43.18	11.30	5.84	2.97

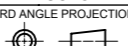
THIS DRAWING CONTAINS INFORMATION THAT IS PROPRIETARY TO MOLEX ELECTRONIC TECHNOLOGIES, LLC AND SHOULD NOT BE USED WITHOUT WRITTEN PERMISSION																	
DIMENSION UNITS		SCALE		CURRENT REV DESC:													
mm		NTS															
GENERAL TOLERANCES (UNLESS SPECIFIED)				EC NO: 679909 DRWN: AKUMAR19 2021/10/08 CHK'D: MRAMAKRISHNA 2021/10/11 APPR: MRAMAKRISHNA 2021/10/11 INITIAL REVISION: DRWN: YLQIAO 2004/12/06 APPR: SLOW 2004/12/07						CUSTOMER DRAWING							
ANGULAR TOL		± 3.0 °								DOCUMENT NUMBER		DOC TYPE		DOC PART		REVISION	
4 PLACES		±								SD-87891-013		PSD		001		B5	
3 PLACES		±								MATERIAL NUMBER		CUSTOMER		SHEET NUMBER			
2 PLACES		± 0.2								SEE TABLE		GENERAL MARKET		4 OF 8			
1 PLACE		±															
0 PLACES		±															
DRAFT WHERE APPLICABLE MUST REMAIN WITHIN DIMENSIONS				THIRD ANGLE PROJECTION		DRAWING		SERIES									
						A3-SIZE		87891									

DOCUMENT STATUS	P1	RELEASE DATE	2021/10/11	11:53:25
-----------------	----	--------------	------------	----------

10	9			8	7	6				
	PACKAGING OPTION PART NO.					CKT SIZE	VOID POSITION	PLATING TYPE	DIMENSION	
TRAY	BULK	TUBE WITHOUT CAP	A	B	F				M	P
87891-1901	---	---	19	---	1	48.26	45.72	11.30	5.84	2.97
87891-1902	---	---	19	---	2	48.26	45.72	11.30	5.84	2.97
87891-1903	---	---	19	---	3	48.26	45.72	11.30	5.84	2.97
87891-1904	---	---	19	---	4	48.26	45.72	11.30	5.84	2.97
87891-1905	---	---	19	---	5	48.26	45.72	11.30	5.84	2.97
87891-1906	---	---	19	---	6	48.26	45.72	11.30	5.84	2.97
87891-2001	---	---	20	---	1	50.80	48.26	11.30	5.84	2.97
87891-2002	---	---	20	---	2	50.80	48.26	11.30	5.84	2.97
87891-2003	---	---	20	---	3	50.80	48.26	11.30	5.84	2.97
87891-2004	---	---	20	---	4	50.80	48.26	11.30	5.84	2.97
87891-2005	---	---	20	---	5	50.80	48.26	11.30	5.84	2.97
87891-2006	---	---	20	---	6	50.80	48.26	11.30	5.84	2.97
87891-2101	---	---	21	---	1	53.34	50.80	11.30	5.84	2.97
87891-2102	---	---	21	---	2	53.34	50.80	11.30	5.84	2.97
87891-2103	---	---	21	---	3	53.34	50.80	11.30	5.84	2.97
87891-2104	---	---	21	---	4	53.34	50.80	11.30	5.84	2.97
87891-2105	---	---	21	---	5	53.34	50.80	11.30	5.84	2.97
87891-2106	---	---	21	---	6	53.34	50.80	11.30	5.84	2.97

4	3			2	1					
	PACKAGING OPTION PART NO.					CKT SIZE	VOID POSITION	PLATING TYPE	DIMENSION	
TRAY	BULK	TUBE WITHOUT CAP	A	B	F				M	P
87891-2201	---	---	22	---	1	55.88	53.34	11.30	5.84	2.97
87891-2202	---	---	22	---	2	55.88	53.34	11.30	5.84	2.97
87891-2203	---	---	22	---	3	55.88	53.34	11.30	5.84	2.97
87891-2204	---	---	22	---	4	55.88	53.34	11.30	5.84	2.97
87891-2205	---	---	22	---	5	55.88	53.34	11.30	5.84	2.97
87891-2206	---	---	22	---	6	55.88	53.34	11.30	5.84	2.97
87891-2301	---	---	23	---	1	58.42	55.88	11.30	5.84	2.97
87891-2302	---	---	23	---	2	58.42	55.88	11.30	5.84	2.97
87891-2303	---	---	23	---	3	58.42	55.88	11.30	5.84	2.97
87891-2304	---	---	23	---	4	58.42	55.88	11.30	5.84	2.97
87891-2305	---	---	23	---	5	58.42	55.88	11.30	5.84	2.97
87891-2306	---	---	23	---	6	58.42	55.88	11.30	5.84	2.97
87891-2401	---	---	24	---	1	60.96	58.42	11.30	5.84	2.97
87891-2402	---	---	24	---	2	60.96	58.42	11.30	5.84	2.97
87891-2403	---	---	24	---	3	60.96	58.42	11.30	5.84	2.97
87891-2404	---	---	24	---	4	60.96	58.42	11.30	5.84	2.97
87891-2405	---	---	24	---	5	60.96	58.42	11.30	5.84	2.97
87891-2406	---	---	24	---	6	60.96	58.42	11.30	5.84	2.97

DOCUMENT STATUS	P1	RELEASE DATE	2021/10/11	11:53:25
-----------------	----	--------------	------------	----------

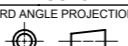
THIS DRAWING CONTAINS INFORMATION THAT IS PROPRIETARY TO MOLEX ELECTRONIC TECHNOLOGIES, LLC AND SHOULD NOT BE USED WITHOUT WRITTEN PERMISSION											
DIMENSION UNITS	SCALE	CURRENT REV DESC:									
mm	NTS	 CUSTOM HEADER 2.54MM PITCH, SINGLE ROW SINGLE WAFER, T/H HEADER PRODUCT CUSTOMER DRAWING									
GENERAL TOLERANCES (UNLESS SPECIFIED)											
ANGULAR TOL	± 3.0 °										
4 PLACES	±										
3 PLACES	±										
2 PLACES	± 0.2	EC NO: 679909	DRWN: AKUMAR19	2021/10/08	DOCUMENT NUMBER				DOC TYPE	DOC PART	REVISION
1 PLACE	±	CHK'D: MRAMAKRISHNA	2021/10/11	SD-87891-013				PSD	001	B5	
0 PLACES	±	APPR: MRAMAKRISHNA	2021/10/11	INITIAL REVISION:				SHEET NUMBER			
DRAFT WHERE APPLICABLE MUST REMAIN WITHIN DIMENSIONS		THIRD ANGLE PROJECTION	DRAWING	SERIES	MATERIAL NUMBER	CUSTOMER	SEE TABLE				
			A3-SIZE	87891	GENERAL MARKET	5 OF 8					

PACKAGING OPTION PART NO.			CKT SIZE	VOID POSITION	PLATING TYPE	DIMENSION				
TRAY	BULK	TUBE WITHOUT CAP				A	B	F	M	P
87891-2501	---	---	25	---	1	63.50	60.96	11.30	5.84	2.97
87891-2502	---	---	25	---	2	63.50	60.96	11.30	5.84	2.97
87891-2503	---	---	25	---	3	63.50	60.96	11.30	5.84	2.97
87891-2504	---	---	25	---	4	63.50	60.96	11.30	5.84	2.97
87891-2505	---	---	25	---	5	63.50	60.96	11.30	5.84	2.97
87891-2506	---	---	25	---	6	63.50	60.96	11.30	5.84	2.97
---	87891-2611	---	26	---	1	66.04	63.50	11.30	5.84	2.97
---	87891-2602	---	26	---	2	66.04	63.50	11.30	5.84	2.97
---	87891-2603	---	26	---	3	66.04	63.50	11.30	5.84	2.97
---	87891-2604	---	26	---	4	66.04	63.50	11.30	5.84	2.97
---	87891-2605	---	26	---	5	66.04	63.50	11.30	5.84	2.97
---	87891-2606	---	26	---	6	66.04	63.50	11.30	5.84	2.97
---	87891-2701	---	27	---	1	68.58	66.04	11.30	5.84	2.97
---	87891-2702	---	27	---	2	68.58	66.04	11.30	5.84	2.97
---	87891-2703	---	27	---	3	68.58	66.04	11.30	5.84	2.97
---	87891-2704	---	27	---	4	68.58	66.04	11.30	5.84	2.97
---	87891-2705	---	27	---	5	68.58	66.04	11.30	5.84	2.97
---	87891-2706	---	27	---	6	68.58	66.04	11.30	5.84	2.97

PACKAGING OPTION PART NO.			CKT SIZE	VOID POSITION	PLATING TYPE	DIMENSION				
TRAY	BULK	TUBE WITHOUT CAP				A	B	F	M	P
---	87891-2801	---	28	---	1	71.12	68.58	11.30	5.84	2.97
---	87891-2802	---	28	---	2	71.12	68.58	11.30	5.84	2.97
---	87891-2803	---	28	---	3	71.12	68.58	11.30	5.84	2.97
---	87891-2804	---	28	---	4	71.12	68.58	11.30	5.84	2.97
---	87891-2805	---	28	---	5	71.12	68.58	11.30	5.84	2.97
---	87891-2806	---	28	---	6	71.12	68.58	11.30	5.84	2.97
---	87891-2901	---	29	---	1	73.66	71.12	11.30	5.84	2.97
---	87891-2902	---	29	---	2	73.66	71.12	11.30	5.84	2.97
---	87891-2903	---	29	---	3	73.66	71.12	11.30	5.84	2.97
---	87891-2904	---	29	---	4	73.66	71.12	11.30	5.84	2.97
---	87891-2905	---	29	---	5	73.66	71.12	11.30	5.84	2.97
---	87891-2906	---	29	---	6	73.66	71.12	11.30	5.84	2.97
---	87891-3001	---	30	---	1	76.20	73.66	11.30	5.84	2.97
---	87891-3002	---	30	---	2	76.20	73.66	11.30	5.84	2.97
---	87891-3003	---	30	---	3	76.20	73.66	11.30	5.84	2.97
---	87891-3004	---	30	---	4	76.20	73.66	11.30	5.84	2.97
---	87891-3005	---	30	---	5	76.20	73.66	11.30	5.84	2.97
---	87891-3006	---	30	---	6	76.20	73.66	11.30	5.84	2.97

DOCUMENT STATUS	P1	RELEASE DATE	2021/10/11	11:53:25
-----------------	----	--------------	------------	----------

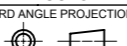
THIS DRAWING CONTAINS INFORMATION THAT IS PROPRIETARY TO MOLEX ELECTRONIC TECHNOLOGIES, LLC AND SHOULD NOT BE USED WITHOUT WRITTEN PERMISSION									
DIMENSION UNITS	SCALE	CURRENT REV DESC:			 CUSTOMER HEADER 2.54MM PITCH, SINGLE ROW SINGLE WAFER, T/H HEADER				
mm	NTS								
GENERAL TOLERANCES (UNLESS SPECIFIED)		EC NO: 679909			PRODUCT CUSTOMER DRAWING DOCUMENT NUMBER: SD-87891-013 DOC TYPE: PSD DOC PART: 001 REVISION: B5				
ANGULAR TOL ± 3.0 °		DRWN: AKUMAR19 2021/10/08							
4 PLACES ±	CHK'D: MRAMAKRISHNA 2021/10/11			MATERIAL NUMBER: SEE TABLE CUSTOMER: GENERAL MARKET SHEET NUMBER: 6 OF 8					
3 PLACES ±	APPR: MRAMAKRISHNA 2021/10/11								
2 PLACES ± 0.2	INITIAL REVISION:			THIRD ANGLE PROJECTION:  DRAWING: A3-SIZE SERIES: 87891					
1 PLACE ±	DRWN: YLQIAO 2004/12/06								
0 PLACES ±	APPR: SLOW 2004/12/07								
DRAFT WHERE APPLICABLE MUST REMAIN WITHIN DIMENSIONS									

PACKAGING OPTION PART NO.			CKT SIZE	VOID POSITION	PLATING TYPE	DIMENSION				
TRAY	BULK	TUBE WITHOUT CAP				A	B	F	M	P
---	87891-3101	---	31	---	1	78.74	76.20	11.30	5.84	2.97
---	87891-3102	---	31	---	2	78.74	76.20	11.30	5.84	2.97
---	87891-3103	---	31	---	3	78.74	76.20	11.30	5.84	2.97
---	87891-3104	---	31	---	4	78.74	76.20	11.30	5.84	2.97
---	87891-3105	---	31	---	5	78.74	76.20	11.30	5.84	2.97
---	87891-3106	---	31	---	6	78.74	76.20	11.30	5.84	2.97
---	87891-3201	---	32	---	1	81.28	78.74	11.30	5.84	2.97
---	87891-3202	---	32	---	2	81.28	78.74	11.30	5.84	2.97
---	87891-3203	---	32	---	3	81.28	78.74	11.30	5.84	2.97
---	87891-3204	---	32	---	4	81.28	78.74	11.30	5.84	2.97
---	87891-3205	---	32	---	5	81.28	78.74	11.30	5.84	2.97
---	87891-3206	---	32	---	6	81.28	78.74	11.30	5.84	2.97
---	87891-3301	---	33	---	1	83.82	81.28	11.30	5.84	2.97
---	87891-3302	---	33	---	2	83.82	81.28	11.30	5.84	2.97
---	87891-3303	---	33	---	3	83.82	81.28	11.30	5.84	2.97
---	87891-3304	---	33	---	4	83.82	81.28	11.30	5.84	2.97
---	87891-3305	---	33	---	5	83.82	81.28	11.30	5.84	2.97
---	87891-3306	---	33	---	6	83.82	81.28	11.30	5.84	2.97

PACKAGING OPTION PART NO.			CKT SIZE	VOID POSITION	PLATING TYPE	DIMENSION				
TRAY	BULK	TUBE WITHOUT CAP				A	B	F	M	P
---	87891-3401	---	34	---	1	86.36	83.82	11.30	5.84	2.97
---	87891-3402	---	34	---	2	86.36	83.82	11.30	5.84	2.97
---	87891-3403	---	34	---	3	86.36	83.82	11.30	5.84	2.97
---	87891-3404	---	34	---	4	86.36	83.82	11.30	5.84	2.97
---	87891-3405	---	34	---	5	86.36	83.82	11.30	5.84	2.97
---	87891-3406	---	34	---	6	86.36	83.82	11.30	5.84	2.97
---	87891-3501	---	35	---	1	88.90	86.36	11.30	5.84	2.97
---	87891-3502	---	35	---	2	88.90	86.36	11.30	5.84	2.97
---	87891-3503	---	35	---	3	88.90	86.36	11.30	5.84	2.97
---	87891-3504	---	35	---	4	88.90	86.36	11.30	5.84	2.97
---	87891-3505	---	35	---	5	88.90	86.36	11.30	5.84	2.97
---	87891-3506	---	35	---	6	88.90	86.36	11.30	5.84	2.97
---	87891-3611	---	36	---	1	91.44	88.90	11.30	5.84	2.97
---	87891-3602	---	36	---	2	91.44	88.90	11.30	5.84	2.97
---	87891-3603	---	36	---	3	91.44	88.90	11.30	5.84	2.97
---	87891-3604	---	36	---	4	91.44	88.90	11.30	5.84	2.97
---	87891-3605	---	36	---	5	91.44	88.90	11.30	5.84	2.97
---	87891-3606	---	36	---	6	91.44	88.90	11.30	5.84	2.97

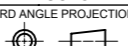
THIS DRAWING CONTAINS INFORMATION THAT IS PROPRIETARY TO MOLEX ELECTRONIC TECHNOLOGIES, LLC AND SHOULD NOT BE USED WITHOUT WRITTEN PERMISSION													
DIMENSION UNITS		SCALE		CURRENT REV DESC:									
mm		NTS											
GENERAL TOLERANCES (UNLESS SPECIFIED)				EC NO: 679909 DRWN: AKUMAR19 2021/10/08 CHK'D: MRAMAKRISHNA 2021/10/11 APPR: MRAMAKRISHNA 2021/10/11 INITIAL REVISION: DRWN: YLQIAO 2004/12/06 APPR: SLOW 2004/12/07				CUSTOMER DRAWING					
ANGULAR TOL		± 3.0 °						DOCUMENT NUMBER		DOC TYPE		DOC PART	
4 PLACES		±						SD-87891-013		PSD		001	
3 PLACES		±						REVISION		B5			
2 PLACES		± 0.2						MATERIAL NUMBER		CUSTOMER		SHEET NUMBER	
1 PLACE		±		SEE TABLE		GENERAL MARKET		7 OF 8					
0 PLACES		±		THIRD ANGLE PROJECTION		DRAWING		SERIES					
DRAFT WHERE APPLICABLE MUST REMAIN WITHIN DIMENSIONS				A3-SIZE		87891							

DOCUMENT STATUS	P1	RELEASE DATE	2021/10/11	11:53:25
-----------------	----	--------------	------------	----------

