

TOLERANCE UNLESS OTHERWISE SPECIFIED	
.X	±0.25
.XX	±0.13
.XXX	±0.10

THIS IS A C.A.D. GENERATED DRAWING  
DO NOT MAKE MANUAL REVISIONS TO MASTER.

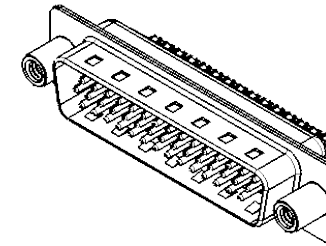

ISSUE NUMBER	
ORIGINAL	①

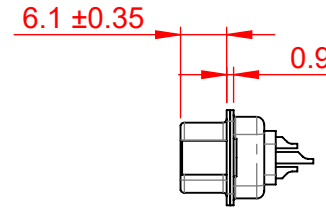
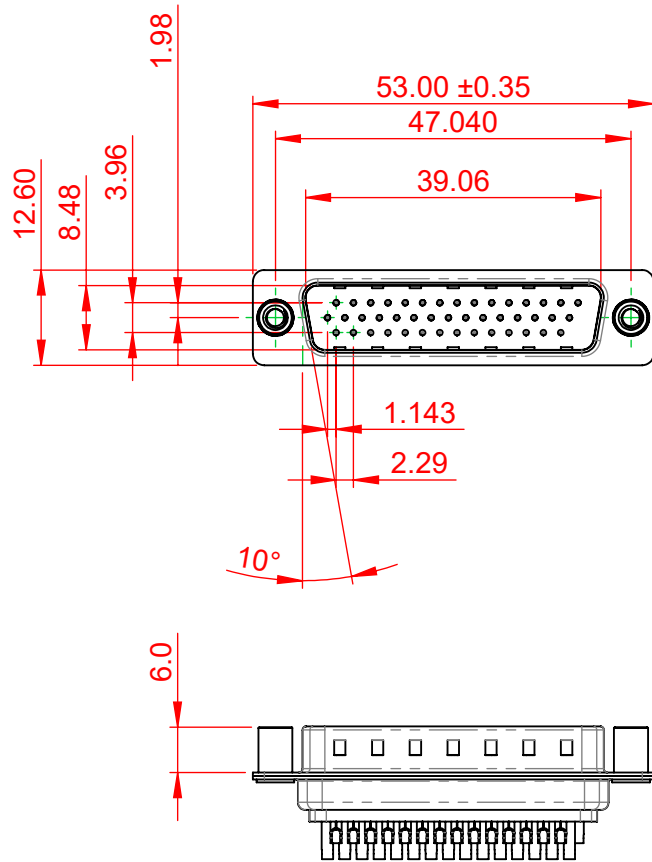

**NOTES:**

**MATERIAL:**  
**HOUSING:**  
**SHELL:**  
**CONTACT:**

**THERMOPLASTIC POLYESTER, UL94V-0**  
**STEEL, NICKEL PLATED**  
**COPPER ALLOY, GOLD FLASH PLATED**

**OPERATING TEMPERATURE: -55°C TO +85°C**

**CURRENT RATING: 3A PER CONTACT**  
**CONTACT RESISTANCE: 25mΩ MAX.**  
**INSULATOR RESISTANCE: 5000MΩ min.**  
**DIELECTRIC**  
**WITHSTANDING VOLTAGE: 1000V AC rms**



THIS SERIES FULLY CONFORMS TO  
THE EUROPEAN UNION DIRECTIVES  
2011/65/EU FOR RoHS COMPLIANCY.



YOUR CONNECTION TO QUALITY & SERVICE

EDAC INC  
TORONTO, ONTARIO  
CANADA

THESE DRAWINGS AND SPECIFICATIONS  
ARE THE PROPERTY OF EDAC INC., AND  
SHALL NOT BE REPRODUCED, OR COPIED  
OR USED AS THE BASIS FOR THE  
MANUFACTURE OR SALE OF APPARATUS  
WITHOUT WRITTEN PERMISSION.

**637 SERIES D-SUB CONNECTOR**

SW REFERENCE NO.: 637 ASSEMBLY	
DRAWN: C.B	DATE: AUG. 01/2018
CHECKED:	DATE:
SCALE: 1:1	SHEET 1 OF 1
DRAWING NUMBER: 637-044-232-048	ISSUE
PART NUMBER: 637-044-232-048	1