

GENERAL DESCRIPTION

The ADISEVAL is a PC-based evaluation system for many of the iSensor™ products. It comes with a Parallel Interface Board, parallel interface cable, 2 12-pin ribbon cables, and the iSensor™ CD, which contains product documentation and evaluation software.

GETTING STARTED

Getting started with this system requires four simple steps.

1. Connect J2 of the Parallel Interface Board (see Figure 1) to the appropriate power supply, using Table 1. For simplicity, connect pin 1 to pin 4 and connect pin 2 to pin 3. Set the voltage on the power supply per Table 2. Turn power off.
2. Install the ADIS16XXX/PCBZ evaluation board on the Parallel Interface Board, using 2mm machine screws and the two 12-pin ribbon cables, as shown in Figure 2. Make sure that these cables are aligned correctly on each header before applying power. Hook up the system to a PC using the parallel cable.
3. Locate the product-specific evaluation software on the iSensor™ CD or download it from: www.analog.com/isensor-evaluation. See Table 3 for a list of products supported by each installation package.
4. Unpack the zip file and double click on the setup.exe file. Follow the prompts to install the software.
5. Go to the created directory. In most cases, this will be a subdirectory under "C:\ProgramFiles\Analog Devices iSensors\". Double-click on the giveio.exe. Follow the prompts to install this driver, which enables the parallel port communications in the PC.
6. Double click on the ADIS*.exe file to start the software.
7. Click on "Interface" and select, "Parallel." Enter the address of the parallel port on the PC and click the "OK" button. The parallel port address can be found under the Device Manager in Windows XP.

The software contains help files that describe each function of the software. The right button on the mouse has the ability to speed up changes when the Pointer is placed over titles, graph axes and waveform data.

See Figure 4 (ADIS16003, ADIS16006), Figure 5 (ADIS16080, ADIS16100), Figure 6 (ADIS16201), Figure 7 (ADIS16203), Figure 8 (ADIS16209) and Figure 9 (ADIS16250) for basic software assistance.

Table 1. Power Supply Hook-up – J2

Pin Number	Function
1	Digital I/O Power Supply
2	Common
3	Common
4	Sensor Power Supply

NOTE: No reverse polarity protection provided.

Table 2. Power Supply Voltages

Evaluation Board	Power Supply Voltage
ADIS16003/PCBZ	+3.0 to +5.25V
ADIS16006/PCBZ	+3.0 to +5.25V
ADIS16060/PCBZ	+4.75 to +5.25V
ADIS16080/PCBZ	+4.75 to +5.25V
ADIS16100/PCB	+4.75 to +5.25V
ADIS1620x/PCBZ	+3.0 to +3.6V
ADIS1625x/PCBZ	+4.75 to +5.25V

Table 3. Evaluation Software

Installation Package Filename	Supported Products
003ES(x).zip	ADIS16003 ADIS16006 ADIS16060 ADIS16080 ADIS16100
201ES(x).zip	ADIS16201
203ES(x).zip	ADIS16203
204ES(x).zip	ADIS16024
209ES(x).zip	ADIS16209
250ES(x).zip	ADIS16250 ADIS16251 ADIS16255

ORDERING GUIDE

Model	Package Description
ADISEVAL	iSensor™ PC Evaluation System

Rev. Pr.C

Information furnished by Analog Devices is believed to be accurate and reliable. However, no responsibility is assumed by Analog Devices for its use, nor for any infringements of patents or other rights of third parties that may result from its use. Specifications subject to change without notice. No license is granted by implication or otherwise under any patent or patent rights of Analog Devices. Trademarks and registered trademarks are the property of their respective owners.

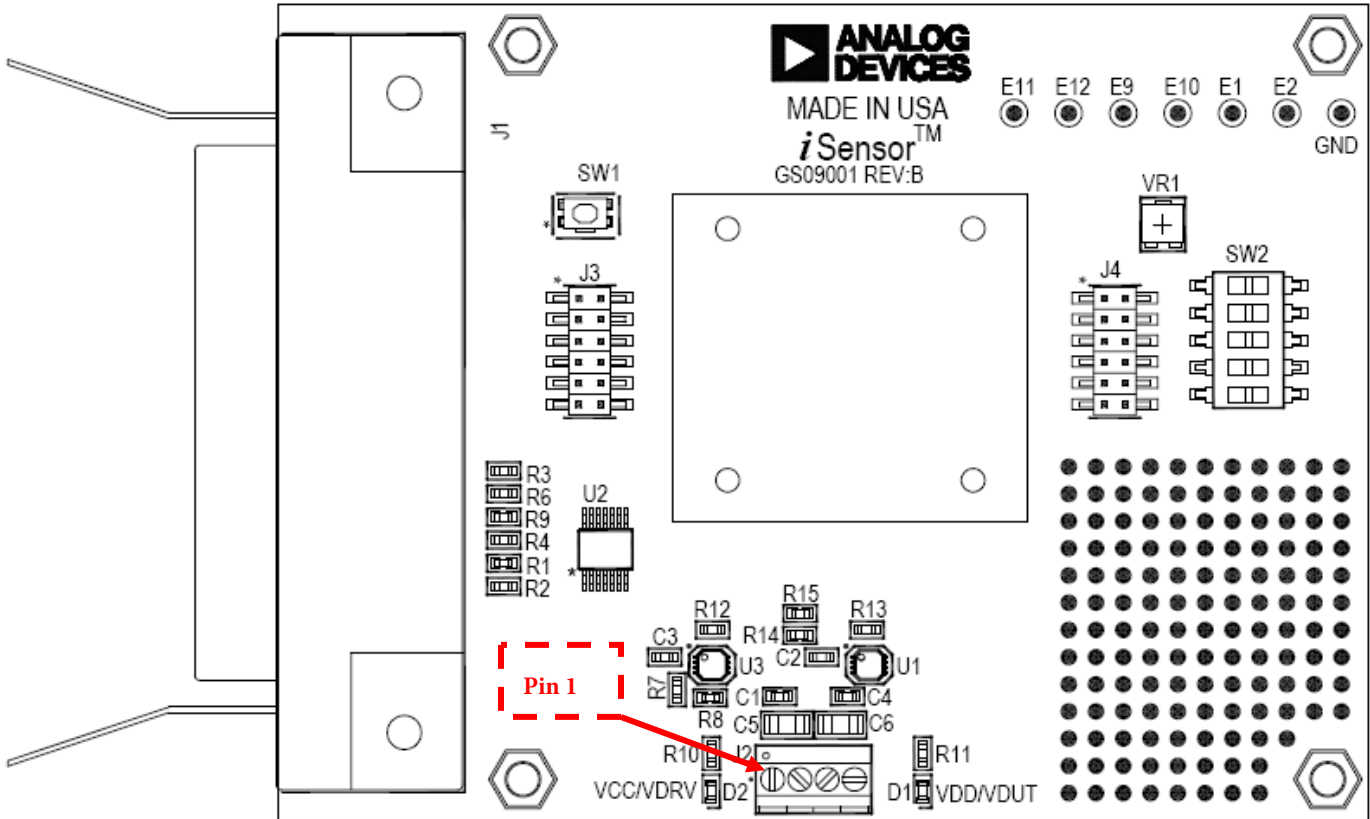

DO NOT INSTALL U1, U3, R7, R8, R14 AND R15.

Figure 1 – iSensor™ PC Interface Board Layout

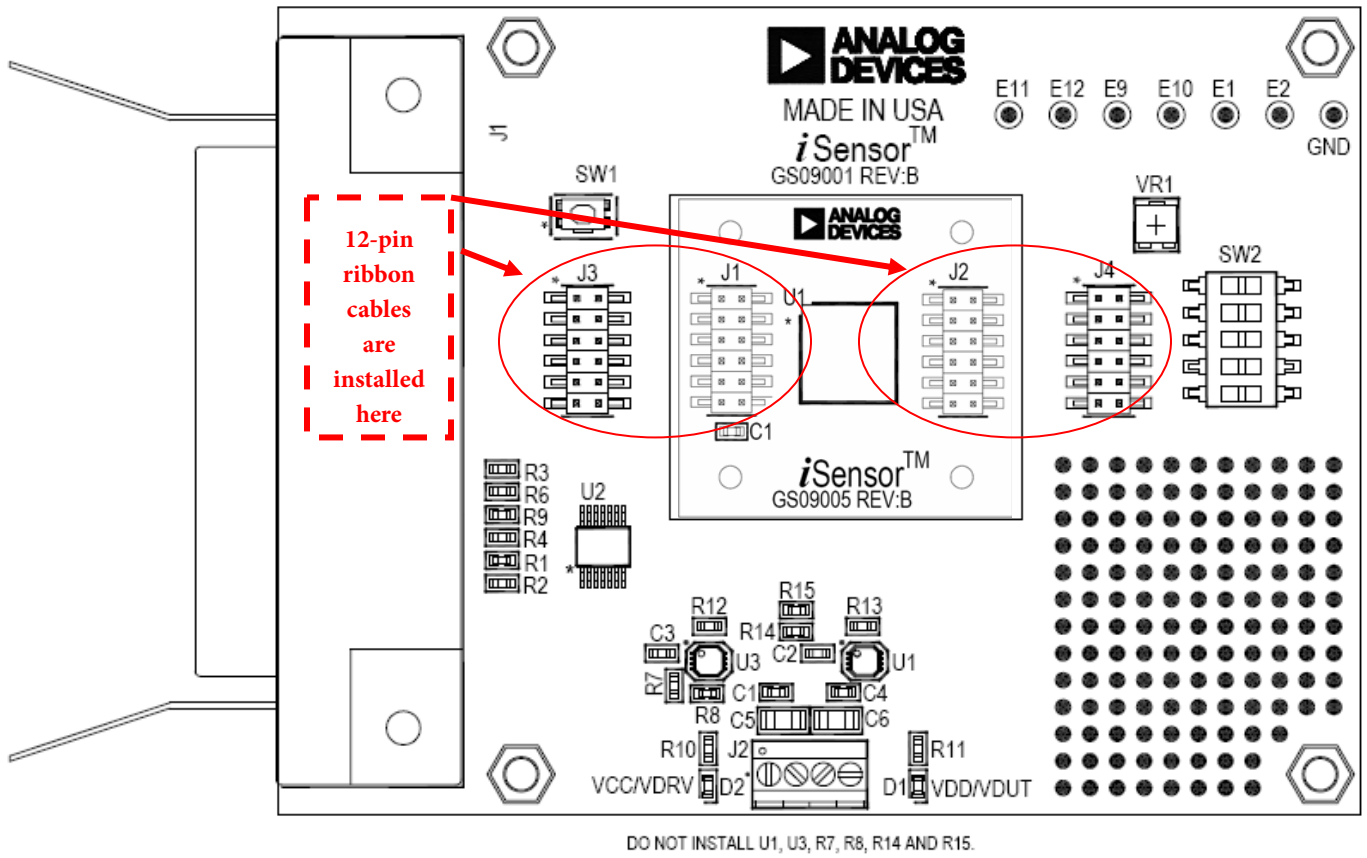

Figure 2 – iSensor™ PC Interface Board with ADIS16201/PCBZ installed

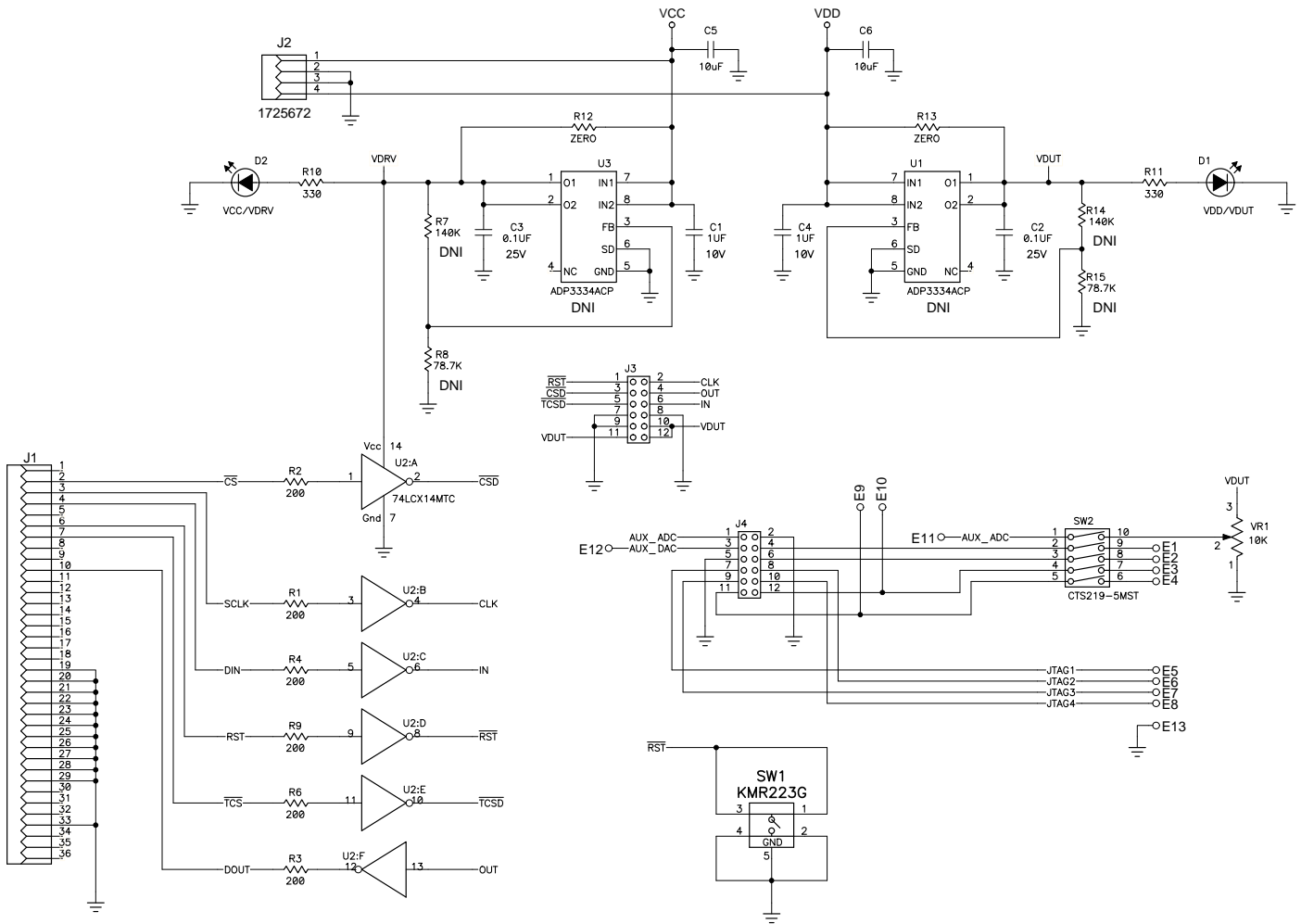

Figure 3 – iSensor™ MPC Evaluation Board Schematic



FIGURE FLAG NOTES:

1. Set the Device type to ADIS16003 or ADIS16006.
2. Set the axis to measure. Test function exercises a self-test during a single sweep on the screen.
3. Plot and log data to files.
4. Set up data logging parameters.
5. Right click over Y-Axis to adjust scale and offset of the plot.

Figure 4. ADIS16003 and ADIS16006 Evaluation Software

ADISEVAL

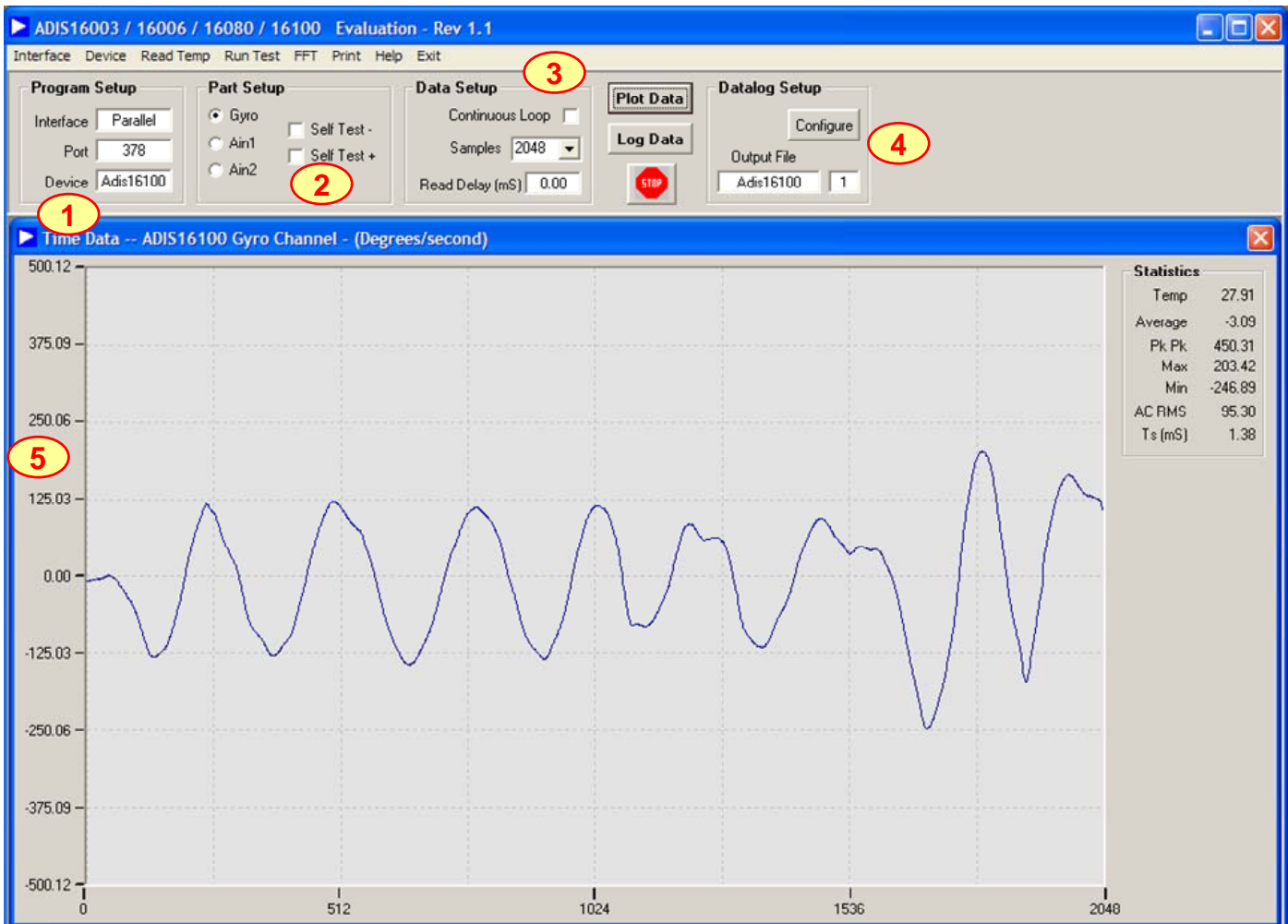

FIGURE FLAG NOTES:

1. Set the Device type to ADIS16060, ADIS16080 or ADIS16100.
2. Set the output channel to measure. Test function exercises a self-test during a single sweep on the screen.
3. Plot and log data to files.
4. Set up data logging parameters.
5. Right click over Y-Axis to adjust scale and offset of the plot.

Figure 5. ADIS16060, ADIS16080 and ADIS16100 Evaluation Software Screen

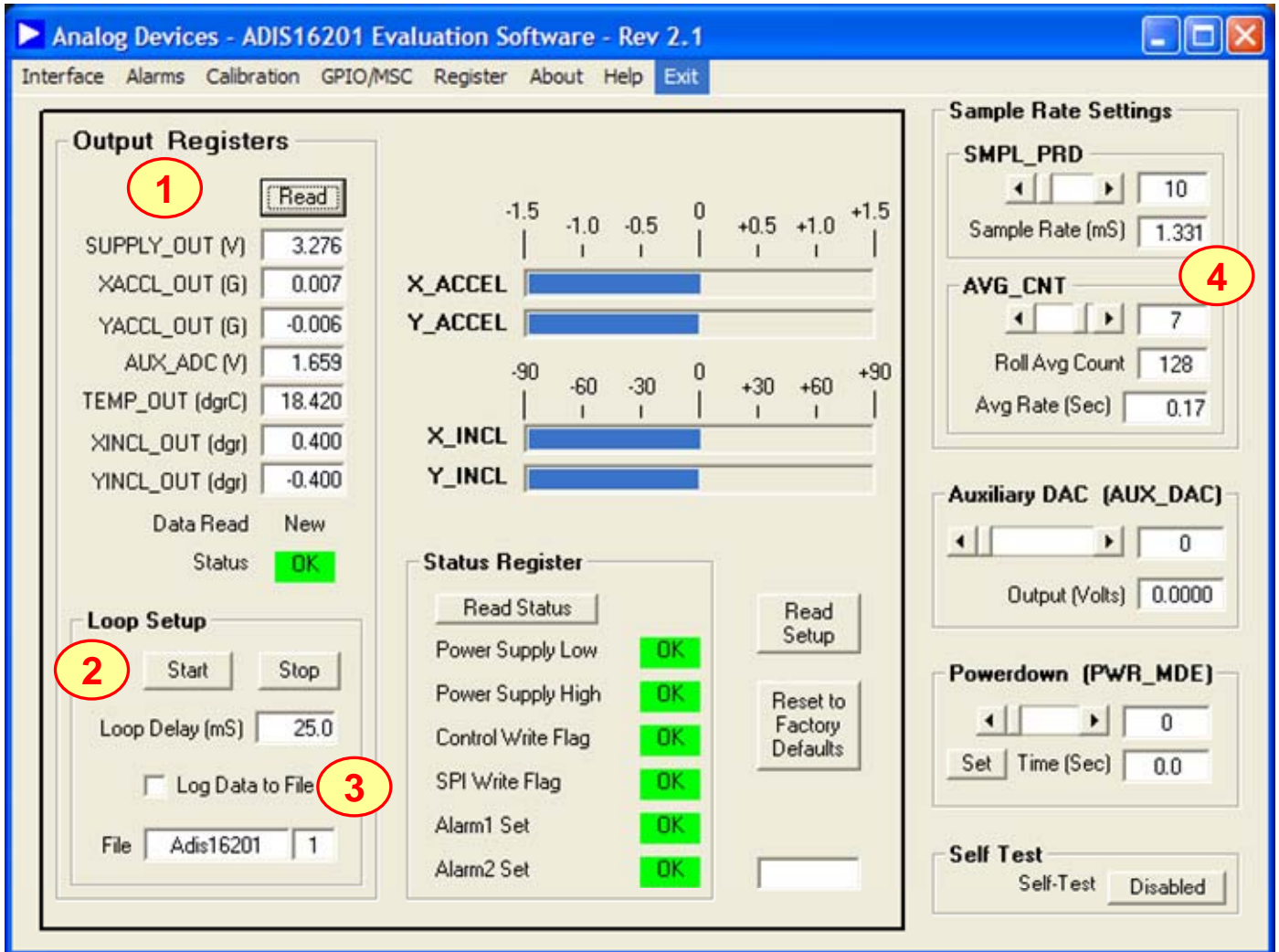

FIGURE FLAG NOTES:

1. Perform a single read of the ADIS16201's output data
2. Start and stop continuous reading of the ADIS16201's output data. The acquisition loop delay time provides rough control over sample times. Please note that this data will not have a high degree of coherence.
3. Select the file data logging option.
4. Configure the ADIS16201's internal sample rate and filter response.

Figure 6. ADIS16201 Evaluation Software

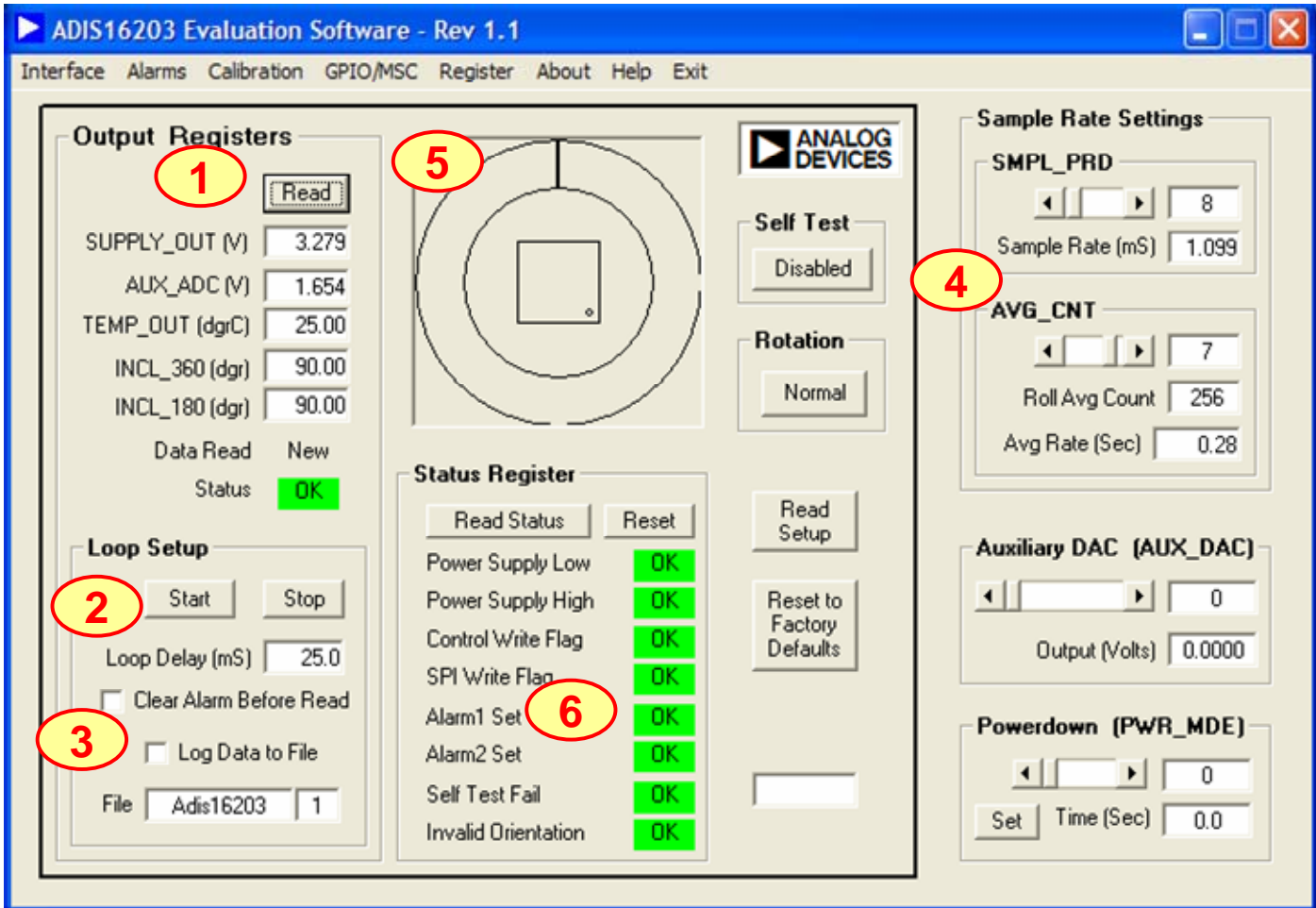

FIGURE FLAG NOTES:

1. Perform a single read of the ADIS16203's output data
2. Start and stop continuous reading of the ADIS16203's output data. The acquisition loop delay time provides rough control over sample times. Please note that this data will not have a high degree of coherence.
3. Select the file data logging option.
4. Configure the ADIS16203's internal sample rate and filter response.
5. Graphical orientation. Note that for incline angle - 0°, the corner dot would be in the lower, left hand corner.
6. Alarm monitoring. Note that these turn red on alarm condition. They maintain their status until the Reset button is pressed, even if the error condition has cleared.

Figure 7. ADIS16203 Evaluation Software

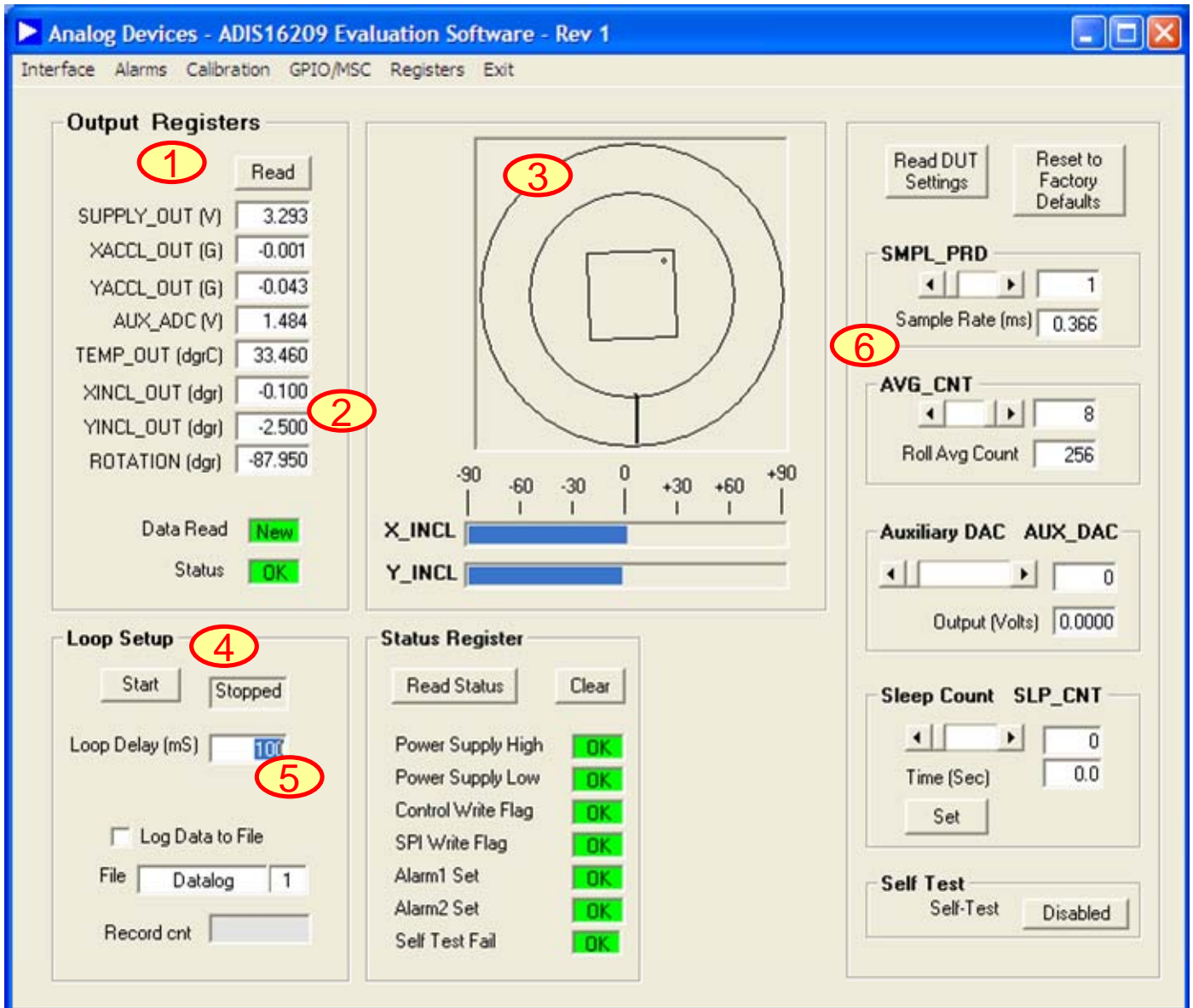

FIGURE FLAG NOTES:

1. Perform a single read of the ADIS16209’s output data
2. XINCL_OUT and YINCL_OUT are horizontal incline outputs. ROTATION is the vertical-oriented rotational position measurement. This requires the X and Y axes to be in the vertical plane, with respect to the earth’s surface.
3. This graph displays the vertical oriented, rotational position. This requires the X and Y axes to be in the vertical plane, with respect to the earth’s surface.
4. Start and stop continuous reading of the ADIS16209’s output data. The acquisition loop time provides rough control over sample times. Please note that this data will not have a high degree of coherence.
5. The acquisition loop time provides rough control over sample times. Please note that this data will not have a high degree of coherence.

ADISEVAL

- Configure the ADIS16209's internal sample rate and filter response.

Figure 8. ADIS16209 Evaluation Software

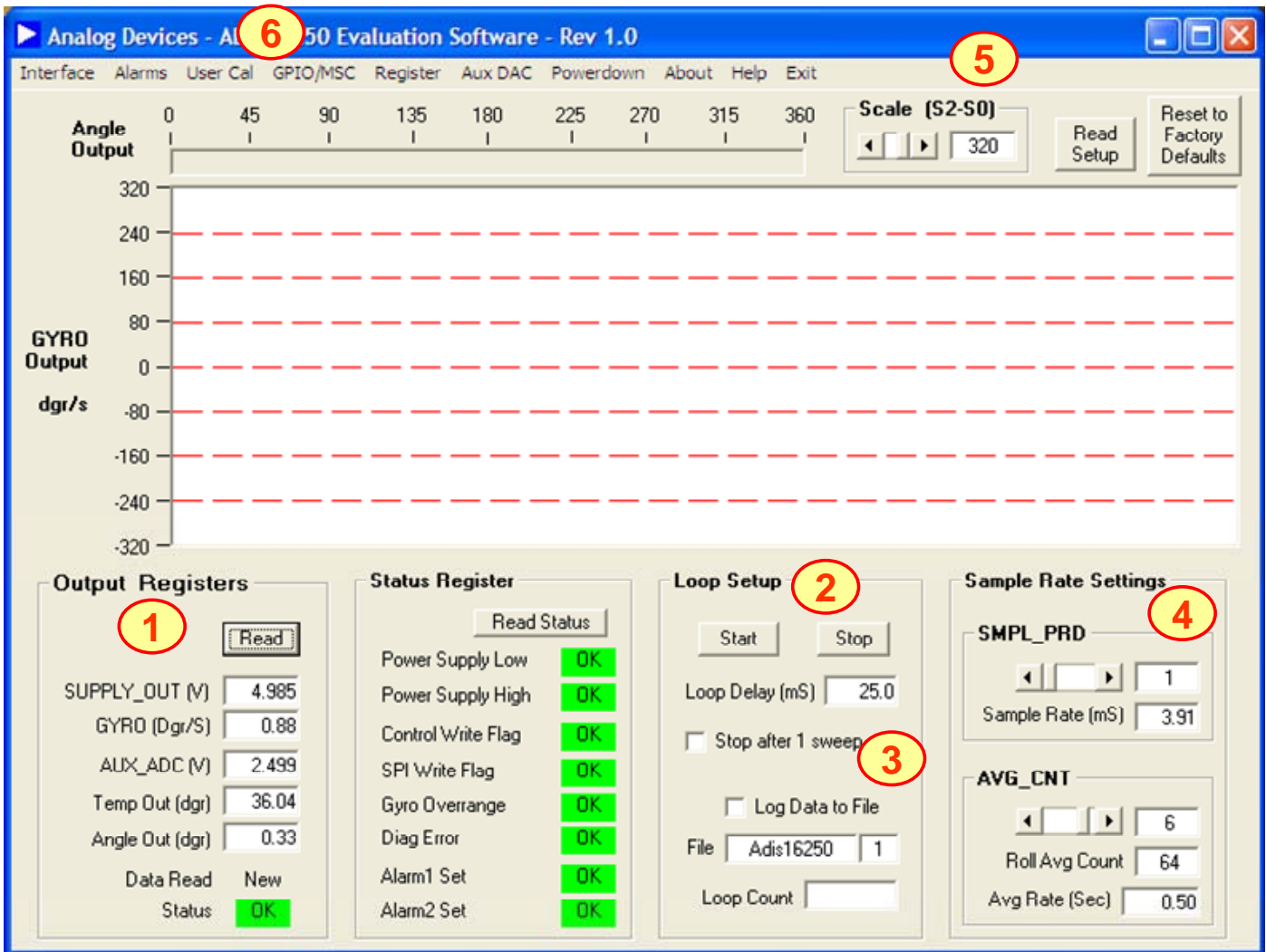

FIGURE FLAG NOTES:

- Perform a single read of the ADIS16250's output data
- Start and stop continuous reading of the ADIS16250's output data. The acquisition loop delay time provides rough control over sample times. Please note that this data will not have a high degree of coherence.
- Select the file data logging option.
- Configure the ADIS16250's internal sample rate and filter response.
- Set the measurement range from the three options available in the ADIS16250.
- Exercise the user calibration functions.
- Note, for the ADIS16251, divide the data by a factor of 4. The ADIS16255 data requires no scaling.

Figure 9. ADIS16250 Evaluation Software