



ANT-GNCP-TH258L15

L1/L5 Ceramic Patch GNSS Antenna

The ANT-GNCP-TH258L15 is a stacked ceramic patch antenna for GPS/ GALILEO/ BeiDou, IRNSS, QZSS global navigation satellite system (GNSS) operation in the L1 and L5 frequency bands. The ANT-GNCP-TH258L15 provides excellent gain and radiation pattern performance supporting solutions with high location accuracy, rapid satellite signal reception and lock, and quick time to first fix.

The ANT-GNCP-TH258L15 offers an extended temperature range to +105 °C for compliance to automotive standard AEC-Q200 Grade 2. The antenna is mounted via attached adhesive patch and has a solder pin signal connection.

FEATURES

- Directional radiation pattern orthogonal to antenna surface
- Right-hand circularly polarized (RHCP)
- Extended operation to +105 °C
- AEC-Q200 Grade 2 compliance
- Adhesive mounting to PCB
- Solder pin signal connection

APPLICATIONS

- Global navigation GNSS L1/L5
 - GPS
 - Galileo
 - II
 - Beidou B1-BOC L1
 - IRNSS
 - QZSS
- Timing solutions
- Automotive

ORDERING INFORMATION

Part Number	Description
ANT-GNCP-TH258L15	GNSS ceramic patch antenna with pin-type solder connection

Available from Linx Technologies and select distributors and representatives.

TABLE 1. ELECTRICAL SPECIFICATIONS

ANT-GNCP-TH258L15	GPS L1, GALILEO E1, II L1, Beidou B1-BOC, IRNSS, QZSS L1	GPS L5, GALILEO E5a, II L5, QZSS L5
Center Frequency	1580.89 MHz	1176.45 MHz
Frequency Range	1553.10 MHz to 1608.68 MHz	1170 MHz to 1183 MHz
VSWR (max)	5.9	6.4
Peak Gain (dBi)	5.6	1.0
Average Gain RHCP (dBi)	4.8	-2.4
Axial Ratio (dBiC)	11.2	17.4
Efficiency (%)	74	46
Polarization	RHCP	
Radiation	Omnidirectional	
Wavelength	1/4-wave	
Impedance	50 Ω	
Electrical Type	Radiating Patch	
Operating Temp. Range	-40 °C to +105 °C	
ESD Sensitivity	NOT ESD sensitive. As a best practice, Linx may use ESD packaging.	

Electrical specifications and plots measured with a 70 mm x 70 mm (2.76 in x 2.76 in) reference ground plane.

TABLE 2. MECHANICAL SPECIFICATIONS

Parameter	Value
Connection	Pin Type (Through hole)
Weight	17.0 g (0.60 oz)
Dimensions	25.1 mm x 25.1 mm x 8.0 mm (0.99 in x 0.99 in x 0.31 in)

Product Dimensions

Figure 1 provides dimensions of the ANT-GNCP-TH258L15.

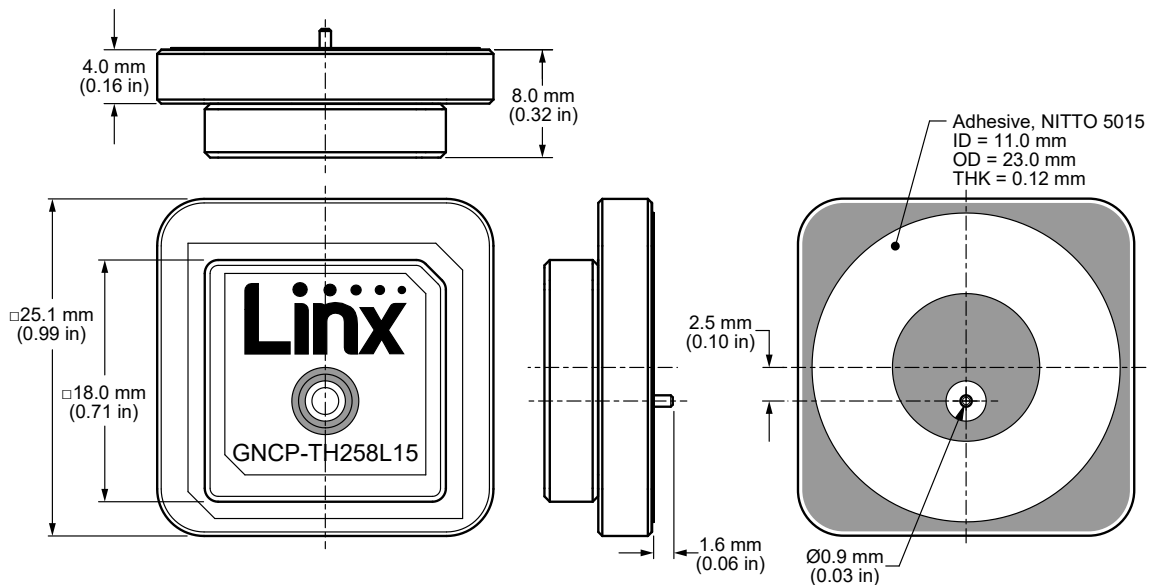

Figure 6. ANT-GNCP-CA188L165 Antenna Dimensions

VSWR

Figure 2 provides the voltage standing wave ratio (VSWR) across the L1 band, and Figure 3 provides VSWR across the L5 band. VSWR describes the power reflected from the antenna back to the radio. A lower VSWR value indicates better antenna performance at a given frequency. Reflected power is also shown on the right-side vertical axis as a gauge of the percentage of transmitter power reflected back from the antenna.

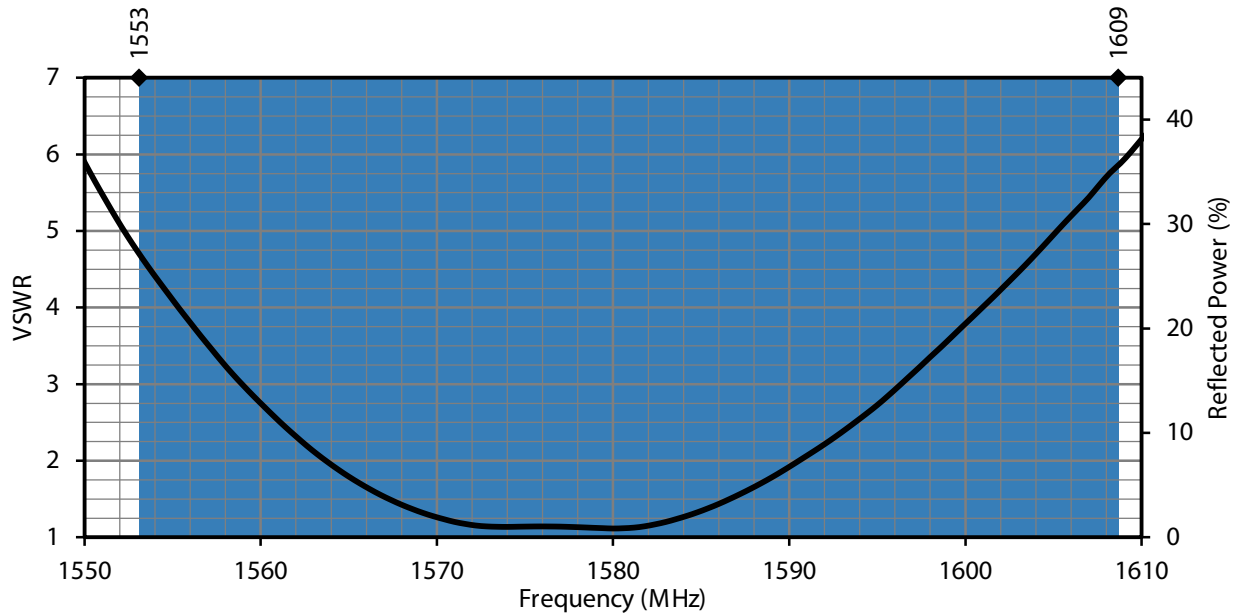

Figure 2. ANT-GNCP-TH258L15 VSWR, L1 Band

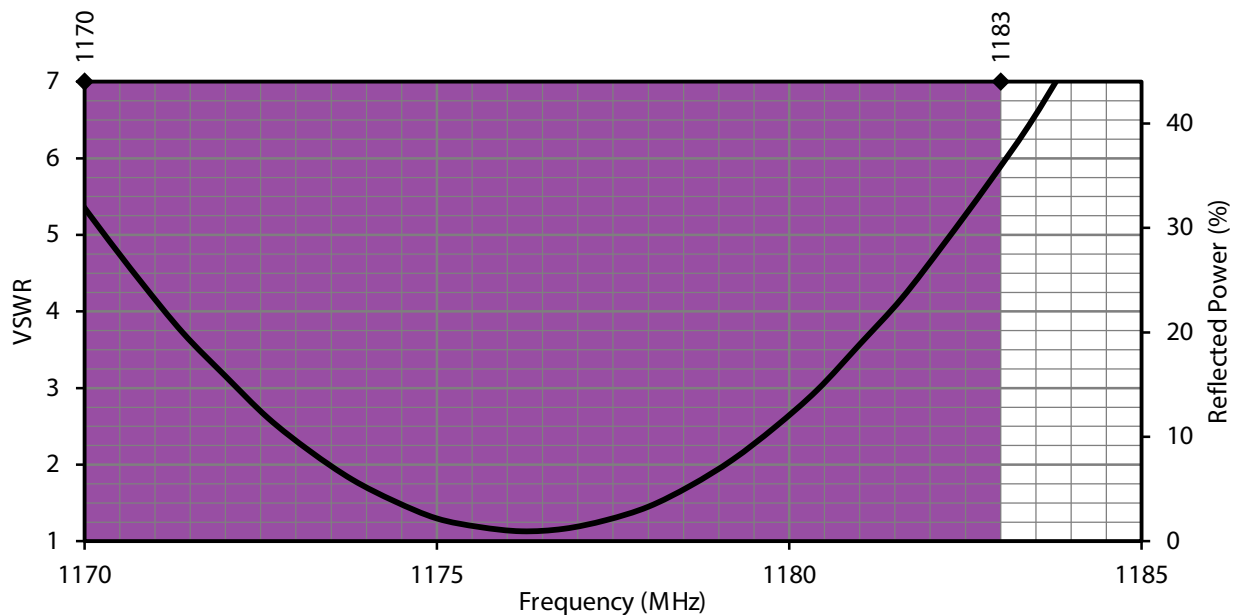

Figure 3. ANT-GNCP-TH258L15 VSWR, L5 Band

RETURN LOSS

Return loss, shown in Figure 4 (L1 band) and Figure 5 (L5 band), represents the loss in power at the antenna due to reflected signals. Like VSWR, a lower return loss value indicates better antenna performance at a given frequency.

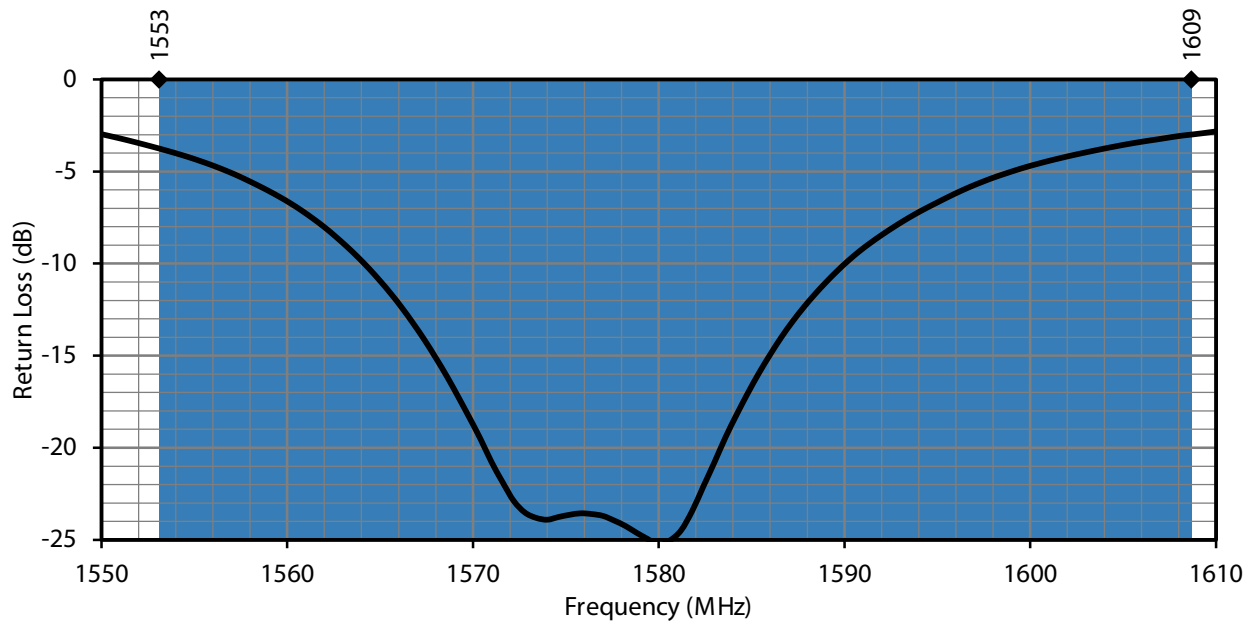

Figure 4. ANT-GNCP-TH258L15 Return Loss, L1 Band

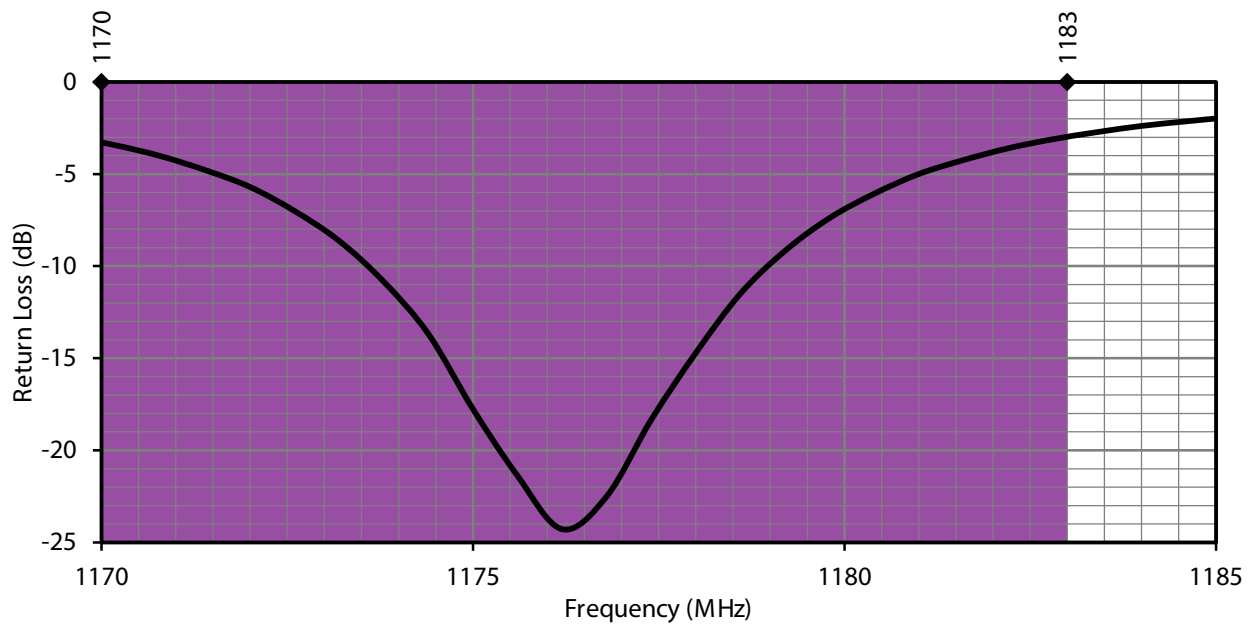

Figure 5. ANT-GNCP-TH258L15 Return Loss, L5 Band

PEAK GAIN

The peak gain across the antenna bandwidth is shown in Figure 6 (L1 band) and Figure 7 (L5 band). Peak gain represents the maximum antenna input power concentration across 3-dimensional space, and therefore peak performance at a given frequency, but does not consider any directionality in the gain pattern.

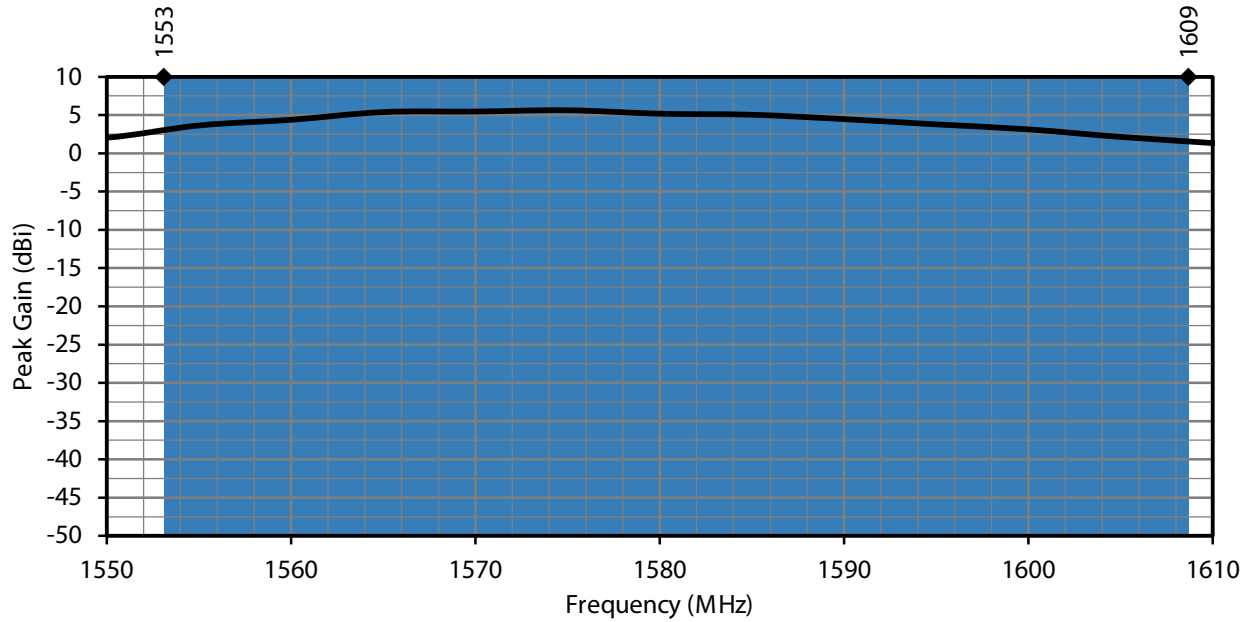

Figure 6. ANT-GNCP-TH258L15 Peak Gain, L1 Band

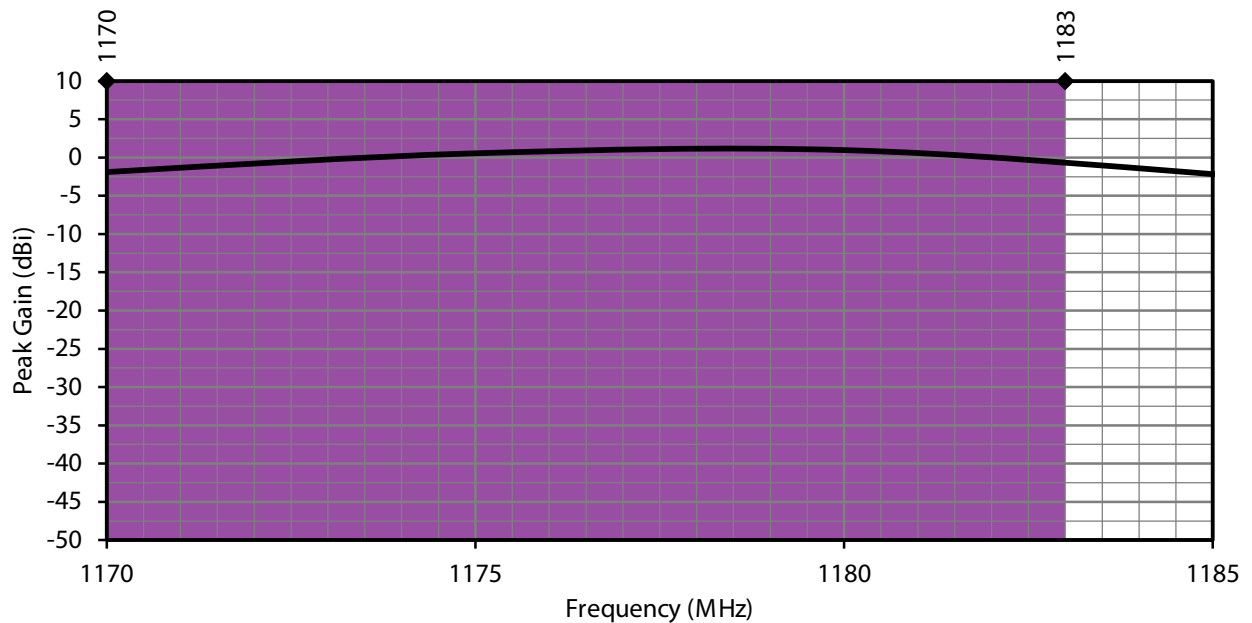

Figure 7. ANT-GNCP-TH258L15 Peak Gain, L5 Band

AVERAGE GAIN - RHCP

Average gain, shown in Figure 8 (L1 band) and Figure 9 (L5 band), is the average of all antenna gain in 3-dimensional space at each frequency, providing an indication of overall performance without expressing antenna directionality.

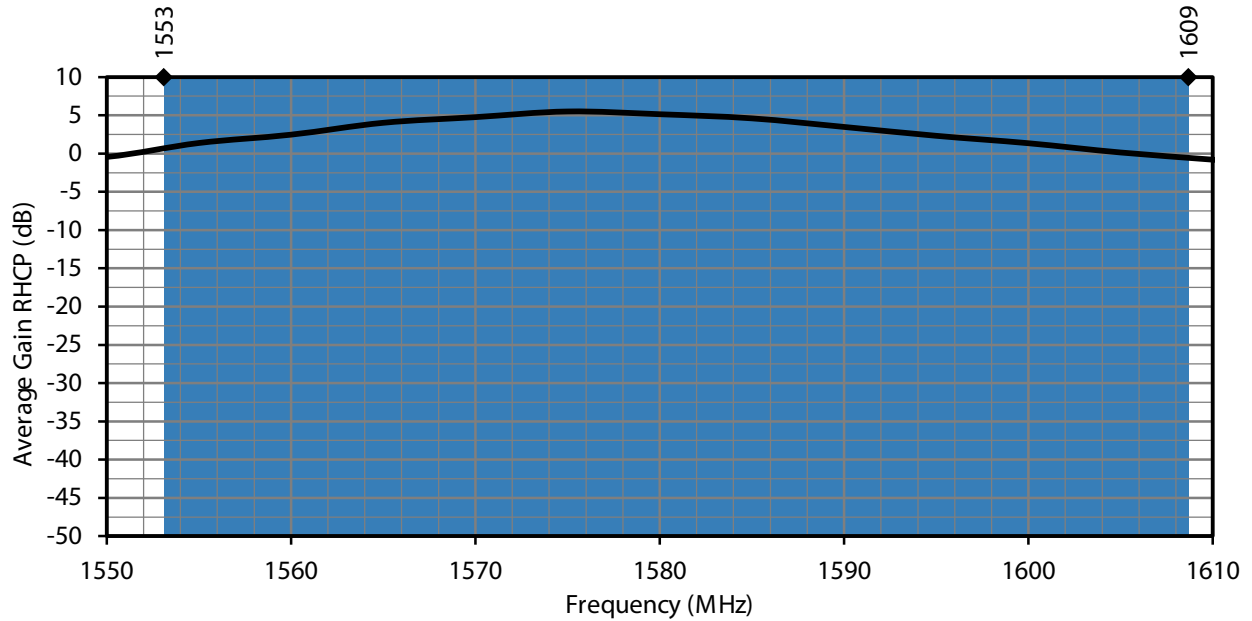

Figure 8. ANT-GNCP-TH258L15 Antenna Average Gain, L1 Band

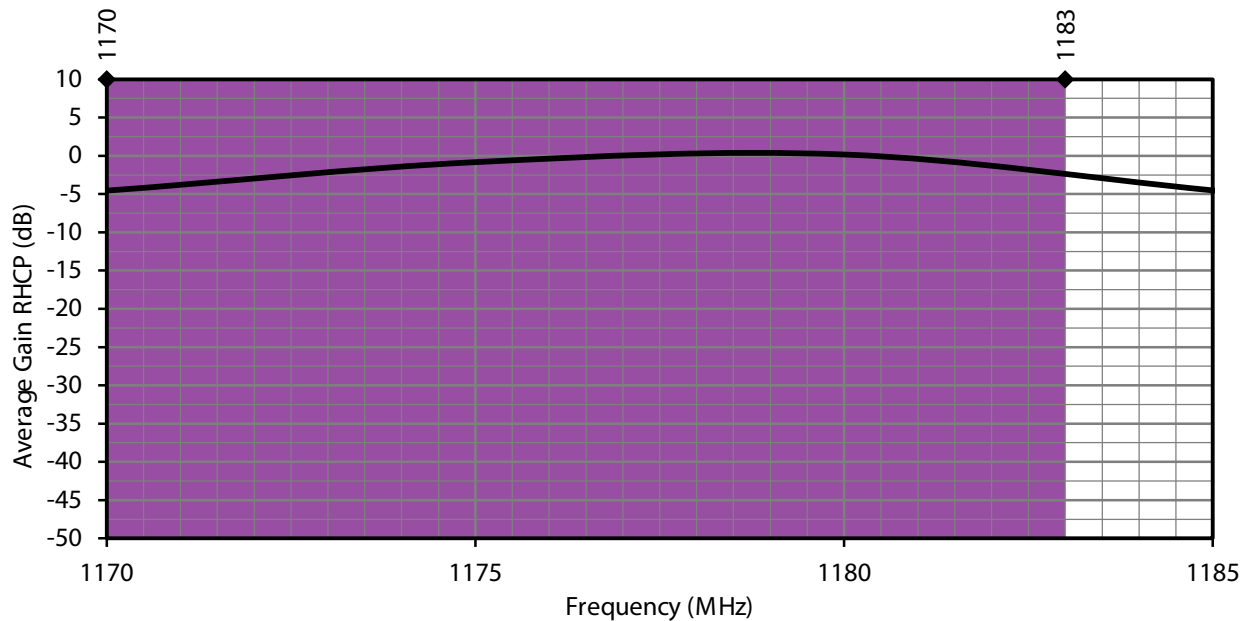

Figure 9. ANT-GNCP-TH258L15 Antenna Average Gain, L5 Band

AXIAL RATIO

Axial ratio provides a measure of the quality of circular polarization of an antenna, the lower the value (in dB), the better the circular polarization. A circularly polarized antenna field comprises two orthogonal E-field components. These fields are ideally of equal amplitude, resulting in an axial ratio equal to unity (0 dB). In practice, no antenna is perfectly circular in polarization, the polarization is elliptical as one field has larger magnitude. As the axial ratio increases the antenna gain degrades away from the main beam orthogonal to the antenna surface. The axial ratio for the ANT-GNCP-TH258L15 antenna is shown in Figure 10 (L1 band) and Figure 11 (L5 band).

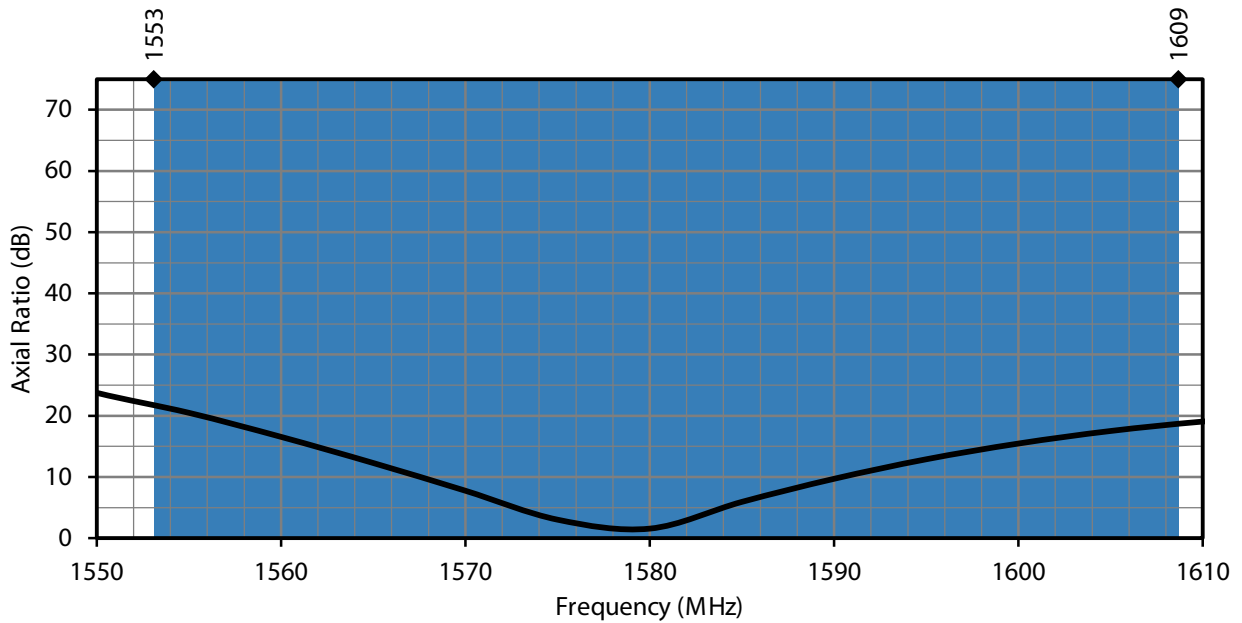

Figure 10. Axial Ratio of the ANT-GNCP-TH258L15, L1 Band

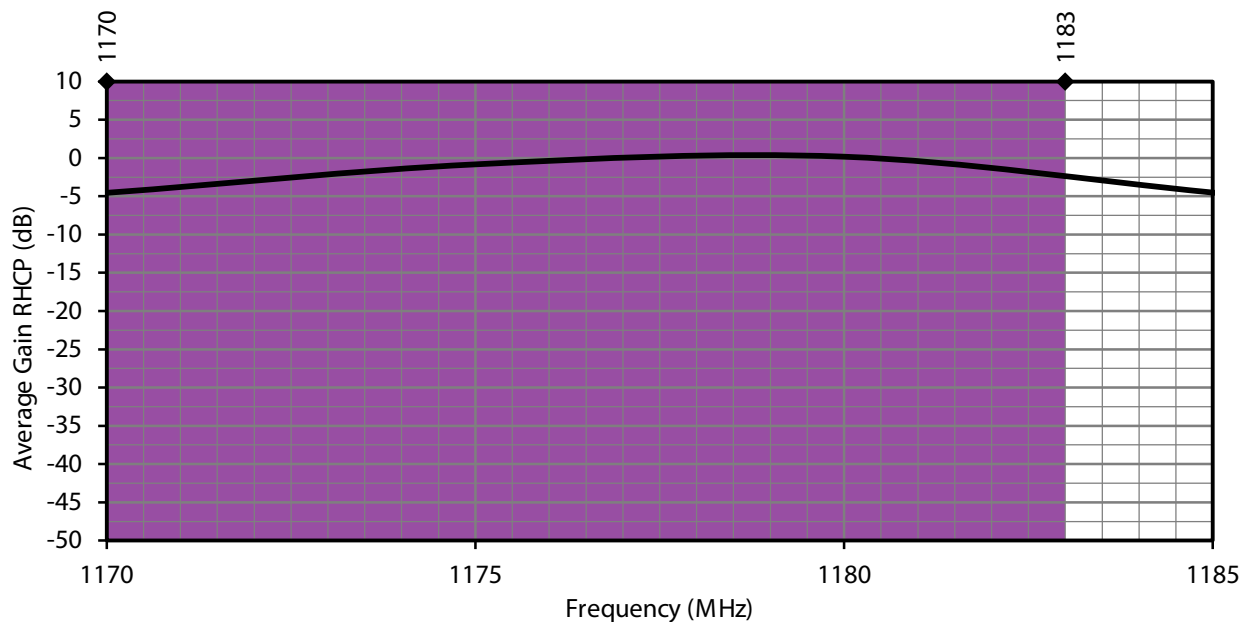

Figure 11. Axial Ratio of the ANT-GNCP-TH258L15, L5 Band

RADIATION EFFICIENCY

Radiation efficiency, Figure 12 (L1 band) and Figure 13 (L5 band), shows the ratio of power delivered to the antenna relative to the power radiated at the antenna, expressed as a percentage, where a higher percentage indicates better performance at a given frequency.

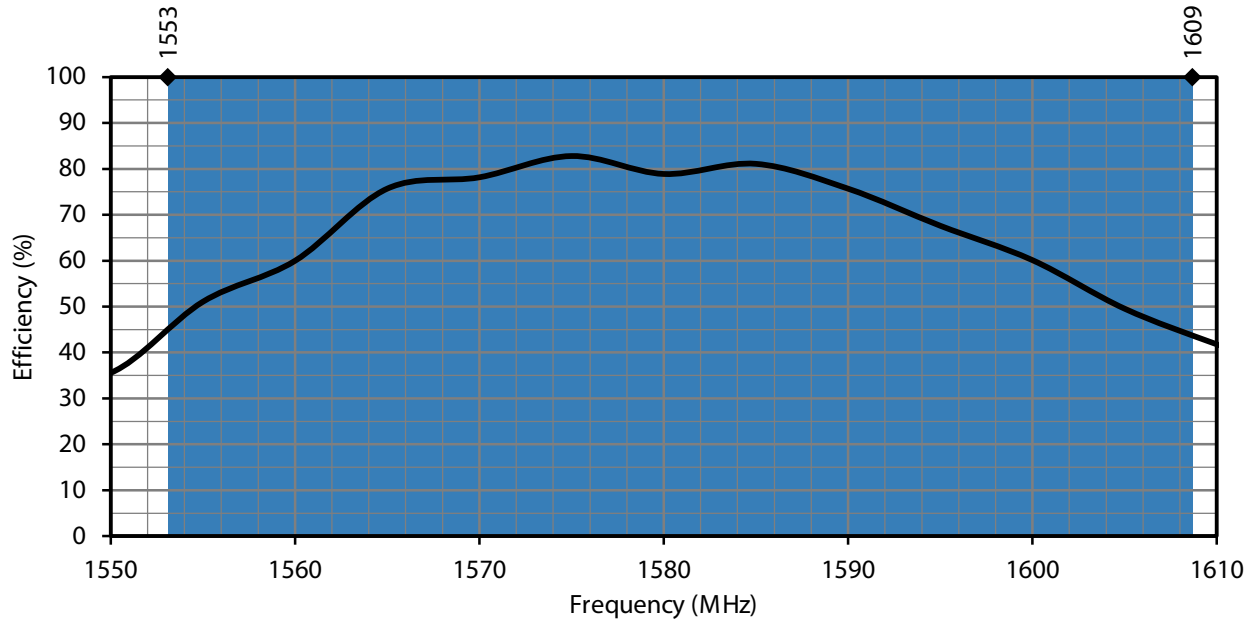

Figure 12. ANT-GNCP-TH258L15 Antenna Radiation Efficiency, L1 Band

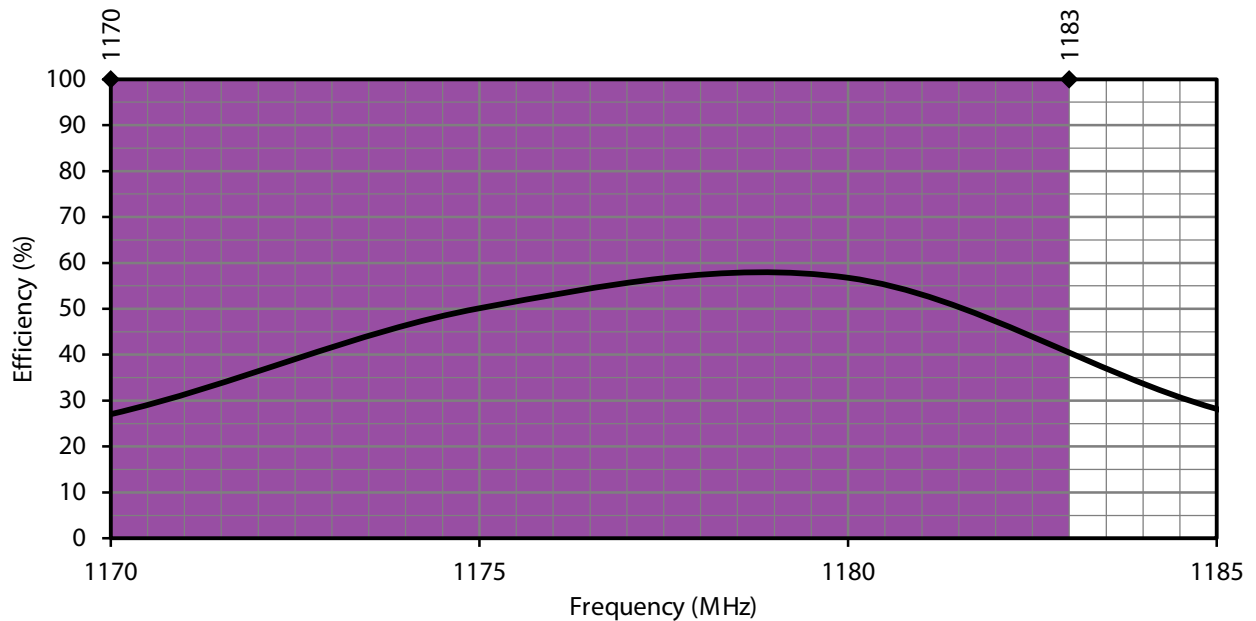
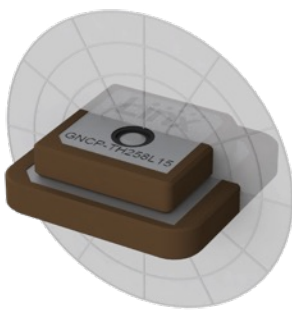

Figure 13. ANT-GNCP-TH258L15 Antenna Radiation Efficiency, L5 Band

RADIATION PATTERNS

Radiation patterns provide information about the directionality and 3-dimensional gain performance of the antenna by plotting gain at specific frequencies in three orthogonal planes. Antenna radiation patterns are shown in Figure 14 using polar plots covering 360 degrees. The antenna graphic at the top of the page provides reference to the plane of the column of plots below it. Note: when viewed with typical PDF viewing software, zooming into radiation patterns is possible to reveal fine detail.



XZ-Plane Gain

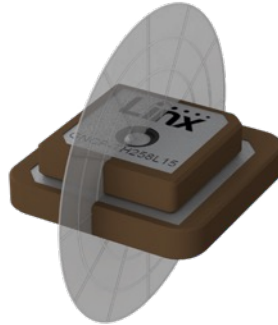

YZ-Plane Gain



XY-Plane Gain

1553 MHZ TO 1609 MHZ (1580 MHZ)

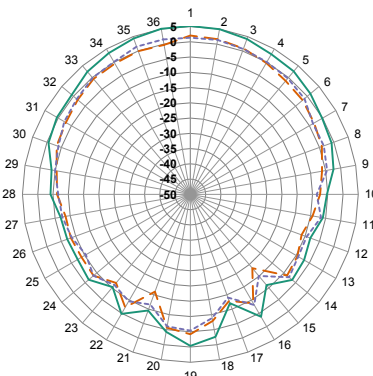

XZ-Plane Gain

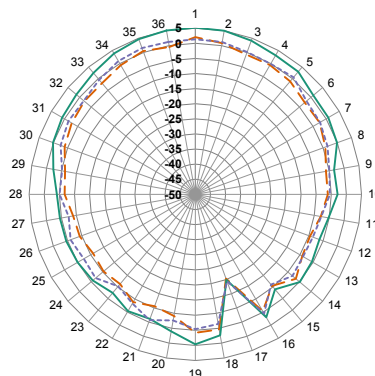

YZ-Plane Gain

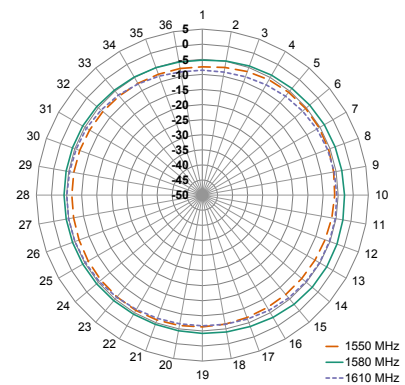

XY-Plane Gain

1170 MHZ TO 1183 MHZ (1180 MHZ)

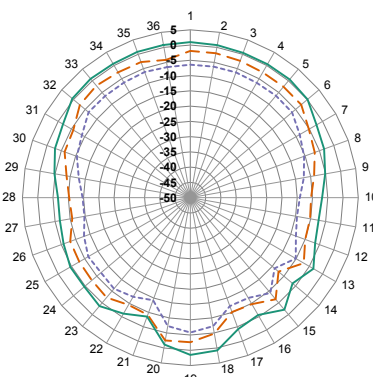

XZ-Plane Gain

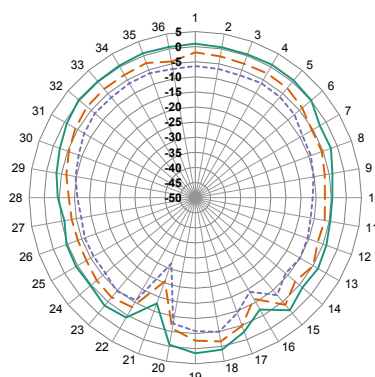

YZ-Plane Gain

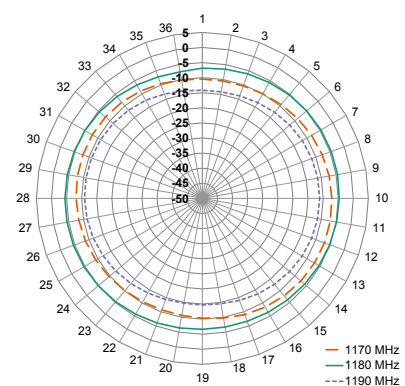

XY-Plane Gain

Figure 14. ANT-GNCP-TH258L15 Radiation Patterns

GROUND PLANE

Ceramic patch antennas are directional in signal transmission and reception orthogonal to the surface plane of the antenna, and require a ground plane for proper operation. The larger the ground plane, the narrower the antenna signal beam, and generally, the better the VSWR performance of the antenna. Relatively smaller ground planes produce wider signal beams. Linx recommends the ground plane size shown in the Electrical Specifications table to achieve performance similar to that shown in this datasheet. Other ground plane sizes and antenna mounting locations are possible. The antenna should be mounted at the center of the ground plane for best performance. Linx offers PCB design reviews to help optimize solution performance.

ANTENNA INSTALLATION

The ANT-GNCP-TH258L15 attaches to the PCB surface using a double-sided adhesive (0.12 mm thick) which consists of a flexible pressure sensitive adhesive that adheres to metal, plastic and other non-porous surfaces. The mounting surface should be clean and free of moisture and oily residues for ideal adhesive strength. The 4 optional PCB solder pads and their dimensions are provided for use where the adhesive used to attach the antenna is not adequate to maintain the bond between the antenna and the PCB such as in installations that are exposed to excessive vibration. To facilitate soldering the adhesive must be removed.

RECOMMENDED LAYOUT

The recommended printed circuit board (PCB) layout for the ANT-GNCP-TH258L15 is demonstrated in Figure 15. Contact Linx for availability of PCB layout design files. The recommended layout includes a matching network, ground plane and PCB transmission line from the antenna to the matching network, and to the connector or radio circuitry. The connector used for the evaluation board is optional, the transmission line may be run directly to the radio if on the same PCB.

Linx recommends inclusion of at least a 3-element, surface mount pi matching network of two parallel capacitors, (C1, C2) and one serial inductor, (L1) in all designs (Figure 16). Surface mount components should be 0603 size. 0402 size components are also supported. The ANT-GNCP-TH258L15 antenna, as designed, does not require matching, but matching may improve end-product antenna performance depending on the effects of the enclosure, PCB and other electronic components. If no matching is necessary, the serial element may be populated with a zero-ohm resistor and no components in the two capacitor positions. Linx believes in wireless made simple® and offers matching network design support.

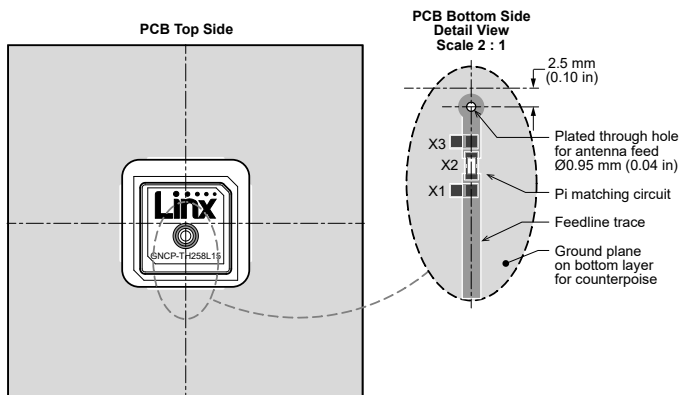

Figure 15. Recommended PCB Layout for the ANT-GNCP-TH258L15

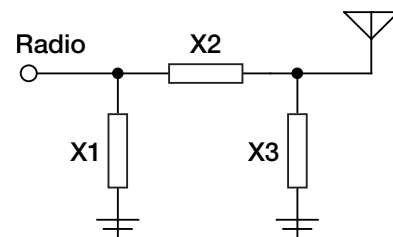

Figure 16. Matching Network Recommendation

RECOMMENDED PCB FOOTPRINT

Figure 17 shows the recommended printed circuit board footprint and spacing for the ANT-GNCP-TH258L15 antenna. The footprint recommendation should be used in conjunction with the recommended layout configuration shown in Figure 15.

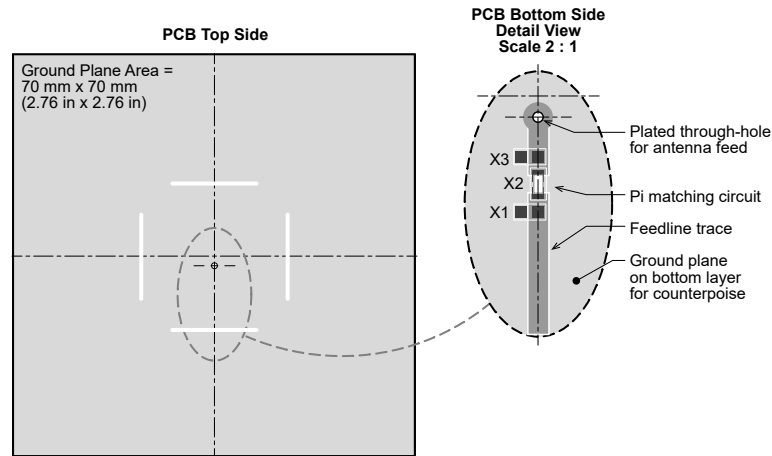

Figure 17. ANT-GNCP-TH258L15 Antenna Placement on PCB

TRANSMISSION LINES FOR EMBEDDED ANTENNAS

For most designs, Linx recommends a microstrip transmission line for the ANT-GNCP-TH258L15 antenna. A microstrip transmission line is a PCB trace that runs over a ground plane to maintain the characteristic impedance for optimal signal transfer between the antenna and radio circuitry. Linx designs all antennas with a characteristic impedance of 50 Ω .

Important practices to observe when designing a transmission line are:

- Keep all transmission lines to a minimum length for best signal performance
- Use RF components that also operate at a 50 Ω impedance
- If the radio is not on the same PCB as the antenna, the microstrip should be terminated in a connector, enabling a shielded cable to complete the antenna connection to the radio
- For designs subject to significant electromagnetic interference, a coplanar waveguide transmission line may be used on the PCB

The design of a PCB transmission line can be aided by many commercially available software packages which can calculate the correct transmission line width and gap dimensions based upon the PCB thickness and dielectric constant used. Linx offers PCB design reviews to help optimize solution performance.

PACKAGING SPECIFICATIONS

The ANT-GNCP-TH258L15 antenna is packaged in protective plastic trays. Antennas are packaged 25 per tray, 175 antennas (7 trays) are packed in a carton 10.3 in x 6.0 in x 4.7 in (261 mm x 152 mm x 118 mm). 700 antennas packaged in a labeled shipping box 13.0 in x 11.0 in x 10.0 in (330 mm x 280 mm x 254 mm).

ANTENNA DEFINITIONS AND USEFUL FORMULAS

VSWR - Voltage Standing Wave Ratio. VSWR is a unitless ratio that describes the power reflected from the antenna back to the radio. A lower VSWR value indicates better antenna performance at a given frequency. VSWR is easily derived from Return Loss.

$$\text{VSWR} = \frac{10^{\left[\frac{\text{Return Loss}}{20}\right]} + 1}{10^{\left[\frac{\text{Return Loss}}{20}\right]} - 1}$$

Return Loss - Return loss represents the loss in power at the antenna due to reflected signals, measured in decibels. A lower return loss value indicates better antenna performance at a given frequency. Return Loss is easily derived from VSWR.

$$\text{Return Loss} = -20 \log_{10} \left[\frac{\text{VSWR} - 1}{\text{VSWR} + 1} \right]$$

Efficiency (η) - The total power radiated from an antenna divided by the input power at the feed point of the antenna as a percentage.

Total Radiated Efficiency -(TRE) The total efficiency of an antenna solution comprising the radiation efficiency of the antenna and the transmitted (forward) efficiency from the transmitter.

$$\text{TRE} = \eta \cdot \left(1 - \left(\frac{\text{VSWR} - 1}{\text{VSWR} + 1} \right)^2 \right)$$

Gain - The ratio of an antenna's efficiency in a given direction (G) to the power produced by a theoretical lossless (100% efficient) isotropic antenna. The gain of an antenna is almost always expressed in decibels.

$$G_{\text{db}} = 10 \log_{10}(G)$$

$$G_{\text{dBd}} = G_{\text{dBi}} - 2.51\text{dB}$$

Peak Gain - The highest antenna gain across all directions for a given frequency range. A directional antenna will have a very high peak gain compared to average gain.

Average Gain - The average gain across all directions for a given frequency range.

Maximum Power - The maximum signal power which may be applied to an antenna feed point, typically measured in watts (W).

Reflected Power - A portion of the forward power reflected back toward the amplifier due to a mismatch at the antenna port.

$$\left(\frac{\text{VSWR} - 1}{\text{VSWR} + 1} \right)^2$$

decibel (dB) - A logarithmic unit of measure of the power of an electrical signal.

decibel isotropic (dBi) - A comparative measure in decibels between an antenna under test and an isotropic radiator.

decibel relative to a dipole (dBd) - A comparative measure in decibels between an antenna under test and an ideal half-wave dipole.

Dipole - An ideal dipole comprises a straight electrical conductor measuring 1/2 wavelength from end to end connected at the center to a feed point for the radio.

Isotropic Radiator - A theoretical antenna which radiates energy equally in all directions as a perfect sphere.

Omnidirectional - Term describing an antenna radiation pattern that is uniform in all directions. An isotropic antenna is the theoretical perfect omnidirectional antenna. An ideal dipole antenna has a donut-shaped radiation pattern and other practical antenna implementations will have less perfect but generally omnidirectional radiation patterns which are typically plotted on three axes.

TE TECHNICAL SUPPORT CENTER

USA:	+1 (800) 522-6752
Canada:	+1 (905) 475-6222
Mexico:	+52 (0) 55-1106-0800
Latin/S. America:	+54 (0) 11-4733-2200
Germany:	+49 (0) 6251-133-1999
UK:	+44 (0) 800-267666
France:	+33 (0) 1-3420-8686
Netherlands:	+31 (0) 73-6246-999
China:	+86 (0) 400-820-6015

te.com

TE Connectivity, TE, TE connectivity (logo), Linx and Linx Technologies are trademarks owned or licensed by the TE Connectivity Ltd. family of companies. All other logos, products and/or company names referred to herein might be trademarks of their respective owners.

The information given herein, including drawings, illustrations and schematics which are intended for illustration purposes only, is believed to be reliable. However, TE Connectivity makes no warranties as to its accuracy or completeness and disclaims any liability in connection with its use. TE Connectivity's obligations shall only be as set forth in TE Connectivity's Standard Terms and Conditions of Sale for this product and in no case will TE Connectivity be liable for any incidental, indirect or consequential damages arising out of the sale, resale, use or misuse of the product. Users of TE Connectivity products should make their own evaluation to determine the suitability of each such product for the specific application.

TE Connectivity warrants to the original end user customer of its products that its products are free from defects in material and workmanship. Subject to conditions and limitations TE Connectivity will, at its option, either repair or replace any part of its products that prove defective because of improper workmanship or materials. This limited warranty is in force for the useful lifetime of the original end product into which the TE Connectivity product is installed. Useful lifetime of the original end product may vary but is not warranted to exceed one (1) year from the original date of the end product purchase.

©2022 TE Connectivity. All Rights Reserved.

09/22 Original