



Science.
Applied to Life.™

3M Fire Protection Products

Applicator & Specifier Guide



Trust and Confidence.
Even Under Fire.

Protecting Lives for More Than 30 Years

In 1974, the movie *Towering Inferno*[†] sparked the imagination of Richard Licht, a 3M product developer who passionately believed 3M technologies could be used to improve the safety of multi-story buildings. Several devastating fires — including the 1980 MGM Grand Hotel fire that killed 84 people and injured 679 — inspired Licht to develop the first firestop products based on existing 3M intumescent technology.

Recognized by many at 3M as “one of the fathers of firestopping,” Licht also helped develop some of the first firestop requirements in commercial building codes. He worked tirelessly to make the codes more progressive to improve the safety of all buildings.

[†] Produced by Irwin Allen

Comprehensive fire protection includes fire detection, fire containment and fire suppression. 3M Fire Protection Products address fire containment and are an integral part of a well-designed fire protection system. Our understanding of the spread of fire, smoke and toxic gases helps us continue to create preventative and affordable firestopping solutions.



Table of Contents

| | |
|--|-----------------|
| 3M Firestopping Partnership, Training and Testing | iii – iv |
|--|-----------------|

| | |
|--|----------|
| 3M Firestopping Progress and Trends | v |
|--|----------|

| | |
|------------------------------------|------------------|
| Technical Information | vi – liii |
|------------------------------------|------------------|

| | |
|----------------------------------|-----------------|
| Resources and Tools | vii – ix |
|----------------------------------|-----------------|

| | |
|---------------------------------|------------|
| www.3M.com/firestop tools | vii – viii |
|---------------------------------|------------|

| | |
|--|----|
| Typical Applications – Commercial Construction | ix |
|--|----|

| | |
|----------------------------------|-------------------|
| Product Information | x – xxviii |
|----------------------------------|-------------------|

| | |
|---------------------------|----------|
| Product Information | x – xxii |
|---------------------------|----------|

| | |
|----------------------------|----------------|
| Ordering Information | xxiii – xxviii |
|----------------------------|----------------|

| | |
|----------------------------------|--------------------|
| Technical Documents | xxix – xxxv |
|----------------------------------|--------------------|

| | |
|---|------------|
| General Certificates of Conformance | xxix – xxx |
|---|------------|

| | |
|----------------------------------|-----|
| LEED® Credit Contributions | xxx |
|----------------------------------|-----|

| | |
|--|--------------|
| Shelf Life Definitions, Lot Number Interpretations | xxxii – xxxv |
|--|--------------|

| | |
|---|---------------------|
| How to Use the UL Numbering System | xxxvi – liii |
|---|---------------------|

| | |
|---|----------------|
| Through Penetrations Systems & Designs | 1 – 983 |
|---|----------------|

| | |
|-----------------|----------------|
| UL | 2 – 905 |
|-----------------|----------------|

| | |
|---------------------|---------------|
| Blanks | 3 – 42 |
|---------------------|---------------|

| | |
|------------------------|--------|
| Concrete Systems | 4 – 31 |
|------------------------|--------|

| | |
|----------------------|---------|
| Gypsum Systems | 32 – 42 |
|----------------------|---------|

| | |
|-----------------------------|-----------------|
| Metallic Pipes | 43 – 211 |
|-----------------------------|-----------------|

| | |
|------------------------|----------|
| Concrete Systems | 44 – 131 |
|------------------------|----------|

| | |
|----------------------|-----------|
| Gypsum Systems | 131 – 186 |
|----------------------|-----------|

| | |
|-----------------------------|-----------|
| Floor/Ceiling Systems | 187 – 211 |
|-----------------------------|-----------|

| | |
|---------------------------------|------------------|
| Non-Metallic Pipes | 212 – 451 |
|---------------------------------|------------------|

| | |
|------------------------|-----------|
| Concrete Systems | 213 – 342 |
|------------------------|-----------|

| | |
|----------------------|-----------|
| Gypsum Systems | 343 – 404 |
|----------------------|-----------|

| | |
|-----------------------------|-----------|
| Floor/Ceiling Systems | 405 – 451 |
|-----------------------------|-----------|

| | |
|---------------------|------------------|
| Cables | 452 – 562 |
|---------------------|------------------|

| | |
|------------------------|-----------|
| Concrete Systems | 453 – 506 |
|------------------------|-----------|

| | |
|----------------------|-----------|
| Gypsum Systems | 507 – 548 |
|----------------------|-----------|

| | |
|-----------------------------|-----------|
| Floor/Ceiling Systems | 549 – 562 |
|-----------------------------|-----------|

| | |
|--------------------------|------------------|
| Cable Trays | 563 – 611 |
|--------------------------|------------------|

| | |
|------------------------|-----------|
| Concrete Systems | 564 – 588 |
|------------------------|-----------|

| | |
|----------------------|-----------|
| Gypsum Systems | 589 – 611 |
|----------------------|-----------|

| | |
|------------------------------|------------------|
| Insulated Pipes | 612 – 697 |
|------------------------------|------------------|

| | |
|------------------------|-----------|
| Concrete Systems | 613 – 662 |
|------------------------|-----------|

| | |
|----------------------|-----------|
| Gypsum Systems | 663 – 691 |
|----------------------|-----------|

| | |
|-----------------------------|-----------|
| Floor/Ceiling Systems | 692 – 697 |
|-----------------------------|-----------|

| | |
|---------------------------------------|------------------|
| Miscellaneous Electrical | 698 – 707 |
|---------------------------------------|------------------|

| | |
|------------------------|-----------|
| Concrete Systems | 699 – 704 |
|------------------------|-----------|

| | |
|----------------------|-----------|
| Gypsum Systems | 705 – 707 |
|----------------------|-----------|

| | |
|---------------------------------------|------------------|
| Miscellaneous Mechanical | 708 – 785 |
|---------------------------------------|------------------|

| | |
|------------------------|-----------|
| Concrete Systems | 709 – 738 |
|------------------------|-----------|

| | |
|----------------------|-----------|
| Gypsum Systems | 739 – 778 |
|----------------------|-----------|

| | |
|-----------------------------|-----------|
| Floor/Ceiling Systems | 779 – 785 |
|-----------------------------|-----------|

| | |
|---------------------|------------------|
| Combos | 786 – 905 |
|---------------------|------------------|

| | |
|------------------------|-----------|
| Concrete Systems | 787 – 855 |
|------------------------|-----------|

| | |
|----------------------|-----------|
| Gypsum Systems | 856 – 888 |
|----------------------|-----------|

| | |
|-----------------------------|-----------|
| Floor/Ceiling Systems | 889 – 905 |
|-----------------------------|-----------|

| | |
|-----------------------|------------------|
| Intertek | 906 – 983 |
|-----------------------|------------------|

| | |
|---|------------------|
| Horizontal Assemblies (Floors) | 907 – 935 |
|---|------------------|

| | |
|--|------------------|
| Vertical Assemblies (Walls) | 936 – 958 |
|--|------------------|

| | |
|---|------------------|
| Horizontal or Vertical Assemblies (Floor or Walls) | 959 – 983 |
|---|------------------|

| | |
|--|-------------------|
| Through Penetrations Systems & Designs, Canada-Specific | 984 – 1010 |
|--|-------------------|

| | |
|------------------|-------------------|
| ULC | 985 – 1010 |
|------------------|-------------------|

| | |
|---------------------------------|-------------------|
| Non-Metallic Pipes | 986 – 1005 |
|---------------------------------|-------------------|

| | |
|------------------------|------------|
| Concrete Systems | 987 – 1001 |
|------------------------|------------|

| | |
|-----------------------------|-------------|
| Floor/Ceiling Systems | 1002 – 1005 |
|-----------------------------|-------------|

| | |
|---------------------|--------------------|
| Combos | 1006 – 1010 |
|---------------------|--------------------|

| | |
|------------------------|-------------|
| Concrete Systems | 1007 – 1010 |
|------------------------|-------------|

| | |
|------------------------------------|--------------------|
| Electrical Outlet Box | 1011 – 1015 |
|------------------------------------|--------------------|

CLIV

| | |
|----------------------------------|--------------------|
| Construction Joints | 1016 – 1342 |
|----------------------------------|--------------------|

| | |
|-----------------|--------------------|
| UL | 1017 – 1253 |
|-----------------|--------------------|

| | |
|----------------------|-------------|
| Bottom-of-Wall | 1020 – 1023 |
|----------------------|-------------|

| | |
|----------------------|-------------|
| Floor-to-Floor | 1024 – 1041 |
|----------------------|-------------|

| | |
|---------------------|-------------|
| Floor-to-Wall | 1042 – 1054 |
|---------------------|-------------|

| | |
|--------------------|-------------|
| Head-of-Wall | 1055 – 1197 |
|--------------------|-------------|

| | |
|--------------------|-------------|
| Wall-to-Wall | 1198 – 1233 |
|--------------------|-------------|

| | |
|-------------------------------|-------------|
| Continuity Head-of-Wall | 1234 – 1241 |
|-------------------------------|-------------|

| | |
|-----------------------|-------------|
| Perimeter Joint | 1242 – 1253 |
|-----------------------|-------------|

| | |
|-----------------------|--------------------|
| Intertek | 1254 – 1342 |
|-----------------------|--------------------|

| | |
|-----------------------|-------------|
| Perimeter Joint | 1255 – 1334 |
|-----------------------|-------------|

| | |
|--------------------|-------------|
| Head-of-Wall | 1335 – 1342 |
|--------------------|-------------|

| | |
|---|--------------------|
| Flexible Wraps | 1343 – 1512 |
| Duct Wraps | 1344 – 1410 |
| Grease Duct Protection | 1345 – 1372 |
| Ventilation Duct Protection | 1373 – 1401 |
| Chemical Fume Exhaust Duct Protection | 1402 – 1410 |
| Penetration Systems – Duct Wrap | 1411 – 1446 |
| Penetration System – Duct Through Floor | 1412 – 1420 |
| Penetration System – Duct Through Wall | 1421 – 1446 |
| Plenum Wraps | 1447 – 1452 |
| Plenum Protection System | 1448 – 1452 |
| Mats | 1453 – 1512 |
| Structural Steel Protection | 1454 – 1474 |
| Cellulosic (Standard Intensity Fire) | 1455 – 1459 |
| Hydrocarbon (High Intensity Fire) | 1460 – 1466 |
| Torch Fire | 1467 |
| Jet Fire | 1468 – 1474 |
| Electrical Circuit Protection | 1475 – 1509 |
| Cellulosic (Standard Intensity Fire) | 1477 – 1502 |
| Ampacity Derating | 1503 – 1504 |
| Hydrocarbon (High Intensity Fire) | 1505 – 1509 |
| Fuel Oil Pipe Protection | 1510 – 1512 |

3M Firestopping Partnership,

Partners in Protection

Being a leader in the fire protection industry goes beyond selling innovative products. 3M partners with you from the start — providing a comprehensive library of tested and listed systems, excellent technical services, and the superior training you need to enhance your firestopping capabilities.

We meet with you to discuss your application needs and to help you select the best firestopping solutions. To help ensure your inspection process goes smoothly, we work directly with building inspectors to answer their questions and help you respond to any concerns the inspector might have. By continuing to work closely with you throughout a building's life — including retrofit and maintenance activities — we support you as you work to ensure your building's firestopping is being properly managed.

Risk Management and Facility Maintenance

3M's Firestop Risk Management and Facility Maintenance Programs provide a comprehensive approach to helping you manage the complexities of the firestopping process. From helping you define your initial needs to helping manage your firestopping throughout a building's life, we walk you through the decisions and steps required to keep your project on time, in budget and code-compliant. Our Healthcare Facility Maintenance Program includes additional tools for Joint Commission and other critical life safety inspections.

For more information regarding the 3M Firestop Risk Management and Facility Maintenance Programs, contact your local 3M Fire Protection Sales Representative, or call 1-800-328-1687.

Choosing a System

The easy-to-use, online 3M Firestop Systems Selector helps you choose the firestop solution best suited to your application. To learn more, and to see the latest in firestopping solutions, visit [3M.com/firestop](https://www.3m.com/firestop)



Training and Testing



Training With The Best

When it comes to training, 3M delivers. We provide comprehensive online firestop training so you can train when it's most convenient for you, 24/7.

3M firestop training provides a wealth of information — from firestopping basics and system nomenclature to detailed installation techniques. The program's high-quality videos highlight proper installation techniques in a broad range of systems for through penetrations, construction joints and flexible wrap systems.

Over the last 10 years, 3M has provided detailed, hands-on firestop training for more than 5,000 code officials, architects, contractors and firestop professionals at our online fire-test center. Plus, 3M offers jobsite and on-location training by our qualified sales representatives.

For more information, visit 3M.com/firestop

Architects, Earn AIA/CES LUs

Since 1999, all active members of the American Institute of Architects must successfully complete 18 Learning Units (LUs) including the CES requirement of 12 hours of Health, Safety, Welfare issues (HSW) and 4 hours of Sustainable Design (SD) for annual membership renewal.

3M™ Fire Protection Products, long recognized as an industry leader, is now a Registered Provider of AIA/CES credits, including HSW.

In our continuing effort to provide a complete and comprehensive firestopping program available, 3M™ Fire Protection Products offers substantial and informative courses designed with you in mind.

New applications, products and the ever broadening array of system designs are covered by the most knowledgeable and helpful experts in the industry. These topics allow you to keep updated on the latest firestopping technology and systems while earning required LUs.

3M Test Center

For more than 30 years, our fire-test center has ensured quality results and has been qualified under UL and Intertek guidelines for UL's Client Test Data Program and Intertek's Satellite Laboratory Program. Extensive product testing, online and hands-on training are just a few more ways 3M partners with you to help keep people safe.

3M Firestopping Progress and Trends

As an industry leader, 3M drives technologies that enable lower cost building solutions. For instance, 3M intumescent technology enabled the use of plastic pipes that were previously banned in commercial buildings due to their combustable nature — providing a lower cost, easy-to-install solution for electrical conduits and plumbing lines.

3M is proud to be an industry leader in firestopping. Our dedication to stringent testing and code developments help make buildings safer today than they were even 10 years ago. And when that dedication is backed by a brand as powerful as 3M, you get what you would expect — proven reliability and outstanding service.

The construction industry is increasingly moving toward easy-to-use firestop solutions. That's why 3M, in its leadership role, provides cutting-edge and fully integrated systems. These systems are designed to help you efficiently construct safer buildings that help protect lives and property.

The majority of 3M's firestopping innovations are tested online in the company's own UL and Intertek certified fire-test center. By testing these systems in job-specific conditions, 3M can more effectively provide fire protection solutions that meet current industry needs.



From time-tested fire barrier sealants to today's innovative firestop devices and duct wraps, 3M scientists work to develop solutions to firestop virtually anything on a building site. With over 100 products and 1,000 tested approved systems, 3M has the most complete program for all your firestopping needs.



Building designs and uses continue to evolve, and so too must 3M firestop technology. For example, in buildings where telecommunication cables are constantly being upgraded, the 3M™ Fire Barrier Pass-Through Device allows for re-enterability and helps keep cables organized and protected.

Technical Information

Value Beyond the Products

The 3M Fire Protection Product website is designed to enhance our technical and sales support by providing users easy access to critical information needed in the construction and maintenance of buildings requiring passive fire protection. In addition to a wealth of product and technical information, here are some value-add tools that can be accessed from the 3M Fire Protection website:

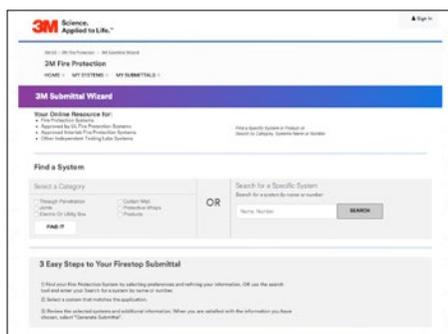

3M System Selector

Helps you quickly navigate through our extensive library of tested and listed systems to provide a short list of suitable systems for a specific application.

3M Submittal Wizard

Allows users to access, select and combine documents from multiple applications on the 3M Fire Protection website. Selected documents can be combined into a single document for user's submittal.

Training

3M offers fire protection training at your site, online or at our UL certified test center. Our website provides information on upcoming courses as well as registration for online training. 3M Fire Protection's online learning management system is designed to provide users with general firestopping information and trade-specific installation details.

3M Firestop Management System

This web-based application is designed to help existing facilities monitor their fire barrier management system. With specific functionality to help healthcare facilities pass Joint Commission and other key life safety inspections, key features include contractor management (e.g. issue permits, monitor access), firestop system management down to every floor or wall, document retention including life safety plans and installation photos, and report generation (e.g. system inventory or contractor status).





3M.com/firestop

Please visit our website often. It contains the most current product information and is your first stop to find a system solution and to stay informed about what's new with our products. All of the resources provided in this guide are constantly updated and made available for you to download at any time.

3M.com/firestop

- For distributors near you, click **“WHERE TO BUY”**
- For your local sales representative, click **“SALES REP LOCATOR”**
- Can't find what you are looking for?
Click **“CONTACT US”** or call us at **1-800-328-1687**

Contact your local distributor or 3M Fire Protection Sales Representative for more information.

3M™ Fire Protection Products Typical Applications — Commercial Construction

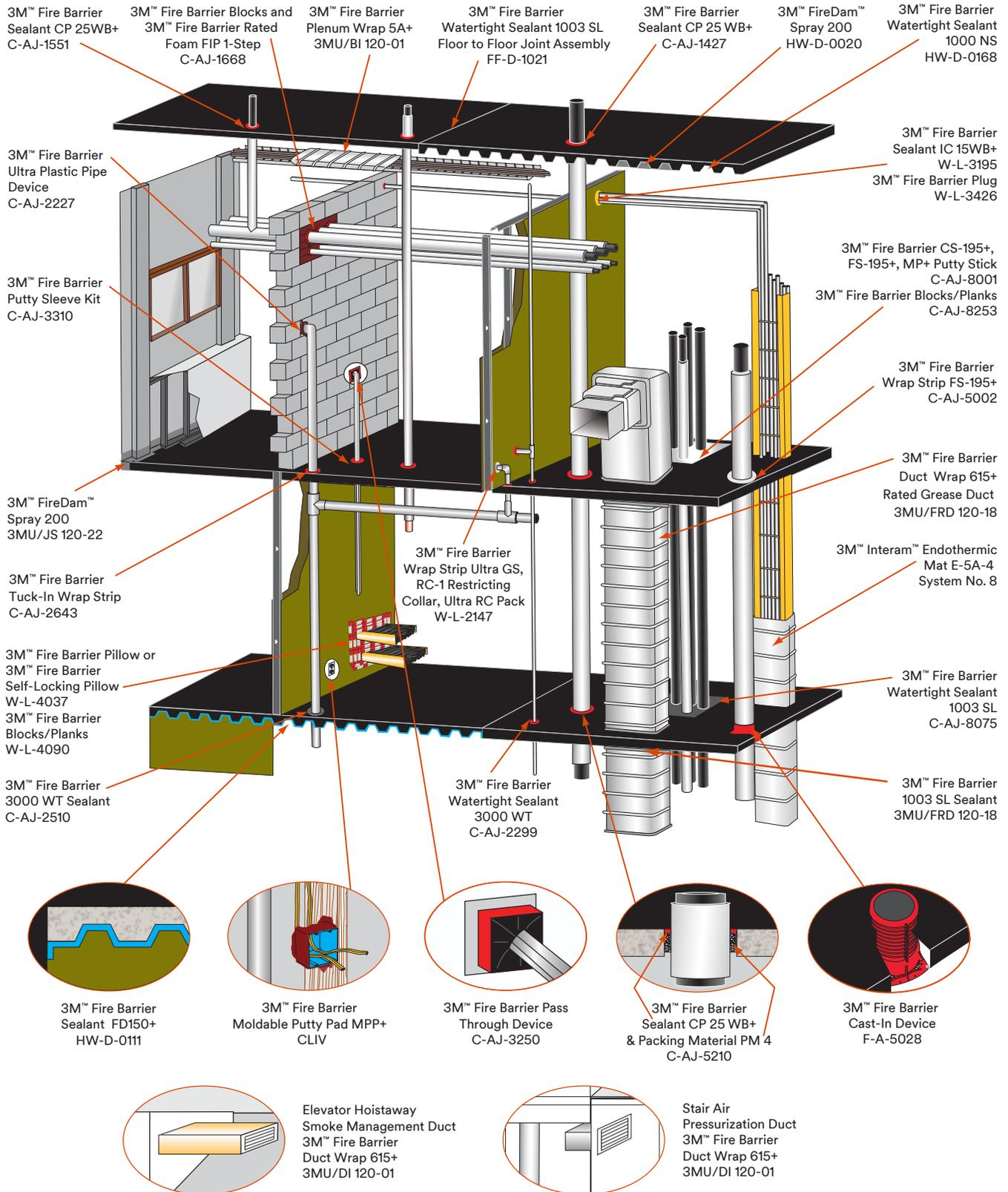

The listed systems are typical applications only. Please refer to the volume of your 3M specification guide for your specific application or use the 3M System Selector available at 3M.com/firestop

Fire Barrier Rated Foam

3M™ Fire Barrier Rated Foam FIP 1-Step

Designed to expand up to 5 times in volume after dispensing, 3M™ Fire Barrier Rated Foam FIP 1-Step is a two-part urethane, smoke, sound and firestopping foam. This intumescent foam can be used to fill the annular space created by pipes and cables penetrating through fire-rated construction. It's an alternative to mineral wool, bricks, pillows and runny, ineffective foams and is UL listed.

- Firestop tested and rated up to 2 hours in accordance with ASTM E 814 (UL 1479) and CAN/ULC S115
- Sag resistant, quick curing formulation that expands up to 5 times in volume during installation
- Intumescent foam expands when exposed to fire
- Re-enterable and repairable foam remains pliable after installation
- Excellent adhesion and does not require backing material in wall or floor applications
- Paintable with primer



FIRE BARRIER



SMOKE SEAL



SOUND BARRIER



Water Based Firestop Sealants

3M™ Fire Barrier Sealant CP 25WB+

3M™ Fire Barrier Sealant CP 25WB+ is a high-performance, intumescent latex-based sealant offering outstanding fire performance plus a non-halogen formula. Approved for the majority of caulk through penetration systems.

- Firestop tested up to 4 hours in accordance with ASTM E 814 (UL 1479)
- Acoustic barrier: STC-Rating of 54 when tested in a STC 54-rated wall assembly
- Provides L-Rating (smoke seal)
- Water based: easy cleanup and routine disposal with no special handling
- Intumescent: expands when heated to seal around items consumed by fire
- Re-enterable/repairable
- Halogen-free and no-sag formulation
- Over 600 tested and listed systems
- One-part system: no mixing or measuring required
- Fast-drying: tack-free in approximately 10–15 minutes
- Paintable (best results obtained after 72 hour cure)
- Red color widely recognized as a firestop for inspections
- High caulk rate: 1000g/min. with 1/4 in. nozzle opening
- Documented aging properties

Not for use with CPVC pipe.



FIRE BARRIER



SMOKE SEAL



SOUND BARRIER



Water Based Firestop Sealants (cont.)

3M™ Fire Barrier Sealant IC 15WB+

3M™ Fire Barrier Sealant IC 15WB+ is a latex sealant designed for use as a one-part fire, smoke, toxic gas sealant. Approved for up to 3 hour rated systems. CPVC compatible.

- Firestop tested up to 3 hours in accordance with ASTM E 814 (UL 1479)
- Acoustic barrier: STC-Rating of 54 when tested in a STC 54-rated wall assembly
- Provides L-Rating (smoke seal)
- Water based: easy cleanup and routine disposal with no special handling
- Intumescent: expands when heated to seal around items consumed by fire
- Halogen-free and no-sag formulation
- Fast drying: tack-free in approximately 8–12 minutes @ 73°F (23°C)
- Paintable (best results obtained after 72 hour cure)
- High caulk rate: 2000g/min. with 1/4 in. nozzle
- Easy-to-identify yellow color

FBC
SYSTEM COMPATIBLE



FIRE BARRIER



SMOKE SEAL



SOUND BARRIER



3M™ Fire Barrier Sealant FD 150+

3M™ Fire Barrier Sealant FD 150+ is the economical alternative to costly firestopping applications. Used to firestop metal pipes or cables through concrete or gypsum, and in dynamic head-of-wall systems.

- Firestop tested up to 3 hours in accordance with ASTM E 814 (UL 1479)
- Fire Resistive Joint System tested up to 4 hours in accordance with ASTM E 1966 (UL 2079)
- Water based acrylic latex: easy cleanup and routine disposal
- Safe, solvent-free: fully cured, continuous seal with ±19% dynamic joint movement capability
- Single-part formulation
- Remains pliable allowing for normal pipe movement
- Fast-drying: tack-free in approximately 30–60 minutes
- Paintable (best results obtained after 72 hour cure)
- Excellent adhesion: multi-viscosity grade offers excellent caulking properties
- Available in limestone gray, blue and red



FIRE BARRIER SMOKE SEAL SOUND BARRIER ELASTOMERIC



Not for use with CPVC pipe.

Water Tight Silicone Firestop Sealants

3M™ Fire Barrier Water Tight Sealant 3000 WT

3M™ Fire Barrier Water Tight Sealant 3000 WT Intumescent Sealant forms an effective barrier to fire and water in through penetrations. This high-performance sealant helps prevent water and moisture intrusion while protecting buildings and their occupants by preventing the spread of fire, smoke and toxic gas.

- Intumescent silicone for use in systems with a firestop rating up to 4 hours when tested in accordance with ASTM E 814 (UL1479)
- Meets UL Water Leakage Test, W Rating: Class 1 requirements for systems tested in accordance with ANSI/UL 1479
- Helps prevent moisture and water migration through a building
- Minimizes noise transfer: STC-rating of 53 when tested in STC 54-rated wall assembly
- Excellent weathering properties
- Ideal for fast-track construction
- Easy application with standard caulking gun or pneumatic pump
- Excellent bonding
- Gray color with black flecks



| | | | |
|--|---|---|--|
| FIRE BARRIER | SMOKE SEAL | WATER BARRIER | SOUND BARRIER |
| UP TO 4 HOUR Fire Protection | L RATED Meets Optional L Requirements | UL CLASS 1W Rating UL Water Leakage | STC 53 In STC 54-rated Wall Assembly |

3M™ Fire Barrier Water Tight Sealant 1000 NS and 3M™ Fire Barrier Water Tight Sealant 1003 SL

3M™ Fire Barrier Water Tight Sealant 1000 NS (non-slump) and 3M™ Fire Barrier Water Tight Sealant 1003 SL Silicone Sealant (self-leveling) are ready to use, one-component silicone elastomers. Both cure upon exposure to atmospheric humidity to form a flexible seal. Both sealants remain elastomeric and are weather resistant. They bond to most common construction materials.

- Firestop tested up to 3 hours in accordance with ASTM E 814 (UL 1479)
- Joint System Fire Resistance tested in accordance with ASTM E 1966 (UL 2079)
- Meets UL Water Leakage Test, W Rating: Class 1 requirements
- Minimizes noise transfer: STC-rating of 56 when tested in STC 56-rated wall assembly
- ±25% dynamic joint movement capability
- Excellent adhesion
- Cures upon exposure to atmospheric humidity
- Applied with conventional caulking equipment
- Re-enterable/repairable
- Aids in the prevention of moisture and water migration through a building
- Light gray color



| | | | | |
|--|---|---|--|------------------------------------|
| FIRE BARRIER | WATER BARRIER | SMOKE SEAL | SOUND BARRIER | ELASTOMERIC |
| UP TO 3 HOUR Fire Protection | UL CLASS 1W Rating UL Water Leakage | L RATED Meets Optional L Requirements | STC 56 In STC 56-rated Wall Assembly | ±25% Movement Capability |

Product Information

Silicone Sealants

3M™ Fire Barrier Silicone Sealant 2000+

3M™ Fire Barrier Silicone Sealant 2000+ is a ready-to-use, gun-grade, one-component silicone elastomer that cures upon exposure to atmospheric humidity to form a flexible seal. Sealant remains elastomeric and is weather resistant. It will bond to most common construction materials.

- Firestop tested up to 3 hours in accordance with ASTM E 814 (UL 1479)
- Firestop tested for up to 4 hours in construction joint systems in accordance with ASTM E 1966 (UL 2079)
- Minimizes noise transfer: STC-Rating of 56 when tested in STC 56-rated wall assembly
- ±13% dynamic joint movement capability
- Re-enterable/repairable
- Excellent weatherability
- Superior adhesion
- Gray color

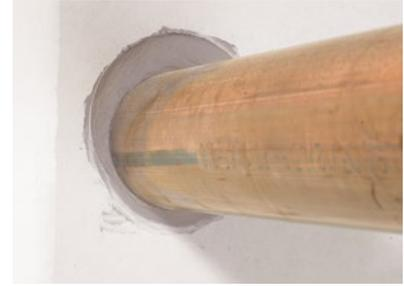

| FIRE BARRIER | SMOKE SEAL | ELASTOMERIC | SOUND BARRIER |
|--|---|------------------------------------|--|
| UP TO 4 HOUR Fire Protection | L RATED Meets Optional L Requirements | ±13% Movement Capability | STC 56 In STC 56-rated Wall Assembly |

Moldable Putty

3M™ Fire Barrier Moldable Putty+ Pads and 3M™ Fire Barrier Moldable Putty+ Sticks

3M™ Fire Barrier Moldable Putty+ Pads and Sticks are designed for use as a one-part, 100% solids intumescent firestop that restores the integrity of fire-rated building construction.

- Provides up to 4 hour fire ratings when tested by Underwriters Laboratories Inc. in accordance with ASTM E 814 (UL1479)
- Remains pliable and flexible for easy installation and re-enterability
- UL-classified for telecommunications applications (innerduct, fiber optic and cables)
- Won't dry out or crumble
- Non-halogen formula
- Adheres to all common building surfaces including metal and plastic electrical boxes
- Provides draft and cold smoke seal even before temperature increases
- Intumescent: expands when expose to fire to form a hard char which helps prevent the spread of fire, smoke and toxic gas



Small pads are typically used as a wall opening protective (e.g. membrane penetrations made by listed steel or non-metallic electrical boxes). Larger pad sizes are used to firestop metallic and non-metallic electrical outlet boxes up to 14 in. x 4.5 in. by 2-1/2 in. Sticks are typically used to seal gaps between cables in multiple penetrations and to firestop cable bundles, insulated pipe, electrical conduit, metal pipe and other through penetrations. Putty pads or sticks can be molded together (pads to pads/sticks to sticks) for larger applications.

| FIRE BARRIER | SMOKE SEAL | WALL OPENING | SOUND BARRIER |
|--|---|--|--|
| UP TO 4 HOUR Fire Protection | L RATED Meets Optional L Requirements | UP TO 2 HOUR Fire Protection | STC 52 In STC 53-Rated Wall Assembly |

Pass-Through Devices

3M™ Fire Barrier Pass-Through Devices

3M™ Fire Barrier Pass-Through Devices are a line of integrated firestopping devices that create a fire-proofed dedicated space for voice, data, telecom wires and pipes. Available in a variety of shapes and sizes. Mounting accessories and foam replacements sold separately.

- Firestop tested for up to 4 hours in accordance with ASTM E 814 (UL 1479)
- One-piece, hinged metal enclosure makes installations fast and easy
- Blank to multiple penetrants tested (0 to 100% fillable)
- Red color: easy to identify as a fire rated device during inspection
- Stackable for multiple penetrations (square devices)
- Warning labels included on device
- UL classified: meets code requirements
- Re-enterable for addition and removal of penetrants



Achieves an UL Classified L-Rating when used in conjunction with 3M™ Fire Barrier Sealant or Moldable Putty +



Putty Sleeve Kit

3M™ Fire Barrier Putty Sleeve Kits

3M™ Fire Barrier Putty Sleeve Kits offer an affordable and re-enterable solution to meet firestop codes for the installation of cable and blanks in both new or retrofit applications. Ready-to-install kit with all items needed for a complete cable or blank firestop installation.

- Firestop tested for up to 4 hours in accordance with ASTM E 814 (UL 1479)
- One-piece, hinged metal enclosure makes installations fast and easy
- Blank sleeve (0% cable fill) accommodates future cable installation
- Two-piece split/hinged design for easy retrofit installation on existing cables
- Suitable for installation in gypsum wallboard and concrete walls or floors
- No gasket required

Cable types can be a mixture of the following:

- 100 pr. No. 24 AWG copper conductor telephone cables
- 1/C-750 kcmil copper conductor power cable
- 7/C-No. 12 AWG copper conductor control cables
- Coaxial cables
- No. 23 AWG Category 6 data cables
- Fiber optic cable
- 3/C-No. 2/0 AWG aluminum conductor SER cable with No. 1 AWG aluminum ground conductor



Each Kit Includes:
(1) Split Metal Sleeve; (2) Split Mounting Brackets; (1) Bag Screws; (2) Wall Labels



Fire Barrier Pillows

3M™ Fire Barrier Self-Locking Pillows

3M™ Fire Barrier Self-Locking Pillows are self-contained, highly-intumescent product designed to firestop a wide variety of through penetrations including cable trays, conduit and blank openings. Interlocking strips hold pillows securely together yet release easily for retrofit or reuse — just remove and reinstall pillows as needed.

- Firestop tested for up to 3 hours in accordance with ASTM E 814 (UL 1479)*
- L-Rating (smoke seal) achievable when used in conjunction with 3M™ Fire Barrier Moldable Putty
- Easy retrofit: remove and reuse pillows as needed
- Interlocking strips lock pillows together
- Graphite-free composition
- Available in three sizes**
- Easy to install, easy to inspect
- No wire mesh required to secure in opening
- Can be cut and retaped with box sealing tape for odd-sized gaps



FIRE BARRIER

UP TO
3
HOUR
Fire Protection

* Ratings achieved in openings up to 1024 sq. in. (6606 sq. cm).

** Any combination of pillow sizes can be used to firestop an opening provided the minimum compression requirements are met (minimum of 25% within the opening).



3M™ Fire Barrier Pillows

3M™ Fire Barrier Pillows are self-contained, highly-intumescent product designed to firestop a wide variety of through penetrations including cable trays, conduit and blank openings.

- Firestop tested for up to 3 hours in accordance with ASTM E 814 (UL 1479)*
- L-Rating (smoke seal) achievable when used in conjunction with 3M™ Fire Barrier Moldable Putty
- Easy retrofit: remove and reuse pillows as needed
- Graphite-free composition
- Available in three sizes**
- Easy to install, easy to inspect
- No wire mesh required to secure in opening
- Can be cut and retaped with box sealing tape for odd-sized gaps



FIRE BARRIER

UP TO
3
HOUR
Fire Protection

* Ratings achieved in openings up to 1024 sq. in. (6606 sq. cm).

** Any combination of pillow sizes can be used to firestop an opening provided the minimum compression requirements are met (minimum of 25% within the opening).



Fire Barrier Blocks, Plugs and Planks

3M™ Fire Barrier Blocks, Plugs and Planks

3M™ Fire Barrier Blocks and Planks are pre-formed foam units designed for easy installation to effectively seal medium to large openings in wall and floor through-penetrations against smoke, toxic gas and flame. Plugs are designed for up to 5 inch diameter openings.

- No cure time means faster completion
- Paintable with primer
- Installation requires no special tools
- Can be repaired and reused as needed, saving time and labor
- Firestop tested in accordance with ASTM E 814/UL 1479
- Can be sealed with 3M™ Fire Barrier Rated Foam FIP 1-Step and other 3M™ Fire Barrier Sealants (sold separately)



FIRE BARRIER



Composite Sheet

3M™ Fire Barrier Composite Sheet CS-195+

Intumescent sheet used to firestop large openings. Seals penetrations against flame spread, smoke and toxic gases. This composite sheet has multiple applications, including blank openings, through penetrations of multiple cable, pipe ducts, bus ducts and cable trays. The fire-resistive intumescent sheet is bonded on one side to a layer of 28-gauge galvanized steel. The other side is reinforced with hexagonal shaped steel-wire mesh and covered with an aluminum foil scrim.

- Firestop tested for up to 4 hours in accordance with ASTM E 814 (UL 1479)
- Intumescent (expands with heat) to form a hard char that tightly seals penetrations against flame spread, smoke and toxic gases
- Multiple applications: through-penetration firestop, heat shield and firebreak protection
- UL-classified: meets all code requirements
- 100% solids
- Lightweight: easy to handle, just cut and form to desired shape
- Re-enterable for new or retrofit installations
- Easy to fasten: bolt-punch or drill-through
- No mixing or damming: installs easily with screws or anchor bolts
- Versatile: can be cut to fit irregular shapes
- Thermally conductive: allows unwanted heat buildup to escape
- Easy to install using common trade tools

FIRE BARRIER



Firestop Wraps

3M™ Fire Barrier Tuck-In Wrap Strips and Rolls

3M™ Fire Barrier Tuck-In Wrap Strips and Rolls are designed for use with plastic pipe penetrations through floors and walls. Engineered for top-side firestop installations, the tuck-in wrap strip simplifies labor by helping to eliminate the need for retaining collars, concrete screws, ladders, etc. The flexible intumescent strip wraps around the pipe and easily slides into the annular space.

- Firestop tested up to 3 hours in accordance with ASTM E 814 (UL 1479)
- Designed for improved top-side concrete floor installations to help eliminate the need for steel retaining collars and most other bottom-side installation equipment and materials
- Adhesive-backed label for quick installation
- Ready-to-install 3/16 in. thick x 2-1/2 in. wide wrap strips: available in 8.2 ft. rolls or strips precut to length for 2 in., 3 in. and 4 in. non-metallic pipes
- Firestop up to 6* in. PVC pipe

*6 in. Pipe installation requires 2-layers using 3M™ Fire Barrier Tuck-In Wrap Strip Roll



3M™ Fire Barrier Wrap Ultra GS

3M™ Fire Barrier Wrap Ultra GS is a graphite-based, largely inorganic, flexible, fire resistant, intumescent wrap. 3M™ Fire Barrier Wrap Ultra GS is designed to firestop plastic pipe penetrations in fire-rated walls, floors and floor/ceiling assemblies. The unique, intumescent property of this material means that as penetrating items such as plastic pipe are consumed by fire, 3M™ Fire Barrier Wrap Ultra GS expands to maintain a tight seal, preventing the spread of fire, deadly smoke and other by-products of combustion.

- Intumescent: expands when heated to seal around items consumed by fire
- UL approved for up to 3 hour fire ratings when tested in accordance with ASTM E 814 (UL1479)
- Excellent flexibility and versatility
- Thermal insulator and smoke seal



3M™ Fire Barrier Wrap Strips FS-195+

Firestops difficult through penetrations such as plastic pipe, insulated pipe and cables. When exposed to heat, this flexible, rubber-like strip intumesces, expanding up to ten times its original volume, forming a very hard char to prevent the migration of fire, smoke and toxic gas.

- Firestop tested up to 4 hours in accordance with ASTM E 814 (UL 1479)
- 100% solids
- One-part, graphite-free, fire-resistant strips with foil on one side
- Versatile: can be cut to fit irregular shapes
- Re-enterable: no special tools required
- Non-flame supporting
- Applications include: telephone cable, metal pipe, plastic pipe, conduit, insulated metal pipe and cable trays
- UL-classified for use on PVC, ABS, ccPVC, ccABS, PVDF, FRPP, PP and PB plastic pipe
- Dark red color

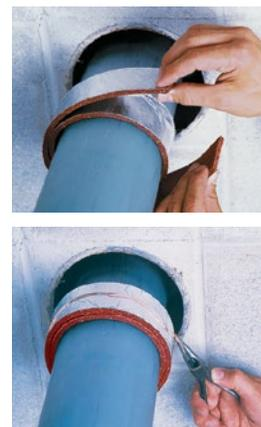

Restricting Collar

3M™ Fire Barrier RC-1 Restricting Collar

This collar works in conjunction with 3M™ Fire Barrier Wrap Strip FS-195+ and 3M™ Fire Barrier Wrap Ultra GS to close an opening left by a burned away plastic pipe.

- UL-classified for use on PVC, CPVC, ABS, ccPVC, ccABS, PVDF, PP and PB plastic pipe
- 28 gauge steel
- Used in conjunction with 3M™ Fire Barrier Wrap Strips (FS-195+ or Ultra GS) when plastic pipes have larger than a 4 in. diameter (refer to system details)



Plastic Pipe Devices and Ultra Fast Anchors

3M™ Fire Barrier Ultra Plastic Pipe Device, 3M™ Fire Barrier Plastic Pipe Device and 3M™ Ultra Fast Anchors

3M™ Fire Barrier Ultra Plastic Pipe Devices are one-piece metal collar assemblies encasing heat expanding 3M™ Ultra GS (intumescent) material. These devices are used for new and retrofit installations and will accommodate 1-1/2 in., 2 in., 3 in. and 4 in. pipes. The 3M™ Fire Barrier Plastic Pipe Device utilizes 3M™ Fire Barrier Wrap FS-195+ (intumescent) material and will accommodate and 6 inch plastic pipes. These devices firestop ccPVC, PVC, CPVC, FRPP, PVDF, ccABS and ABS pipes, cables or combos penetrating 1- and 2-hour floor/ceiling assemblies, as well as 1-, 2- and 3-hour fire-rated gypsum wallboard and fire-rated concrete wall, floor or hollow core assemblies. The device are ideal for application in drain, waste and vent or closed pipe systems.

- Up to 3-hour fire ratings when tested in accordance with ASTM E814 (UL1479)
- Ultra fast anchoring system (optional)
- One piece assembly for quick and easy installation
- Factory-made helps ensure quality consistency
- UL Classified: meets code requirements — universally recognized
- Easily identified red color (fire rated device)

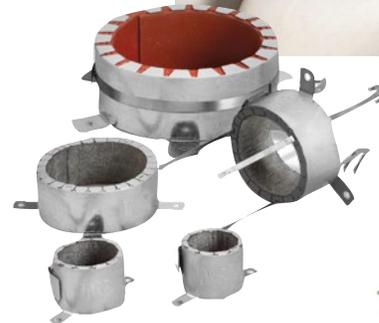

Intumescent Door/Frame & Glazing Strip

3M™ Expantrol™ Flexible Intumescent Strip E-FIS

3M™ Expantrol™ Flexible Intumescent Strip E-FIS has been designed to seal the air space between doors and frames and for glazing fire resistant glass to help prevent the passage of smoke and flames in the event of a fire. When exposed to heat such as would occur in a fire, the material expands to seal the gap and forms a char to deter the spread of a fire. This expansion or intumescence of the material helps prevent noxious gases, flames or other by-products that may be produced in a fire from penetrating into adjacent areas.

- Easy, cost-effective installation
- Excellent flexibility
- Non-flame supporting
- Low odor
- Intumescent: expands when heated to seal around objects consumed by fire
- Smoke seal: retards spread of toxic by-products of combustion
- Low flame spread and smoke development
- Versatile: can be cut to fit irregular shapes
- Re-enterable: no special tools required
- Dark red color (Black Char)



Cast-In Devices

3M™ Fire Barrier Cast-In Devices and Accessories

3M™ Fire Barrier Cast-In Devices are designed to make firestopping through concrete easy and affordable. 3M™ Fire Barrier Cast-In Devices are installed prior to the concrete pour (attaching directly to the wood forms or fluted metal decking) and can be adjusted to various concrete depths. Both devices feature easily adjustable bodies that can be adopted to concrete height, before or after pour. These devices are used primarily in new installations and are designed to accommodate concrete thickness as thin as 2-1/2 in. and pipe sizes from 1-1/2 in. to 6 in. Achieve up to 3 hour F Ratings when tested in accordance with ASTM E 814 (UL 1479).

Accessories include: 3M™ Fire Barrier Cast-In Device Height Adapter (for use with up to 12 in. concrete thickness), 3M™ Fire Barrier Cast-In Metal Deck Adapter (for use with fluted metal decks), 3M™ Fire Barrier Cast-In Tub Box Assembly (to create a void for plumbing access) and 3M™ Fire Barrier Cast Aerator Adaptor (to create a void around aerators).

- Easy installation, annular space allows for easier pipe installation
- Pipes may be installed from top or bottom of floor
- Color coded caps, retainers and labels allow quick identification of device type (white for plastic and black for metal)
- Easily adjustable bodies that can be adapted to concrete height from 2-1/2 in. to 8 in. (thicker pours can be accommodated with height adapter)
- Available in 2 in., 3 in., 4 in. and 6 in. diameter by 8 in. height
- Metallic devices (black cap) are used for metallic pipe, single and multiple cables, insulated pipe and HVAC line sets
- Non-metallic devices (white cap) are used for non-metallic pipe (including CPVC) and HVAC line sets



Firestop Spray

3M™ FireDam™ Spray 200

3M™ FireDam™ Spray 200 is a flexible, sprayable, water-based coating that dries in ambient conditions to form a flexible seal. 3M™ FireDam™ Spray 200 has an extensive portfolio of tested and listed systems for protecting construction joints, and perimeter joints (curtain wall joints). In addition this product is used to firestop through penetrations with up to 2-hour rated systems.

- Up to 4-hour fire protection in construction joints per ASTM E 1966 (UL 2079)
- Up to 2-hour fire protection for through penetration systems per ASTM E 814 (UL 1479)
- Highly elastic material maintains performance with up to ±50% movement capabilities
- High-cling properties help prevent sagging
- Water-based: dries when exposed to the atmosphere, easy water clean-up
- Robust job site formula: freeze/thaw resistant, uniform seal formation in heat and cold conditions
- Available in gray and red: applied with conventional airless spray equipment
- Fast drying: paintable when cured

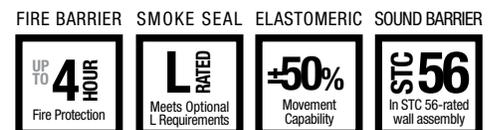

Firestop Spray (cont.)

3M™ Fire Barrier Watertight Spray

3M™ Fire Barrier Watertight Spray is a sprayable, moisture-curing hybrid siliconized polymer that forms a tough, elastomeric coating. This material is used to firestop perimeter joints (curtain wall) and construction joints.

- Up to 3-hour fire protection in construction joints per ASTM E 1966 (UL 2079)
- Up to 3-hour fire protection in perimeter joints per ASTM E 2307
- Elastic material maintains performance with up to ±10% movement capabilities
- Paintable with primer
- Broad range of applications (extensive portfolio of tested and listed building and perimeter joint systems)
- Improved spraying pattern: applied with conventional airless spray equipment
- Robust jobsite formula (freeze/thaw resistant and uniform seal formation in hot or cold conditions)

FIRE BARRIER



Firestop Mortar

3M™ Fire Barrier Mortar

3M™ Fire Barrier Mortar is a lightweight non-structural cementitious firestop product with variable mix ratios for use in through penetration applications. Up to 3-hour fire protection in tested and listed systems. Off-white with dark flecks, ready for mixing with potable water.

- Variable mix ratio: permits self-leveling as well as no-sag (no forming) application consistencies, resulting in labor savings
- Excellent adhesion: will bond to concrete, metals, wood, plastic and cable jacketing
- Re-enterable without use of power tools: results in lower maintenance costs due to ease of making cable changes
- Asbestos-free

FIRE BARRIER



Product Information

Flexible, Fire-Resistive Plenum Wrap

3M™ Fire Barrier Plenum Wrap 5A+

3M™ Fire Barrier Plenum Wrap 5A+ is a fire resistant wrap encapsulated with a scrim-reinforced foil. It provides a flexible, non-combustible enclosure for cables and pipes in return air plenums as tested to NFPA 262 (UL 910). Use with single and multiple 1 in. and larger plastic pipes and cables. This non-asbestos wrap contains a safer fiber construction and installs easily because of its high flexibility and strength.

- Tested to NFPA 262 (UL 910) flammability test, UL 1887 and ASTM E 84
- Lightweight with high flexibility for easy installation
- Safer fiber construction*

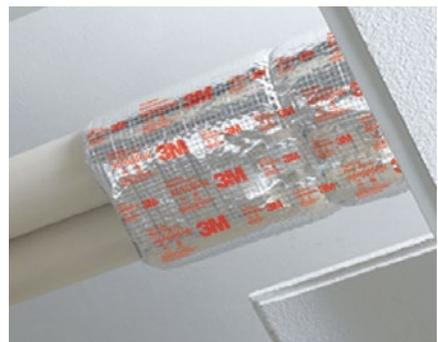

*Has been demonstrated to be soluble in the lungs according to EU67/548/EWG, Note Q for biopersistence.

Flexible, Fire-Resistive Duct Wrap Protection

3M™ Fire Barrier Duct Wrap 615+

Flexible solutions for the protection of grease ducts, ventilation air ducts, return air plenums, emergency circuits, structural steel and more. These flexible wrap products make installation easy, even around corners. Ideal for use in a wide variety of commercial and industrial applications.

Two-layer grease duct applications: 3M™ Fire Barrier Duct Wrap 615+ meets the criteria of ASTM E 2336 Standard Test Methods for Fire Resistive Grease Duct Enclosure Systems.

Single-layer air duct applications: 3M™ Fire Barrier Duct Wrap 615+ has passed ISO 6944-1985 Fire Resistance Tests — Ventilation Ducts.

T-rating for metallic through-penetrating items: 3M™ Fire Barrier Duct Wrap 615+ is used in conjunction with 3M Fire Barrier sealants to achieve up to 2-hour equal F-rating and T-rating in ASTM E 814 (UL 1479) tested through-penetrations.

- Lighter weight for easier installation (nom. 1-1/2 in. thick, 6 pcf density)
- Zero clearance to combustible throughout the entire enclosure system
- Highly flexible for installation ease
- Widest range of duct penetration firestop systems
- Low thermal conductivity and thermal shock resistant
- Supports continuous use temperatures of up to 1832°F (1000°C)
- Safer fiber construction* for contractor piece of mind

*Has been demonstrated to be soluble in the lungs according to EU guidelines 97/69/EC. Note Q for biopersistence.

FIRE BARRIER



FLEXIBLE WRAP



ICC-ES ESR-1255

Flexible Endothermic Mat

3M™ Interam™ Endothermic Mat E-5A-4

When properly installed, 3M™ Interam™ Endothermic Mat E-5A-4 provides a uniform covering that, when exposed to high temperatures, releases chemically-bound water to cool the outer surfaces of the protected item and significantly retard heat transfer. Helps protect structural steel components for up to four hours, critical electrical components for up to three hours and wall opening membranes for up to two hours. Applied to the back and sides of metallic utility boxes, this product helps achieve an equal F-rating and T-rating in membrane penetrations of rated wall assemblies. 3M™ Interam™ Endothermic Mat E-5A-4 is non-flame supporting with low-smoke evolution. The mat is flexible which aids in installation and allows it to more easily be applied on complex shapes and around corners.

- Up to 4-hour protection for structural steel (ASTM E119/UL 263 and ASTM E 1725/UL 1709), up to 3-hour electrical circuit protection (ASTM E 1725) and up to 2-hour protection for wall opening membranes (UL 1479)*
- Outstanding performance in high-intensity fires, provides protection against large hydrocarbon pool fires in accordance with ASTM E 1529 (UL 1709)
- Easy to cut and easy to install, flexible mat can even be installed directly over existing conduits fire protection
- Exterior durability when covered with 0.010 in. stainless steel jacketing
- Re-enterable for effective maintenance and inspection

*See System details for layering requirements.

WALL OPENING MEMBRANES



ELECTRICAL CIRCUITS



STRUCTURAL STEEL



High-performance endothermic mat with protective aluminum foil.



Tapes

3M™ Fire and Water Barrier Tape FWBT

3M™ Fire and Water Barrier Tape is a self-adhered membrane that provides a tough, elastomeric coating. This product has a unique pressure sensitive adhesive that aggressively sticks and stays stuck to a wide variety of substrates at both high and low temperatures, and will even adhere to damp surfaces.

- Up to 4-hour fire protection in construction joints per ASTM E 1966 (UL 2079)
- Up to 3-hour fire protection in perimeter joints per ASTM E 2307
- Up to 2-hour fire protection in through-penetration applications per ASTM E 814 (UL 1479)
- Elastic material maintains performance with up to ±50% movement capabilities
- Can be installed in temperatures as low as 0°F (18°C) and as high as 120°F (49°C)



3M™ Aluminum Foil Tape 425

3M™ Aluminum Foil Tape 425, dead-soft aluminum foil backing, excellent heat and light reflection to protect against high temperatures and U.V. degradation. The foil also serves as an excellent barrier against moisture, dust, flame and certain chemicals. Acrylic adhesive supplies superior temperature, U.V. and solvent resistance. It provides excellent age life and is ideal for harsh, long-term outdoor environments. Meets F.A.R. 25.853(a), O447.

- Used to seal cut edges of 3M™ Interam™ Endothermic Mat E-5A-4 in order to complete total encapsulation
- Thermally-conductive, dead-soft aluminum backing combined with a transparent acrylic adhesive backing
- 4.6 mils thick, aluminum foil backed, 4 in. x 60 yd. roll



3M™ FSK Facing Tape 1525CW

3M™ FSK Facing Tape 1525CW is a conformable, easy-to-apply tape that is used to seal cut edges of 3M™ Fire Barrier Duct Wrap, 3M™ Fire Barrier Plenum Wrap and similar products in order to complete total encapsulation.

- High-performance reinforced insulation tape (Foil/Scrim/Kraft)
- Mold-resistant
- Special acrylic adhesive works in both very cold and hot temperatures
- High-performance reinforced insulation tape (Foil/Scrim/Kraft)
- 5.5 mils thick, 3.89 in. x 50 yd. roll



Through Penetration Packing Material

3M™ Fire Barrier Packing Material PM4

3M™ Fire Barrier Packing Material PM4 is designed to be used as an alternative packing material to mineral wool, fiberglass and backer rod in through penetration firestop systems. With excellent strength and flexibility characteristics, it is an ideal through penetration packing material. 3M™ Fire Barrier Packing Material PM4 is an asbestos-free, inorganic material that is mold and fungi resistant when tested in accordance with ASTM C 1338. This installation friendly material is easy to dispense and its compact packaging is optimized for portability. The smooth textured woven material can be torn by hand, eliminating the need for a knife.



3M™ Fire Barrier Packing Material PM4 is approved for use in all 3M through penetration firestop systems requiring backing material.

Ordering Information

3M™ Fire Barrier Cast-In Devices and Accessories

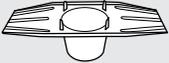
| Product | Product Number | Description | Shipping Wt./Carton | Billing UPC Number | Qty./Case | Qty./Pallet | Price Unit |
|---|----------------|------------------------------|---------------------|--------------------|-----------|-------------|------------|
| Cast-In Devices for Plastic Pipes  | 2PCID | 2 in. Diameter | 11.4 lbs. | 000-51115-16536-8 | 12 | 420 | Each |
| | 3PCID | 3 in. Diameter | 17.0 lbs. | 000-51115-16537-5 | 12 | 240 | Each |
| | 4PCID | 4 in. Diameter | 12.4 lbs. | 000-51115-16538-2 | 6 | 180 | Each |
| | 6PCID | 6 in. Diameter | 8.7 lbs. | 000-51115-16539-9 | 2 | 70 | Each |
| Cast-In Devices for Metal Pipes  | 2MCID | 2 in. Diameter | 11.6 lbs. | 000-51115-16540-5 | 12 | 420 | Each |
| | 3MCID | 3 in. Diameter | 15.3 lbs. | 000-51115-16541-2 | 12 | 240 | Each |
| | 4MCID | 4 in. Diameter | 10.5 lbs. | 000-51115-16542-9 | 6 | 180 | Each |
| | 6MCID | 6 in. Diameter | 6.0 lbs. | 000-51115-16543-6 | 2 | 70 | Each |
| Product Accessories | | | | | | | |
| Metal Deck Adaptors  | 2MDA | For use with 2PCID and 2MCID | 5.2 lbs. | 000-51115-16544-3 | 12 | 240 | Each |
| | 3MDA | For use with 3PCID and 3MCID | 6.6 lbs. | 000-51115-16545-0 | 12 | 240 | Each |
| | 4MDA | For use with 4PCID and 4MCID | 7.0 lbs. | 000-51115-16546-7 | 12 | 240 | Each |
| | 6MDA | For use with 6PCID and 6MCID | 8.2 lbs. | 000-51115-16547-4 | 12 | 192 | Each |
| Height Adaptors  | 2HA | For use with 2PCID and 2MCID | 4.1 lbs. | 000-51115-16548-1 | 12 | 420 | Each |
| | 3HA | For use with 3PCID and 3MCID | 5.2 lbs. | 000-51115-16549-8 | 12 | 240 | Each |
| | 4HA | For use with 4PCID and 4MCID | 6.3 lbs. | 000-51115-16550-4 | 12 | 240 | Each |
| | 6HA | For use with 6PCID and 6MCID | 4.9 lbs. | 000-51115-16551-1 | 12 | 144 | Each |
| Tub Box Assembly  | 3TB | For use with 2PCID and 2MCID | 8.5 lbs. | 500-51115-16586-8 | 6 | 108 | Each |

3M™ Fire Barrier Pass-Through Devices and Accessories

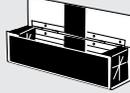
| Product | Product Number | Description | Shipping Wt./Carton | Billing UPC Number | Qty. | Price Unit |
|--|----------------|---|---------------------|--------------------|------------|------------|
| Square Device  | PT4SD | 4 in. Square Re-enterable Firestop Device (Up to 4-hr Firestop) | 13.6 lbs. | 000-51115-16597-9 | 6/Cs | Each |
| Round Device  | PT2RD | 2 in. Round Re-enterable Firestop Device (Up to 4-hr Firestop) | 7.7 lbs. | 000-51115-18773-5 | 6/Cs | Each |
| | PT4RD | 4 in. Round Re-enterable Firestop Device (Up to 4-hr Firestop) | 12.4 lbs. | 000-51115-16598-6 | 6/Cs | Each |
| Product Accessories | | | | | | |
| Single Mounting Brackets  | PT4SMB | For use with 4 in. Square Device | 16.4 lbs. | 000-51115-18752-0 | 24 Pair/Cs | Pair |
| | PT2RMB | For use with 2 in. Round Device | 11.6 lbs. | 000-51115-18774-2 | 24 Pair/Cs | Pair |
| | PT4RMB | For use with 4 in. Round Device | 10.3 lbs. | 000-51115-18754-4 | 24 Pair/Cs | Pair |
| Triplex Mounting Bracket  | PT4TMB | Gang up to three 4 in. Square Devices | 29.1 lbs. | 000-51115-18753-7 | 24 Pair/Cs | Pair |
| Sixplex Mounting Bracket  | PT4SSMB | Gang up to six 4 in. Square Devices | 9.5 lbs. | 000-51115-18777-3 | 6 Pair/Cs | Pair |
| Foam Plugs  | PT4SRP | For use with 4 in. Square Device | 1.3 lbs. | 000-51115-18794-0 | 24/Cs | Each |
| | PT2RRP | For use with 2 in. Round Device | 0.4 lbs. | 000-51115-18793-3 | 24/Cs | Each |
| | PT4RRP | For use with 4 in. Round Device | 0.8 lbs. | 000-51115-18791-9 | 24/Cs | Each |

Ordering Information

3M™ Fire Barrier Sealants

Unit Volumes: 10.1 fl. oz. tube (298.7 mL, 18.2 in.³), 10.3 fl. oz. tube (304.6 mL, 18.6 in.³), 20 fl. oz. sausage (591.5 mL, 36.1 in.³), 27 fl. oz. tube (798.5 mL, 48.7 in.³), 28 fl. oz. tube (828.1 cc, 50.5 in.³), 2 gal. pail (7.57 L, 462 in.³), 4.5 gal. pail (.017 m³, 1039.5 in.³), 5 gal. pail (18.9 L, 1155 in.³)

| Product Number | Description | Size | Color | Unit | Billing UPC Number | Qty. | Price Unit |
|---------------------|--|----------|--------|-----------|--------------------|-------|------------|
| CP 25WB+ | Up to 4-hr Penetration Firestop | 10.1 oz. | Red | Tube | 000-51115-11638-4 | 12/Cs | Each |
| | Up to 4-hr Penetration Firestop | 20 oz. | Red | Sausage | 000-51115-11642-1 | 10/Cs | Each |
| | Up to 4-hr Penetration Firestop | 27 oz. | Red | Cartridge | 000-51115-11641-4 | 6/Cs | Each |
| | Up to 4-hr Penetration Firestop | 2 gal. | Red | Pail | 000-51115-11639-1 | 1/Cs | Each |
| | Up to 4-hr Penetration Firestop | 5 gal. | Red | Pail | 000-51115-11640-7 | 1/Cs | Each |
| IC 15WB+ | Up to 3-hr Penetration Firestop | 10.1 oz. | Yellow | Tube | 000-51115-16557-3 | 12/Cs | Each |
| | Up to 3-hr Penetration Firestop | 20 oz. | Yellow | Sausage | 000-51115-16560-3 | 10/Cs | Each |
| | Up to 3-hr Penetration Firestop | 4.5 gal. | Yellow | Pail | 000-51115-16558-0 | 1/Cs | Each |
| FD 150+ | Up to 3-hr Penetration/4-hr Joint Firestop | 10.1 oz. | Blue | Tube | 000-51115-11574-5 | 12/Cs | Each |
| | Up to 3-hr Penetration/4-hr Joint Firestop | 20 oz. | Blue | Sausage | 000-51115-11634-6 | 12/Cs | Each |
| | Up to 3-hr Penetration/4-hr Joint Firestop | 28 oz. | Blue | Cartridge | 000-51115-11602-5 | 6/Cs | Each |
| | Up to 3-hr Penetration/4-hr Joint Firestop | 4.5 gal. | Blue | Pail | 500-51115-11575-7 | 1/Cs | Each |
| FD 150+ | Up to 3-hr Penetration/4-hr Joint Firestop | 10.1 oz. | Red | Tube | 000-51115-18812-1 | 12/Cs | Each |
| | Up to 3-hr Penetration/4-hr Joint Firestop | 20 oz. | Red | Sausage | 000-51115-18810-7 | 12/Cs | Each |
| | Up to 3-hr Penetration/4-hr Joint Firestop | 28 oz. | Red | Cartridge | 000-51115-18811-4 | 6/Cs | Each |
| | Up to 3-hr Penetration/4-hr Joint Firestop | 4.5 gal. | Red | Pail | 000-51115-18813-8 | 1/Cs | Each |
| FD 150+ | Up to 3-hr Penetration/4-hr Joint Firestop | 10.1 oz. | Grey | Tube | 000-51115-16564-1 | 12/Cs | Each |
| | Up to 3-hr Penetration/4-hr Joint Firestop | 20 oz. | Grey | Sausage | 000-51115-16567-2 | 12/Cs | Each |
| | Up to 3-hr Penetration/4-hr Joint Firestop | 28 oz. | Grey | Cartridge | 000-51115-16566-5 | 6/Cs | Each |
| | Up to 3-hr Penetration/4-hr Joint Firestop | 4.5 gal. | Grey | Pail | 000-51115-16565-8 | 1/Cs | Each |

3M™ Fire Barrier Water Tight Sealants (W-Rated)

| Product Number | Description | Size | Color | Unit | Billing UPC Number | Qty. | Price Unit |
|-----------------------------|--|----------|-------|---------|--------------------|-------|------------|
| Watertight Spray | Up to 3-hr Joint Firestop | 5.0 gal. | Red | Pail | 000-76308-98232-4 | 1/Cs | Each |
| | Up to 3-hr Joint Firestop | 5.0 gal. | White | Pail | 000-76308-86113-1 | 1/Cs | Each |
| 3000 WT | Intumescent Silicone (Up to 4-hr Penetration Firestop) | 10.1 oz. | Grey | Tube | 000-51115-16593-1 | 12/Cs | Each |
| | Intumescent Silicone (Up to 4-hr Penetration Firestop) | 20 oz. | Grey | Sausage | 000-51115-18788-9 | 12/Cs | Each |
| | Intumescent Silicone (Up to 4-hr Penetration Firestop) | 4.5 gal. | Grey | Pail | 500-51115-16594-3 | 1/Cs | Each |
| 1000 NS | Non-slump Silicone (Up to 3-hr Penetration/Joint Firestop) | 10.1 oz. | White | Tube | 000-51115-11535-6 | 12/Cs | Each |
| | Non-slump Silicone (Up to 3-hr Penetration/Joint Firestop) | 20 oz. | White | Sausage | 000-51115-18790-2 | 12/Cs | Each |
| | Non-slump Silicone (Up to 3-hr Penetration/Joint Firestop) | 4.5 gal. | White | Pail | 500-51115-11537-5 | 1/Cs | Each |
| 1003 SL | Self-Leveling Silicone (Up to 3-hr Penetration/Joint Firestop) | 10.1 oz. | White | Tube | 000-51115-11538-7 | 12/Cs | Each |
| | Self-Leveling Silicone (Up to 3-hr Penetration/Joint Firestop) | 20 oz. | White | Sausage | 000-51115-18789-6 | 12/Cs | Each |
| | Self-Leveling Silicone (Up to 3-hr Penetration/Joint Firestop) | 4.5 gal. | White | Pail | 500-51115-11540-5 | 1/Cs | Each |

Ordering Information

3M™ Fire Barrier Rated Foam FIP 1-Step

| Product Number | Description | Size | Color | Unit | Billing UPC Number | Qty. | Price Unit |
|--|--|-----------|---|--|--------------------|------|------------|
| FIP 1-Step     | Firestop Foam Up to 2-hr Penetration Firestop | 12.85 oz. |  |  Cartridge | 0-00-51115-54925-0 | 1/Cs | Each |
| Mixing Nozzles | Mixing Nozzles | — | — | Nozzle | 0-00-51115-54933-0 | 5/Cs | Bag |
| Albion® Manual Dispenser Gun | Manual gun for 3M™ Fire Rated Foam FIP 1-Step | — | — | Gun | 0-00-76308-14612-2 | 1/Cs | Each |
| Albion® Power Dispenser Gun | Power gun for 3M™ Fire Rated Foam FIP 1-Step | — | — | Gun | 0-00-76308-14610-8 | 1/Cs | Each |
| | 18V Li-ion Battery | — | — | Battery | 0-00-76308-14614-6 | 1/Cs | Each |

3M™ Fire Barrier Silicone Sealant (water-resistant)

| Product Number | Description | Size | Color | Unit | Billing UPC Number | Qty. | Price Unit |
|---|--|----------|---|--|--------------------|-------|------------|
| 2000+     | Up to 3-hr Penetration/4-hr Joint Firestop | 10.3 oz. |  |  Tube | 000-51115-11558-5 | 12/Cs | Each |
| | Up to 3-hr Penetration/4-hr Joint Firestop | 4.5 gal. |  |  Pail | 500-51115-11559-7 | 1/Cs | Each |

3M™ FireDam™ Spray 200

| Product Number | Description | Size | Color | Unit | Billing UPC Number | Qty. | Price Unit |
|---|--|----------|--|--|--------------------|------|------------|
| 200     | Up to 2-hr Penetration/4-hr Joint Firestop | 5.0 gal. |  |  Pail | 000-51115-18797-1 | 1/Cs | Each |
| | Up to 2-hr Penetration/4-hr Joint Firestop | 5.0 gal. |  |  Pail | 000-51115-18798-8 | 1/Cs | Each |

3M™ Fire Barrier Moldable Putty MP+

| Product Number | Description | Size | Color | Unit | Billing UPC Number | Qty. | Price Unit |
|---|---|---|---|--|--------------------|--------------------|------------|
| MPP-1+     | Moldable Putty Firestop—Pad (Up to 2-hr Wall Openings/ 4-hr Penetration Firestop) | 4 in. x 8 in. (1/10 in. thick) |  |  Pad | 000-51115-16508-5 | 10/Pk, 10 Pk/Cs | Each |
| MPP-4S+     | Moldable Putty Firestop—Pad (Up to 2-hr Wall Openings/ 4-hr Penetration Firestop) | 7 in. x 7 in. (1/10 in. thick) |  |  Pad | 000-51115-16509-2 | 20/Cs | Each |
| MPP-5S+     | Moldable Putty Firestop—Pad (Up to 2-hr Wall Openings/ 4-hr Penetration Firestop) | 9.5 in. x 9.5 in. (1/10 in. thick) |  |  Pad | 000-51115-16510-8 | 20/Cs | Each |
| MP+    | Moldable Putty Firestop—Stix in Tube (Up to 4-hr Penetration Firestop) | 1.45 in. Dia. x 6 in. Approximate Dimension |  |  Stix | 000-51115-16561-0 | 12/Cs | Each |
| MPS-2+    | Moldable Putty Firestop—Stix (Up to 4-hr Penetration Firestop) | 1.5 in. Dia. x 11.5 in. Approximate Dimension |  |  Stix | 000-51115-16526-9 | 10/Cs | Each |

3M™ Fire Barrier Mortar

| Product | Description | Size | Color | Unit | Billing UPC Number | Qty. | Price Unit |
|---|--|---------|---|--|--------------------|------|------------|
| Mortar (non load-bearing)  | Dry Mix Mortar Firestop (Up to 3-hr Penetration Firestop) | 28 lbs. |  |  Pail | 000-51115-54901-4 | 1/Cs | Each |
| | Dry Mix Mortar Firestop (Up to 3-hr Penetration Firestop) | 44 lbs. |  |  Bag | 000-51115-54900-7 | 1/Cs | Each |

Ordering Information

3M™ Fire Barrier Putty Sleeve Kits

| Product Number | Description | Sleeve Size | Shipping Wt./Case | Unit | Billing UPC Number | Qty. | Price Unit |
|---|--|-------------|-------------------|------|--------------------|------|------------|
| Each Kit Includes: (1) Split Metal Sleeve; (2) Split Mounting Brackets; (1) Bag Screws; (2) Wall Labels | | | | | | | |
| DT 100   | Re-enterable Firestop Kit (Up to 4-hr Penetration Firestop) | 1 in. Dia. | 1.7 lbs. | Kit | 000-51115-18809-1 | 1/Cs | Each |
| DT 200   | Re-enterable Firestop Kit (Up to 4-hr Penetration Firestop) | 2 in. Dia. | 3.0 lbs. | Kit | 000-51115-18808-4 | 1/Cs | Each |
| DT 400   | Re-enterable Firestop Kit (Up to 4-hr Penetration Firestop) | 4 in. Dia. | 6.9 lbs. | Kit | 000-51115-18806-0 | 1/Cs | Each |

3M™ Fire Barrier Composite Sheet CS-195+

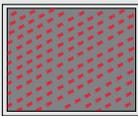
| Product Number | Description | Size | Unit | Shipping Wt./Case | Billing UPC Number | Qty. | Price Unit |
|--|--|--|-------|-------------------|--------------------|------|------------|
| CS-195+ (non load-bearing) Openings up to 36 sq. ft.   | Composite Sheet (Up to 4-hr Penetration Firestop) | 36 in. x 24 in. (0.303 in. thick nominal) | Sheet | 18.6 lbs. | 000-51115-07220-8 | 1/Cs | Each |
| | Composite Sheet (Up to 4-hr Penetration Firestop) | 28 in. x 52 in. (0.303 in. thick nominal) | Sheet | 32.0 lbs. | 000-51115-08260-3 | 1/Cs | Each |
| | Composite Sheet (Up to 4-hr Penetration Firestop) | 16 in. x 28 in. (0.303 in. thick nominal) | Sheet | 10.6 lbs. | 000-51115-07437-0 | 1/Cs | Each |
| | Composite Sheet (Up to 4-hr Penetration Firestop) | 36 in. x 41 in. (0.303 in. thick nominal) | Sheet | 34.9 lbs. | 000-51115-07224-6 | 1/Cs | Each |
| | Composite Sheet (Up to 4-hr Penetration Firestop) | 36 in. x 36 in. (0.303 in. thick nominal) | Sheet | 30.2 lbs. | 000-51115-07222-2 | 1/Cs | Each |

3M™ Fire Barrier Wrap Strips FS-195+

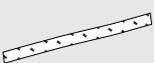
| Product | Product Number | Description | Size | Unit | Shipping Wt./Case | Billing UPC Number | Qty. | Price Unit |
|---|----------------|---|-----------------------------------|-------|-------------------|--------------------|-------|------------|
| Wrap Strip   | FS-195+ | Intumescent wrap for most pipes and cables (Up to 4-hr Firestop) | 2 in. x 24 in. (1/4 in. thick) | Strip | 7.7 lbs. | 000-51115-07115-7 | 10/Cs | Each |

3M™ Fire Barrier Wrap Ultra GS

| Product | Product Number | Description | Size | Unit | Shipping Wt./Case | Billing UPC Number | Qty. | Price Unit |
|---|----------------|---|-----------------------------------|------|-------------------|--------------------|------|------------|
| Ultra GS   | ULTRA-GS-40 | Intumescent wrap for insulated pipes, plastic pipes and combos (Up to 4-hr Firestop) | 2 in. x 40 ft. (1/8 in. thick) | Roll | 29.0 lbs. | 000-51115-16507-8 | 5/Cs | Each |

3M™ Fire Barrier Tuck-In Wrap Strips

| Product | Product Number | Description | Size | Unit | Shipping Wt./Case | Billing UPC Number | Qty. | Price Unit |
|--|----------------|---|--|-------|-------------------|--------------------|-------|------------|
| Tuck-In Wrap Strips   | WS 200 | Intumescent wrap for 2 in. nominal plastic pipes (Up to 3-hr Firestop) | 2-1/2 in. x 8-1/4 in. (3/16 in. thick) | Strip | 3.9 lbs. | 500-51115-18814-0 | 24/Cs | Each |
| | WS 300 | Intumescent wrap for 3 in. nominal plastic pipes (Up to 3-hr Firestop) | 2-1/2 in. x 11-1/2 in. (3/16 in. thick) | Strip | 5.4 lbs. | 500-51115-18815-7 | 24/Cs | Each |
| | WS 400 | Intumescent wrap for 4 in. nominal plastic pipes (Up to 3-hr Firestop) | 2-1/2 in. x 14-7/8 in. (3/16 in. thick) | Strip | 7.0 lbs. | 500-51115-18817-1 | 24/Cs | Each |
| | WS Roll | Intumescent wrap for plastic pipes (Up to 3-hr Firestop) | 2-1/2 in. x 98.4 in. (3/16 in. thick) | Roll | 15.9 lbs. | 500-51115-18821-3 | 6/Cs | Roll |

Product Information

Ordering Information

3M™ Fire Barrier Pillows

| Product | Product Number | Description | Size | Unit | Shipping Wt./Case | Billing UPC Number | Qty. | Price Unit |
|---|----------------|--|--------------------------------|--------|-------------------|--------------------|-------|------------|
|  | FB249 | Re-enterable pillows (Up to 3-hr Firestop) | 2 in. x 4 in. x 9 in. (Small) | Pillow | 12.5 lbs. | 000-51115-16530-6 | 24/Cs | Each |
| | FB269 | Re-enterable pillows (Up to 3-hr Firestop) | 2 in. x 6 in. x 9 in. (Medium) | Pillow | 12.5 lbs. | 000-51115-16531-3 | 16/Cs | Each |
| | FB369 | Re-enterable pillows (Up to 3-hr Firestop) | 3 in. x 6 in. x 9 in. (Large) | Pillow | 15.8 lbs. | 000-51115-16532-0 | 20/Cs | Each |

3M™ Fire Barrier Self-Locking Pillows

| Product | Product Number | Description | Size | Unit | Shipping Wt./Case | Billing UPC Number | Qty. | Price Unit |
|---|----------------|--|--------------------------------|--------|-------------------|--------------------|-------|------------|
|  | FB249SL | Re-enterable, self-locking pillows (Up to 3-hr Firestop) | 2 in. x 4 in. x 9 in. (Small) | Pillow | 12.5 lbs. | 500-51115-16578-3 | 24/Cs | Each |
| | FB269SL | Re-enterable, self-locking pillows (Up to 3-hr Firestop) | 2 in. x 6 in. x 9 in. (Medium) | Pillow | 12.5 lbs. | 500-51115-16579-0 | 16/Cs | Each |
| | FB369SL | Re-enterable, self-locking pillows (Up to 3-hr Firestop) | 3 in. x 6 in. x 9 in. (Large) | Pillow | 15.8 lbs. | 500-51115-16580-6 | 20/Cs | Each |

3M™ Fire Barrier Blocks, Plugs and Planks

| Product | Product Number | Description | Size | Unit | Shipping Wt./Case | Billing UPC Number | Qty. | Price Unit |
|---------|----------------|--|--------------------------------|------------|-------------------|--------------------|-------|------------|
| Block | B258 | Used to fill annular space created by pipes and cables penetrating through fire rated construction | 2.36 in. x 5.12 in. x 7.87 in. | Block | 14.78 lbs. | 000-76308-97939-3 | 12/Cs | Each |
| Plugs | PLG2 | | 2 in. | Plug | 1.41 lbs. | 000-76308-98126-6 | 4/Cs | Each |
| | PLG4 | | 4 in. | Plug | 3.23 lbs. | 000-76308-98203-4 | 4/Cs | Each |
| Plank | PK39 | 2.35 in. x 5.12 in. x 39.37 in. | Plank | 19.02 lbs. | 000-76308-98231-7 | 3/Cs | Each | |

3M™ Fire Barrier Plastic Pipe Devices

| Product | Product Number | Description | Size | Unit | Shipping Wt./Case | Billing UPC Number | Qty. | Price Unit |
|---|----------------|--|------------------|---------|-------------------|--------------------|--------|------------|
|  | Ultra PPD 1.5 | Firestop for non-metallic pipes, cables and combos (Up to 3-hr Firestop) | 1.5 in. Dia. | Device | 3.9 lbs. | 000-51115-08378-5 | 10/Cs | Each |
| | Ultra PPD 2.0 | | 2 in. Dia. | Device | 4.5 lbs. | 000-51115-08379-2 | 10/Cs | Each |
| | Ultra PPD 3.0 | | 3 in. Dia. | Device | 7.5 lbs. | 000-51115-08380-8 | 10/Cs | Each |
| | Ultra PPD 4.0 | | 4 in. Dia. | Device | 11.9 lbs. | 000-51115-08381-5 | 10/Cs | Each |
|  | PPD 6.0 | Firestop for non-metallic pipes, cables and combos (Up to 3-hr Firestop) | 6 in. Dia. | Device | 20.2 lbs. | 000-51115-08253-5 | 5/Cs | Each |
| Mounting Accessories | | | | | | | | |
|  | UF Anchor | Anchors for fast installation of plastic pipe devices | 3/4 in. x 16 in. | Anchors | 14.9 lbs. | 000-51115-11530-1 | 400/Cs | Each |

3M™ Fire Barrier RC-1 Restricting Collar

| Product Number | Description | Size | Unit | Shipping Wt./Case | Billing UPC Number | Qty. | Price Unit |
|----------------|---|----------------|------|-------------------|--------------------|------|------------|
| RC-1 | Steel collar for use with Ultra GS or FS-195+ for firestopping up to 10 in. diameter plastic pipe | 2 in. x 25 ft. | Roll | 5.4 lbs. | 000-54007-08324-5 | 1/Cs | Roll |

3M™ Fire Barrier Packing Material PM 4

| Product Number | Description | Size | Unit | Shipping Wt./Case | Billing UPC Number | Qty. | Price Unit |
|----------------|---|------------------|------|-------------------|--------------------|------|------------|
| PM 4 | Packing material for use in 3M through-penetration firestop systems | 4 in. x 20.5 ft. | Roll | 19.6 lbs. | 000-51115-18764-3 | 5/Cs | Roll |

Ordering Information

3M™ Interam™ Endothermic Mat E-5A-4

| Product Number | Description | Size | Unit | Shipping Wt./Case | Billing UPC Number | Qty. | Price Unit |
|---|--|------------------------------------|------|-------------------|--------------------|------|------------|
| E-5A-4 | Protective wrap for cable trays, conduits, wall opening membranes and more | 24.5 in. x 20 ft. (.408 in. thick) | Roll | 86.1 lbs. | 000-51115-54913-7 | 1/Cs | Roll |
|  | | 24.5 in. x 20 ft. (.408 in. thick) | Roll | 86.1 lbs. | 000-51115-54913-7 | 1/Cs | Roll |
|  | | 24.5 in. x 20 ft. (.408 in. thick) | Roll | 86.1 lbs. | 000-51115-54913-7 | 1/Cs | Roll |

3M™ Fire Barrier Duct Wrap 615+

| Product Number | Description | Size | Unit | Shipping Wt./Case | Billing UPC Number | Qty. | Price Unit |
|----------------|--|---------------------------------|--------|-------------------|--------------------|------|------------|
| 615+ | Space saving, flexible wrap for protection of air, grease, and chemical fume ducts | 24 in. x 25 ft. (1.5 in. thick) | Roll | 49.7 lbs. | 000-51115-54905-2 | 1/Cs | Each |
| | Space saving, flexible wrap for protection of air, grease, and chemical fume ducts | 48 in. x 25 ft. (1.5 in. thick) | Roll | 99.4 lbs. | 000-51115-54906-9 | 1/Cs | Each |
| | Collar for butted joint installations | 6 in. x 25 ft. (1.5 in. thick) | Collar | 49.7 lbs. | 000-51115-18804-6 | 4/Cs | Each |

Use 2 layers for grease ducts per ASTM 2336. Use 1 layer for air ducts per ISO 6994. Up to 2-hour T-ratings for through penetrations.

3M™ Fire Barrier Plenum Wrap 5A+

| Product Number | Description | Size | Unit | Shipping Wt./Case | Billing UPC Number | Qty. | Price Unit |
|----------------|---|---------------------------------|------|-------------------|--------------------|------|------------|
| 5A+ | Flexible wrap for protection of plenum spaces | 24 in. x 50 ft. (0.5 in. thick) | Roll | 34.8 lbs. | 000-51115-18802-2 | 1/Cs | Roll |
| | Flexible wrap for protection of plenum spaces | 48 in. x 25 ft. (0.5 in. thick) | Roll | 115.0 lbs. | 000-51115-18805-3 | 2/Cs | Roll |

3M™ Fire and Water Barrier Tape FWBT

| Product Number | Description | Size | Unit | Shipping Wt./Case | Billing UPC Number | Qty. | Price Unit |
|----------------|---|---------------------------------|------|-------------------|--------------------|-------|------------|
| FWBT | Used to firestop perimeter joints (curtain wall), construction joints, and through penetration openings | 2 in. x 75 ft. (9.9 mil thick) | Roll | 26.97 lbs. | 0-00-76308-86899-4 | 24/Cs | Each |
| | | 3 in. x 75 ft. (9.9 mil thick) | Roll | 26.0 lbs. | 0-00-76308-14448-7 | 16/Cs | Each |
| | | 4 in. x 75 ft. (9.9 mil thick) | Roll | 26.5 lbs. | 0-00-76308-86900-7 | 12/Cs | Each |
| | | 6 in. x 75 ft. (9.9 mil thick) | Roll | 26.06 lbs. | 0-06-38060-13883-0 | 8/Cs | Each |
| | | 8 in. x 75 ft. (9.9 mil thick) | Roll | 18.4 lbs. | 0-00-76308-86901-4 | 4/Cs | Each |
| | | 12 in. x 75 ft. (9.9 mil thick) | Roll | 25.7 lbs. | 0-00-76308-86902-1 | 4/Cs | Each |

3M™ Aluminum Foil Tape 425

| Product Number | Description | Size | Unit | Shipping Wt./Case | Billing UPC Number | Qty. | Price Unit |
|----------------|---|--------------------------------|------|-------------------|--------------------|------|------------|
| 425 | Seals cut edges of 3M™ Interam™ Endothermic Mat | 4 in. x 60 yd. (4.6 mil thick) | Roll | 6.4 lbs. | 000-51138-95074-3 | 2/Cs | Roll |

3M™ FSK Facing Tape 3320

| Product Number | Description | Size | Unit | Shipping Wt./Case | Billing UPC Number | Qty. | Price Unit |
|----------------|---|-----------------------------------|------|-------------------|--------------------|------|------------|
| 3320 | Seals cut edges of 3M™ Fire Barrier Duct Wrap and Plenum Wrap | 3.89 in. x 50 yd. (6.5 mil thick) | Roll | 18.0 lbs. | 000-51115-00705-7 | 2/Cs | Roll |

3M™ Expantrol™ Flexible Intumescent Strip E-FIS

| Product Number | Description | Size | Unit | Shipping Wt./Case | Billing UPC Number | Qty. | Price Unit |
|----------------|---|-----------------------------------|------|-------------------|--------------------|-------|------------|
| E-FIS | Protective seal for doors, frames and windows needing fire-resistance | 0.5 in. x 50 ft. (1/16 in. thick) | Roll | 13.0 lbs. | 000-51115-11626-1 | 10/Cs | Roll |

3M Fire Protection Products

Date: April 6, 2017
Subject: **GENERAL CERTIFICATE OF CONFORMANCE**
3M FIRE PROTECTION PRODUCTS

Product Category: Through Penetration Firestop Products

| | |
|--|---|
| 3M™ Aluminum Foil Tape 425 | 3M™ Fire Barrier Sealant FD 150+ |
| 3M™ Expanrol™ Flexible Intumescent Strip E-FIS | 3M™ Fire Barrier Sealant IC 15WB+ |
| 3M™ Fire Barrier 2 in. Plug PLG2 | 3M™ Fire Barrier Self-Locking Pillows |
| 3M™ Fire Barrier 4 in. Plug PLG4 | 3M™ Fire Barrier Silicone Sealant 2000+ |
| 3M™ Fire Barrier Block B258 | 3M™ Fire Barrier Tuck-In Wrap Strips |
| 3M™ Fire Barrier Cast-In Devices and Accessories | 3M™ Fire Barrier Ultra Plastic Pipe Device (UPPD) |
| 3M™ Fire Barrier Composite Sheet CS-195+ | 3M™ Fire Barrier Water Tight Sealant 1000 NS |
| 3M™ Fire Barrier Sealant CP 25WB+ | 3M™ Fire Barrier Water Tight Sealant 1003 SL |
| 3M™ Fire Barrier Moldable Putty+ Pads (MPP+) | 3M™ Fire Barrier Water Tight Sealant 3000 WT |
| 3M™ Fire Barrier Moldable Putty+ Sticks (MP+) | 3M™ Fire Barrier Watertight Spray |
| 3M™ Fire Barrier Mortar | 3M™ Fire Barrier Wrap Strips FS-195+ |
| 3M™ Fire Barrier Packing Material PM4 | 3M™ Fire Barrier Wrap Ultra GS |
| 3M™ Fire Barrier Pass-Through Devices | 3M™ Fire Block Foam FB-Foam |
| 3M™ Fire Barrier Pillows | 3M™ Fire Block Sealant FB 136 |
| 3M™ Fire Barrier Plank PK39 | 3M™ FireDam™ Spray 200 |
| 3M™ Fire Barrier Plastic Pipe Device (PPD) | 3M™ Interam™ Stainless Steel Foil Tape T-65 |
| 3M™ Fire Barrier Putty Sleeve Kits | 3M™ Marine Fire Wrap |
| 3M™ Fire Barrier Rated Foam FIP 1-Step | 3M™ Smoke and Sound Sealant SS 100 |
| 3M™ Fire and Water Barrier Tape FWBT | 3M™ Fire Barrier RC-1 Restricting Collar |
| 3M™ Smoke and Sound Tape SST | |

The above listed products are tested to one or more of the following standards:

- ASTM E 119 (ANSI/UL 263) Standard Test Methods for Fire Tests of Building Construction and Materials
- ASTM E 814 (ANSI/UL 1479) Standard Test Method for Fire Tests of Penetration Firestop Systems (under positive furnace pressure of minimum 0.01 inches of water column)
- ASTM E 84 (ANSI/UL 723) Standard Test Method for Surface Burning Characteristics of Building Materials
- ASTM E 1966 (ANSI/UL 2079) Standard Test Method for Fire-Resistive Joint Systems
- NFPA 252 Standard Methods of Fire Test and Door Assemblies
- UBC Standard 7-2(97)
- IMO Res. A.754(18)
- ASTM E 2307 Standard Test Method for Determining Fire Resistance of Perimeter Fire Barriers Using Intermediate-Scale, Multi-story Test Apparatus
- ASTM E 136 Standard Test Method for Behavior of Material in a Vertical Tube Furnace at 750°C
- ASTM C 1338 Standard Test Method for Determining Fungi Resistance of Insulation Materials and Facings
- ISO 6944-1985 Fire Resistance Tests — Ventilation Ducts
- ASTM C 1241 Standard Test Method for Volume Shrinkage of Latex Sealants During Cure
- CAN/ULC S115 Standard Method of Fire Tests of Firestop Systems
- ASTM E 90 Standard Test Method for Laboratory Measurement of Airborne Sound Transmission Loss of Building Partitions and Elements

These products are formulated without asbestos, polychlorinated biphenyls (PCBs) or lead.

Issued by:

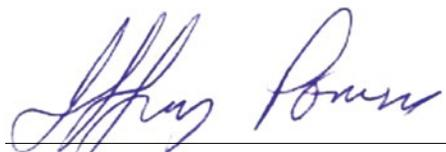

Quality Manager or Designee



Technical Manager or Designee

3M Fire Protection Products

Date: June 1, 2015

Subject: **GENERAL CERTIFICATE OF CONFORMANCE**
3M FIRE PROTECTION PRODUCTS

Product Category: Wrap Products

3M™ Fire Barrier Duct Wrap 615

3M™ Interam™ I-10 Series Mats

3M™ Fire Barrier Duct Wrap 615+

3M™ Fire Barrier Plenum Wrap 5A+

3M™ Interam™ E-5 Series Mats

3M™ Fire Barrier Duct Wrap Collars

These Products are tested to one or more of the following standards:

- UL 1978 Grease Duct 1 or 2 hour Shaft Enclosure (Sections 12 and 13)
- ICC-ES AC101 Grease Ducts, Flexible Enclosure Systems
- ASTM E 119 (ANSI/UL 263) Fire Tests of Building Construction and Materials Time-Temperature Curve
- ASTM E 814 (ANSI/UL 1479) Fire Tests of Through-Penetration Fire Stops
- ASTM E 84 (ANSI/UL 723) Surface Burning Characteristics of Building Materials
- ASTM E 136 Test Method for Behavior of Materials in a Vertical Tube Furnace at 750°C
- ASTM C 411 Hot Surface Performance of High Temperature Thermal Insulation
- ASTM C 518 Standard Test Method for Steady-State Thermal Transmission Properties by Means of the Heat Flow Meter Apparatus
- UL 910 Test Method for Fire and Smoke Characteristics of Cables
- UL 1887 Fire Test of Plastic Sprinkler Pipe for Visible Flame and Smoke Characteristics
- NFPA 262 Standard Method of Test for Flame Travel and Smoke of Wires and Cables for Use in Air-Handling Spaces
- ASTM E 2336 Standard Test Methods for Fire Resistive Grease Duct Enclosure Systems
- ISO 6944-1985 Fire Resistance Tests — Ventilation Ducts
- ASTM E 1725 (UL 1724) Standard Test Methods for Fire Tests of Fire-Resistive Barrier Systems for Electrical System Components
- ASTM E 1529 (UL 1709) Standard Test Methods for Determining Effects of Large Hydrocarbon Pool Fires on Structural Members and Assemblies

No asbestos, PCBs or lead are used or contained in these products.

Issued by:



Quality Manager or Designee



Technical Manager or Designee

3M Fire Protection Products

BROADCAST NO. T17-003

Date: April 10, 2017

Issued by: 3M IATD EH&R Department

Title: **LEED® v4 BD+C (New Construction and Major Renovation) Credit Contribution and/or Compliance**
3M FIRE PROTECTION PRODUCTS

Indoor Environmental Quality – Low-Emitting Materials:

| Product Name | VOC Content (g/l) Method 24 | VOC Emissions CDPH Spec 01350 v1.1 |
|--|--------------------------------|---------------------------------------|
| 3M™ Fire and Water Barrier Tape FWBT | n/a | Testing Complete |
| 3M™ Smoke and Sound Tape SST | n/a | Testing Complete |
| 3M™ FPP Watertight Spray | 131.2 | Testing Complete |
| 3M™ FireDam™ Spray 200 | 2.9 | Testing Complete |
| 3M™ Fire Barrier Sealant FD 150+ | 114.6 | Testing Complete |
| 3M™ Fire Barrier Sealant IC 15 WB+ | 3.96 | Testing Complete |
| 3M™ Fire Barrier Sealant CP 25WB+ | 5.69 | Testing Complete |
| 3M™ Fire Barrier Water Tight Sealant 1000NS | 47.3 | Testing Complete |
| 3M™ Fire Barrier Silicone Sealant 2000+ | 29.0 | Testing Complete |
| 3M™ Fire Barrier Water Tight Sealant 3000 WT | 64.7 | Testing Complete |
| 3M™ Fire Barrier Composite Sheet CS-195+ | n/a | Testing Complete |
| 3M™ Fire Barrier Duct Wrap 615+ | n/a | Testing Complete |

All samples were tested at Intertek Testing Services NA Inc. an ISO/IEC Standard 17025:2005 accredited laboratory. VOC Emission test certificates available on request.

Materials and Resources

- Building Product Disclosure and Optimization – Sourcing of Raw Materials
 - Raw Material source and extraction information for this product is considered to be 3M confidential and is therefore not available.
- Building Product Disclosure and Optimization – Material Ingredients
 - Recycled Content: The above listed products do not contain any pre- or post-consumer recycled material at this time.
 - Salvaged/Refurbished: n/a
 - Rapidly Renewable Materials: The above listed products do not contain any rapidly renewable materials.
- Construction and Demolition Waste Management:
 - Packaging and pallet components contribute to recycled and/or salvage content. 3M will provide specific product information on request.

Note: For information on product composition greater than 1%, or chemicals of concern, please see 3M.com/sds for Safety Data Sheets (SDS) and Regulatory Data Sheets (RDS).

3M Fire Protection Products

Date: March 28, 2017

Subject: **SHELF LIFE DEFINITIONS AND LOT NUMBER INTERPRETATIONS**
3M FIRE PROTECTION PRODUCTS

Issued by: Rick Heidick

The following 3M products do not have a shelf life requirement when stored indoors:

3M™ Expanrol™ Flexible Intumescent Strip E-FIS
3M™ Fire Barrier Block B258
3M™ Fire Barrier Cast-In Devices and Accessories
3M™ Fire Barrier Composite Sheet CS-195+
3M™ Fire Barrier Duct Wrap 15A
3M™ Fire Barrier Duct Wrap 20A
3M™ Fire Barrier Duct Wrap 615
3M™ Fire Barrier Duct Wrap 615+
3M™ Fire Barrier Duct Wrap Collars
3M™ Fire Barrier Grease Duct Access Doors
3M™ Fire Barrier Moldable Putty+ Pads (MPP+)
3M™ Fire Barrier Moldable Putty+ Sticks (MP+)
3M™ Fire Barrier Packing Material PM4
3M™ Fire Barrier Pass-Through Devices
3M™ Fire Barrier Pillows
3M™ Fire Barrier Plank PK39
3M™ Fire Barrier Plastic Pipe Device (PPD)
3M™ Fire Barrier Plug 2 in. PLG2
3M™ Fire Barrier Plug 4 in. PLG4
3M™ Fire Barrier Putty Sleeve Kits
3M™ Fire Barrier RC-1 Restricting Collar
3M™ Fire Barrier Self-Locking Pillows
3M™ Fire Barrier Tuck-In Wrap Strips
3M™ Fire Barrier Ultra Plastic Pipe Device (UPPD)
3M™ Fire Barrier Ultra RC Pack
3M™ Fire Barrier Wrap Strips FS-195+
3M™ Fire Barrier Wrap Ultra GS
3M™ Interam™ E-5 Series Mats
3M™ Interam™ I-10 Series Mats
3M™ Marine Fire Wrap

The following 3M products have shelf lives:

3M™ Aluminum Foil Tape 425
3M™ Fire and Water Barrier Tape FWBT
3M™ Fire Barrier Mortar
3M™ Fire Barrier Rated Foam FIP 1-Step
3M™ Fire Barrier Sealant CP 25WB+
3M™ Fire Barrier Sealant FD 150+
3M™ Fire Barrier Sealant IC 15WB+
3M™ Fire Barrier Silicone Sealant 2000+
3M™ Fire Barrier Water Tight Sealant 1000 NS
3M™ Fire Barrier Water Tight Sealant 1003 SL
3M™ Fire Barrier Water Tight Sealant 3000 WT
3M™ Fire Barrier Watertight Spray
3M™ Fire Block Foam FB-Foam
3M™ Fire Block Sealant FB 136
3M™ FireDam™ Spray 200
3M™ Interam™ FireDam™ 150 Caulk
3M™ Interam™ Stainless Steel Tape T-65
3M™ Smoke and Sound Sealant SS 100
3M™ Smoke and Sound Tape SST

Shelf life and lot number interpretation is listed on the following pages.

3M Fire Protection Products

Shelf life and lot number interpretation is listed below, on the previous page and on the following page.

3M™ Fire Block Sealant FB 136

- Shelf life of 12 months from date of packaging when stored in original unopened container at 68°F (20°C); FB 136 Sealant is also Freeze-Thaw Stable, however, for maximum shelf life store between 33°F (1°C) and 90°F (32°C)
- 10.1 fl. oz. cartridges

YYDDD-X Example: 14002-1

- 14 = Last two digits of year of production
 - 002 = Julian Date of production
 - 1 = Lot number of bulk product (January 2, 2014 would be the date of packaging)
-

3M™ Fire Barrier Watertight Spray

- Shelf life is 12 months from date of manufacture when stored below 100°F (38°C)
- Store indoors in dry conditions; It is recommended that the pails of product remain in heated storage above 40°F (4°C) prior to spraying material
- Spray has been cycled from 10–70°F (12–21°C) up to 10 times with no significant effects to product performance
- 5 gallon pail

YYDDD-X Example: 7039AS

- 7 = Last digit of year manufactured
 - 039 = Julian Date
 - AS = Random characters to distinguish between lot numbers (February 8, 2017 would be the date of packaging)
-

3M™ FireDam™ Spray 200

- Shelf life is 18 months from date of packaging when stored above 40°F (4°C)
- 5 gallon pail

YDDDX Example: 5183AS

- 5 = Last digit of year manufactured
 - 183 = Julian Date
 - AS = Random characters to distinguish between lot numbers (July 2, 2015 would be the date of packaging)
-

3M™ Fire Barrier Mortar

- Shelf life of **bagged product** is 3 years from date of packaging when stored in original unopened bags in dry, indoor conditions
- Shelf life of **plastic pail product** is indefinite when stored in original unopened pails in dry, indoor conditions
- 28 lb. plastic pail and 44 lb. poly-lined paper bag

YDDDX Example: 5183AS

- 5 = Last digit of year manufactured
 - 183 = Julian Date
 - AS = Random characters to distinguish between lot numbers (July 2, 2015 would be the date of packaging)
-

3M™ Fire Block Foam FB-Foam

- Shelf life of 15 months from date of packaging in original unopened packages; See bottom of can for expiration date and lot information
- 12.0 fl. oz. can

YDDDX Example: 5183AS

- 5 = Last digit of year manufactured
 - 183 = Julian Date
 - AS = Random characters to distinguish between lot numbers (July 2, 2015 would be the date of packaging)
-

3M™ Smoke and Sound Sealant SS 100

- Shelf life is 18 months in original unopened containers from date of packaging when stored above 68°F (20°C) and below 90°F (32°C)
- 20.0 oz. sausages, 28.0 fl. oz. cartridges and 4.5 gallon pails

MMDDYY-X Example: 063015-1

- 063015 = Date of Production
 - 1 = Shift number (June 30, 2015 would be the date of packaging)
-

3M Fire Protection Products

Shelf life and lot number interpretation is listed below and on the following pages.

3M™ Fire Barrier Sealant CP 25WB+ and 3M™ Fire Barrier Sealant IC 15WB+

- Shelf life is 12 months in original unopened containers from date of packaging when stored above 68°F (20°C)
- CP 25WB+ is available in 10.1 fl. oz. cartridges, 20.0 fl. oz. sausages, 27.0 fl. oz. cartridges, 2 gallon pails and 5 gallon pails
- IC 15WB+ is available in 10.1 fl. oz., 20.0 fl. oz. sausages and 4.5 gallon pails

YDDDXX Example: 5183AS

- 5 = Last digit of year manufactured
- 183 = Julian Date
- AS = Random characters to distinguish between lot numbers (July 2, 2015 would be the date of packaging)

3M™ Fire Barrier Sealant FD 150+

- Shelf life of 18 months from date of packaging when stored in original unopened container at 68°F (20°C)
- 10.1 fl. oz. cartridges, 20.0 fl. oz. sausages, 28.0 fl. oz. cartridges and 4.5 gallon pails

AAMDDYY-XL Example: BN082214-02

- AA = BN → Blue, RN → Red, LN → Limestone
- 08 = Month of Production
- 22 = Day of Production
- 14 = Last two digits of the year of production
- 02 = Consecutive batch number on that date (August 22, 2014 would be the date of packaging)

3M™ Fire Barrier Water Tight Sealant 3000 WT

- Shelf life is 12 months in original unopened containers from date of packaging when stored above 68°F (20°C)
- 10.1 fl. oz. cartridges, 20.0 fl. oz. sausages and 4.5 gallon pails

MMDDYY-X Example: 100115-1

- 100115 = Date of Production
- 1 = Consecutive batch number on that date (October 1, 2015 would be the date of packaging)

3M™ Fire Barrier Water Tight Sealant 1003 SL and 3M™ Fire Barrier Water Tight Sealant 1000 NS

- Shelf life is 18 months in original unopened containers from date of packaging when stored between 40°F and 90°F (4°C and 32°C)
- 10.1 fl. oz. cartridges, 20.0 fl. oz. sausages and 4.5 gallon pails

MMDDYY-X Example: 100115-1

- 100115 = Date of Production
- 1 = Consecutive batch number on that date (October 1, 2015 would be the date of packaging)

3M™ Fire Barrier Rated Foam FIP 1-Step

- Shelf life is 16 months in original unopened containers from date of packaging when stored above 68°F (20°C) and below 90°F (32°C)
- 12.85 fl. oz. cartridges

YDDDXX Example: 5183AS

- 5 = Last digit of year manufactured
- 183 = Julian Date
- AS = Random characters to distinguish between lot numbers (July 2, 2015 would be the date of packaging)

3M™ Fire Barrier Silicone Sealant 2000+

- Shelf life of 18 months from date of packaging when stored below 90°F (32°C) in original unopened container
- 10.3 fl. oz. cartridges and 4.5 gallon pails

“Use by” date printed on each unit

3M Fire Protection Products

Shelf life and lot number interpretation is listed below and on the previous pages.

3M™ Fire and Water Barrier Tape FWBT and 3M™ Smoke and Sound Tape SST

- 3M™ Fire and Water Barrier Tape should be stored indoors in dry conditions in the original packaging.

To obtain best performance, use this product within 24 months from date of manufacture which can be determined from the lot number (found on the label inside of the cardboard core). The label format is as follows: Name of tape – Work order number – Lot number (e.g. FWBT – 123456 – 634501)

YDDDX **Example: 634501**

- 6 = Year of Manufacture
 - 345 = Julian Date of Manufacture
 - 01 = Julian Date of Manufacture (December 10, 2016 would be the date of manufacturing)
-

3M™ Aluminum Foil Tape 425

- Shelf life of 24 months from date of manufacturing when stored in original unopened container at 68°F (20°C)

MMM-YYDDD **Example: DWB-14154**

- DWB = Manufacturing Location
 - 14 = Year of Manufacture
 - 154 = Julian Date of Manufacture (June 3, 2014 would be the date of manufacturing)
-

3M™ Interam™ Stainless Steel Tape T-65

- Shelf life of 24 months from date of manufacturing when stored in original unopened container at 68°F (20°C)

These products use the P.O. number as the lot number

How to Use the UL Numbering System

Through Penetration Numbering System

For Through Penetration Firestopping, UL uses an alphanumeric system to categorize the type of construction along with the penetrating item(s).

By following the guidelines of the chart below, you can achieve a basic understanding of each system and its uses.

EXAMPLE – UL system C-AJ-1044 translates to:

C = Either floor or wall is penetrated

A = Concrete floors with a minimum thickness less than or equal to 5"

J = Concrete walls with a minimum thickness less than or equal to 8"

1044 = Metallic pipe, conduit or tubing as penetrating items.

The details vary within each system in a category such as, maximum pipe size, annular distances, products used, etc.

| | |
|-------------|---|
| F | Floor is penetrated |
| W | Wall is penetrated |
| C | Either wall or floor |
| A | Concrete floors with a min. thickness of less than or equal to 5" |
| B | Concrete floors with a min. thickness greater than 5" |
| C | Framed floor |
| D | Steel deck in marine vessels |
| E | Floor ceiling assemblies consisting of concrete with membrane protection |
| F-I | Not currently used |
| J | Concrete or masonry wall with a min. thickness less than or equal to 8" |
| K | Concrete or masonry wall with a min. thickness greater than 8" |
| L | Framed walls |
| M | Bulkheads in marine vessels |
| N | Composite panel walls |
| O-Z | Not currently used |
| 0000 | No penetrating items |
| 1000 | Metallic pipe, conduit, or tubing |
| 2000 | Non-metallic pipe, conduit, or tubing |
| 3000 | Electrical cables |
| 4000 | Cable trays with electrical cables |
| 5000 | Insulated pipes |
| 6000 | Misc. electrical penetrants such as bus ducts |
| 7000 | Misc. mechanical penetrants such as air ducts |
| 8000 | Groupings of penetrations including any combination of items listed above |
| 9000 | Not currently used |

3M Fire Protection Products

Joint Numbering System

The systems are identified in this category by an Alpha-Numeric identification system. The alpha components identify the type of joint system and whether the joint system has movement capabilities.

The numeric components identify the nominal joint width. In the case of head of wall joint systems, the width of the joint does not include the voids created under the crests of metal deck floor or roof systems.

The first two alpha characters identify the type of joint system as follows:

The third alpha character is either S or D. The S signifies joint systems which do not have movement capabilities. The D signifies joint systems which do have movement capabilities.

The numeric component uses sequential numbers to identify the nominal width of the joint systems. The significance of the number used is:

| Alpha Characters | Description of Joint System |
|------------------|---|
| FF | Floor-to-Floor |
| WW | Wall-to-Wall |
| FW | Floor-to-Wall |
| HW | Head-of-Wall |
| BW | Bottom-of-Wall |
| CG | Wall-to-Wall Joints Intended for use as Corner Guards |
| CW | Curtain-Wall |

| Number Range | Nom Joint Width |
|--------------|--|
| 0000 - 0999 | Less than or equal to 2 in. |
| 1000 - 1999 | Greater than 2 in. and less than or equal to 6 in. |
| 2000 - 2999 | Greater than 6 in. and less than or equal to 12 in. |
| 3000 - 3999 | Greater than 12 in. and less than or equal to 24 in. |
| 4000 - 4999 | Greater than 24 in. |

Note: Systems from Warnock Hersey and Intertek/Omega Point Laboratories use a different numbering system.

Underwriters Laboratories Inc. Explanation Through Penetration Firestop Systems (XHEZ)

This category covers firestop systems, which are specific constructions consisting of a wall or floor assembly, a penetrating item passing through an opening in the wall or floor assembly, and the materials designed to prevent the spread of fire through the openings. The specifications for materials in a firestop system and the assembly of the materials are details that directly relate to the established ratings. Information concerning these details is described in the individual systems. The hourly ratings apply only to the complete systems. Individual components are designated for use in a specific system to achieve specified ratings. The individual components are not assigned ratings and are not intended to be interchanged between systems. Additionally, the substitution or elimination of components required in a system should not be made unless specifically permitted in the individual system or in these general guidelines.

The firestop systems covered under this category have been investigated with a positive furnace pressure differential of at least 0.01 in. of water maintained at a distance of 12 in. below horizontal test assemblies and 0.78 in. below the fill materials surrounding the penetrating items passing through vertical test assemblies. The Classifications of firestop systems contemplate installation in heated and air conditioned environments unless stated otherwise in the description of the system.

ANSI/UL 1479, "Fire Tests of Through-Penetration Firestops," defines the criteria for hourly F, T, L and W ratings for firestop systems. The F-rating criteria prohibits flame passage through the system and requires acceptable hose-stream test performance. The T-rating criteria prohibits flame passage through the system and requires the maximum temperature rise on the unexposed surface of the wall or floor assembly, on the penetrating item and on the fill material not to exceed 325°F (181°C) above ambient, and requires acceptable hose-stream test performance.

The L-rating criteria determines the amount of air leakage, in cu feet per minute per square foot of opening (CFM/sq ft) or in cu feet per minute per unit (CFM/unit) for fixed-size opening units, through the firestop system at ambient and/or 400°F air temperatures at an air-pressure differential of 0.30 in. W.C. The L ratings are intended to assist Authorities Having Jurisdiction and others in determining the suitability of firestop systems for the protection of penetrations and miscellaneous openings in floors and smoke barriers for the purpose of restricting the movement of smoke in accordance with ANSI/NFPA 101, "Life Safety Code."

The Class 1 W rating determines the capability of the firestop system to maintain watertightness of the penetration through a floor or wall construction at ambient air conditions under 3 ft of water pressure head (1.3 psi) for a period of 72 hours. The W rating may be applicable for building structures whose floors are subjected to incidental standing water and/or for buildings that house critical equipment as described in ANSI/NFPA 75, "Protection of Information Technology Equipment," and ANSI/NFPA 76, "Fire Protection of Telecommunications Facilities."

Acceptance is based upon the ability of the firestop system to withstand the applied pressure without the passage of any water through the firestop system. After the Class 1 watertightness test, the firestop system is conditioned in accordance with the requirements of ANSI/UL 1479 and the fire and hose stream tests described in the standard are conducted.

The W rating is intended to assist Authorities Having Jurisdiction and others in determining the suitability of firestop systems in applications where submersion in water may be a factor.

Materials used in the firestop systems are intended to be installed in accordance with the manufacturer's instructions provided with the materials. The structural integrity of the floor or wall assembly needs to be investigated when providing openings for the penetrating items. The fill, void or cavity material thickness published in the fire-resistance designs is measured wet and may be susceptible to a percentage of shrinkage during the curing process. Firestop systems are investigated after the fill, void or cavity materials are fully cured. Refer to the individual Classifications under Fill, Void or Cavity Materials (XHHW) for the investigated percentage of shrinkage.

The minimum and/or maximum annular space referenced in the firestop system must be maintained in order to achieve the hourly rating of the system. The annular space of a penetrating item through a rectangular opening is determined by measuring the distance from the closest point of the penetrating item to a point perpendicular to each of the four sides of the opening. The diagonal dimension is not intended to represent the annular space of a rectangular opening. The annular space between multiple penetrating items within a rectangular opening is determined by measuring the closest point of one penetrating item to the closest point of the adjacent penetrating item.

Underwriters Laboratories Inc. Explanation

Through Penetration Firestop Systems (XHEZ) – continued

ANSI/NFPA 90A, “Installation of Air-Conditioning and Ventilating Systems,” contains requirements on the use of fire dampers in conjunction with ventilation ducts. Unless specifically indicated as part of the Classification of the damper, the annular space around the damper sleeve should not be firestopped with the materials described herein.

The systems covered under this category are Classified with respect to (1) installation in a wall only, (2) installation in a floor only or (3) installation in either a wall or a floor. Unless otherwise indicated in the systems, the ratings for firestop systems installed in walls apply when either face of the wall is exposed to fire. The ratings for firestop systems installed in a floor apply when the underside or ceiling surface is exposed to fire.

The hourly fire-endurance rating of the walls and floors incorporating these systems are not indicated. Volume 1 of the Fire Resistance Directory covers the hourly fire-endurance ratings of floor and wall assemblies. Firestop systems that specify installation in concrete floors may include installation in floors consisting of fluted or corrugated steel deck topped with structural concrete, provided that (1) the concrete topping thickness measured above the top plane of the steel deck is equal to or greater than the minimum concrete thickness specified in the system, and (2) the firestop system does not require any portion of the forming material or fill material to extend below the bottom plane of the floor.

Some firestop systems specify the use of hollow-core precast concrete unit floor assemblies. Where not specified, firestop systems utilizing caulk, sealant, putty or spray materials installed over a mineral wool or ceramic blanket may be installed in hollow-core floors, provided that (1) the thickness of the hollow-core floor is equal to or greater than the minimum concrete thickness specified in the system, (2) the maximum size of the opening is 7 in. diameter or 7 in. by 7 in., and (3) any cores of the precast concrete units penetrated as a result of the firestop system are sealed with a minimum 4 in. depth of either firmly packed minimum 4 pcf mineral wool or ceramic fiber blanket, or concrete, grout or mortar. Additionally, firestop systems utilizing a firestop device or wrap strips/steel collar installed around the penetrant beneath the floor may be installed in hollow-core floors, provided that (1) the thickness of the hollow-core floor is equal to or greater than the minimum concrete thickness specified in the system, and (2) the maximum size of the opening is 7 in. diameter or 7 in. by 7 in.

ANSI/NFPA 70, “National Electrical Code” (NEC), contains requirements for permissible installation and percentages of electrical conductor fill for conduit, cable trays and other electrical conductor raceways.

Authorities Having Jurisdiction should be consulted as to the particular requirements covering the installation and use of these Classified systems.

Penetrating Items

When the penetrating item is indicated as being conduit, the conduit is intended for use as a raceway for electrical conductors in accordance with the NEC. Electrical conductors may be used without conduit only when permitted by and installed in accordance with the NEC, and when the conductors are specifically described in the firestop system. The maximum conductor size and the maximum number of conductors in the individual cables are specified in each system. All electrical conductors are intended to be copper unless indicated otherwise in the system.

When the penetrating item is indicated as being pipe, the pipe is intended for the transport of gases, liquids and the like. The maximum diameter, the minimum wall thickness and the specific material for conduit and pipes are specified in each system. All nonmetallic pipe is intended to be of the solid-core type unless indicated otherwise in the system.

Further specifications for the various types of penetrating items may be found in the documents referenced below:

Underwriters Laboratories Inc. Explanation

Through Penetration Firestop Systems (XHEZ) – continued

| Penetrating Item | Document |
|--|-------------------------------------|
| Electrical metallic tubing (EMT) | ANSI/UL 797 |
| Intermediate metal conduit (IMC) | ANSI/UL 1242 |
| Rigid metal conduit | ANSI/UL 6 |
| Copper tubing | ASTM B88 |
| Copper pipe | ASTM B42 |
| Flexible metal conduit | ANSI/UL 1 |
| Liquid-tight flexible nonmetallic conduit | ANSI/UL 1660 |
| Rigid nonmetallic PVC conduit | ANSI/UL 651 |
| Electrical nonmetallic tubing (ENT) | ANSI/UL 1653 |
| Cross-linked polyethylene (PEX) tubing | ANSI/ASTM D2737 |
| Solid-core polyvinyl chloride (PVC) pipe | ANSI/ASTM D1785 and ANSI/ASTM D2665 |
| Cellular-core polyvinyl chloride (PVC) pipe | ANSI/ASTM F891 |
| Chlorinated polyvinyl chloride (CPVC) pipe | ANSI/ASTM F442 |
| Solid-core acrylonitrile butadiene styrene (ABS) pipe | ANSI/ASTM D1527 and ANSI/ASTM D2661 |
| Cellular-core acrylonitrile butadiene styrene (ABS) pipe | ANSI/ASTM F628 |
| Polybutylene (PB) pipe | ASTM D3000 |
| Polyvinylidene fluoride (PVDF) pipe | ANSI/ASTM F1673 |
| Fiberglass pipe | ANSI/ASTM D2997 |

Where the individual system specifies the penetrating item is to be rigidly supported on both sides of wall or floor, the support system should be designed based upon the premise the firestop system provides no support.

Where the penetrating item is indicated as a metallic pipe, conduit, tube, duct or cable, and the firestop system consists of a fill material (such as sealants, putty or mortar) and a packing material, the penetrant may pass through the opening in the wall or floor assembly at an angle, provided the annular space is maintained on both sides of the wall or floor assembly. In all other cases, except where otherwise indicated in the system, the penetrating item should penetrate the wall or floor assembly at a 90° angle.

Some systems do not include penetrating items. These firestop systems are intended to be used to seal openings where the penetrating items have been removed or where the penetrating items have not yet been installed.

Forming Materials

Forming materials specified for a firestop system should not be removed after cure of the fill material, unless removal is specified in the description of the system.

The installation contractor and Authority Having Jurisdiction should ensure the specified properties of the packing and/or forming material are satisfied as noted in the individual Classifications. Such properties may include material type (mineral wool, backer rod, fiberglass, etc.), physical properties (size, density, etc.) and installation (depth, orientation, compression, etc.). Attention should also be given to ensure the installed material matches the manufacturer (where applicable) in the individual Classifications. The material and attributes are critical to the performance of the system and the ability of such system to satisfy the conditions of acceptance in ANSI/UL 1479 and the local building code. The fire-resistance rating of the system is dependent upon the use and installation of the materials specified within the respective system.

Fill Materials

When more than one fill, void or cavity material is specified under a single item number within a firestop system, it is intended that any single one of the materials may be used.

Conductor Ampacity

Where indicated in the system, the ampacity reduction due to the firestop system has been determined in accordance with UL Subject 1712, “Outline of Investigation for Tests for Ampacity of Insulated Electrical Conductors Installed in Fire Protective Systems.” If not specified in the individual system, the effect of the firestop system on the ampacity of electrical conductors has not been investigated.

Numbering System

The systems are identified in this category by an alpha-numeric identification system. The alpha components identify the type of assembly being penetrated and the numeric component identifies the type of penetrating item.

The first alpha component is an F, W or C. The F signifies a floor is being penetrated, the W signifies a wall is being penetrated, and C signifies either a floor or a wall is being penetrated.

3M Fire Protection Products

Underwriters Laboratories Inc. Explanation

Through Penetration Firestop Systems (XHEZ) – continued

The second alpha component may be any letter. The significance of the letter used is:

| Letter | Description |
|--------|--|
| A | Concrete floors with a minimum thickness less than or equal to 5 in. |
| B | Concrete floors with a minimum thickness greater than 5 in. |
| C | Framed floors |
| D | Steel decks in marine vessels |
| E | Floor-ceiling assemblies consisting of concrete with membrane protection |
| F - I | Not used at present time |
| J | Concrete or masonry walls with a minimum thickness less than or equal to 8 in. |
| K | Concrete or masonry walls with a minimum thickness greater than 8 in. |
| L | Framed walls |
| M | Bulkheads in marine vessels |
| N | Composite panel walls |
| O - Z | Not used at present time |

The numeric component uses sequential numbers to identify the penetrating item. The significance of the number used is:

| No. Range | Description |
|-----------|--|
| 0000-0999 | No penetrating items |
| 1000-1999 | Metallic pipe, conduit or tubing |
| 2000-2999 | Nonmetallic pipe, conduit or tubing |
| 3000-3999 | Electrical cable |
| 4000-4999 | Cable trays with electrical cable |
| 5000-5999 | Insulated pipe |
| 6000-6999 | Miscellaneous electrical penetrants, such as busducts |
| 7000-7999 | Miscellaneous mechanical penetrants, such as air ducts |
| 8000-8999 | Groupings of penetrations, including any combination of items listed above |
| 9000-9999 | Not used at present time |

Additional Information

For additional information, see Fire Resistance Ratings (BXRH).

Requirements

The basic standard used to investigate products in this category is ANSI/UL 1479 (ASTM E814 [2002]), "Fire Tests of Through-Penetration Firestops."

Where indicated in the individual Classifications under Joint Systems (XHBN) and Fill, Void or Cavity Materials (XHHW), fill, void or cavity materials have also been investigated to ASTM C1241 (2000), "Standard Test Method for Volume Shrinkage of Latex Sealants During Cure."

UL Mark

Those materials identified by an (*) in the system description text are eligible to be produced under the Follow-Up Service Program of UL. The Classification Mark of UL on the product is the Only method provided by UL to identify products manufactured under its Classification and Follow-Up Service.

UL, in performing its functions in accordance with its objectives, does not assume or undertake to discharge any responsibility of the manufacturer or any other party. UL shall not incur any obligation or liability for any loss, expense or damages, including incidental or consequential damages, arising out of or in connection with the use, interpretation of, or reliance upon this Guide Information

Underwriters Laboratories Inc. Explanation Joint Systems (XHBN)

This category covers joint systems, which are specific constructions consisting of adjacent wall and/or floor assemblies and the materials designed to prevent the spread of fire through a linear opening between the wall and/or floor assemblies. The specifications for materials in a joint system and the assembly of the materials are details that directly relate to the established ratings. Information concerning these details is described in the individual systems. The hourly ratings apply only to the complete systems. Individual components are designated for use in a specific system to achieve specified ratings. The individual components are not assigned ratings and are not intended to be interchanged between systems. Additionally, the substitution or elimination of components required in a system should not be made unless specifically permitted in the individual system or in these general guidelines.

The Classification of joint systems contemplate installation in heated and air-conditioned environments unless stated otherwise in the description of the system.

Materials used in the joint systems are intended to be installed in accordance with the manufacturer's instructions provided with the material. The structural integrity of the floor or wall assembly has not been investigated as a result of the openings.

When the joint system specifies the insulation material is to be compressed prior to installation into the joint, the uncompressed thickness necessary can be calculated as follows:

$$T_{\text{uncomp}} = (W_{\text{nom}} \times 100) / (100 - I_{\text{comp}})$$

Where:

- T_{uncomp} = Uncompressed Thickness Necessary, In.
- I_{comp} = Insulation Compression Percentage Specified in System, X%
- W_{nom} = Nominal (Installed) Joint Width, In.

Unless otherwise indicated in the systems, the ratings for joint systems installed in walls apply when either face of the wall is exposed to fire. The ratings for joint systems installed in a floor apply when the underside or ceiling surface is exposed to fire.

The hourly fire-resistance ratings of the floor and wall assemblies in which, or between which, the joint system is intended to be installed are covered under Fire Resistance Ratings (BXUV). Where the individual joint system

references back to fire-resistance designs, all construction details of the individual design are intended to be followed. In addition, all details relative to the construction of the wall or floor assembly contained in the individual joint system are intended to be followed. Where the construction details shown in the fire-resistance design and the joint system differ, such as in stud size and spacing, fastener spacing, etc., the most restrictive construction details prevail.

Floor-to-floor and floor-to-wall joint systems that specify installation in concrete floors may include installation in floors consisting of fluted or corrugated steel deck topped with structural concrete, provided that (1) the concrete topping thickness measured above the top plane of the steel deck is equal to or greater than the minimum concrete thickness specified in the joint system, and (2) the joint system does not require any portion of the forming material or fill material to extend below the bottom plane of the floor.

The installation contractor and Authority Having Jurisdiction should ensure the specified properties of the packing and/or forming material are satisfied as noted in the individual Classifications. Such properties may include material type (mineral wool, backer rod, fiberglass, etc.), physical properties (size, density, etc.) and installation (depth, orientation, compression, etc.). Attention should also be given to ensure the installed material matches the manufacturer (where applicable) in the individual Classifications. The material and attributes are critical to the performance of the system and the ability of such system to satisfy the conditions of acceptance in ANSI/UL 1479 and the local building code. The fire-resistance rating of the system is dependent upon the use and installation of the materials specified within the respective system.

The joint sealant material thickness published in the fire-resistance designs is measured wet (unless otherwise specified in the individual systems) and may be susceptible to a percentage of shrinkage during the curing process. Joint systems are investigated after the sealant materials are fully cured. Refer to the individual Classifications for the investigated percentage of shrinkage.

Authorities Having Jurisdiction should be consulted as to the particular requirements covering the installation and use of these Classified systems.

3M Fire Protection Products

Underwriters Laboratories Inc. Explanation Joint Systems (XHBN) – continued

Numbering System

The systems are identified by an alphanumeric identification system. The alpha components identify the type of joint system and whether the joint system has movement capabilities. The numeric components identify the nominal joint width. In the case of head-of-wall joint systems, the width of the joint does not include the voids created under the crests of metal deck floor or roof systems.

The first two alpha characters identify the type of joint system as follows:

| Alpha Characters | Description of Joint System |
|------------------|---|
| FF | Floor-to-floor |
| WW | Wall-to-wall |
| FW | Floor-to-wall |
| HW | Head-of-wall |
| BW | Bottom-of-wall |
| CG | Wall-to-wall joints intended for use as corner guards |

The third alpha character is either S or D. The S signifies joint systems that do not have movement capabilities. This D signifies joint systems that do have movement capabilities. The numeric component uses sequential numbers to identify the nominal width of the joint systems. The significance of the number used is:

| Number. Range | Nom Joint Width |
|---------------|--|
| 0000 - 0999 | Less than or equal to 2 in. |
| 1000 - 1999 | Greater than 2 in. and less than or equal to 6 in. |
| 2000 - 2999 | Greater than 6 in. and less than or equal to 12 in. |
| 3000 - 3999 | Greater than 12 in. and less than or equal to 24 in. |
| 4000 - 4999 | Greater than 24 in. |

Additional Information

For additional information, see Fire Resistance Ratings (BXRH).

Requirements

The basic standard used to investigate products in this category is ANSI/UL 2079, "Tests for Fire Resistance of Building Joint Systems."

ANSI/UL 2079 defines four types of joint systems: floor-to-floor, wall-to-wall, floor-to-wall and head-of-wall. In addition, bottom-of-wall joint systems have been investigated using the general methods and conditions of acceptance specified for the four defined types of joint systems.

All joint systems covered under this category have been investigated with a minimum positive furnace pressure differential of 0.01 in. of water maintained at a distance of 12 in. below horizontal test assemblies and at the mid-height of vertical test assemblies.

ANSI/UL 2079 requires joint systems with movement capabilities to be cycled through the intended range of movement prior to the fire test. The movement cycling is intended to demonstrate the compatibility between the individual components of the joint system and the fire resistive assembly. Joint systems are required to be cycled through the intended movement range 500 or 100 complete movement cycles at a minimum rate of 1, 10 or 30 cycles per minute prior to the fire test.

Joint systems with movement capabilities are noted through the appearance of a Class I, II and/or III designation included as part of the heading information. The definitions of the movement class designations are as follows:

| Movement Class | Min No. of Cycles | Min Cycling Rate (Cycles Per Min) |
|----------------|-------------------|-----------------------------------|
| Class I | 500 | 1 |
| Class II | 500 | 10 |
| Class III | 100 | 30 |

3M Fire Protection Products

Underwriters Laboratories Inc. Explanation Joint Systems (XHBN) – continued

Each joint system with movement capabilities specifies a nominal joint width and the movement capabilities, expressed in either a numerical value or as a percent of the nominal joint width. When the compression or extension movement capabilities are expressed as a percent, the minimum and maximum joint widths that the joint system can accommodate are calculated as follows:

$$w_{\min} = W_{\text{nom}}[1 - (\% \text{ Comp} / 100)]$$

Where:

w_{\min} = Minimum Joint Width, In.

w_{nom} = Nominal Joint Width, In.

% Comp = Movement Capability in Compression Direction, Percent and

w_{\max} = $W_{\text{nom}}[1 + (\% \text{ Est} / 100)]$

Where:

w_{\max} = Maximum Joint Width, In.

w_{nom} = Nominal Joint Width, In.

% Ext = Movement Capability in Extension Direction, X%

When the shear movement capabilities are expressed as a percent, the shear movement capabilities in inches that the joint system can accommodate are calculated as follows:

$$\text{Shear} = W_{\text{nom}} (\% \text{ Shear} / 100)]$$

Where:

Shear = Shear Movement, In.

w_{nom} = Nominal Joint Width, In.

% Shear = Shear Movement, X%

All joint systems have been tested at their maximum joint width and maximum shear capabilities.

Joint systems intended to be load bearing are investigated with respect to the ability to carry the load during the fire test. The load-carrying capacity of such joints is noted in the individual joint system.

The conditions of acceptance in ANSI/UL 2079 provide criteria for an assembly rating with an optional L rating and/or W rating. The L-rating criteria determines the amount of air leakage, in cubic feet per minute per linear foot of joint opening (CFM/LIN Ft), through the joint system at ambient and/or 400°F air temperature at an air pressure differential of 0.30 in. W.C. The L ratings are intended to assist

Authorities Having Jurisdiction, and others, in determining the suitability of joint systems for the protection of openings in floors and smoke barriers for the purpose of restricting the movement of smoke in accordance with ANSI/NFPA 101, "Life Safety Code."

The W rating, identified as Class 1, determines the capability of the joint system to maintain watertightness at ambient air conditions under 3 ft of water pressure head (1.3 psi) for a period of 72 hours. The W rating may be applicable for building structures whose floors are subjected to incidental standing water and/or for buildings that house critical equipment as described in ANSI/NFPA 75, "Protection of Information Technology Equipment," and ANSI/NFPA 76, "Fire Protection of Telecommunications Facilities."

The surface flammability and smoke development characteristics of Classified materials used in joint systems are measured by the test method in ANSI/UL 723 (ASTM E84 and NFPA 255), "Test for Surface Burning Characteristics of Building Materials." The flame spread index of these materials is less than 200 and the smoke developed index is less than 450. Surface burning characteristics Classifications are covered under Surface Burning Characteristics (BIKT).

Where indicated in the individual Classifications, joint sealant materials have also been investigated to ASTM C1241 (2000), "Standard Test Method for Volume Shrinkage of Latex Sealants During Cure."

UL Mark

Those materials identified by an (*) in the system description text are eligible to be produced under the Follow-Up Service Program of UL. The Classification Mark of UL on the product is the Only method provided by UL to identify products manufactured under its Classification and Follow-Up Service.

UL, in performing its functions in accordance with its objectives, does not assume or undertake to discharge any responsibility of the manufacturer or any other party. UL shall not incur any obligation or liability for any loss, expense or damages, including incidental or consequential damages, arising out of or in connection with the use, interpretation of, or reliance upon this Guide Information.

Underwriters Laboratories Inc. Explanation Perimeter Fire Containment Systems (XHDG)

Use and Installation

This category covers perimeter fire-containment systems, which are specific constructions consisting of a floor with an hourly fire-endurance rating, an exterior curtain wall with no hourly fire-endurance rating, and material installed to fill gaps between the floor and the curtain wall to prevent the vertical spread of fire in a building. The hourly ratings apply only to the complete systems. The individual components are not assigned ratings and are not intended to be interchanged between systems.

The specifications for materials in a perimeter fire-containment system and the assembly of the materials are details that directly relate to the established ratings. Information concerning these details is described in the individual systems. Materials used in these perimeter fire-containment systems are intended to be installed in accordance with the manufacturer's instructions provided with the material. The substitution or elimination of components required in a system should not be made unless specifically permitted in the individual system or in these general guidelines.

All perimeter fire-containment systems have been tested with the curtain wall at the maximum clearance distance from the floor.

Curtain wall spandrel panel dead-load anchors located below the concrete floor should be protected from direct fire exposure. When lateral anchors or braces are required to be used with the curtain wall spandrel panels, the lateral anchors or braces located beneath the concrete floor should also be protected from direct fire exposure. The protection for the anchors and braces may consist of a fire-resistive ceiling membrane, spray-applied fire-resistive material, or other protective material with known hourly fire-resistive properties.

The Classification of perimeter fire-containment systems contemplate installation in heated and air-conditioned environments unless stated otherwise in the description of the system.

Authorities Having Jurisdiction should be consulted as to the particular requirements covering the installation and use of these Classified systems.

Ratings

Ratings for some perimeter fire-containment systems may also include an Integrity Rating, an Insulation Rating and a Leakage Rating. These perimeter fire-containment systems were tested in compliance with ANSI/ASTM E2307, "Standard Test Method for Determining Fire Resistance of Perimeter Fire Barriers Using Intermediate-Scale, Multi-story Test Apparatus," but the required minimum pressure of 0.01 in. of water was maintained 12 in. below the floor, as compared to the lowest point of the perimeter joint as specified in ANSI/ASTM E2307. This practice ensures a higher level of positive pressure beneath the lowest point of the perimeter joint and this exceeds the minimum requirement specified in ANSI/ASTM E2307.

The criteria for the Integrity Rating complies with the requirements for the "F Rating" of ANSI/ASTM E2307, but also limits the passage of flame through openings in the curtain wall above the perimeter fire-barrier system.

The criteria for the Insulation Rating complies with the "T Rating" of ANSI/ASTM E2307, but also limits the temperature rise to 325°F above the starting temperature on the interior surface of the curtain wall.

The criteria for the Leakage Rating ("L Rating") is a measure of the amount of air leakage, in cubic feet per minute per linear foot, through the perimeter fire-containment system at ambient and/or 400°F air temperature at an air pressure differential of 0.30 in. of water. The "L Rating" is intended to assist Authorities Having Jurisdiction and others in determining the suitability of perimeter fire-containment systems for restricting the movement of smoke in accordance with ANSI/NFPA 101, "Life Safety Code."

Numbering System

The systems are identified in this category by an alpha-numeric identification system. The first two alpha characters, CW, identify the perimeter fire-containment system as being for use at the interface of a fire-rated floor and a nonfire-rated exterior curtain wall. The third alpha character is either S or D. The S signifies perimeter fire-containment systems that do not have movement capabilities (i.e., Static). The D signifies fire-containment systems that do have movement capabilities (i.e., Dynamic). The numeric component uses sequential numbers to identify the maximum clearance distance between the curtain wall and the perimeter of the floor. The significance of the number used is:

Reprinted from the Online Certifications Directory with permission from Underwriters Laboratories Inc.
Copyright © 2010 Underwriters Laboratories Inc. Last modified 1-10-2012.

3M Fire Protection Products

Underwriters Laboratories Inc. Explanation Perimeter Fire Containment Systems (XHDG) – continued

| No. Range | Max Clearance Distance Between Curtain Wall & Perimeter Of Floor |
|-------------|--|
| 0000 - 0999 | Less than or equal to 2 in. |
| 1000 - 1999 | Greater than 2 in. and less than or equal to 6 in. |
| 2000 - 2999 | Greater than 6 in. and less than or equal to 12 in. |

Additional Information

For additional information, see Fire Resistance Ratings (BXRH).

Requirements

The basic standard used to investigate the systems in this category is ANSI/ASTM E2307-04, "Standard Test Method for Determining Fire Resistance of Perimeter Fire Barriers Using Intermediate-Scale, Multi-story Test Apparatus."

Two hourly ratings are defined for each perimeter fire-containment system: the "T Rating" and the "F Rating." The "T Rating" is a measure of the ability of the perimeter fire-containment system to limit the temperature rise on the unexposed surface of the perimeter fire-containment system and the adjacent supporting construction as defined in ANSI/ASTM E2307. The "F Rating" is a measure of the perimeter fire-containment system to limit flame penetration through the system or around its boundaries and the passage of flames and hot gases sufficient to ignite cotton waste as defined in ANSI/ASTM E2307.

The test method requires joint systems with movement capabilities to be cycled through the intended range of movement prior to the fire test. The movement cycling is intended to demonstrate the compatibility between the individual components of the joint system and the supporting construction. Joint systems are required to be cycled through the intended movement range 500 or 100 complete movement cycles at a minimum rate of 1, 10 or 30 cycles per minute prior to the fire test. Perimeter fire-containment systems with movement capabilities are noted through the appearance of a Class I, II and/or III designation included as part of the heading information. The definitions of the movement class designations are as follows:

| Movement Class | Min No. of Cycles | Min Cycling Rate (Cycles Per Min) |
|----------------|-------------------|-----------------------------------|
| Class I | 500 | 1 |
| Class II | 500 | 10 |
| Class III | 100 | 30 |

Each perimeter fire-containment system with movement capabilities specifies a nominal opening width and the movement capabilities, expressed in either a numerical value or as a percent of the nominal opening width. When the shear movement capabilities are expressed as a percent, the shear movement capabilities in inches which the joint system can accommodate can be calculated as follows:

$$\text{Shear} = w_{\text{nom}}(\% \text{ Shear} / 100)]$$

Where:

- Shear = Shear Movement, In.
- w_{nom} = Nominal Opening Width, In.
- % Shear = Shear Movement, Percent

UI Follow-Up Service

Those materials identified by an (*) in the system description text are eligible to be produced under UL's Follow-Up Service Program.

UL, in performing its functions in accordance with its objectives, does not assume or undertake to discharge any responsibility of the manufacturer or any other party. UL shall not incur any obligation or liability for any loss, expense or damages, including incidental or consequential damages, arising out of or in connection with the use, interpretation of, or reliance upon this Guide Information.

3M Fire Protection Products

Underwriters Laboratories Inc. Explanation

Electrical Circuit Protective Systems – Flexible Wraps (FHIT)

General

This category covers electrical circuit protective systems consisting of components and materials intended for installation as protection for specific electrical wiring systems, with respect to the disruption of electrical circuit integrity upon exterior fire exposure.

Ratings apply only to the entire protective system assembly, constructed using the combination of components and materials specified in the individual system. Components and materials are designated for use in a specific individual system for which corresponding ratings have been developed, and are not intended to be interchanged between systems. Ratings are not assigned to individual system components or materials. For example, caulk or putty used from one system cannot be interchanged with the caulk or putty specified in another system.

Electrical circuit protective systems are intended to be fastened to a concrete or masonry wall or a concrete floor-ceiling assembly. The fire rating of the wall or floor-ceiling assembly is intended to be equal to or greater than the rating of the electrical circuit protective system. This is to ensure that the complete electrical circuit protective system will survive during fire and hose stream exposure.

Systems Incorporating Cable Protected with Electrical Circuit Protective Materials

These protective systems are investigated with respect to fire exposure and water hose stream performance. Performance criteria are based on temperatures within the enclosure and visual examination after the water hose stream.

These protective systems are intended to be installed in interior environments with representative heating and air conditioning, unless stated otherwise in the individual system. Where indicated in the system, the ampacity reduction due to the electrical circuit protection system has been determined for normal ambient temperature operating conditions in accordance with IEEE 848-1996, "IEEE Standard Procedure for the Determination of the Ampacity Derating of Fire-Protected Cables." If not specified in the system, the effect of the electrical circuit protection system on the ampacity of the electrical conductors has not been investigated. The specifications for the protective system and its assembly are important details in the development of the ratings. Information concerning these details is described in each system.

The products used in these systems are intended to be installed in accordance with the applicable accompanying instructions.

Systems Constructed with Fire-Resistive Cable

These protective systems are investigated with respect to fire exposure and water hose stream performance. Performance criteria are based on functionality of the cable during the fire and after the water hose stream. ANSI/UL 2196, "Tests for Fire Resistive Cables," describes two fire exposure conditions. The normal temperature rise (to ANSI/UL 263, "Fire Tests of Building Construction and Materials") is intended to represent a fully developed interior building fire. The rapid temperature rise (to ANSI/UL 1709, "Rapid Rise Fire Tests of Protection Materials for Structural Steel") is intended to represent a hydrocarbon pool fire. If not stated otherwise in the individual system, the normal temperature rise exposure was used. There are two hose stream levels: low impact and normal impact. The low-impact fog nozzle hose stream is applied only to cable marked with the "-CI" suffix. The normal-impact hose stream, applied with a standard-taper, smooth-bore playpipe, is applied to all other types of cable.

CI cable is tested on steel rings to simulate installation in free air. If CI cable is intended to be installed in a raceway it is so tested. CI cable that has been tested in a raceway will be specified in the system.

Each design of fire-resistive cable is tested per ANSI/UL 2196. One-conductor and multi-conductor constructions are tested separately, as well as shielded or unshielded, and stranded or solid conductors. The system contains the construction details of the tested configuration. The minimum conductor size, minimum number of conductors, UL Type, voltage rating, etc., are construction details that are also provided. Cable is UL Listed to a National Electrical Code Type and constructed to a UL Standard for the cable (such as Type MC per ANSI/UL 1569, "Metal-Clad Cables"; Type RHH/RHW to ANSI/UL 44, "Thermoset-Insulated Wires and Cables"; Type FPL per ANSI/UL 1424, "Cables for Power-Limited Fire-Alarm Circuits"; Type NPLF per ANSI/UL 1425, "Cables for Non-Power-Limited Fire-Alarm Circuits"; and Type TC per ANSI/UL 1277, "Electrical Power and Control Tray Cables with Optional Optical-Fiber Members").

Cable is tested as a complete system. The system includes the cable and/ or raceway support, couplings, boxes/ conduit bodies, optional splices, vertical supports, grounds, pulling lubricants, cable tray, etc. Cable or raceway supports

3M Fire Protection Products

Underwriters Laboratories Inc. Explanation

Electrical Circuit Protective Systems – Flexible Wraps (FHIT) – continued

need to hold the cable in place during the fire and hose stream. The hardware, clamps, strut, etc., are generally stated to be made of steel.

Systems that require a raceway are tested with the minimum raceway diameter and the minimum raceway type with their respective coupling(s). Raceways having larger diameters are acceptable. Raceways with greater wall thickness are also acceptable. Intermediate metal conduit (IMC) or rigid metal conduit (RMC) are acceptable for use in systems where electrical metallic tubing (EMT) is specified.

The raceway is intended to be connected together using the coupling type referenced in the system, such as steel setscrew type for EMT or threaded types of coupling for IMC and RMC. No other couplings are intended to be used unless noted in the specific system. For example, a compression coupling is not intended to be used in place of a steel setscrew coupling for EMT unless otherwise specified in the system. If IMC or RMC is substituted where EMT is specified, the raceway should be connected together with threaded types of couplings.

If a box, conduit body, supports (such as a grip), splice or other components are tested, it is noted in the system. Otherwise, the hourly fire rating applies only to continuous lengths of cable and/or raceway with couplings passing completely through a fire zone and terminating a minimum of 12 inches beyond the fire-rated wall or floor bounding the fire zone. For systems installed in a raceway, ANSI/NFPA 70, "National Electrical Code" (NEC), requires not more than 360 degrees of bends without a pull point (such as conduit bodies or boxes). Therefore, for most practical installations, a conduit body or a box will be required. Items such as conduit bodies and boxes, if found acceptable, are described in the system. Since boxes are tested with a single raceway, each individual raceway should have an independent box used for pull points or splices. If a splice is tested, it is also described in the system. Boxes should be sized per the method described in the NEC.

The supports are an important part of the systems and each individual system has specific support requirements. The maximum distance between the supports is described in the individual systems and are not intended to be exceeded even if an alternate raceway is used. For example, if 5-foot spacing between supports is specified for EMT, this same support distance should be used with any other raceway (IMC, RMC, etc.), unless stated otherwise in the system or a lesser support spacing is specified in the NEC. The type of support and the distance between the steel supports is unique to that specific system and is for all sizes/types of cable and/or conduit/

raceway unless otherwise noted in a specific system. Spacing of the tray support should also be the same as the raceway support spacing unless otherwise noted.

The support requirements are for both the horizontal and vertical configuration unless otherwise noted in a specific system. The supports for both the vertical or horizontal configuration are intended to be the support to the cable/conductor. Cable installed in a vertical raceway is not supported by the raceway. This is in contrast to MI or MC cable, where a support on the outside of the cable also supports the conductors. The ability of cable to support the equivalent cable weight of the maximum distance between cable supports without breaking the conductor, and compatibility/mechanical considerations of the cable support mechanism may be investigated in the test by simulating the weight of the vertical cable run. When so investigated, the maximum vertical distance tested and the cable support mechanism (s) are detailed in the system.

Compatibility of materials used in fire-rated systems is also a concern. Some materials can provide carbon residue that is conductive, or conductive gases that can cause premature failure. A dedicated raceway is the required configuration unless otherwise noted in the system (such as the option of bare ground wires or insulated ground wires). The bare or insulated ground wire may be of special manufacture to be compatible with the system. The system will specify the manufacturer of an allowable ground wire. If not specified, the ground should be the same as the fire-rated wire described in the system. Use of any other ground wire violates the system fire rating. For example, THHN ground wire is not intended to be used with a fire-rated system unless specified in the system. If a pulling lubricant has been tested with the system, it will be so noted in the system.

These systems are intended to be installed in accordance with all provisions of the NEC and as amended by the details of each individual system (such as type of supports and distance between supports).

Authorities Having Jurisdiction should be consulted as to the specific requirements covering the installation and use of these systems.

Related Products

Fire-resistive cable with the "-CI" marking is also investigated to ANSI/UL 2196 and is covered under Power-limited Fire Alarm Cable (HNIR) and Nonpower-limited Fire Alarm Cable (HNHT).

3M Fire Protection Products

Underwriters Laboratories Inc. Explanation

Electrical Circuit Protective Systems – Flexible Wraps (FHIT) – continued

Additional Information

For additional information, see Fire Resistance Ratings (BXRH).

Requirements

The basic requirements used to investigate systems incorporating cable protected with electrical circuit protective materials in this category are contained in UL Subject 1724, "Outline of Investigation for Fire Tests for Electrical Circuit Protective Systems."

The basic standard used to investigate systems constructed with fire-resistive cable in this category is ANSI/UL 2196, "Tests for Fire Resistive Cables."

UL Mark

System components identified by an (*) in the description text are Classified under the Classification and Follow-Up Service of UL. Such components and names of manufacturers who are authorized to apply the Classification Mark are identified under the specific product category.

UL, in performing its functions in accordance with its objectives, does not assume or undertake to discharge any responsibility of the manufacturer or any other party. UL shall not incur any obligation or liability for any loss, expense or damages, including incidental or consequential damages, arising out of or in connection with the use, interpretation of, or reliance upon this Guide Information.

3M Fire Protection Products

Underwriters Laboratories Inc. Explanation Flexible Wraps Firestop Systems (BYBU) ANSI / UL1709

General

This category covers fire-rating Classifications based upon the test method and acceptance criteria in ANSI/UL 1709, "Rapid Rise Fire Tests of Protection Materials for Structural Steel." These ratings are expressed in hours and are applied to steel columns.

The fire ratings in this category are similar to the ratings for columns covered under Fire Resistance Ratings (BXUV) except for the following two major differences: (1) the rate of temperature rise of the fire exposure, and (2) the inclusion of environmental exposure simulating potential environments in which the fire-resistive assemblies may be located.

The temperature of the fire exposure in which rapid temperature rise ratings are established reaches 2000°F within the first 5 minutes of the fire exposure test. The fire temperature is maintained at 2000°F throughout the rating period. This fire exposure was developed to provide a means to investigate fire-resistive assemblies intended for use in areas such as petrochemical production facilities, which may develop fire temperatures at a more rapid rate than assemblies tested under ANSI/UL 263, "Fire Tests of Building Construction and Materials."

The systems covered under this category are subjected to standardized environmental tests, which include accelerated aging, high humidity, salt spray exposure, cycling effects of water/freezing temperatures/dryness, and exposure to air containing carbon dioxide and sulfur dioxide. The systems may also be exposed to optional environmental tests, which simulate environments containing various solvents and/or acids. These environmental exposures are intended to measure the ability of the fire-resistive assemblies to retain some degree of fire resistance when subjected to conditions that may occur at production facilities exposed to weathering. A list of the environmental exposures is included in the Classification information for each material described in this category.

The assemblies covered under this category are identified by an alphanumeric system. The identification system is similar to the assemblies in BXUV except an R is included in the number. For example, a column coated with an SFRM (spray-applied fire-resistive material) is identified as Design No. XR7___ (X for column, R for rapid temperature rise fire, 7 for SFRM, and ___ reserved for the sequential numbering of each design).

Unless specifically prohibited in a design, materials identified as Spray-applied Fire-resistive Materials (CHPX) may be applied to primed or similarly painted wide-flange steel shapes, provided: (A) the column flange width does not exceed 16 in., (B) the column web depth does not exceed 16 in., and (C) bond tests conducted in accordance with ANSI/ASTM E736, "Standard Test Method for Cohesion/Adhesion of Sprayed Fire-Resistive Materials Applied to Structural Members," indicate a minimum average bond strength of 80% and a minimum individual bond strength of 50% when compared to the bond strength of the fire-resistive coating as applied to clean, uncoated 1/8 in.-thick steel plate. The average and minimum bond strength values are determined based upon a minimum of five bond tests conducted in accordance with ANSI/ASTM E736.

The bond tests need only be conducted when the fire-resistive coating is applied to a primed or similarly painted surface for which acceptable bond strength performance between the primer or other similar material and the fire-resistive coating has not been measured. A bonding agent may be applied to the primed or similarly painted surface to obtain the minimum required bond strength where the bond strengths are found to be below the minimum acceptable values.

As an alternative to the bond test conducted on control samples applied to an uncoated steel plate, the following method may be used for unknown coatings in existing structures. Sections of painted steel are coated with a bonding agent compatible with the sprayed material being used on the project. The treated and untreated substrates are coated with material, cured and subjected to five bond tests each, in accordance with ANSI/ASTM E736. If the failure mode of the sections treated with the bonding agent is 100% cohesive in nature, it is acceptable to use this bond test value as the control bond strength. The value obtained on the untreated painted section is compared to the control value using the minimum 80% average, 50% individual bond strength acceptance criteria established in ANSI/ASTM E736.

If condition (C) is not met, a mechanical bond may be obtained by wrapping the structural member with expanded metal lath (minimum 1.7 lbs per sq yd).

Underwriters Laboratories Inc. Explanation

Flexible Wraps Firestop Systems (BYBU) ANSI / UL1709 – continued

If any of the conditions specified in (A) or (B) are not met, a mechanical break is provided. A mechanical break may be provided by mechanically fastening one or more minimum 1.7 lbs per sq yd metal lath strips to the flange or web either by weld, screw, or powder-actuated fasteners, on maximum 12 in. centers, on each longitudinal edge of the strip, so that the clear spans do not exceed the limits established in conditions (A) or (B) as appropriate. No less than 25% of the width of the oversize flange or web element should be covered by the metal lath. No strip of metal lath should be less than 3-1/2 in. wide.

As an alternative to metal lath, the mechanical break may be provided by the use of minimum No. 12 gauge steel studs with minimum No. 28 gauge galvanized steel disks if such a system is described in a specific design (usually bottomless trench in an electrified floor design) for the fire-resistive coating being applied. The studs are welded to the oversize element in rows such that the maximum clear span conforms to conditions (A) or (B) as appropriate. The spacing of studs along each row should not exceed 24 in. and a minimum one stud 256 sq in. is provided. Where metal lath strips or steel studs and disks are used, acceptable bond strength as described in item (C) is also provided. A bonding agent may be applied to the painted surface to obtain the required minimum bond strength where bond strengths to a painted surface are found to be below minimum acceptable values.

Additional Information

For additional information, see Fire Resistance Ratings (BXRH).

UL, in performing its functions in accordance with its objectives, does not assume or undertake to discharge any responsibility of the manufacturer or any other party. UL shall not incur any obligation or liability for any loss, expense or damages, including incidental or consequential damages, arising out of or in connection with the use, interpretation of, or reliance upon this Guide Information.

Underwriters Laboratories Inc. Explanation Ventilation Duct Assemblies (HNLJ)

General

This category covers the fire-resistive performance of ventilation duct assemblies investigated in accordance with ISO 6944-1985, "Fire Resistance Tests - Ventilation Ducts." The purpose of this test is to measure the ability of a representative ventilation duct assembly to resist the spread of fire from one compartment to another without the aid of fire dampers.

ISO 6944 defines performance requirements for ventilation duct assemblies in terms of insulation, integrity and stability. Stability is the measurement of a ventilation duct assembly's ability to resist collapse which would prevent the ventilation duct assembly from performing its intended function. Integrity is the measurement of the ventilation duct assembly's ability to resist the passage of flames and hot gases into a nonfire environment. Insulation is the measurement of the ventilation duct assembly's ability to limit the temperature rise on the surface of the ventilation duct assembly in a nonfire environment from reaching an average temperature rise of 140°C (252°F) and a maximum temperature rise of 180°C (324°F).

ISO 6944 is applicable to vertical and horizontal ducts, with or without branches, taking into account the joints, air supply and exhaust openings, as well as the basic duct construction.

ISO 6944 contains requirements for two types of ventilation duct assemblies, identified as Duct A and Duct B. The requirements for Duct A are intended for ventilation duct assemblies that pass through the fire environment without openings. The requirements for Duct B are intended for ventilation duct assemblies where the duct contains openings within the fire environment.

ISO 6944 recommends the ventilation duct assembly tested represent the maximum width-to-height ratio intended for use. ISO 6944 also recommends the tested duct be 250 mm by 1000 mm. The Classification for all ventilation duct assemblies is based upon data from fire tests on 250 mm by 1000 mm ducts unless reported otherwise.

Ventilation duct assemblies have been investigated for a flame spread rating of 25 or less and a smoke developed rating of 50 or less in accordance with ANSI/NFPA 90A, "Installation of Air-Conditioning and Ventilating Systems."

Ventilation duct assemblies are intended to be installed in accordance with the manufacturer's installation instructions provided with the product.

Where a ventilation duct assembly penetrates a fire-rated floor or wall assembly, the resulting opening around the ventilation duct assembly should be firestopped with a firestop system tested in accordance with ANSI/UL 1479, "Fire Tests of Through-Penetration Firestops." Each individual ventilation duct assembly includes reference to one or more through-penetration firestop systems described in Through-penetration Firestop Systems (XHEZ).

The F and T ratings of the firestop system should be equal to or greater than the hourly insulation rating of the ventilation duct assembly, and the F rating of the firestop system should be equal to or greater than the hourly integrity and stability ratings of the ventilation duct assembly.

Authorities Having Jurisdiction should be consulted as to the particular requirements covering the installation and use of these Classified assemblies.

Additional Information

For additional information, see Fire-resistive Duct Assemblies (HNKN) and Fire Resistance Ratings (BXRH).

UL Mark

Those materials identified by an (*) in the assembly description text are eligible to be produced under UL's Follow-Up Service Program. The Classification Mark of UL on the product is the only method provided by UL to identify products manufactured under its Classification and Follow-Up Service.

UL, in performing its functions in accordance with its objectives, does not assume or undertake to discharge any responsibility of the manufacturer or any other party. UL shall not incur any obligation or liability for any loss, expense or damages, including incidental or consequential damages, arising out of or in connection

3M Fire Protection Products

Intertek Design Listing Nomenclature

| Joint Protection Systems | Current Naming Intertek Testing Services (ITS) | Legacy Naming OmegaPointLaboratories(OPL) |
|--|--|---|
| Perimeter Fire Barrier | JS / PFB | CEJ xxx P |
| Head of Wall Joint Systems | EJH | CEJ xxx H |
| Floor Expansion Joint | EJH | CEJ xxx F |
| Wall Expansion Joint | EJV | CEJ xxx W |
| Floor/Wall Expansion Joint | EJH | CEJ xxx FW |
| Duct Protection Systems | | |
| Grease Duct Protection | FRD | GD |
| Chemical Fume Exhaust Duct Protection | FRD | CFD |
| Ventilation Duct Protection Systems | FRD / DI | VAD |
| Protective Envelopes | | |
| Electrical Circuit Protection | PHV | ECP |
| Plenum Protection | BI / FRD | PP |
| Process Piping | PPI | FPE |
| Through Penetration Firestop Systems & Flexible Wraps Firestop Systems | | |
| Penetration Firestop Through Wall Assembly | PH | FS xxx W |
| Penetration Firestop Through Floor-Ceiling Assembly | PV | FS xxx F |
| Penetration Firestop Through Wall or Floor-Ceiling Assembly | PHV | N/A |
| Structural Protection - Roof/Ceiling, Floor/Ceiling, Beam & Column Assemblies | | |
| Beam | | FCA |

Intertek Legend

| | |
|-----|---|
| BI | Blanket Insulation |
| DI | Duct Insulation |
| EJH | Expansion Joint, Horizontal |
| EJV | Expansion Joint, Vertical |
| FCA | Floor-Ceiling Assembly |
| FRD | Fire-Resistant Duct |
| JS | Joint System |
| PFB | Perimeter Fire Barrier |
| PH | Penetration, Horizontal Assembly |
| PHV | Penetration of either a Horizontal or Vertical Assembly |
| PPI | Process Piping Insulation |
| PV | Penetration, Vertical Assembly |

Omega Point Legend

| | |
|-----|-------------------------------|
| B | Beam |
| CEJ | Construction Expansion Joint |
| CFD | Chemical Fume Duct |
| ECP | Electrical Circuit Protection |
| F | Floor |
| FPE | Fire Protective Enclosure |
| FS | Fire Penetration Seal |
| FW | Floor-Wall |
| GD | Grease Duct Perimeter |
| P | Perimeter |
| PP | Plenum Protection |
| VAD | Ventilation Air Duct |
| W | Wall |

Reprinted from the Online Certifications Directory with permission from Underwriters Laboratories Inc. Copyright © 2010 Underwriters Laboratories Inc. Last modified 5-20-2010.



Through Penetrations

UL

CAJ

Concrete floors with a minimum thickness less than or equal to 5 inches (127 mm)
Concrete or masonry walls with a minimum thickness less than or equal to 8 inches (203 mm)

CBJ

Concrete floors with a minimum thickness greater than 5 inches (127 mm)
Concrete or masonry walls with a minimum thickness less than or equal to 8 inches (203 mm)

FA

Concrete floors/Steel decks
Concrete or masonry walls with a minimum thickness less than or equal to 8 inches (203 mm)

FB

Concrete floors/Steel decks
Concrete floors with a minimum thickness greater than 5 inches (127 mm)

FC

Floor assemblies
Framed floors

FE

Truss floor assemblies

WJ

Floor assemblies
Concrete or masonry walls with a minimum thickness less than or equal to 8 inches (203 mm)

WL

Wall assemblies
Framed walls

WK

Wall assemblies
Concrete or masonry walls with a thickness greater than 8 inches (203 mm)

Blanks

CAJ

Concrete floors with a minimum thickness less than or equal to 5 inches (127 mm)

Concrete or masonry walls with a minimum thickness less than or equal to 8 inches (203 mm)

FA

Concrete floors/Steel decks

Concrete or masonry walls with a minimum thickness less than or equal to 8 inches (203 mm)

WJ

Floor assemblies

Concrete or masonry walls with a minimum thickness less than or equal to 8 inches (203 mm)

WL

Wall assemblies

Framed walls

Blanks • Concrete

| 3M UL Systems | "F" Rating | 3M Product | Through Penetrant Details |
|------------------|------------|--|--|
| C-AJ-0004 | 1, 2, 3, 4 | 3M™ Expanrol™ Flexible Intumescent Strip E-FIS 3M™ Fire Barrier Wrap Ultra GS 3M™ Fire Barrier Sealant CP 25WB+ 3M™ Fire Barrier Water Tight Sealant 3000 WT 3M™ Fire Barrier Moldable Putty Stix MP+ 3M™ Fire Barrier Composite Sheet CS-195+ | Max. 36 square foot opening with a max. 36 inch dimension in a concrete floor or wall utilizing CS 195+ Composite Sheet. 1, 2, 3, or 4 hour rating attainable. |
| C-AJ-0007 | 1, 2, 3, | 3M™ Fire Barrier Moldable Putty Stix MP+ 3M™ Fire Barrier Packing Material PM4 | Max. 4 in. diameter blank opening in a concrete floor or wall utilizing mineral wool and MP+ Moldable Putty. Optional steel sleeve. |
| C-AJ-0008 | 1, 2 | 3M™ Fire Barrier Silicone Sealant 2000+ 3M™ Fire Barrier Silicone Sealant 2000 NS 3M™ Fire Barrier Water Tight Sealant 1000 NS 3M™ Fire Barrier Water Tight Sealant 1003 SL | Max. 36 square inch opening with a maximum dimension of 6 inch in a concrete floor or wall. Utilizing a metal lath, packing material, and Fire Barrier silicone sealants. |
| C-AJ-0009 | 1, 2, 3, | 3M™ Fire Barrier Sealant CP 25WB+ 3M™ Fire Barrier Packing Material PM4 | Max. 6 in. diameter blank opening in a concrete floor or wall utilizing mineral wool and CP 25WB+ Sealant. Optional steel sleeve. |
| C-AJ-0060 | 1, 2, 3, | 3M™ Fire Barrier Water Tight Sealant 1000 NS 3M™ Fire Barrier Water Tight Sealant 1003 SL | Max. 6 in. diameter blank opening in a concrete floor or wall utilizing mineral wool and Fire Barrier silicone sealants. Optional steel or PVC sleeve. |
| C-AJ-0084 | 1, 2, 3, | 3M™ Fire Barrier Moldable Putty Stix MP+ 3M™ Fire Barrier Pillows 3M™ Fire Barrier Self-Locking Pillows | Max. 360 square inch opening with a max. 30 inch dimension in a concrete floor or wall utilizing Fire Barrier Pillows and MP+ Moldable Putty. 1, 2, or 3 hour rating attainable. |
| C-AJ-0091 | 1, 2 | 3M™ Fire Barrier Sealant CP 25WB+ 3M™ Fire Barrier Sealant IC 15WB+ | Max. 6 in. diameter blank opening in a concrete floor or wall utilizing mineral wool and IC 15WB+ Sealant or CP 25WB+ Sealant. Optional steel sleeve. |
| C-AJ-0118 | 1, 2 | 3M™ Fire Barrier Pass-Through Products 3M™ Fire Barrier Water Tight Sealant 3000 WT 3M™ Fire Barrier Sealant CP 25WB+ 3M™ Fire Barrier Sealant IC 15WB+ 3M™ Fire Barrier Moldable Putty Stix MP+ | Blank opening in a concrete wall or floor utilizing a Fire Barrier Pass-Through Device. This system allows a blank opening to be firestopped and simultaneously prepared to accept penetrants. |
| C-AJ-0131 | 1, 2, 3, | 3M™ Fire Barrier Mortar | Max. 1296 square inch opening with a max. 36 inch dimension in a concrete floor or wall utilizing Fire Barrier Mortar and a reinforcement grid of steel rebar. |
| C-AJ-0134 | 1, 2, 3, | 3M™ Fire Barrier Putty Sleeves 3M™ Fire Barrier Moldable Putty Stix MP+ | Blank opening in a concrete wall or floor utilizing a Fire Barrier Putty Sleeve kit. This system allows a blank opening to be firestopped and simultaneously prepared to accept penetrants. |
| C-AJ-0139 | 1, 2, 3, | 3M™ Fire Barrier Mortar | Max. 1728 square inch opening with a max. 48 inch dimension in a concrete floor or wall utilizing Fire Barrier Mortar. |
| C-AJ-0140 | 1, 2 | 3M™ Fire Barrier Rated Foam FIP 1-Step | Max. 8 inch diameter opening in a concrete floor or wall utilizing Fire Barrier Rated Foam, FIP 1-Step. |
| C-AJ-0153 | 1, 2 | 3M™ Fire Barrier Block 3M™ Fire Barrier Plank 3M™ Fire Barrier Rated Foam FIP 1-Step | Max. 384 square inch opening with a max. 32 inch dimension in a concrete floor or wall utilizing Fire Barrier Block/Planks and FIP 1-Step. |
| C-AJ-0154 | 1, 2 | 3M™ Fire Barrier Plug | Max. 4.5 in. diameter opening in a concrete floor or wall utilizing Fire Barrier Plug(s). |
| C-AJ-0163 | 1, 2 | 3M™ Fire and Water Barrier Tape 3M™ Watertight Spray | Max. 64 square inch opening with a max. 8 inch dimension in a concrete floor or wall utilizing Fire and Water Barrier Tape or Fire Barrier Watertight Spray. |
| F-A-0004 | 1, 2 | 3M™ Fire Barrier Sealant CP 25WB+ 3M™ Fire Barrier Composite Sheet CS-195+ 3M™ Fire Barrier Water Tight Sealant 3000 WT | Max. 3 square foot blank opening in min. 4.5 in. thick concrete floor. Utilizing CS 195+ Composite Sheet. |
| F-A-0011 | 1, 2, 3, | 3M™ Fire Barrier Cast-In Devices for Metal Pipes 3M™ Fire Barrier Water Tight Sealant 1003 SL 3M™ Fire Barrier Water Tight Sealant 1000 NS 3M™ Fire Barrier Sealant CP 25WB+ 3M™ Fire Barrier Water Tight Sealant 3000 WT 3M™ Fire Barrier Moldable Putty Stix MP+ 3M™ Fire Barrier Sealant IC 15WB+ 3M™ Fire Barrier Sealant FD 150+ | Fire Barrier Metal Cast-In Device with no penetrants installed in a concrete floor. W rating available. Utilizing packing material and sealant. |
| F-A-0013 | 1, 2 | 3M™ Fire Barrier Cast-In Devices for Metal Pipes 3M™ Fire Barrier Water Tight Sealant 1000 NS 3M™ Fire Barrier Water Tight Sealant 1003 SL 3M™ Fire Barrier Water Tight Sealant 3000 WT 3M™ Fire Barrier Cast-In Device Metal Deck Adaptors | Fire Barrier Metal Cast-In Device with Metal Deck Adapter with no penetrants installed in a concrete floor over fluted steel deck. W rating available. Utilizing packing material and sealant. |

Blanks • Concrete

| 3M UL Systems | "F" Rating | 3M Product | Through Penetrant Details |
|---------------|------------|---|---|
| F-A-0015 | 1, 2, 3, | 3M™ Fire Barrier Cast-In Devices for Metal Pipes 3M™ Fire Barrier Cast-In Devices for Plastic Pipes 3M™ Fire Barrier Water Tight Sealant 1000 NS 3M™ Fire Barrier Water Tight Sealant 1003 SL 3M™ Fire Barrier Water Tight Sealant 3000 WT 3M™ Fire Barrier Cast-In Device Metal Deck Adaptors | Fire Barrier Metal or Plastic Cast-In Device with no penetrants installed in a concrete floor. W rating available. Utilizing packing material and sealant. |
| F-A-0024 | 1, 2, 3, | 3M™ Fire Barrier Cast-In Devices for Metal Pipes 3M™ Fire Barrier Cast-In Devices for Plastic Pipes 3M™ Fire Barrier Water Tight Sealant 1000 NS 3M™ Fire Barrier Water Tight Sealant 1003 SL 3M™ Fire Barrier Cast-In Device Metal Deck Adaptors | Fire Barrier Metal or Plastic Cast-In Device with Metal Deck Adapter with no penetrants installed in a concrete floor over fluted steel deck. W rating available. Utilizing packing material and sealant. |
| W-J-0017 | 1, 2 | 3M™ Fire Barrier Sealant IC 15WB+ 3M™ Fire Barrier Sealant CP 25WB+ 3M™ Fire Barrier Water Tight Sealant 3000 WT | Max 2 in. opening. No mineral wool required. 2 hour F & T rating. Also known as WJ0017. |
| W-J-0021 | 1, 2, 3, | 3M™ Fire Barrier Pillows 3M™ Fire Barrier Self-Locking Pillows 3M™ Fire Barrier Sealant IC 15WB+ 3M™ Fire Barrier Sealant CP 25WB+ 3M™ Fire Barrier Water Tight Sealant 3000 WT | Max 6 in. blank opening. Min 6 in. concrete wall or concrete block wall. 2 & 3 hour F & T ratings. Min 28 gauge sheet metal sleeve required. Sealant only at concrete/sleeve interface. Also known as WJ0021. |
| W-J-0023 | 1, 2 | 3M™ Fire Barrier Sealant IC 15WB+ 3M™ Fire Barrier Sealant CP 25WB+ 3M™ Fire Barrier Water Tight Sealant 3000 WT 3M™ Fire Barrier Rated Foam FIP 1-Step | Min 4-1/2 in. concrete wall or concrete block wall. Max 6-1/2 in. opening. Nom 6 in. steel sleeve. Also known as WJ0023 |
| W-J-0025 | 1, 2 | 3M™ Fire Barrier Block 3M™ Fire Barrier Plank 3M™ Fire Barrier Rated Foam FIP 1-Step | Max 144 sq. in. with max dimension of 12 in. blank opening in a min 6 in. concrete wall assembly. Also known as WJ0025 |
| W-J-0026 | 1, 2 | 3M™ Fire Barrier Block 3M™ Fire Barrier Plank 3M™ Fire Barrier Rated Foam FIP 1-Step 3M™ Fire Barrier Sealant IC 15WB+ 3M™ Fire Barrier Sealant CP 25WB+ 3M™ Fire Barrier Water Tight Sealant 3000 WT | Blank opening in a concrete wall assembly with a 1080 sq. in. opening with max 36 in. dimension. |

System No. C-AJ-0004

June 28, 2010

F Ratings – 1, 2, 3 and 4 Hr (See Items 1 and 3)

T Ratings – 0 and 1-1/2 Hr (See Item 3)

L Rating At Ambient – less than 1 CFM/sq ft (See Item 2)

L Rating At 400 F – less than 1 CFM/sq ft (See Item 2)

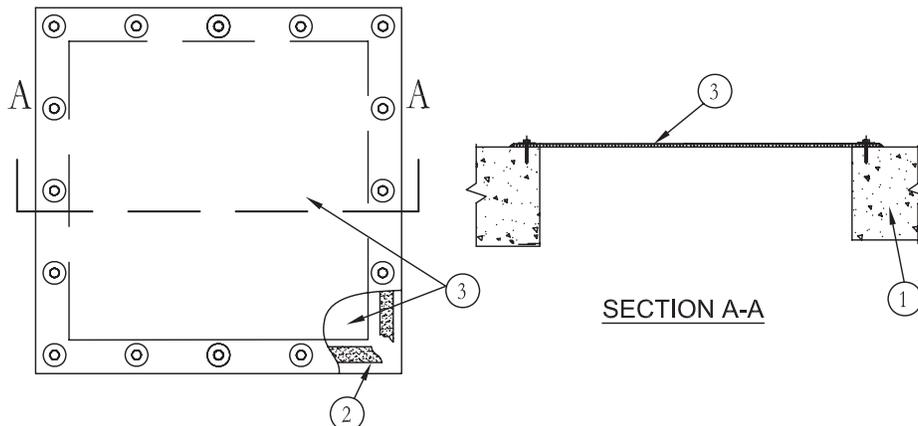

CONFIGURATION A - 1, 2 AND 3 HR F RATINGS

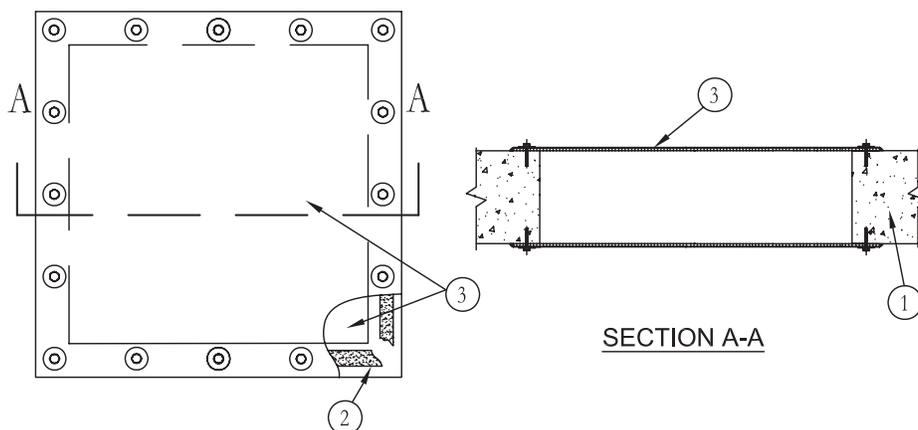

CONFIGURATION B - 4 HR F RATINGS

1. **Floor or Wall Assembly** – Lightweight or normal weight (100-150 pcf or 1600-2400kg/m³) concrete. Min thickness of concrete floor or wall assembly to be 2-1/2 in. (64 mm) for 1 and 2 hr F Rating, 4-1/2 in. (114 mm) for 3 h F rating and 5-1/2 in. (140 mm) for 4 h F rating. Wall may also be constructed of any UL Classified **Concrete Blocks***. Max area of opening 36 sq ft (3.34 m²) with one dimension of opening being 36 in. (914 mm) or less.

See **Concrete Blocks** (CAZT) category in the Fire Resistance Directory for names of manufacturers.

2. **Fill, Void Or Cavity Materials*** – **Graphite Seal, Caulk, Sealant or Putty** (Not Shown) – One layer of 1/2 in. (13 mm) x 1/16 in. (1.6 mm) adhesive backed graphite intumescent seal positioned under intumescent sheet around entire perimeter of through opening or min 1/4 in. (6 mm) diam continuous bead of caulk or putty applied to edge of intumescent sheet at its interface with surface of floor or wall around entire perimeter of through opening.

3M COMPANY – E-FIS or Ultra GS seals, CP 25WB+ caulk, MPS-2+ putty, FB-3000 WT sealant

(Note: L Ratings apply only when Type CP 25WB+ or FB-3000 WT sealant caulk is used.)

3. **Fill, Void Or Cavity Materials*** – **Intumescent Sheet** – Rigid aluminum foil-faced sheets with galv steel sheet backer. Sheet cut to lap a min of 2 in. (51 mm) on the floor or wall surface on all sides of the through opening. Sheets to be installed with the galv steel sheet backer exposed (aluminum foil facing against floor or wall surface). Sheets secured to both sides of floor or wall assembly using min 3/16 in. (4.8 mm) diam by 1-1/4 in. (32 mm) long steel masonry fasteners with min 1-1/4 in. (32 mm) diam steel washers. Max spacing of fasteners not to exceed 6 in. (152 mm) OC. As an option for 1, 2 and 3 h F ratings in floor assemblies only, the sheet may be installed only on the top surface of the floor (see Configuration A above). When the sheet is installed only on the top surface of the floor, T Rating is 0 h.

3M COMPANY – Type CS-195+

4. **Support Channel** – (Not shown) – When area of through opening exceeds 1440 sq in., (9,290 cm²) an intermediate support channel shall be installed on each side of floor or wall assembly, flush with floor or wall surface, near the center of the opening. Support channels to be min 1-5/8 by 1-5/8 in. (41 by 41 mm) and formed of min 0.093 in. (2.36 mm) thick (No. 12 gauge) painted or galv steel. Ends of steel channel bolted or welded to steel angles anchored to inside walls of through opening. Intumescent sheets secured to steel support channels with steel sheet metal screws in conjunction with min 1-1/4 in. (32 mm) diam steel fender washers spaced a max of 4 in. (102 mm) OC.

*Bearing the UL Classification Marking

Reprinted from the Online Certifications Directory with permission from Underwriters Laboratories Inc.

Copyright © 2010 Underwriters Laboratories Inc.®



System No. C-AJ-0007

May 21, 2012

ANSI/UL1479 (ASTM E814)

F Rating – 3 Hr

T Ratings – 0 and 2 Hr (See Item 2)

CAN/ULC S115

F Rating – 3 Hr

FT Ratings – 0 and 2 Hr (See Item 2)

FH Rating – 3 Hr

FTH Ratings – 0 and 2 Hr (See Item 2)

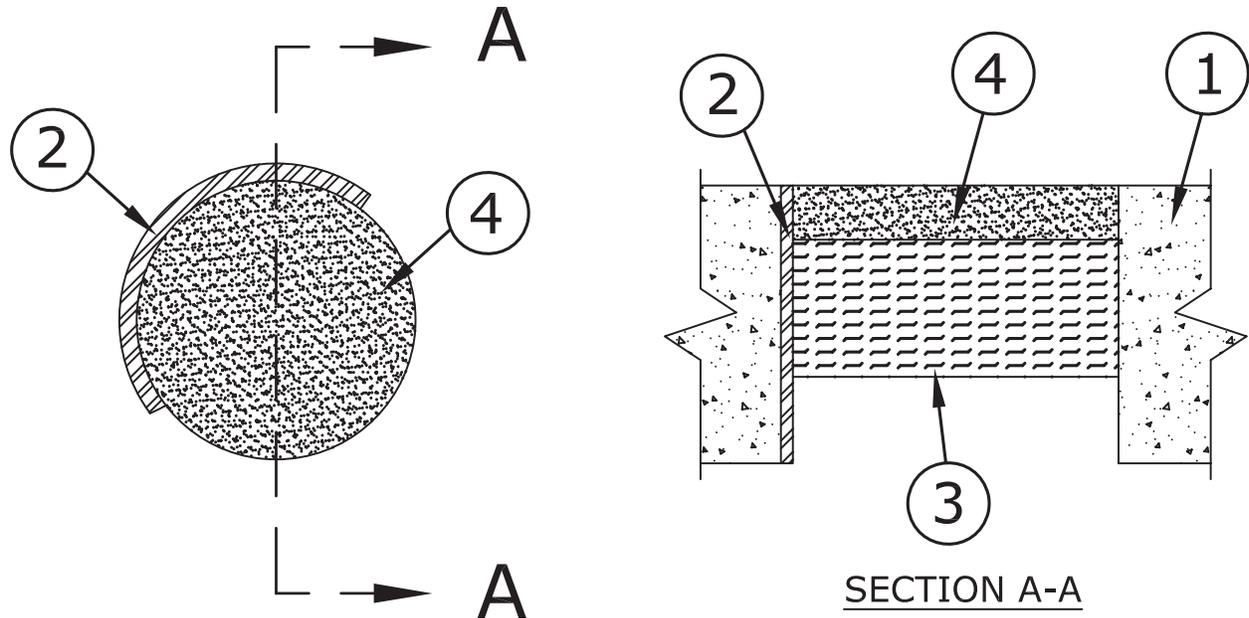

1. **Floor or Wall Assembly** – Min 4-1/2 in. (114 mm) thick lightweight or normal weight (100-150 pcf or 1600-2400 kg/m³) concrete. Wall may also be constructed of any UL Classified **Concrete Blocks***. Max diam of opening is 4 in. (102 mm).
See **Concrete Blocks (CAZT)** category in the Fire Resistance Directory for names of manufacturers.
2. **Steel Sleeve** – (Optional) – Nom 4 in. (102 mm) diam (or smaller) Schedule 10 (or heavier) steel sleeve cast or grouted into floor or wall assembly. Steel sleeve may be installed flush or may project max 2 in. (51 mm) beyond the floor or wall surfaces. As an alternate, nom 4 in. (102 mm) diam (or smaller) sleeve fabricated from nom 0.019 in. (0.48 mm) thick galv steel cast or grouted into floor or wall assembly flush with floor or wall surfaces. **When steel sleeve is used, T Rating is 0 Hr.**
3. **Packing Material** – Min 1 in. (25 mm) thickness of ceramic (alumina silica) fiber blanket or mineral wool batt insulation firmly packed into opening as a permanent form. When steel sleeve (Item 2) is used, min packing material thickness is 2 in. (51 mm). Packing material to be recessed min 1 in. (25 mm) from top surface of floor or floor sleeve or from both surfaces of wall or both ends of wall sleeve to accommodate the required thickness of fill material.
- 3A. **Forming Material*** – As an alternate to the packing material in Item 3, nom 4 in. (102 mm) wide strips of min 1/2 in (13 mm) thick compressible mat to be folded in half, lengthwise, and tightly-rolled into a solid 2 in. (51 mm) high cylinder having a diameter greater than the inside diameter of the opening and installed edge-first into the opening. Top of forming material to be recessed min 1 in. (25 mm) from top surface of floor or floor sleeve or from both surfaces of wall or both ends of wall sleeve to accommodate the required thickness of fill material.
3M COMPANY – Fire Barrier Packing Material
4. **Fill, Void or Cavity Materials* – Putty** – Moldable putty material, applied to fill through opening to a min depth of 1 in. (25 mm). In floors, fill material to be installed flush with top surface of floor or floor sleeve. In walls, fill material to be installed flush with wall surface or end of sleeve on both sides of wall assembly.
3M COMPANY – MPS-2+ Putty

*Bearing the UL Classification Mark

Reprinted from the Online Certifications Directory with permission from UL
© 2013 UL LLC

System No. C-AJ-0008

May 09, 2013

F Rating – 2 Hr

T Rating – 2 Hr

L Rating At Ambient – Less Than 1 CFM/sq ft

L Rating At 400 F – Less Than 1 CFM/sq ft

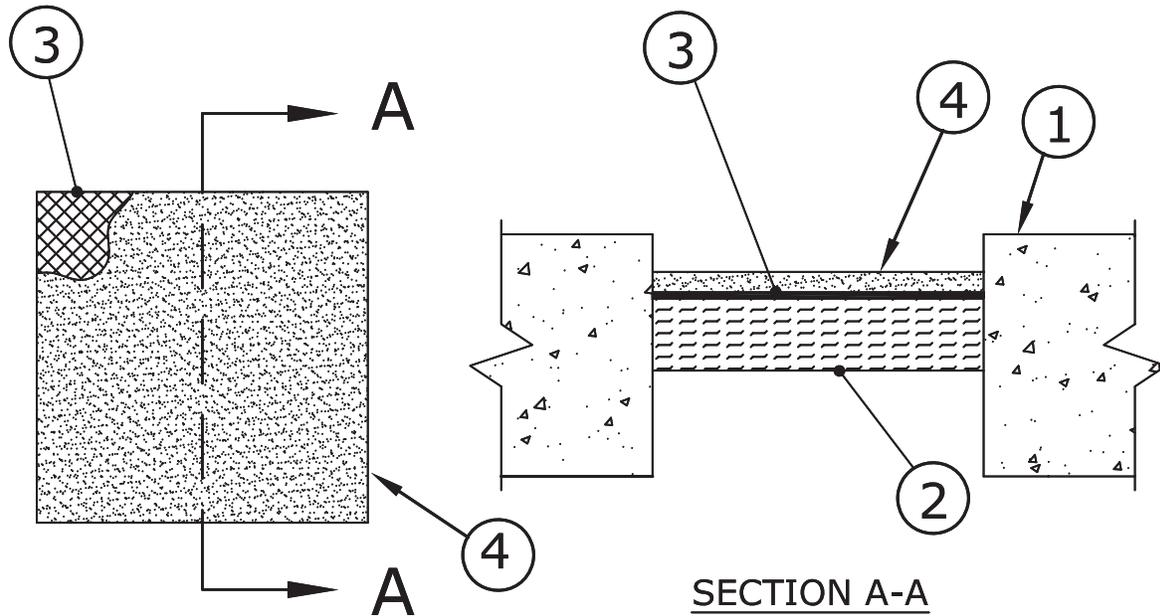

1. **Floor or Wall Assembly** – Min 4-1/2 in. (114 mm) thick reinforced lightweight or normal weight (100-150 pcf or 1600-2400 kg/m³) concrete. Walls may also be constructed of any UL Classified **Concrete Blocks***. Max area of opening is 36 sq in. (232 cm²) with max dimension shall be 6 in. (152 mm).

See **Concrete Block** (CAZT) category in the Fire Resistance Directory for names of manufacturers.

2. **Packing Materials** – Min 1-1/2 in. (38 mm) thickness of min 4 pcf (64 kg/m³) mineral wool batts insulation firmly packed into opening as a permanent form. Packing material to be recessed 1-3/4 in. (44 mm) from top surface of floor or from one surface of wall.
3. **Metal Lath** – Metal lath, weighing a min of 2.5 lb/sq yd shall be cut 1 in. (25 mm) larger than each dimension of the hole. The four edges shall be bent upwards at a 90 degree angle. The lath is positioned above the mineral wool insulation, with the bent edges facing upwards. In walls, the lath is installed on both surfaces of the mineral wool.
4. **Fill, Void or Cavity Material* – Sealant** – Min 1/2 in. (13 mm) thickness of fill material applied to the top surface of steel lath. For walls, fill material shall be installed adjacent to both pieces of the steel lath.

3M COMPANY – Types FB-1000 NS, FB-1003SL (floors only), FB-2000 or FB-2000+ (Floors Only).

*Bearing the UL Classification Mark

Reprinted from the Online Certifications Directory with permission from UL
© 2013 UL LLC



System No. C-AJ-0009

July 15, 2011

F Rating – 3 Hr

T Ratings – 0, 1/2, 3/4, 1 and 1-1/2 Hr (See Item 4)

L Rating At Ambient – 2 CFM/sq ft

L Rating At 400 F – less than 1 CFM/sq ft

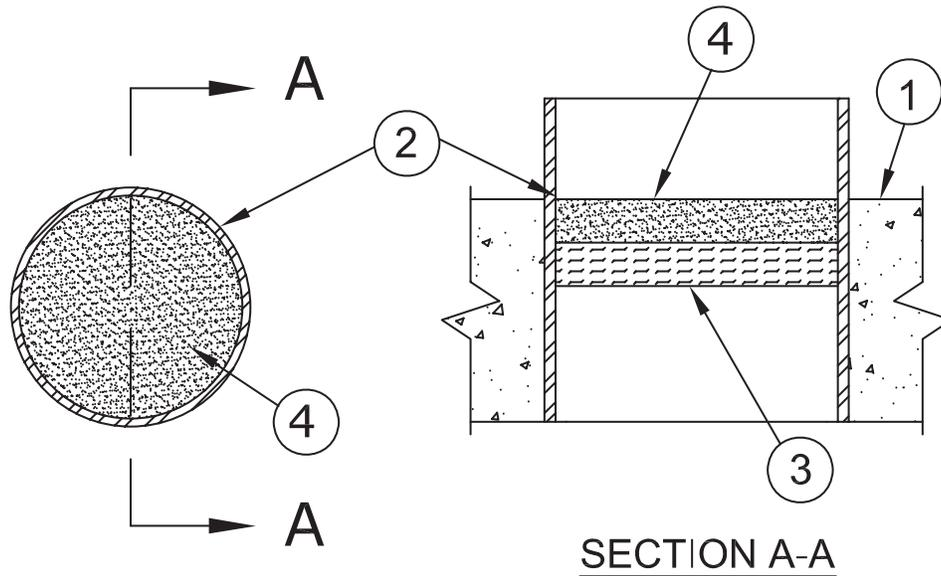

- Floor or Wall Assembly** – Min 4-1/2 in. (114 mm) thick lightweight or normal weight (100-150 pcf or 1600-2400 kg/m³) concrete. Wall assembly may also be constructed of any UL Classified Concrete Blocks*. Max diam of circular through opening is 6 in. (152 mm). See Concrete Blocks (CAZT) category in the Fire Resistance Directory for names of manufacturers.
 - Sleeve** – (Optional) – Nom 6 in. (152 mm) diam (or smaller) Schedule 40 steel pipe cast into floor or wall assembly. Sleeve to be flush with or project max 2 in. from top surface of floor or from both surfaces of wall.
 - Packing Material** – Min 1 in. (25 mm) thickness of min 4 pcf (64 kg/m³) mineral wool batt insulation firmly packed into opening as a permanent form. Packing material to be recessed from top surface of floor or from both surfaces of wall as necessary to accommodate the required thickness of caulk fill material.
 - Forming Material*** – As an alternate to the packing material in Item 3, nom 4 in. (102 mm) wide strips of min 1/2 in. (13 mm) thick compressible mat to be tightly-rolled into a solid 4 in. (102 mm) high cylinder having a diameter greater than the inside diameter of the opening and installed edge-first into the opening. As an option, the strips of min 1/2 in. (13mm) thick compressible mat may be folded in half, lengthwise, and tightly-rolled into a solid 2 in. (51 mm) high cylinder having a diameter greater than the inside diameter of the opening and installed edge-first into the opening. Top of forming material to be recessed from top surface of floor or from both surfaces of wall as necessary to accommodate the required thickness of caulk fill material.
- 3M COMPANY** – Fire Barrier Packing Material
- Fill, Void or Cavity Materials* – Caulk** – Applied to fill the through opening flush with the top surface of floor or both surfaces of wall. The hourly T Rating is dependent upon the diam of the through opening, the presence of a steel sleeve and the thickness of caulk fill material, as tabulated below:

| Max Opening or Sleeve Diam In. (mm) | Steel Sleeve | Min Caulk Thkns In. (mm) | T Rating Hr |
|-------------------------------------|--------------|--------------------------|-------------|
| 2 (51) | Yes | 1/2 (13) | 3/4 |
| 2 (51) | No | 1/2 (13) | 1 |
| 4 (102) | Yes | 1/2 (13) | 0 |
| 4 (102) | No | 1/2 (13) | 3/4 |
| 4 (102) | Yes | 1 (25) | 1/2 |
| 4 (102) | No | 1 (25) | 1-1/2 |
| 6 (152) | Yes | 1 (25) | 0 |
| 6 (152) | No | 1 (25) | 1 |

3M COMPANY – CP 25WB+

*Bearing the UL Classification Marking

Reprinted from the Online Certifications Directory with permission from Underwriters Laboratories Inc.

Copyright © 2011 Underwriters Laboratories Inc.®



System No. C-AJ-0060

March 05, 2007

F Rating – 3 Hr

T Ratings – 1, 2 and 3 Hr (See Item 2)

L Rating At Ambient – Less Than 1 CFM/sq ft

L Rating At 400 F – 2 CFM/sq ft

W Rating – Class 1

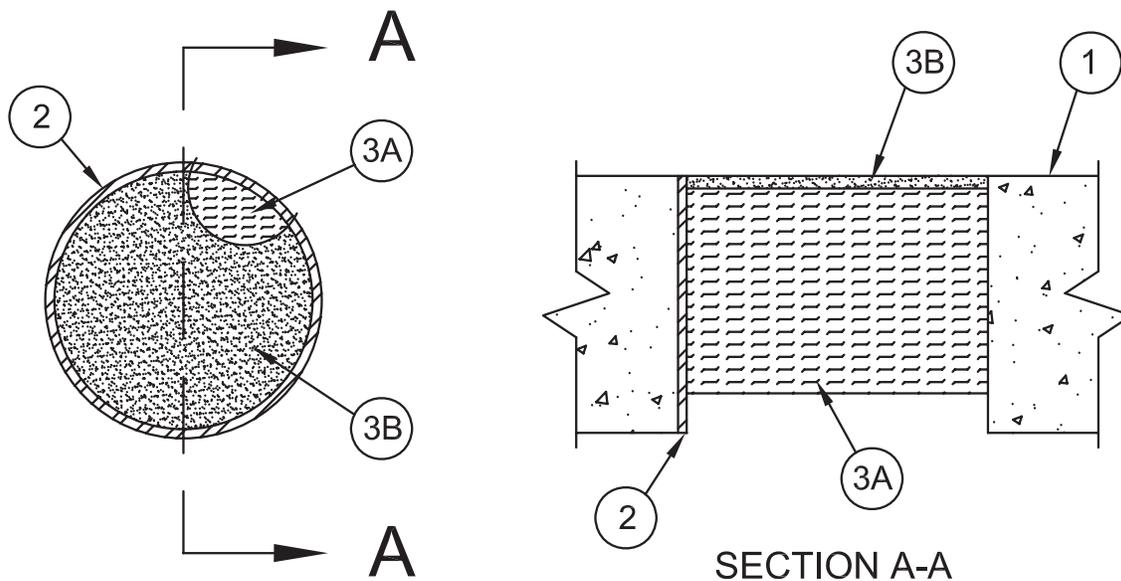

- Floor or Wall Assembly** – Min 4-1/2 in. (114 mm) thick reinforced light-weight or normal weight (100-150 pcf or 1600-2400 kg/m³) concrete. Wall may also be constructed of any UL Classified **Concrete Blocks***. Max diam of opening is 6 in. (152 mm).
See **Concrete Blocks (CAZT)** category in the Fire Resistance Directory for names of manufacturers.
- Sleeves (Optional)** – The following sleeves may be used:
 - Metallic Sleeve** – Nom 6 in. (152 mm) diam (or smaller) Schedule 10 (or heavier) steel pipe sleeve cast or grouted into floor or wall assembly, flush with floor or wall surfaces. As an alternate, nom 6 in. (152 mm) diam (or smaller) sleeve fabricated from nom 0.019 in. (0.48 mm) thick galv steel cast or grouted into floor or wall assembly flush with floor or wall surfaces. **T Rating is 1 Hr when metallic sleeve is used.**
 - Nonmetallic Sleeve** – Nom 6 in. (152 mm) diam (or smaller) Schedule 40 polyvinyl chloride (PVC) pipe cast or grouted into floor or wall assembly, flush with floor or wall surfaces. **T Rating is 2 Hr when PVC sleeve is used.**
T Rating is 3 Hr when no sleeve is used.
- Firestop System** – The firestop system shall consist of the following:
 - Packing Material** – Min 3-3/4 in. (95 mm) thickness of min 4 pcf (64 kg/m³) mineral wool batt insulation firmly packed into opening as a permanent form so that the width of the wool is compressed at least 50 percent. Packing material to be recessed from top surface of floor or from both surfaces of wall as required to accommodate the required thickness of fill material.
 - Fill, Void or Cavity Material* – Sealant** – Min 1/4 in. (6 mm) thickness of sealant applied within the annulus, flush with the top surface of floor or with both surfaces of wall. Sealant to lap onto top surface of concrete floor to attain W Rating.
3M COMPANY – FB-1000 NS (floors or walls) or FB-1003 SL

*Bearing the UL Classification Mark

Reprinted from the Online Certifications Directory with permission from Underwriters Laboratories Inc.

Copyright © 2010 Underwriters Laboratories Inc.®



Through Penetrations

Blanks

0000 Series

Concrete

CAJ

System No. C-AJ-0084

September 20, 2011

ANSI/UL1479 (ASTM E814)

F Rating – 3 Hr

T Rating – 2-1/2 Hr

L Rating At Ambient – 2 CFM/sq ft

L Rating At 400 F – 2 CFM/sq ft

CAN/ULC S115

F Rating – 3 Hr

FT Rating – 2-1/2 Hr

FH Rating – 3 Hr

FTH Rating – 2-1/2 Hr

L Rating At Ambient – 2 CFM/sq ft

L Rating At 400 F – 2 CFM/sq ft

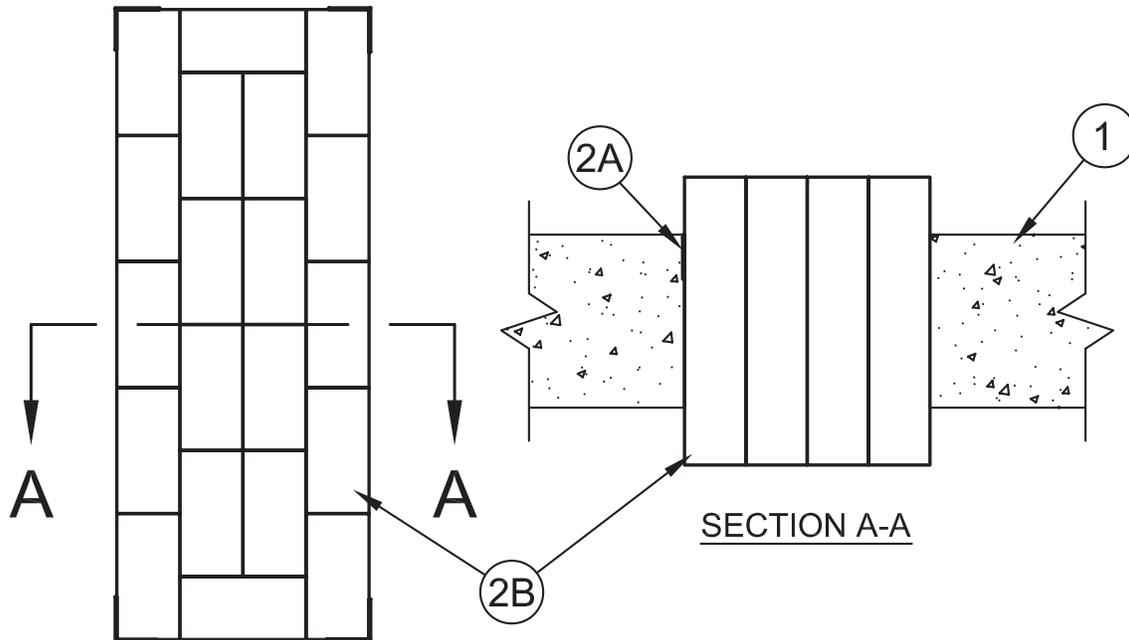

1. **Floor or Wall Assembly** – Min 4-1/2 in. (114 mm) thick reinforced lightweight or normal weight (100-150 pcf or 1600-2400 kg/m³) concrete. Wall may also be constructed of any UL Classified **Concrete Blocks***. Max area of opening is 360 in² (0.23 m²), with a max dimension of 30 in. (762 mm)
See **Concrete Blocks (CAZT)** category in the Fire Resistance Directory for names of manufacturers.
2. **Firestop System** – The firestop system shall consist of the following:
 - A. **Fill Void or Cavity Material*** – **Putty** – Min 1 in. (25 mm) thickness, min 1/2 in. (13 mm) width of putty applied within annulus at all corners of opening and extending a min 1 in. (25 mm) in both directions from each corner, flush with top surface of floor or both surfaces of wall.
3M COMPANY – MPS-2+
 - B. **Fill Void or Cavity Material*** – **Pillows** – Max 9 in. (229 mm) long by 6 in. (152 mm) wide by 2 and 3 in. (51 and 76 mm) thick plastic covered pillows tightly-packed into opening. Pillows installed with 9 in. (229 mm) dimension projecting through floor or wall and centered within the opening.
3M COMPANY – Fire Barrier Pillow or Fire Barrier Self-Locking Pillows

*Bearing the UL Classification Mark

Reprinted from the Online Certifications Directory with permission from Underwriters Laboratories Inc.
Copyright © 2011 Underwriters Laboratories Inc.®





UL System No. C-AJ-0091
XHEZ - Through-penetration Firestop Systems
XHEZ7 - Through-penetration Firestop Systems Certified for Canada

May 08, 2015

| ANSI/UL1479 (ASTM E814) | CAN/ULC S115 |
|---|---|
| F Rating — 2 Hr | F Rating — 2 Hr |
| T Ratings — 0 and 1 Hr (See Item 2) | FT Ratings — 0 and 1 Hr (See Item 2) |
| L Rating At Ambient — 2 CFM/sq ft | FH Rating — 2 Hr |
| L Rating At 400 F — less than 1 CFM/sq ft | FTH Ratings — 0 and 1 Hr (See Item 2) |
| | L Rating At Ambient — 2 CFM/sq ft |
| | L Rating At 400 F — less than 1 CFM/sq ft |

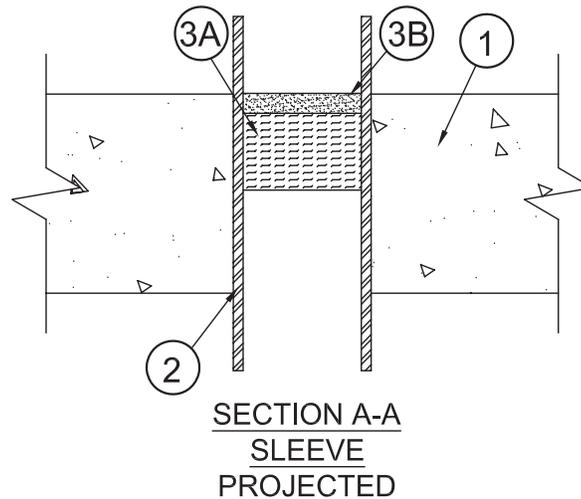
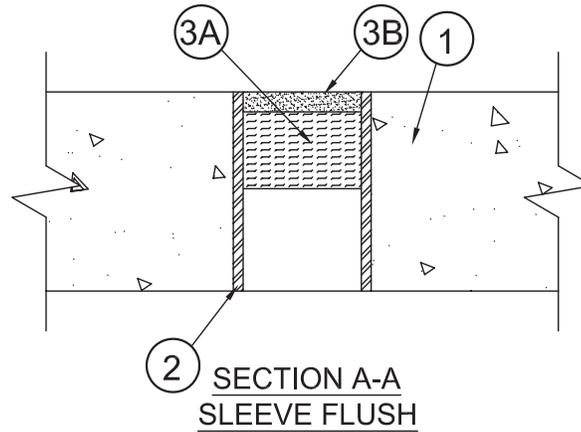
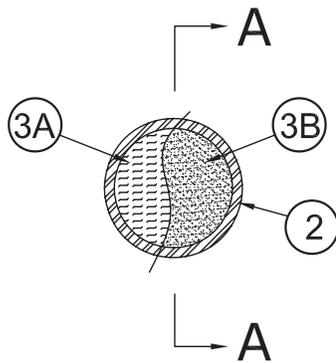

1. Floor or Wall Assembly – Min 4-1/2 in. (144 mm) thick reinforced lightweight or normal weight (100-150 pcf or 1600-2400 kg/m³) concrete floors or min 3 in. (76 mm) thick reinforced lightweight or normal weight concrete walls. Wall may also be constructed of any UL Classified **Concrete Blocks***. Max diam of opening is 6 in. (152 mm).

See **Concrete Blocks** (CAZT) category in the Fire Resistance Directory for names of manufacturers.

2. Steel Sleeve – (Optional) — Nom 6 in. (152 mm) (or smaller) Schedule 10 (or heavier) steel sleeve cast or grouted into floor or wall assembly. Steel sleeve may be installed flush (Configuration A) or may project max 2 in. (51 mm) beyond the floor or wall surfaces (Configuration B).

The T, FT and FTH Rating of the firestop system is 1 hr except that when the sleeve projects beyond either or both faces of the wall or floor, the T Rating is 0 hr.

2A. Steel Sleeve – (Optional) - As an alternate to Item 2, nom 6 in. (152 mm) diam (or smaller) sleeve fabricated from nom 0.019 in. (0.48 mm) thick galv steel cast or grouted into floor or wall assembly flush with floor or wall surfaces (Configuration A).

3. Firestop System – The details of the firestop system shall be as follows:

A. Packing Material – Min 2 in. (51 mm) thickness of min 4 pcf (64 kg/m³) mineral wool batt insulation firmly packed into opening as a permanent form. Packing material to be recessed from top surface of floor or from both surfaces of wall to accommodate the required thickness of fill material.

A1. Forming Material* – As an alternate to the packing material in Item 3A, nom 4 in. (102 mm) wide strips of min 1/2 in (13 mm) thick compressible mat to be folded in half, lengthwise, and tightly-rolled into a solid 2 in. (51 mm) high cylinder having a diameter greater than the inside diameter of the opening and installed edge-first into the opening. Top of forming material to be recessed from top surface of floor or from both surfaces of wall to accommodate the required thickness of fill material.

3M COMPANY – Fire Barrier Packing Material

B. Fill Void or Cavity Materials* - Caulk – Min 1/2 in. (13 mm) thickness of fill material applied within the annulus, flush with top surface of floor or with both surfaces of wall.

3M COMPANY – FB-3000 WT, IC 15WB+ or CP 25WB+ caulk



*Indicates such products shall bear the UL or cUL Certification Mark for jurisdictions employing the UL or cUL Certification (such as Canada), respectively.

System No. C-AJ-0118

February 26, 2008

F Rating – 2 Hr

T Ratings – 1/2 and 1-1/2 Hr (See Item 1)

L Rating At Ambient – 23 CFM/sq ft.

L Rating At 400 F – 4 CFM/sq ft.

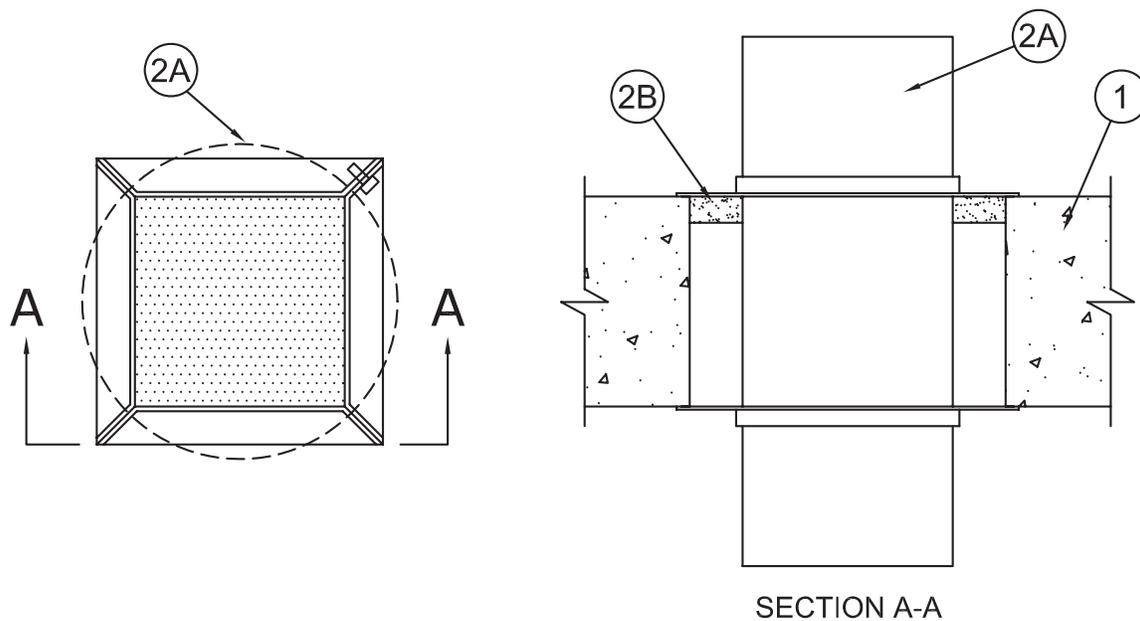

1. **Floor or Wall Assembly** – Min 2-1/2 in. (64 mm) thick reinforced lightweight or normal weight (100-150 pcf or 1600-2400 kg/m³) concrete. Wall may also be constructed of any UL Classified **Concrete Blocks***. Max diam of opening is 6 in. (152 mm) for square devices, 2-1/2 in. (64 mm) for 2 in. round devices and 4-1/2 in. (114 mm) for 4 in. (102 mm) round devices. **When thickness of floor or wall assembly is less than 4-1/2 in. (114 mm), T Rating is 1/2 Hr.**

See **Concrete Blocks (CAZT)** category in Fire Resistance Directory for names of manufacturers.

2. **Firestop System** – The firestop system shall consist of the following:
 - A. **Firestop Device*** – Nom 2-1/2 by 2-1/2 by 10 in. (64 by 64 by 254 mm), 4 by 4 by 10 in. (102 by 102 by 254 mm), 2 in. (51 mm) diam by 10 in. (254 mm) or 4 in. (102 mm) diam by 10 in. (254 mm) powdered coated steel transit incorporating internal intumescent material, foam plugs and mounting flanges. Firestop device to be centered within opening and installed with its ends projecting an equal distance beyond each surface of the floor or wall assembly in accordance with the accompanying installation instructions. Firestop device secured in place by means of fill material, (Item 2B) and steel split mounting flanges sized to accommodate the firestop device. Steel split mounting flanges installed on both sides of floor or wall after installation of fill material and secured to together with supplied steel set screws. Nom 1 in. (25 mm) thick foam plugs installed flush with each end of device on both sides of floor or wall assembly.
3M COMPANY – 3M Fire Barrier Pass-Through Device
 - B. **Fill, Void or Cavity Materials*** – **Caulk or Putty** – Min 1 in. (25 mm) thickness of fill material applied within the annulus between the outer perimeter of firestop device and periphery of opening prior to the installation of the mounting flanges, flush with top surface of floor or with both surfaces of wall. As an option, foam plugs may be recessed into device and the recess filled with putty or caulk flush with the ends of the device.
3M COMPANY – Moldable Putty+, CP 25WB+, IC 15WB+, 3000 WT

*Bearing the UL Classification Mark

Reprinted from the Online Certifications Directory with permission from Underwriters Laboratories Inc.

Copyright © 2010 Underwriters Laboratories Inc.®



System No. C-AJ-0131

October 07, 2010

F Rating – 3 Hr

T Rating – 2 Hr

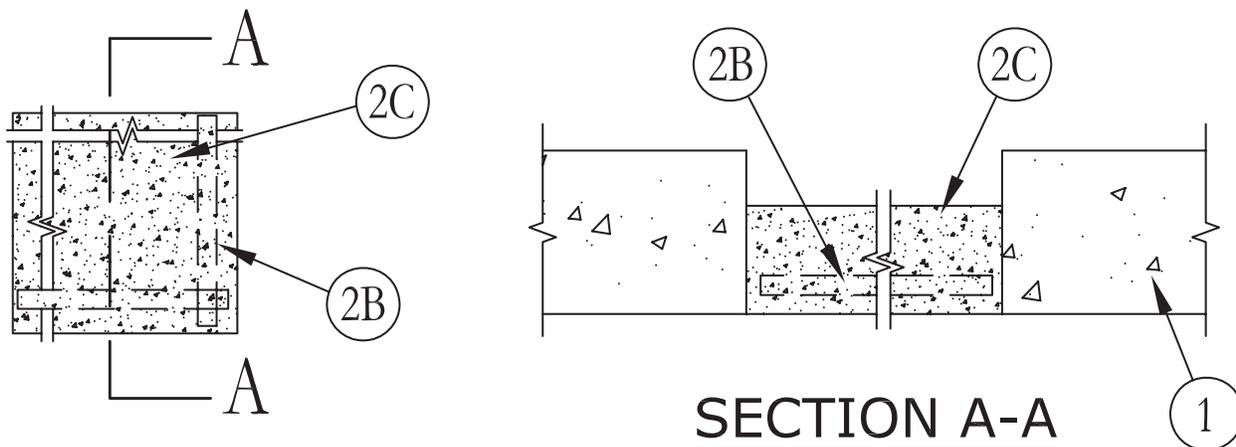

1. **Floor or Wall Assembly** – Min 4-1/2 in. (114 mm) thick reinforced lightweight or normal weight (100-150 pcf) or (1600-2400 kg/m³) concrete. Wall may also be constructed of any UL Classified **Concrete Blocks***. Max area of opening is 1296 sq in. with max dimension of 36 in. (914 mm)

See **Concrete Blocks (CAZT)** category in the Fire Resistance Directory for names of manufacturers.

2. **Firestop System** – The firestop system shall consist of the following:
 - A. **Forms** – (Not Shown) – Used as a form to prevent leakage of the fill material during installation on bottom surface of floor or both surfaces of wall. Forms to be a rigid sheet material, positioned as required to accommodate the required thickness of fill material. Forms to be removed after fill material has cured.
 - B. **Reinforcement** – A grid of No. 4 (1/2 in., 13mm) diam steel rebar to be inserted into the with a max spacing of 12 in. (306 mm) O.C. prior to the application of the mortar (Item 2C). The steel rebar to be secured together with steel tie wire and installed at mid depth of the mortar with masonry anchors secured to the sides of the opening.
 - C. **Fill, Void or Cavity Materials*** – **Mortar** – Min 3 in. (76 mm) thickness of fill material applied within the annulus, flush with bottom surface of floor or with both surfaces of wall. Mortar is mixed in accordance with the fill material manufacturer's installation instructions.

3M COMPANY

3M FIRE PROTECTION PRODUCTS – 3M Fire Barrier Mortar

*Bearing the UL Classification Mark

Reprinted from the Online Certifications Directory with permission from Underwriters Laboratories Inc.
Copyright © 2011 Underwriters Laboratories Inc.®



Through Penetrations

Blanks

0000 Series

Concrete

CAJ

System No. C-AJ-0134

October 11, 2011

ANSI/UL1479 (ASTM E814)

F Rating – 3 Hr

T Rating – 0 Hr

CAN/ULC S115

F Rating – 3 Hr

FT Rating – 0 Hr

FH Rating – 3 Hr

FTH Rating – 0 Hr

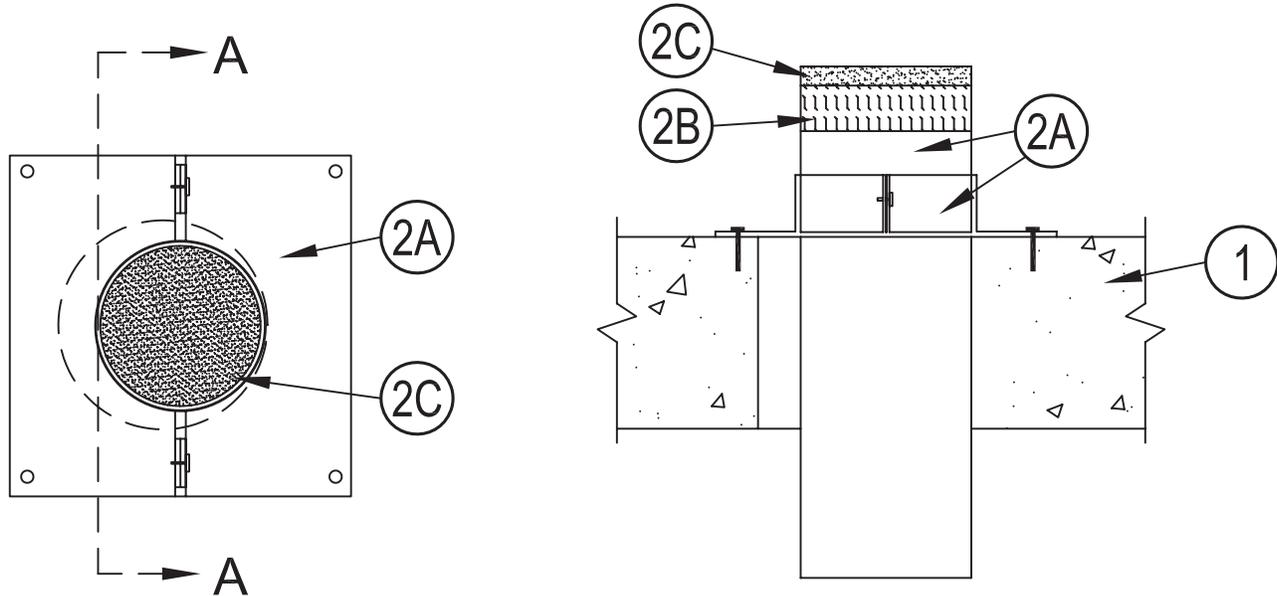
**SECTION A-A**

1. **Floor or Wall Assembly** – Min 4-1/2 in. (144 mm) thick reinforced lightweight or normal weight (100-150 pcf or 1600-2400 kg/m³) concrete. Floor assembly may also be constructed of any min 6 in. (152 mm) thick UL Classified hollow-core **Precast Concrete Units***. Wall may also be constructed of any UL Classified **Concrete Blocks***. Max diam of opening 6 in. (152 mm).
See **Concrete Blocks (CAZT)** and **Precast Concrete Units (CFTV)** categories in Fire Resistance Directory for names of manufacturers.
2. **Firestop System** – The firestop system shall consist of the following:
 - A. **Firestop Device*** – One firestop device module centered within the opening. The firestop device module consists of a 12 in. (305 mm) long galv steel split sleeve with galv steel flange plates. Firestop device module to be installed in accordance with the accompanying installation instructions. The space between the firestop device module and the periphery of the opening shall be min 0 in. (0 mm, point contact) to max 1 in. (25 mm). Firestop device module secured in place by means of steel flange plates sized to accommodate the firestop device module. Steel flange plate installed on top side of concrete floor or both sides of a wall or hollow core concrete floor and secured around firestop device module with steel screws. The steel flange plate is then secured to both sides of the floor or wall assembly with masonry screws. The firestop device module is to be installed with its ends projecting an equal distance beyond each surface of the floor or wall assembly.
3M COMPANY
3M FIRE PROTECTION PRODUCTS – DT 100, DT 200 or DT 400 putty sleeve kit
 - B. **Packing Material** – Min 2 in. (51 mm) thickness of min 4 pcf (64 kg/m³) mineral wool batt insulation firmly packed into sleeve (Item 3A) as a permanent form. Packing material to be recessed from top end of sleeve in floor or both ends of sleeve in walls to accommodate the required thickness of fill material. The use of packing material is optional for DT 100 and DT 200 assemblies in walls.
 - C. **Fill, Void or Cavity Material** – After the installation of the packing material (Item 2B, if required), the supplied putty material is to be packed into end(s) of the firestop device. A min 1 in. (25mm) depth of the putty material is required at each end of device on the wall assemblies and the top side for floor assemblies.
3M COMPANY
3M FIRE PROTECTION PRODUCTS – 3M Fire Barrier MP+ Putty stix

*Bearing the UL Classification Mark

Reprinted from the Online Certifications Directory with permission from UL

© 2013 UL LLC



System No. C-AJ-0139

February 28, 2013

ANSI/UL1479 (ASTM E814)

F Rating – 3 Hr

T Rating – 2 Hr

CAN/ULC S115

F Rating – 3 Hr

FT Rating – 2 Hr

FH Rating – 3 Hr

FTH Rating – 2 Hr

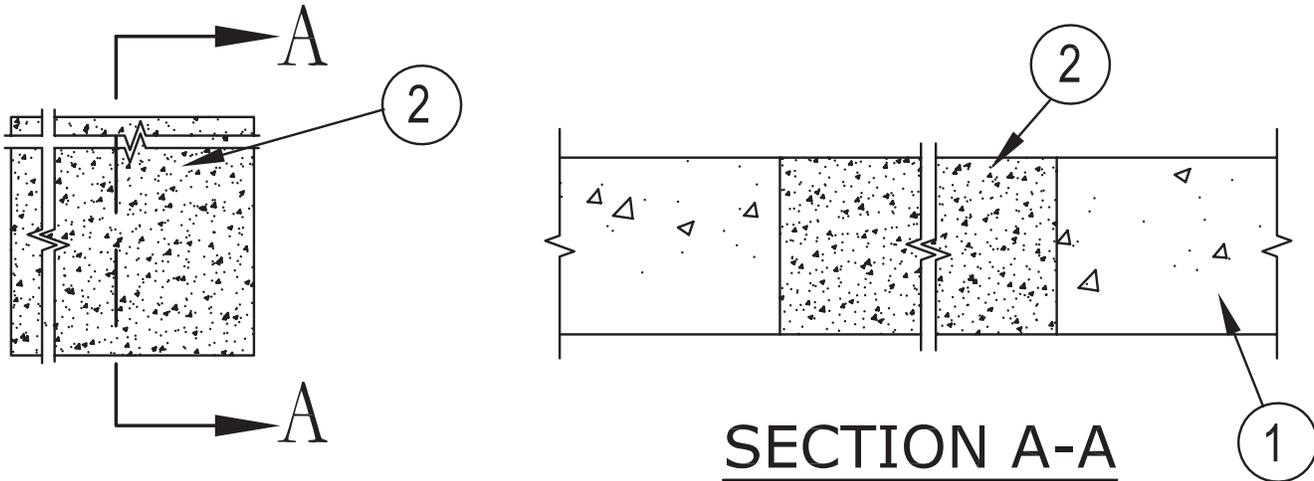

1. **Floor or Wall Assembly** – Min 2-1/2 in. (64 mm) thick reinforced lightweight or normal weight (100-150 pcf or 1600-2400 kg/m³) concrete. Max area of opening is 1728 in² (1.114 m²) with max dimension of 48 in. (1219 mm).
2. **Firestop System** – The firestop system shall consist of the following:
 - A. **Forms** – (Not Shown) – Used as a form to prevent leakage of the fill material during installation on bottom surface of floor or both surfaces of wall. Forms to be a rigid sheet material, positioned as required to accommodate the required thickness of fill material. Forms to be removed after fill material has cured.
 - B. **Fill, Void or Cavity Materials* – Mortar** – Min 2-1/2 in. (64 mm) thickness of fill material applied within the annulus, flush with bottom surface of floor or both surfaces of wall. Mortar is mixed in accordance with the fill material manufacturer’s installation instructions.

3M COMPANY

3M FIRE PROTECTION PRODUCTS – 3M Fire Barrier Mortar

*Bearing the UL Classification Mark

Reprinted from the Online Certifications Directory with permission from UL

© 2013 UL LLC



System No. C-AJ-0140

August 01, 2013

ANSI/UL1479 (ASTM E814)

F Ratings – 2 Hr

T Rating – 3/4 Hr

L Rating at Ambient - Less than 1 CFM/sq ft

L Rating at 400 F - Less than 1 CFM/sq ft

CAN/ULC S115

F Ratings – 2 Hr

FT Rating – 3/4 Hr

FH Ratings – 2 Hr

FTH Rating – 3/4 Hr

L Rating at Ambient - Less than 1 CFM/sq ft

L Rating at 400 F - Less than 1 CFM/sq ft

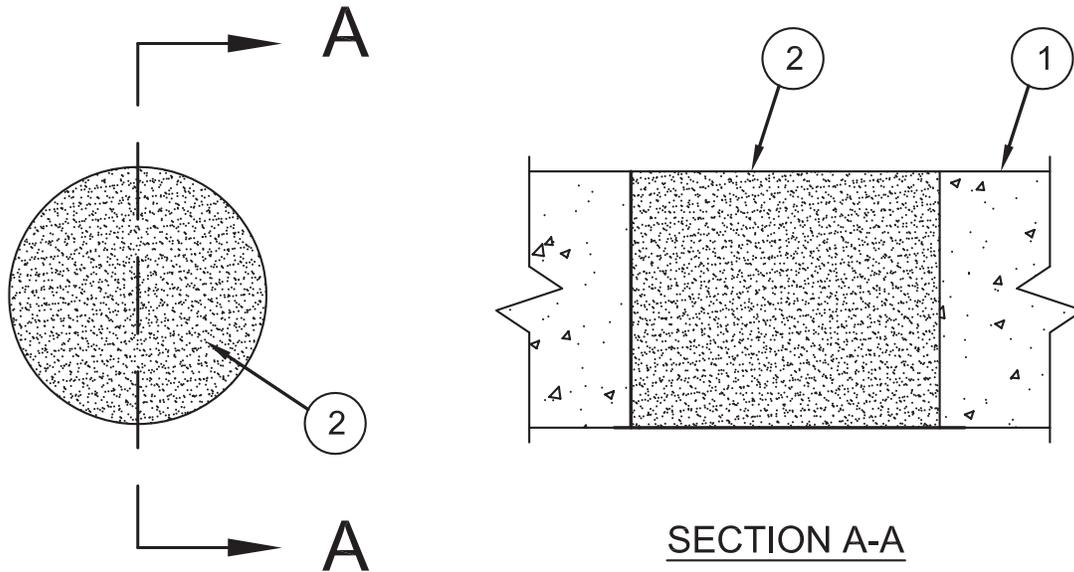

1. **Floor or Wall Assembly** – Min 2-1/2 in. (64 mm) thick lightweight or normal weight (100-150 pcf or 1600-2400 kg/m³) concrete. Max diam of opening is 8 in. (203 mm).
2. **Fill, Void or Cavity Material*** – **Foam** – Min 2-1/2 in. (64 mm) thickness of fill material applied within the annulus, flush with top surface of floor or both surfaces of wall.

3M COMPANY – Fire Barrier Rated Foam, FIP 1-Step

*Bearing the UL Classification Mark

Reprinted from the Online Certifications Directory with permission from UL
© 2013 UL LLC



System No. C-AJ-0153

March 04, 2016

| ANSI/UL1479 (ASTM E814) | CAN/ULC S115 |
|-------------------------|-------------------|
| F Rating — 2 Hr | F Rating — 2 Hr |
| T Rating — 2 Hr | FT Rating — 2 Hr |
| | FH Rating — 2 Hr |
| | FTH Rating — 2 Hr |

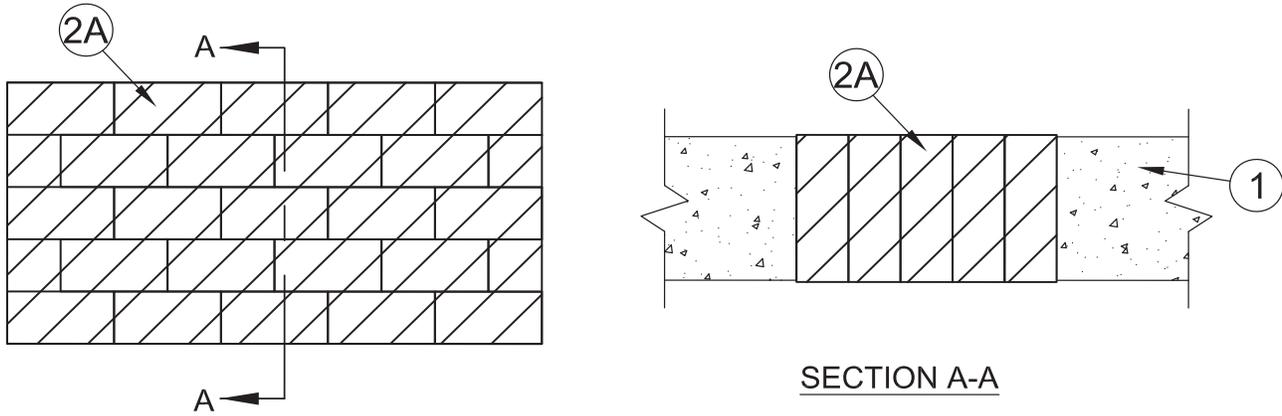

1. **Floor or Wall Assembly** — Min 4-1/2 in. (114 mm) thick reinforced lightweight or normal weight (100-150 pcf or 1600-2400 kg/m³) concrete. Wall may also be constructed of any UL Classified Concrete Blocks*. Max area of opening is 384 in.² (2477 cm²) with a max dimension of 32 in. (813 mm).

See **Concrete Blocks (CAZT)** category in the Fire Resistance Directory for names of manufacturers.

2. **Firestop System** — The firestop system shall consist of the following:

A. **Fill, Void or Cavity Material*** — Blocks installed with 5 in. (127 mm) dimension projecting through opening flush with bottom surface of floor or centered in wall. Blocks to be firmly packed to fill the opening area.

3M COMPANY - 3M™ Fire Barrier Block B258, 3M™ Fire Barrier Plank PK39

B. **Fill, Void or Cavity Material*** — (**Not shown**) — Fill material to be forced between blocks and periphery of opening to the max extent possible on top surface of floor or both surfaces of wall.

3M COMPANY - 3MTM Fire Barrier Rated Foam, FIP 1-Step

* Indicates such products shall bear the UL or cUL Certification Mark for jurisdictions employing the UL or cUL Certification (such as Canada), respectively.



Through Penetrations

Blanks

0000 Series

Concrete

CAJ

System No. C-AJ-0154

March 04, 2016

| ANSI/UL1479 (ASTM E814) | CAN/ULC S115 |
|-------------------------|-----------------------|
| F Rating — 2 Hr | F Rating — 2 Hr |
| T Rating — 1-1/4 Hr | FT Rating — 1-1/4 Hr |
| | FH Rating — 2 Hr |
| | FTH Rating — 1-1/4 Hr |

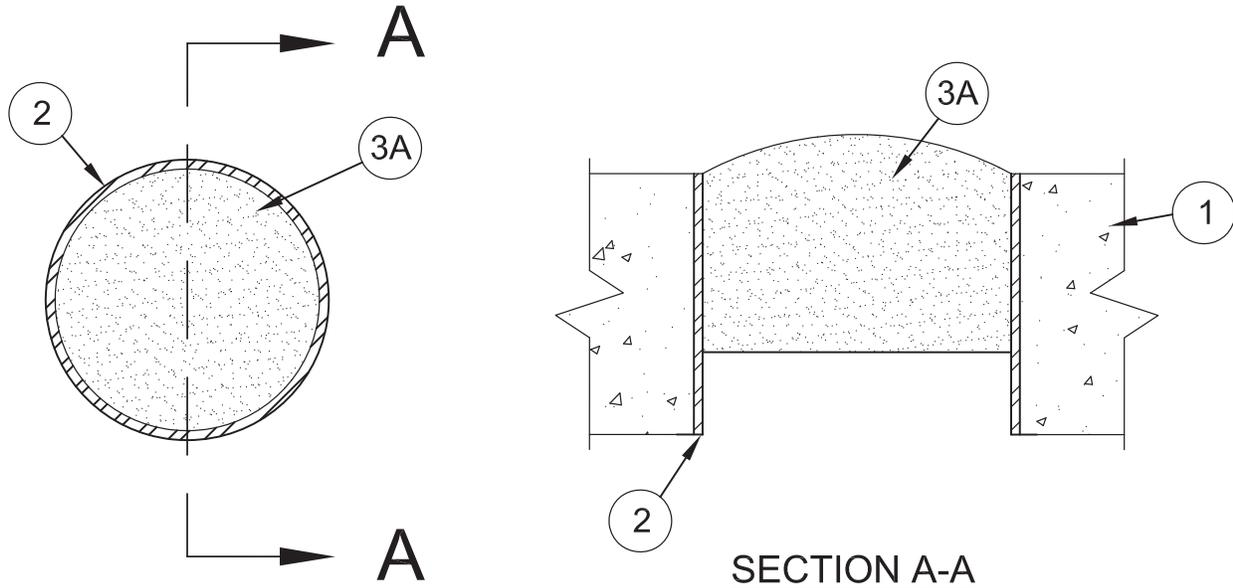

1. **Floor or Wall Assembly** — Min 4-1/2 in. (114 mm) thick reinforced lightweight or normal weight (100-150 pcf or 1600-2400 kg/m³) concrete. Wall may also be constructed of any UL Classified Concrete Blocks*. Max diameter of opening is nom 4-1/2 in. (114 mm).
See **Concrete Blocks (CAZT)** category in the Fire Resistance Directory for names of manufacturers.
2. **Metallic Sleeve** — (Optional) — Nom 2 or 4-1/2 in. (51 or 114 mm) diameter Schedule 5 (or heavier) steel sleeve or rigid steel conduit or electrical metallic tubing cast or grouted into floor or wall flush with floor or wall surfaces.
3. **Firestop System** — The firestop system shall consist of the following:
 - A. **Fill, Void or Cavity Material*** — Plug sized for the steel sleeve or opening diameter to be friction-fitted within the sleeve or opening such that the outer circumference of the dome-shaped plug is flush with the top surface of the floor or with both surfaces of the wall.

3M COMPANY 3M FIRE PROTECTION PRODUCTS — 3M™ Fire Barrier Plug PLG2, 3M™ Fire Barrier Plug PLG4

* Indicates such products shall bear the UL or cUL Certification Mark for jurisdictions employing the UL or cUL Certification (such as Canada), respectively.



Through Penetrations

Blanks

0000 Series

Concrete

CAJ

UL System No. C-AJ-0163

January 26, 2017

ANSI/UL1479 (ASTM E814)

F Rating – 2 Hr
 T Rating – 2 Hr
 L Rating At Ambient – Less Than 1 CFM/ft²
 L Rating At 400°F – 1 CFM/ft² and Less Than 1 CFM/ft² (See Item 2)
 W Rating – Class 1 (see Item 1)

CAN/ULC S115

F Rating – 2 Hr
 FT Rating – 2 Hr
 FH Rating – 2 Hr
 FTH Rating – 2 Hr
 L Rating At Ambient – Less Than 5.08 L/s/m²
 L Rating At 400°F – 5.08 L/s/m² and Less Than 5.08 L/s/m² (See Item 2)

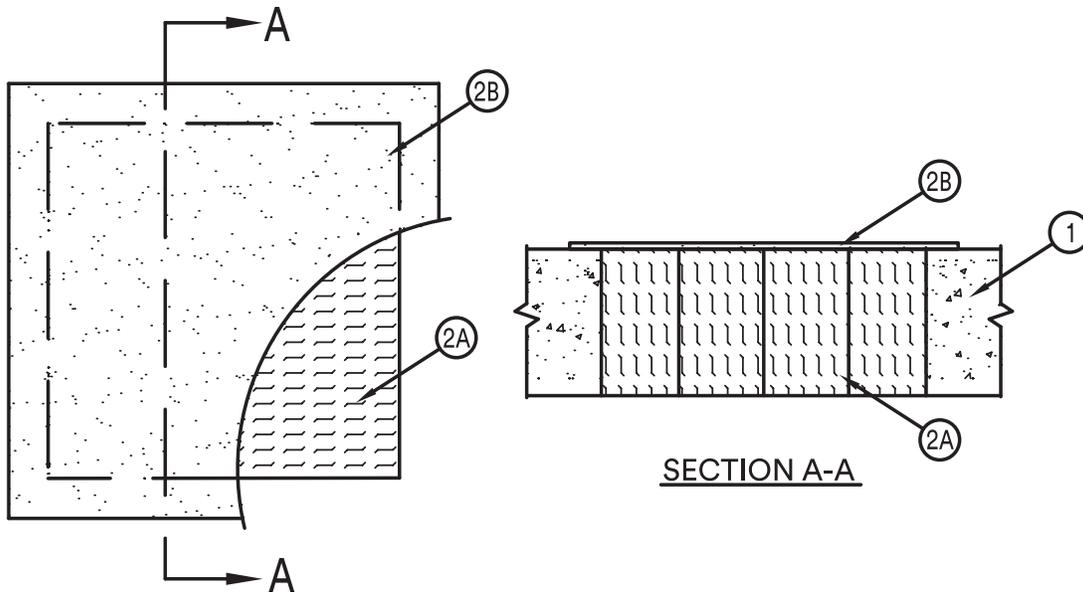

1. **Floor or Wall Assembly** – Min 4-1/2 in. (114 mm) thick reinforced lightweight or normal weight (100-150 pcf or 1600-2400 kg/m³) structural concrete floor or wall. Wall may also be constructed of any UL Classified solid **Concrete Blocks***. Max area of opening to be 64 in² (413 cm²) with maximum dimension of 8 in. (203 mm). **W Rating applies to floor installations only.**
 See **Concrete Blocks** (CAZT) in the Fire Resistance Directory for names of manufacturers.
2. **Firestop System** – The firestop system shall consist of the following:
 - A. **Packing Material** – Min 4-1/2 in. (114 mm) thickness of min 4 pcf (64 kg/m³) mineral wool batt insulation compressed 50 percent into opening as a permanent form. Packing material to be installed flush with top surface of floor or both surfaces of wall assembly.
 - B. **Fill, Void or Cavity Material*** – Min 1/10 in. (2.5 mm) wet (and dry) of fill material sprayed or brushed on top surface of floor to completely cover mineral wool and overlap a min of 1/2 in. (13 mm) onto top surface of concrete floor or both surfaces of wall.
 - 3M COMPANY** – 3M Fire Barrier Watertight Spray
 - B1. Fill, Void or Cavity Material* – Tape** – As an alternate to Item 2B, Tape cut to size and press applied to top surface of floor or both surfaces of wall to completely cover mineral wool and overlap a min of 1 in. (25 mm) onto the concrete floor or wall around periphery of opening.
 - 3M COMPANY** – 3M Fire and Water Barrier Tape

When Item 2B (Spray) is used, the L Rating at 400°F is less than 1 CFM/ft² (5.08 L/s/m²). When Item 2B1 (Tape) is used, the L Rating at 400°F is 1 CFM/ft² (5.08 L/s/m²).

*Indicates such products shall bear the UL or cUL Certification Mark for jurisdictions employing the UL or cUL Certification (such as Canada), respectively. 

Reprinted from the Online Certifications Directory with permission from UL©

Through Penetrations

Blanks

0000 Series

Concrete

CAJ

System No. F-A-0004

September 04, 2004

F Rating – 2 Hr

T Rating – 1/4 Hr

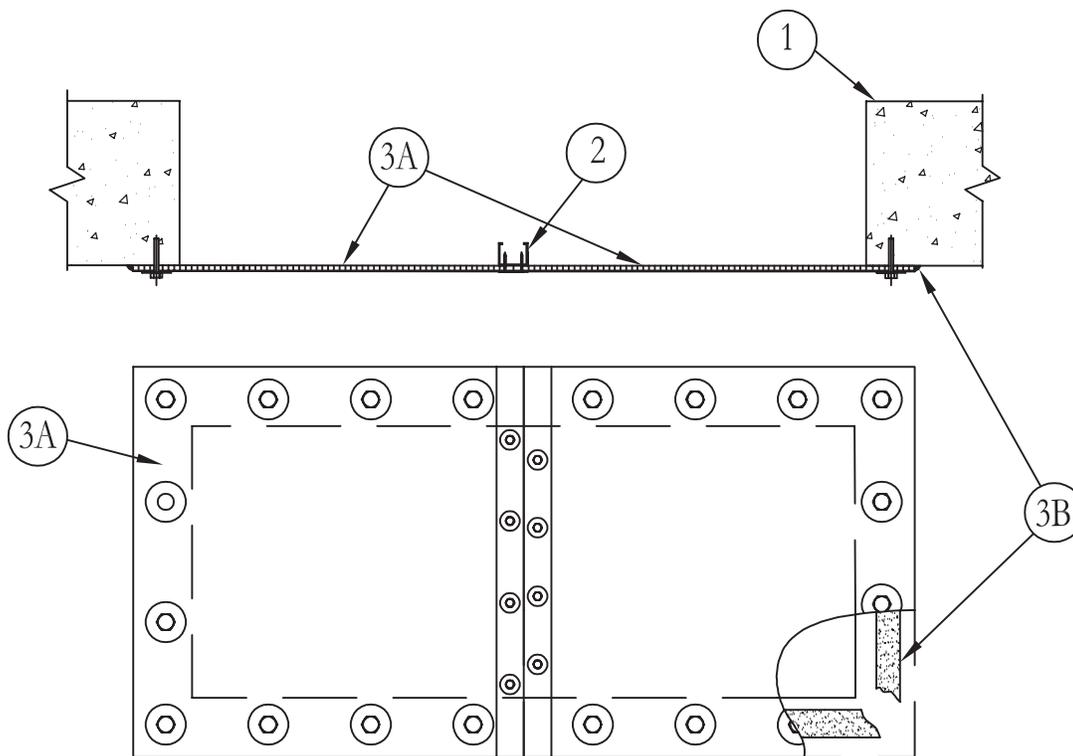

- 1. Floor Assembly** – Min 4-1/2 in. thick reinforced lightweight or normal weight (100-150 pcf) concrete. Max area of opening 3 sq ft. with max dimension of 36 in.
- 2. Support Channel** – Support channel shall be installed flush with bottom surface of floor, midway in opening. Support channel not required for openings with a max dimension of 18 in. or less. Support channels to be min 1-5/8 by 1-5/8 in. and formed of min 0.093 in. thick (No. 12 gauge) painted or galv steel. Ends of steel channel bolted or welded to steel angles anchored to inside walls of through opening using min 1/4 in. diam by 1-1/2 in. long steel expansion bolts, or equivalent, in conjunction with steel nuts and washers.
- 3. Firestop System** – The details of the firestop system shall be as follows:
 - A. Fill, Void or Cavity Materials* – Intumescent Sheet** – Rigid aluminum foil-faced sheets with galv steel sheet backer. Sheet cut to lap a min of 3 in. on the floor surface on all sides of the through opening. Sheets to be installed with the galv steel sheet backer exposed (aluminum foil facing against floor surface). Sheets secured to bottom side of floor assembly using min 1/4 in. diam by 1-1/2 in. long steel expansion bolts, or equivalent, in conjunction with steel nuts and washers. Max spacing of sheet fasteners not to exceed 4 in. OC. Intumescent sheet secured to steel support channels (Item 2) with steel sheet metal screws in conjunction with min 1-1/4 in. diam steel fender washers spaced max 3 in. OC. When support channel is used beneath butted seam of intumescent sheets, fasteners spaced max 3 in. OC on each side of butted seam.
3M COMPANY – CS-195+
 - B. Fill, Void or Cavity Materials* – Caulk or Sealant** – Min 1/2 in. diam continuous bead applied to edge of intumescent sheet at its interface with surface of floor around entire perimeter of through opening.
3M COMPANY – CP 25WB+ caulk or FB-3000 WT sealant.

*Bearing the UL Classification Marking

Reprinted from the Online Certifications Directory with permission from Underwriters Laboratories Inc.
Copyright © 2010 Underwriters Laboratories Inc.®



Through Penetrations

Blanks

0000 Series

Concrete

FA

System No. F-A-0011

January 09, 2007

F Rating – 3 Hr

T Ratings – 1-1/4 and 3 Hr (See Item 2A)

L Rating at Ambient – Less Than 1 CFM/sq ft (See Item 3A)

L Rating at 400° F – Less Than 1 CFM/sq ft (See Item 3A)

W Rating – Class 1 (See Item 3A)

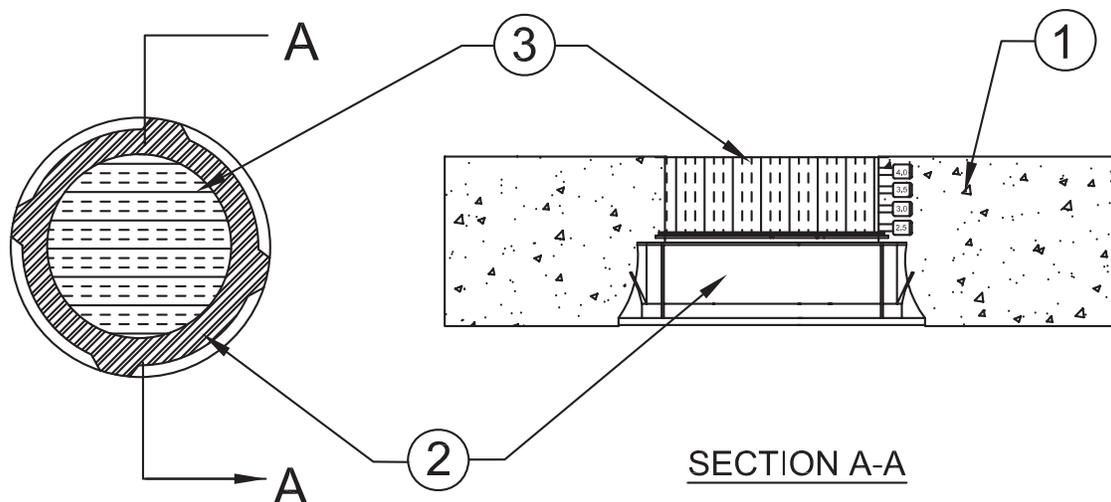

1. **Floor Assembly** – Min 4-1/2 in. (114 mm) thick reinforced lightweight or normal weight (100-150 pcf or 1600 - 2400 kg/m³) concrete.
2. **Firestop Device*** – Cast in place firestop device permanently embedded during concrete placement or grouted in concrete assembly in accordance with accompanying installation instructions. The device may be trimmed flush with top surface of floor or may project up to a max of 3-1/2 in. (89 mm) above top surface of floor.

3M COMPANY – 3M Fire Barrier Cast-In Device 2MCID, 3MCID, 4MCID

T Rating is 3 Hr for 2MCID. T Rating is 1-1/4 Hr for 3MCID and 4MCID.

- 2A. **Firestop Device – Height Adapter*** – (Not Shown) - For use in floors greater than 8 in. (203 mm) thick. Adapter snaps onto top of firestop device (Item 2).

3M COMPANY – 3M Fire Barrier Cast-In Device Height Adapter, 2HA, 3HA, 4HA.

3. **Packing Material** – Min 2 in. (51 mm) thick of min 4 pcf (64 kg/m³) mineral wool batt insulation firmly packed within the firestop device, flush with the top surface of floor.

- 3A. **Fill, Void or Cavity Materials – Sealant, Caulk or Putty*** – (Optional, Not Shown) - As an option, the packing material (Item 3) may be reduced in thickness by 1/4 in. (6 mm) to 1/2 in. (13 mm) and recessed from top surface of floor to accommodate a 1/4 in. (6 mm) to 1/2 in. (13 mm) thickness of sealant, caulk or putty, installed within the firestop device, flush with the top surface of floor. For W and L Ratings, sealant is required. For W Rating, a min 1/4 in. (6 mm) bead of sealant is also required at the device/concrete interface on the top surface of the floor.

3M COMPANY – FB-1000 NS sealant, FB-1003 SL sealant, CP 25WB+ caulk, FB-3000 WT sealant, FireDam 150+ caulk, IC 15WB+ caulk or MP+ Stix putty

(Note: W and L Ratings apply only when FB-1000 NS, FB-1003 SL or FB-3000WT sealants are used.)

*Bearing the UL Classification Mark

Reprinted from the Online Certifications Directory with permission from Underwriters Laboratories Inc.
Copyright © 2010 Underwriters Laboratories Inc.®



System No. F-A-0013

January 09, 2007

F Rating – 2 Hr

T Rating – 1/4 Hr

L Rating at Ambient – Less Than 1 CFM/sq ft (See Item 3A)

L Rating at 400° F – Less Than 1 CFM/sq ft (See Item 3A)

W Rating – Class 1 (See Item 3A)

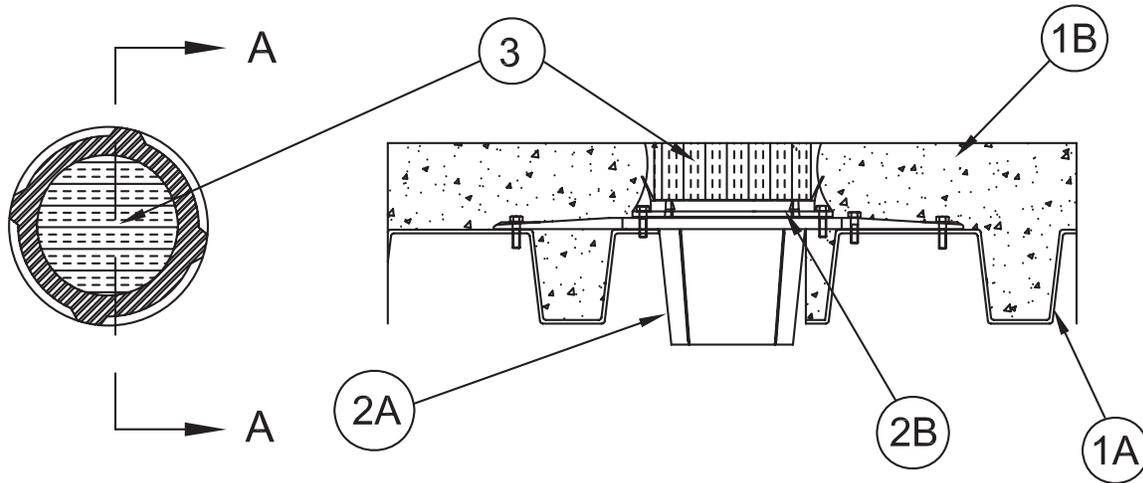

Section A-A

- Floor Assembly** – The fire-rated unprotected concrete and steel floor assembly shall be constructed of the materials and in the manner specified in the individual D900 Series designs in the UL Fire Resistance Directory and as summarized below:
 - Concrete** – Min 2-1/2 in. (64 mm) thick reinforced lightweight or normal weight (100-150 pcf or 1600-2400 kg/m³) concrete.
 - Steel Floor and Form Units*** – Composite or noncomposite max 3 in. (76 mm) deep fluted galv units as specified in the individual Floor-Ceiling design.
- Firestop Devices*** – The firestop devices are cast in place and permanently embedded during concrete placement or grouted in concrete assembly in accordance with accompanying installation instructions.
 - Firestop Device – Metal Deck Adapter*** – Adapter installed through opening in deck and secured with four sheet metal screws to deck in accordance with installation instructions.
3M COMPANY – 3M Fire Barrier Cast-In Device Metal Deck Adapter, 2MDA, 3MDA or 4MDA
 - Firestop Device*** – Snapped into top of metal deck adapter in accordance with accompanying installation instructions. The device may be trimmed flush with top surface of floor or may project up to a max 5-1/2 in. (140 mm) above top surface of floor.
3M COMPANY – 3M Fire Barrier Cast-In Device, 2MCID, 3MCID, 4MCID, 2PCID, 3PCID or 4PCID
- Packing Material** – Min 2 in. (51 mm) thickness of min 4 pcf (64 kg/m³) mineral wool batt insulation firmly packed into the top of the firestop device (Item 2B) as a permanent form, flush with the top surface of the floor.
- 3A. Fill, Void or Cavity Materials – Sealant *** – (Optional, Not Shown) – As an option, the packing material (Item 3) may be reduced in thickness by 1/4 in. (6 mm) to 1/2 in. (13 mm) and recessed from top surface of floor to accommodate a 1/4 in. (6 mm) to 1/2 in. (13 mm) thickness of sealant installed within the firestop device, flush with the top surface of floor. For W and L Ratings, sealant is required. For W Rating, a min 1/4 in. (6 mm) bead of sealant is also required at the device/concrete interface on the top surface of the floor.
3M COMPANY – FB-1000 NS sealant, FB-1003 SL sealant or FB-3000 WT sealant
(**Note:** W and L Ratings apply only when FB-1000 NS, FB-1003 SL or FB-3000 WT sealants are used.)

*Bearing the UL Classification Mark

Reprinted from the Online Certifications Directory with permission from Underwriters Laboratories Inc.

Copyright © 2010 Underwriters Laboratories Inc.®



Through Penetrations

Blanks

0000 Series

Concrete

FA

System No. F-A-0015

January 09, 2007

F Rating – 3 Hr

T Rating – 3 Hr

L Rating at Ambient – Less Than 1 CFM/sq ft (See Item 3A)

L Rating at 400° F – Less Than 1 CFM/sq ft (See Item 3A)

W Rating – Class 1 (See Item 3A)

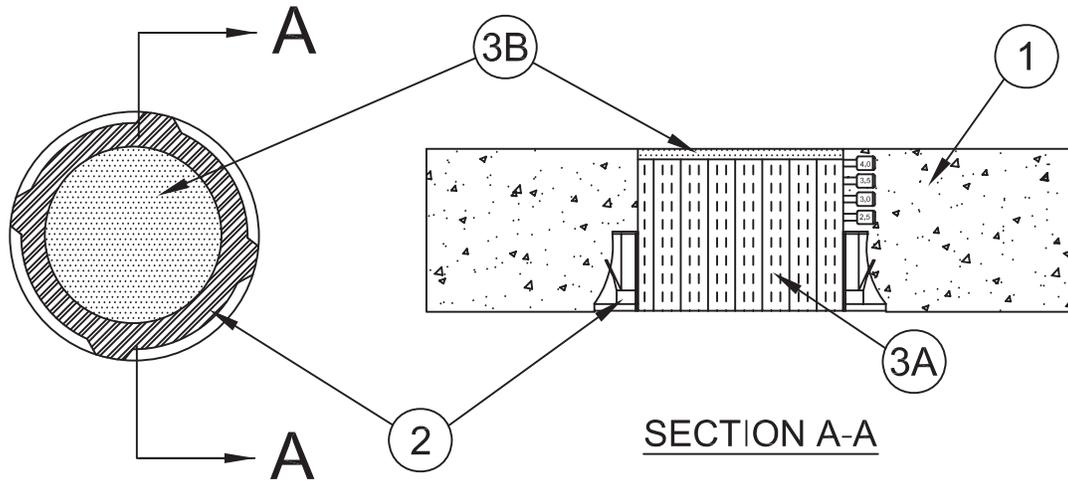

1. **Floor Assembly** – Min 4-1/2 in. (114 mm) thick reinforced lightweight or normal weight (100-150 pcf or 1600-2400 kg/m³) concrete.
2. **Firestop Device*** – Cast in place firestop device permanently embedded during concrete placement or grouted in concrete assembly in accordance with accompanying installation instructions. The device may be trimmed flush with top surface of floor or may project up to a max of 3-1/2 in. (89 mm) above top surface of floor.
3M COMPANY – 3M Fire Barrier Cast-In Device 6MCID or 6PCID
- 2A. **Firestop Device – Height Adapter*** – (Not Shown) - For use in floors greater than 8 in. (203 mm) thick. Adapter snaps onto top of firestop device (Item 2).
3M COMPANY – 3M Fire Barrier Cast-In Device Height Adapter, 6HA
3. **Packing Material** – Min 4 in. (102 mm) thickness of min 4 pcf (64 kg/m³) mineral wool batt insulation firmly packed within the firestop device, recessed min 1/4 in. (6 mm) from the top surface of floor.
- 3A. **Fill, Void or Cavity Materials – Sealant*** – Min 1/4 in. (6 mm) thickness of sealant installed within the firestop device, flush with the top surface of floor. For W Rating, a min 1/4 in. (6 mm) bead of sealant is also required at the device/concrete interface on the top surface of the floor.
3M COMPANY – FB-1000 NS, FB-1003 SL or FB-3000 WT Sealant

*Bearing the UL Classification Mark

Reprinted from the Online Certifications Directory with permission from Underwriters Laboratories Inc.
 Copyright © 2010 Underwriters Laboratories Inc.®



System No. F-A-0024

October 30, 2006

F Rating – 3 Hr

T Rating – 3 Hr

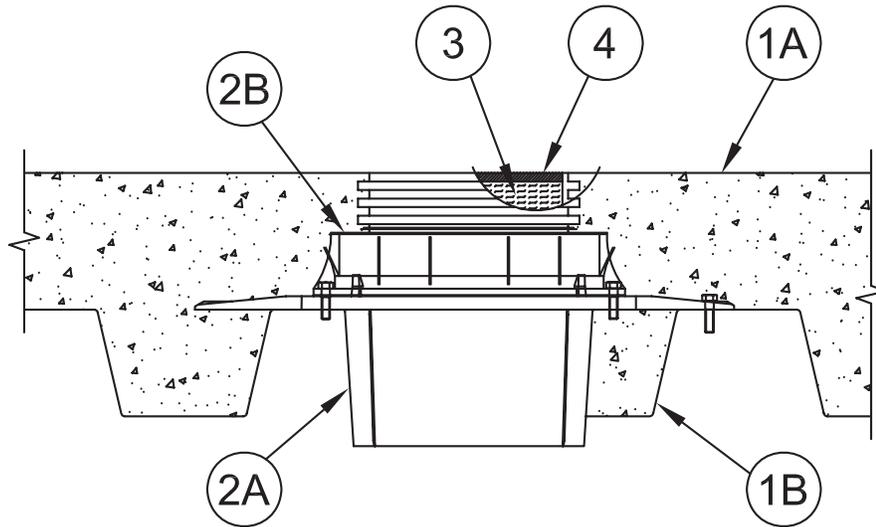

- Floor Assembly** – The fire-rated unprotected concrete and steel floor assembly shall be constructed of the materials and in the manner specified in the individual D900 Series designs in the UL Fire Resistance Directory and as summarized below:
 - Concrete** – Min 4-1/2 in. (114 mm) thick reinforced lightweight or normal weight (100-150 pcf or 1600-2400 kg/m³) concrete topping.
 - Steel Floor and Form Units*** – Composite or noncomposite max 3 in. (76 mm) deep fluted galv units as specified in the individual Floor-Ceiling design.
- Firestop Devices*** – The firestop devices are cast in place and permanently embedded during concrete placement or grouted in concrete assembly in accordance with accompanying installation instructions.
 - Firestop Device - Metal Deck Adapter*** – Adapter installed through opening in deck and secured with four sheet metal screws to deck in accordance with installation instructions.
3M COMPANY – 3M Fire Barrier Cast-In Device Metal Deck Adapter, 6MDA
 - Firestop Device*** – Snapped into top of metal deck adapter in accordance with accompanying installation instructions. The device shall be trimmed flush with top surface of floor.
3M COMPANY – 3M Fire Barrier Cast-In Device, 6MCID or 6PCID
- Packing Material** – Min 4 in. (102 mm) thickness of min 4 pcf (64 kg/m³) mineral wool batt insulation firmly packed into the top of the firestop device (Item 2B) as a permanent form, recessed 1/4 in. (6 mm) from the top surface of the floor.
- Fill, Void or Cavity Material* – Sealant** – Min 1/4 in. (6 mm) thickness of sealant installed within the firestop device, flush with the top surface of the floor.
3M COMPANY – FB-1000 NS or FB-1003 SL

*Bearing the UL Classification Mark

Reprinted from the Online Certifications Directory with permission from Underwriters Laboratories Inc.
Copyright © 2010 Underwriters Laboratories Inc.®



Through Penetrations

Blanks

0000 Series

Concrete

FA

System No. W-J-0017

July 02, 2009

F Rating – 2 Hr

T Rating – 2 Hr

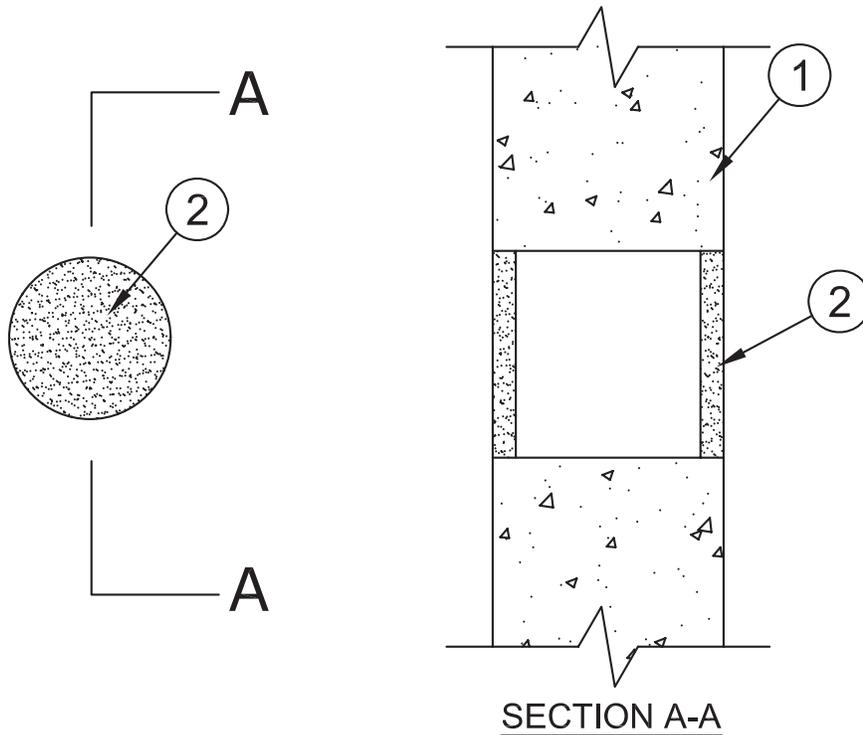

1. **Wall Assembly** – Min 6 in. (152 mm) thick reinforced lightweight or normal weight (100-150 pcf or 1600-2400 kg/m³) concrete. Wall may also be constructed of any UL Classified **Concrete Blocks***. Max diam of opening is 2 in. (51 mm).
See **Concrete Blocks** (CAZT) category in the Fire Resistance Directory for names of manufacturers.
2. **Fill, Void or Cavity Material – Caulk or Sealant** – Min 5/8 in. (16 mm) thickness of fill material applied within annulus, flush with each surface of the wall assembly.

3M COMPANY

3M FIRE PROTECTION PRODUCTS – IC 15WB+, CP 25WB+ or FB-3000 WT

*Bearing the UL Classification Mark

Reprinted from the Online Certifications Directory with permission from Underwriters Laboratories Inc.
Copyright © 2010 Underwriters Laboratories Inc.®



Through Penetrations

Blanks

0000 Series

Concrete

WJ

System No. W-J-0021

September 20, 2011

ANSI/UL1479 (ASTM E814)

F Ratings – 2 and 3 Hr (See Item 1)

T Ratings – 2 and 3 Hr (See Item 1)

CAN/ULC S115

F Ratings – 2 and 3 Hr (See Item 1)

FT Ratings – 2 and 3 Hr (See Item 1)

FH Ratings – 2 and 3 Hr (See Item 1)

FTH Ratings – 2 and 3 Hr (See Item 1)

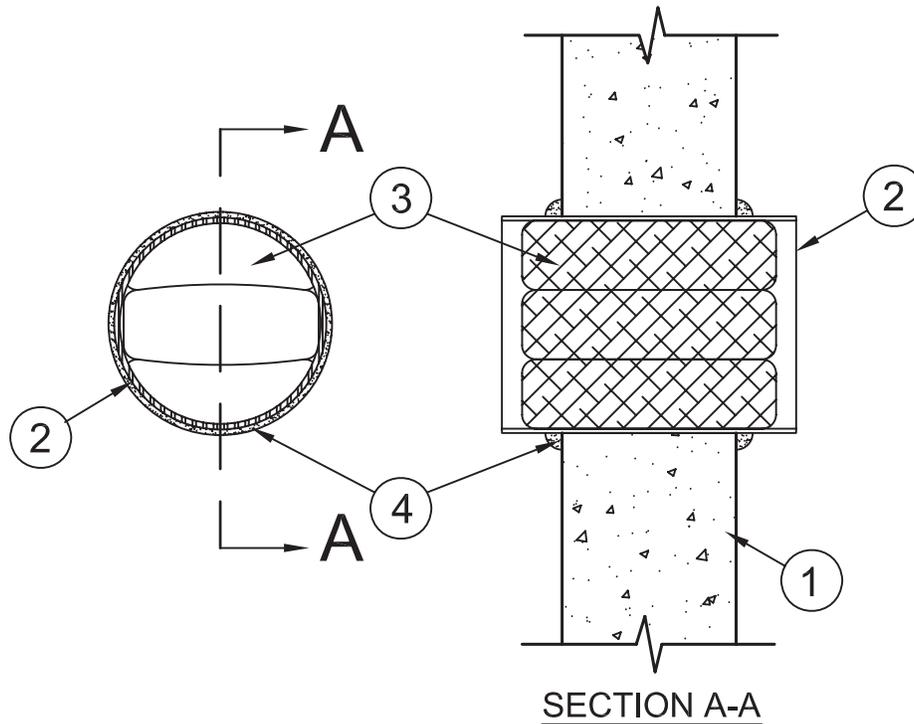

- Wall Assembly** – Min 6 in. (152 mm) thick reinforced lightweight or normal weight (100-150 pcf or 1600-2400 kg/m³) concrete. Wall may also be constructed of any UL Classified **Concrete Blocks***. Max diam of opening is 6 in. (152 mm).

See **Concrete Blocks** (CAZT) category in Fire Resistance Directory for names of manufacturers.

The F, T, FT, FH and FTH Ratings of the firestop system are equal to the 2 hr or 3 hr fire rating of the wall assembly in which it is installed.

- Steel Sleeve** – Cylindrical sleeve fabricated from min 0.016 in. (0.41 mm) thick (No. 28 MSG) galv sheet steel and having a min 1 in. (25 mm) lap along the longitudinal seam. Sleeve installed by coiling the sheet steel to a diam smaller than the through opening, inserting the coil through the opening and releasing the coil to let it uncoil against the periphery of the opening. The ends of the steel sleeve shall extend 2 in. (51 mm) beyond each surface of the wall.
- Fill Void or Cavity Material* – Pillows** – Nom 9 in. (229 mm) long by 6 in. (152 mm) wide by 2 or 3 in. (51 or 76 mm) thick plastic covered pillows tightly-packed into opening. Pillows installed with 9 in. (229 mm) dimension projecting through wall and centered within the opening.

3M COMPANY

3M FIRE PROTECTION PRODUCTS – Fire Barrier Pillow or Fire Barrier Self-Locking Pillows

- Fill, Void or Cavity Material* – Caulk or Sealant** – A min 1/2 in. (13 mm) bead of fill material shall be applied at the steel sleeve/concrete interface on both sides of wall.

3M COMPANY

3M FIRE PROTECTION PRODUCTS – IC 15WB+, CP 25WB+ or FB-3000 WT Sealant

*Bearing the UL Classification Mark

+Bearing the UL Listing Mark

Reprinted from the Online Certifications Directory with permission from Underwriters Laboratories Inc.
Copyright © 2011 Underwriters Laboratories Inc.®



System No. W-J-0023

January 09, 2014

F Ratings – 1 and 2 Hr (See Item 1)

T Rating – 0 Hr

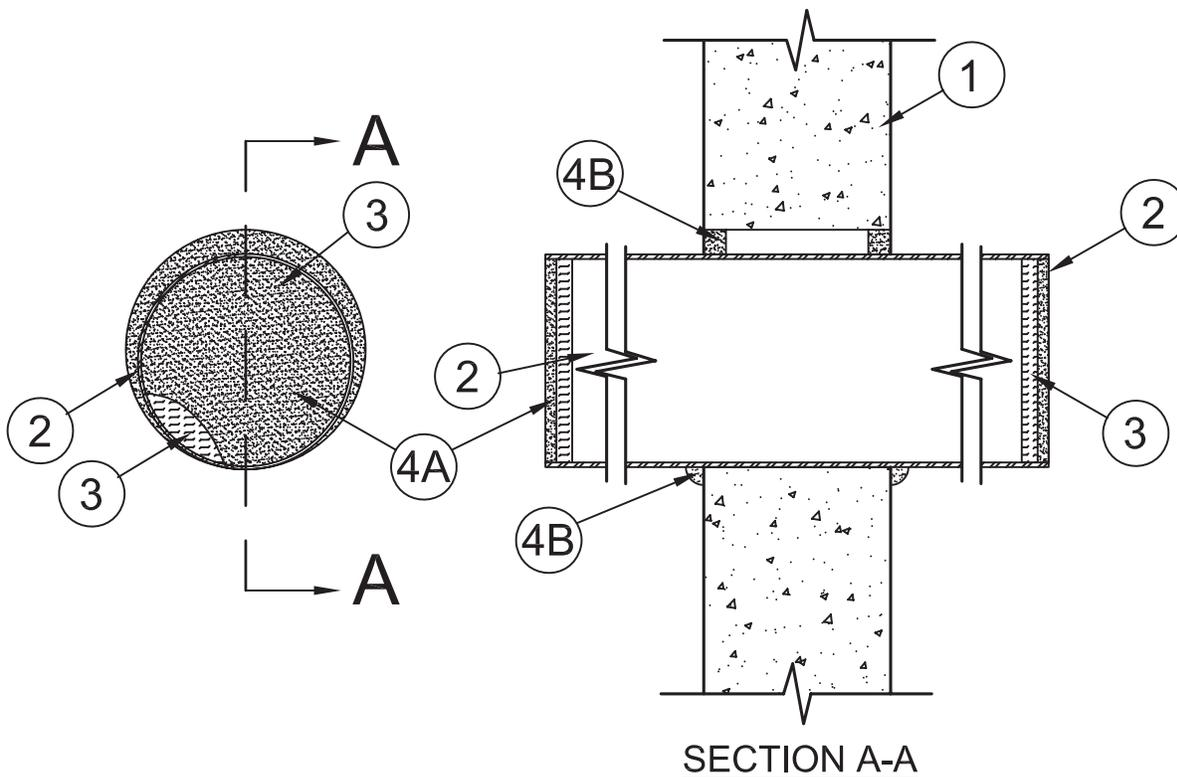

- Wall Assembly** – Min 4-1/2 in. (114 mm) thick reinforced lightweight or normal weight (100-150 pcf) concrete. Wall may also be constructed of any UL Classified **Concrete Blocks***. Max diameter of the opening is 6-1/2 in. (165 mm).
See **Concrete Blocks (CAZT)** in the Fire Resistance Directory for names of manufacturers.
The hourly F Rating of the firestop system is equal to the hourly fire rating of the wall assembly in which it is installed.
- Steel Sleeve** – Nom 6 in. (152 mm) diam (or smaller) steel electrical metallic tubing (EMT) or Schedule 5 steel pipe. The annular space between steel sleeve and periphery of opening shall be min 0 in. (point contact) to max 1/2 in. (13mm) Sleeve may extend up to 18 in. (457 mm) beyond each surface of the wall. Sleeve to be rigidly supported on both sides of wall assembly.
- Packing Materials** – Min 1 in. (25 mm) thickness of min 4 pcf (64 kg/m³) mineral wool batt insulation firmly packed into the opening as a permanent form. Packing material to be recessed from both ends of the sleeve as necessary to accommodate the required thickness of fill material.
- Firestop System** – The firestop system shall consist of the following:
 - Fill, Void or Cavity Material* – Caulk** – Min 1 in. (25 mm) thickness of fill material applied to fill the through opening flush with both ends of the sleeve.
3M COMPANY
3M FIRE PROTECTION PRODUCTS – CP 25WB+
 - Fill, Void or Cavity Material* – Sealant or Putty** – Min 5/8 in. (16 mm) thickness of fill material applied within the annulus, flush with both sides of the wall. At point contact, a min 1/2 in. (13 mm) bead of fill material shall be applied at sleeve/wall interface on both sides of the wall when sleeve extends beyond surface of wall.
3M COMPANY
3M FIRE PROTECTION PRODUCTS – IC 15 WB+, CP 25WB+ or FB-3000 WT
 - Fill, Void or Cavity Material* – (Not Shown)** - As an alternate to Item 4B above, min 5/8 in. (16 mm) thickness of fill material applied within the annulus, flush with both sides of the wall. At point contact, a min. 1/2 in. (13 mm) bead of fill material at sleeve/wall interface on both sides of both sides of wall when sleeve extends beyond surface of the wall.
3M COMPANY
3M FIRE PROTECTION PRODUCTS – Fire Barrier rated Foam, FIP 1 - Step

*Bearing the UL Classification Mark

+Bearing the ULListing Mark

Reprinted from the Online Certifications Directory with permission from UL
© 2014 UL LLC



System No. W-J-0025

May 13, 2016

| ANSI/UL1479 (ASTM E814) | CAN/ULC S115 |
|---|---|
| F Rating — 2 Hr | F Rating — 2 Hr |
| T Rating — 2 Hr | FT Rating — 2 Hr |
| L Rating At Ambient — Less Than 1 CFM/sq ft | FH Rating — 2 Hr |
| L Rating At 400 F — Less Than 1 CFM/sq ft | FTH Rating — 2 Hr |
| | L Rating At Ambient — Less Than 1 CFM/sq ft |
| | L Rating At 400 F — Less Than 1 CFM/sq ft |

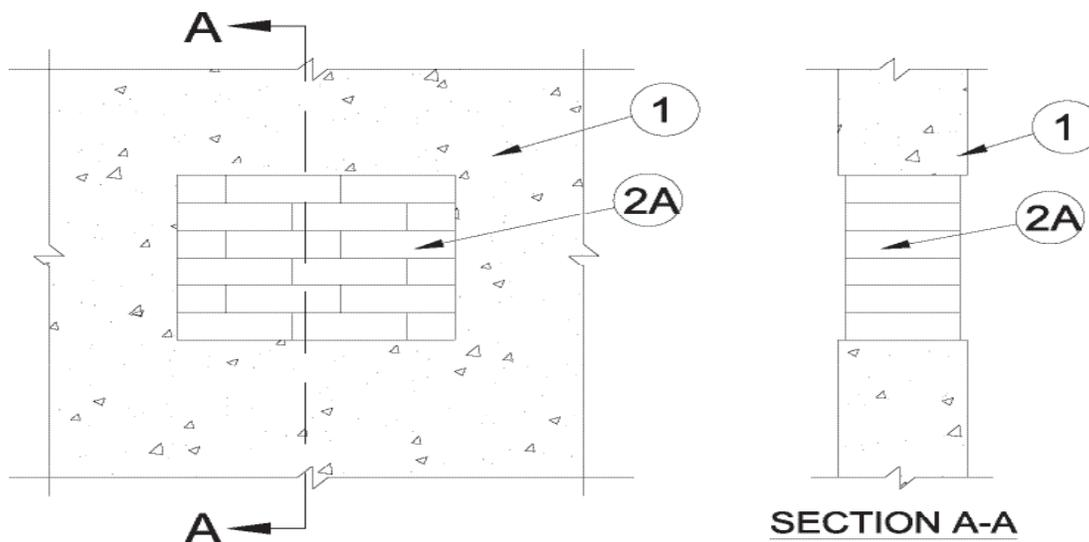

1. **Wall Assembly** — Min 6 in. (152 mm) thick lightweight or normal weight (100-150 pcf or 1600-2400 kg/m³) concrete. Wall may also be constructed of any UL Classified **Concrete Blocks***. Max area of opening is 144 sq in. (929 cm²) with a max dimension of 12 in. (305 mm). See **Concrete Blocks** (CAZT) in the Fire Resistance Directory for names of manufacturers.

2. **Firestop System** — The firestop system shall consist of the following:

A. **Fill, Void or Cavity Material*** — Blocks centered within wall opening with 5 in. (127 mm) dimension projecting through opening. The fire block can be centered within wall opening or installed flush with either side of wall. In concrete block walls, fire block to fill entire thickness of wall opening unless concrete block is solid filled. Blocks to be tightly packed to fill the opening area.

3M COMPANY 3M FIRE PROTECTION PRODUCTS — 3M™ Fire Barrier Block B258, 3M™ Fire Barrier Plank PK39

B. **Fill, Void or Cavity Materials*** — Foam (Optional. Required for L Rating Only. Not Shown) — Fill material to be forced between blocks and periphery of opening to the max extent possible. Foam to be injected into all voids within the annular space between blocks to the full depth of the blocks (Item 2A).

3M COMPANY 3M FIRE PROTECTION PRODUCTS — Fire Barrier Rated Foam, FIP 1-Step

* Indicates such products shall bear the UL or cUL Certification Mark for jurisdictions employing the UL or cUL Certification (such as Canada), respectively.



System No. W-J-0026

August 01, 2016

| ANSI/UL1479 (ASTM E814) | CAN/ULC S115 |
|---|---|
| F Rating — 2 Hr | F Rating — 2 Hr |
| T Rating — 1-3/4 Hr | FT Rating — 1-3/4 Hr |
| L Rating At Ambient — Less Than 1 CFM/sq ft | FH Rating — 2 Hr |
| L Rating At 400 F — Less Than 1 CFM/sq ft | FTH Rating — 1-3/4 Hr |
| | L Rating At Ambient — Less Than 1 CFM/sq ft |
| | L Rating At 400 F — Less Than 1 CFM/sq ft |

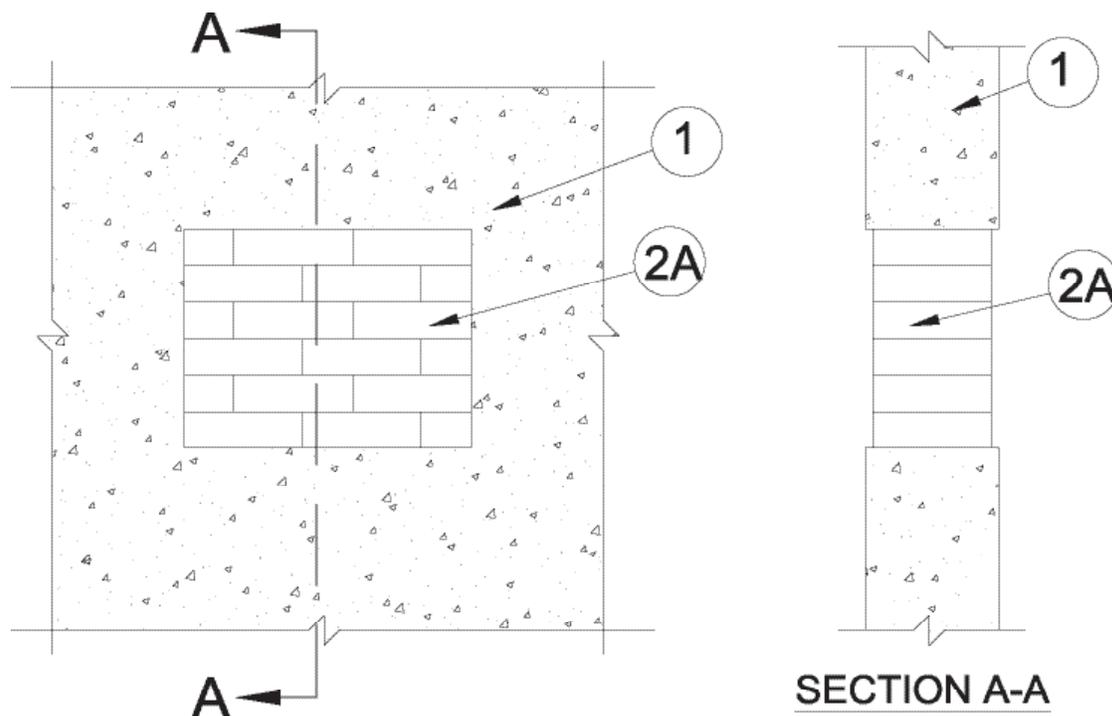

1. **Wall Assembly** — Min 6 in. (152 mm) thick lightweight or normal weight (100-150 pcf or 1600-2400 kg/m³) concrete. Wall may also be constructed of any UL Classified **Concrete Blocks***. Max area of opening is 1080 sq in. (6968 cm²) with a max dimension of 36 in. (914 mm).

See **Concrete Blocks** (CAZT) in the Fire Resistance Directory for names of manufacturers.

2. **Firestop System** — The firestop system shall consist of the following:

A. **Fill, Void or Cavity Material*** — Blocks centered within wall opening with 5 in. (127 mm) dimension projecting through opening. The fire block can be centered within wall opening or installed flush with either side of wall. In concrete block walls, fire block to fill entire thickness of wall opening unless concrete block is solid filled. Blocks to be tightly packed to fill the opening area.

3M COMPANY 3M FIRE PROTECTION PRODUCTS — 3M™ Fire Barrier Block B258, 3M™ Fire Barrier Plank PK39

B. **Fill, Void or Cavity Material*** — **Foam** — (Not Shown) — Fill material to be forced between blocks and periphery of opening to the max extent possible. Foam to be injected into all voids within the annular space between blocks to the full depth of the blocks (Item 2A).

3M COMPANY 3M FIRE PROTECTION PRODUCTS — Fire Barrier Rated Foam, FIP 1-Step

B1. **Fill, Void or Cavity Material*** — **Sealant or Caulk** — (Not Shown) — As an alternate to Item 2B, sealant to be forced between blocks and periphery of opening to the max extent possible. Sealant to be applied into all voids within the annular space between blocks to the full depth of the blocks (Item 2A).

3M COMPANY 3M FIRE PROTECTION PRODUCTS — IC 15WB+ Caulk, CP 25WB+ Caulk or FB-3000 WT Sealant

The L Ratings of the firestop system apply only when Item 2B Foam is used.

* Indicates such products shall bear the UL or cUL Certification Mark for jurisdictions employing the UL or cUL Certification (such as Canada), respectively.



Blanks • Gypsum

| 3M UL Systems | "F" Rating | 3M Product | Through Penetrant Details |
|---------------|------------|--|---|
| W-L-0011 | 1, 2 | 3M™ Fire Barrier Moldable Putty Stix MP+ 3M™ Fire Barrier Self-Locking Pillows 3M™ Fire Barrier Pillows | 540 sq. in., 30" maximum. Also referred as WL0011. |
| W-L-0031 | 1, 2 | 3M™ Fire Barrier Sealant IC 15WB+ 3M™ Fire Barrier Sealant CP 25WB+ 3M™ Fire Barrier Water Tight Sealant 3000 WT | Max 2 in. blank opening. U300, V400, or U400 walls with steel or metal studs. No mineral wool required—sealant only. 1 & 2 hour F. Also known as WL0031. |
| W-L-0036 | 1, 2 | 3M™ Fire Barrier Putty Sleeves 3M™ Fire Barrier Moldable Putty Stix MP+ | Max 6-1/2 in. blank opening. U300 or U400 Series wall with wood or steel studs. Space between device and periphery of opening point contact to max 1 in. 1 and 2 hour F rating. 1/2 hour T rating. Also known as WL0036. |
| W-L-0037 | 3, 4 | 3M™ Fire Barrier Putty Sleeves 3M™ Fire Barrier Moldable Putty Stix MP+ | Max 6-1/2 in. blank opening. U300 or U400 Series wall with wood or steel studs. Space between device and periphery of opening point contact to max 1 in. Packing material required. 3 and 4 hour F rating. 1/2 hour T rating. Also known as WL0037. |
| W-L-0039 | 1, 2, 3 | 3M™ Fire Barrier Sealant IC 15WB+ 3M™ Fire Barrier Sealant CP 25WB+ 3M™ Fire Barrier Water Tight Sealant 3000 WT 3M™ Fire Barrier Pillows 3M™ Fire Barrier Self-Locking Pillows | Max 6 in. blank opening. U400 or V400 series gypsum walls. 1, 2 & 3 hour F & T ratings. Min 28 gauge sheet metal sleeve required. Sealant only at concrete/sleeve interface. Also known as WL0039. |
| W-L-0041 | 1, 2 | 3M™ Fire Barrier Pass-Through Products 3M™ Fire Barrier Sealant CP 25WB+ 3M™ Fire Barrier Sealant IC 15WB+ 3M™ Fire Barrier Moldable Putty Stix MP+ 3M™ Fire Barrier Water Tight Sealant 3000 WT | Max. 4-1/2 in. square or round opening in a 1 or 2 hour rated U300, U400, or V400 series gypsum wallboard assembly, using Fire Barrier Pass-Through Device. |
| W-L-0045 | 1, 2 | 3M™ Fire Barrier Sealant IC 15WB+ 3M™ Fire Barrier Sealant CP 25WB+ 3M™ Fire Barrier Water Tight Sealant 3000 WT 3M™ Fire Barrier Rated Foam FIP 1-Step | Max 6-1/2 in. opening. 1 or 2 hour fire rated gypsum board/stud wall assembly. Nom 6 in. steel sleeve. Also known as WL0045 |
| W-L-0049 | 1, 2 | 3M™ Fire Barrier Block 3M™ Fire Barrier Plank 3M™ Fire Barrier Rated Foam FIP 1-Step | Blank opening in a gypsum wall assembly with a 144 sq. in. opening with max 12 in. dimension. |
| W-L-0050 | 1, 2 | 3M™ Fire Barrier Block 3M™ Fire Barrier Plank 3M™ Fire Barrier Rated Foam FIP 1-Step 3M™ Fire Barrier Sealant IC 15WB+ 3M™ Fire Barrier Sealant CP 25WB+ 3M™ Fire Barrier Water Tight Sealant 3000 WT | Blank opening in a gypsum wall assembly with a 1080 sq. in. opening with max 36 in. dimension. |
| W-L-0051 | 1, 2 | 3M™ Fire Barrier Plug | Max 2 in. or 4-1/2 in. blank opening in a gypsum wallboard assembly sleeved with No. 28 MSG galvanized sheet steel. |

System No. W-L-0011

September 20, 2011

ANSI/UL1479 (ASTM E814)

F Ratings – 1 and 2 Hr (See Item 1)

T Ratings – 1 and 2 Hr (See Item 1)

L Rating At Ambient – 2 CFM/sq f

L Rating At 400 F – 2 CFM/sq f

CAN/ULC S115

F Ratings – 1 and 2 Hr (See Item 1)

FT Ratings – 1 and 2 Hr (See Item 1)

FH Ratings – 1 and 2 Hr (See Item 1)

FTH Ratings – 1 and 2 Hr (See Item 1)

L Rating At Ambient – 2 CFM/sq ft

L Rating At 400 F – 2 CFM/sq ft

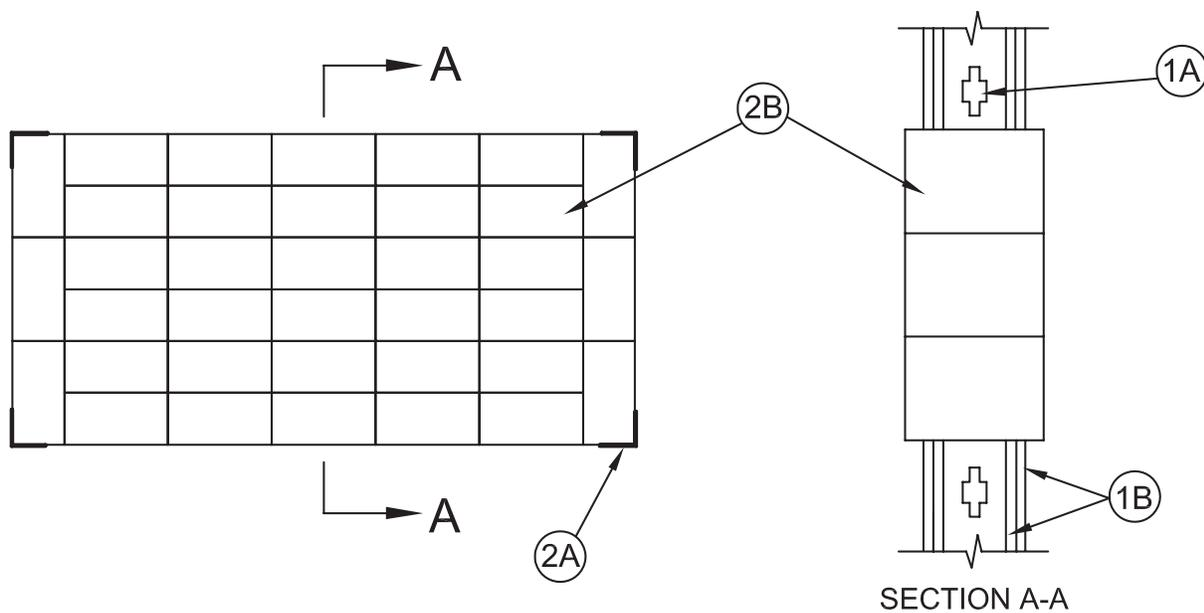

1. **Wall Assembly** – The 1 or 2 hr fire-rated gypsum board/stud wall assembly shall be constructed of the materials and in the manner specified in the individual U300, U400, V400 or W400 Series Wall or Partition Designs in the UL Fire Resistance Directory and shall include the following construction features:

A. **Studs** – Wall framing may consist of either wood studs or steel channel studs. Wood studs to consist of nom 2 by 4 in. (51 by 102 mm) lumber spaced 16 in. (406 mm) OC. Steel studs to be min 3-5/8 in. (92 mm) wide and spaced max 24 in. (305 mm) OC. Additional framing members shall be used to completely frame around opening.

B. **Gypsum Board*** – Thickness, type, number of layers and fasteners as required in the individual Wall and Partition Design. Max area of opening is 540 in.2 (0.35 m2) with a max dimension of 30 in.(762 mm).

The hourly F, T FT, FH and FTH Ratings for the firestop system are equal to the hourly fire rating of the wall assembly in which it is installed.

2. **Firestop System** – The firestop system shall consist of the following:
 - A. **Fill Void or Cavity Material* – Putty** – Min 1/2 in. (13 mm) thickness of putty formed to a min 1 in. (25 mm) width and applied within annulus at all corners of opening and extending a min 1 in. (25 mm) in both directions from each corner, flush with both surfaces of wall.
3M COMPANY – MPS-2+
 - B. **Fill Void or Cavity Material* – Pillows** – Max 9 in. (229 mm) long by 6 in. (152 mm) wide by 2 and 3 in. (51 and 76 mm) thick plastic covered pillows tightly-packed into opening. Pillows installed with 9 in. (229 mm) dimension projecting through wall and centered within the opening.
3M COMPANY – Fire Barrier Pillow or Fire Barrier Self-Locking Pillows

*Bearing the UL Classification Mark

Reprinted from the Online Certifications Directory with permission from Underwriters Laboratories Inc.

Copyright © 2011 Underwriters Laboratories Inc.®



System No. W-L-0031

July 02, 2009

F Ratings – 1 and 2 Hr (See Item 1)

T Ratings – 1 and 2 Hr (See Item 1)

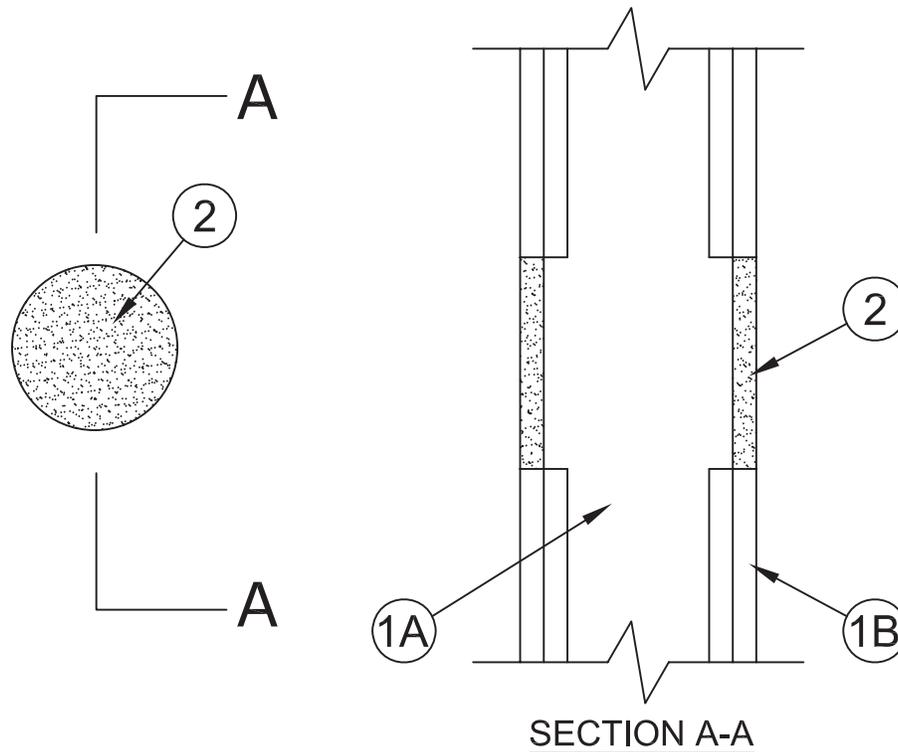

1. **Wall Assembly** – The 1 or 2 h fire-rated gypsum board/stud wall assembly shall be constructed of the materials and in the manner described in the individual U300, U400 or V400 Series Wall and Partition Designs in the UL Fire Resistance Directory and shall include the following construction features:
 - A. **Studs** – Wall framing may consist of either wood studs or steel channel studs. Wood studs to consist of nom 2 by 4 in. (51 by 102 mm) lumber spaced 16 in. (406 mm) OC. Steel studs to be min 3-1/2 in. (89 mm) wide and spaced max 24 in. (610 mm) OC.
 - B. **Gypsum Board** – Thickness, type, number of layers and fasteners as specified in the individual Wall and Partition Design. Max diam of opening is 2 in. (51 mm).

The hourly F Rating of the firestop system is equal to the hourly assembly rating of the wall assembly in which it is installed.
2. **Fill, Void or Cavity Material – Caulk or Sealant** – Min 5/8 in. (16 mm) thickness of fill material applied within annulus, flush with each surface of the wall assembly.

3M COMPANY**3M FIRE PROTECTION PRODUCTS** – IC 15WB+, CP 25WB+ or FB-3000 WT

*Bearing the UL Classification Mark

Reprinted from the Online Certifications Directory with permission from Underwriters Laboratories Inc.
 Copyright © 2010 Underwriters Laboratories Inc.®



System No. W-L-0036

October 11, 2011

ANSI/UL1479 (ASTM E814)

F Ratings – 1 and 2 Hr (See Item 1)

T Rating – 1/2 Hr

CAN/ULC S115

F Ratings – 1 and 2 Hr (See Item 1)

FT Rating – 1/2 Hr

FH Ratings – 1 and 2 Hr (See Item 1)

FTH Rating – 1/2 Hr

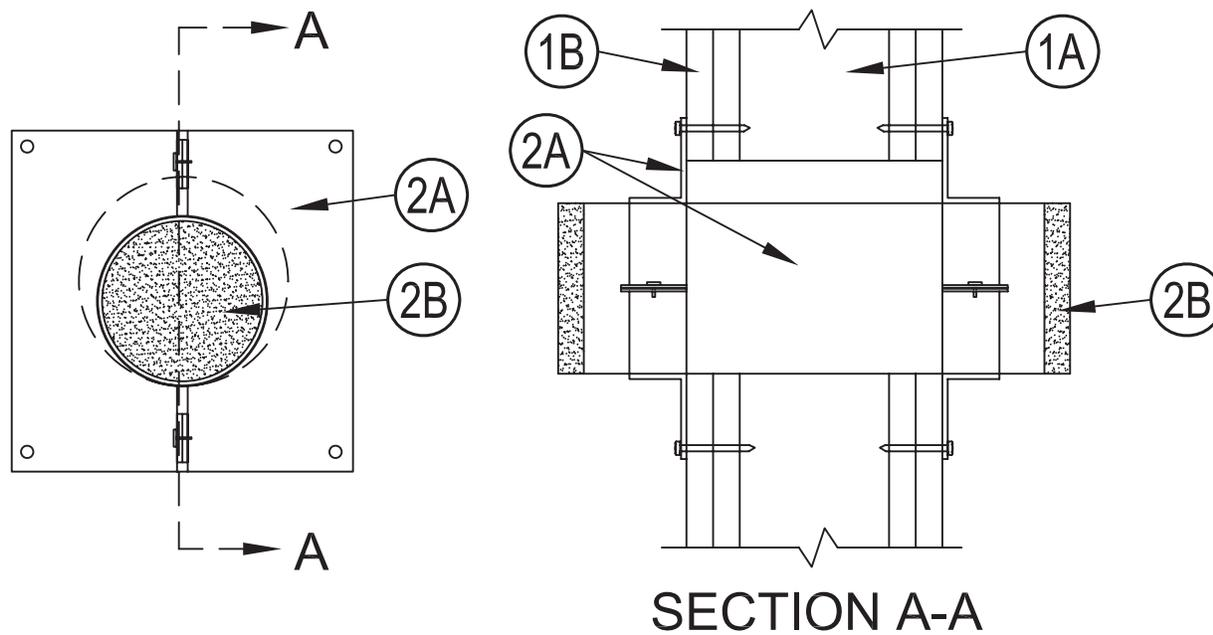

1. **Wall Assembly** – The 1 or 2 hr fire rated gypsum board/stud wall assembly shall be constructed of the materials and in the manner specified in the individual U300, U400, V400 or W400 Series Wall and Partition Designs in the UL Fire Resistance Directory and shall include the following construction features:

- A. **Studs** – Wall framing may consist of either wood studs or steel channel studs. Wood studs to consist of nom 2 by 4 in. (51 by 102 mm) lumber spaced 16 in. (406 mm) OC. Steel studs to be min 3-1/2 in. (89 mm) wide and spaced max 24 in. (610 mm) OC.
- B. **Gypsum Board*** – 5/8 in. (16 mm) thick, The gypsum board type, thickness, number of layers, fastener type and sheet orientation shall be as specified in the individual U300, U400, V400 or W400 Series Design in the UL Fire Resistance Directory. Max diam of opening is 6-1/2 in. (165 mm)

The hourly F and FH Ratings of the firestop system are equal to the hourly fire rating of the wall assembly in which it is installed.

2. **Firestop System** – The firestop system shall consist of the following:
 - A. **Firestop Device*** – One firestop device module centered within the opening. The firestop device module consists of a 12 in. (305 mm) long galv steel split sleeve with galv steel flange plates. Firestop device module to be installed in accordance with the accompanying installation instructions. The space between the firestop device module and the periphery of the opening shall be min 0 in. (point contact) to max 1 in. (25 mm). Firestop device module secured in place by means of steel flange plates sized to accommodate the firestop device module.. Steel flange plate installed on both sides of wall and secured around firestop device module with steel screws. The steel flange plate is then secured to the wall with the supplied drywall screws. The firestop device module is to be installed with its ends projecting an equal distance beyond each surface of the wall assembly.

3M COMPANY
3M FIRE PROTECTION PRODUCTS – 3M Fire Barrier Putty Sleeve Kit DT 100, DT 200 or DT 400
 - B. **Fill, Void or Cavity Material*** – A min 1 in. (25mm) depth of the putty material is required at each end of the device.

3M COMPANY
3M FIRE PROTECTION PRODUCTS – 3M Fire Barrier MP+ Putty stix
 - C. **Packing Material** – (Not shown. Required for installation only on DT 400. Optional on DT 100 and DT200 assemblies.) - Min 2 in. (51 mm) thickness of min 4 pcf (64 kg/m³) mineral wool batt insulation firmly packed into each end of sleeve (Item 3B) as a permanent form. Packing material to be recessed from each end of sleeve to accommodate the required thickness of fill material.

*Bearing the UL Classification Mark

+Bearing the UL Listing Mark

Reprinted from the Online Certifications Directory with permission from UL

© 2012 UL LLC



System No. W-L-0037

October 11, 2011

ANSI/UL1479 (ASTM E814)

F Ratings – 3 and 4 Hr (See Item 1)

T Rating – 1/2 Hr

CAN/ULC S115

F Ratings – 3 and 4 Hr (See Item 1)

FT Rating – 1/2 Hr

FH Ratings – 3 and 4 Hr (See Item 1)

FTH Rating – 1/2 Hr

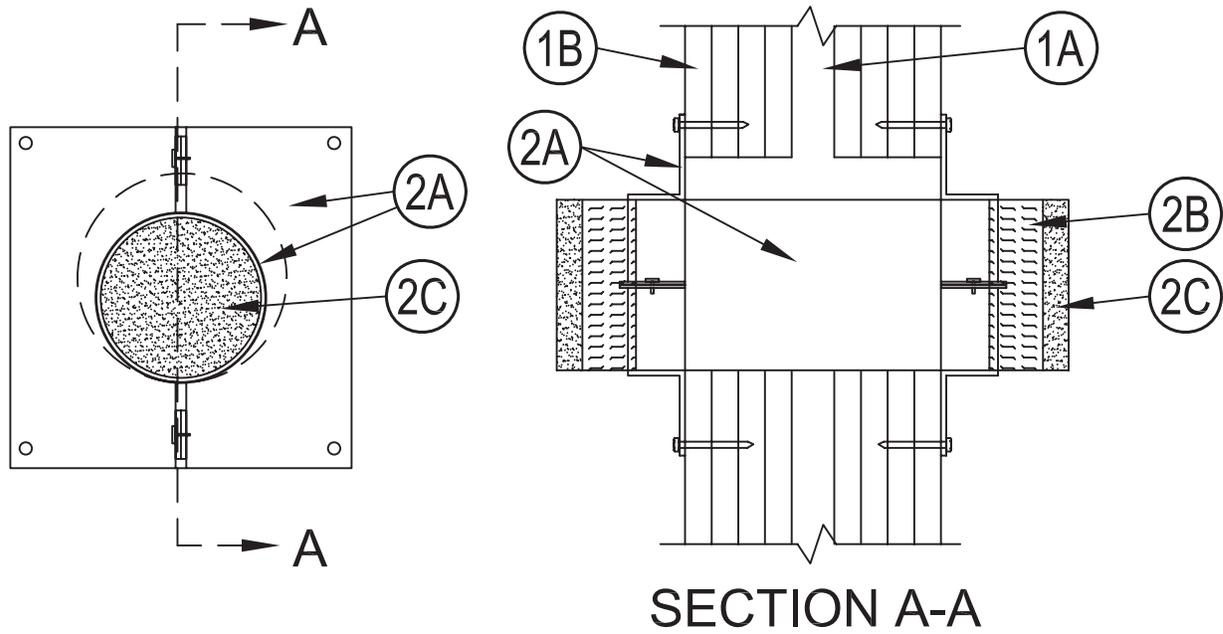

1. **Wall Assembly** – The 3 or 4 hr fire rated gypsum board/stud wall assembly shall be constructed of the materials and in the manner specified in the individual U400, V400 or W400 Series Wall and Partition Designs in the UL Fire Resistance Directory and shall include the following construction features:

- A. **Studs** – Wall framing shall consist of steel channel studs. Steel studs to be min 3-1/2 in. (89 mm) wide and spaced max 24 in. (610 mm) OC.
- B. **Gypsum Board*** – 5/8 in. (16 mm) thick. The gypsum board type, thickness, number of layers, fastener type and sheet orientation shall be as specified in the individual U400, V400 or W400 Series Design in the UL Fire Resistance Directory. Max diam of opening is 6-1/2 in. (165 mm)

The hourly F and FH Ratings of the firestop system are equal to the hourly fire rating of the wall assembly in which it is installed.

2. **Firestop System** – The firestop system shall consist of the following:
- A. **Firestop Device*** – One firestop device module centered within the opening. The firestop device module consists of a 12 in. (305 mm) long galv steel split sleeve with steel flange plates. Firestop device module to be installed in accordance with the accompanying installation instructions. The space between the firestop device module and the periphery of the opening shall be min 0 in. (point contact) to max 1 in. (25 mm). Firestop device module secured in place by means of steel flange plates sized to accommodate the firestop device module. Steel flange plate installed on both sides of wall and secured around firestop device module with steel screws. The steel flange plate is then secured to both sides of the wall assembly with the supplied screws. The firestop device module is to be installed with its ends projecting an equal distance beyond each surface of the wall assembly.

3M COMPANY

3M FIRE PROTECTION PRODUCTS – 3M Fire Barrier Putty Sleeve Kit DT 100, DT 200 or DT 400

- B. **Packing Material** – Min 2 in. (51 mm) thickness of min 4 pcf (64 kg/m³) mineral wool batt insulation firmly packed into top end of sleeve (Item 2A) as a permanent form. Packing material to be recessed from top end of sleeve to accommodate the required thickness of fill material.
- C. **Fill, Void or Cavity Material*** – After the installation of the packing material (Item 2B) the supplied putty material is to be packed into each end of the firestop device. A min 1 in. (25mm) depth of the putty material is required at each end of device.

3M COMPANY

3M FIRE PROTECTION PRODUCTS – 3M Fire Barrier MP+ Putty stix

*Bearing the UL Classification Mark
+Bearing the UL Listing Mark

System No.W-L-0039

September 20, 2011

ANSI/UL1479 (ASTM E814)

F Ratings – 1, 2 and 3 Hr (See Item 1)

T Ratings – 0 and 3 Hr (See Item 1)

CAN/ULC S115

F Ratings – 1, 2 and 3 Hr (See Item 1)

FT Ratings – 0 and 3 Hr (See Item 1)

FH Ratings – 1, 2 and 3 Hr (See Item 1)

FTH Ratings – 0 and 3 Hr (See Item 1)

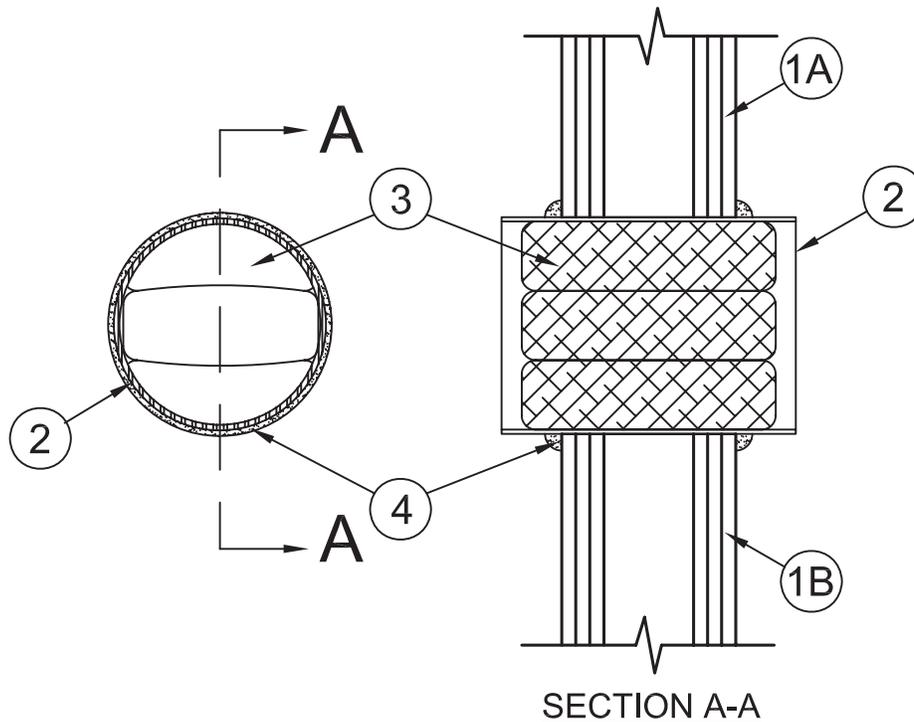

- Wall Assembly** – The 1, 2 or 3 hr fire rated gypsum board/stud wall assembly shall be constructed of the materials and in the manner specified in the individual U400, V400 or W400 Series Wall and Partition Designs in the UL Fire Resistance Directory and shall include the following construction features:
 - Studs** – Wall framing to consist of steel channel studs. Steel studs to be min 3-1/2 in. (89 mm) wide and spaced max 24 in.(610 mm) OC.
 - Gypsum Board*** – 5/8 in.(16 mm) thick. The gypsum board type, thickness, number of layers, fastener type and sheet orientation shall be as specified in the individual U400, V400 or W400 Series Design in the UL Fire Resistance Directory. Max diam of opening is 6 in.(152 mm).

The hourly F and FH Ratings of the firestop system are equal to the hourly fire rating of the wall assembly in which it is installed. The hourly T, FT and FTH Ratings of the firestop system are 0 hr when used in 1 or 2 hr fire rated walls and 3 hr when used in 3 hr fire rated walls.

- Steel Sleeve** – Cylindrical sleeve fabricated from min 0.016 in. (0.41 mm) thick (No. 28 MSG) galv sheet steel and having a min 1 in. (25 mm) lap along the longitudinal seam. Sleeve installed by coiling the sheet steel to a diam smaller than the through opening, inserting the coil through the openings and releasing the coil to let it uncoil against the circular cutouts in the gypsum board layers. The ends of the steel sleeve shall extend 2 in. (51 mm) beyond each surface of the wall.
- Fill Void or Cavity Material* – Pillows** – Nom 9 in. (229 mm) long by 6 in. (152 mm) wide by 2 or 3 in. (51 or 76 mm) thick plastic covered pillows tightly-packed into opening. Pillows installed with 9 in. (229 mm) dimension projecting through wall and centered within the opening.

3M COMPANY

3M FIRE PROTECTION PRODUCTS – Fire Barrier Pillow or Fire Barrier Self-Locking Pillows

- Fill, Void or Cavity Material* – Caulk or Sealant** – A min 1/2 in. (13 mm) bead of fill material shall be applied at the steel sleeve/gypsum board interface on both sides of wall.

3M COMPANY

3M FIRE PROTECTION PRODUCTS – IC 15WB+, CP 25WB+ or FB-3000 WT Sealant

*Bearing the UL Classification Mark

+Bearing the UL Listing Mark

Reprinted from the Online Certifications Directory with permission from Underwriters Laboratories Inc.

Copyright © 2011 Underwriters Laboratories Inc.®



System No. W-L-0041

May 23, 2011

F Ratings – 1 and 2 Hr (See Item 1)

T Rating – 0 Hr

L Rating At Ambient – 1 CFM/sq ft. (See Item 2B)

L Rating At 400 F – Less Than 1 CFM/sq ft. (See Item 2B)

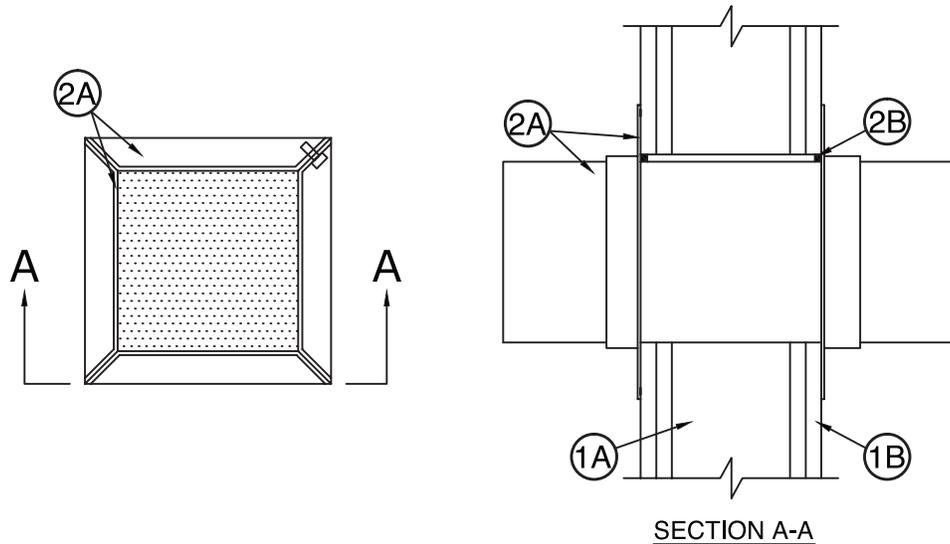

1. **Wall Assembly** – The 1 or 2 hr fire rated gypsum board/stud wall assembly shall be constructed of the materials and in the manner described in the individual U300, U400 or V400 Series Wall and Partition Design in the UL Fire Resistance Directory and shall include the following construction features:

- A. **Studs** – Wall framing may consist of either wood or steel channel studs. Wood studs to consist of nom 2 by 4 in. (51 by 102 mm) lumber spaced 16 in. (406 mm) OC. Steel studs to be min 3-1/2 in. (89 mm) wide spaced max 24 in. (610 mm) OC.
- B. **Gypsum Board*** – The gypsum board type, thickness, number of layers, fastener type and sheet orientation shall be as specified in the individual Wall and Partition Design in the UL Fire Resistance Directory. Max area of opening is 18 in.2 (116 cm²) with a max dimension of 4-1/4 in. (108 mm) for square device. Max diam of opening is 2-1/4 in. (57 mm) for nom 2 in. (51 mm) round device and 4-1/4 in. (108 mm) for nom 4 in. (102 mm) round device.

The hourly F Rating of the firestop system is equal to the hourly fire rating of the wall assembly in which it is installed.

2. **Firestop System** – The firestop system shall consist of the following:

- A. **Firestop Device*** – Each device consists of a nom 2-1/2 by 2-1/2 by 10 in. (64 by 64 by 254 mm), a nom 4 by 4 by 10 in. (102 by 102 by 254 mm), a nom 2 in. (51 mm) diam by 10 in. (254 mm) or a nom 4 in. (102 mm) diam by 10 in. (254 mm) powder coated steel transit incorporating internal intumescent material, foam plugs and mounting flanges. Firestop device to be installed within opening with ends projecting an equal distance beyond each surface of wall assembly in accordance with the accompanying installation instructions. The annular space between device and periphery of opening shall be min 0 in. (point contact) to max 1/8 in. (3.2 mm). Firestop device secured in place by means of fill material (Item 2B) and steel split mounting flanges sized to accommodate the firestop device. Steel split mounting flanges installed on both sides of wall after installation of fill material, and secured together with supplied steel set screws. Nom 1 in. (25 mm) thick pre-cut foam plugs installed flush with each end of device on both sides of wall assembly. The foam plug in one or both ends of the device is optional except when L Rating is required (See Item 2B).

3M COMPANY**3M FIRE PROTECTION PRODUCTS** – 3M Fire Barrier Pass-Through Device

- B. **Fill, Void or Cavity Materials* – Putty or Caulk** – Min 1/8 in. (3 mm) bead of fill material applied at interface of gypsum board and firestop devices immediately prior to the installation of the mounting flanges. As an option, foam plugs may be recessed into device and the recess filled with putty or caulk flush with the ends of the device. L Rating applies only when fill material is applied at interface of gypsum board and device prior to mounting flanges and with both ends of firestop device filled with nominal 1/8 in. (3.2 mm) of Moldable Putty+.

3M COMPANY**3M FIRE PROTECTION PRODUCTS** – Moldable Putty+, CP 25WB+, IC 15WB+, 3000 WT

*Bearing the UL Classification Mark

Reprinted from the Online Certifications Directory with permission from UL

© 2012 UL LLC

System No. W-L-0045

January 09, 2014

F Ratings – 1 and 2 Hr (See Item 1)

T Rating – 0 Hr

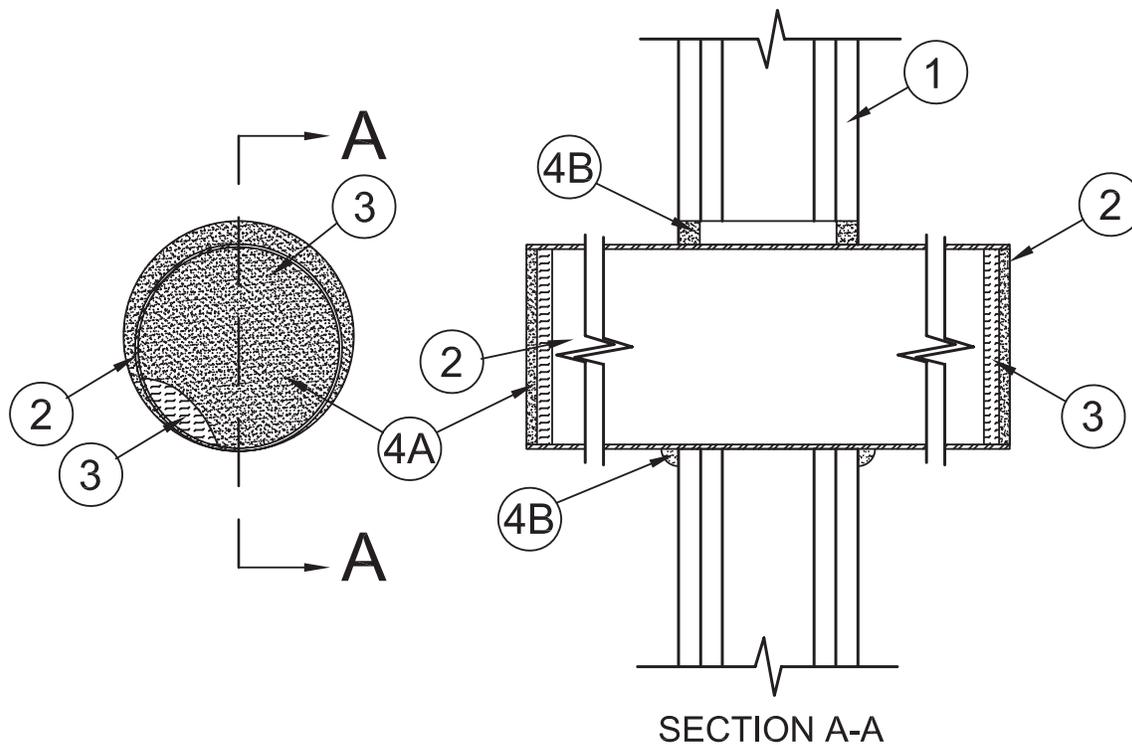

- Wall Assembly** – The 1 or 2 hr fire rated gypsum board/stud wall assembly shall be constructed of the materials and in the manner specified in the individual U300 or U400 Series Wall and Partition Designs in the UL Fire Resistance Directory and shall include the following construction features:

- Studs** – Wall framing may consist of either wood studs or steel channel studs. Wood studs to consist of nom 2 by 4 in. (51 by 102 mm) lumber spaced 16 in. (406 mm) OC. Steel studs to be min 2-1/2 in. (64 mm) wide and spaced max 24 in. (610 mm) OC.
- Gypsum Board*** – 5/8 in. (16 mm) thick, The gypsum board type, thickness, number of layers, fastener type and sheet orientation shall be as specified in the individual U300 or U400 Series Design in the UL Fire Resistance Directory. Max diam of opening is 6-1/2 in. (165 mm).

The hourly F Rating of the firestop system is equal to the hourly fire rating of the wall assembly in which it is installed.

- Steel Sleeve** – Nom 6 in. (152 mm) diam (or smaller) steel electrical metallic tubing (EMT) or Schedule 5 steel pipe. The annular space between steel sleeve and periphery of opening shall be min 0 in. (point contact) to max 1/2 in. (13 mm) Sleeve may extend up to 18 in. (457 mm) beyond each surface of the wall.

Sleeve to be rigidly supported on both sides of wall assembly.

- Packing Materials** – Min 1 in. (25 mm) thickness of min 4 pcf (64 kg/m³) mineral wool batt insulation firmly packed into the opening as a permanent form. Packing material to be recessed from both ends of the sleeve as necessary to accommodate the required thickness of fill material.

- Firestop System** – The firestop system shall consist of the following:

- Fill, Void or Cavity Material* – Caulk** – Min 1 in. (25 mm) thickness of fill material applied to fill the through opening flush with both ends of the sleeve.

3M COMPANY

3M FIRE PROTECTION PRODUCTS – CP 25WB+

- Fill, Void or Cavity Material* – Sealant or Putty** – Min 5/8 in. (16 mm) thickness of fill material applied within the annulus, flush with both sides of the wall. At point contact, a min 1/2 in. (13 mm) bead of fill material shall be applied at sleeve/wall interface on both sides of the wall when sleeve extends beyond surface of wall.

3M COMPANY

3M FIRE PROTECTION PRODUCTS – IC 15 WB+, CP 25WB+ or FB-3000 WT

- Fill, Void or Cavity Material* – (Not Shown)** - As an alternate to Item 4B above, min 5/8 in. (16 mm) thickness of fill material applied within the annulus, flush with both sides of the wall. At point contact, a min. 1/2 in. (13 mm) bead of fill material at sleeve/wall interface on both sides of both sides of wall when sleeve extends beyond surface of the wall.

3M COMPANY

3M FIRE PROTECTION PRODUCTS – Fire Barrier rated Foam, FIP 1 - Step

*Bearing the UL Classification Mark

+Bearing the UL Listing Mark

Reprinted from the Online Certifications Directory with permission from UL

© 2014 UL LLC



System No. W-L-0049

May 13, 2016

| ANSI/UL1479 (ASTM E814) | CAN/ULC S115 |
|---|---|
| F Ratings — 1 and 2 Hr (See Item 1) | F Ratings — 1 and 2 Hr (See Item 1) |
| T Ratings — 1 and 2 Hr (See Item 1) | FT Ratings — 1 and 2 Hr (See Item 1) |
| L Rating At Ambient — Less Than 1 CFM/sq ft | FH Ratings — 1 and 2 Hr (See Item 1) |
| L Rating At 400 F — Less Than 1 CFM/sq ft | FTH Ratings — 1 and 2 Hr (See Item 1) |
| | L Rating At Ambient — Less Than 1 CFM/sq ft |
| | L Rating At 400 F — Less Than 1 CFM/sq ft |

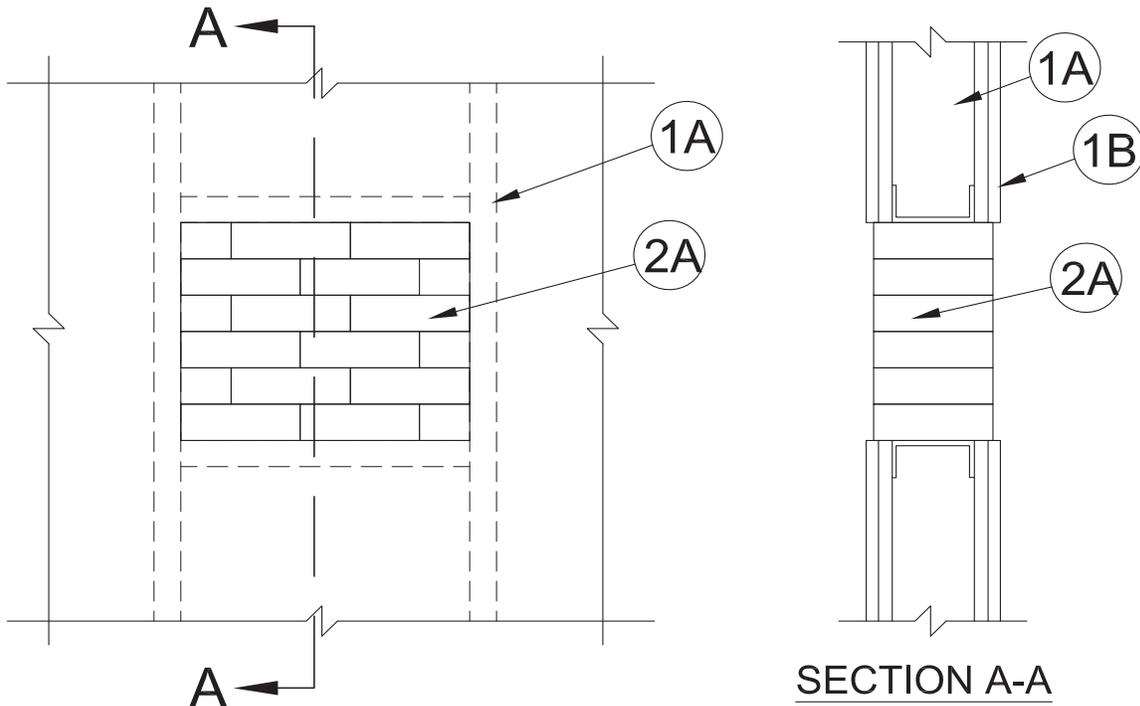

1. **Wall Assembly** — The 1 or 2 hr fire-rated gypsum board/stud wall assembly shall be constructed of the materials and in the manner specified in the individual U300, U400, V400 or W400 Series Wall and Partition Designs in the UL Fire Resistance Directory and shall include the following construction features:

- A. **Studs** — Wall framing to consist of wood studs or channel shaped steel studs. Wood studs to consist of nom 2 by 4 in. (51 by 102 mm) lumber spaced 16 in. (406 mm) OC. Steel studs to be min 3-1/2 in. (89 mm) wide and spaced max 24 in. (610 mm) OC. Additional studs shall be used to completely frame the opening.
- B. **Gypsum Board*** — One or two layers of nom 5/8 in. (16 mm) thick gypsum board, as specified in the individual Wall and Partition Design. Max area of opening is 144 sq in. (929 cm²) with a max dimension of 12 in. (305 mm).

The hourly F, T, FH, FT and FTH Ratings of the firestop system are equal to the hourly fire rating of the wall assembly in which it is installed.

2. **Firestop System** — The firestop system shall consist of the following:

- A. **Fill, Void or Cavity Material*** — Blocks centered within wall opening with 5 in. (127 mm) dimension projecting through opening such that blocks are recessed max 1/2 in. (13 mm) from both surfaces of wall. Blocks to be tightly packed to fill the opening area.
3M COMPANY 3M FIRE PROTECTION PRODUCTS — 3M™ Fire Barrier Block B258, 3M™ Fire Barrier Plank PK39
- B. **Fill, Void or Cavity Materials*** — Foam (Optional. Required for L Rating Only. Not Shown) — Fill material to be forced between blocks and periphery of opening to the max extent possible. Foam to be injected into all voids within the annular space between blocks to the full depth of the blocks (Item 2A).
3M COMPANY 3M FIRE PROTECTION PRODUCTS — Fire Barrier Rated Foam, FIP 1-Step

* Indicates such products shall bear the UL or cUL Certification Mark for jurisdictions employing the UL or cUL Certification (such as Canada), respectively.



Through Penetrations
Blanks
0000 Series
Gypsum
WL

System No. W-L-0050

August 01, 2016

| ANSI/UL1479 (ASTM E814) | CAN/ULC S115 |
|---|---|
| F Ratings — 1 and 2 Hr (See Item 1) | F Ratings — 1 and 2 Hr (See Item 1) |
| T Ratings — 1/2 and 1-3/4 Hr (See Item 1) | FT Ratings — 1/2 and 1-3/4 Hr (See Item 1) |
| L Rating At Ambient — Less Than 1 CFM/sq ft | FH Ratings — 1 and 2 Hr (See Item 1) |
| L Rating At 400 F — Less Than 1 CFM/sq ft | FTH Ratings — 1/2 and 1-3/4 Hr (See Item 1) |
| | L Rating At Ambient — Less Than 1 CFM/sq ft |
| | L Rating At 400 F — Less Than 1 CFM/sq ft |

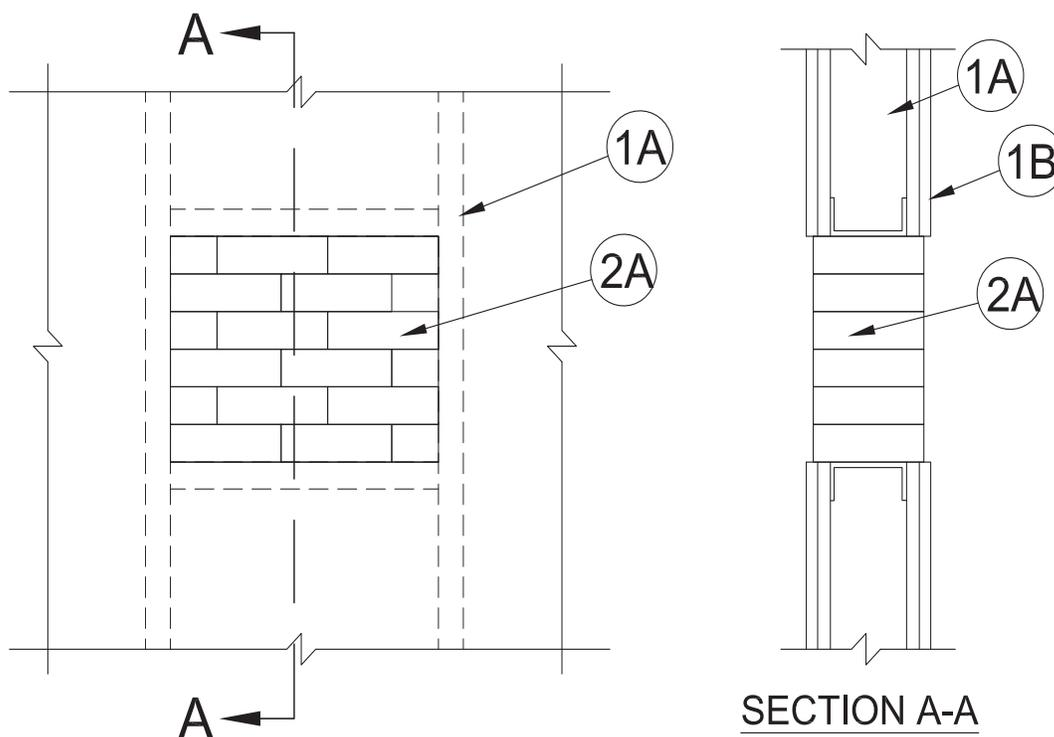

1. **Wall Assembly** — The 1 or 2 hr fire-rated gypsum board/stud wall assembly shall be constructed of the materials and in the manner specified in the individual U300, U400, V400 or W400 Series Wall and Partition Designs in the UL Fire Resistance Directory and shall include the following construction features:

A. **Studs** — Wall framing to consist of wood studs or channel shaped steel studs. Wood studs to consist of nom 2 by 4 in. (51 by 102 mm) lumber spaced 16 in. (406 mm) OC. Steel studs to be min 3-1/2 in. (89 mm) wide and spaced max 24 in. (610 mm) OC. Additional studs shall be used to completely frame the opening.

B. **Gypsum Board*** — One or two layers of nom 5/8 in. (16 mm) thick gypsum board, as specified in the individual Wall and Partition Design. Max area of opening is 1080 sq in. (6968 cm²) with a max dimension of 36 in. (914 mm).

The hourly F and FH Ratings of the firestop system are equal to the hourly fire rating of the wall assembly in which it is installed. The hourly T, FT and FTH Ratings of the firestop system are equal to 1/2 Hr when installed in 1 hr rated walls, and 1-3/4 Hr when installed in 2 hr rated walls.

2. **Firestop System** — The firestop system shall consist of the following:

A. **Fill, Void or Cavity Material*** — Blocks centered within wall opening with 5 in. (127 mm) dimension projecting through opening such that blocks are recessed max 1/2 in. (13 mm) from both surfaces of wall. Blocks to be tightly packed to fill the opening area.

3M COMPANY 3M FIRE PROTECTION PRODUCTS — 3M™ Fire Barrier Block B258, 3M™ Fire Barrier Plank PK39

B. **Fill, Void or Cavity Material*** — **Foam** — (Not Shown) — Fill material to be forced between blocks and periphery of opening to the max extent possible. Foam to be injected into all voids within the annular space between blocks to the full depth of the blocks (Item 2A).

3M COMPANY 3M FIRE PROTECTION PRODUCTS — Fire Barrier Rated Foam, FIP 1-Step

B1. **Fill, Void or Cavity Material*** — **Sealant or Caulk** — (Not Shown) — As an alternate to Item 2B, sealant to be forced between blocks and periphery of opening to the max extent possible. Sealant to be applied into all voids within the annular space between blocks to the full depth of the blocks (Item 2A).

3M COMPANY 3M FIRE PROTECTION PRODUCTS — IC 15WB+ Caulk, CP 25WB+ Caulk or FB-3000 WT Sealant

The L Ratings of the firestop system apply only when Item 2B Foam is used.

* Indicates such products shall bear the UL or cUL Certification Mark for jurisdictions employing the UL or cUL Certification (such as Canada), respectively.



System No. W-L-0051

July 01, 2016

| ANSI/UL1479 (ASTM E814) | CAN/ULC S115 |
|-------------------------------------|---------------------------------------|
| F Ratings — 1 and 2 Hr (See Item 1) | F Ratings — 1 and 2 Hr (See Item 1) |
| T Ratings — 1 and 2 Hr (See Item 1) | FT Ratings — 1 and 2 Hr (See Item 1) |
| | FH Ratings — 1 and 2 Hr (See Item 1) |
| | FTH Ratings — 1 and 2 Hr (See Item 1) |

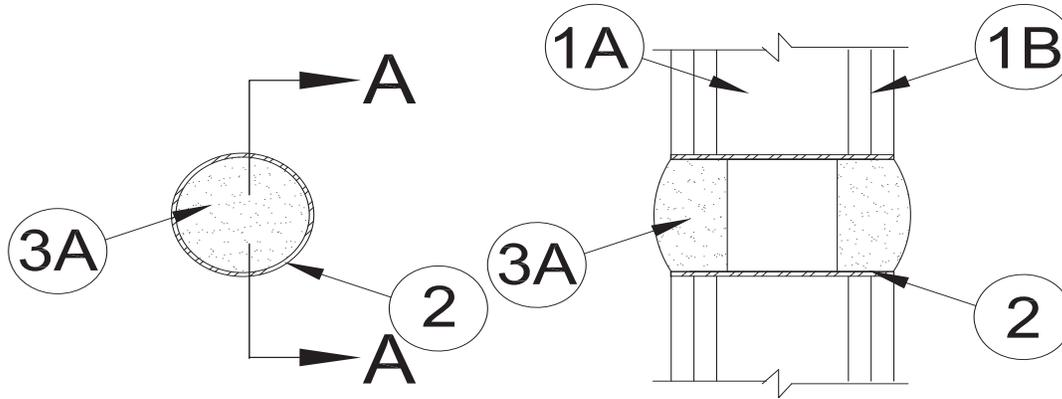

SECTION A-A

- Wall Assembly** — The 1 or 2 hr fire-rated gypsum board/stud wall assembly shall be constructed of the materials and in the manner specified if the individual U300, U400 or V400 Series Wall and Partition Designs in the Fire Resistance Directory and shall include the following construction features:
 - Studs** — Wall framing shall consist of either wood studs or channel shaped steel studs. Wood studs to consist of 2 by 4 in. (51 by 102 mm) lumber spaced max 16 in. (406 mm) OC. Steel studs to be min 3-1/2 in. (89 mm) wide, fabricated from min 25 MSG galvanized steel, spaced max 24 in. (610 mm) OC.
 - Gypsum Board*** — Nom 5/8 in. (16 mm) thick with square or tapered edges. The gypsum board type, number of layers and sheet orientation shall be as specified in the individual Wall and Partition Design Number. Max diam of opening is 2 in. (51 mm) or 4-1/2 in. (114 mm).

The hourly F, T, FT, FH and FTH Ratings of the firestop system are equal to the hourly fire rating of the wall assembly in which it is installed.
- Steel Sleeve** — Cylindrical sleeve fabricated from min 0.016 in. (0.41 mm) thick (No. 28 MSG) galv sheet steel and having a min 1 in. (25 mm) lap along the longitudinal seam. Sleeve installed by coiling the sheet steel to a diam smaller than the through opening, inserting the coil through the openings and releasing the coil to let it uncoil against the circular cutouts in the gypsum board layers. The ends of the steel sleeve shall be flush with each surface of the wall.
- Firestop System** — The firestop system shall consist of the following:
 - Fill, Void or Cavity Material*** — Plug sized for the steel sleeved opening per Table below friction-fitted within the sleeve at each side of wall such that the outer circumference of the dome-shaped plug is flush with both surfaces of the wall.

| Max. Sleeve/Opening Diam in. (mm) | Plug |
|---|--------|
| 2 (51) | PLG2** |
| 4.5 (114) | PLG4** |
| ** Cut wedge from plug to fit smaller sleeve/opening size. See 3M Installation Instructions for specific size of wedge cuts required. | |

3M COMPANY 3M FIRE PROTECTION PRODUCTS — 3M™ Fire Barrier Plug PLG2, 3M™ Fire Barrier Plug PLG4

* Indicates such products shall bear the UL or cUL Certification Mark for jurisdictions employing the UL or cUL Certification (such as Canada), respectively.



Through Penetrations
Blanks
0000 Series
Gypsum
WL

Metallic Pipes

CAJ

Concrete floors with a minimum thickness less than or equal to 5 inches (127 mm)
Concrete or masonry walls with a minimum thickness less than or equal to 8 inches (203 mm)

CBJ

Concrete floors with a minimum thickness greater than 5 inches (127 mm)
Concrete or masonry walls with a minimum thickness less than or equal to 8 inches (203 mm)

FA

Concrete floors/Steel decks
Concrete or masonry walls with a minimum thickness less than or equal to 8 inches (203 mm)

FB

Concrete floors/Steel decks
Concrete floors with a minimum thickness greater than 5 inches (127 mm)

FC

Floor assemblies
Framed floors

FE

Truss floor assemblies

WJ

Floor assemblies
Concrete or masonry walls with a minimum thickness less than or equal to 8 inches (203 mm)

WL

Wall assemblies
Framed walls

Metallic Pipes • Concrete

| 3M UL Systems | "F" Rating | 3M Product | Through Penetrant Details |
|---------------|------------|--|---|
| C-AJ-1001 | 1, 2, 3 | 3M™ Fire Barrier Sealant CP 25WB+ 3M™ Fire Barrier Water Tight Sealant 3000 WT 3M™ Fire Barrier Packing Material PM4 | Max. 30 inch steel or iron pipe, or max. 6 inch steel conduit penetrating a concrete wall or floor. Optional steel sleeve. |
| C-AJ-1006 | 1, 2, 3 | 3M™ Fire Barrier Sealant CP 25WB+ 3M™ Fire Barrier Composite Sheet CS-195+ 3M™ Fire Barrier Wrap Strips FS-195+ 3M™ Fire Barrier Moldable Putty Stix MP+ 3M™ Expantrol™ Flexible Intumescent Strip E-FIS 3M™ Fire Barrier Wrap Ultra GS 3M™ Fire Barrier Water Tight Sealant 3000 WT | Single max. 12 inch steel pipe or max. 6 in. copper pipe in a large (max. 36 square foot) opening in a concrete floor or wall. |
| C-AJ-1009 | 1, 2 | 3M™ Fire Barrier Silicone Sealant 2000+ 3M™ Fire Barrier Silicone Sealant 2000 NS 3M™ Fire Barrier Water Tight Sealant 1000 NS 3M™ Fire Barrier Water Tight Sealant 1003 SL | Max. 4 inch steel pipe or conduit penetrating a concrete floor or wall. Steel sleeve optional. |
| C-AJ-1013 | 1 | 3M™ Fire Barrier Silicone Sealant 2000+ 3M™ Fire Barrier Silicone Sealant 2000 NS 3M™ Fire Barrier Water Tight Sealant 1000 NS 3M™ Fire Barrier Water Tight Sealant 1003 SL | Max. 4 inch steel pipe or conduit penetrating a concrete floor or wall. |
| C-AJ-1014 | 1, 2 | 3M™ Fire Barrier Silicone Sealant 2000+ 3M™ Fire Barrier Water Tight Sealant 1000 NS 3M™ Fire Barrier Water Tight Sealant 1003 SL 3M™ Fire Barrier Water Tight Sealant 1003 SL | Max. 4 inch steel pipe or conduit penetrating a concrete floor or wall. |
| C-AJ-1027 | 1, 2, 3 | 3M™ Fire Barrier Moldable Putty Stix MP+ | Max. 10 inch steel or iron pipe, or max. 3 inch copper pipe penetrating a concrete floor or wall. |
| C-AJ-1044 | 2, 3, 4 | 3M™ Fire Barrier Sealant CP 25WB+ 3M™ Fire Barrier Water Tight Sealant 3000 WT | Single metallic pipe penetrating a minimum 4-1/2 in. thick concrete floor or wall. Max. 30 in. steel or iron pipe, max. 6 in. copper or conduit, max. 4 in. EMT. |
| C-AJ-1052 | 2 | 3M™ Fire Barrier Sealant CP 25WB+ | Single 4 inch diameter aluminum or steel flexible metallic conduit penetrating a concrete floor or wall. |
| C-AJ-1058 | 3 | 3M™ Fire Barrier Silicone Sealant 2000+ 3M™ Fire Barrier Water Tight Sealant 1000 NS 3M™ Fire Barrier Water Tight Sealant 1003 SL 3M™ Fire Barrier Water Tight Sealant 3000 WT 3M™ Fire Barrier Packing Material PM4 | Single metallic pipe penetrating a minimum 4-1/2 in. thick concrete floor or wall. Max. 24 in. steel or iron pipe, max. 6 in. copper or conduit, max. 4 in. EMT. |
| C-AJ-1060 | 2 | 3M™ Fire Barrier Silicone Sealant 2000+ | Single max. 2 in. copper pipe penetrating a minimum 4-1/2 in. thick concrete floor or wall. Opening size max. 30 square inch. Utilizing FB 2000+ Silicone Sealant. |
| C-AJ-1066 | 2, 3 | 3M™ Fire Barrier Sealant CP 25WB+ 3M™ Fire Barrier Water Tight Sealant 3000 WT | Multiple copper or steel pipes penetrating a max. 45 square inch opening in a min. 4.5 in. thick concrete floor or wall. Max. 3 in. copper pipe or max. 2.5 in. steel pipe. |
| C-AJ-1091 | 2 | 3M™ Fire Barrier Sealant CP 25WB+ | Single 2 inch diameter aluminum flexible metallic conduit penetrating a concrete floor or wall. |
| C-AJ-1092 | 2 | 3M™ Fire Barrier Sealant CP 25WB+ 3M™ Fire Barrier Water Tight Sealant 3000 WT | Multiple copper or steel pipes penetrating a max. 560 square inch opening in a min. 4.5 in. thick concrete floor or wall. Firestop utilizes mineral wool and 20 gauge sheet steel support hangers. Max. 4 in. copper pipe or max. 6 in. steel pipe. |
| C-AJ-1112 | 2, 3 | 3M™ Fire Barrier Sealant CP 25WB+ 3M™ Fire Barrier Wrap Strips FS-195+ 3M™ Fire Barrier Water Tight Sealant 3000 WT | Max. 10 inch closed process aluminum pipe penetrating a min. 4.5 in. thick concrete floor or wall. |
| C-AJ-1175 | 2 | 3M™ Fire Barrier Sealant CP 25WB+ 3M™ Fire Barrier Water Tight Sealant 3000 WT | Single metallic pipe penetrating a minimum 2-1/2 in. thick concrete floor or wall with bottom side access. Max. 8 in. steel pipe, max. 6 in. copper or conduit, max. 4 in. EMT or iron. |
| C-AJ-1176 | 2, 3 | 3M™ Fire Barrier Sealant CP 25WB+ | Single 4 inch diameter aluminum or steel flexible metallic conduit penetrating a concrete floor or wall. |
| C-AJ-1188 | 2, 3 | 3M™ Fire Barrier Silicone Sealant 2000+ 3M™ Fire Barrier Water Tight Sealant 1000 NS 3M™ Fire Barrier Water Tight Sealant 1003 SL 3M™ Fire Barrier Water Tight Sealant 3000 WT | Single metallic pipe penetrating a minimum 4-1/2 in. thick concrete floor or wall. Max. 12 in. steel pipe, max. 6 in. copper or conduit, max. 4 in. EMT. |
| C-AJ-1216 | 2 | 3M™ Fire Barrier Sealant CP 25WB+ | Single 1 inch diameter steel flexible metallic conduit penetrating a concrete floor or wall. |
| C-AJ-1225 | 2 | 3M™ Fire Barrier Sealant CP 25WB+ | Single 2 inch diameter steel flexible metallic conduit penetrating a concrete floor or wall. |
| C-AJ-1241 | 2 | 3M™ Fire Barrier Sealant CP 25WB+ | Single 2 inch diameter steel flexible metallic conduit penetrating a concrete floor or wall. |

Metallic Pipes • Concrete

| 3M UL Systems | "F" Rating | 3M Product | Through Penetrant Details |
|---------------|------------|--|---|
| C-AJ-1274 | 2, 3 | 3M™ Fire Barrier Sealant CP 25WB+ 3M™ Fire Barrier Water Tight Sealant 3000 WT | Single metallic pipe penetrating a minimum 4-1/2 in. thick concrete floor or wall. Max. 24 in. steel or iron pipe, max. 6 in. copper or conduit, max. 4 in. EMT. |
| C-AJ-1275 | 2 | 3M™ FireDam™ Spray 200 | Single metallic pipe penetrating a minimum 4-1/2 in. thick concrete floor or wall utilizing mineral wool and FireDam Spray 200. Max. 6 in. steel or iron pipe, max. 6 in. copper or conduit, max. 4 in. EMT. |
| C-AJ-1292 | 2, 3 | 3M™ Fire Barrier Water Tight Sealant 1000 NS 3M™ Fire Barrier Water Tight Sealant 1003 SL 3M™ Fire Barrier Water Tight Sealant 3000 WT | Single metallic pipe penetrating a minimum 4-1/2 in. thick concrete floor or wall. Max. 4 in. steel pipe, iron pipe, steel conduit, or EMT and max. 3 in. copper pipes/tubes. |
| C-AJ-1306 | 2 | 3M™ Fire Barrier Sealant CP 25WB+ 3M™ Fire Barrier Water Tight Sealant 3000 WT | Single 8 inch aluminum conduit for beverage lines penetrating a concrete floor or wall. |
| C-AJ-1317 | 2 | 3M™ Fire Barrier Sealant FD 150+ 3M™ Fire Barrier Packing Material PM4 | Single metallic pipe penetrating a minimum 4-1/2 in. thick concrete floor or wall utilizing mineral wool and FD 150+ Sealant. Max. 8 in. steel or iron pipe, max. 6 in. steel conduit, or max. 4 in. EMT or copper pipe. |
| C-AJ-1338 | 2 | 3M™ Fire Barrier Sealant CP 25WB+ 3M™ Fire Barrier Water Tight Sealant 3000 WT | Single metallic pipe penetrating a minimum 2-1/2 in. thick concrete floor or wall. Max. 24 in. steel or iron pipe, max. 6 in. copper or conduit, max. 4 in. EMT. |
| C-AJ-1364 | 2 | 3M™ Fire Barrier Water Tight Sealant 1000 NS 3M™ Fire Barrier Water Tight Sealant 1003 SL 3M™ Fire Barrier Water Tight Sealant 3000 WT | Single metallic pipe penetrating a minimum 4-1/2 in. thick concrete floor or wall. Max. 24 in. steel or iron pipe, max. 6 in. copper or conduit, max. 4 in. EMT. |
| C-AJ-1366 | 2 | 3M™ Fire Barrier Sealant FD 150+ | Single metallic pipe penetrating a minimum 4-1/2 in. thick concrete floor or wall. Max. 8 in. steel or iron pipe, max. 6 in. conduit, max. 4 in. copper pipe or EMT. |
| C-AJ-1427 | 2, 3 | 3M™ Fire Barrier Sealant IC 15WB+ 3M™ Fire Barrier Sealant CP 25WB+ 3M™ Fire Barrier Water Tight Sealant 3000 WT | Single metallic pipe penetrating a minimum 4-1/2 in. thick concrete floor or wall. Max. 10 in. steel or iron pipe, max. 6 in. conduit, max. 4 in. copper pipe or EMT. |
| C-AJ-1428 | 2 | 3M™ Fire Barrier Sealant IC 15WB+ 3M™ Fire Barrier Sealant CP 25WB+ 3M™ Fire Barrier Water Tight Sealant 3000 WT 3M™ Fire Barrier Packing Material PM4 | Multiple metallic pipes penetrating a minimum 2.5 in. thick concrete floor or concrete wall. Max. 12 in. diameter opening. Steel sleeve optional. Max. 4 in. steel or iron, max. 3 in. copper pipe, max. 2 in. flexible metallic conduit. |
| C-AJ-1429 | 2 | 3M™ Fire Barrier Sealant IC 15WB+ 3M™ Fire Barrier Sealant CP 25WB+ 3M™ Fire Barrier Water Tight Sealant 3000 WT | Multiple metallic pipes penetrating a minimum 2.5 in. thick concrete floor or concrete wall. Max. 240 square in. opening with a max. 30 in. dimension. Steel sleeve optional. Max. 6 in. steel or iron, max. 4 in. EMT, max. 3 in. copper pipe, max. 2 in. flexible metallic conduit. |
| C-AJ-1473 | 2 | 3M™ Fire Barrier Sealant IC 15WB+ 3M™ Fire Barrier Sealant CP 25WB+ 3M™ Fire Barrier Water Tight Sealant 3000 WT 3M™ Fire Barrier Duct Wrap 615+ 3M™ Fire Barrier Duct Wrap 615 | Equal F and T for a single metallic pipe penetrating a min. 4.5 in. thick concrete floor or wall. Utilizing mineral wool, sealant, and Fire Barrier Duct Wrap. Max. 10 in. steel or iron, max. 6 in. steel conduit, max. 4 in. EMT or copper pipe. |
| C-AJ-1496 | 2, 3 | 3M™ Fire Barrier Sealant CP 25WB+ 3M™ Fire Barrier Sealant IC 15WB+ 3M™ Fire Barrier Water Tight Sealant 3000 WT | Single metallic pipe penetrating a min. 4.5 in. thick concrete floor or wall with bottom side or both side access. Steel sleeve optional. Max. 10 in. steel or iron pipe, max. 6 in. steel conduit, max. 4 in. EMT or copper pipe. |
| C-AJ-1540 | 2, 3 | 3M™ Fire Barrier Pass-Through Products 3M™ Fire Barrier Water Tight Sealant 3000 WT 3M™ Fire Barrier Sealant CP 25WB+ 3M™ Fire Barrier Sealant IC 15WB+ 3M™ Fire Barrier Moldable Putty Stix MP+ | Multiple max. 3 in. metallic pipes penetrating a 2 or 3 hour rated concrete floor or wall utilizing 3M Fire Barrier Pass-Through Device(s). A single round device or up to three square devices ganged together. |
| C-AJ-1551 | 2 | 3M™ Fire Barrier Sealant CP 25WB+ 3M™ Fire Barrier Sealant IC 15WB+ 3M™ Fire Barrier Water Tight Sealant 3000 WT | Single metallic pipe penetrating a minimum 2-1/2 in. thick concrete floor or wall utilizing sealant only. Max. 24 in. steel or iron pipe, max. 6 in. steel conduit or copper pipe, max. 4 in. EMT. Steel sleeve optional. |
| C-AJ-1552 | 2, 3 | 3M™ Fire Barrier Sealant CP 25WB+ 3M™ Fire Barrier Sealant IC 15WB+ 3M™ Fire Barrier Water Tight Sealant 3000 WT | Single metallic pipe penetrating a min. 2.5 in. thick concrete floor or wall with bottom side or both side access. Steel sleeve optional. Max. 24 in. steel or iron pipe, max. 6 in. steel conduit or copper pipe, max. 4 in. EMT. |
| C-AJ-1611 | 2 | 3M™ Fire Barrier Pillows 3M™ Fire Barrier Self-Locking Pillows 3M™ Fire Barrier Moldable Putty Stix MP+ | Multiple metallic pipes penetrating a max. 504 square inch opening in a concrete floor or wall utilizing Fire Barrier Pillows/Self Locking Pillows. |
| C-AJ-1626 | 2 | 3M™ Fire Barrier Sealant IC 15WB+ 3M™ Fire Barrier Sealant CP 25WB+ 3M™ Fire Barrier Water Tight Sealant 3000 WT | Single max. 8 in. steel or iron pipe having a compression coupling located within the plane of the rated concrete floor or wall. |

Metallic Pipes • Concrete

| 3M UL Systems | "F" Rating | 3M Product | Through Penetrant Details |
|---------------|------------|--|---|
| C-AJ-1628 | 2 | 3M™ Fire Barrier Rated Foam FIP 1-Step | Single metallic pipe penetrating a minimum 2-1/2 in. thick concrete floor or wall utilizing Fire Barrier Rated Foam, FIP 1-Step. Max. 8 in. steel or iron pipe, max. 6 in. conduit, max. 4 in. copper pipe or EMT. |
| C-AJ-1629 | 2 | 3M™ Fire Barrier Rated Foam FIP 1-Step | Single metallic pipe penetrating a minimum 2-1/2 in. thick concrete floor or wall utilizing Fire Barrier Rated Foam, FIP 1-Step. Optional steel sleeve. Max. 8 in. steel or iron pipe, max. 6 in. conduit, max. 4 in. copper pipe or EMT. |
| C-AJ-1631 | 2, 3 | 3M™ Fire Barrier Mortar | Multiple metallic pipes penetrating a max. 1656 square inch opening in a concrete floor or wall utilizing Fire Barrier Mortar. |
| C-AJ-1668 | 2 | 3M™ Fire Barrier Block 3M™ Fire Barrier Plank 3M™ Fire Barrier Rated Foam FIP 1-Step | Multiple metallic pipes penetrating the same max. 1296 square inch opening in a concrete floor or wall utilizing Fire Barrier Blocks/Planks and Fire Barrier Rated Foam, FIP 1-Step. |
| C-AJ-1672 | 2 | 3M™ Fire Barrier Blocks 3M™ Fire Barrier Planks 3M™ Fire Barrier Water Tight Sealant 3000 WT | Multiple metallic pipes penetrating the same max. 900 square inch opening in a concrete floor or wall utilizing Fire Barrier Blocks/Planks and sealant. |
| C-BJ-1020 | 4 | 3M™ Fire Barrier Sealant CP 25WB+ 3M™ Fire Barrier Sealant IC 15WB+ 3M™ Fire Barrier Composite Sheet CS-195+ 3M™ Fire Barrier Wrap Strips FS-195+ 3M™ Expanrol™ Flexible Intumescent Strip E-FIS | Multiple metallic pipes penetrating a 4 hour, min. 5.5 in. thick concrete floor or wall. Maximum opening size 1500 square in. with a max. 50 in. dimension. Utilizing CS 195+ Composite Sheet and FS-195+ for larger pipes. |
| F-A-1002 | 1, 2 | 3M™ Fire Barrier Sealant CP 25WB+ 3M™ Fire Barrier Water Tight Sealant 3000 WT | Multiple metallic pipes penetrating the same max. 192 square in. opening in a concrete floor. Utilizing packing material and sealant. |
| F-A-1011 | 1, 2 | 3M™ Fire Barrier Sealant CP 25WB+ 3M™ Fire Barrier Water Tight Sealant 3000 WT | Single max. 1 in. metallic pipe penetrating a hollow core concrete floor. Utilizing packing material and sealant. |
| F-A-1019 | 4 | 3M™ Fire Barrier Sealant CP 25WB+ 3M™ Fire Barrier Water Tight Sealant 3000 WT | Single metallic pipe penetrating a 4 hour rated concrete floor over fluted steel deck having Spray-Applied Fire Resistive Material on the bottom of the deck. |
| F-A-1041 | 1, 2 | 3M™ Fire Barrier Cast-In Devices for Metal Pipes 3M™ Fire Barrier Moldable Putty Stix MP+ 3M™ Fire Barrier Water Tight Sealant 1003 SL 3M™ Fire Barrier Water Tight Sealant 1000 NS 3M™ Fire Barrier Water Tight Sealant 3000 WT | Fire Barrier Metal Cast-In Device with a single metallic pipe penetrating a concrete floor. |
| F-A-1042 | 1, 2, 3 | 3M™ Fire Barrier Cast-In Devices for Metal Pipes 3M™ Fire Barrier Moldable Putty Stix MP+ 3M™ Fire Barrier Water Tight Sealant 1003 SL 3M™ Fire Barrier Water Tight Sealant 1000 NS 3M™ Fire Barrier Water Tight Sealant 3000 WT 3M™ Fire Barrier Cast-In Device Height Adaptors | Fire Barrier Metal Cast-In Device with a single metallic pipe penetrating a concrete floor. |
| F-A-1046 | 1, 2 | 3M™ Fire Barrier Cast-In Devices for Metal Pipes 3M™ Fire Barrier Moldable Putty Stix MP+ 3M™ Fire Barrier Cast-In Device Metal Deck Adaptors | Fire Barrier Metal Cast-In Device with Metal Deck Adapter with a single metallic pipe penetrating a concrete floor over fluted steel deck. |
| F-A-1050 | 1, 2, 3 | 3M™ Fire Barrier Cast-In Devices for Metal Pipes 3M™ Fire Barrier Water Tight Sealant 1000 NS 3M™ Fire Barrier Water Tight Sealant 1003 SL 3M™ Fire Barrier Sealant CP 25WB+ 3M™ Fire Barrier Sealant FD 150+ 3M™ Fire Barrier Sealant IC 15WB+ 3M™ Fire Barrier Moldable Putty Stix MP+ 3M™ Fire Barrier Water Tight Sealant 3000 WT | Multiple metallic pipes penetrating the same Fire Barrier Metal Cast-In Device penetrating a concrete floor. |
| F-A-1057 | 1, 2 | 3M™ Fire Barrier Sealant CP 25WB+ 3M™ Fire Barrier Moldable Putty Stix MP+ 3M™ Fire Barrier Water Tight Sealant 3000 WT 3M™ Fire Barrier Duct Wrap 615+ 3M™ Fire Barrier Duct Wrap 615 | Equal F and T for a single metallic pipe penetrating a min. 4.5 in. thick concrete floor or wall. Utilizing mineral wool, sealant, and Fire Barrier Duct Wrap. Max. 10 in. steel or iron, max. 6 in. steel conduit, max. 4 in. EMT or copper pipe. Optional steel sleeve. |
| F-A-1064 | 1, 2, 3 | 3M™ Fire Barrier Mortar | Multiple metallic pipes penetrating the same max. 180 square in. opening in a concrete floor. Utilizing Fire Barrier Mortar. |
| F-A-1065 | 1, 2, 3 | 3M™ Fire Barrier Mortar | Multiple metallic pipes penetrating the same max. 180 square in. opening in a concrete floor. Utilizing Fire Barrier Mortar. |
| F-A-1067 | 1, 2, 3 | 3M™ Fire Barrier Cast-In Devices for Metal Pipes | Fire Barrier Metal Cast-In Device 6MCID with a single 6 in. metallic pipe penetrating a concrete floor. |

Metallic Pipes • Concrete

| 3M UL Systems | "F" Rating | 3M Product | Through Penetrant Details |
|---------------|------------|--|--|
| F-A-1092 | 1, 2, 3 | 3M™ Fire Barrier Cast-In Devices for Metal Pipes | Fire Barrier Metal Cast-In Device 6MCID with Metal Deck Adapter with a single 6 in. metallic pipe penetrating a concrete floor over fluted steel deck. |
| F-A-1102 | 1, 2 | 3M™ Fire Barrier Water Tight Sealant 1003 SL | Single or multiple max. 12 in. steel or iron pipes penetrating the same max. 98 square in. opening in a concrete floor. Utilizing packing material and FB 1000SL Self-Leveling Silicone Sealant. |
| F-A-1112 | 1, 2 | 3M™ Fire Barrier Water Tight Sealant 1000 NS | Single metallic pipe penetrating a concrete floor with bottom side access. Utilizing FB 1000NS Silicone Sealant. |
| F-A-1131 | 1, 2 | 3M™ Fire Barrier Tuck-In Wrap Strips 3M™ Fire Barrier Duct Wrap 615+ | Equal F and T rating for a max. 12 in. x 12 in. floor sink fully cast into a concrete floor slab. Max. 4 in. cast or ductile iron drain pipe with compression fittings. Utilizing Fire Barrier Duct Wrap 615+ and Tuck-In Wrap Strip. |
| F-A-1160 | 1, 2 | 3M™ Fire Barrier Duct Wrap 615+ 3M™ Fire Barrier Sealant CP 25WB+ 3M™ Fire Barrier Water Tight Sealant 3000 WT | Equal F and T rating for a max. 12 in. x 12 in. floor sink fully cast into a concrete floor slab or concrete floor over fluted steel deck. Max. 4 in. cast or ductile iron drain pipe with compression fittings. Utilizing Fire Barrier Duct Wrap 615+. |
| F-B-1006 | 1 | 3M™ Fire Barrier Sealant CP 25WB+ 3M™ Fire Barrier Water Tight Sealant 3000 WT | 1" steel conduit, 1" steel EMT, 1" steel flexible conduit. Max diam of opening 2". Hollow core included. Min 1/8" to max 1/2" annular space. 1 hour F Rating. Firestop at top and bottom of floor. Also known as FB1006. |
| F-B-1011 | 1, 2, 3 | 3M™ Fire Barrier Cast-In Devices for Metal Pipes | Single cast or ductile iron drain pipe penetrating a concrete floor with the use of a Fire Barrier Metallic Cast-In Device and Aerator Adapter. |
| W-J-1010 | 1, 2, 3 | 3M™ Fire Barrier Sealant CP 25WB+ | Multiple max. 3 in. steel pipes or steel conduits penetrating the same max. 12 in. diameter opening in a concrete wall. |
| W-J-1111 | 1, 2 | 3M™ Fire Barrier Moldable Putty Stix MP+ 3M™ Fire Barrier Pillows 3M™ Fire Barrier Self-Locking Pillows | Multiple max. 4 in. steel conduits penetrating a max. 225 square inch opening in a concrete wall. Utilizing Fire Barrier Pillows. |
| W-J-1122 | 1, 2 | 3M™ Fire Barrier Sealant CP 25WB+ 3M™ Fire Barrier Sealant IC 15WB+ | Multiple 3" steel, iron, cast, conduit, EMT, 2" copper tubing or pipe, 2" steel flexible metal piping. Also referred as WJ1122. |
| W-J-1127 | 1, 2 | 3M™ Fire Barrier Sealant CP 25WB+ 3M™ Fire Barrier Sealant IC 15WB+ | Multiple 8" steel, iron, cast, 6" rigid conduit, EMT, 2" copper tubing or pipe, 2" steel flexible metal piping. Also referred as WJ1127. |
| W-J-1139 | 1, 2 | 3M™ Fire Barrier Sealant CP 25WB+ 3M™ Fire Barrier Sealant IC 15WB+ | Multiple max. 3" steel pipe or conduit, max. 182 sq. in. with one dimension max. 45-1/2". Also referred as WJ1139. |
| W-J-1155 | 1, 2 | 3M™ Fire Barrier Sealant CP 25WB+ 3M™ Fire Barrier Sealant IC 15WB+ | 8" steel, 8" iron, 4" EMT, 6" rigid steel conduit, 4" copper pipe or tubing. Concentric or eccentric installation. Penetrant can be installed up to 45 degree from perpendicular. Point contact to max 3-1/2" annular. Max diam of opening 12". 2 hr. F. Also referred as WJ1155. |
| W-J-1156 | 1, 2 | 3M™ Fire Barrier Water Tight Sealant 1000 NS | Max 6" steel, 6" iron, 4" EMT or steel conduit, 3" copper tubing or pipe. One penetrant centered. Max opening min 1/2" to max 4" greater than outside diameter of penetrant. Annular min 1/4" to max 2". 2 hr F. Caulk only system. Also known as WJ1156. |
| W-J-1205 | 1, 2 | 3M™ Fire Barrier Sealant CP 25WB+ 3M™ Fire Barrier Water Tight Sealant 3000 WT 3M™ Fire Barrier Sealant IC 15WB+ | Max 4 in. Sch 10 steel, max 4 in. cast iron. Compression coupling with min 1/2 in. extending from wall. Min 6 in. concrete. Max opening 5-1/2 in. Point contact to max 1/2 in. annular. Concentric/eccentric installation. 2 hour F rating. Sealant only-no mineral wool required. Also known as WJ1205. |
| W-J-1218 | 1, 2 | 3M™ Fire Barrier Sealant CP 25WB+ 3M™ Fire Barrier Sealant IC 15WB+ 3M™ Fire Barrier Water Tight Sealant 3000 WT | Max 12 in. steel, max 12 in. iron, max 6 in. steel conduit, max 4 in. EMT, max 6 in. copper tubing, max 6 in. copper pipe. Min 6 in. concrete wall. Max diam of opening 12-3/4 in. Continuous point contact only. 2 hour F rating. Also known as WJ1218. |
| W-J-1229 | 1, 2 | 3M™ Fire Barrier Sealant CP 25WB+ 3M™ Fire Barrier Sealant IC 15WB+ 3M™ Fire Barrier Water Tight Sealant 3000 WT | Min 6 in. concrete wall. Multiple single row of max 4 in. steel, max 4 in. steel conduit, max 4 in. EMT, max 4 in. iron, max 4 in. copper tubing, max 4 in. copper pipe. Max opening 6 in. high and 36 in. wide. Point contact to max 2 in. annular. Min 1-1/4 in. to max 2 in. spacing. Optional mineral wool. 2 hour F rating. Also known as WJ1229. |
| W-J-1231 | 1, 2 | 3M™ Fire Barrier Rated Foam FIP 1-Step | One or more: max 4 in. EMT, max 4 in. steel conduit. Min 6 in. concrete wall or concrete block wall. Max 720 sq. in. opening with max 30 in. dimension. Min 1 in. to max 3 in. annular. Penetrants min 1 in. to max 2 in. apart. 2 hour F rating. See system for T rating. Also known as WJ1231. |

Metallic Pipes • Concrete

| 3M UL Systems | "F" Rating | 3M Product | Through Penetrant Details |
|---------------|------------|--|---|
| W-J-1232 | 1, 2 | 3M™ Fire Barrier Rated Foam FIP 1-Step | Max 8 in. steel, max 8 in. iron, max 6 in. conduit, max 4 in. EMT, max 4 in. copper tubing, max 4 in. copper pipe. Min 6 in. concrete wall. Concrete block walls. Max diameter of opening 12-1/2 in. Min 1/2 in. to max 3-3/8 in. annular space. Concentric/eccentric installation. 2 hour F rating. 1/2 hour T rating. Also known as WJ1232. |
| W-J-1247 | 1, 2 | 3M™ Fire Barrier Composite Sheet CS-195+ 3M™ Fire Barrier Moldable Putty+ Pads and Sticks 3M™ Fire Barrier Sealant IC 15WB+ 3M™ Fire Barrier Sealant CP 25WB+ 3M™ Fire Barrier Water Tight Sealant 3000 WT | Multiple max. 4 in. steel conduits with one max. 6 in. conduit penetrating the same max. 720 square inch opening in a concrete wall. |
| W-J-1281 | 1, 2 | 3M™ Fire Barrier Sealant CP 25WB+ 3M™ Fire Barrier Sealant IC 15WB+ 3M™ Fire Barrier Water Tight Sealant 3000 WT | Metallic pipe (steel, iron, copper, steel conduit) penetrating a concrete wall with single side access. |
| W-J-1282 | 1, 2 | 3M™ Fire Barrier Sealant CP 25WB+ 3M™ Fire Barrier Sealant IC 15WB+ 3M™ Fire Barrier Water Tight Sealant 3000 WT 3M™ Fire Barrier Sealant FD 150+ 3M™ Fire Barrier Water Tight Sealant 1000 NS 3M™ Fire Barrier Moldable Putty Stix MP+ | 16 gauge steel pull or junction box mounted against a concrete wall. 1 in. steel conduit penetrates through the wall and out the opposite side. |
| W-J-1283 | 1, 2 | 3M™ Fire Barrier Sealant CP 25WB+ 3M™ Fire Barrier Sealant IC 15WB+ 3M™ Fire Barrier Water Tight Sealant 3000 WT 3M™ Fire Barrier Water Tight Sealant 1000 NS | Metallic pipe (steel, iron, copper, steel conduit) penetrating a concrete wall with single side access. |

System No. C-AJ-1001

March 05, 2007

F Rating – 3 Hr

T Rating – 0 Hr

W Rating – Class 1 (See Item 4)

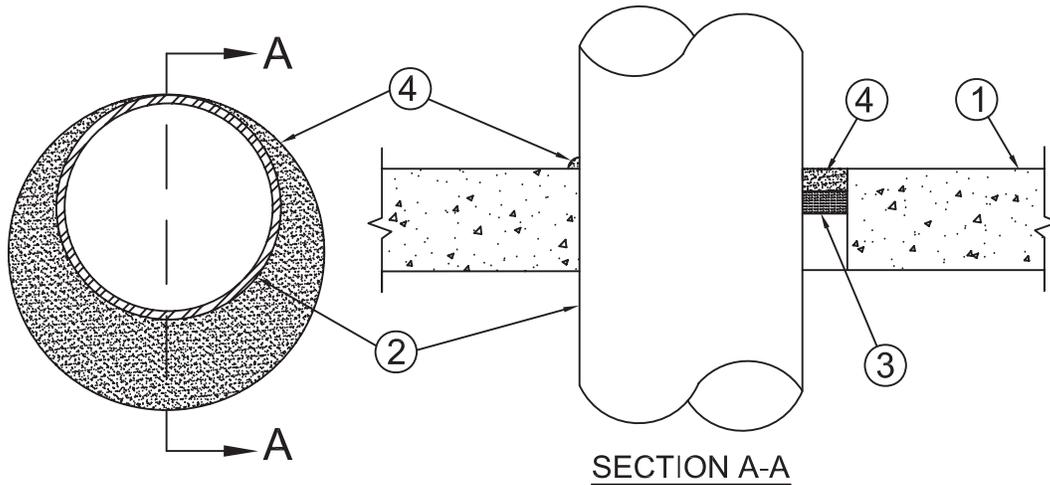

1. **Floor or Wall Assembly** – Min 4-1/2 in. (114 mm) thick lightweight or normal weight (100-150 pcf or 1600-2400 kg/m³) concrete. Wall may also be constructed of any UL Classified **Concrete Blocks***. Max diam of circular through opening is 32-1/2 in. (826 mm).
See **Concrete Blocks (CAZT)** category in the Fire Resistance Directory for names of manufacturers.
- 1A. **Steel Sleeve** (Optional, not shown) – Nom 12 in. (305 mm) diam (or smaller) Schedule 40 (or heavier) steel pipe sleeve cast into concrete floor or wall. Sleeve to be flush with or project max 2 in. (51 mm) from top surface of floor or from both surfaces of wall. As an alternate, nom 12 in. (305 mm) diam (or smaller) sleeve fabricated from nom 0.019 in. (0.48 mm) thick galv steel cast or grouted into floor or wall assembly flush with floor or wall surfaces.
2. **Through Penetrant** – One metallic pipe, conduit or tubing installed either concentrically or eccentrically within the firestop system. The annular space between pipe, conduit or tubing and periphery of opening shall be min of 0 in. (0 mm, point contact) to max 1-3/8 in. (35 mm). Pipe, conduit or tubing to be rigidly supported on both sides of wall assembly. The following types and sizes of metallic pipes, conduits or tubing may be used:
 - A. **Steel Pipe** – Nom 30 in. (762 mm) diam (or smaller) Schedule 10 (or heavier) steel pipe.
 - A1. **Iron Pipe** – Nom 30 in. (762 mm) diam (or smaller) cast or ductile iron pipe.
 - B. **Conduit** – Nom 6 in. (152 mm) diam (or smaller) rigid steel conduit.
 - C. **Conduit** – Nom 4 in. (102 mm) diam (or smaller) steel electrical metallic tubing.
3. **Packing Material** – Polyethylene backer rod or nom 1 in. (25 mm) thickness of tightly-packed ceramic (alumina silica) fiber blanket, mineral wool batt or glass fiber insulation material used as a permanent form. Packing material to be recessed from top surface of floor or from both surfaces of solid concrete or concrete block wall as required to accommodate the required thickness of caulk fill material (Item 4). As an alternate when max pipe size is 10 in. (254 mm) diam and when max annular space is 1 in. (25 mm), a min 1 in. (25 mm) thickness of tightly-packed ceramic fiber blanket or mineral wool batt packing material may be recessed min 1/2 in. (13 mm) from bottom surface of floor or from either side of solid concrete wall.
4. **Fill, Void or Cavity Materials*** – **Caulk or Sealant** – Applied to fill the annular space to the min thickness shown in the following table:

| Max Pipe Diam In. (mm) | Max Annular Space In. (mm) | Packing Mtl Type (a) | Min Caulk Thkns In. (mm) |
|------------------------|----------------------------|----------------------|--------------------------|
| 10 (254) | 1 (25) | BR, CF, GF or MW | 1/2 (13) (b) |
| 10 (254) | 1 (25) | CF or MW | 1/2 (13) (c) |
| 30 (762) | 2-1/2 (64) | BR, CF, GF or MW | 1 (25) (b) |

(a) BR = Polyethylene backer rod.

CF = Ceramic fiber blanket.

GF = Glass fiber insulation.

MW = Mineral-wool batt.

(b) Caulk installed flush with top surface of floor or both surfaces of wall.

(c) Caulk installed flush with bottom surface of floor or one surface of solid (non-concrete block) wall.

3M COMPANY – CP 25WB+ or FB-3000 WT

(Note: W Rating applies only when FB-3000 WT is used on top surface of floor and when it laps onto concrete for sleeved opening.)

*Bearing the UL Classification Marking

Reprinted from the Online Certifications Directory with permission from Underwriters Laboratories Inc.

Copyright © 2010 Underwriters Laboratories Inc.®



System No. C-AJ-1006

September 03, 2004

(Formerly System No. 93)

F Ratings – 1, 2 and 3 Hr (See Items 1 and 3)

T Rating – 0 Hr

L Rating At Ambient – 2 CFM/sq ft (See Item 5)

L Rating At 400 F – less than 1 CFM/sq ft (See Item 5)

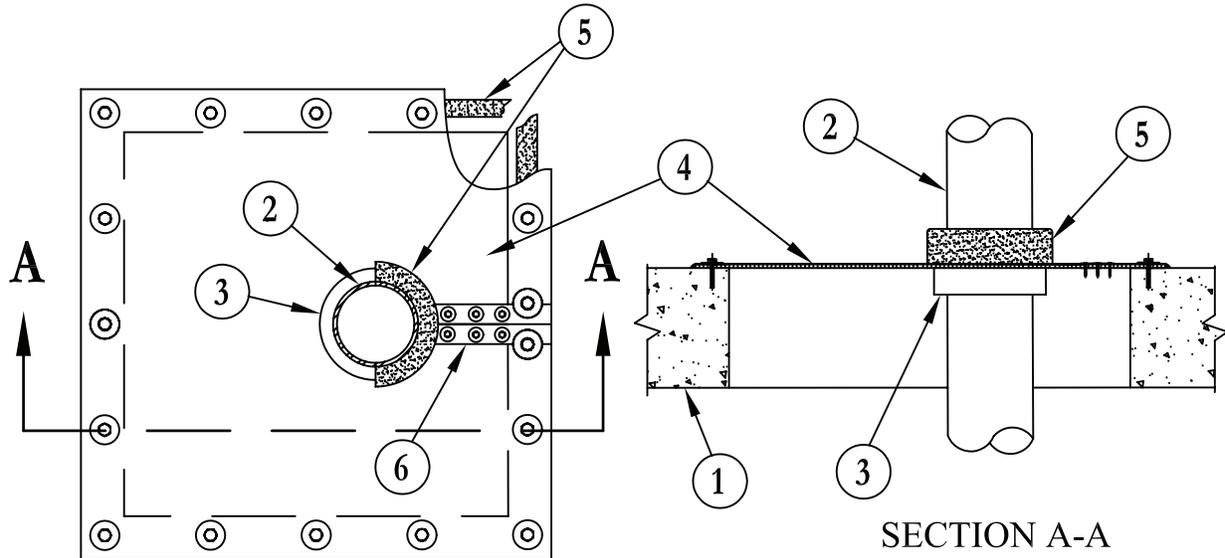

- 1. Floor or Wall Assembly** – Lightweight or normal weight (100-150 pcf or 1600-2400 kg/m³) concrete. Min thickness of concrete floor or wall is 2-1/2 in. (64 mm) for 1 hr F Rating and 4-1/2 in. (114 mm) for 2 or 3 hr F Rating. Wall may also be constructed of any UL Classified **Concrete Blocks***. Max area of opening 36 sq ft (3.4 m²) with one dimension of opening being 36 in. (914 mm) or less.

See **Concrete Blocks (CAZT)** category in the Fire Resistance Directory for names of manufacturers.

- 2. Pipe or Conduit** – Nom 12 in. (305 mm) diam (or smaller) Schedule 10 (or heavier) steel pipe, nom 6 in. (152 mm) diam (or smaller) steel conduit, nom 4 in. (102 mm) diam (or smaller) steel EMT or nom 6 in. (152 mm) diam (or smaller) Type L (or heavier) copper tubing. Min clearance between pipes 1 in. (25 mm) Min clearance between pipe and wall of through opening 1/4 in. (6 mm). When single nom 4 in. (102 mm) diam (or smaller) pipe, conduit or EMT is installed in nom 7 in. (178 mm) diam (or smaller) circular through opening, min clearance between pipe, conduit or EMT and wall of through opening is 0 in. (0 mm) (point contact). Pipes and conduits rigidly supported on both sides of floor or wall assembly.
- 3. Fill, Void or Cavity Materials* – Wrap Strip** – Nom 1/4 in. (6 mm) thick intumescent elastomeric material faced on one side with aluminum foil, supplied in strips. Min 2 in. (51 mm) wide strip wrapped around pipe/conduit (foil side exposed) and secured in place with steel wire or aluminum foil tape. Wrap strip to extend approx 7/8 in. (22 mm) beyond each face of the intumescent sheet (Item 4). When nom 6 in. (152 mm) diam (or smaller) pipe, conduit or EMT is installed in through opening, no wrap strip is required on pipe, conduit or EMT for 2 hr F Rating.

3M COMPANY – FS-195+

- 4. Fill, Void or Cavity Materials* – Intumescent Sheet** – Rigid aluminum foil-faced sheet with galv steel sheet backer. Sheet cut to tightly follow the contours of the pipe wrap strip (or individual pipe) and with a min lap of 2 in. (51 mm) on all sides of the through opening. Sheet to be installed with the galv steel sheet backer exposed (aluminum foil facing against floor or wall surface). Sheet secured to top surface of floor and both sides of solid concrete or concrete block wall using min 3/16 in. (5 mm) diam by 1-1/4 in. (32 mm) long steel masonry fasteners with min 1-1/4 in. (32 mm) diam steel washers. Max spacing of fasteners not to exceed 6 in. (152 mm) OC. As an alternate when (1) the max pipe or conduit size is nom 4 in. (102 mm) diam, (2) each pipe or conduit is provided with a layer of wrap strip and (3) no bundled cables or insulated pipes are installed in the through opening, the intumescent sheet may be installed on bottom surface of floor or on only one side of solid concrete wall.

3M COMPANY – CS-195+

- 5. Fill, Void or Cavity Materials* – Graphite Seal, Caulk, Sealant or Putty** – Generous application of caulk or putty to be applied around the base of the wrap strip (or individual pipe) at its egress from the intumescent sheet(s) in addition to completely covering the wrap strip up to the interface(s) with the pipe, pipe insulation and/or cable bundle. One layer of 1/2 in. (13 mm) x 1/16 in. (1.6 mm) adhesive backed graphite intumescent seal positioned under intumescent sheet around entire perimeter of through opening or min 1/4 in. (6 mm) diam continuous bead of caulk or putty applied to edge of intumescent sheet at its interface with surface of floor or wall around entire perimeter of through opening. Prior to installation of the steel strip, slit in intumescent sheet covered with nom 1/4 in. (6 mm) diam bead of caulk (Item 5). Steel cover strip secured to galv steel backer of intumescent sheet with steel sheet-metal screws or steel rivets spaced max 2 in. (51 mm) OC on each side of slit.

3M COMPANY – E-FIS or Ultra GS seals, CP 25WB+ caulk, FB-3000 WT sealant or MP+ Stix putty.

(Note: L Ratings apply only when CP 25WB+ caulk or FB-3000 WT sealant is used.)

- 6. Steel Cover Strip** – Min 2 in. (51 mm) wide strip of min 0.015 in. (0.39 mm) thick (30 gauge) galv steel centered over entire length of slit made in intumescent sheet (Item 4) to permit installation about the pipe/cable bundle. Prior to installation of the steel strip, slit in intumescent sheet covered with nom 1/4 in. (6 mm) diam bead of caulk (Item 5). Steel cover strip secured to galv steel backer of intumescent sheet with steel sheet-metal screws or steel rivets spaced max 2 in. (51 mm) OC on each side of slit.

System No. C-AJ-1006 continued

7. **Support Channel** (Not Shown) – When area of through opening exceeds 1440 sq in. (9290 cm²), an intermediate support channel shall be installed flush with top surface of floor or both surfaces of wall. Support channels to be min 1-5/8 in. by 1-5/8 in. (41 mm by 41 mm) and formed of min 0.093 in. (2.36 mm) thick (No. 12 gauge) painted or galv steel. Ends of steel channel bolted or welded to steel angles anchored to inside walls of through opening. When steel support channels are centered beneath butted seams of intumescent sheets, no steel cover strip (Item 6) is required over butted seam. Intumescent sheet secured to steel support channels with steel sheet metal screws in conjunction with min 1-1/4 in. (32 mm) diam steel fender washers. When support channel is used beneath butted seam of intumescent sheets, fasteners spaced max 3 in. (76 mm) OC on each side of butted seam. When support channel is located away from intumescent sheet seam, fasteners spaced max 6 in. (152 mm) OC. Prior to installation of the intumescent sheet(s), a nom 1/4 in. (6 mm) diam continuous bead of caulk (Item 5) shall be applied as gasket over the steel support channel.

*Bearing the UL Classification Mark

Reprinted from the Online Certifications Directory with permission from Underwriters Laboratories Inc.
Copyright © 2010 Underwriters Laboratories Inc.®



Through Penetrations

Metallic Pipes

1000 Series

Concrete

CAJ

System No. C-AJ-1009

May 09, 2013

F Rating – 2 Hr

T Rating – 0 Hr

L Rating At Ambient – Less Than 1 CFM/sq ft

L Rating At 400 F – Less Than 1 CFM/sq ft

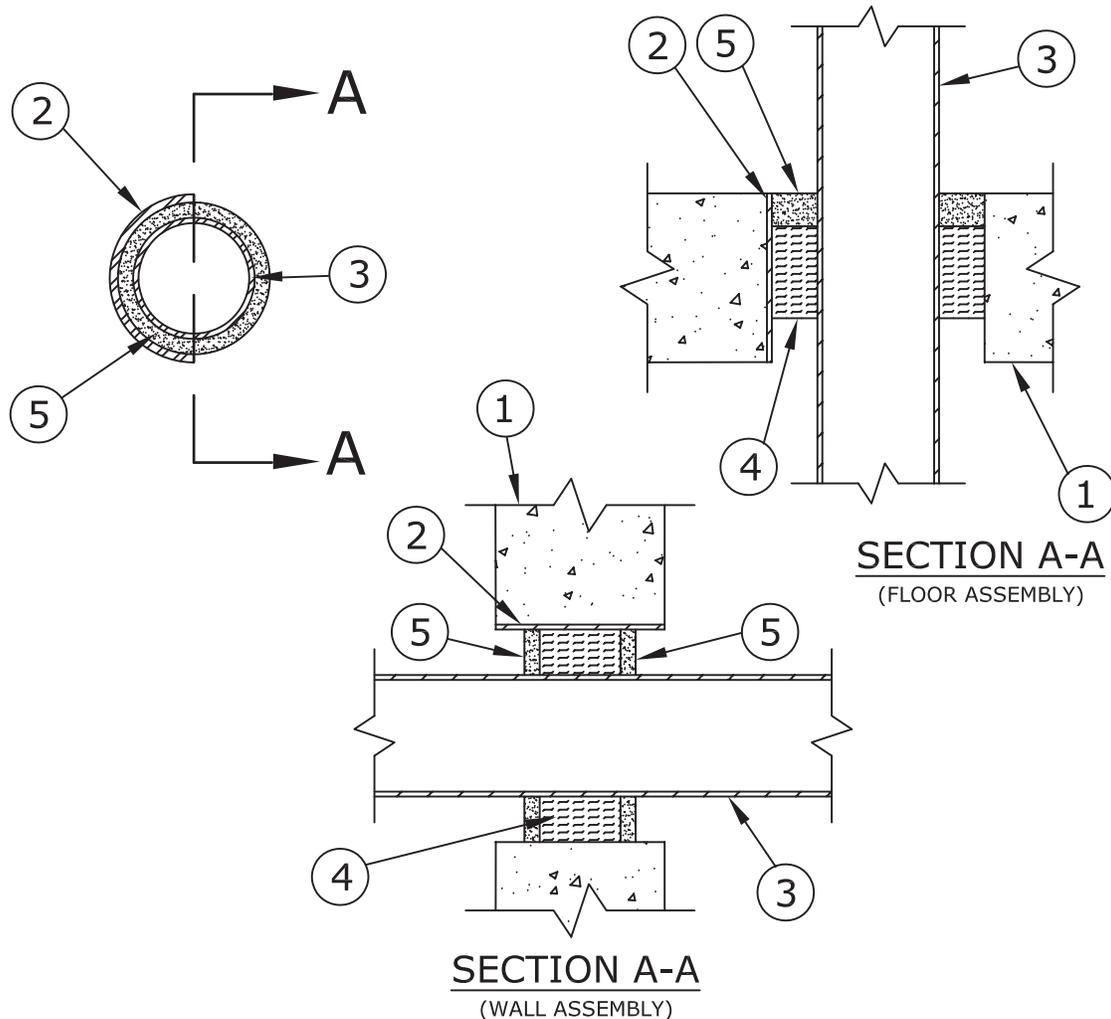

- Floor or Wall Assembly** – Min 5 in. (127 mm) thick reinforced normal weight (100-150 pcf or 1600-2400 kg/m³) concrete. Wall may also be constructed of any UL Classified **Concrete Blocks***. Max diam of opening is 6 in. (152 mm).
See **Concrete Blocks** (CAZT) category in the Fire Resistance Directory for names of manufacturers.
- Metallic Sleeve** – (Optional) – Nom 6 in. (152 mm) diam (or smaller) electrical metallic tubing, steel conduit or cast iron pipe cast or grouted into floor or wall assembly, flush with floor or wall surfaces.
- Through Penetrants** – One metallic pipe or conduit to be centered within the firestop system. A nom annular space of 3/4 in. (19 mm) is required within the firestop system. Pipe or conduit to be rigidly supported on both sides of floor or wall assembly. The following types and sizes of metallic pipes or conduits may be used:
 - Steel Pipe** – Nom 4 in. (102 mm) diam (or smaller) Schedule 5 (or heavier) steel pipe.
 - Conduit** – Nom 4 in. (102 mm) diam (or smaller) steel electrical metallic tubing or steel conduit.
- Packing Material** – Min 3 in. (76 mm) thickness of min 4 pcf (64 kg/m³) mineral wool batt insulation firmly packed into opening as a permanent form. Packing material to be recessed from top surface of floor as required to accommodate the required thickness of fill material. Packing material to be centered in walls mid depth and recessed to allow for installation of fill material.
- Fill, Void or Cavity Material* – Sealant** – Min 1/2 in. (13 mm) thickness of fill material applied within the annulus, flush with top surface of floor. In walls, fill material to be applied on each side of packing material.

3M COMPANY – Types FB-1000 NS, FB-1003SL (floors only), FB-2000 or FB-2000+ (floors only).

*Bearing the UL Classification Mark

Reprinted from the Online Certifications Directory with permission from UL

© 2013 UL LLC



System No. C-AJ-1013

May 09, 2013

F Rating – 1 Hr

T Rating – 0 Hr

L Rating At Ambient – Less Than 1 CFM/sq ft

L Rating At 400 F – Less Than 1 CFM/sq ft

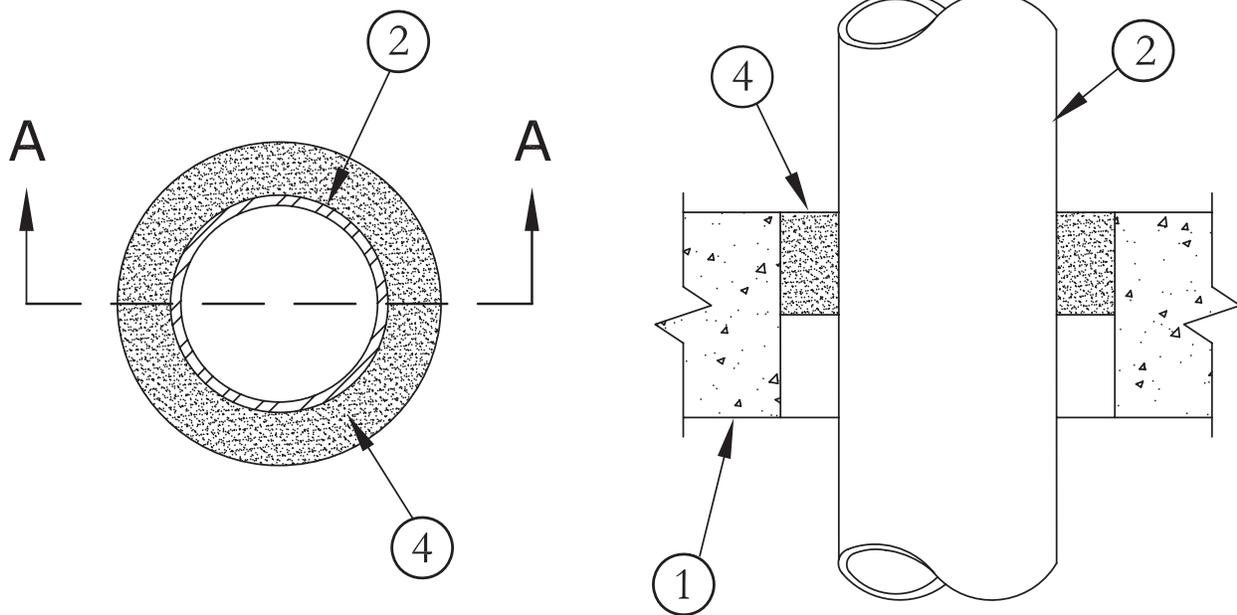

SECTION A-A

1. **Floor or Wall Assembly** – Min 5 in. (127 mm) thick reinforced normal weight (140-155 pcf) concrete. Wall may also be constructed of any UL Classified **Concrete Blocks***. Max diam of opening is 6 in. (152 mm).
See **Concrete Block (CAZT)** category in the Fire Resistance Directory.
2. **Through Penetrants** – One metallic pipe, or conduit to be centered within the firestop system. Pipe or conduit to be rigidly supported on both sides of floor or wall assembly. The following types and sizes of metallic pipes or conduits may be used:
 - A. **Steel Pipe** – Nom 4 in. (102 mm) diam (or smaller) Schedule 5 (or heavier) steel pipe. A nom annular space of 3/4 in. (19 mm) is required within the firestop system.
 - B. **Conduit** – Nom 4 in. (102 mm) diam (or smaller) steel electrical metallic tubing or steel conduit. A nom annular space of 3/4 in. (19 mm) is required within the firestop system.
3. **Packing Material** – (Not Shown) – Nom 1 in. (25 mm) diam open cell polyurethane foam backer rod friction-fitted into the opening as a permanent form. Packing material to be recessed from top surface of floor or from both surfaces of wall as required to accommodate the required thickness of fill material.
4. **Fill, Void or Cavity Material* – Sealant** – Min 3/4 in. (19 mm) thickness of fill material applied within annulus, flush with top surface of floor or with both surfaces of wall.

3M COMPANY – Types FB-1000 NS, FB-1003SL (floors only), FB-2000 or FB-2000+.

*Bearing the UL Classification Mark

Reprinted from the Online Certifications Directory with permission from UL

© 2013 UL LLC



Through Penetrations

Metallic Pipes

1000 Series

Concrete

CAJ

System No. C-AJ-1014

May 09, 2013

F Rating – 2 Hr

T Rating – 0 Hr

L Rating At Ambient – Less Than 1 CFM/sq ft

L Rating At 400 F – Less Than 1 CFM/sq ft

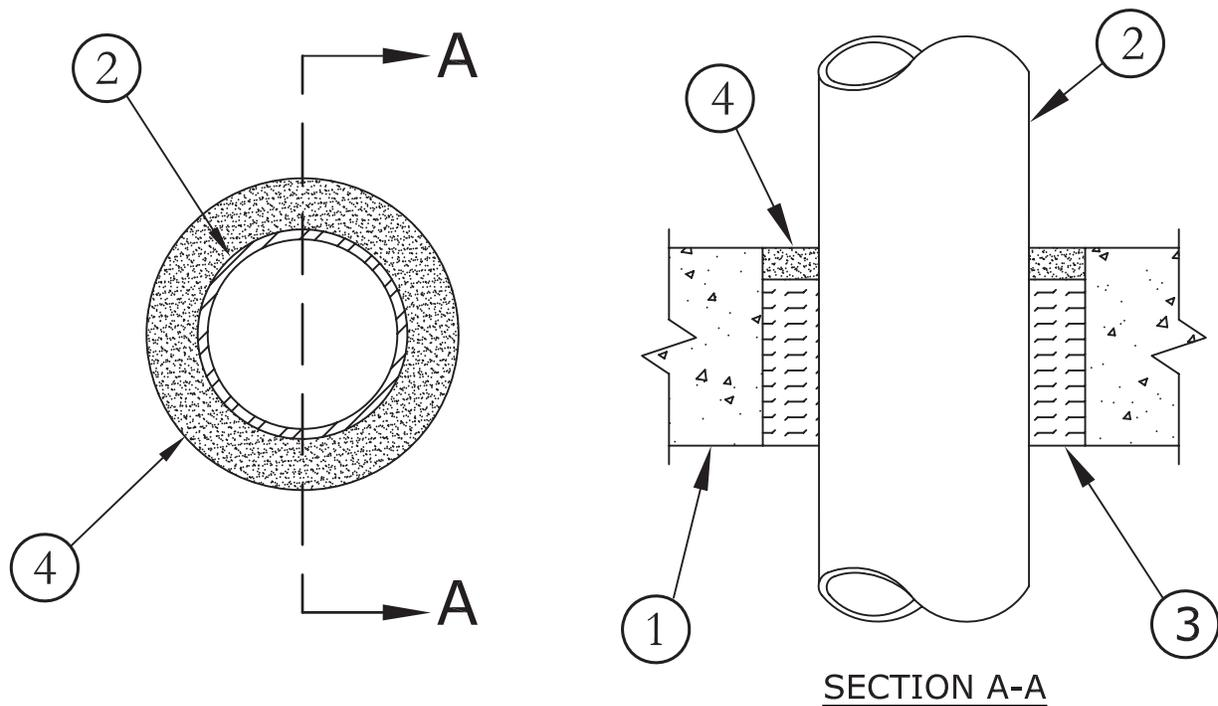

SECTION A-A

- Floor or Wall Assembly** – Min 3-1/4 in. (83 mm) thick reinforced lightweight or normal weight (100-150 pcf or 1600-2400 kg/m³) concrete. Wall may also be constructed of any UL Classified **Concrete Blocks***. Max diam of circular opening is 6 in. (152 mm).
See **Concrete Block (CAZT)** category in the Fire Resistance Directory for names of manufacturers.
- Through Penetrants** – One metallic pipe or conduit to be centered within the firestop system. A nom annular space of 3/4 in. (19 mm) is required within the firestop system. Pipe or conduit to be rigidly supported on both sides of floor or wall assembly. The following types and sizes of metallic pipes or conduits may be used:
 - Steel Pipe** – Nom 4 in. diam (102 mm) (or smaller) Schedule 10 (or heavier) steel pipe.
 - Conduit** – Nom 4 in. (102 mm) diam (or smaller) steel electrical metallic tubing or steel conduit.
- Packing Material** – Min 4 pcf (64 kg/m³) mineral wool batt insulation firmly packed into opening as a permanent form. Packing material to be recessed from top surface of floor or from both surfaces of wall as require to accommodate the required thickness of fill material. Min thickness of packing material in floors and walls to be 2-3/4 in. (70 mm) and 2-1/4 in. (57 mm), respectively.
- Fill, Void or Cavity Material* – Sealant** – Min 1/2 in. (13 mm) thickness of fill material applied within annulus, flush with top surface of floor or with both surfaces of wall. As an alternate, the permanent forming material (Item 3) may be omitted if the fill material thickness is increased to a min 1-1/2 in. (38 mm).
3M COMPANY – Types FB-1000 NS, FB-1003SL (floors only), FB-2000 or FB-2000+.

*Bearing the UL Classification Mark

Reprinted from the Online Certifications Directory with permission from UL

© 2013 UL LLC



System No. C-AJ-1027

January 22, 2008

F Rating – 3 Hr

T Rating – 0 Hr

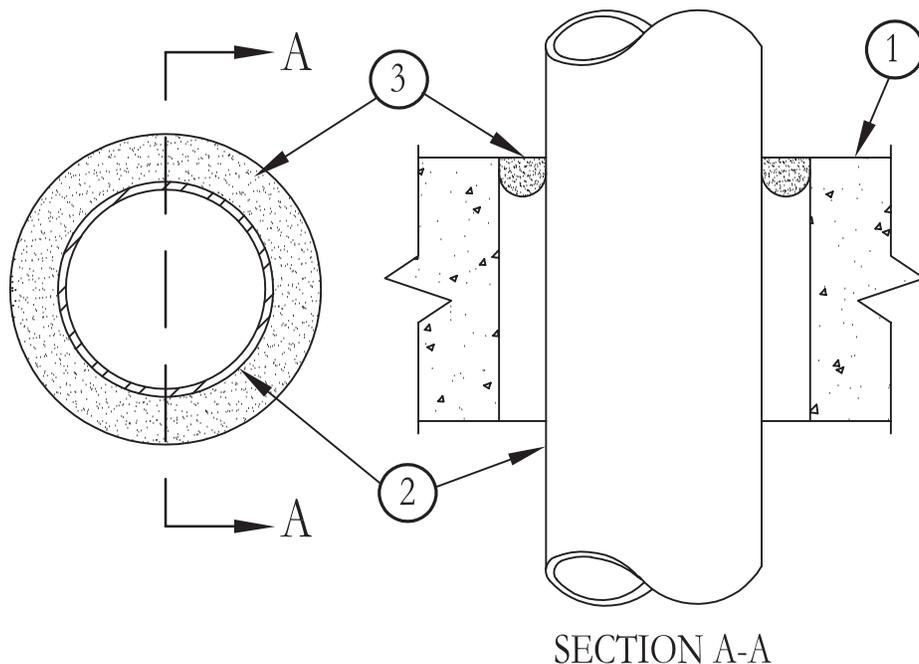

1. **Floor or Wall Assembly** – Min 4-1/2 in. thick lightweight or normal weight (100-150 pcf) concrete. Wall may also be constructed of any UL Classified **Concrete Blocks***. Max diam of through opening is 12-1/4 in.
See **Concrete Blocks** (CAZT) category in Fire Resistance Directory for names of manufacturers.
2. **Through Penetrants** – One metallic pipe, conduit or tubing to be installed either concentrically or eccentrically within the firestop system. Min annular space between pipe, conduit or tubing and edge of opening is 0 in. (point contact). Max annular space is dependent on pipe, conduit or tubing type and size as well as the F Rating of the system, as shown in the table below. Pipe, conduit or tubing to be rigidly supported on both sides of wall assembly. The following types and sizes of metallic pipes, conduits or tubing may be used:
 - A. **Steel Pipe** – Nom 10 in. diam (or smaller) Schedule 10 (or heavier) steel pipe.
 - B. **Conduit** – Nom 6 in. diam (or smaller) rigid steel conduit.
 - C. **Conduit** – Nom 4 in. diam (or smaller) steel electrical metallic tubing or steel conduit.
 - D. **Copper Tubing** – Nom 3 in. diam (or smaller) Type L (or heavier) copper tubing.
 - E. **Copper Pipe** – Nom 3 in. diam (or smaller) Regular (or heavier) copper pipe.
 - F. **Iron Pipe** – Nom 10 in. diam (or smaller) cast or ductile iron pipe.

| Pipe Conduit or Tubing Type | Max Nom Pipe Conduit or Tubing Diam In. | F Rating Hr | Max Annular Space In. |
|-----------------------------|---|-------------|-----------------------|
| A or F | 10 | 3 | 3/4 |
| B | 6 | 3 | 3/4 |
| C | 4 | 3 | 1-1/2 |
| D and E | 3 | 3 | 3/4 |
| D and E | 3 | 2 | 7/8 |

3. **Fill, Void or Cavity Materials* – Putty** – Moldable putty material kneaded by hand and applied to fill annular space to a min depth of 1 in., flush with top surface of floor. In wall assemblies, required putty thickness to be installed symmetrically on both sides of wall.

3M COMPANY – MPS-2+.

*Bearing the UL Classification Mark

Reprinted from the Online Certifications Directory with permission from Underwriters Laboratories Inc.
Copyright © 2010 Underwriters Laboratories Inc.®



System No. C-AJ-1044

March 15, 2007

F Ratings – 2, 3, and 4 Hr (See Items 2A and 4)

T Rating – 0 Hr

L Rating At Ambient – 2 CFM/sq ft

L Rating At 400 F – less than 1 CFM/sq ft

W Rating – Class 1 (See Item 4)

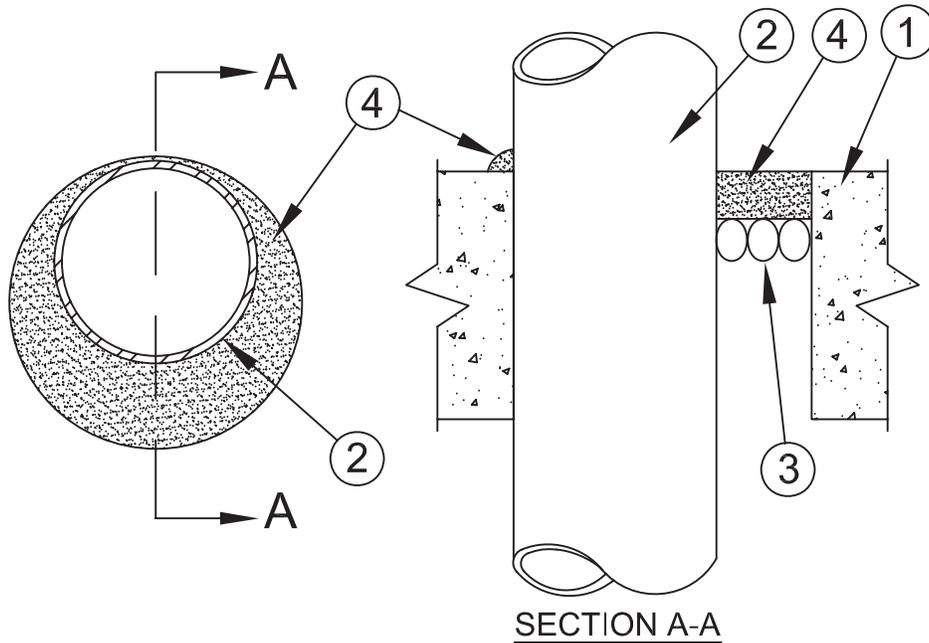

- Floor or Wall Assembly** – Lightweight or normal weight (100-150 pcf or 1600-2400 kg/m³) concrete. Except as noted in table under Item 4, min thickness of solid concrete floor or wall assembly is 4-1/2 in. (114 mm). Floor may also be constructed of any min 6 in. (152 mm) thick UL Classified hollow core **Precast Concrete Units***. When floor is constructed of hollow core precast concrete units, packing material (Item 3) and caulk fill material (Item 4) to be installed symmetrically on both sides of floor, flush with floor surface. Wall assembly may also be constructed of any UL Classified **Concrete Blocks***. Max diam of opening in solid lightweight or normal weight concrete floor is 32 in. (813 mm). Max diam of opening in floor constructed of hollow-core precast concrete units is 7 in. (178 mm)

See **Concrete Blocks (CAZT)** and **Precast Concrete Units (CFTV)** categories in the Fire Resistance Directory for names of manufacturers.

- Steel Sleeve** – (Optional, Not Shown) - Nom 16 in. (406 mm) diam (or smaller) Schedule 10 (or heavier) steel sleeve cast or grouted into floor or wall assembly. Sleeve may extend a max of 2 in. (51 mm) above top of floor or beyond either surface of wall. As an alternate, nom 16 in. (406 mm) diam (or smaller) min 0.028 (0.71 mm) thick galvanized sheet steel sleeve cast or grouted into floor or wall assembly flush with floor or wall surfaces.
- Through Penetrants** – One metallic pipe, conduit or tubing to be installed either concentrically or eccentrically within the firestop system. Max annular space between pipe, conduit or tubing and edge of through opening or sleeve is dependent on the parameters shown in Item 4. Min annular space between pipe or conduit and edge of through opening is 0 in. (point contact). Max annular space to be as shown in the table in Item 4. Pipe, conduit or tubing to be rigidly supported on both sides of floor or wall assembly. The following types and sizes of metallic pipes, conduits or tubing may be used:
 - Steel Pipe** – Nom 30 in. (762 mm) diam (or smaller) Schedule 10 (or heavier) steel pipe.
 - Iron Pipe** – Nom 30 in. (762 mm) diam (or smaller) cast or ductile iron pipe.
 - Conduit** – Nom 6 in. (152 mm) diam (or smaller) rigid steel conduit.
 - Conduit** – Nom 4 in. (102 mm) diam (or smaller) steel electrical metallic tubing.
 - Copper Tubing** – Nom 6 in. (152 mm) diam (or smaller) Type L (or heavier) copper tube.
 - Copper Pipe** – Nom 6 in. (152 mm) diam (or smaller) Regular (or heavier) copper pipe.
- Packing Material** – Polyethylene backer rod or nom 1 in. (25 mm) thickness of tightly-packed mineral wool batt or glass fiber insulation firmly packed into opening as a permanent form. Packing material to be recessed from top surface of floor or from both surfaces of wall as required to accommodate the required thickness of caulk fill material (Item 4).
- Forming Material*** – As an alternate to the packing material in Item 3, nom 4 in. (102 mm) wide strips of min 1/2 in. (13 mm) thick compressible mat to be stacked to a thickness greater than the width of the annular space and compression-fitted, edge-first, to fill the annular space to a min 4 in. (102 mm) depth. As an option, the strips of min 1/2 in. (13 mm) thick compressible mat may be folded in half, lengthwise, and stacked to a thickness greater than the width of the annular space and compression-fitted, edge-first, to fill the annular space to a min 2 in. (51 mm) depth. Top of forming material to be recessed from top surface of floor or from both surfaces of wall as necessary to accommodate the required thickness of caulk fill material.

3M COMPANY – Fire Barrier Packing Material

System No. C-AJ-1044 *continued*

4. **Fill, Void or Cavity Material* – Caulk, Sealant** – Applied to fill the annular space flush with top surface of floor. In wall assemblies, required caulk thickness to be installed symmetrically on both sides of wall, flush with wall surface. At point contact location between penetrant and sleeve or between penetrant and concrete, a min 1/4 in. (6 mm) diam bead of caulk shall be applied at top surface of floor and at both surfaces of wall. The hourly F Ratings and the min required caulk thicknesses are dependent upon a number of parameters, as shown in the following table::

| Min Floor or Wall Thkns In. (mm) | Nom Pipe Tube or Conduit Diam In. (mm) | Max Annular Space In. (mm) | Min Caulk Thkns In. (mm) | F Rating Hr |
|----------------------------------|--|----------------------------|--------------------------|-------------|
| 2-1/2 (64) | 1/2-12 (13-305) | 1-3/8 (35) | 1/2 (13) | 2 |
| 2-1/2 (64) | 1/2-12 (13-305) | 3-1/4 (83) | 1 (25) | 2 |
| 4-1/2 (114) | 1/2-6 (13-152) | 1-3/8 (35) | 1/4(6)(a) | 2 |
| 4-1/2 (114) | 1/2-12 (13-305) | 1-1/4 (32) | 1/2 (13) | 3 |
| 4-1/2 (114) | 1/2-20 (13-508) | 2 (51) | 1 (25) | 3 |
| 4-1/2 (114) | 1/2-20 (13-508) | 2 (51) | 1 (25) | 3 |
| 4-1/2 (114) | 1/2-12 (13-305) | 3-1/4 (83) | 1 (25) | 3 |
| 4-1/2 (114) | 22-30 (558-762) | 2 (51) | 2 (51) | 3 |
| 5-1/2 (140) | 1/2-6 (13-152) | 1-3/8 (35) | 1 (25)(b) | 4 |

- (a) Min 2 in. (51 mm) thickness of mineral wool batt insulation or forming material (Item 3A) required in annular space.
 (b) Min 1 in. (25 mm) thickness of mineral wool batt insulation required in annular space on both sides of floor or wall assembly. Min 1 in. (25 mm) thickness of caulk to be installed flush with each surface of floor or wall assembly.

3M COMPANY – CP 25WB+ or FB-3000 WT.

(Note: W Rating applies only when FB-3000 WT is used.)

*Bearing the UL Classification Marking

Reprinted from the Online Certifications Directory with permission from Underwriters Laboratories Inc.
 Copyright © 2010 Underwriters Laboratories Inc.®



Through Penetrations

Metallic Pipes

1000 Series

Concrete

CAJ

System No. C-AJ-1052

January 11, 1999
 (Formerly System No.337)
 F Rating – 2 Hr
 T Rating – 0 Hr

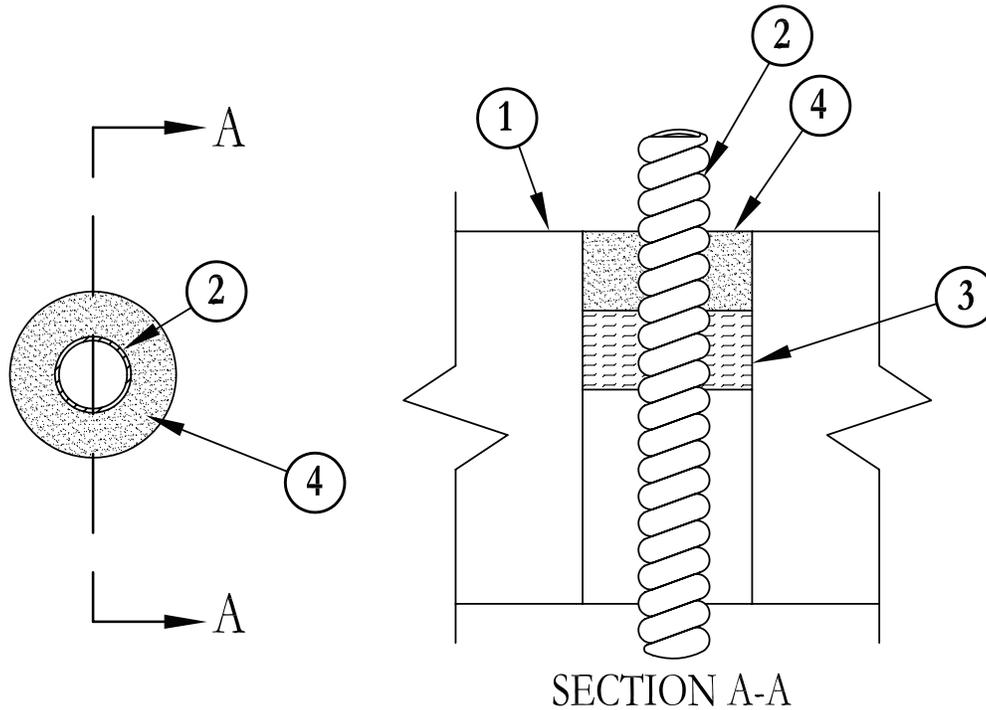

1. **Floor or Wall Assembly** – Min 4-1/2 in. thick lightweight or normal weight (100-150 pcf) concrete. Wall may also be constructed of any UL Classified **Concrete Blocks***. Diam of circular through opening in floor or wall assembly to be 3/4 in. to 1-1/2 in. larger than diam of flexible metal conduit (Item 2) installed in through opening. Max diam of opening is 6 in.
 See **Concrete Blocks (CAZT)** category in the Fire Resistance Directory for names of manufacturers.
2. **Through Penetrating Product*** – Nom 4 in. diam (or smaller) aluminum or steel **Flexible Metal Conduit+**. Max one flexible metal conduit to be installed near center of circular through opening in floor or wall assembly. Flexible metal conduit to be rigidly supported on both sides of floor or wall assembly.
AFC CABLE SYSTEMS INC
3. **Packing Material** – Nom 1 in. thickness of ceramic (alumina silica) fiber blanket or mineral wool batt insulation firmly packed into opening as a permanent form. Packing material to be recessed min 1 in. from top surface of floor or from both surfaces of wall.
4. **Fill, Void or Cavity Material* – Caulk** – Applied to fill the annular space around the flexible metal conduit. In floors, a min 1 in. depth of fill material to be installed flush with top surface of floor. In walls, a min 1 in. depth of fill material to be installed flush with wall surface on both sides of wall assembly.
3M COMPANY – CP 25WB+

*Bearing the UL Classification Marking

Reprinted from the Online Certifications Directory with permission from Underwriters Laboratories Inc.
 Copyright © 2010 Underwriters Laboratories Inc.®



System No. C-AJ-1058

May 09, 2013

ANSI/UL1479 (ASTM E814)

F Rating – 3 Hr
T Rating – 0 Hr
L Rating At Ambient – Less Than 1 CFM/sq ft
L Rating At 400 F – Less Than 1 CFM/sq ft
W Rating – Class 1 (See Item 4)

CAN/ULC S115

F Rating – 3 Hr
FT Rating – 0 Hr
FH Rating – 3 Hr
FTH Rating – 0 Hr
L Rating At Ambient – Less Than 1 CFM/sq ft
L Rating At 400 F – Less Than 1 CFM/sq ft

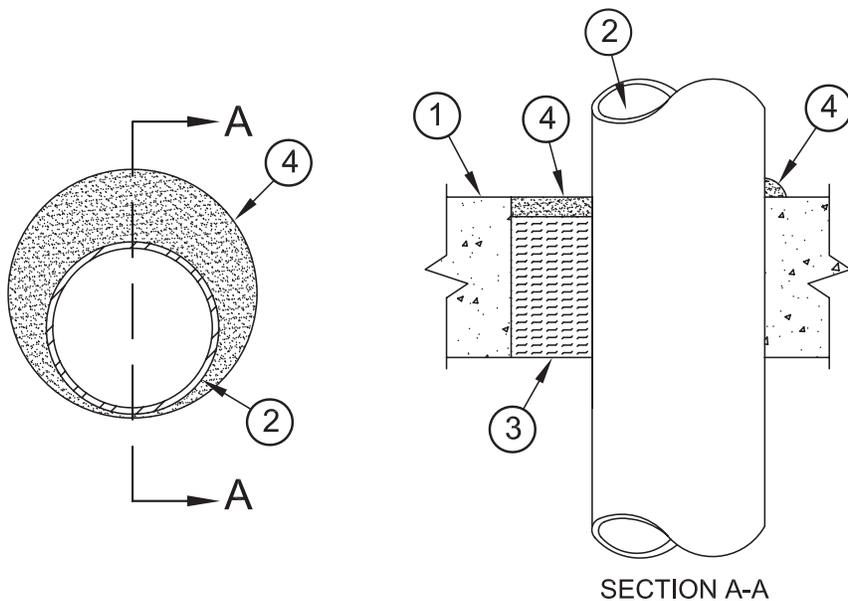

SECTION A-A

1. **Floor or Wall Assembly** – Min 4-1/2 in. (114 mm) thick reinforced lightweight or normal weight (100-150 pcf or 1600-2400 kg/m³) concrete. Wall may also be constructed of any UL Classified **Concrete Blocks***. Max diam of opening is 27-1/4 in. (692 mm).
See **Concrete Block (CAZT)** category in the Fire Resistance Directory for names of manufacturers.
- 1A. **Steel Sleeve** – (Optional, Not Shown) – Nom 28 in. (711 mm) diam (or smaller) Schedule 10 (or heavier) steel sleeve cast or grouted into floor or wall assembly. As an alternate, nom 28 in. (711 mm) diam (or smaller) sleeve fabricated from nom 0.028 in. (0.71 mm) thick galv steel cast or grouted into floor or wall assembly flush with floor or wall surfaces.
2. **Through-Penetrant** – One metallic pipe, conduit or tubing to be installed either concentrically or eccentrically within the firestop system. An annular space of min 0 in. (point contact) to max 3-1/4 in. (83 mm) is required within the firestop system. When optional steel sleeve is used, min annular space shall be 1/2 in. (13 mm). Pipe, conduit or tubing to be rigidly supported on both sides of floor or wall assembly. The following types and sizes of metallic pipes, conduits or tubing may be used:
 - A. **Steel Pipe** – Nom 24 in. (610 mm) diam (or smaller) Schedule 10 (or heavier) steel pipe. When Type FB-1000 NS or FB-1003 SL sealant (see Item 4) is used, pipe diam shall not exceed nom 8 in. (203 mm).
 - B. **Conduit** – Nom 4 in. (102 mm) diam (or smaller) steel electrical metallic tubing or nom 6 in. (152 mm) diam (or smaller) steel conduit.
 - C. **Copper Tubing** – Nom 6 in. (152 mm) diam (or smaller) Type L (or heavier) copper tubing. When Type FB-1000 NS or FB-1003 SL sealant (see Item 4) is used, tubing diam shall not exceed nom 4 in. (102 mm).
 - D. **Copper Pipe** – Nom 6 in. (152 mm) diam (or smaller) Regular (or heavier) copper pipe. When Type FB-1000 NS or FB-1003 SL sealant (see Item 4) is used, pipe diam shall not exceed nom 4 in. (102 mm).
 - E. **Iron Pipe** – Nom 24 in. (610 mm) diam (or smaller) cast or ductile iron pipe. When Type FB-1000 NS or FB-1003 SL sealant (see Item 4) is used, pipe diam shall not exceed nom 8 in. (203 mm).
3. **Packing Material** – Min 3 in. (76 mm) thickness of min 4 pcf (64 kg/m³) mineral wool batt insulation firmly packed into opening as a permanent form. Packing material to be recessed from top surface of floor or from both surfaces of wall as required to accommodate the required thickness of fill material.
- 3A. **Forming Material*** – As an alternate to the packing material in Item 3, nom 4 in. (102 mm) wide strips of min 1/2 in. (13 mm) thick compressible mat to be stacked to a thickness greater than the width of the annular space and compression-fitted, edge-first, to fill the annular space to a min 4 in. (102 mm) depth. Top of forming material to be recessed from top surface of floor or steel sleeve or from both surfaces of wall or steel sleeve in wall as necessary to accommodate the required thickness of caulk fill material.

3M COMPANY 3M FIRE PROTECTION PRODUCTS – Fire Barrier Packing Material
4. **Fill, Void or Cavity Material* – Sealant** – Min 1/2 in. (13 mm) thickness of fill material applied within annulus, flush with top surface of floor or both surfaces of wall assembly. At the point contact location between pipe and concrete, a min 1/2 in. (13 mm) diam bead of sealant shall be applied at the concrete/pipe interface on the top surface of floor and on both surfaces of wall assembly.

3M COMPANY 3M FIRE PROTECTION PRODUCTS – Types FB-2000, FB-2000+, FB-1000 NS, FB-1003 SL or FB-3000 WT.
(Note: W Rating applies only when FB-1000 NS, FB-1003 SL or FB-3000 WT Sealant is used.)

*Bearing the UL Classification Mark

Reprinted from the Online Certifications Directory with permission from UL

© 2013 UL LLC



System No. C-AJ-1060

December 07, 1999

(Formerly System No. 358)

F Rating – 2 Hr

T Rating – 0 Hr

L Rating At Ambient – Less Than 1 CFM/sq ft (See Item 4)

L Rating At 400 F – Less Than 1 CFM/sq ft (See Item 4)

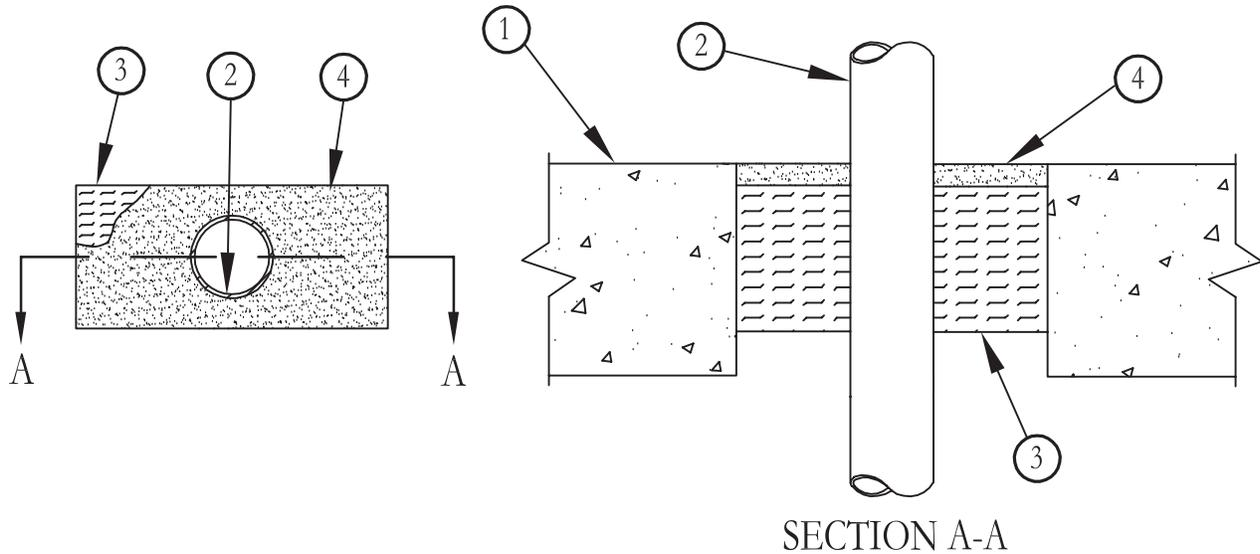

- Floor or Wall Assembly** – Min 4-1/2 in. thick reinforced lightweight or normal weight (100-150 pcf) concrete. Wall may also be constructed of any UL Classified **Concrete Blocks***. Max area of rectangular opening in floor or wall 30 sq in. with max dimension of 10 in. Max diam of circular opening is 6 in.
See **Concrete Blocks** (CAZT) category in the Fire Resistance Directory for names of manufacturers.
- Copper Tubing** – One nom 2 in. diam (or smaller) Type L (or heavier) copper tubing installed within firestop system. When installed in rectangular opening, tubing is to be centered. When installed in circular openings, a min annular space of 7/16 in. is required. Pipe to be rigidly supported on both sides of floor or wall assembly.
- Packing Material** – Min 3 in. thickness of min 4 pcf mineral wool batt insulation firmly packed into opening as a permanent form. Packing material to be recessed from top surface of floor or from both surfaces of wall as required to accommodate the required thickness of fill material.
- Fill, Void or Cavity Material* – Sealant** – Min 1/2 in. thickness of fill material applied within annulus, flush with top surface of floor or both surfaces of wall.

3M COMPANY – FB-2000 or FB-2000+

(Note: L Ratings apply only when FB-2000+ is used.)

*Bearing the UL Classification Marking

Reprinted from the Online Certifications Directory with permission from Underwriters Laboratories Inc.

Copyright © 2010 Underwriters Laboratories Inc.®



System No. C-AJ-1066

August 23, 2004

(Formerly System No. 395)

F Rating – 3 Hr

T Rating – 0 Hr

L Rating At Ambient – 2 CFM/sq ft

L Rating At 400 F – less than 1 CFM/sq ft

W Rating – Class I (See Item 4)

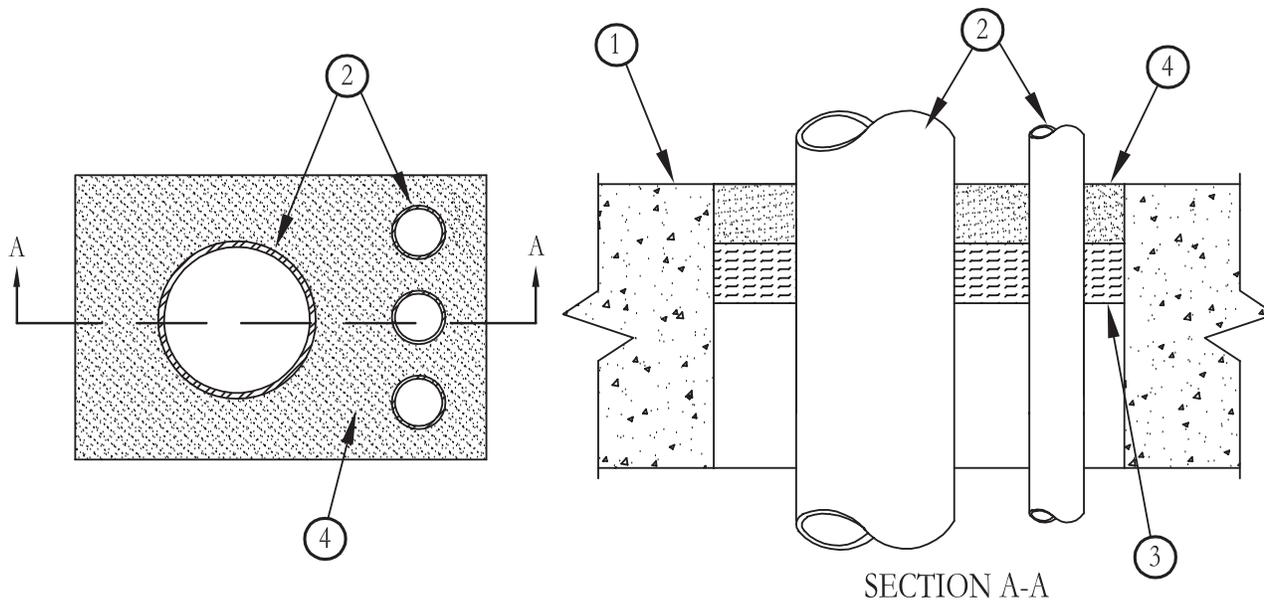

1. **Floor or Wall Assembly** – Min 4-1/2 in. thick lightweight or normal weight (100-150 pcf) concrete. Wall may also be constructed of any UL Classified **Concrete Blocks***. Max area of square, rectangular or circular opening is 45 sq in. with max dimension of 9 in.
See **Concrete Blocks (CAZT)** category in the Fire Resistance Directory for names of manufacturers.
2. **Pipe** – Nom 3 in. diam (or smaller) Type L (or heavier) copper pipe or nom 2-1/2 in. diam (or smaller) Schedule 10 (or heavier) steel pipe. One or more pipes may be installed with a min 1/2 in. to max 1 in. clearance maintained between pipes and with a min 1/4 in. to max 1 in. clearance maintained between pipe and sides of through opening. Pipes to be rigidly supported on both sides of floor or wall assembly.
3. **Packing Material** – Min 1 in. thick mineral wool batt insulation firmly packed into opening with its top surface recessed min 1 in. from top surface of the floor. In wall assemblies, forming material to be firmly packed into opening on both sides of wall and recessed min 1 in. from wall surface.
4. **Fill, Void or Cavity Materials* – Caulk or Sealant** – Applied to fill through opening to a min depth of 1 in. In floor assemblies, fill material to be installed flush with top surface of floor. In wall assemblies, fill material to be installed flush with wall surface on both sides of wall.
3M COMPANY – CP 25WB+ caulk or FB-3000 WT sealant. (Note: W Rating applies only when FB-3000 WT is used.)

*Bearing the UL Classification Marking

Reprinted from the Online Certifications Directory with permission from Underwriters Laboratories Inc.

Copyright © 2010 Underwriters Laboratories Inc.®



Through Penetrations

Metallic Pipes

1000 Series

Concrete

CAJ

System No. C-AJ-1091
 December 9, 1995
 (Formerly System No. 481)
 F Rating – 2 Hr
 T Ratings – 0, 1-1/2 and 2 Hr (See Item 2)

Through Penetrations

Metallic Pipes

1000 Series

Concrete

CAJ

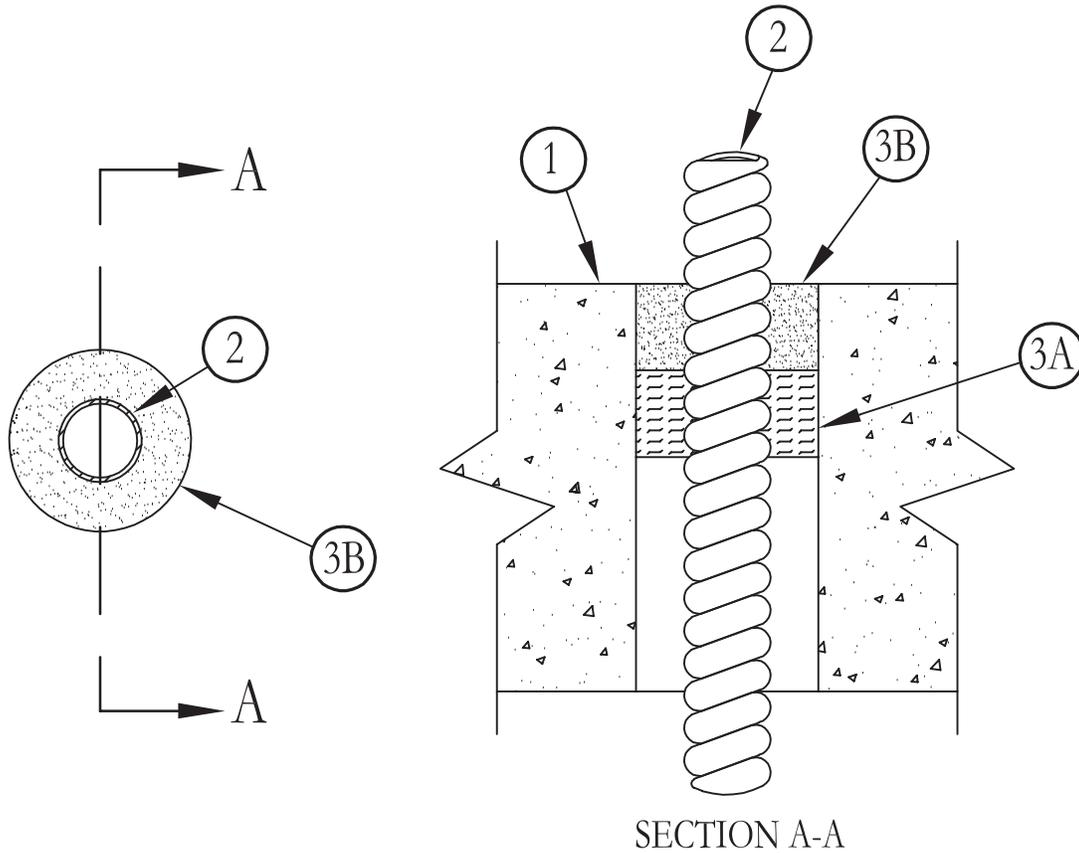

- Floor or Wall Assembly** – Min 4-1/2 in. thick lightweight or normal weight (100-150 pcf) concrete. Wall may also be constructed of any UL Classified **Concrete Blocks***. Max diam of opening is 3 in.
 See **Concrete Blocks (CAZT)** category in the Fire Resistance Directory for names of manufacturers.
- Through Penetrating Product* – Flexible Metal Conduit** – Nom 2 in. diam (or smaller) aluminum Flexible Metal Conduit+. Max one flexible metal conduit installed near center of through opening in floor or wall assembly. Diam of opening to be min 1/2 in. to max 1-1/2 in. larger than diam of flexible metal conduit. **When nom 1-1/4 in. to 2 in. diam conduit is used, T Rating is 0 hr. When nom 1/2 in. to 1 in. diam conduit is used, T Rating is 1-1/2 hr. When nom 3/8 in. diam conduit is used, T Rating is 2 hr.** Flexible metal conduit to be rigidly supported on both sides of floor or wall assembly.

ANAMET INDUSTRIAL INC

- Firestop System** – The firestop system shall consist of the following:
 - Packing Material** – Nom 1 in. thickness of ceramic (alumina silica) fiber blanket or mineral wool batt insulation firmly packed into opening as a permanent form. Packing material to be recessed min 1 in. from top surface of floor or from both surfaces of wall.
 - Fill, Void or Cavity Material* – Caulk** – Applied to fill the annular space around the through-penetrating product. In floors, a min 1 in. depth of fill material to be installed flush with top surface of floor. In walls, a min 1 in. depth of fill material to be installed flush with wall surface on both sides of wall assembly.

3M COMPANY – CP 25WB+

*Bearing the UL Classification Marking

+Bearing the UL Listing Mark

Reprinted from the Online Certifications Directory with permission from Underwriters Laboratories Inc.

Copyright © 2010 Underwriters Laboratories Inc.®

System No. C-AJ-1092

September 03, 2004

(Formerly System No. 487)

F Rating – 2 Hr

T Rating – 0 Hr

L Rating At Ambient – 2 CFM/sq ft

L Rating At 400 F – less than 1 CFM/sq ft

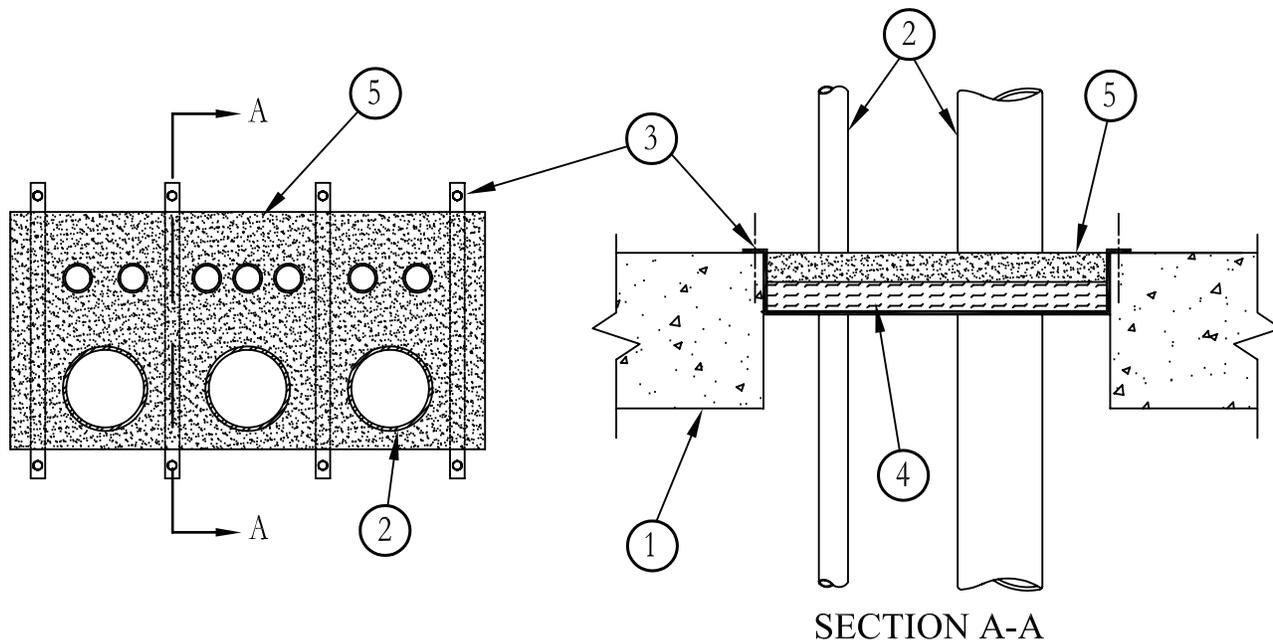

1. **Floor or Wall Assembly** – Min 2-1/2 in. thick lightweight or normal weight (100-150 pcf) concrete. When area of through opening exceeds 144 sq in., min concrete thickness is 4-1/2 in. Wall may also be constructed of any UL Classified **Concrete Blocks***. Max area of through opening not to exceed 560 sq in. with max width dimension of 14 in.
See **Concrete Blocks** (CAZT) category in the Fire Resistance Directory for names of manufacturers.
2. **Pipe or Conduit** – Nom 6 in. diam (or smaller) Schedule 10 (or heavier) steel pipe or steel conduit or nom 4 in. diam (or smaller) steel EMT or Type L (or heavier) copper tubing. Multiple pipes and/or conduits permitted in opening provided a min separation of 1/2 in. is maintained between pipes or conduits. Min annular space between pipes or conduits and edge of through opening is zero in. (point contact). Max annular space is 6 in. Pipes and conduits rigidly supported on both sides of floor or wall assembly.
3. **Support Hanger** – Min 1 in. wide strips of min 0.034 in. (20 gauge) galv steel sheet bent to form a “hat” shape with each “brim” of the hat shape bearing 2 in. on the top surface of the floor and with the “crown” depth sufficient to accommodate the packing material (Item 4) and the required fill material (Item 5) thickness. Support hangers installed across width of opening and spaced max 8 in. O.C. When max dimension of opening is 12 in. and when max annular space is 2-3/4 in., no support hangers are required. Ends of support hangers anchored to top surface of floor with steel anchor bolts, or equivalent, in conjunction with steel fender washers. Support hangers not required in wall assemblies.
4. **Packing Material** – Min 1 in. thickness of mineral wool batt insulation firmly packed into opening as a permanent form. In floors, packing material to be installed atop support hangers (when required) with top surface recessed min 1 in. from top surface of floor. In walls, packing material to be recessed min 1 in. from both surfaces of wall.
5. **Fill, Void or Cavity Material* – Caulk or Sealant** – Applied to fill the annular space to a min depth of 1 in. on top surface of floor or on both sides of wall.

3M COMPANY – CP 25WB+ caulk or FB-3000 WT sealant.

*Bearing the UL Classification Marking

Reprinted from the Online Certifications Directory with permission from Underwriters Laboratories Inc.

Copyright © 2010 Underwriters Laboratories Inc.®



Through Penetrations

Metallic Pipes

1000 Series

Concrete

CAJ

System No. C-AJ-1112

August 23, 2004

F Ratings – 2 and 3 Hr (See Item 1)

T Rating – 0 Hr

L Rating At Ambient – 2 CFM/sq ft

L Rating At 400 F – Less than 1 CFM/sq ft

W Rating – Class I (See Item 3)

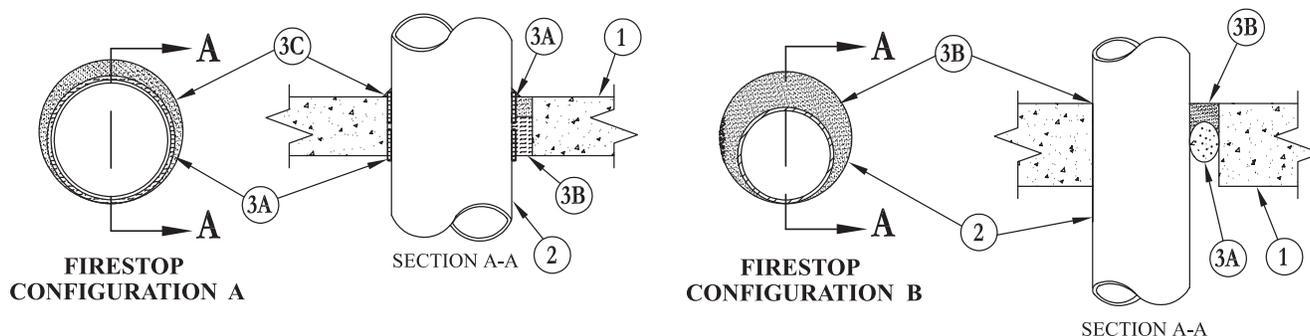

- Floor or Wall Assembly** – Min 4-1/2 in. thick lightweight or normal weight (100-150 pcf) concrete. Wall may also be constructed of any UL Classified **Concrete Blocks***. Max diam of circular through opening is 12 in.

See **Concrete Blocks (CAZT)** category in the Fire Resistance Directory for names of manufacturers.

The hourly F Rating is 2 Hr for Firestop Configuration A and 3 Hr for Firestop Configuration B.

FIRESTOP CONFIGURATION A

- Aluminum Pipe** – Nom 10 in. diam (or smaller) Schedule 10 (or heavier) pipe for use in closed (process or supply) piping system. Max annular space between pipe and edge of through opening not to exceed 1-3/4 in. Min annular space between pipe and edge of opening is 1/4 in. Pipe to be rigidly supported on both sides of floor or wall assembly.
- Firestop System** – The firestop system shall consist of the following:
 - Fill, Void or Cavity Materials – Wrap Strip** – Nom 1/4 in. thick intumescent elastomeric material faced on one side with aluminum foil, supplied in nom 2 in. wide strips. Nom 2 in. wide strip tightly-wrapped around pipe (foil side exposed), secured with a steel wire tie and slid into annular space on both sides of floor or wall assembly. In floors, the bottom edge of the lower wrap strip is to be flush with the bottom surface of floor and the upper wrap strip is to protrude 1/4 in. above the top surface of the floor. In walls, each wrap strip is to protrude 1/4 in. from the wall surface.
3M COMPANY – FS-195+
 - Packing Material** – Min 3-1/2 in. thickness of min 4 pcf mineral wool batt insulation firmly packed into opening as a permanent form. Packing material to be recessed from top surface of floor or from both surfaces of wall as required to accommodate the required thickness of caulk fill material (Item 3C).
 - Fill, Void or Cavity Materials – Caulk or Sealant** – Min 1 in. thickness of fill material applied within annulus, flush with top surface of floor or both surfaces of wall assembly. Min 1/4 in. thickness of caulk also applied to cover exposed edge of wrap strip layer on top surface of floor and on both sides of wall.
3M COMPANY – CP 25WB+ caulk or FB-3000 WT sealant. (Note: W Rating applies only when FB-3000 WT is used.)

FIRESTOP CONFIGURATION B

- Aluminum Pipe** – Nom 5 in. diam (or smaller) Schedule 10 (or heavier) pipe for use in closed (process or supply) or vented (drain, waste or vent) piping systems. An annular space of min 0 in. (point contact) to max 1-1/2 in. is required within the firestop system. Pipe to be rigidly supported on both sides of floor or wall assembly.
- Firestop System** – The firestop system shall consist of the following:
 - Packing Material** – Polyethylene backer rod or nom 1 in. thickness of tightly-packed mineral wool batt or glass fiber insulation firmly packed into opening as a permanent form. Packing material to be recessed from top surface of floor or from both surfaces of wall as required to accommodate the required thickness of caulk fill material (Item 3B).
 - Fill, Void or Cavity Materials – Caulk or Sealant** – Min 1/2 in. thickness of fill material applied within annulus, flush with top surface of floor or both surfaces of wall assembly. At the point contact location between pipe and concrete, a min 1/2 in. diam bead of sealant shall be applied at the concrete/pipe interface on the top surface of floor and on both surfaces of wall assembly.
3M COMPANY – CP 25WB+ caulk or FB-3000 WT sealant. (Note: W Rating applies only when FB-3000 WT is used.)

*Bearing the UL Classification Marking

Reprinted from the Online Certifications Directory with permission from Underwriters Laboratories Inc.

Copyright © 2010 Underwriters Laboratories Inc.®



System No. C-AJ-1175

March 05, 2007

F Rating – 2 Hr

T Rating – 0 Hr

W Rating – Class 1 (See Item 4)

FIRESTOP CONFIGURATION - A

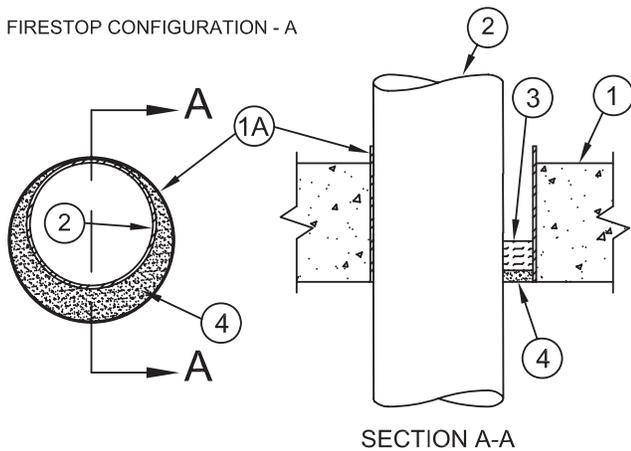

FIRESTOP CONFIGURATION - B

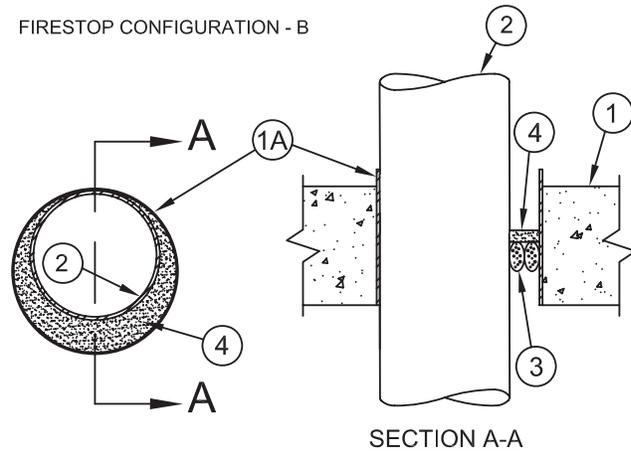

- 1. Floor or Wall Assembly** – Min 2-1/2 in. (64 mm) thick lightweight or normal weight (100-150 pcf or 1600-2400 kg/m³) concrete. When Configuration A is used or when Configuration B is used in conjunction with the steel sleeve (Item 1A), floor may be constructed of any min 6 in. (152 mm) thick UL Classified hollow core **Precast Concrete Units***. Wall may also be constructed of any UL Classified **Concrete Blocks***. Max diam of circular through opening is 10 in. (254 mm).
See **Concrete Blocks (CAZT)** and **Precast Concrete Units (CFTV)** categories in the Fire Resistance Directory for names of manufacturers.
- 1A. Steel Sleeve** – (Optional) – Nom 10 in. diam (or smaller) Schedule 10 (or heavier) steel pipe sleeve cast into concrete floor or wall. Sleeve to be flush with or project max 2 in. from top surface of floor or from both surfaces of wall. As an alternate, nom 10 in. (254 mm) diam (or smaller) sleeve fabricated from nom 0.019 in. (0.48 mm) thick galv steel cast or grouted into floor or wall assembly flush with floor or wall surfaces.
- 2. Through Penetrants** – One metallic pipe, conduit or tubing to be installed either concentrically or eccentrically within the firestop system. Max annular space between pipe, conduit or tubing and edge of through opening not to exceed 1-3/8 in. (35 mm). Min annular space between pipe or conduit and edge of through opening is 0 in. (point contact). Pipe, conduit or tubing to be rigidly supported on both sides of floor or wall assembly. The following types and sizes of metallic pipes, conduits or tubing may be used:
 - A. Steel Pipe** – Nom 8 in. (203 mm) diam (or smaller) Schedule 10 (or heavier) steel pipe.
 - B. Conduit** – Nom 6 in. (152 mm) diam (or smaller) rigid steel conduit.
 - C. Conduit** – Nom 4 in. (102 mm) diam (or smaller) steel electrical metallic tubing.
 - D. Iron Pipe** – Nom 4 in. (102 mm) diam (or smaller) cast or ductile iron pipe.
 - E. Copper Tubing** – Nom 6 in. (152 mm) diam (or smaller) Type L (or heavier) copper tube.
 - F. Copper Pipe** – Nom 6 in. (152 mm) diam (or smaller) Regular (or heavier) copper pipe.

Firestop Configuration A

- 3. Packing Material** – Min 1 in. (25 mm) thickness of tightly-packed mineral wool batt material used as a permanent form. Packing material to be recessed from top or bottom surface of floor or from either surface of solid concrete wall as required to accommodate the required thickness of caulk fill material (Item 4). When wall is constructed of concrete block, packing material is to be installed on both sides of wall assembly. When precast hollow core floor is used, packing material must be installed on bottom surface of floor.
- 4. Fill, Void or Cavity Materials* – Caulk or Sealant** – Applied to fill the annular space to a min depth of 1/2 in. (13 mm) flush with the top or bottom surface of the floor or either surface of the solid concrete wall. A min 1/4 in. (6 mm) diam bead of caulk shall be applied to the floor or wall surface where the pipe, conduit or EMT is installed in point contact with the edge of the through opening. When wall is constructed of concrete block, caulk to be installed symmetrically on both sides of wall assembly. When precast hollow core floor is used, caulk fill material must be installed on bottom surface of floor.

3M COMPANY – CP 25WB+ or FB-3000 WT.

(Note: W Rating applies only when FB-3000 WT is used flush with the top surface of floor.)

Firestop Configuration B

- 3. Packing Material** – Polyethylene backer rod or nom 1 in. (25 mm) thickness of tightly-packed mineral wool batt insulation firmly packed into opening as a permanent form. Packing material to be recessed min 1/2 in. (13 mm) from top surface of floor or from both surfaces of wall as required to accommodate the required thickness of caulk fill material (Item 4).
- 4. Fill, Void or Cavity Materials* – Caulk or Sealant** – Applied to fill the annular space to a min depth of 1/2 in. (13 mm) flush with the top surface of the floor or both surfaces of the wall. A min 1/4 in. (6 mm) diam bead of caulk shall be applied to the floor or wall surface where the pipe, conduit or EMT is installed in point contact with the edge of the through opening.

3M COMPANY – CP 25WB+ or FB-3000 WT.

(Note: W Rating applies only when FB-3000 WT is used.)

*Bearing the UL Classification Mark

Reprinted from the Online Certifications Directory with permission from Underwriters Laboratories Inc.

Copyright © 2010 Underwriters Laboratories Inc.®



System No. C-AJ-1176

December 1, 2002

F Ratings – 2 and 3 Hr (See Item 2)

T Rating – 0 Hr

L Rating At Ambient – less than 1 CFM per sq ft

L Rating At 400 F – less than 1 CFM per sq ft

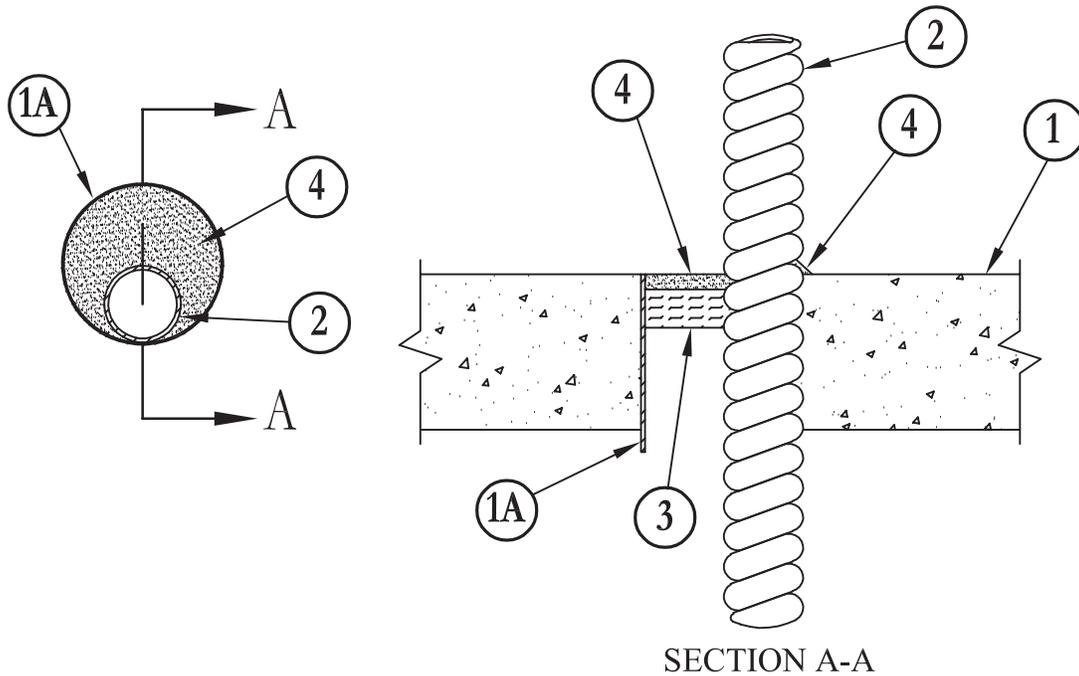

1. **Floor or Wall Assembly** – Min 4-1/2 in. thick lightweight or normal weight (100-150 pcf) concrete. Wall may also be constructed of any UL Classified **Concrete Blocks***. Diam of circular through opening in floor or wall assembly to be 3/4 in. to 1-1/2 in. larger than diam of flexible metal conduit (Item 2) installed in through opening. Max diam of opening is 6 in.
See **Concrete Blocks (CAZT)** category in the Fire Resistance Directory for names of manufacturers.
- 1A. **Steel Sleeve (Optional)** – Nom 6 in. diam (or smaller) Schedule 10 (or heavier) steel pipe sleeve cast into concrete floor or wall. Sleeve to be flush with or project max 2 in. from top surface of floor or from both surfaces of wall.
2. **Through Penetrating Product*** – Nom 4 in. diam (or smaller) aluminum or steel **Flexible Metal Conduit#**. Max one conduit per through opening. Max annular space between conduit and edge of through opening not to exceed 1-1/2 in. Min annular space between conduit and edge of through opening is zero in. (point contact). When aluminum conduit is used, F Rating is 2 Hr. When steel conduit is used, F Rating is 3 hr. Flexible metal conduit to be rigidly supported on both sides of floor or wall assembly.

AFC CABLE SYSTEMS INC

3. **Packing Material** – Polyethylene backer rod or min 1 in. thickness of mineral wool batt insulation firmly packed into opening as a permanent form. Packing material to be recessed min 1/2 in. from top surface of floor or from both surfaces of wall.
4. **Fill, Void or Cavity Material* – Caulk** – Applied to fill the annular space around the flexible metal conduit. In floors, a min 1/2 in. depth of fill material to be installed flush with top surface of floor. In walls, a min 1/2 in. depth of fill material to be installed flush with wall surface on both sides of wall assembly. When steel sleeve is not used or is used and installed flush with floor or wall surfaces, a min 1/4 in. diam bead of caulk shall be applied to the floor on wall surface where the through penetrant is installed in point contact with the edge of the through opening.

3M COMPANY – CP 25WB+

*Bearing the UL Classification Marking

#Bearing the UL Listing Mark

Reprinted from the Online Certifications Directory with permission from Underwriters Laboratories Inc.

Copyright © 2010 Underwriters Laboratories Inc.®



System No. C-AJ-1188

March 05, 2007

F Rating – 3 Hr

T Rating – 0 Hr

W Rating – Class 1 (See Item 4)

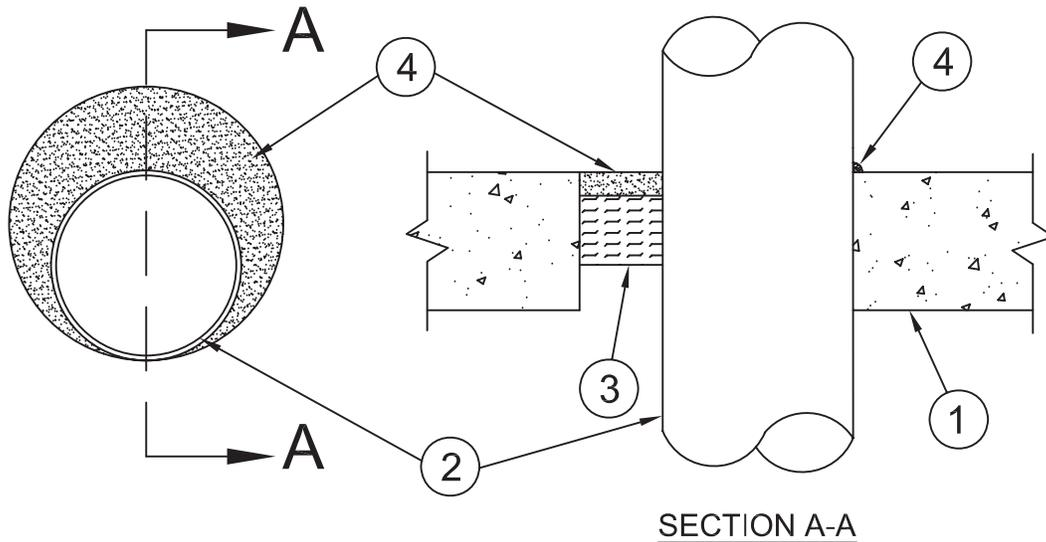

- Floor or Wall Assembly** – Min 4-1/2 in. (114 mm) thick reinforced lightweight or normal weight (100-150 pcf or 1600-2400 kg/m³) concrete. Wall may also be constructed of any UL Classified **Concrete Blocks***. Max diam of opening is 16 in. (406 mm).
See **Concrete Block** (CAZT) category in the Fire Resistance Directory for names of manufacturers.
- 1A. Steel Sleeve** – (Optional, Not Shown) - Nom 16 in. (406 mm) diam (or smaller) Schedule 10 (or heavier) steel sleeve cast or grouted into floor or wall assembly. As an alternate, nom 16 in. (406 mm) diam (or smaller) sleeve fabricated from nom 0.028 in. (0.71 mm) thick galv steel cast or grouted into floor or wall assembly flush with floor or wall surfaces.
- Through Penetrant** – One metallic pipe, conduit or tubing to be installed either concentrically or eccentrically within the firestop system. An annular space of min 0 in. (point contact) to max 2-7/8 in. (73 mm) is required within the firestop system. When optional steel sleeve is used, min annular space shall be 1/2 in. (13 mm). Pipe, conduit or tubing to be rigidly supported on both sides of floor or wall assembly. The following types and sizes of metallic pipes, conduits or tubing may be used:
 - Steel Pipe** – Nom 12 in. (305 mm) diam (or smaller) Schedule 10 (or heavier) steel pipe.
 - Conduit** – Nom 6 in. (152 mm) diam (or smaller) steel conduit.
 - Conduit** – Nom 4 in. (102 mm) diam (or smaller) steel electrical metallic tubing.
 - Copper Tubing** – Nom 6 in. (152 mm) diam (or smaller) Type L (or heavier) copper tubing.
 - Copper Pipe** – Nom 6 in. (152 mm) diam (or smaller) Regular (or heavier) copper pipe.
- Packing Material** – Min 3 in. (76 mm) thickness of min 4 pcf (64 kg/m³) mineral wool batt insulation tightly packed into opening as a permanent form. Packing material to be recessed from top surface of floor or from both surfaces of wall as required to accommodate the required thickness of fill material.
- Fill, Void or Cavity Material* – Sealant** – Min 1/4 in. (6 mm) thickness of fill material applied within annulus, flush with top surface of floor or both surfaces of wall assembly. At the point contact location between pipe and concrete, a min 1/2 in. (13 mm) diam bead of sealant shall be applied at the concrete/pipe interface on the top surface of floor and on both surfaces of wall assembly.
3M COMPANY – FB-2000+, FB-1000 NS, FB-1003 SL or FB-3000 WT.
(Note: W Rating applies only when FB-1000 NS, FB-1003 SL or FB-3000 WT is used.)

*Bearing the UL Classification Mark

Reprinted from the Online Certifications Directory with permission from Underwriters Laboratories Inc.

Copyright © 2010 Underwriters Laboratories Inc.®



System No. C-AJ-1216

March 8, 1995

F Rating – 2 Hr

F Rating – 0 Hr

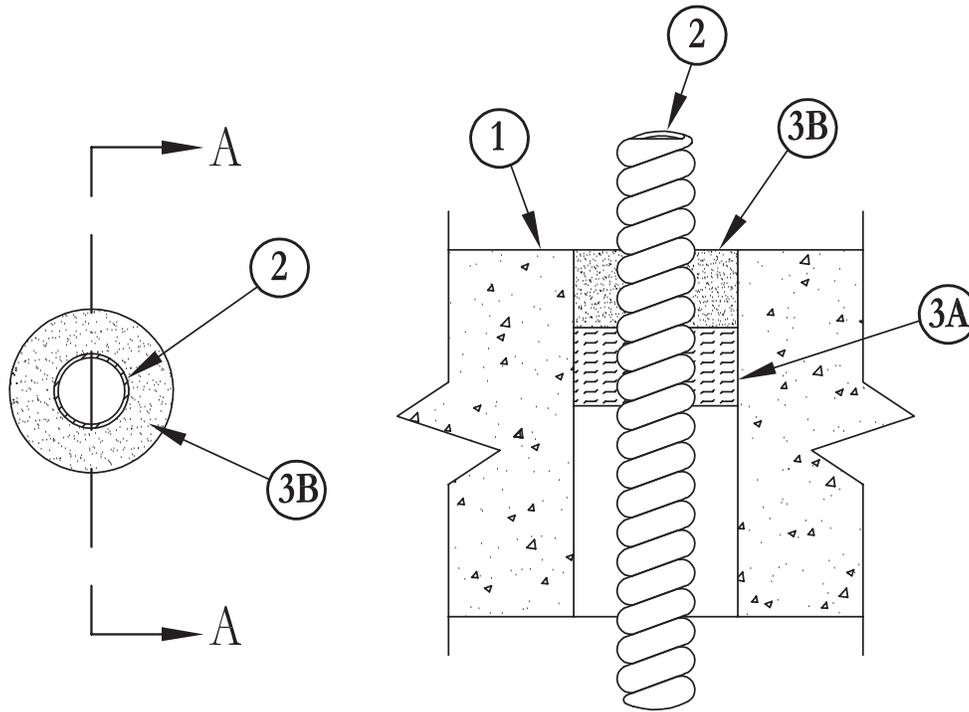

SECTION A-A

- Floor or Wall Assembly** – Min 4-1/2 in. thick lightweight or normal weight (100 to 150 pcf) concrete. Wall may also be constructed of any UL Classified **Concrete Blocks***. Diam of circular through opening in floor or wall assembly to be min 3/4 in. to max 1-1/2 in. larger than diam of flexible metal piping (Item 2) installed in through opening. Max diam of opening is 2-3/4 in.

See **Concrete Blocks (CAZT)** category in the Fire Resistance Directory for names of manufacturers.

- Through Penetrating Product* – Flexible Metal Piping** – Nom 1 in. diam (or smaller) steel Flexible Metal Piping. Max one flexible metal piping to be installed near center of circular through opening in floor or wall assembly. Flexible metal piping to be rigidly supported on both sides of floor or wall assembly. Plastic covering on piping shall be removed for a distance of 2 ft on both sides of floor or wall assembly.

TITFLEX CORP, A BUNDY CO

- Packing Material** – Nom 1 in. thickness of ceramic (alumina silica) fiber blanket or mineral wool batt insulation firmly packed into opening as a permanent form. Packing material to be recessed min 1 in. from top surface of floor or from both surfaces of wall.
- Fill, Void or Cavity Material* – Caulk** – Applied to fill the annular space around the flexible metal piping. In floors, a min 1 in. depth of fill material to be installed flush with top surface of floor. In walls, a min 1 in. depth of fill material to be installed flush with wall surface on both sides of wall assembly.

3M COMPANY – CP 25WB+

*Bearing the UL Classification Marking

Reprinted from the Online Certifications Directory with permission from Underwriters Laboratories Inc.
Copyright © 2010 Underwriters Laboratories Inc.®



System No. C-AJ-1225

October 19, 2011

F Rating – 2 Hr

T Rating – 0 Hr

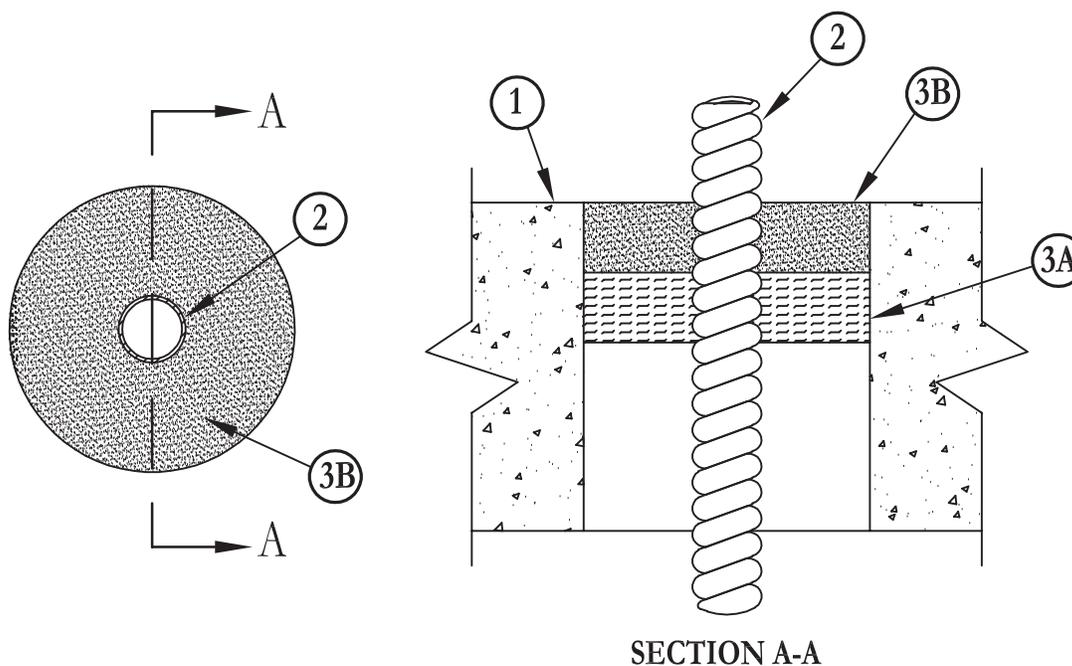

1. **Floor or Wall Assembly** – Min 4-1/2 in. (114 mm) thick lightweight or normal weight (100 to 150 pcf or 1600-2400 kg/m³) concrete. Wall may also be constructed of any UL Classified **Concrete Blocks***. Diam of circular through opening in floor or wall assembly to be min 3/4 in. (19 mm) to max 1-1/2 in. (38 mm) larger than diam of flexible metal piping (Item 2) installed in through opening. Max diam of opening is 4-1/8 in. (105 mm).

See **Concrete Block** (CAZT) category in the Fire Resistance Directory for names of manufacturers.

2. **Through Penetrating Product* – Flexible Metal Piping** – Nom 2 in. (51 mm) diam (or smaller) steel flexible metal piping. Max one flexible metal piping to be installed near center of circular through opening in floor or wall assembly. Flexible metal piping to be rigidly supported on both sides of floor or wall assembly.

WARD MFG L L C – Wardflex or Wardflex II

3. **Packing Material** – Nom 1 in. (25 mm) thickness of ceramic (alumina silica) fiber blanket or mineral wool batt insulation firmly packed into opening as a permanent form. Packing material to be recessed min 1 in. (25 mm) from top surface of floor or from both surfaces of wall.
4. **Fill, Void or Cavity Material* – Caulk** – Applied to fill the annular space around the flexible metal piping. In floors, a min 1 in. (25 mm) depth of fill material to be installed flush with top surface of floor. In walls, a min 1 in. (25 mm) depth of fill material to be installed flush with wall surface on both sides of wall assembly.

3M COMPANY – CP-25 WB+

*Bearing the UL Classification Mark

Reprinted from the Online Certifications Directory with permission from UL

© 2012 UL LLC



Through Penetrations

Metallic Pipes

1000 Series

Concrete

CAJ

System No. C-AJ-1241

November 19, 1999

F Rating – 2 Hr

T Rating – 0 Hr

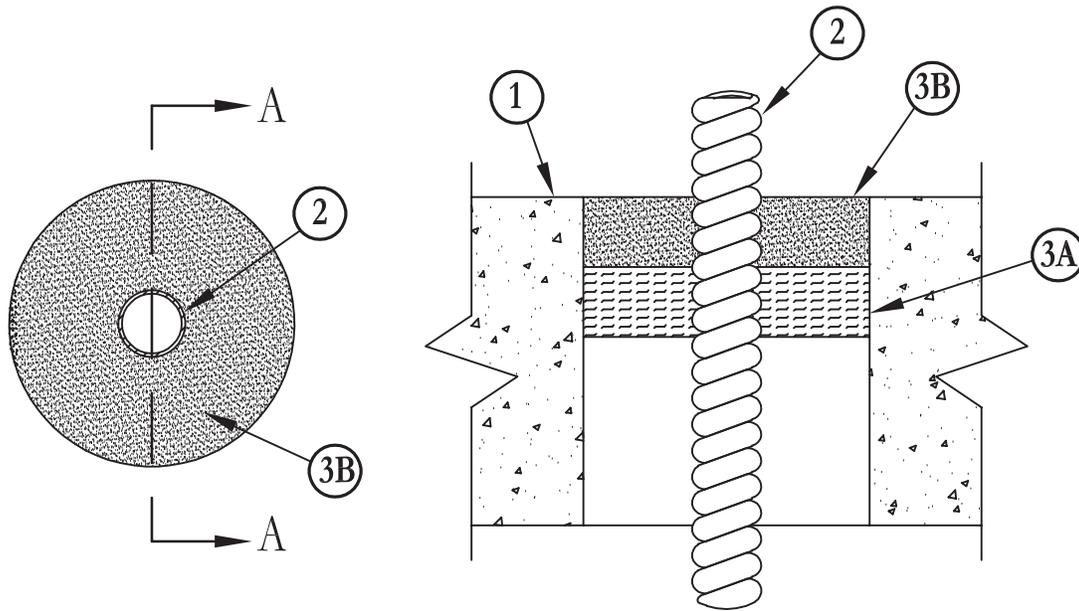

SECTION A-A

1. **Floor or Wall Assembly** – Min 4-1/2 in. thick lightweight or normal weight (100 to 150 pcf) concrete. Wall may also be constructed of any UL Classified **Concrete Blocks***. Diam of circular through opening in floor or wall assembly to be min 3/4 in. to max 1-1/2 in. larger than diam of flexible metal piping (Item 2) installed in through opening. Max diam of opening is 3-15/16 in. See **Concrete Blocks (CAZT)** category in the Fire Resistance Directory for names of manufacturers.

2. **Through Penetrating Products* – Flexible Metal Piping** – Nom 2 in. diam (or smaller) steel Flexible Metal Piping. Max one flexible metal piping to be installed near center of circular through opening in floor or wall assembly. Flexible metal piping to be rigidly supported on both sides of floor or wall assembly. Plastic covering on piping shall be removed for a distance of 2 ft on both sides of floor or wall assembly.

OMEGA FLEX INC

3. **Packing Material** – Nom 1 in. thickness of ceramic (alumina silica) fiber blanket or mineral wool batt insulation firmly packed into opening as a permanent form. Packing material to be recessed min 1 in. from top surface of floor or from both surfaces of wall.
4. **Fill, Void or Cavity Material* – Caulk** – Applied to fill the annular space around the flexible metal piping. In floors, a min 1 in. depth of fill material to be installed flush with top surface of floor. In walls, a min 1 in. depth of fill material to be installed flush with wall surface on both sides of wall assembly.

3M COMPANY – CP 25WB+

*Bearing the UL Classification Marking

Reprinted from the Online Certifications Directory with permission from Underwriters Laboratories Inc.

Copyright © 2010 Underwriters Laboratories Inc.®



System No. C-AJ-1274

March 05, 2007

F Rating – 3 Hr

T Rating – 0 Hr

W Rating – Class 1 (See Item 4)

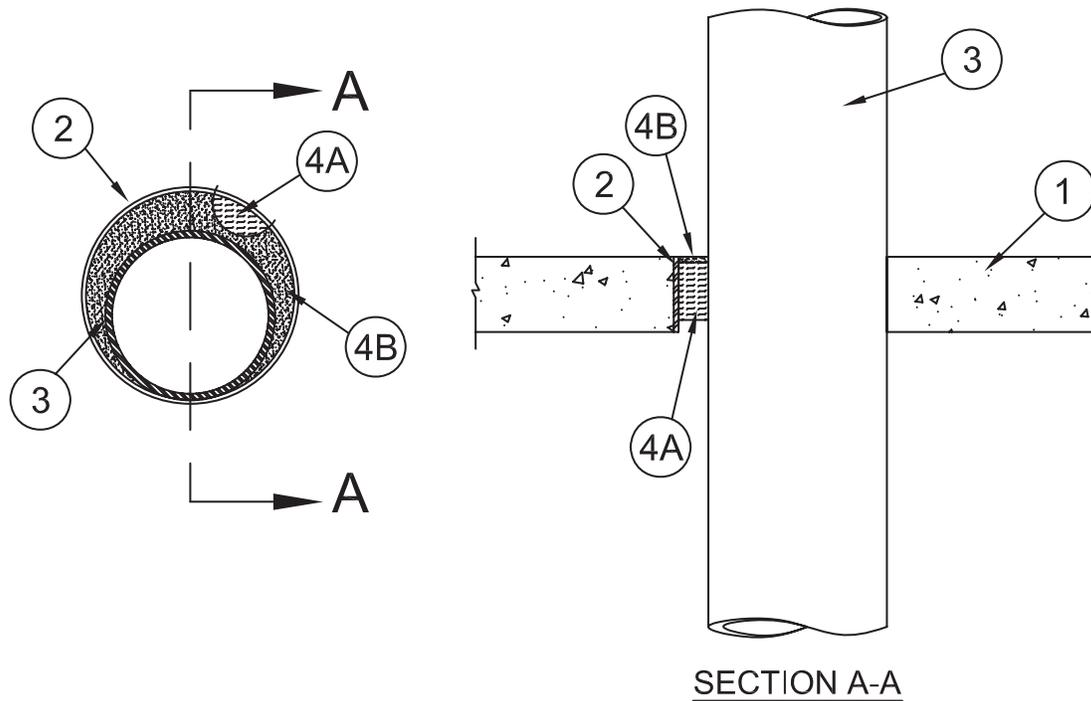

- Floor or Wall Assembly** – Min 4-1/2 in. (114 mm) thick reinforced lightweight or normal weight (100-150 pcf or 1600-2400 kg/m³) concrete. Wall may also be constructed of any UL Classified **Concrete Blocks***. Max diam of opening is 26 in. (660 mm).
See **Concrete Blocks (CAZT)** category in the Fire Resistance Directory for names of manufacturers.
- Steel Sleeve** – (Optional) – Nom 14 in. (356 mm) diam (or smaller) Schedule 10 (or heavier) steel sleeve cast or grouted into floor or wall assembly. As an alternate, nom 14 in. (356 mm) diam (or smaller) sleeve fabricated from nom 0.028 in. (0.71 mm) thick galv steel cast or grouted into floor or wall assembly flush with floor or wall surfaces.
- Through Penetrants** – One metallic pipe, conduit or tubing installed either concentrically or eccentrically within the firestop system. The annular space between pipe, conduit or tubing and periphery of opening or sleeve shall be min 0 in. (point contact) to max 2 in. (51 mm). Pipe, conduit or tubing to be rigidly supported on both sides of wall assembly. The following types and sizes of metallic pipes, conduits or tubing may be used:
 - Steel Pipe** – Nom 24 in. (610 mm) diam (or smaller) Schedule 10 (or heavier) steel pipe.
 - Iron Pipe** – Nom 24 in. (610 mm) diam (or smaller) service weight (or heavier) cast iron soil pipe, nom 24 in diam (or smaller) Class 50 (or heavier) ductile iron pressure pipe.
 - Conduit** – Nom 6 in. (152 mm) diam (or smaller) steel conduit or nom 4 in. (102 mm) diam (or smaller) steel electrical metallic tubing.
 - Copper Tubing** – Nom 6 in. (152 mm) diam (or smaller) Type L (or heavier) copper tubing.
 - Copper Pipe** – Nom 6 in. (152 mm) diam (or smaller) Regular (or heavier) copper pipe.
- Firestop System** – The details of the firestop system shall be as follows:
 - Packing Material** – Min 4 in. (102 mm) thickness of min 4 pcf (64 kg/m³) mineral wool batt insulation firmly packed into opening as a permanent form. Packing material to be recessed from top surface of floor or from both surfaces of wall as required to accommodate the required thickness of fill material.
 - Fill, Void or Cavity Materials* – Caulk or Sealant** – Min 1/4 in. (6 mm) thickness of fill material applied within the annulus, flush with top surface of floor or with both surfaces of wall. Min 1/4 in. (6 mm) diam bead of caulk applied to the penetrant/concrete or penetrant/sleeve interface at the point contact location on the top surface of floor or both surfaces of wall.
3M COMPANY – CP 25WB+ caulk or FB-3000 WT sealant
(Note: W Rating applies only when FB-3000 WT is used.)

*Bearing the UL Classification Mark

Reprinted from the Online Certifications Directory with permission from Underwriters Laboratories Inc.
Copyright © 2010 Underwriters Laboratories Inc.®



System No. C-AJ-1275

January 31, 2006

F Rating – 2 Hr

T Rating – 0 Hr

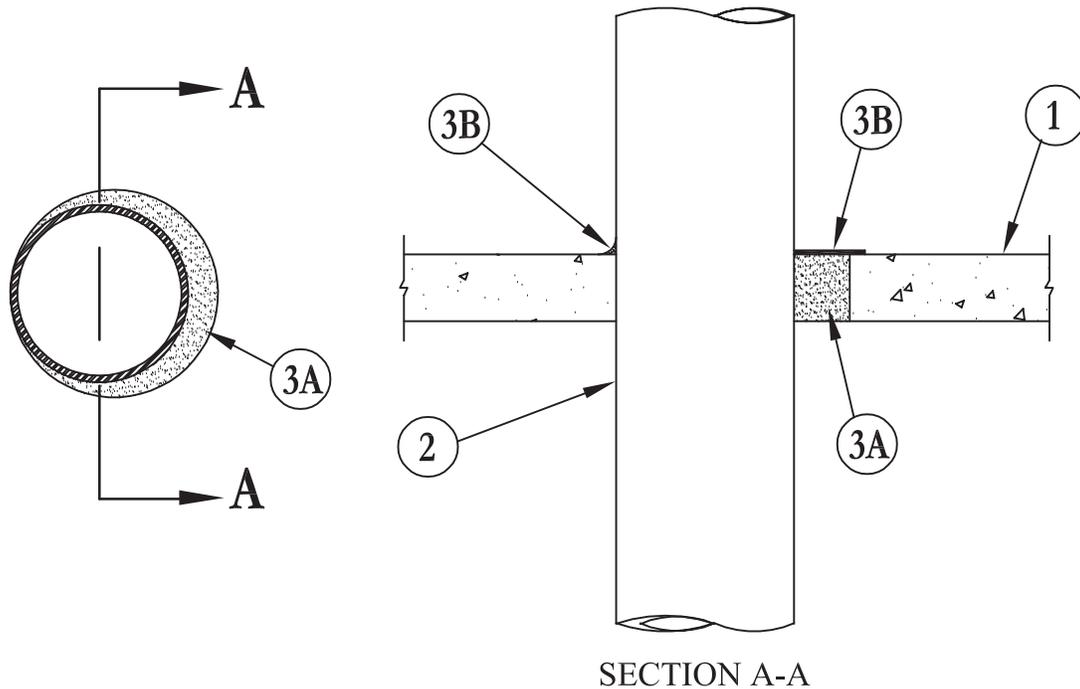

1. **Floor or Wall Assembly** – Min 4-1/2 in. (114 mm) thick reinforced lightweight or normal weight (100-150 pcf or 1600-2400 kg/m³) concrete. Wall may also be constructed of any UL Classified **Concrete Blocks***. Max diam of opening is 8 in. (203 mm).
See **Concrete Blocks** (CAZT) category in the Fire Resistance Directory for names of manufacturers.
2. **Through Penetrant** – One metallic pipe, conduit or tubing installed either concentrically or eccentrically within the firestop system. The annular space between pipe, conduit or tubing and periphery of opening shall be min 0 in. (0 mm, point contact) to max 1-7/8 in. (48 mm). Pipe, conduit or tubing to be rigidly supported on both sides of wall assembly. The following types and sizes of metallic pipes, conduits or tubing may be used:
 - A. **Steel Pipe** – Nom 6 in. (152 mm) diam (or smaller) Schedule 10 (or heavier) steel pipe.
 - B. **Iron Pipe** – Nom 6 in. (152 mm) diam (or smaller) service weight (or heavier) cast iron soil pipe, nom 6 in (152 mm) diam (or smaller) or Class 50 (or heavier) ductile iron pressure pipe.
 - C. **Conduit** – Nom 6 in. (152 mm) diam (or smaller) steel conduit or nom 4 in. (102 mm) diam (or smaller) steel electrical metallic tubing.
 - D. **Copper Tubing** – Nom 6 in. (152 mm) diam (or smaller) Type L (or heavier) copper tubing.
 - E. **Copper Pipe** – Nom 6 in. (152 mm) diam (or smaller) Regular (or heavier) copper pipe.
3. **Firestop System** – The details of the firestop system shall be as follows:
 - A. **Packing Material** – Min 4-1/2 in. (114 mm) thickness of min 4 pcf (64 kg/m³) mineral wool batt insulation firmly packed into opening as a permanent form. Packing material to be flush with top surface of floor or from both surfaces of wall.
 - B. **Fill, Void or Cavity Material*** – Min 1/16 in. (1.6 mm) dry thickness (min 1/8 in. or 3.2 mm wet thickness) of fill material sprayed or brushed into annular space on top surface of floor or both surfaces of wall to completely cover mineral wool and overlap a min of 1 in. (25 mm) onto penetrant and top surface of floor or both surfaces of wall.

3M COMPANY – FireDam™ Spray 200

*Bearing the UL Classification Mark

Reprinted from the Online Certifications Directory with permission from Underwriters Laboratories Inc.
Copyright © 2010 Underwriters Laboratories Inc.®



System No. C-AJ-1292

March 05, 2007

F Rating – 3 Hr

T Rating – 0 Hr

L Rating At Ambient – Less Than 1 CFM/sq ft

L Rating At 400 F – 2 CFM/sq ft

W Rating – Class 1

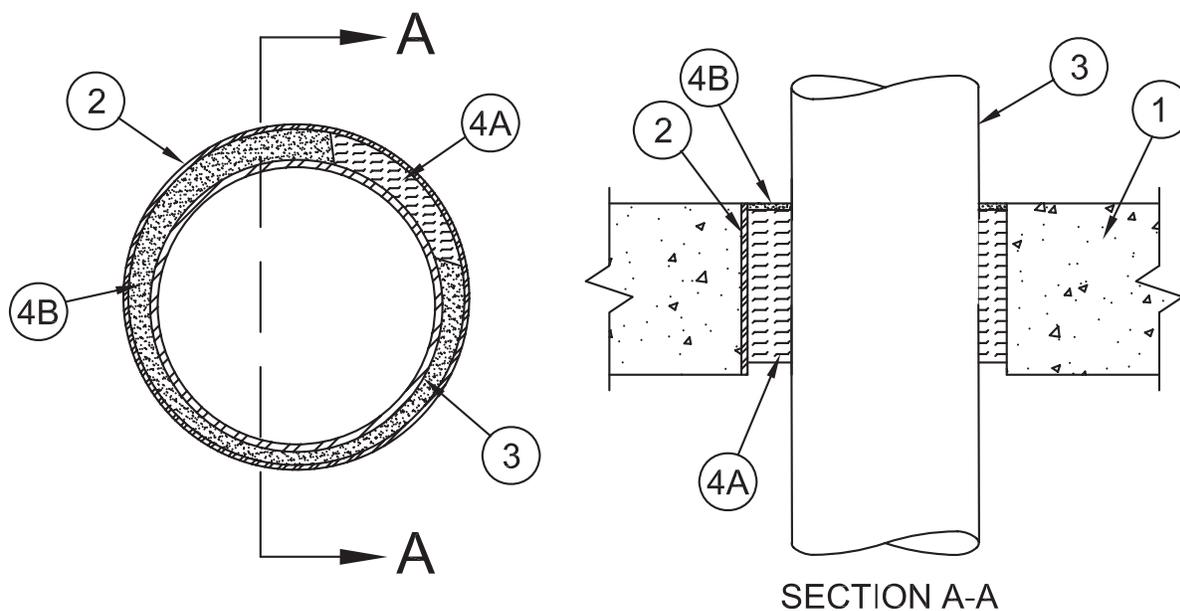

- Floor or Wall Assembly** – Min 4-1/2 in. (114 mm) thick reinforced lightweight or normal weight (100-150 pcf or 1600-2400 kg/m³) concrete. Wall may also be constructed of any UL Classified **Concrete Blocks***. Max diam of opening is 6 in. (152 mm).
See **Concrete Blocks** (CAZT) category in the Fire Resistance Directory for names of manufacturers.
- Sleeves** – (Optional) – The following sleeves may be used:
 - Metallic Sleeve** – Nom 6 in. (152 mm) diam (or smaller) steel Schedule 40 (or heavier) pipe cast or grouted into floor or wall assembly, flush with floor or wall surfaces. As an alternate, nom 6 in. (152 mm) diam (or smaller) sleeve fabricated from nom 0.019 in. (0.48 mm) thick galv steel cast or grouted into floor or wall assembly flush with floor or wall surfaces.
 - Nonmetallic Sleeve** – Nom 6 in. (152 mm) diam (or smaller) Schedule 40 polyvinyl chloride (PVC) pipe cast or grouted into floor or wall assembly, flush with floor or wall surfaces.
- Through Penetrants** – One metallic pipe, conduit or tubing installed either concentrically or eccentrically within the firestop system. The annular space shall be min 1/2 in. (13 mm) to max 2-3/8 in. (60 mm) Pipe, conduit or tubing to be rigidly supported on both sides of floor or wall assembly. The following types of pipe, conduit or tubing may be used:
 - Steel Pipe** – Nom 4 in. (102 mm) diam (or smaller) Schedule 10 (or heavier) steel pipe.
 - Conduit** – Nom 4 in. (102 mm) diam (or smaller) steel electrical metallic tubing (EMT) or steel conduit.
 - Copper Tubing** – Nom 3 in. (76 mm) diam (or smaller) Type M (or heavier) copper tubing.
 - Iron Pipe** – Nom 4 in. (102 mm) diam (or smaller) cast or ductile iron pipe.
- Firestop System** – The firestop system shall consist of the following:
 - Packing Material** – Min 3-3/4 in. (95 mm) thickness of min 4 pcf (64 kg/m³) mineral wool batt insulation firmly packed into opening as a permanent form so that the width of the wool is compressed at least 50 percent. Packing material to be recessed from top surface of floor or from both surfaces of wall as required to accommodate the required thickness of fill material.
 - Fill, Void or Cavity Material*** – **Sealant** – Min 1/4 in. (6 mm) thickness of sealant applied within the annulus, flush with the top surface of floor or with both surfaces of wall.

3M COMPANY – FB-1000 NS, FB-1003SL or FB-3000 WT

*Bearing the UL Classification Mark

Reprinted from the Online Certifications Directory with permission from Underwriters Laboratories Inc.
Copyright © 2010 Underwriters Laboratories Inc.®



System No. C-AJ-1306

August 23, 2004

F Rating – 2 Hr

T Rating – 0 Hr

W Rating – Class I (See Item 4)

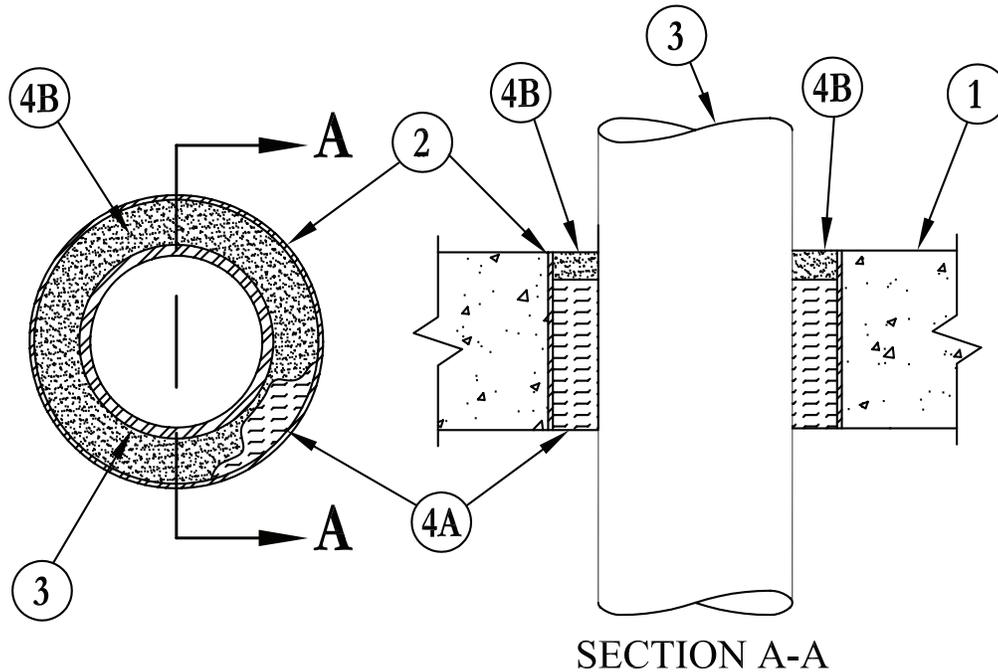

SECTION A-A

1. **Floor or Wall Assembly** – Min 4-1/2 in. thick reinforced lightweight or normal weight (100-150 pcf) concrete. Wall may also be constructed of any UL Classified **Concrete Blocks***. Max diam of opening is 10 in.
See **Concrete Blocks (CAZT)** category in the Fire Resistance Directory for names of manufacturers.
2. **Steel Sleeve** – Nom 10 in. diam (or smaller) Schedule 10 (or heavier) steel sleeve cast or grouted into floor or wall assembly.
3. **Aluminum Conduit** – Nom 8 in. diam (or smaller) 0.063 in. wall thickness or heavier aluminum beverage conduit centered within the sleeve with a nominal annular space between conduit and periphery of opening or sleeve of 1 in. Conduit to be rigidly supported on both sides of wall assembly.
4. **Firestop System** – The details of the firestop system shall be as follows:
 - A. **Packing Material** – Min 3-1/2 in. thickness of min 4 pcf mineral wool batt insulation firmly packed into opening as a permanent form. Packing material to be recessed from top surface of floor or from both surfaces of wall as required to accommodate the required thickness of fill material. Min 2 in. thickness of mineral wool batt insulation installed within both ends of the conduit at its termination points.
 - B. **Fill Void or Cavity Materials* – Caulk or Sealant** – Min 1 in. thickness of fill material applied within the annulus, flush with top surface of floor or with both surfaces of wall.
3M COMPANY – CP 25WB+ caulk or FB-3000 WT sealant. (Note: W Rating applies only when FB-3000 WT is used.)

*Bearing the UL Classification Marking

Reprinted from the Online Certifications Directory with permission from Underwriters Laboratories Inc.
Copyright © 2010 Underwriters Laboratories Inc.®



System No. C-AJ-1317

March 28, 2012

ANSI/UL1479 (ASTM E814)
 F Rating – 2 Hr
 T Rating – 0 Hr
 L Rating At Ambient – Less Than 1 CFM/sq ft
 L Rating At 400 F – 2 CFM/sq ft

CAN/ULC S115
 F Rating – 2 Hr
 FT Rating – 0 Hr
 FH Rating – 2 Hr
 FTH Rating – 0 Hr
 L Rating At Ambient – Less Than 1 CFM/sq ft
 L Rating At 400 F – 2 CFM/sq ft

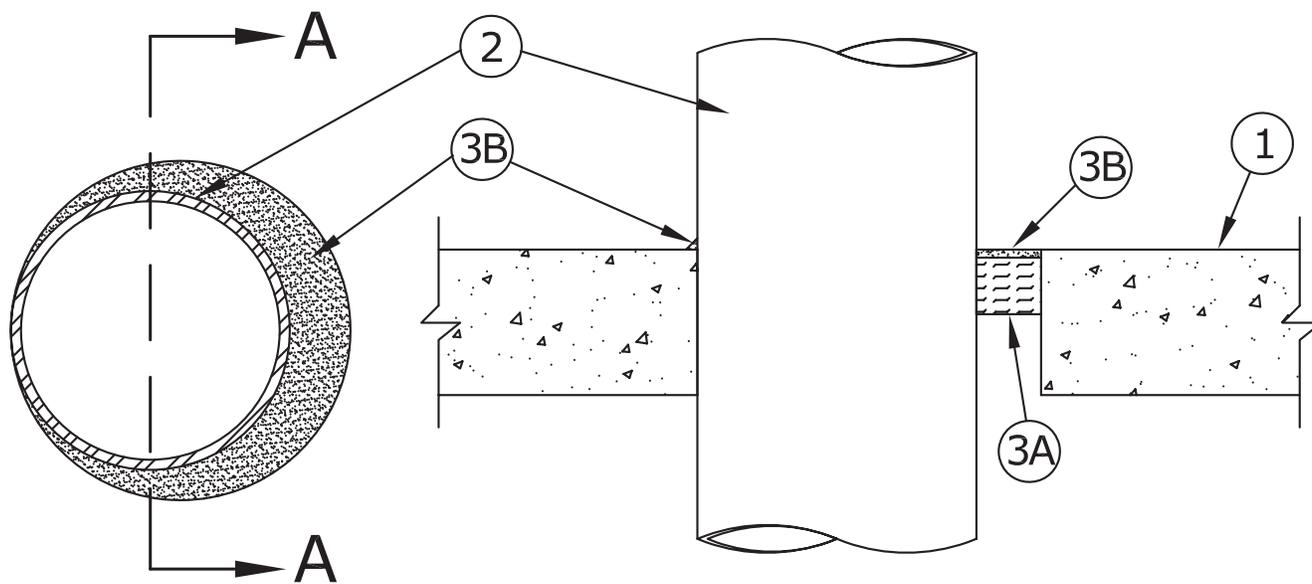

SECTION A-A

1. **Floor or Wall Assembly** – Min 4-1/2 in. (114 mm) thick reinforced lightweight or normal weight (100-150 pcf or 1600-2400 kg/m³) concrete. Wall may also be constructed of any UL Classified **Concrete Blocks***. Max diam of opening is 10-1/2 in. (267 mm).
 See **Concrete Blocks (CAZT)** category in the Fire Resistance Directory for names of manufacturers.
 2. **Through Penetrants** – One metallic pipe or tubing to be installed either concentrically or eccentrically within the firestop system. The annular space between tube and periphery of opening shall be min 0 in. (point contact) to max 1-7/8 in. (48 mm). Penetrants to be rigidly supported on both sides of floor or wall assembly. The following types and sizes of metallic pipes or tubing may be used:
 - A. **Steel Pipe** – Nom 8 in. (203 mm) diam (or smaller) Schedule 10 (or heavier) steel pipe.
 - B. **Iron Pipe** – Nom 8 in. (201 mm) diam (or smaller) cast or ductile iron pipe.
 - C. **Conduit** – Nom 6 in. (152 mm) diam (or smaller) steel conduit, or nom 4 in. (102 mm) diam (or smaller) steel electrical metallic tubing.
 - D. **Copper Tubing** – Nom 4 in. (102 mm) diam (or smaller) Type M (or heavier) copper tube.
 - E. **Copper Pipe** – Nom 4 in. (102 mm) diam (or smaller) Regular (or heavier) copper pipe.
 3. **Firestop System** – The details of the firestop system shall be as follows:
 - A. **Packing Material** – Min 2 in. (51 mm) thickness of min 4 pcf (64 kg/m³) mineral wool batt insulation firmly packed into opening as a permanent form. Packing material to be recessed from top surface of floor or from both surfaces of wall as required to accommodate the required thickness of fill material.
 - A1. **Forming Material*** – As an alternate to the packing material in Item 3, nom 4 in. (102 mm) wide strips of min 1/2 in. (13 mm) thick compressible mat to be stacked to a thickness greater than the width of the annular space and compression-fitted, edge-first, to fill the annular space to a min 4 in. (102 mm) depth. As an option, the strips of min 1/2 in. (13mm) thick compressible mat may be folded in half, lengthwise, and stacked to a thickness greater than the width of the annular space and compression-fitted, edge-first, to fill the annular space to a min 2 in. (51 mm) depth. Top of forming material to be recessed from top surface of floor or from both surfaces of wall as necessary to accommodate the required thickness of caulk fill material.
- 3M COMPANY**
3M FIRE PROTECTION PRODUCTS – Fire Barrier Packing Material
- B. **Fill Void or Cavity Materials*** – **Caulk** – Min 1/4 in. (6 mm) thickness of fill material applied within the annulus, flush with top surface of floor or with both surfaces of wall. Min 1/2 in. (13 mm) diam bead of caulk applied to the penetrant/concrete interface at the point contact location on the top surface of floor or both surfaces of wall.

3M COMPANY
3M FIRE PROTECTION PRODUCTS – FD-150+ Caulk

*Bearing the UL Classification Mark

Reprinted from the Online Certifications Directory with permission from UL
 © 2013 UL LLC



System No. C-AJ-1338

August 23, 2004

F Rating – 2 Hr

T Rating – 0 Hr

W Rating – Class I (See Item 3)

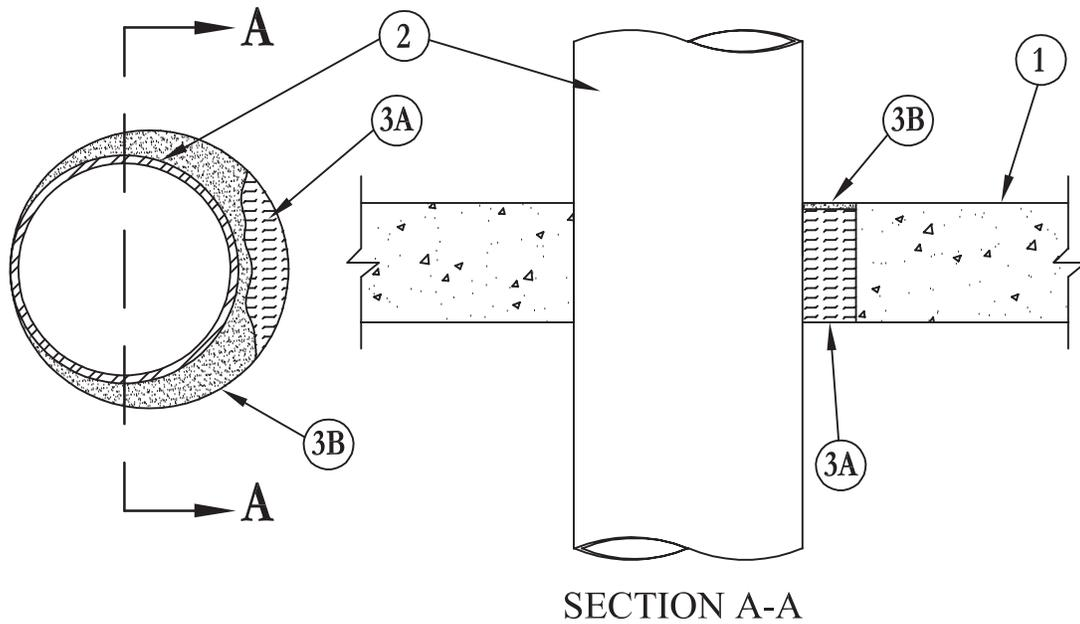

SECTION A-A

1. **Floor or Wall Assembly** – Min 2-1/2 in. thick reinforced lightweight or normal weight (100-150 pcf) concrete. Wall may also be constructed of any UL Classified **Concrete Blocks***. Max diam of opening is 25-7/8 in.
See **Concrete Blocks (CAZT)** category in the Fire Resistance Directory for names of manufacturers.
2. **Through Penetrants** – One metallic pipe or tubing to be installed either concentrically or eccentrically within the firestop system. The annular space between tube and periphery of opening shall be min 0 in. to max 1-7/8 in. Penetrants to be rigidly supported on both sides of floor or wall assembly. The following types and sizes of metallic pipes or tubing may be used:
 - A. **Steel Pipe** – Nom 24 in. diam (or smaller) Schedule 10 (or heavier) steel pipe.
 - B. **Iron Pipe** – Nom 24 in. diam (or smaller) cast or ductile iron pipe.
 - C. **Conduit** – Nom 6 in. diam (or smaller) steel conduit, or nom 4 in. (or smaller) steel electrical metallic tubing.
 - D. **Copper Tubing** – Nom 6 in. diam (or smaller) Type M (or heavier) copper tube.
 - E. **Copper Pipe** – Nom 6 in. diam (or smaller) Regular (or heavier) copper pipe.
3. **Firestop System** – The details of the firestop system shall be as follows:
 - A. **Packing Material** – Min 2-1/4 in. thickness of min 4 pcf mineral wool batt insulation firmly packed into opening as a permanent form. Packing material to be recessed from top surface of floor or from both surfaces of wall as required to accommodate the required thickness of fill material.
 - B. **Fill, Void or Cavity Materials* – Caulk or Sealant** – Min 1/4 in. thickness of fill material applied within the annulus, flush with top surface of floor or with both surfaces of wall. Min 1/2 in. diam bead of caulk applied to the penetrant/concrete interface at the point contact location on the top surface of floor or both surfaces of wall.
3M COMPANY – CP 25WB+ caulk or FB-3000 WT sealant. (Note: W Rating applies only when FB-3000 WT is used.)

*Bearing the UL Classification Mark

Reprinted from the Online Certifications Directory with permission from Underwriters Laboratories Inc.
Copyright © 2010 Underwriters Laboratories Inc.®



System No. C-AJ-1364

February 08, 2010

F Rating – 2 Hr

T Rating – 0 Hr

L Rating At Ambient – Less Than 1 CFM/sq ft

L Rating At 400 F – 2 CFM/sq ft

W Rating – Class 1

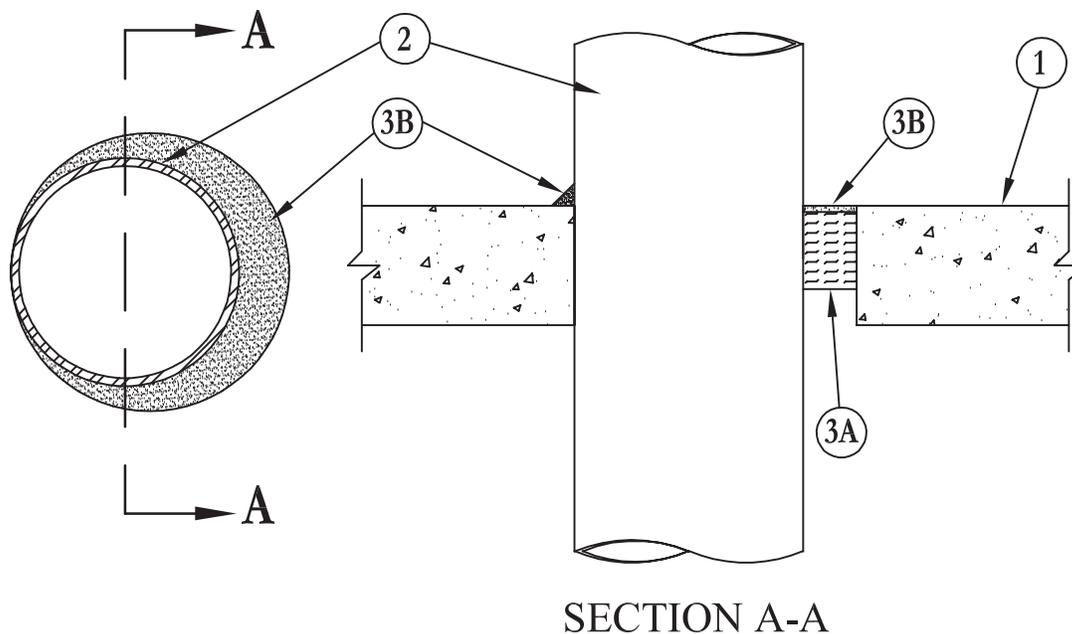

- Floor Assembly** – Min 4-1/2 in. (114 mm) thick reinforced lightweight or normal weight (100-150 pcf or 1600 - 2400 kg/m³) concrete. Wall may also be constructed of any UL Classified **Concrete Blocks***. Max diam of opening is 25-7/8 in. (657 mm).
See **Concrete Blocks** (CAZT) category in the Fire Resistance Directory for names of manufacturers.
- Through Penetrants** – One metallic pipe, tubing or conduit to be installed either concentrically or eccentrically within the firestop system. The annular space between tube and periphery of opening shall be min 0 in. (point contact) to max 1-7/8 in. (48 mm). Penetrants to be rigidly supported on both sides of floor assembly. The following types and sizes of metallic pipes, tubing or conduit may be used:
 - Steel Pipe** – Nom 24 in. (610 mm) diam (or smaller) Schedule 10 (or heavier) steel pipe.
 - Iron Pipe** – Nom 24 in. (610 mm) diam (or smaller) cast or ductile iron pipe.
 - Conduit** – Nom 6 in. (152 mm) diam (or smaller) rigid steel conduit.
 - Conduit** – Nom 4 in. (102 mm) (or smaller) steel electrical metallic tubing.
 - Copper Tubing** – Nom 6 in. (152 mm) diam (or smaller) Type L (or heavier) copper tube.
 - Copper Pipe** – Nom 6 in. (152 mm) diam (or smaller) Regular (or heavier) copper pipe.
- Firestop System** – The details of the firestop system shall be as follows:
 - Packing Material** – Min 3 in. (76 mm) thickness of min 4 pcf (64 kg / m³) mineral wool batt insulation firmly packed into opening as a permanent form. Packing material to be recessed from top surface of floor to accommodate the required thickness of fill material.
 - Fill, Void or Cavity Materials* – Sealant** – Min 1/4 in. (6 mm) thickness of fill material applied within the annulus, flush with top surface of floor. Min 1/2 in. (13 mm) diam bead of caulk applied to the penetrant/concrete interface at the point contact location on the top surface of floor.
3M COMPANY – FB-1000 NS, FB-1003 SL or FB-3000 WT

*Bearing the UL Classification Mark

Reprinted from the Online Certifications Directory with permission from Underwriters Laboratories Inc.
Copyright © 2010 Underwriters Laboratories Inc.®



System No. C-AJ-1366

December 04, 2008

F Rating – 2 Hr

T Rating – 0 Hr

L Rating At Ambient – Less Than 1 CFM/sq ft

L Rating At 400 F – 2 CFM/sq ft

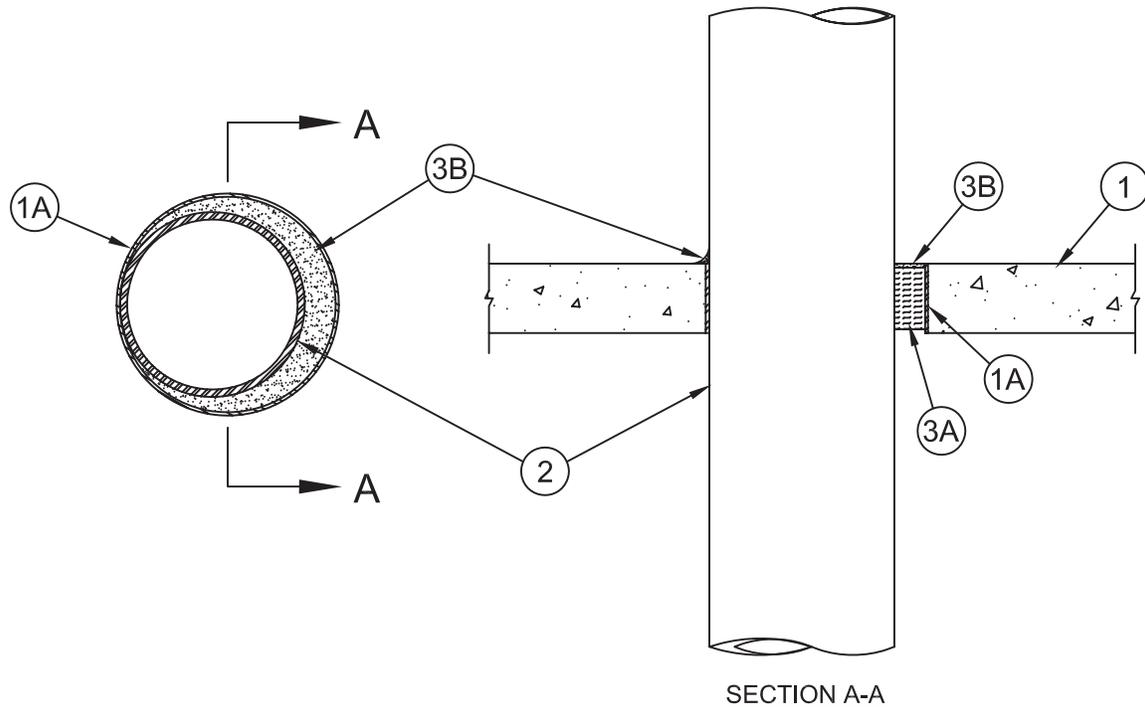

1. **Floor or Wall Assembly** – Min 2-1/2 in. (64 mm) thick reinforced lightweight or normal weight (100-150 pcf or 1600-2400 kg/m³) concrete floor or min 3 in. (76 mm) thick, reinforced lightweight or normal weight (100-150 pcf or 1600-2400 kg/m³) concrete wall. Wall may also be constructed of any UL Classified **Concrete Blocks***. Max diam of opening is 10 in. (254 mm).
See **Concrete Blocks (CAZT)** category in the Fire Resistance Directory for names of manufacturers.
- 1A. **Steel Sleeve (Optional)** – Nom 10 in. (254 mm) diam (or smaller) Schedule 10 (or heavier) steel pipe sleeve cast into concrete floor or wall. Sleeve to be flush with top and bottom surfaces of floor or both surfaces of wall.
2. **Through Penetrants** – One metallic pipe, tubing or conduit to be installed either concentrically or eccentrically within the firestop system. The annular space between tube and periphery of opening shall be min 0 in. to max 7/8 in. (22 mm). Penetrants to be rigidly supported on both sides of floor assembly. The following types and sizes of metallic pipes, tubing or conduit may be used:
 - A. **Steel Pipe** – Nom 8 in. (203 mm) diam (or smaller) Schedule 10 (or heavier) steel pipe.
 - B. **Iron Pipe** – Nom 8 in. (203 mm) diam (or smaller) cast or ductile iron pipe.
 - C. **Conduit** – Nom 6 in. (152 mm) diam (or smaller) rigid steel conduit.
 - D. **Conduit** – Nom 4 in. (102 mm) diam (or smaller) steel electrical metallic tubing.
 - E. **Copper Tubing** – Nom 4 in. (102 mm) diam (or smaller) Type L (or heavier) copper tube.
 - F. **Copper Pipe** – Nom 4 in. (102 mm) diam (or smaller) Regular (or heavier) copper pipe.
3. **Firestop System** – The details of the firestop system shall be as follows:
 - A. **Packing Material** – Min 2 in. (51 mm) thickness of min 4 pcf (64 kg/m³) mineral wool batt insulation firmly packed into opening as a permanent form. Packing material to be recessed from top surface of floor or both surfaces of wall to accommodate the required thickness of fill material.
 - B. **Fill, Void or Cavity Materials*** – **Caulk** – Min 1/2 in. (13 mm) thickness of caulk applied within the annulus, flush with top surface of floor or both surfaces of wall. Min 1/2 in. (13 mm) diam bead of caulk applied to the penetrant/concrete interface at the point contact location on the top surface of floor or both surfaces of wall.

3M COMPANY – FireDam 150+

*Bearing the UL Classification Mark

Reprinted from the Online Certifications Directory with permission from Underwriters Laboratories Inc.

Copyright © 2010 Underwriters Laboratories Inc.®



System No. C-AJ-1427

March 05, 2007

F Rating – 3 Hr

T Rating – 0 Hr

W Rating – Class 1 (See Item 3)

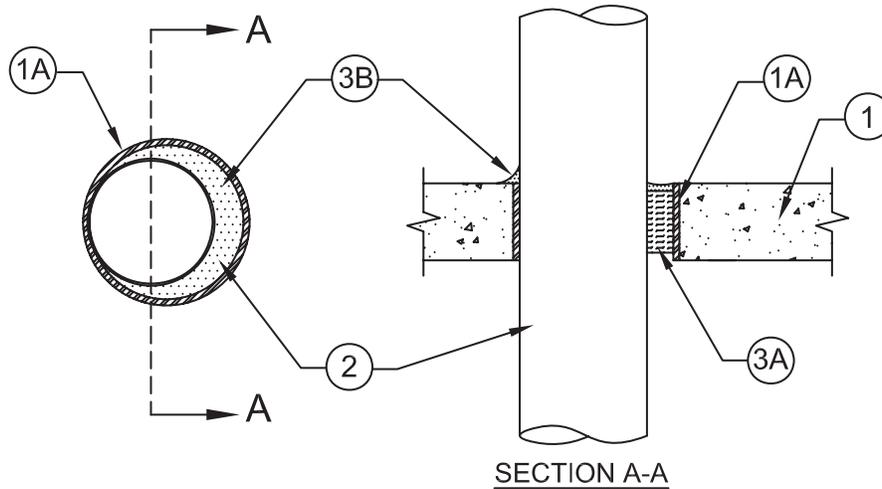

1. **Floor or Wall Assembly** – Min 2-1/2 in. (64 mm) thick reinforced lightweight or normal weight (100-150 pcf or 1600 - 2400 kg/m³) concrete floors or min 3 in. (76 mm) thick reinforced lightweight or normal weight concrete walls. Floor assembly may also be constructed of any min 6 in. (152 mm) thick UL Classified hollow-core **Precast Concrete Units***. Wall may also be constructed of any UL Classified **Concrete Blocks***. Max diam of opening 12-3/4 in. (324 mm). Max diam of opening in floors constructed of hollow-core concrete is 7 in. (78 mm).
See **Concrete Blocks (CAZT)** and **Precast Concrete Units (CFTV)** categories in Fire Resistance Directory for names of manufacturers.
- 1A. **Steel Sleeve** – (Optional) - Nom 12 in. (305 mm) diam (or smaller) Schedule 10 (or heavier) steel sleeve cast or grouted into floor or wall assembly. Steel sleeve may be installed flush or may project max 2 in. (51 mm) beyond the floor or wall surfaces. As an alternate, nom 12 in. (305 mm) diam (or smaller) sleeve fabricated from nom 0.019 in. (0.48 mm) thick galv steel cast or grouted into floor or wall assembly flush with floor or wall surfaces.
2. **Through Penetrant** – One metallic pipe, conduit, tubing or flexible metal piping installed concentrically or eccentrically within opening. Annular space between penetrant and periphery of opening or sleeve shall be min of 0 in. (0 mm) (point contact) to max 2 in. (51 mm). Penetrant to be rigidly supported on both sides of floor or wall assembly. The following types and sizes of penetrants may be used:
 - A. **Steel Pipe** – Nom 10 in. (254 mm) diam (or smaller) Schedule 10 (or heavier) steel pipe.
 - B. **Iron Pipe** – Nom 10 in. (254 mm) diam (or smaller) cast or ductile iron pipe.
 - C. **Conduit** – Nom 6 in. (152 mm) diam (or smaller) steel conduit or nom 4 in. (102 mm) diam (or smaller) steel electrical metallic tubing.
 - D. **Copper Tubing** – Nom 4 in. (102 mm) diam (or smaller) Type L (or heavier) copper tubing.
 - E. **Copper Pipe** – Nom 4 in. (102 mm) diam (or smaller) Regular (or heavier) copper pipe.
 - F. **Through Penetrating Product* – Flexible Metal Piping** – The following types of steel flexible metal gas piping may be used:
 - 1.) Nom 2 in. (51 mm) diam (or smaller) steel flexible metal gas piping. Plastic covering on piping may or may not be removed on both sides of floor or wall assembly.
OMEGA FLEX INC
 - 2.) Nom 1 in. (25 mm) diam (or smaller) steel flexible metal gas piping. Plastic covering on piping may or may not be removed on both sides of floor or wall assembly.
GASTITE, DIV OF TITFLEX
 - 3.) Nom 1 in. (25 mm) diam (or smaller) steel flexible metal gas piping. Plastic covering on piping may or may not be removed on both sides of floor or wall assembly.
WARD MFG INC
3. **Firestop System** – The details of the firestop system shall be as follows:
 - A. **Packing Material** – Min 2 in. (51 mm) thickness of min 4 pcf (64 kg/m³) mineral wool batt insulation firmly packed into opening as a permanent form. Packing material to be recessed from top surface of floor or top edge of sleeve or from both surfaces of wall or both ends of sleeve as required to accommodate the required thickness of fill material. In floors constructed of hollow-core concrete, packing material to be recessed from top and bottom surfaces of floor or sleeve as required to accommodate the required thickness of fill material.
 - B. **Fill, Void or Cavity Materials* – Caulk or Sealant** – Min 1/2 in. (13 mm) thickness of caulk applied within the annulus, flush with top surface of floor or top edge of sleeve or with both surfaces of wall or both ends of sleeves. In floors constructed of hollow-core concrete, min 1/2 in. (13 mm) thickness of caulk applied within the annulus, flush with top and bottom surfaces of floor or sleeve. Min 1/4 in. (6 mm) diam bead of caulk applied to the penetrant/concrete or penetrant/sleeve interface at the point contact location on the top surface of floor or both surfaces of wall or hollow-core.
3M COMPANY – IC 15WB+, CP 25WB+ caulk or FB-3000 WT sealant
(Note: W Rating applies only when FB-3000 WT is used.)

*Bearing the UL Classification Mark

Reprinted from the Online Certifications Directory with permission from Underwriters Laboratories Inc.
Copyright © 2010 Underwriters Laboratories Inc.®



System No. C-AJ-1428

February 06, 2013

ANSI/UL1479 (ASTM E814)
 F Rating – 2 Hr
 T Rating – 0 Hr
 W Rating – Class 1 (See Item 4)

CANULC S115
 F Rating – 2 Hr
 FT Rating – 0 Hr
 FH Rating – 2 Hr
 FTH Rating – 0 Hr

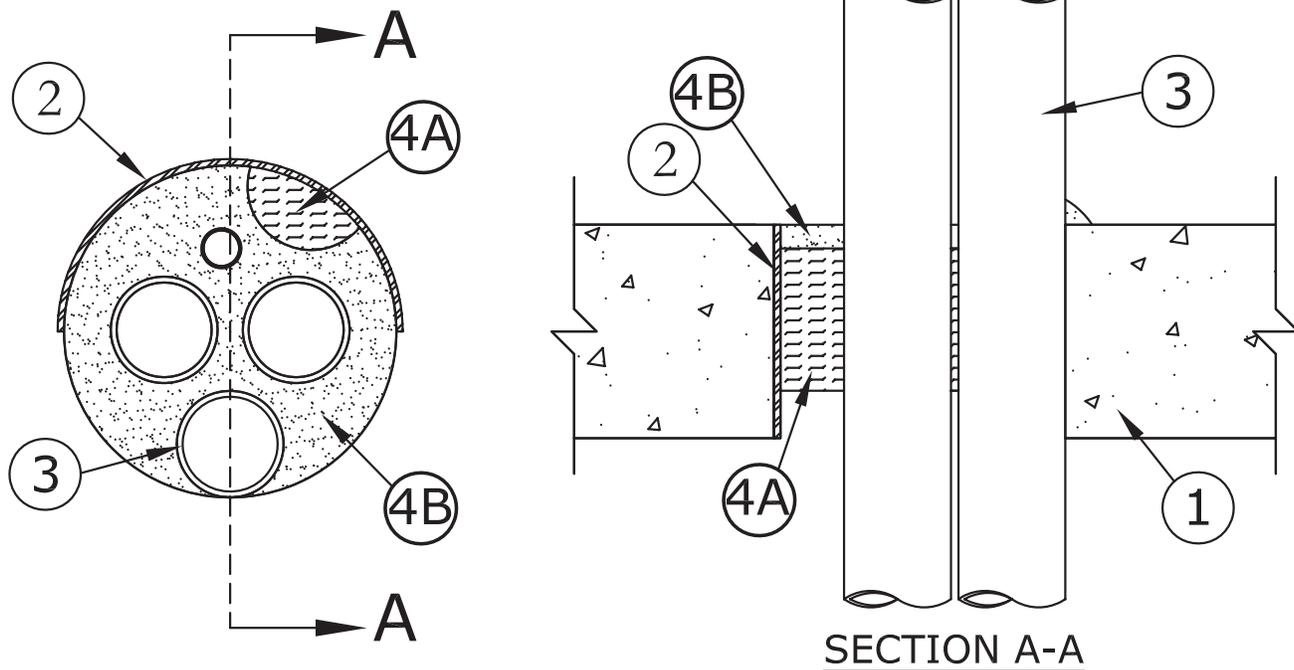

1. **Floor or Wall Assembly** – Min 2-1/2 in. (64 mm) thick reinforced lightweight or normal weight (100-150 pcf or 1600 - 2400 kg/m³) concrete floors or min 3 in. (76 mm) thick reinforced lightweight or normal weight concrete walls. Floor assembly may also be constructed of any min 6 in. (152 mm) thick UL Classified hollow-core **Precast Concrete Units***. Wall may also be constructed of any UL Classified **Concrete Blocks***. Max diam of opening 12 in. (305 mm). Max diam of opening in floors constructed of hollow-core concrete is 7 in. (178 mm).
 See **Concrete Blocks (CAZT)** and **Precast Concrete Units (CFTV)** categories in Fire Resistance Directory for names of manufacturers.
2. **Steel Sleeve** – Optional, Nom 10 in. (254 mm) diam (or smaller) Schedule 10 (or heavier) steel sleeve cast or grouted into floor or wall assembly. Steel sleeve may be installed flush or may project max 2 in. (51 mm) beyond the floor or wall surfaces.
3. **Through-Penetrant** – One or more metallic pipes, conduits, tubes or flexible metal pipes installed concentrically or eccentrically within opening. Annular space between penetrants and periphery of opening or sleeve shall be min of 0 in. (0 mm) (point contact) to max 2-1/2 in. (64 mm). The space between penetrants shall be min of 1/4 in. (6 mm) to max 2-1/2 in. (64 mm). Penetrants to be rigidly supported on both sides of floor or wall assembly. The following types and sizes of penetrants may be used:
 - A. **Steel Pipe** – Nom 4 in. (102 mm) diam (or smaller) Schedule 10 (or heavier) steel pipe.
 - B. **Iron Pipe** – Nom 4 in. (102 mm) diam (or smaller) cast or ductile iron pipe.
 - C. **Conduit** – Nom 4 in. (102 mm) diam (or smaller) steel conduit or steel electrical metallic tubing.
 - D. **Copper Tubing** – Nom 3 in. (76 mm) diam (or smaller) Type L (or heavier) copper tubing.
 - E. **Copper Pipe** – Nom 3 in. (76 mm) diam (or smaller) Regular (or heavier) copper pipe.
 - F. **Through Penetrating Product* – Flexible Metal Piping** – The following types of steel flexible metal gas piping may be used:
 - 1.) Nom 2 in. (51 mm) diam (or smaller) steel flexible metal gas piping. Plastic covering on piping may or may not be removed on both sides of floor or wall assembly.
OMEGA FLEX INC
 - 2.) Nom 1 in. (25 mm) diam (or smaller) steel flexible metal gas piping. Plastic covering on piping may or may not be removed on both sides of floor or wall assembly.
GASTITE, DIV OF TITFLEX
 - 3.) Nom 1 in. (25 mm) diam (or smaller) steel flexible metal gas piping. Plastic covering on piping may or may not be removed on both sides of floor or wall assembly.
WARD MFG LLC
4. **Firestop System** – The details of the firestop system shall be as follows:
 - A. **Packing Material** – Min 2 in. (51 mm) thickness of min 4 pcf (64 kg/m³) mineral wool batt insulation firmly packed into opening as a permanent form. Packing material to be recessed from top surface of floor or top edge of sleeve or from both surfaces of wall or both ends of sleeve as required to accommodate the required thickness of fill material. In floors constructed of hollow-core concrete, packing material to be recessed from top and bottom surfaces of floor or sleeve as required to accommodate the required thickness of fill material.

System No. C-AJ-1428

- A1. **Forming Material*** – As an alternate to the packing material in Item 4A, nom 4 in. (102 mm) wide strips of min 1/2 in (13 mm) thick compressible mat folded in half, lengthwise, and stacked to a thickness greater than the width of the annular space and compression-fitted, edge-first, to fill the annular space to a min 2 in. (51 mm) depth. Top of forming material to be recessed from top surface of floor or top edge of sleeve or from both surfaces of wall or both ends of sleeve in wall as necessary to accommodate the required thickness of caulk fill material. In floors constructed of hollow-core concrete, packing material to be recessed from top and bottom surfaces of floor or sleeve as required to accommodate the required thickness of fill material.

3M COMPANY

3M FIRE PROTECTION PRODUCTS – Fire Barrier Packing Material

- B. **Fill, Void or Cavity Materials* – Caulk or Sealant** – Min 1/2 in. (13 mm) thickness of caulk applied within the annulus, flush with top surface of floor or top edge of sleeve or with both surfaces of wall or both ends of sleeves. In floors constructed of hollow-core concrete, min 1/2 in. (13 mm) thickness of caulk applied within the annulus, flush with top and bottom surfaces of floor or sleeve. Min 1/4 in. (6 mm) diam bead of caulk applied to the penetrant/concrete or penetrant/sleeve interface at the point contact location on the top surface of floor or both surfaces of wall or hollow-core concrete.

3M COMPANY

3M FIRE PROTECTION PRODUCTS – IC 15WB+, CP 25WB+ caulk or FB-3000 WT sealant

(Note: W Rating applies only when FB-3000 WT Sealant is used.)

*Bearing the UL Classification Mark

Reprinted from the Online Certifications Directory with permission from UL
© 2013 UL LLC



Through Penetrations

Metallic Pipes

1000 Series

Concrete

CAJ

System No. C-AJ-1429

March 05, 2007

F Rating – 2 Hr

T Rating – 0 Hr

W Rating – Class 1 (See Item 3)

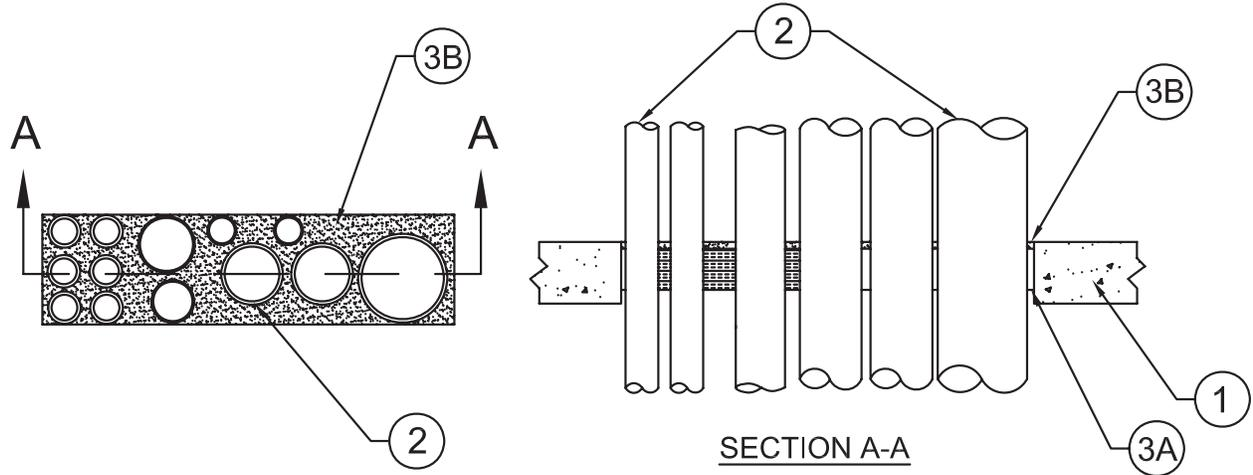

1. **Floor or Wall Assembly** – Min 4-1/2 in. (114 mm) thick reinforced lightweight or normal weight (100-150 pcf or 1600-2400 kg/m³) concrete. Floor assembly may also be constructed of any min 6 in. (152 mm) thick UL Classified hollow-core **Precast Concrete Units***. Wall may also be constructed of any UL Classified **Concrete Blocks***. Max area of opening 240 sq in. (1548 sq cm) with a max dimension of 30 in. (762 mm). Max area of opening in floors constructed of hollow-core concrete is 49 sq in. (316 sq cm) with a max dimension of 7 in. (178 mm).

See **Concrete Blocks (CAZT)** and **Precast Concrete Units (CFTV)** categories in Fire Resistance Directory for names of manufacturers.

- 1A. **Steel Sleeve** – (Optional, Not Shown) – Nom 16 in. (406 mm) diam (or smaller) circular sleeve fabricated from nom 0.028 in. (0.71 mm) thick galv steel cast or grouted into floor or wall assembly flush with floor or wall surfaces.
2. **Through Penetrant** – One or more metallic pipes, conduits, tubes or flexible metal pipes installed concentrically or eccentrically within opening. Annular space between penetrants and periphery of opening shall be min of 0 in. (0 mm) (point contact) to max 2 in. (51 mm) Space between penetrants shall be min of 1/4 in. (6 mm) to max 2 in. (51 mm). Penetrants to be rigidly supported on both sides of floor or wall assembly. The following types and sizes of penetrants may be used:
 - A. **Steel Pipe** – Nom 6 in. (152 mm) diam (or smaller) Schedule 10 (or heavier) steel pipe.
 - B. **Iron Pipe** – Nom 6 in. (152 mm) diam (or smaller) cast or ductile iron pipe.
 - C. **Conduit** – Nom 6 in. (152 mm) diam (or smaller) steel conduit or nom 4 in. (102 mm) diam (or smaller) steel electrical metallic tubing.
 - D. **Copper Tubing** – Nom 3 in. (76 mm) diam (or smaller) Type L (or heavier) copper tubing.
 - E. **Copper Pipe** – Nom 3 in. (76 mm) diam (or smaller) Regular (or heavier) copper pipe.
 - F. **Through Penetrating Product* – Flexible Metal Piping** – The following types of steel flexible metal gas piping may be used:
 1. Nom 2 in. (51 mm) diam (or smaller) steel flexible metal gas piping. Plastic covering on piping may or may not be removed on both sides of floor or wall assembly.
OMEGA FLEX INC.
 2. Nom 1 in. (25 mm) diam (or smaller) steel flexible metal gas piping. Plastic covering on piping may or may not be removed on both sides of floor or wall assembly.
GASTITE, DIV OF TITEFLEX
 3. Nom 1 in. (25 mm) diam (or smaller) steel flexible metal gas piping. Plastic covering on piping may or may not be removed on both sides of floor or wall assembly.
WARD MFG INC.
3. **Firestop System** – The details of the firestop system shall be as follows:
 - A. **Packing Material** – Min 3 in. (76 mm) thickness of min 4 pcf (64 kg/m³) mineral wool batt insulation firmly packed into opening as a permanent form. Packing material to be recessed from top surface of floor or from both surfaces of wall as required to accommodate the required thickness of fill material. In floors constructed of hollow-core concrete, packing material to be recessed from top and bottom surfaces of floor as required to accommodate the required thickness of fill material.
 - B. **Fill, Void or Cavity Materials* – Caulk or Sealant** – Min 1/2 in. (13 mm) thickness of caulk applied within the annulus, flush with top surface of floor or with both surfaces of wall. In floors constructed of hollow-core concrete, min 1/2 in. (13 mm) thickness of caulk applied within the annulus, flush with top and bottom surfaces of floor. Min 1/4 in. (6 mm) diam bead of caulk applied to the penetrant/concrete interface at the point contact location on the top surface of floor or both surfaces of wall or hollow-core concrete.
3M COMPANY – IC 15WB+, CP 25WB+ caulk or FB-3000 WT sealant.
(Note: W Rating applies only when FB-3000 WT is used.)

* Bearing the UL Classification Marking

Reprinted from the Online Certifications Directory with permission from Underwriters Laboratories Inc.
Copyright © 2010 Underwriters Laboratories Inc.®



System No. C-AJ-1473

August 18, 2009

F Rating – 2 Hr

T Rating – 2 Hr

L Rating at Ambient – 2 CFM/sq ft

L Rating at 400°F – Less than 1 CFM/sq ft

W Rating – Class 1 (See Item 3)

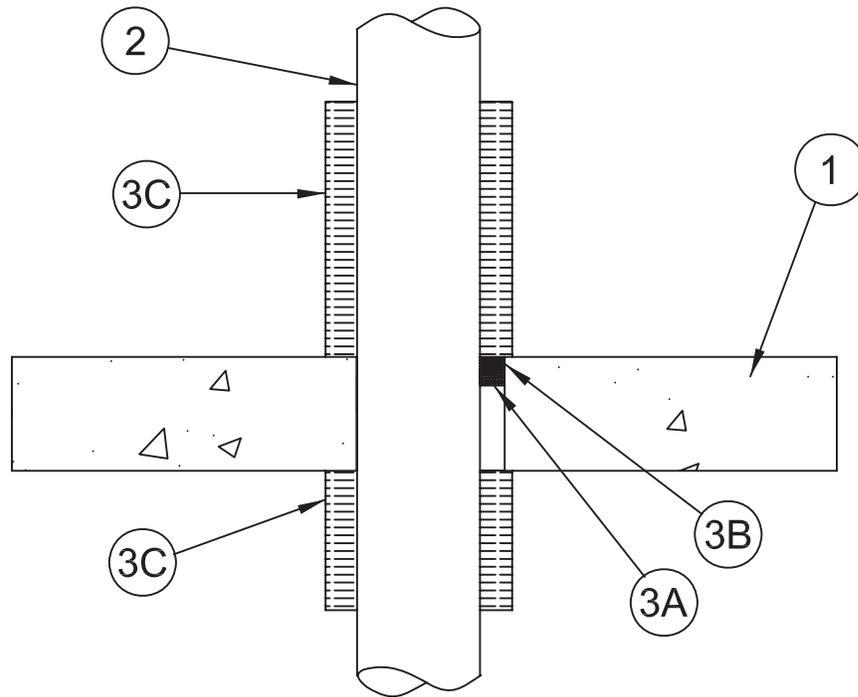
**SECTION A-A**

1. **Floor or Wall Assembly** – Min 4-1/2 in. (114 mm) thick reinforced lightweight or normal weight (100-150 pcf or 1600-2400 kg/m³) concrete. Wall may also be constructed of any UL Classified **Concrete Blocks***. Max diam of opening 12-3/4 in. (324 mm).
See **Concrete Blocks** (CAZT) category in Fire Resistance Directory for names of manufacturers.
- 1A. **Steel Sleeve** – (Optional, Not Shown) – Nom 12 in. (305 mm) diam (or smaller) sleeve fabricated from nom 0.019 in. (0.48 mm) thick galv steel cast or grouted into floor or wall assembly flush with floor or wall surfaces.
2. **Through-Penetrant** – One metallic pipe or tubing installed concentrically or eccentrically within opening. Annular space between penetrant and periphery of opening shall be min of 0 in. (0 mm) (point contact) to max 2 in. (51 mm). Penetrant to be rigidly supported on both sides of floor or wall assembly. The following types and sizes of penetrants may be used:
 - A. **Steel Pipe** – Nom 10 in. (254 mm) diam (or smaller) Schedule 10 (or heavier) steel pipe.
 - B. **Iron Pipe** – Nom 10 in. (254 mm) diam (or smaller) cast or ductile iron pipe.
 - C. **Copper Tubing** – Nom 4 in. (102 mm) diam (or smaller) Type L (or heavier) copper tubing.
 - D. **Copper Pipe** – Nom 4 in. (102 mm) diam (or smaller) Regular (or heavier) copper pipe.
 - E. **Conduit** – Nom 6 in. (152 mm) diam (or smaller) steel conduit or nom 4 in. (102 mm) diam (or smaller) steel electrical metallic tubing.
3. **Firestop System** – The details of the firestop system shall be as follows:
 - A. **Packing Material** – Min 1 in. (25 mm) thickness of min 4 pcf (64 kg/m³) mineral wool batt insulation firmly packed into opening as a permanent form. Packing material to be recessed from top surface of floor or from both surfaces of wall to accommodate the required thickness of fill material. When optional steel sleeve is used, packing material to extend through floor or wall thickness except for recesses needed to accommodate fill material (Item 3B).
 - B. **Fill, Void or Cavity Materials* – Caulk, Sealant or Putty** – Min 1 in. (25 mm) thickness of caulk or putty applied within the annulus, flush with top surface of floor or with both surfaces of wall.
3M COMPANY – CP 25WB+ caulk, FB-3000 WT sealant or MP+ putty
(Note: W Rating applies only when FB-3000 WT is used.)
 - C. **Duct Wrap Material*** – Nom 2 in. (51 mm) thick duct wrap tightly wrapped around penetrant to extend 12 in. (305 mm) below floor and 36 in. (914 mm) above floor or 36 in. (914 mm) beyond both surfaces of wall. Longitudinal seams sealed with foil tape.
3M COMPANY – Fire Barrier Duct Wrap 20A, 3M Fire Barrier Duct Wrap 615, 3M Fire Barrier Duct Wrap 615+

*Bearing the UL Classification Mark

Reprinted from the Online Certifications Directory with permission from Underwriters Laboratories Inc.

Copyright © 2010 Underwriters Laboratories Inc.®



System No. C-AJ-1496

May 18, 2005

F Rating – 3 Hr

T Rating – 0 Hr

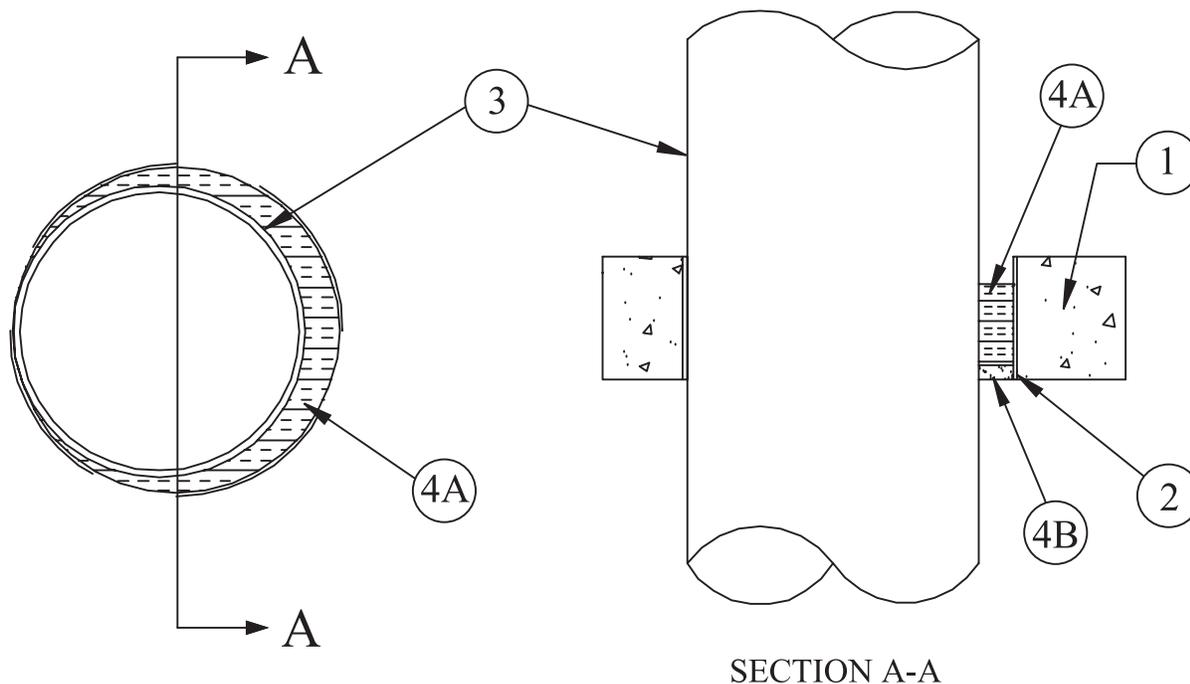

SECTION A-A

- Floor or Wall Assembly** – Min 4-1/2 in. (114 mm) thick reinforced lightweight or normal weight (100-150 pcf or 1600-2400 kg/m³) concrete. Wall may also be constructed of any UL Classified Concrete Blocks*. Max diam of opening 13-3/4 in. (349 mm).
See **Concrete Blocks** (CAZT) category in Fire Resistance Directory for names of manufacturers.
- Steel Sleeve** – (optional) – Schedule 10 (or heavier) steel sleeve or grouted into slab, flush with bottom of floor. Sleeve may extend a max of 2 in. (51 mm) above top surface of floor or both surfaces of wall.
- Through Penetrant** – One metallic pipe or tubing installed concentrically or eccentrically within opening. Annular space between penetrant and sleeve or periphery of opening shall be min of 0 in. (0 mm) (point contact) to max 3 in. (76 mm). Penetrant to be rigidly supported on both sides of floor or wall assembly. The following types and sizes of penetrants may be used:
 - Steel Pipe** – Nom 10 in. (254 mm) diam (or smaller) Schedule 10 (or heavier) steel pipe.
 - Iron Pipe** – Nom 10 in. (254 mm) diam (or smaller) cast or ductile iron pipe.
 - Conduit** – Nom 6 in. diam (or smaller) steel conduit or nom 4 in. diam (or smaller) steel electrical metallic tubing.
 - Copper Tubing** – Nom 4 in. (102 mm) diam (or smaller) Type L (or heavier) copper tubing.
 - Copper Pipe** – Nom 4 in. (102 mm) diam (or smaller) Regular (or heavier) copper pipe.
- Firestop System** – The firestop system shall consist of the following:
 - Packing Material** – Min 3 in. (76 mm) thickness of min 4 pcf (64 kg/m³) mineral wool batt insulation firmly packed into opening as a permanent form. Packing material to be recessed from bottom surface of floor or from both surfaces of wall to accommodate the required thickness of fill material.
 - Fill, Void or Cavity Materials* – Caulk or Sealant** – Min 1/2 in. (13 mm) thickness of caulk applied within the annulus, flush with bottom surface of floor or with both surfaces of wall.
3M COMPANY – CP 25WB+, IC 15WB+ caulk or FB-3000 WT sealant.

*-Bearing the UL Classification Mark

Reprinted from the Online Certifications Directory with permission from Underwriters Laboratories Inc.
Copyright © 2010 Underwriters Laboratories Inc.®



Through Penetrations

Metallic Pipes

1000 Series

Concrete

CAJ

System No. C-AJ-1540

February 26, 2008

F Ratings – 2 and 3 Hr (See Items 1 and 2)

T Rating – 0 Hr

L Rating At Ambient – 1 CFM/sq ft. (See Item 3B)

L Rating At 400 F – Less Than 1 CFM/sq ft. (See Item 3B)

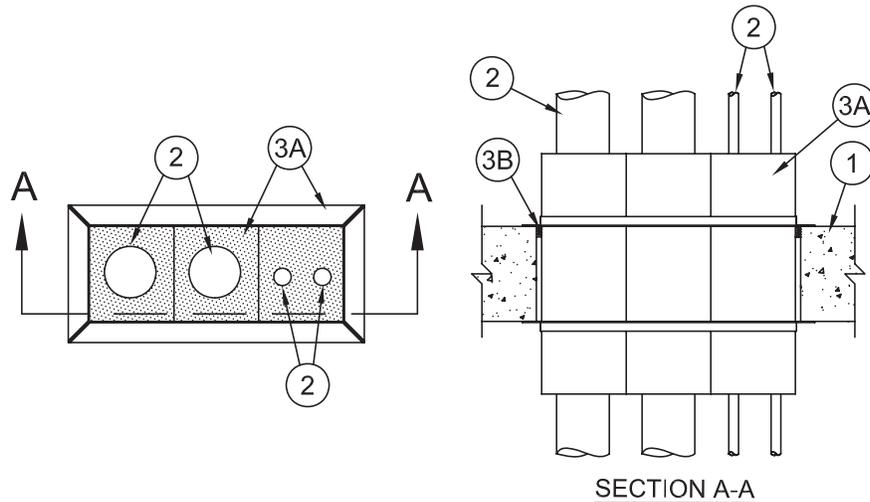

1. **Floor or Wall Assembly** – Min 2-1/2 in. (64 mm) thick reinforced lightweight or normal weight (100-150 pcf or 1600-2400 kg/m³) concrete required for 2 hr F Rating. Min 4-1/2 in. (114 mm) thick reinforced lightweight or normal weight (100-150 pcf or 1600-2400 kg/m³) concrete required for 3 hr F Rating. Wall may also be constructed of any UL Classified **Concrete Blocks***. Max area of opening is 56 in.² (363 cm²) with a max dimension of 12-1/2 in. (318 mm) for square devices. Max diam of opening is 2-1/2 in. (64 mm) for nom 2 in. (51 mm) round devices and 4-1/2 in. (114 mm) for nom 4 in. (102 mm) round devices.

See **Concrete Blocks (CAZT)** category in Fire Resistance Directory for names of manufacturers.

2. **Through Penetrant** – One or more metallic pipe, tubing or conduit may be installed concentrically or eccentrically within each firestop device (Item 3A). If multiple through penetrants are installed within the firestop device, through penetrants may be bundled together. Through penetrants to be rigidly supported on both sides of floor or wall assembly. The following types and sizes of through penetrants may be used:
 - A. **Steel Pipe** – Nom 3 in. (76 mm) diam (or smaller) Schedule 10 (or heavier) steel pipe.
 - B. **Iron Pipe** – Nom 3 in. (76 mm) diam (or smaller) cast or ductile iron pipe.
 - C. **Copper Tubing** – Nom 3 in. (76 mm) diam (or smaller) Type L (or heavier) copper tube.
 - D. **Copper Pipe** – Nom 3 in. (76 mm) diam (or smaller) Regular (or heavier) copper pipe.
 - E. **Conduit** – Nom 3 in. (76 mm) diam (or smaller) steel electric metallic tubing (EMT) or rigid steel conduit.
 - F. **Through-Penetrating Product*** – **Flexible Metal Piping** – Nom 1-1/4 in. (32 mm) diam (or smaller) steel flexible metal piping.

OMEGA FLEX INC – TracPipe Flexible Gas Piping

The F Rating of the firestop system is dependent upon the max nom diam of the through penetrant. If the max nom diam is nom 1-1/4 in. or less, the F Rating is 3 hr. If the max nom diam is greater than 1-1/2 in., the F Rating is 2 hr.

3. **Firestop System** – The firestop system shall consist of the following:
 - A. **Firestop Device*** – A max of three square firestop devices may be ganged together. As an alternate, one round device may be centered within a round opening. Each device consists of a nom 2-1/2 by 2-1/2 by 10 in. (64 by 64 by 254 mm), a nom 4 by 4 by 10 in. (102 by 102 by 254 mm), a nom 2 in. (51 mm) diam by 10 in. (254 mm) or a nom 4 in. (102 mm) diam by 10 in. painted steel transit incorporating internal intumescent material, foam plugs and mounting flanges. In nom 2-1/2 by 2-1/2 in. (64 by 64 mm) devices, the max nom diam of the through penetrant (Item 2) shall not exceed 1-1/4 in. (32 mm). Firestop device to be centered within opening and installed with ends projecting an equal distance beyond each surface of the floor or wall assembly in accordance with the accompanying installation instructions. The annular space between the firestop device(s) and the periphery of the opening shall be 0 in. (point contact) to max 1/4 in. (6 mm). Firestop devices secured in place by means of fill material (Item 3B) and steel split mounting flanges sized to accommodate the firestop device. Steel split mounting flanges installed on both sides of floor or wall after installation of fill material and secured to together with supplied steel set screws. Nom 1 in. (25 mm) thick foam plugs cut to accommodate the through penetrant(s) and installed flush with each end of device on both sides of floor or wall assembly.
 - B. **Fill, Void or Cavity Materials*** – **Caulk or Putty** – Min 1 in. (25 mm) thickness of fill material applied within the annulus between the outer perimeter of firestop device and periphery of opening prior to the installation of the mounting flanges, flush with top surface of floor or with both surfaces of wall. When the annular space is 1/8 in. (3.2 mm) or less, the fill material in the annulus is optional. Also, as an option, foam plugs may be recessed into device and the recess filled with putty or caulk flush with the ends of the device. L Rating applies only when fill material is applied within the annulus at interface of floor or both sides of wall and device(s) prior to the installation of the mounting flanges and with both ends of firestop device(s) filled with nominal 1/8 in. (3.2 mm) of Moldable Putty+.

3M COMPANY – Moldable Putty+, CP 25WB+, IC 15WB+, 3000 WT

*Bearing the UL Classification Mark

Reprinted from the Online Certifications Directory with permission from Underwriters Laboratories Inc.
Copyright © 2010 Underwriters Laboratories Inc.®



System No. C-AJ-1551

June 12, 2006

F Rating – 2 Hr

T Rating – 0 Hr

W Rating – Class 1 (See Item 4)

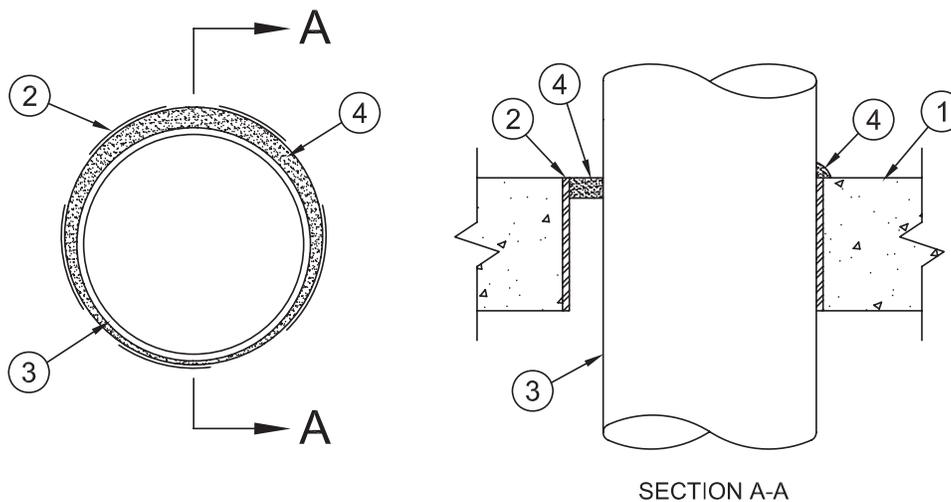

1. **Floor or Wall Assembly** – Min 2-1/2 in. (64 mm) thick reinforced lightweight or normal weight (100-150 pcf or 1600 - 2400 kg/m³) concrete floors or min 3-1/2 in. (89 mm) thick reinforced lightweight or normal weight concrete walls. Floor assembly may also be constructed of any min 6 in. (152 mm) thick UL Classified hollow-core **Precast Concrete Units***. Wall may also be constructed of any UL Classified **Concrete Blocks***. Max diam of opening 28 in. (711 mm). Max diam of opening in floors constructed of hollow-core concrete is 7 in. (78 mm).
See **Concrete Blocks (CAZT)** and **Precast Concrete Units (CFTV)** categories in Fire Resistance Directory for names of manufacturers.
2. **Steel Sleeve** – (Optional) – Nom 28 in. (711 mm) diam (or smaller) Schedule 10 (or heavier) steel sleeve cast or grouted into floor or wall assembly. Steel sleeve may be installed flush or may project max 2 in. (51 mm) beyond the floor or wall surfaces.
3. **Through Penetrant** – One metallic pipe, conduit, tubing or flexible metal piping installed concentrically or eccentrically within opening. Annular space between penetrant and periphery of opening or sleeve shall be min of 0 in. (0 mm, point contact) to max 3-7/8 in. (98 mm). Penetrant to be rigidly supported on both sides of floor or wall assembly. The following types and sizes of penetrants may be used:
 - A. **Steel Pipe** – Nom 24 in. (610 mm) diam (or smaller) Schedule 10 (or heavier) steel pipe.
 - B. **Iron Pipe** – Nom 24 in. (610 mm) diam (or smaller) cast or ductile iron pipe.
 - C. **Conduit** – Nom 6 in. (152 mm) diam (or smaller) steel conduit or nom 4 in. (102 mm) diam (or smaller) steel electrical metallic tubing.
 - D. **Copper Tubing** – Nom 6 in. (152 mm) diam (or smaller) Type L (or heavier) copper tubing.
 - E. **Copper Pipe** – Nom 6 in. (152 mm) diam (or smaller) Regular (or heavier) copper pipe.
 - F. **Through Penetrating Product* – Flexible Metal Piping** – The following types of steel flexible metal gas piping may be used:
 - 1) Nom 2 in. (51 mm) diam (or smaller) steel flexible metal gas piping. Plastic covering on piping may or may not be removed on both sides of floor or wall assembly.
OMEGA FLEX INC
 - 2) Nom 1 in. (25 mm) diam (or smaller) steel flexible metal gas piping. Plastic covering on piping may or may not be removed on both sides of floor or wall assembly.
GASTITE, DIV OF TITFLEX
 - 3) Nom 1 in. (25 mm) diam (or smaller) steel flexible metal gas piping. Plastic covering on piping may or may not be removed on both sides of floor or wall assembly.
WARD MFG INC
4. **Firestop System** – The details of the firestop system shall be as follows:
 - A. **Packing Material** – (Optional, Not Shown) – Polyethylene backer rod or min 1 in. (25 mm) thickness of min 4 pcf (64 kg/m³) mineral wool batt insulation firmly packed into opening as a permanent form. Packing material to be recessed from top surface of floor or from both surfaces of wall as required to accommodate the required thickness of fill material. In floors constructed of hollow-core concrete, packing material to be recessed from top and bottom surfaces of floor as required to accommodate the required thickness of fill material.
 - B. **Fill, Void or Cavity Materials* – Caulk or Sealant** – Min 1 in. (25 mm) thickness of caulk applied within the annulus, flush with top surface of floor or with both surfaces of wall. In floors constructed of hollow-core concrete, min 1 in. (25 mm) thickness of caulk applied within the annulus, flush with top and bottom surfaces of floor. Min 1/4 in. (6 mm) diam bead of caulk applied to the penetrant/concrete or penetrant/sleeve interface at the point contact location on the top surface of floor or both surfaces of wall or hollow-core floor.
3M COMPANY – IC 15WB+ Caulk, CP 25WB+ Caulk or FB-3000 WT Sealant
(Note - W Rating applies only when FB-3000 WT is used.)

*Bearing the UL Classification Mark

Reprinted from the Online Certifications Directory with permission from Underwriters Laboratories Inc.
Copyright © 2010 Underwriters Laboratories Inc.®





UL System No. C-AJ-1552
XHEZ - Through-penetration Firestop Systems
XHEZ7 - Through-penetration Firestop Systems Certified for Canada

May 18, 2018

F Rating — 3 Hr

T Rating — 0 Hr

W Rating - Class I (See Item 4)

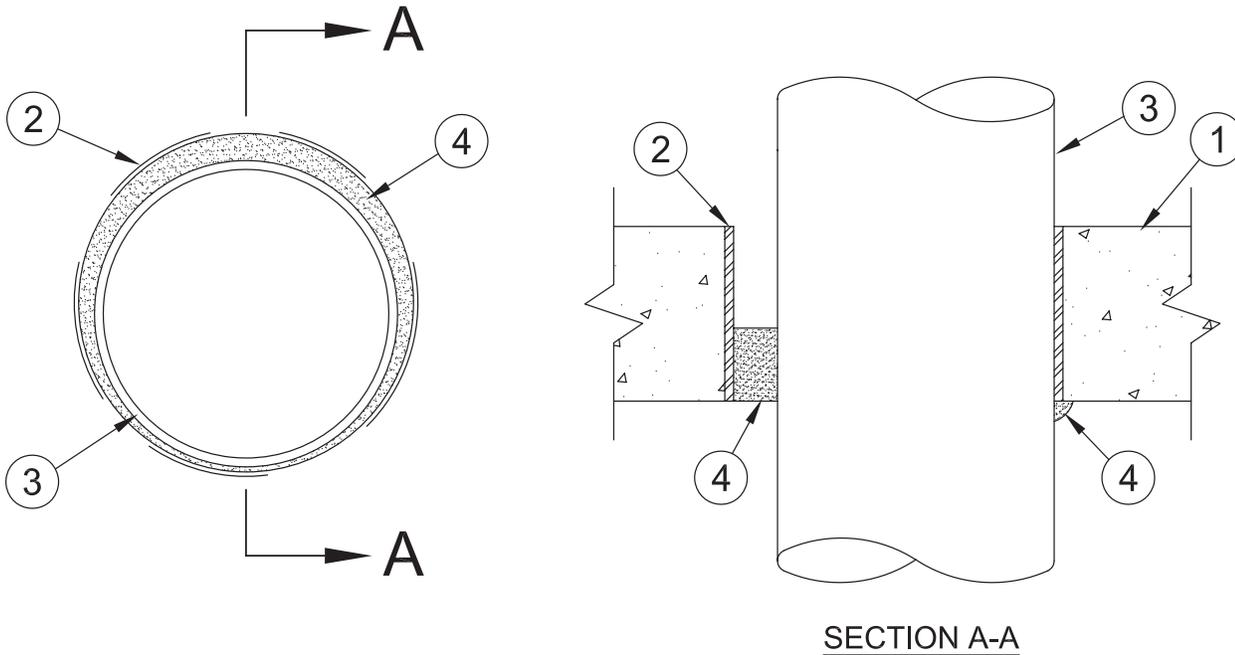

1. **Floor or Wall Assembly** – Min 2-1/2 in. (64 mm) thick reinforced lightweight or normal weight (100-150 pcf or 1600-2400 kg/m³) concrete. Floor assembly may also be constructed of any min 6 in. (152 mm) thick UL Classified hollow-core **Precast Concrete Units***. Wall may also be constructed of any UL Classified **Concrete Blocks***. Max diam of opening in solid concrete or concrete blocks. Max diam of opening in floor constructed of hollow-core precast concrete units is 7 in. (178 mm).

See **Concrete Blocks (CAZT)** and **Precast Concrete Units (CFTV)** categories in Fire Resistance Directory for names of manufacturers.

2. **Steel Sleeve** – (Optional) — Nom 26 in. (660 mm) diam (or smaller) Schedule 10 (or heavier) steel sleeve cast or grouted into slab, flush with bottom of floor. Sleeve may extend a max of 2 in. (51 mm) above top surface of floor or both surfaces of wall.
3. **Through-Penetrant** – One metallic pipe or tubing installed concentrically or eccentrically within opening. Annular space between penetrant and sleeve or periphery of opening shall be min of 0 in. (0 mm, point contact) to max 1-3/8 in. (35 mm). Penetrant to be rigidly supported on both sides of floor or wall assembly. The following types and sizes of penetrants may be used:
 - A. **Steel Pipe** – Nom 24 in. (610mm) diam (or smaller) Schedule 10 (or heavier) steel pipe.
 - B. **Iron Pipe** – Nom 24 in. (610 mm) diam (or smaller) cast or ductile iron pipe.
 - C. **Conduit** – Nom 6 in. diam (152 mm) (or smaller) steel conduit or nom 4 in. (102 mm) diam (or smaller) steel electrical metallic tubing.
 - D. **Copper Tubing** – Nom 6 in. (152 mm) diam (or smaller) Type L (or heavier) copper tubing.
 - E. **Copper Pipe** – Nom 6 in. (152 mm) diam (or smaller) Regular (or heavier) copper pipe.

4. **Fill, Void or Cavity Materials* — Caulk or Sealant** – Min 1-1/2 in. (38 mm) thickness of caulk applied within the annulus, flush with bottom or top surface of floor or with both surfaces of wall or flush with the bottom surface of hollow-core floors.

3M COMPANY – CP 25WB+, IC 15WB+ caulk or FB-3000 WT sealant

Note: W Rating applies only when FB-3000 WT is used.

*Indicates such products shall bear the UL or cUL Certification Mark for jurisdictions employing the UL or cUL Certification (such as Canada), respectively.



System No. C-AJ-1611

September 20, 2011

ANSI/UL1479 (ASTM E814)

F Rating – 2 Hr

T Rating – 0 Hr

CAN/ULC S115

F Rating – 2 Hr

FT Rating – 0 Hr

FH Rating – 2 Hr

FTH Rating – 0 Hr

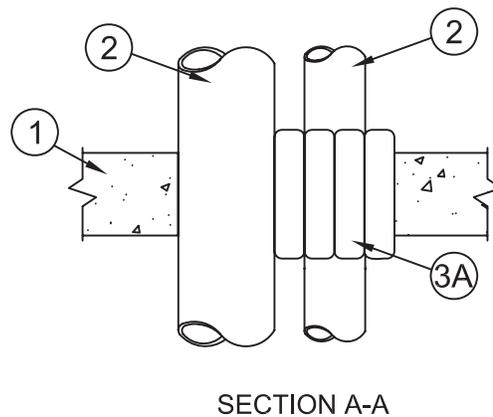
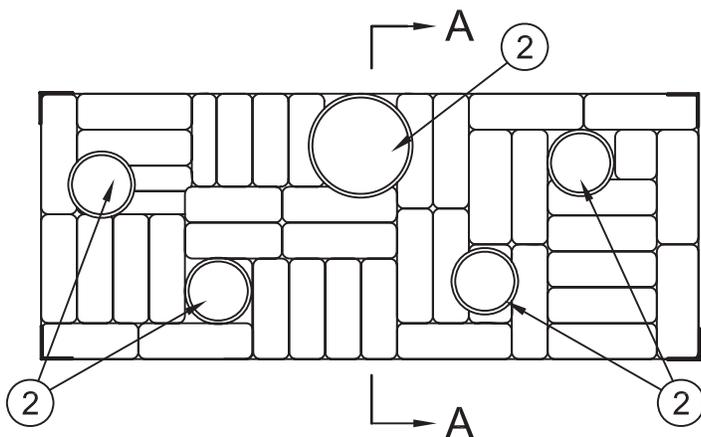

- Floor or Wall Assembly** – Min 4-1/2 in. (114 mm) thick reinforced lightweight or normal weight (100-150 pcf or 1600-2400 kg/m³) concrete. Wall may also be constructed of any UL Classified **Concrete Blocks***. Max area of opening is 504 sq in. (0.33 m²) with a max dimension of 36 in. (914 mm).
See **Concrete Blocks** (CAZT) category in Fire Resistance Directory for names of manufacturers.
- Through Penetrant** – One or more metallic pipes or conduits to be installed within the opening. The annular space between penetrants shall be min 5-1/2 in. (140 mm) to max 9-1/2 in. (241 mm). The annular space between the penetrant and the periphery of the opening shall be min 0 in. (point contact) to max 2-1/2 in. (64 mm). Penetrants to be rigidly supported on both sides of floor or wall assembly. The following types and sizes of metallic pipes or conduit may be used:
 - Conduit** – Nom 4 in. (102 mm) diam (or smaller) steel electrical metallic tubing (EMT) or steel conduit.
 - Copper Tube** – Nom 4 in. (102 mm) diam (or smaller) Type L (or heavier) copper tube
 - Steel Pipe** – Nom 6 in. (152 mm) diam (or smaller) Schedule 5 (or heavier) steel pipe
 - Iron Pipe** – Nom 4 in. (102 mm) diam (or smaller) cast or ductile iron pipe.
- Firestop System** – The details of the firestop system shall be as follows;
 - Fill Void or Cavity Materials*** – **Pillows** – 9 in. (229 mm) long by 6 in. (152 mm) wide by 2 or 3 in. (51 or 76 mm) thick plastic covered pillows tightly packed to fill annular space between penetrants and periphery of opening and installed with 9 in. (229 mm) dimension projecting through the floor or wall and centered within the opening.
3M COMPANY
3M FIRE PROTECTION PRODUCTS – Fire Barrier Pillow or Fire Barrier Self-Locking Pillows
 - Fill Void or Cavity Material*** – **Putty** – (Not shown) Putty installed to fill voids and at the point location on the top surface of floor or both sides of wall.
3M COMPANY
3M FIRE PROTECTION PRODUCTS – Type MP+ Putty

*Bearing the UL Classification Mark

Reprinted from the Online Certifications Directory with permission from Underwriters Laboratories Inc.
Copyright © 2011 Underwriters Laboratories Inc.®



Through Penetrations

Metallic Pipes

1000 Series

Concrete

CAJ

System No. C-AJ-1626

December 14, 2012

ANSI/UL1479 (ASTM E814)

F Rating – 2 Hr

T Rating – 1/4 Hr

CAN/ULC S115

F Rating – 2 Hr

FT Rating – 1/4 Hr

FH Rating – 2 Hr

FTH Rating – 1/4 Hr

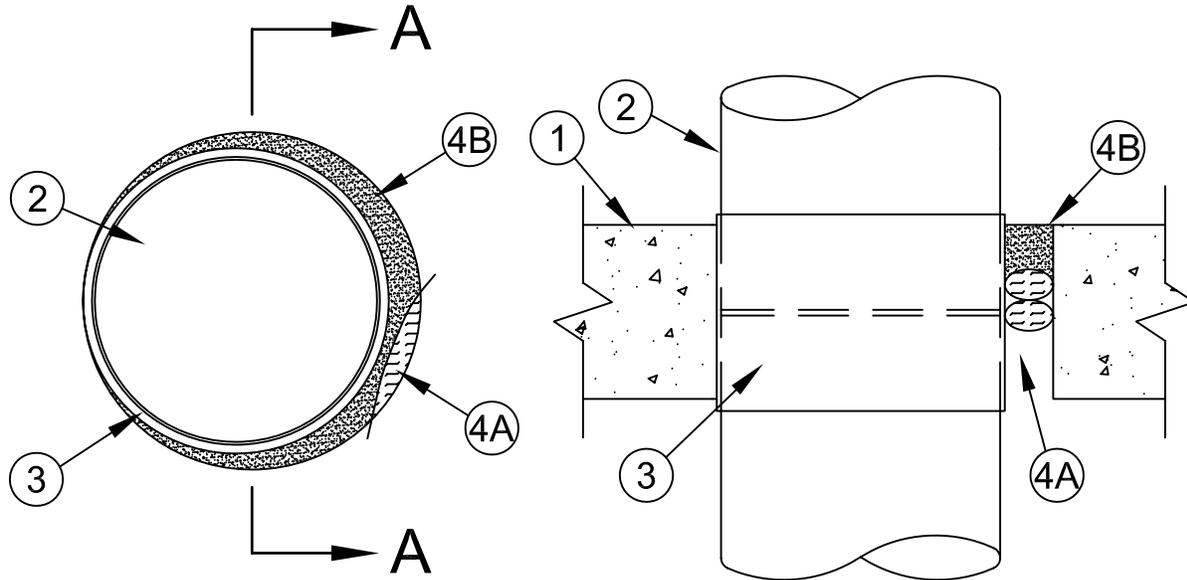

SECTION A-A

- Floor or Wall Assembly** – Min 2-1/2 in. (64 mm) thick reinforced lightweight or normal weight (100-150 pcf or 1600-2400 kg/m³) concrete. Max diam of opening 10 in. (254 mm).
- Through-Penetrant** – One metallic pipe installed concentrically or eccentrically within opening. Annular space between penetrant and periphery of opening shall be min 0 in. (point contact) to max 1-1/8 in. (29 mm). Penetrant to be rigidly supported on both sides of floor or wall assembly. The following types and sizes of penetrants may be used:
 - Steel Pipe** – Nom 8 in. (203 mm) diam (or smaller) Schedule 40 (or heavier) steel pipe.
 - Iron Pipe** – Nom 8 in. (203 mm) diam (or smaller) cast or ductile iron pipe.
- Compression Coupling** – Nom 8 in. (203 mm) diam (or smaller) compression type high pressure pipe coupling with elastomeric plastic and a stainless steel shield. Coupling to be installed through the opening and extending max 1 in. (25 mm) above top surface of floor or beyond either surface of wall. Coupling secured to pipe with stainless steel hose clamps. Annular space between coupling and periphery of opening shall be min 0 in. (point contact) to max 1-1/8 in. (29 mm).
- Firestop System** – The firestop system shall consist of the following:
 - Forming Material** – Polyethylene backer rod used as a permanent form. Backer rod to be friction-fitted into annular space and recessed min 1 in. (25 mm) from top surface of floor or both surfaces of wall.
 - Fill, Void or Cavity Material* – Sealant** – Min 1 in. (25 mm) thickness of fill material applied within annulus, flush with top surface of floor or both surfaces of wall.

3M COMPANY

3M FIRE PROTECTION PRODUCTS – IC 15WB+, CP 25WB+, and FB 3000WT

*Bearing the UL Classification Mark

Reprinted from the Online Certifications Directory with permission from UL

© 2013 UL LLC



Through Penetrations

Metallic Pipes

1000 Series

Concrete

CAJ

System No. C-AJ-1628

August 01, 2013

ANSI/UL1479 (ASTM E814)

F Ratings – 2 Hr

T Rating – 1/4 Hr

L Rating at Ambient - Less than 1 CFM/sq ft

L Rating at 400 F - Less than 1 CFM/sq ft

CAN/ULC S115

F Ratings – 2 Hr

FT Rating – 1/4 Hr

FH Ratings – 2 Hr

FTH Rating – 1/4 Hr

L Rating at Ambient - Less than 1 CFM/sq ft

L Rating at 400 F - Less than 1 CFM/sq ft

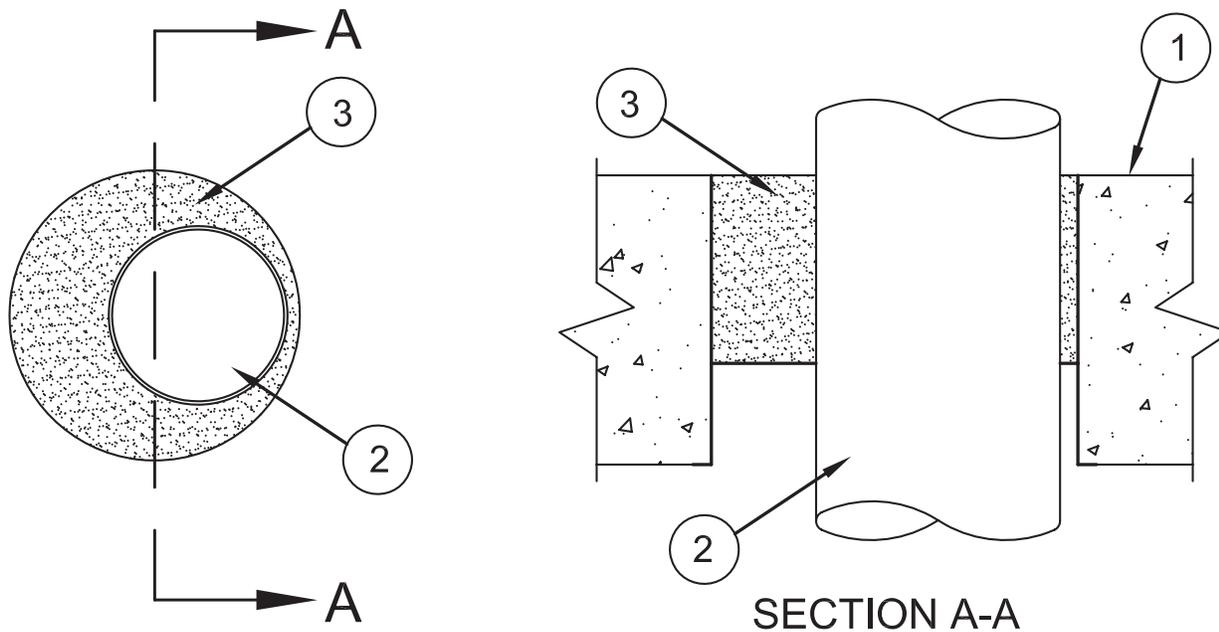

- Floor or Wall Assembly** – Min 2-1/2 in. (64 mm) thick lightweight or normal weight (100-150 pcf or 1600-2400 kg/m³) concrete. Max diam of opening is 12-1/2 in. (318 mm).
- Through-Penetrant** – One metallic pipe, conduit or tubing installed either concentrically or eccentrically within the firestop system. The annular space between pipe, conduit or tubing and periphery of opening shall be min of 1/2 in. (13 mm) to max 3-3/8 in. (86 mm). Pipe, conduit or tubing to be rigidly supported on both sides of floor. The following types and sizes of metallic pipes, conduits or tubing may be used:
 - Steel Pipe** – Nom 8 in. (203 mm) diam (or smaller) Schedule 10 (or heavier) steel pipe.
 - Iron Pipe** – Nom 8 in. (203 mm) diam (or smaller) service weight (or heavier) cast iron soil pipe, nom 12 in. diam (or smaller) or Class 50 (or heavier) ductile iron pressure pipe.
 - Conduit** – Nom 6 in. (152 mm) diam (or smaller) steel conduit or nom 4 in. (102 mm) diam (or smaller) steel electrical metallic tubing.
 - Copper Tubing** – Nom 4 in. (102 mm) diam (or smaller) Type L (or heavier) copper tubing.
 - Copper Pipe** – Nom 4 in. (102 mm) diam (or smaller) Regular (or heavier) copper pipe.
- Fill, Void or Cavity Material*** – **Foam** – Min 1-1/2 in. (38 mm) thickness of fill material applied within the annulus, flush with top surface of floor or both surfaces of wall.

3M COMPANY – Fire Barrier Rated Foam, FIP 1-Step

*Bearing the UL Classification Mark

Reprinted from the Online Certifications Directory with permission from UL

© 2013 UL LLC



System No. C-AJ-1629

August 05, 2013

ANSI/UL1479 (ASTM E814)

F Ratings – 2 Hr

T Rating – 1/4 Hr

L Rating at Ambient – Less than 1 CFM/sq ft

L Rating at 400 F – Less than 1 CFM/sq ft

CAN/ULC S115

F Ratings – 2 Hr

FT Rating – 1/4 Hr

FH Ratings – 2 Hr

FTH Rating – 1/4 Hr

L Rating at Ambient – Less than 1 CFM/sq ft

L Rating at 400 F – Less than 1 CFM/sq ft

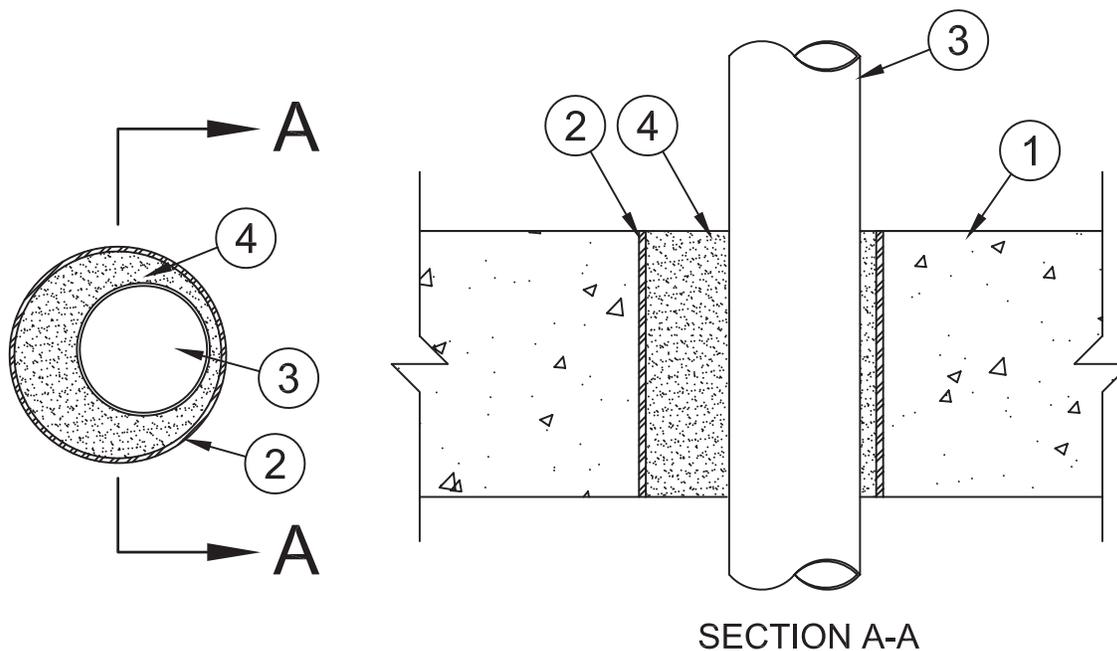

- Floor or Wall Assembly** – Min 2-1/2 in. (64 mm) thick lightweight or normal weight (100-150 pcf or 1600-2400 kg/m³) concrete. Max diam of opening is 12-1/2 in. (318 mm).
- Steel Sleeve** – Optional, nom 12-1/2 in. (318 mm) diam (or smaller) cylindrical sleeve fabricated from min 0.034 in. (0.86 mm) thick (22 gauge or heavier) galv sheet steel and having a min 2 in. (51 mm) lap along the longitudinal seam, cast or grouted into opening. Length of steel sleeve to be equal to thickness of floor or wall, installed flush with both surfaces of floor or wall assembly. As an option, the sleeve may extend up to 2 in. above the top surface of floor.
- Through-Penetrant** – One metallic pipe, conduit or tubing installed either concentrically or eccentrically within the firestop system. The annular space between pipe, conduit or tubing and periphery of opening shall be min of 1/2 in. (13 mm) to max 3-3/8 in. (86 mm). Pipe, conduit or tubing to be rigidly supported on both sides of floor. The following types and sizes of metallic pipes, conduits or tubing may be used:
 - Steel Pipe** – Nom 8 in. (203 mm) diam (or smaller) Schedule 10 (or heavier) steel pipe.
 - Iron Pipe** – Nom 8 in. (203 mm) diam (or smaller) service weight (or heavier) cast iron soil pipe, nom 12 in. diam (or smaller) or Class 50 (or heavier) ductile iron pressure pipe.
 - Conduit** – Nom 6 in. (152 mm) diam (or smaller) steel conduit or nom 4 in. (102 mm) diam (or smaller) steel electrical metallic tubing.
 - Copper Tubing** – Nom 4 in. (102 mm) diam (or smaller) Type L (or heavier) copper tubing.
 - Copper Pipe** – Nom 4 in. (102 mm) diam (or smaller) Regular (or heavier) copper pipe.
- Fill, Void or Cavity Material*** – **Foam** – Min 2-1/2 in. (64 mm) thickness of fill material applied within the annulus flush with top surface of floor or both surfaces of wall.

3M COMPANY – Fire Barrier Rated Foam, FIP 1-Step

*Bearing the UL Classification Mark

Reprinted from the Online Certifications Directory with permission from UL

© 2014 UL LLC





UL System No. C-AJ-1631
XHEZ – Through-penetration Firestop Systems
XHEZ7 – Through-penetration Firestop Systems Certified for Canada

October 04, 2017

| ANSI/UL1479 (ASTM E814) | CAN/ULC S115 |
|-------------------------|-------------------|
| F Rating – 3 Hr | F Rating – 3 Hr |
| T Rating – 0 Hr | FT Rating – 0 Hr |
| | FH Rating – 3 Hr |
| | FTH Rating – 0 Hr |

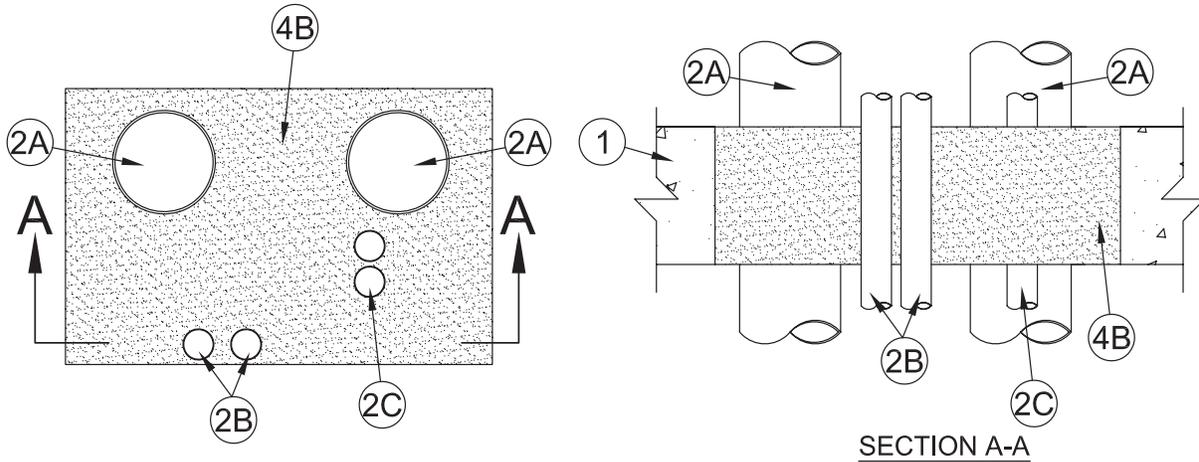

- Floor or Wall Assembly** – Min 2-1/2 in. (63 mm) thick reinforced lightweight or normal weight (100-150 pcf or 1600-2400 kg/m³) concrete. Wall may also be constructed of any UL Classified **Concrete Blocks***. Max area of opening is 1656 sq in. (1.07 m²) with max dimension of 46 in. (1168 mm).
See **Concrete Blocks** (CAZT) in the Fire Resistance Directory for names of manufacturers.
- Through-Penetrant** – A max of seven penetrants to be installed in opening. Min clearance between pipes, conduits or tubing is 0 in. (point contact). Min clearance between pipe, conduit, or tubing and periphery of through opening is 0 in. (point contact). Pipe conduit or tubing to be rigidly supported on both sides of floor or wall assembly. The following types and sizes of pipes, conduits, or tubing may be used:
 - Steel Pipe** – Nom 12 in. (305 mm) diam, or smaller, schedule 10, or heavier, steel pipe.
 - Copper Tubing** – Nom 4 in. (102 mm) diam, or smaller, Type L, or heavier, copper tubing.
 - Conduit** – Nom 4 in. (102 mm) diam, or smaller steel electrical metallic tubing or steel conduit.
- Forms** – (Not Shown) - Used as a form to prevent leakage of fill material during installation. Forms to be a rigid sheet material, cut to fit the contour of the penetrating item and positioned as required to accommodate the required thickness of fill material. Forms to be removed after fill material has cured.
- Firestop System** – The firestop system shall consist of the following:
 - Packing Material** – (Optional, Not Shown) - For floors greater than 2-1/2 in. (63 mm) thick, mineral wool batt insulation firmly packed into opening as a permanent or temporary form and recessed from the top surface of floor, or both surfaces of wall, to accommodate the required thickness of the fill material, Item 5B.
 - Fill, Void, or Cavity Material* – Mortar** – Min 2-1/2 in. (63 mm) thickness of fill material applied within the annulus. Mortar to be mixed with water in accordance with manufacturer's instructions.

3M COMPANY 3M FIRE PROTECTION PRODUCTS – 3M Fire Barrier Mortar

*Indicates such products shall bear the UL or cUL Certification Mark for jurisdictions employing the UL or cUL Certification (such as Canada), respectively.

Reprinted from the Online Certifications Directory with permission from UL©



System No. C-AJ-1668

May 20, 2016

| ANSI/UL1479 (ASTM E814) | CAN/ULC S115 |
|---|---|
| F Rating — 2 Hr | F Rating — 2 Hr |
| T Ratings — 1/4 and 1/2 Hr (See Item 2) | FT Ratings — 1/4 and 1/2 Hr (See Item 2) |
| L Rating At Ambient — Less Than 1 CFM/sq ft | FH Rating — 2 Hr |
| L Rating At 400 F — Less Than 1 CFM/sq ft | FTH Ratings — 1/4 and 1/2 Hr (See Item 2) |
| | L Rating At Ambient — Less Than 1 CFM/sq ft |
| | L Rating At 400 F — Less Than 1 CFM/sq ft |

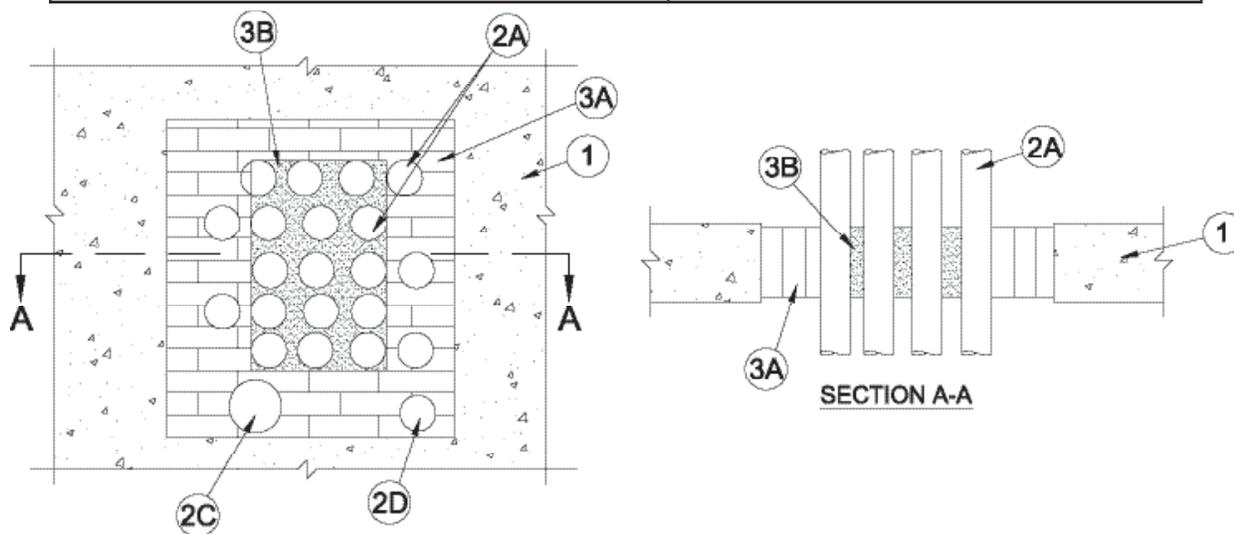

- 1. Floor or Wall Assembly** — Min 4-1/2 in. (114 mm) thick reinforced light weight or normal weight (100-150 pcf or 1600-2400 kg/m³) concrete. Wall may also be constructed of any UL Classified **Concrete Blocks***. Max size of opening is 1296 in.² (0.836 m²) with a max dimension of 36 in. (914 mm).

See **Concrete Blocks** (CAZT) category in the Fire Resistance Directory for names of manufacturers.

- 2. Through Penetrants** — One or more pipes, conduit or tubing to be installed within the opening. The space between the pipes, conduit or tubing shall be min 1/2 in. (13 mm) to max 9-1/2 in. (241 mm), except that for copper penetrants, the min annular space shall be 3 in. (76 mm). The space between pipes, conduit or tubing and periphery of opening shall be min 3/4 in. (19 mm) to max 14 in. (356 mm), except that for copper penetrants, the min annular space shall be 2 in. (51 mm). Pipe, conduit or tubing to be rigidly supported on both sides of floor or wall. The following types and sizes of metallic pipes, conduits or tubing may be used:
 - A. Conduit** — Nom 4 in. (102 mm) diam (or smaller) electrical metallic tubing or steel conduit. A maximum of twenty conduit may be installed within the opening.
 - B. Copper Tubing or Pipe** — Nom 4 in. (102 mm) diam (or smaller) Type L (or heavier) copper tubing or Regular (or heavier) copper pipe. A maximum of one copper penetrant may be installed within the opening.
 - C. Steel Pipe** — Nom 8 in. (203 mm) diam (or smaller) Schedule 5 (or heavier) steel pipe. A maximum of one penetrant exceeding 4 in. (102 mm) diam may be installed within the opening.
 - D. Iron Pipe** — Nom 4 in. (102 mm) diam (or smaller) cast or ductile iron pipe.

The hourly T, FT and FTH Rating is 1/2 hr except that when copper pipe/tube (Items 2B) is used, the hourly T, FT and FTH Rating is 1/4 hr.

- 3. Firestop System** — The firestop system shall consist of the following:

- A. Fill, Void or Cavity Material*** — Blocks to be firmly packed to fill the opening area between the grouping of conduit (Item 2A) and periphery of opening, and between and around all other individual penetrants to the periphery of the opening. Blocks installed with 5 in. (127 mm) dimension projecting through opening, flush with bottom surface of floor or centered in wall. For floors and walls thicker than 5 in. (127 mm), the fire block can be installed flush with either side of floor or wall. In concrete block walls, fire block to fill entire thickness of wall opening unless concrete block is solid filled. Blocks can be cut to fit around penetrants and within smaller annular spaces.

3M COMPANY 3M FIRE PROTECTION PRODUCTS — 3M™ Fire Barrier Block B258, 3M™ Fire Barrier Plank PK39

- B. Fill, Void or Cavity Materials*** — **Foam** — Fill material installed to fill the entire annular space within and around the grouping of conduit penetrating items to a min thickness of 5 in. (127 mm). Fill material to be forced between blocks and periphery of opening to the max extent possible. Fill material to be injected in-between blocks and penetrants to the full depth of the blocks, as well as in any visible voids/openings between blocks (Item 3A).

3M COMPANY 3M FIRE PROTECTION PRODUCTS — Fire Barrier Rated Foam, FIP I-Step

* Indicates such products shall bear the UL or cUL Certification Mark for jurisdictions employing the UL or cUL Certification (such as Canada), respectively.



System No. C-AJ-1672

November 15, 2016

| ANSI/UL1479 (ASTM E814) | CAN/ULC S115 |
|-------------------------|-------------------|
| F Rating — 2 Hr | F Rating — 2 Hr |
| T Rating — 0 Hr | FT Rating — 0 Hr |
| | FH Rating — 2 Hr |
| | FTH Rating — 0 Hr |

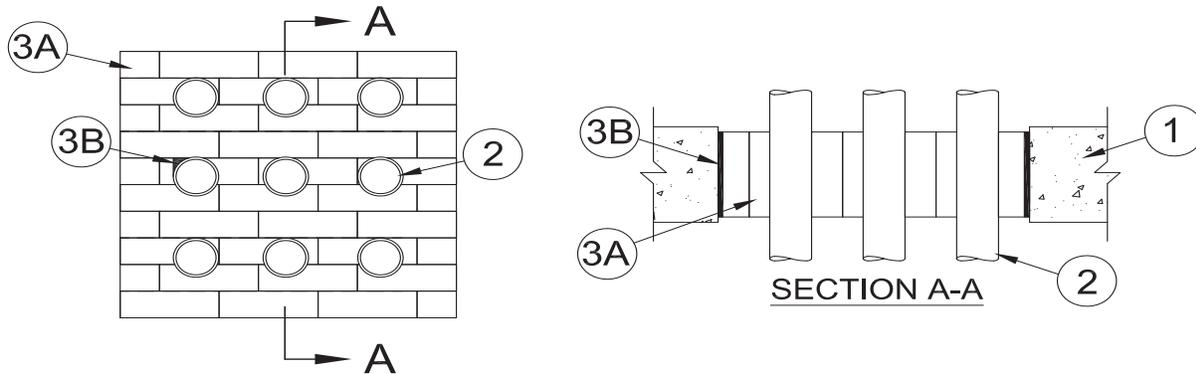

1. **Floor or Wall Assembly** — Min 4-1/2 in. (114 mm) thick reinforced light weight or normal weight (100-150 pcf or 1600-2400 kg/m³) concrete. Wall may also be constructed of any UL Classified **Concrete Blocks***. Max size of opening is 900 in.2 (5806 cm²) with a max dimension of 30 in. (762 mm).
See **Concrete Blocks (CAZT)** in the Fire Resistance Directory for names of manufacturers.
2. **Through Penetrants** — A maximum of nine pipes, conduit or tubing to be installed within the opening. The space between the pipes, conduit or tubing shall be min 3-1/2 in. (13 mm) to max 9-1/2 in. (241 mm). The space between pipes, conduit or tubing and periphery of opening shall be min 2 in. (51 mm) to max 14 in. (356 mm). Pipe, conduit or tubing to be rigidly supported on both sides of floor or wall. The following types and sizes of metallic pipes, conduits or tubing may be used:
 - A. **Conduit** — Nom 4 in. (102 mm) diam (or smaller) electrical metallic tubing or steel conduit.
 - B. **Copper Tubing or Pipe** — Nom 4 in. (102 mm) diam (or smaller) Type L (or heavier) copper tubing or Regular (or heavier) copper pipe. A maximum of one copper penetrant may be installed within the opening.
 - C. **Steel Pipe** — Nom 8 in. (203 mm) diam (or smaller) Schedule 5 (or heavier) steel pipe. A maximum of one penetrant exceeding 4 in. (102 mm) diam may be installed within the opening.
 - D. **Iron Pipe** — Nom 4 in. (102 mm) diam (or smaller) cast or ductile iron pipe.
3. **Firestop System** — The firestop system shall consist of the following:
 - A. **Fill, Void or Cavity Material*** — Blocks to be firmly packed to completely fill the opening area between and around the penetrants and to the periphery of opening. Blocks installed with 5 in. (127 mm) dimension projecting through opening, flush with bottom surface of floor or centered in wall. For floors and walls thicker than 5 in. (127 mm), the fire block can be installed flush with either side of floor or wall. In concrete block walls, fire block to fill entire thickness of wall opening unless concrete block is solid filled. Blocks can be cut to fit around penetrants and within smaller annular spaces.
3M COMPANY 3M FIRE PROTECTION PRODUCTS — 3M™ Fire Barrier Block B258, 3M™ Fire Barrier Plank PK39
 - B. **Fill, Void or Cavity Material*** — **Sealant or Caulk** — Sealant to be forced between blocks and periphery of opening to the max extent possible. Sealant to be forced in-between blocks and all penetrants to the full depth of the blocks, as well as in any visible voids/openings between blocks.
3M COMPANY 3M FIRE PROTECTION PRODUCTS — CP25WB+ Caulk or FB-3000 WT Sealant

* Indicates such products shall bear the UL or cUL Certification Mark for jurisdictions employing the UL or cUL Certification (such as Canada), respectively.



Through Penetrations

Metallic Pipes

1000 Series

Concrete

CAJ

System No. C-BJ-1020

May 18, 2005

F Rating – 4 Hr

T Ratings – 0, 3/4 and 1-1/2 Hr (See Item 2)

L Rating At Ambient – 2 CFM/sq ft

L Rating At 400 F – Less Than 1 CFM/sq ft

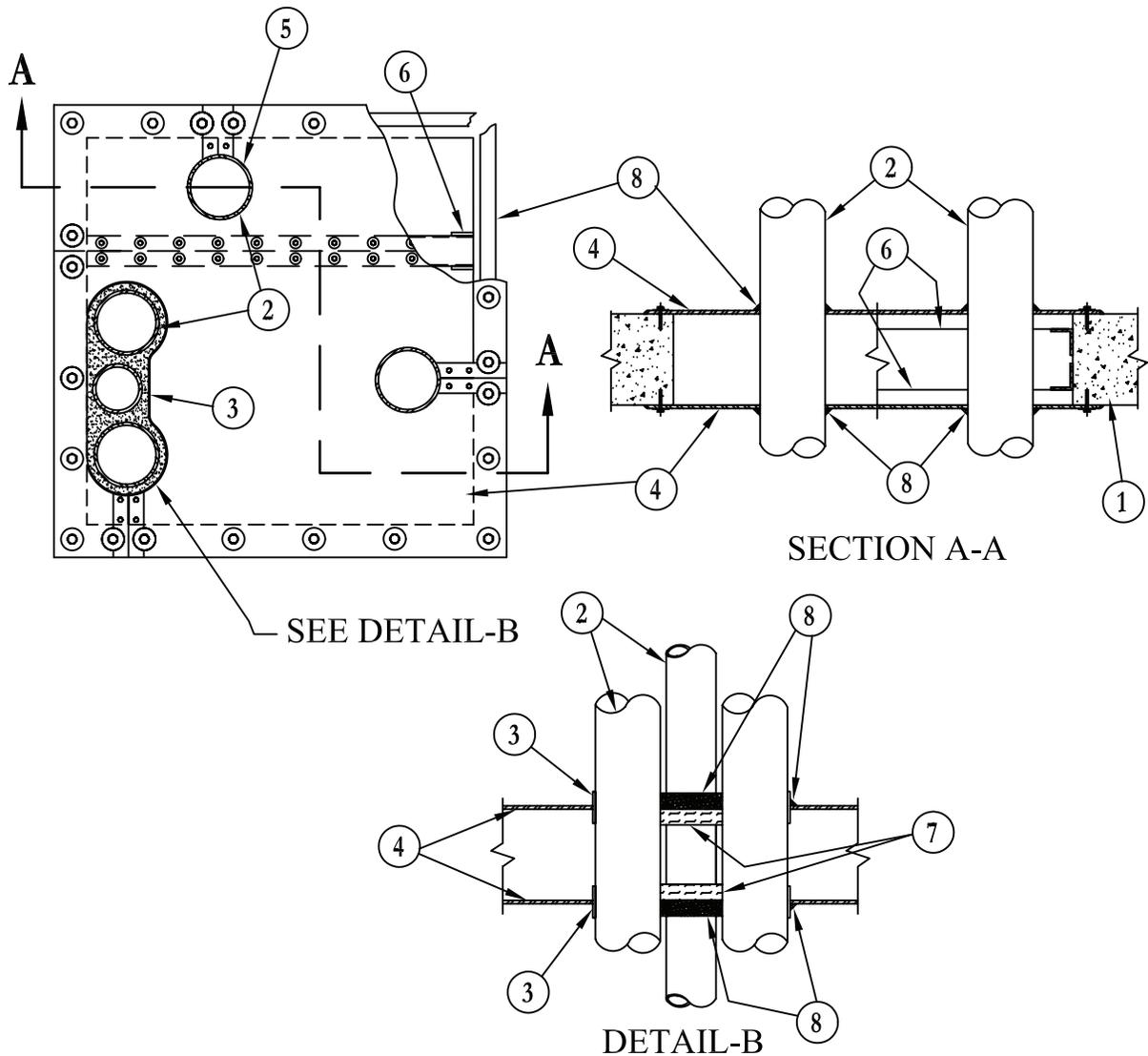

SEE DETAIL-B

SECTION A-A

DETAIL-B

- Floor or Wall Assembly** – Min 5-1/2 in. (140 mm) thick lightweight or normal weight (100-150 pcf or 1600-2400 kg/m³) concrete. Wall may also be constructed of any UL Classified **Concrete Blocks***. Max area of opening 1500 sq in. (9677 sq cm²) with max dimension of 50 in. (127 cm)
See **Concrete Blocks (CAZT)** category in the Fire Resistance Directory for names of manufacturers.
- Pipe or Conduit** – Nom 12 in. (305 mm) diam (or smaller) Schedule 10 (or heavier) steel pipe, nom 6 in. (152 mm) diam (or smaller) steel conduit, nom 4 in. (102 mm) diam (or smaller) steel EMT or nom 3 in. (76 mm) diam (or smaller) Type L (or heavier) copper tubing. Pipe, conduit or EMT rigidly supported on both sides of floor or wall assembly. **When max 4 in. (102 mm) diam steel pipe, conduit or EMT is used, T Rating is 3/4 hr. When max 2 in. (51 mm) diam steel pipe, conduit or EMT is used, T Rating is 1-1/2 hr. When copper tubing is used or when steel pipe or conduit larger than 4 in. (102 mm) is used, T Rating is 0 hr.**
- Fill, Void or Cavity Material* – Wrap Strip** – Nom 1/4 in. (6 mm) thick intumescent elastomeric material faced on one side with aluminum foil, supplied in nom 2 in. (51 mm) wide by 24 in. (610 mm) long strips. Single layer of wrap strip tightly-wrapped around each copper pipe and each steel pipe or conduit larger than nom 4 in. (102 mm) diam. Wrap strip layer installed with foil side exposed and secured in place with steel wire ties. When tight grouping of steel pipes, conduits or EMT does not readily permit tight installation of the intumescent sheet (Item 4) around the individual pipes, conduits or EMT, the grouping of steel pipes, conduits or EMT shall be wrapped with a single piece of wrap strip with the wrap strip drawn in between the individual pipes using steel wires so as to follow the contours of the pipe grouping as tightly as possible. Wrap strip to extend approx 7/8 in. (22 mm) beyond each face of the intumescent sheet (Item 4) on both sides of the floor or wall assembly. Wrap strip layer not required on individual nom 4 in. (102 mm) diam (or smaller) steel pipe, conduit or EMT.

3M COMPANY – FS-195+

System No. C-BJ-1020 *continued*

4. **Fill, Void or Cavity Materials* – Intumescent Sheet** – Rigid aluminum foil-faced sheet with galv steel sheet backer. Sheet cut to tightly-follow the contours of the individual pipes, conduits and EMT and the contours of the wrap strip (Item 3) on the pipes and grouped pipes, conduits and EMT. Sheets to lap a min of 2 in. (51 mm) on the floor or wall surface on all sides of the opening on both sides of the floor or wall assembly. Sheet to be installed with galv steel sheet backer exposed (aluminum foil facing against floor or wall surface) and secured to floor or wall surface with min 3/16 in. (5 mm) diam by 1-1/4 in. (32 mm) long steel masonry fasteners with min 1-1/4 in. (32 mm) diam steel washers. Max spacing of fasteners not to exceed 6 in. (152 mm) with additional fasteners located on each side of butted seams or slits made to permit installation of the sheet around the individual penetrating items.

3M COMPANY – CS-195+

5. **Steel Cover Strip** – Min 2 in. (51 mm) wide strip of min 0.020 in. (0.51 mm) thick galv steel centered over butted seams of adjoining intumescent sheets and over entire length of each slit made in intumescent sheet (Item 4) to permit installation about the penetrating item(s). Prior to installation of the steel strip, the seam or slit in the intumescent sheet shall be covered with a nom 1/4 in. (6 mm) diam bead of caulk (Item 8). Steel cover strip secured to galv steel sheet backer of intumescent sheet with steel sheet metal screws or steel rivets spaced max 3 in. (76 mm) OC on each side of seam or slit.
6. **Support Channel** – When area of through opening exceeds 750 sq in. (4839 sq cm²), an intermediate support channel shall be installed on each side of floor or wall assembly, flush with floor or wall surface. Support channels to be min 1-5/8 in. by 1-5/8 in. (41 mm by 41 mm) and formed of min 0.093 in. (2.4 mm) thick (No. 12 ga) painted or galv steel. Ends of steel channel bolted or welded to steel angles anchored to inside walls of through opening. When steel support channels are centered beneath butted seams of intumescent sheets, no steel cover strip (Item 5), is required over butted seam. Intumescent sheets secured to steel support channels with steel sheet metal screws in conjunction with min 1-1/4 in. (32 mm) diam steel fender washers. When support channel is used beneath butted seam of intumescent sheets, fasteners spaced max 3 in. (76 mm) OC on each side of butted seam. When support channel is located away from intumescent sheet seam, fasteners spaced max 6 in. (152 mm) OC. Prior to installation of the intumescent sheet(s), a nom 1/4 in. (6 mm) diam continuous bead of caulk (Item 8) shall be applied as a gasket over the steel support channel.
7. **Packing Material** – When tightly-grouped steel pipes, conduits or EMT are encircled with a contoured wrap of wrap strip (Item 3), the interstices between the pipes within the wrap strip shall be firmly packed with a nom 1 in. (25 mm) thickness of ceramic (alumina silica) fiber blanket or mineral wool batt insulation. Packing material to be recessed 1 in. (25 mm) from edge of wrap strip on each side of floor or wall assembly.
8. **Fill, Void or Cavity Material* – Caulk or Sealant** – Generous application of caulk to be applied around the base of the individual cables, pipes, conduits, EMT and contour applied wrap strips at their egress from the intumescent sheet on both sides of the floor or wall assembly. An additional bead of caulk shall be applied to the exposed edges of the wrap strip at its interface with the grouped pipes, insulated steel pipe and cable bundle on both sides of floor or wall assembly. An additional 1/4 in. (6 mm) diam bead of caulk shall be applied to edge of intumescent sheet at its interface with surface of floor or wall around entire perimeter. When tightly-grouped steel pipes, conduits, or EMT are encircled with a contoured wrap of wrap strip (Item 3), a min 1 in. (25 mm) thickness of caulk shall be applied over the packing material (Item 7) to completely fill the cavity within the wrap strip on each side of the floor or wall assembly.

3M COMPANY – IC 15WB+, CP 25WB+ caulk or FB-3000 WT sealant.

*Bearing the UL Classification Mark

Reprinted from the Online Certifications Directory with permission from Underwriters Laboratories Inc.
Copyright © 2010 Underwriters Laboratories Inc.®



System No. F-A-1002

August 23, 2004

(Formerly System No. 152)

F Rating – 2 Hr

T Rating – 0 Hr

L Rating At Ambient – 2 CFM/sq ft

L Rating At 400 F – Less Than 1 CFM/sq ft

W Rating – Class I (See Item 4)

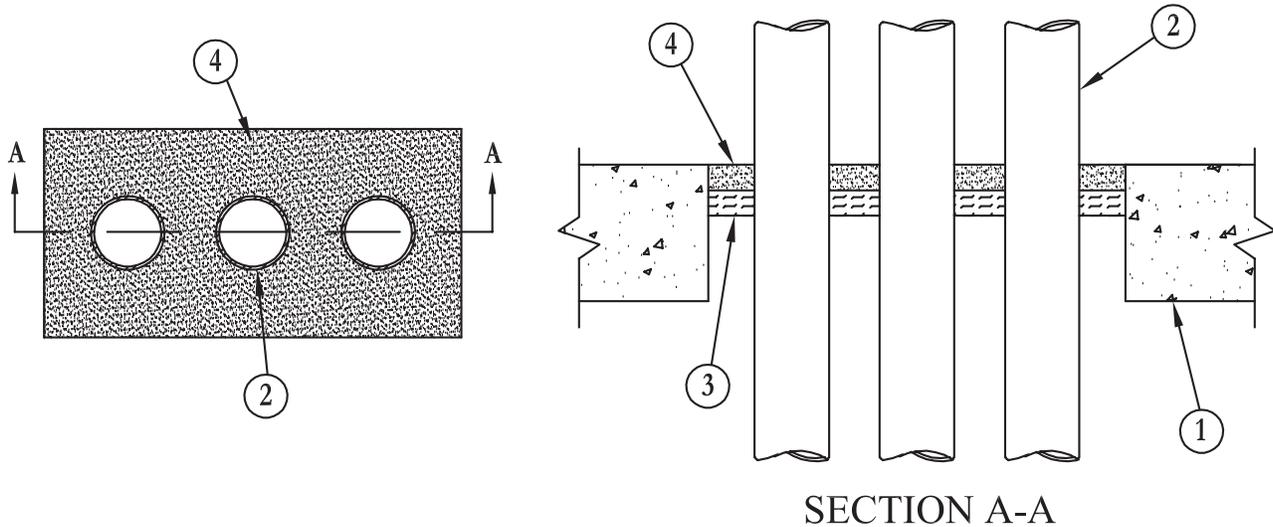

SECTION A-A

- Floor Assembly** – Min 4-1/2 in. thick lightweight or normal weight (100-150 pcf) concrete. Max area of opening 192 sq in. with max length of 24 in. and max width of 8 in.
- Pipe** – Nom 4 in. diam (or smaller) Type L (or heavier) copper tubing Schedule 10 (or heavier) steel pipe, steel conduit or steel EMT to be installed with a min clearance of 1 in. and a max clearance of 2 in. from the sides of the through opening. A min separation of 1 in. shall be maintained between adjacent pipes. Pipes to be rigidly supported on both sides of floor assembly.
- Packing Material** – Min 1 in. thick mineral wool batt material insulation firmly packed into opening as a permanent form with its top surface recessed min 1 in. from top surface of floor.
- Fill, Void or Cavity Materials* – Caulk or Sealant** – Applied to fill through opening to a min depth of 1 in., flush with top surface of floor.
3M COMPANY – CP 25WB+ caulk or FB-3000 WT sealant. (Note: W Rating applies only when FB-3000 WT is used.)

*Bearing the UL Classification Marking

Reprinted from the Online Certifications Directory with permission from Underwriters Laboratories Inc.
 Copyright © 2010 Underwriters Laboratories Inc.®



System No. F-A-1011

September 07, 2004

F Rating – 2 Hr

T Rating – 2 Hr

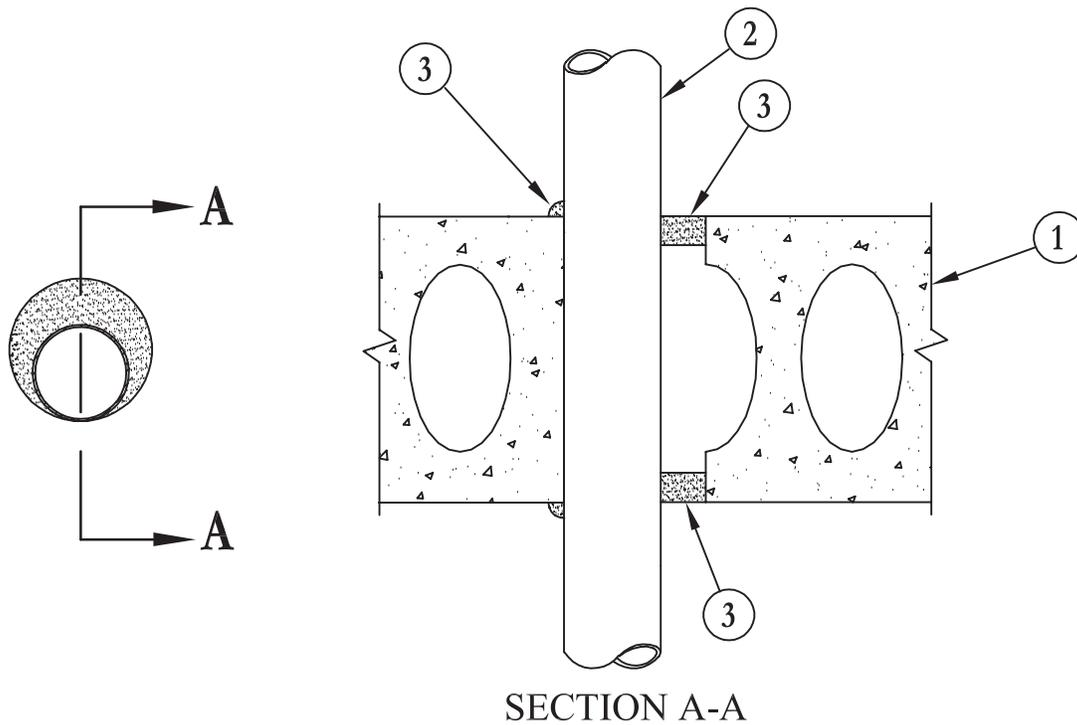

SECTION A-A

- 1. Floor or Wall Assembly** – Min 6 in. thick UL Classified hollow-core **Precast Concrete Units***. Floor may also be constructed of any min 6 in. thick reinforced lightweight or normal weight (100-150 pcf) concrete. Max diam of opening is 2 in.
See **Precast Concrete Units** (CFTV) category in the Fire Resistance Directory for names of manufacturers.
- 2. Through Penetrants** – One metallic pipe, conduit or tubing to be installed either concentrically or eccentrically within the firestop system. Pipe, conduit or tubing to be rigidly supported on both sides of floor assembly. The annular space between pipe, conduit or tubing and periphery of opening shall be min of 0 in. (point contact) to max 7/8 in. The following types and sizes of metallic pipes, conduits or tubings may be used:
 - A. Steel Pipe** – Nom 1 in. diam (or smaller) Schedule 5 (or heavier) steel pipe.
 - B. Conduit** – Nom 1 in. diam (or smaller) steel electrical metallic tubing or steel conduit.
 - C. Copper Tubing** – Nom 1 in. diam (or smaller) Type L (or heavier) copper tube.
 - D. Copper Pipe** – Nom 1 in. diam (or smaller) Regular (or heavier) copper pipe.
- 3. Fill, Void or Cavity Materials* – Caulk or Sealant** – Min 1/2 in. thickness of fill material applied within annulus, flush with each surface of floor. Min 1/2 in. diam bead of caulk applied to the penetrant/concrete interface at the point contact location on both sides of floor.
3M COMPANY – CP 25WB+ caulk or FB-3000 WT sealant.

*Bearing the UL Classification Marking

Reprinted from the Online Certifications Directory with permission from Underwriters Laboratories Inc.
Copyright © 2010 Underwriters Laboratories Inc.®



System No. F-A-1019

September 10, 2004

F Rating – 4 Hr

T Rating – 0 Hr

W Rating – Class I (See Item 3)

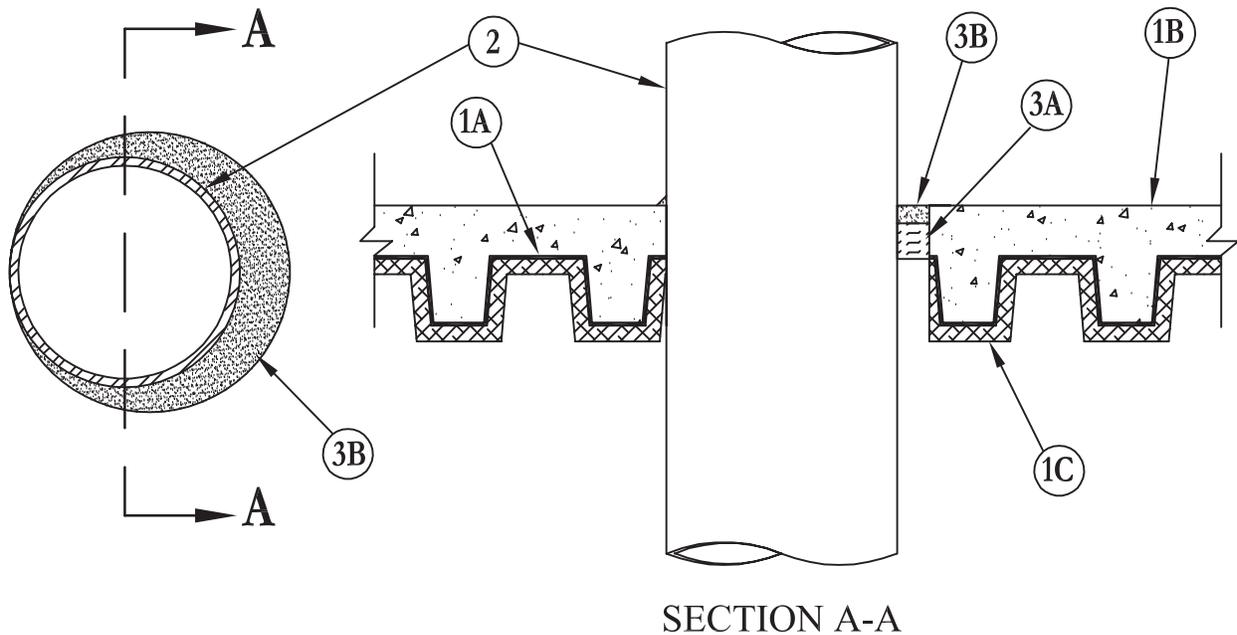

SECTION A-A

1. **Floor Assembly** – The 4 Hr fire-rated concrete and steel floor assembly shall be constructed of the materials and in the manner specified in the individual D700 series design in the UL Fire Resistance Directory and as summarized below:
 - A. **Steel Floor and Form Units*** – Composite or non-composite 3 in. deep fluted galv units as specified in the individual floor-ceiling design. Max size of opening is 25-1/4 in.
 - B. **Concrete** – Min 3 in. thick reinforced lightweight or normal weight (100-150 pcf) concrete.
 - C. **Spray-Applied Fire Resistive Materials*** – Min 11/16 in. thickness spray-applied fire resistive material applied to all surfaces of steel floor units.

W R GRACE & CO - CONN CONSTRUCTION PRODUCTS DIV – Type MK-6/HY
2. **Through Penetrants** – One metallic pipe, tubing or conduit to be installed eccentrically or concentrically within the opening. The annular space between pipe and periphery of opening shall be min 0 in. (point contact) to max 1-1/2 in. Pipe to be rigidly supported on both sides of floor-ceiling assembly. The following types and sizes of metallic pipes, tubing or conduit may be used:
 - A. **Steel Pipe** – Nom 10 in. diam (or smaller) Schedule 10 (or heavier) steel pipe.
 - B. **Steel Pipe** – Nom 24 in. diam (or smaller) Schedule 40 (or heavier) steel pipe.
 - C. **Iron Pipe** – Nom 24 in. diam (or smaller) cast or ductile iron pipe.
 - D. **Copper Tube** – Nom 6 in. diam (or smaller) Type M (or heavier) copper tube.
 - E. **Copper Pipe** – Nom 6 in. diam (or smaller) Regular (or heavier) copper pipe.
 - F. **Conduit** – Nom 6 in. diam (or smaller) rigid steel conduit.
 - G. **Conduit** – Nom 4 in. diam (or smaller) electrical metallic tubing.
3. **Firestop System** – The firestop system shall consist of the following:
 - A. **Packing Material** – Min 2 in. thickness of min 4 pcf density mineral wool batt insulation firmly packed into the annular space and recessed to accommodate the required thickness of fill material.
 - B. **Fill, Void or Cavity Material* –Caulk or Sealant** – Min 3/4 in. thickness of caulk applied within the annulus, flush with the top surface of the floor. An additional 1/2 in. diam bead of caulk applied to the penetrant/concrete interface at point contact location on top surface of the floor.

3M COMPANY – CP 25WB+ caulk or FB-3000 WT sealant. (Note: W Rating applies only when FB-3000 WT is used.)

*Bearing the UL Classification Marking

Reprinted from the Online Certifications Directory with permission from Underwriters Laboratories Inc.
Copyright © 2010 Underwriters Laboratories Inc.®



System No. F-A-1041

January 09, 2007

F Rating – 2 Hr

T Rating – 0 and 1-1/4 Hr (See Item 3)

L Rating at Ambient – Less Than 1 CFM/sq ft (See Item 6)

L Rating at 400° F – Less Than 1 CFM/sq ft (See Item 6)

W Rating – Class 1 (See Item 6)

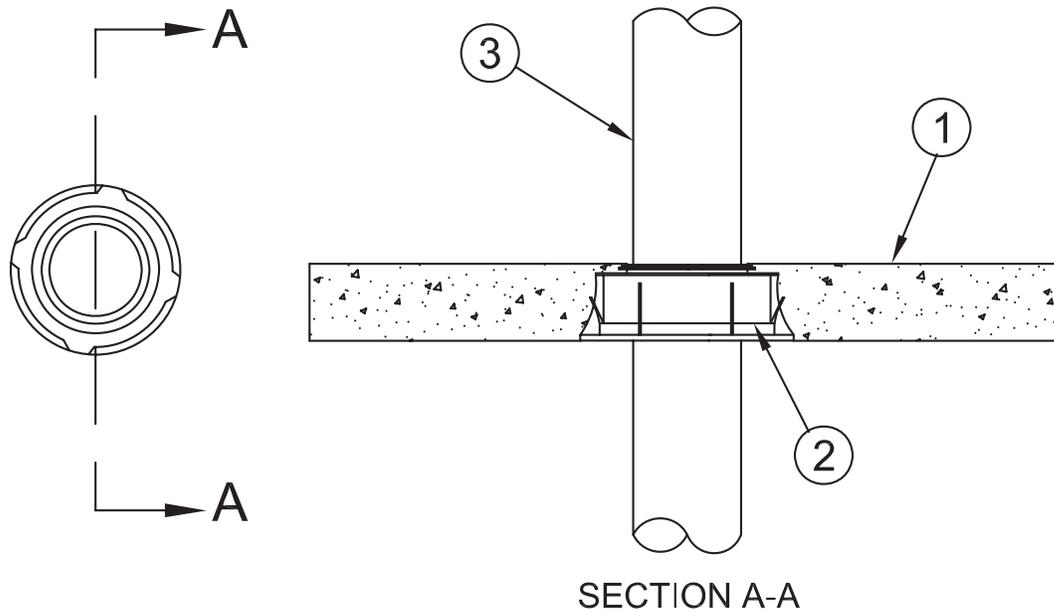

- Floor Assembly** – Min 2-1/2 in. (64 mm) thick reinforced lightweight or normal weight (100-150 pcf or 1600-2400 kg/m³) concrete.
- Firestop Device*** – Cast in place firestop device permanently embedded during concrete placement or grouted in concrete assembly in accordance with accompanying installation instructions. The device may project up to a max of 5-1/2 in. (140 mm) above top surface of floor for nom 2 in. (51 mm) diam (and smaller) penetrants.
3M COMPANY – 3M Fire Barrier Cast-In Device 2MCID, 3MCID, 4MCID.
- Through Penetrants** – One metallic pipe, tubing or conduit installed within the firestop system. Pipe or conduit to be rigidly supported on both sides of floor assembly. The nom pipe or conduit size shall match the nom size of the firestop device with the exception that both nom 1-1/2 and 2 in. (38 and 51 mm) pipes or conduits are suitable for use with the nom 2 in. (51 mm) device. The following types of metallic pipes or conduits may be used:
 - Steel Pipe** – Schedule 5 (or heavier) steel pipe.
 - Iron Pipe** – Cast or ductile iron pipe.
 - Conduit** – Steel conduit or steel electrical metallic tubing.
 - Copper Tubing** – Type L (or heavier) copper tubing.
 - Copper Pipe** – Regular (or heavier) copper pipe.

The hourly T Rating is 1-1/4 Hr for nom 1-1/2 in. (38 mm) diam steel and iron pipes and conduit when the firestop device extends a min of 2 in. (51 mm) above top surface of floor. The T Rating is 0 hr for all other penetrants.

- Packing Material** – (Not Shown) – Min 1/2 in. (13 mm) thick of min 4 pcf (64 kg/m³) mineral wool batt insulation shall be tightly packed within the firestop device around the penetrant, flush with the top surface of floor for all nom 3 in. and 4 in. (76 and 102 mm) penetrants. Packing material is optional with all nom 1-1/2 in. and 2 in. (38 and 51 mm) diam penetrants and may be flush with top surface of floor or top of device.
- Fill, Void or Cavity Materials – Putty** – (Not Shown) – As an alternate to the packing material (Item 4), a min 1/2 in. (13 mm) thickness of putty may be installed within the firestop device around the penetrant, flush with the top surface of floor for all nom 3 in. and 4 in. (76 and 102 mm) diam penetrants.
3M COMPANY – MP+ Stix putty
- Fill, Void or Cavity Materials – Sealant** – (Optional, Not Shown) – For W Rating, a min 1/4 in. (6 mm) bead of sealant is required at the device/concrete interface on the top surface of the floor. When nom 1-1/2 in. (38 mm) diam pipe is installed in nom 2 in. (51 mm) diam device, a min 1/2 in. (13 mm) depth of sealant is required in the annular space between the pipe and the inside of the device to attain the W and L Ratings.
3M COMPANY – FB-1000 NS Sealant, FB-1003 SL Sealant or FB-3000 WT Sealant

*Bearing the UL Classification Mark

Reprinted from the Online Certifications Directory with permission from Underwriters Laboratories Inc.
Copyright © 2010 Underwriters Laboratories Inc.®



System No. F-A-1042

January 09, 2007

F Rating – 3 Hr

T Rating – 0, 1/4, 1/2, 1, 2-1/4 and 3 Hr (See Item 3)

L Rating at Ambient – Less Than 1 CFM/sq ft (See Item 6)

L Rating at 400° F – Less Than 1 CFM/sq ft (See Item 6)

W Rating – Class 1 (See Item 6)

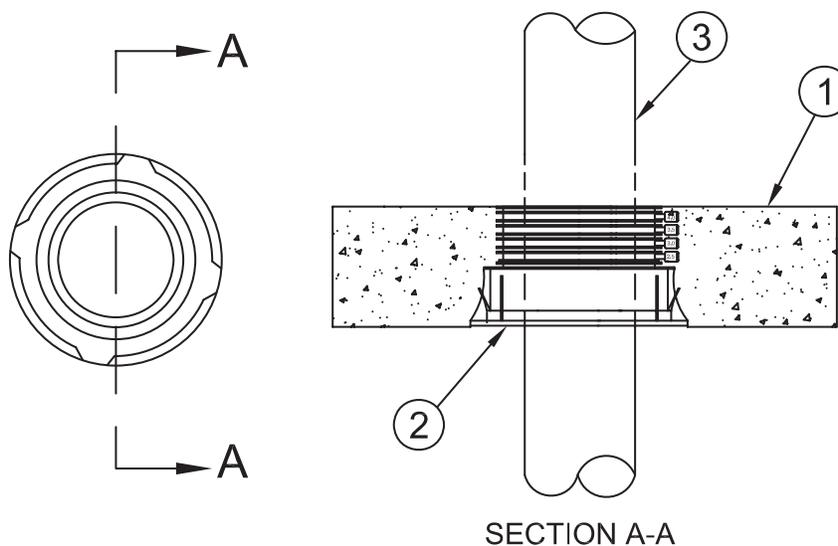

1. **Floor Assembly** – Min 4-1/2 in. (114 mm) thick reinforced lightweight or normal weight (100-150 pcf or 1600-2400 kg/m³) concrete.
2. **Firestop Device*** – Cast in place firestop device permanently embedded during concrete placement or grouted in concrete assembly in accordance with accompanying installation instructions. The device may project up to a max 3-1/2 in. (89 mm) above top surface of floor or must be trimmed flush with top surface of floor, dependent on the type and size of penetrant, as shown in Item 3.
 - 3M COMPANY** – 3M Fire Barrier Cast-In Device 2MCID, 3MCID, 4MCID.
- 2A. **Firestop Device – Height Adapter*** – (Not Shown) - For use in floors greater than 8 in. (203 mm) thick. Adapter snaps onto top of firestop device (Item 2).
 - 3M COMPANY** – 3M Fire Barrier Cast-In Device Height Adapter, 2HA, 3HA, 4HA.
3. **Through Penetrants** – One metallic pipe, tubing or conduit installed within the firestop system. Pipe or conduit to be rigidly supported on both sides of floor assembly. The nom pipe or conduit size shall match the nom size of the firestop device with the exception that both nom 1-1/2 and 2 in. (38 and 51 mm) pipes or conduits are suitable for use with the nom 2 in. (51 mm) device. The following types of metallic pipes or conduits may be used:
 - A. **Steel Pipe** – Schedule 10 (or heavier) steel pipe.
 - B. **Iron Pipe** – Cast or ductile iron pipe.
 - C. **Conduit** – Steel conduit or steel electrical metallic tubing.
 - D. **Copper Tubing** – Type L (or heavier) copper tubing.
 - E. **Copper Pipe** – Regular (or heavier) copper pipe.

The Hourly T Rating is dependent on the type and size of penetrant, the use of flush or extended device and the use or non-use of packing material or putty, as shown below. The ratings for the extended devices are dependent on the device extending a min of 2 in. (51 mm) above surface of floor. If the device extends less than 2 in. (51 mm) above floor, the ratings shown for the flush devices apply.

| Nom Penetrant Size, In. (mm) | Penetrant Type | Flush Device | Extended Device | Packing Material or Putty | F Rating Hr | T Rating Hr |
|------------------------------|----------------|--------------|-----------------|---------------------------|-------------|-------------|
| 1-1/2, 2 (38, 51) | A, B, C | No | Yes | Yes | 3 | 3 |
| 1-1/2, 2 (38, 51) | A, B, C | Yes | Yes | No | 3 | 1/2 |
| 1-1/2, 2 (38, 51) | D, E | No | Yes | Yes | 3 | 1/4 |
| 1-1/2, 2 (38, 51) | D, E | Yes | No | Yes | 3 | 0 |
| 3 (76) | A, B, C | No | Yes | Yes | 3 | 2-1/4 |
| 3 (76) | A, B, C | Yes | No | No | 3 | 1/2 |
| 3, 4 (76, 102) | B | No | Yes | No | 3 | 1 |
| 3, 4 (76, 102) | D, E | Yes | No | Yes | 3 | 0 |
| 4 (102) | A, B | Yes | No | No | 3 | 1/2 |
| 4 (102) | C | Yes | No | Yes | 3 | 1/4 |

System No. F-A-1042 *continued*

4. **Packing Material** (Not Shown) – Min 2 in. (51 mm) thick of min 4 pcf (64 kg/m³) mineral wool batt insulation shall be tightly packed within the firestop device around the penetrant, flush with the top surface of floor, where indicated in above table.
5. **Fill, Void or Cavity Materials – Putty** – (Not Shown) – As an alternate to the packing material (Item 4), a min 1 in. (25 mm) thickness of putty may be installed within the firestop device around the penetrant, flush with the top surface of floor for all nom 3 in. and 4 in. (76 and 102 mm) diam penetrants.

3M COMPANY – MP+ Stix putty

6. **Fill, Void or Cavity Materials – Sealant** – (Optional, Not Shown) – For W Rating, a min 1/4 in. (6 mm) bead of sealant is required at the device/concrete interface on the top surface of the floor. When nom 1-1/2 in. (38 mm) diam pipe is installed in nom 2 in. (51 mm) diam device, a min 1/4 in. (6 mm) depth of sealant atop a nom 2 in. (51 mm) depth of packing material is required in the annular space between the pipe and the inside of the device to attain the W and L Ratings.

3M COMPANY – FB-1000 NS Sealant, FB-1003 SL Sealant or FB-3000 WT Sealant

*Bearing the UL Classification Mark

Reprinted from the Online Certifications Directory with permission from Underwriters Laboratories Inc.
Copyright © 2010 Underwriters Laboratories Inc.®



Through Penetrations

Metallic Pipes

1000 Series

Concrete

FA

System No. F-A-1046

June 15, 2005
 F Rating – 2 Hr
 T Rating – 0 Hr

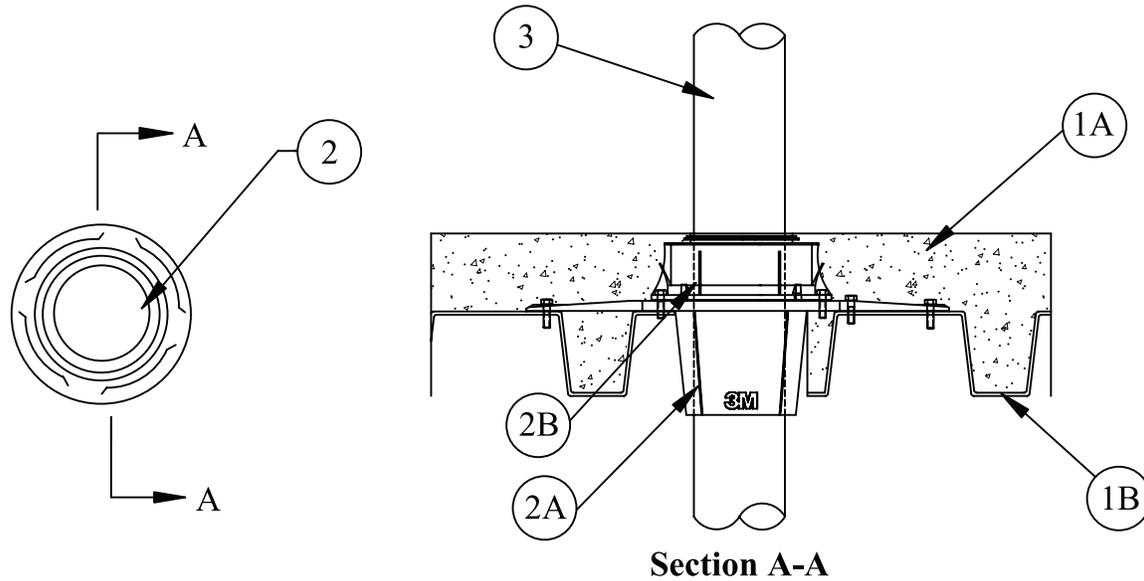

1. **Floor Assembly** – The fire-rated unprotected concrete and steel floor assembly shall be constructed of the materials and in the manner specified in the individual D900 Series designs in the UL Fire Resistance Directory and as summarized below:
 - A. **Concrete** – Min 2-1/2 in. (64 mm) thick reinforced lightweight or normal weight (100-150 pcf or 1600-2400 kg/m³) concrete.
 - B. **Steel Floor and Form Units*** – Composite or noncomposite max 3 in. (76 mm) deep fluted galv units as specified in the individual Floor-Ceiling design.
2. **Firestop Devices*** – The firestop devices are cast in place and permanently embedded during concrete placement or grouted in concrete assembly in accordance with accompanying installation instructions.
 - A. **Firestop Device – Metal Deck Adapter*** – Nom adapter size to correspond with nom penetrant size (Item 3), except that 2 in. (51 mm) adapter is suitable for both nom 1-1/2 in. and 2 in. (38 mm and 51 mm) penetrants. Adapter to be installed through opening in deck and secured with four sheet metal screws to deck in accordance with installation instructions.
3M COMPANY – 3M Fire Barrier Cast-In Device Metal Deck Adapter, 2MDA, 3MDA, 4MDA
 - B. **Firestop Device** – Snapped into top of metal deck adapter in accordance with accompanying installation instructions. The device may be trimmed flush with top surface of floor or may project up to a max 5-1/2 in. (140 mm) above top surface of floor for nom 2 in. (51 mm) diam (and smaller) penetrants. The device must be trimmed flush with top surface of floor for all nom 3 in. and 4 in. (76 mm and 102 mm) penetrants.
3M COMPANY – 3M Fire Barrier Cast-In Device, 2MCID, 3MCID, 4MCID
3. **Through Penetrants** – One metallic pipe, tubing or conduit installed within the firestop system. Pipe, tubing or conduit to be rigidly supported on both sides of floor assembly. The nom pipe, tubing or conduit size shall correspond to the nom size of the firestop device with the exception that both nom 1-1/2 in. and 2 in. (38 mm and 51 mm) pipes, tubing or conduits are suitable for use with the nom 2 in. (51 mm) device. The following types of metallic pipes, tubing or conduits may be used:
 - A. **Steel Pipe** – Schedule 5 (or heavier) steel pipe.
 - B. **Iron Pipe** – Cast or ductile iron pipe.
 - C. **Conduit** – Steel conduit or steel electrical metallic tubing.
 - D. **Copper Tubing** – Type L (or heavier) copper tubing.
 - E. **Copper Pipe** – Regular (or heavier) copper pipe.
4. **Packing Material** – (not shown) - Min 1/2 in. (13 mm) thick of min 4 pcf (64 kg/m³) mineral wool batt insulation shall be tightly packed within the firestop device around the penetrant, flush with the top surface of floor for all nom 3 in. and 4 in. (76 mm and 102 mm) penetrants. Packing material is optional with all nom 2 in. (51 mm) diam (and smaller) penetrants and may be flush with top surface of floor or top of device.
5. **Fill, Void or Cavity Materials – Putty** – (not shown) - As an alternate to the packing material (Item 4), a min 1/2 in. (13 mm) thickness of putty may be installed within the firestop device around the penetrant, flush with the top surface of floor for all nom 3 in. and 4 in. (76 mm and 102 mm) penetrants.

3M COMPANY – MP+ Stix

*Bearing the UL Classification Mark

Reprinted from the Online Certifications Directory with permission from Underwriters Laboratories Inc.
 Copyright © 2010 Underwriters Laboratories Inc.®



System No. F-A-1050

January 09, 2007

F Rating - 3 Hr

T Rating - 1/2 Hr

L Rating at Ambient – Less Than 1 CFM/sq ft (See Item 4A)

L Rating at 400° F – Less Than 1 CFM/sq ft (See Item 4A)

W Rating – Class 1 (See Item 4A)

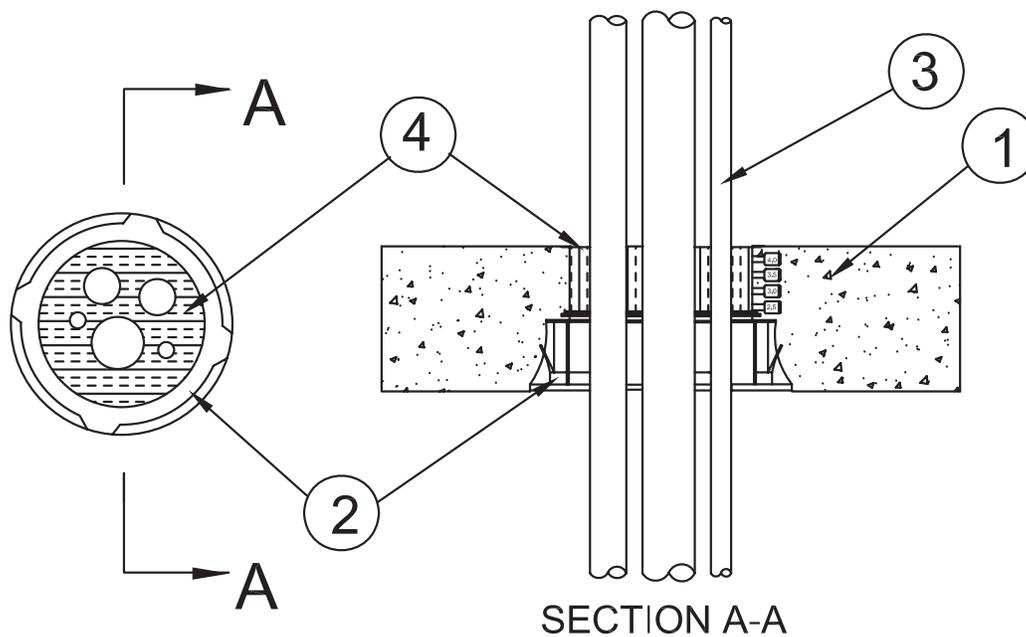

- 1. Floor Assembly** – Min 4-1/2 in. (114 mm) thick reinforced lightweight or normal weight (100-150 pcf or 1600 - 2400 kg/m³) concrete.
- 2. Firestop Device*** – Cast in place firestop device permanently embedded during concrete placement or grouted in concrete assembly in accordance with accompanying installation instructions. The device may be trimmed flush with top surface of floor or may project up to a max of 3-1/2 in. (89 mm) above top surface of floor.
3M COMPANY – 3M Fire Barrier Cast-In Device 2MCID, 3MCID, 4MCID
- 2A. Firestop Device – Height Adapter*** – (Not Shown) – For use in floors greater than 8 in. (203 mm) thick. Adapter snaps onto top of firestop device (Item 2).
3M COMPANY – 3M Fire Barrier Cast-In Device Height Adapter, 2HA, 3HA, 4HA
- 3. Through Penetrant** – One or more metallic pipes, conduits or tubes installed concentrically or eccentrically within the firestop system. Annular space between penetrants and periphery of opening shall be min of 0 in. (0 mm, point contact) to max 2 in. (51 mm). Space between penetrants shall be min of 1/4 in. (6 mm) to max 2 in. (51 mm). Penetrants to be rigidly supported on both sides of floor assembly. The following types and sizes of penetrants may be used:
 - A. Steel Pipe** – Nom 1-1/2 in. (38 mm) diam (or smaller) Schedule 5 (or heavier) steel pipe.
 - B. Iron Pipe** – Nom 1-1/2 in. (38 mm) diam (or smaller) cast or ductile iron pipe.
 - C. Conduit** – Nom 1-1/2 in. (38 mm) diam (or smaller) steel conduit or steel electrical metallic tubing.
 - D. Copper Tubing** – Nom 1 in. (25 mm) diam (or smaller) Type L (or heavier) copper tubing.
 - E. Copper Pipe** – Nom 1 in. (25 mm) diam (or smaller) Regular (or heavier) copper pipe.
- 4. Packing Material** – Min 2 in. (51 mm) thickness of min 4 pcf (64 kg/m³) mineral wool batt insulation firmly packed within annulus, flush with the top surface of floor.
- 4A. Fill, Void or Cavity Materials – Sealant, Caulk or Putty*** – (Optional, Not Shown) - As an option, the packing material (Item 4) may be reduced in thickness by 1/4 (6 mm) to 1/2 in. (13 mm) and recessed from the top surface of floor to accommodate a 1/4 (6 mm) to 1/2 in. (13 mm) thickness of sealant, caulk or putty, installed within annulus, flush with the top surface of floor. For W and L Ratings, sealant is required. For W Rating, a min 1/4 in. (6 mm) bead of sealant is also required at the device/concrete interface on the top surface of the floor.

3M COMPANY – FB-1000 NS sealant, FB-1003 SL sealant, CP 25WB+ caulk, FB-3000 WT sealant, FireDam 150+ caulk, IC 15WB+ caulk or MP+ Stix putty

(Note: W and L Ratings apply only when FB-1000 NS, FB-1003 SL or FB-3000 WT sealants are used.)

*Bearing the UL Classification Mark

Reprinted from the Online Certifications Directory with permission from Underwriters Laboratories Inc.

Copyright © 2010 Underwriters Laboratories Inc.®



System No. F-A-1057

August 18, 2009

F Rating – 2 Hr

T Rating – 2 Hr

L Rating at Ambient – 2 CFM/sq ft

L Rating at 400°F – Less than 1 CFM/sq ft

W Rating – Class 1 (See Item 3)

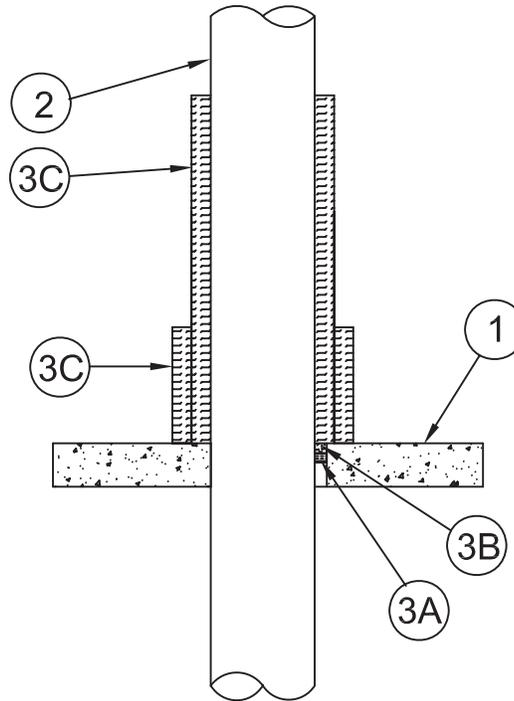
**SECTION A-A**

1. **Floor Assembly** – Min 4-1/2 in. (114 mm) thick reinforced lightweight or normal weight (100-150 pcf or 1600-2400 kg/m³) concrete. As an alternate, any min 2 hr fire rated D700, D800 or D900 Series Floor-Ceiling Design in the UL Fire Resistance Directory having a min 2-1/2 in. (64 mm) thickness of lightweight or normal weight (100-150 pcf or 1600-2400 kg/m³) concrete topping over the steel deck may be used. Max diam of opening is 12-3/4 in. (324 mm).
- 1A. **Steel Sleeve** – (Optional, Not Shown) – Nom 12 in. (305 mm) diam (or smaller) sleeve fabricated from nom 0.028 in. (0.71 mm) thick galv steel cast or grouted into floor assembly flush with floor surfaces.
2. **Through-Penetrant** – One metallic pipe or tubing installed concentrically or eccentrically within opening. Annular space between penetrant and periphery of opening shall be min of 0 in. (0 mm) (point contact) to max 2 in. (51 mm). Penetrant to be rigidly supported on both sides of floor assembly. The following types and sizes of penetrants may be used:
 - A. **Steel Pipe** – Nom 10 in. (254 mm) diam (or smaller) Schedule 10 (or heavier) steel pipe.
 - B. **Iron Pipe** – Nom 10 in. (254 mm) diam (or smaller) cast or ductile iron pipe.
 - C. **Copper Tubing** – Nom 4 in. (102 mm) diam (or smaller) Type L (or heavier) copper tubing.
 - D. **Copper Pipe** – Nom 4 in. (102 mm) diam (or smaller) Regular (or heavier) copper pipe.
 - E. **Conduit** – Nom 6 in. (152 mm) diam (or smaller) steel conduit or nom 4 in. (102 mm) diam (or smaller) steel electrical metallic tubing.
3. **Firestop System** – The details of the firestop system shall be as follows:
 - A. **Packing Material** – Min 1 in. (25 mm) thickness of min 4 pcf (64 kg/m³) mineral wool batt insulation firmly packed into opening as a permanent form. Packing material to be recessed from top surface of floor to accommodate the required thickness of fill material.
 - B. **Fill, Void or Cavity Materials*** – **Caulk, Sealant or Putty** – Min 1 in. (25 mm) thickness of caulk or putty applied within the annulus, flush with top surface of floor.
3M COMPANY – CP 25WB+ caulk, FB-3000 WT sealant or MP+ putty
 (Note: W Rating applies only when FB-3000 WT is used.)
 - C. **Duct Wrap Material*** – Nom 2 in. (51 mm) thick duct wrap tightly wrapped around penetrant to extend 36 in. (914 mm) above floor. An additional layer of nom 2 in. (51 mm) thick duct wrap tightly wrapped around the first layer of duct wrap to extend 12 in. (305 mm) (914 mm) above floor. All longitudinal seams of both layers of duct wrap are sealed with foil tape.
3M COMPANY – Fire Barrier Duct Wrap 20A, 3M Fire Barrier Duct Wrap 615, 3M Fire Barrier Duct Wrap 615+

*Bearing the UL Classification Mark

Reprinted from the Online Certifications Directory with permission from Underwriters Laboratories Inc.
 Copyright © 2010 Underwriters Laboratories Inc.®



System No. F-A-1064

October 07, 2010

F Rating – 3 Hr

T Ratings – 1/4, 1/2 and 1-3/4 Hr (See Item 2)

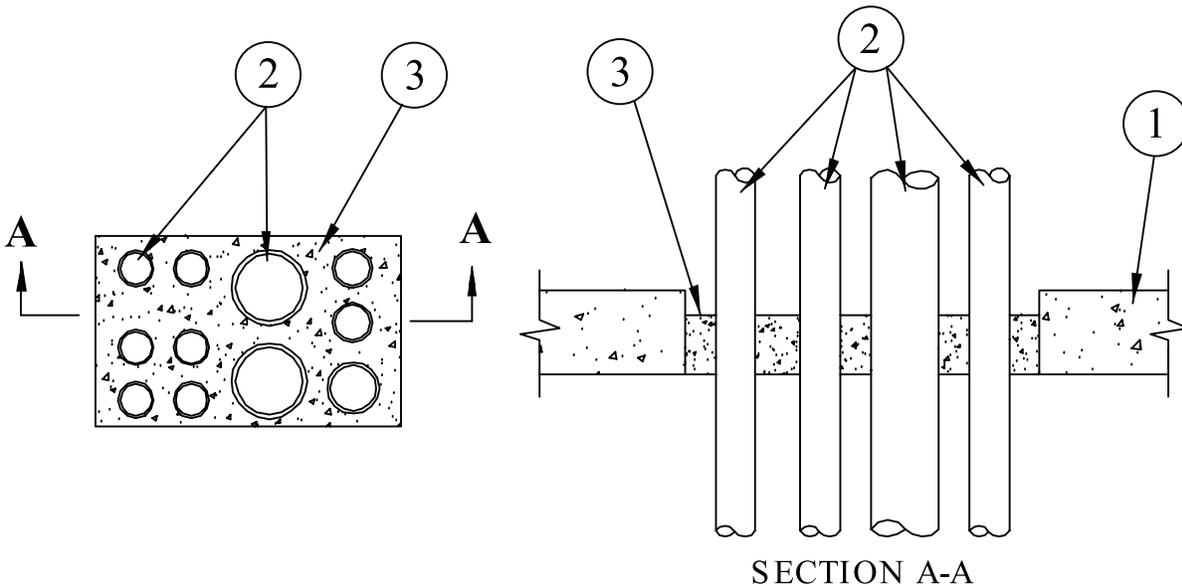

- Floor Assembly** – Min 4-1/2 in. (114 mm) thick reinforced lightweight or normal weight (100-150 pcf or 1600-2400 kg/m³) concrete. Max size of opening shall be 180 in² (1161 cm²) with a max dimension of 18 in. (457 mm).
- Metallic Pipes** – One or more metallic pipe, tubing or conduit installed concentrically or eccentrically within opening. Annular space between penetrants and between penetrants and periphery of opening shall be min 1/4 in. (6 mm) to max 4 in. (102 mm). Penetrants to be rigidly supported on both sides of floor assembly. The following types and sizes of penetrants may be used:
 - Steel Pipe** – Nom 4 in. (102 mm) diam (or smaller) Schedule 5 (or heavier) steel pipe.
 - Conduit** – Nom 4 in. (102 mm) diam (or smaller) steel electrical metallic tubing (EMT) or rigid steel conduit.
 - Iron Pipe** – Nom 4 in. (102 mm) diam (or smaller) cast or ductile iron pipe.
 - Copper Tubing** – Nom 3 in. (76 mm) diam (or smaller) Type L (or heavier) copper tubing.
 - Copper Pipe** – Nom 3 in. (76 mm) diam (or smaller) Regular (or heavier) copper pipe.

The hourly T Rating for the firestop system is 1/4 Hr for penetrants D and E, 1/2 Hr for penetrants A, B and C greater than nom 2 in. (51 mm) diam and 1-3/4 for penetrants A, B and C of nom 2 in. (51 mm) diam and smaller.

- Firestop System** – The firestop system shall consist of the following:
 - Forms** – (not shown) – Rigid sheet material cut to the contour of the penetrants and attached to the underside of the floor to prevent leakage of mortar. Forms to be removed after mortar has cured.
 - Fill, Void or Cavity Material*** – **Mortar** – Mortar to be mixed with water in accordance with the manufacturer's instructions. Min 3 in. (76 mm) thickness of mortar applied within the annulus.
3M COMPANY – 3M Fire Barrier Mortar

*Bearing the UL Classification Mark

Reprinted from the Online Certifications Directory with permission from Underwriters Laboratories Inc.
Copyright © 2011 Underwriters Laboratories Inc.®



Through Penetrations

Metallic Pipes

1000 Series

Concrete

FA

System No. F-A-1065

October 07, 2010

F Rating – 3 Hr

T Ratings – 1/2 and 1-1/4 Hr (See Item 2)

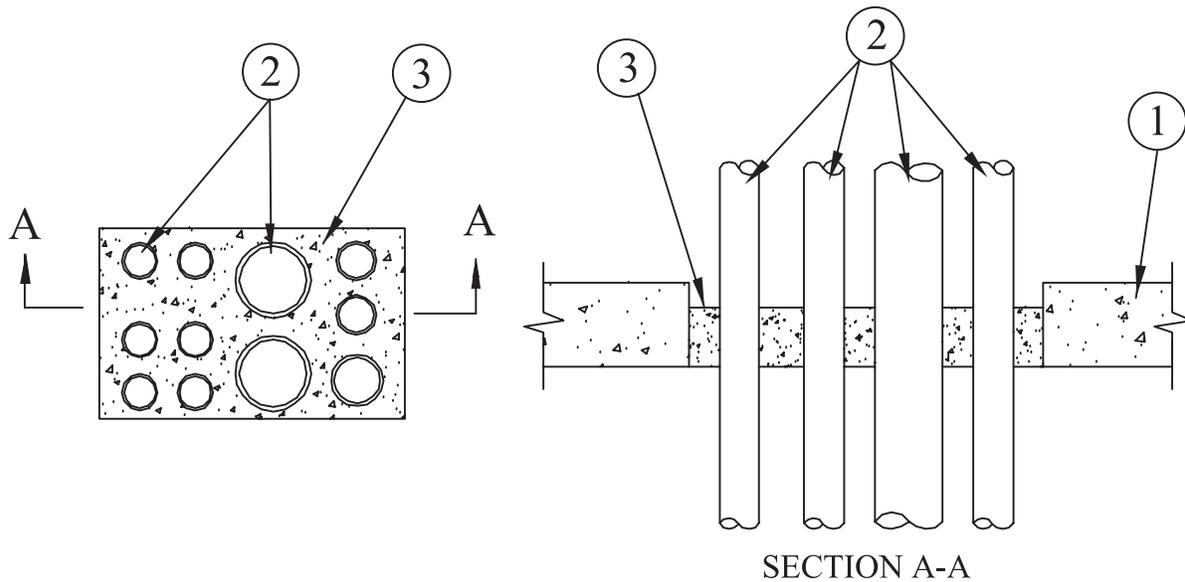

1. **Floor Assembly** – Min 4-1/2 in. (114 mm) thick reinforced lightweight or normal weight (100-150 pcf or 1600-2400 kg/m³) concrete. Max size of opening shall be 180 in² (1161 cm²) with a max dimension of 18 in. (457 mm).
2. **Metallic Pipes** – One or more metallic pipe, tubing or conduit installed concentrically or eccentrically within opening. Annular space between penetrants and between penetrants and periphery of opening shall be min 1/4 in. (6 mm) to max 4 in. (102 mm). Penetrants to be rigidly supported on both sides of floor assembly. The following types and sizes of penetrants may be used:
 - A. **Steel Pipe** – Nom 4 in. (102 mm) diam (or smaller) Schedule 5 (or heavier) steel pipe.
 - B. **Conduit** – Nom 4 in. (102 mm) diam (or smaller) steel electrical metallic tubing (EMT) or rigid steel conduit.
 - C. **Iron Pipe** – Nom 4 in. (102 mm) diam (or smaller) cast or ductile iron pipe.
 - D. **Copper Tubing** – Nom 3 in. (76 mm) diam (or smaller) Type L (or heavier) copper tubing.
 - E. **Copper Pipe** – Nom 3 in. (76 mm) diam (or smaller) Regular (or heavier) copper pipe.

The hourly T Rating for the firestop system is 1-1/4 for penetrants A, B and C of nom 2 in. (51 mm) diam and smaller. The hourly T Rating is 1/2 Hr for penetrants D and E and for penetrants A, B and C greater than nom 2 in. (51 mm) diam.
3. **Firestop System** – The firestop system shall consist of the following:
 - A. **Forms** – (not shown) – Rigid sheet material cut to the contour of the penetrants and attached to the underside of the floor to prevent leakage of mortar. Forms to be removed after mortar has cured.
 - B. **Fill, Void or Cavity Material*** – **Mortar** – Mortar to be mixed with water in accordance with the manufacturer's instructions. Min 4 in. (102 mm) thickness of mortar applied within the annulus.
3M COMPANY – 3M Fire Barrier Mortar

*Bearing the UL Classification Mark

Reprinted from the Online Certifications Directory with permission from Underwriters Laboratories Inc.
Copyright © 2011 Underwriters Laboratories Inc.®



System No. F-A-1067

XHEZ - Through-penetration Firestop Systems

June 06, 2016

F Rating — 3 Hr

T Rating — 0 Hr

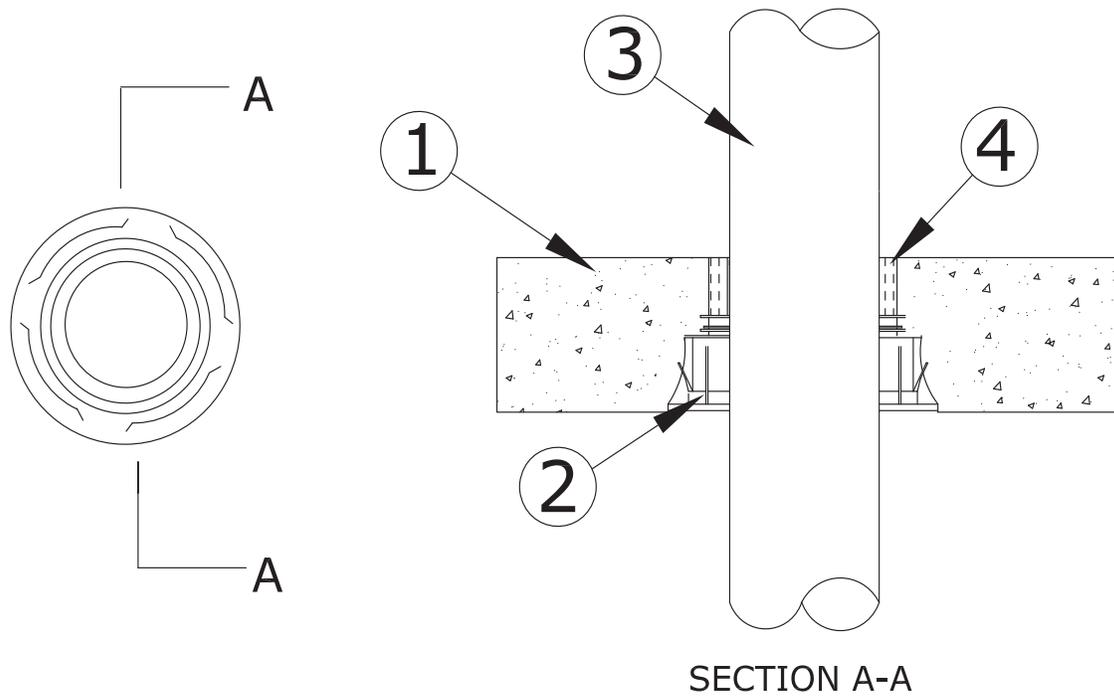

- Floor Assembly** — Min 4-1/2 in. (114 mm) thick reinforced lightweight or normal weight (100-150 pcf or 1600-2400 kg/m³) concrete.
- Firestop Device*** — Cast in place firestop device permanently embedded during concrete placement or grouted in concrete assembly in accordance with accompanying installation instructions. The device may be trimmed flush with top surface of floor or may project up to a max of 3-1/2 in. (89 mm) above top surface of floor.
 - 3M COMPANY** — 3M Fire Barrier Cast-In Device 6MCID
 - 2A. Firestop Device - Height Adapter*** — (Not Shown) - For use in floors greater than 8 in. (203 mm) thick. Adapter snaps onto top of firestop device (Item 2).
 - 3M COMPANY** — 3M Fire Barrier Cast-In Device Height Adapter, 6HA
- Through Penetrant** — One metallic pipe, tubing or conduit installed within the firestop system. Pipe or conduit to be rigidly supported on both sides of floor assembly. The following types and sizes of metallic pipes or conduits may be used:
 - Steel Pipe** — Nom 6 in. (152 mm) diam Schedule 5 (or heavier) steel pipe.
 - Iron Pipe** — Nom 6 in. (152 mm) diam cast or ductile iron pipe.
 - Conduit** — Nom 6 in. (152 mm) diam rigid steel conduit.
 - Copper Tubing** — Nom 6 in. (152 mm) diam Type L (or heavier) copper tubing.
 - Copper Pipe** — Nom 6 in. (152 mm) Regular (or heavier) copper pipe.
- Packing Material** — Min 2 in. (51 mm) thickness of min 4 pcf (64 kg/m³) mineral wool batt insulation tightly packed within the firestop device around the penetrant, flush with the top surface of floor.
- Pipe Tee Fitting System** — (Optional, Not Shown) — For use with Iron Pipe (Item 3B) only. One nom 6 in. (152 mm) diam (or smaller) PVC TESTRITE TEE Fitting (matched to penetrant diameter). The PVC TESTRITE TEE Fitting is secured to metallic penetrant (Item 3B) with compression type pipe coupling elastomeric gasket with stainless steel jacket and stainless steel band clamps for use in vented (drain, waste or vent) iron pipe systems. Installed (Item 3B) penetrant shall extend a minimum of 6 in. (152 mm) above the surface of the floor and minimum 12 in. (302 mm) below the bottom surface of the floor above assembly.

* Indicates such products shall bear the UL or cUL Certification Mark for jurisdictions employing the UL or cUL Certification (such as Canada), respectively.



System No. F-A-1092

October 30, 2006

F Rating – 3 Hr

T Rating – 0 Hr

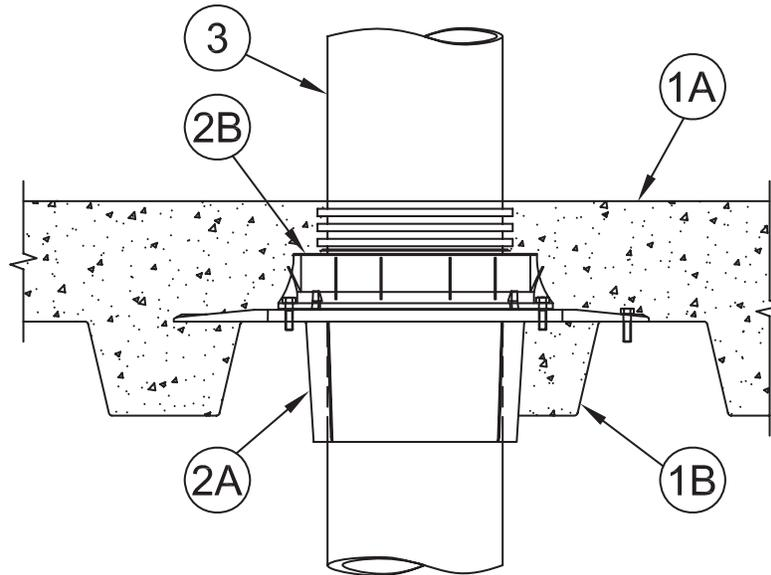

1. **Floor Assembly** – The fire-rated unprotected concrete and steel floor assembly shall be constructed of the materials and in the manner specified in the individual D900 Series designs in the UL Fire Resistance Directory and as summarized below:
 - A. **Concrete** – Min 4-1/2 in. (114 mm) thick reinforced lightweight or normal weight (100-150 pcf or 1600-2400 kg/m³) concrete topping.
 - B. **Steel Floor and Form Units*** – Composite or noncomposite max 3 in. (76 mm) deep fluted galv units as specified in the individual Floor-Ceiling design.
2. **Firestop Devices*** – The firestop devices are cast in place and permanently embedded during concrete placement or grouted in concrete assembly in accordance with accompanying installation instructions.
 - A. **Firestop Device - Metal Deck Adapter*** – Adapter installed through opening in deck and secured with four sheet metal screws to deck in accordance with installation instructions.
3M COMPANY – 3M Fire Barrier Cast-In Device Metal Deck Adapter, 6MDA
 - B. **Firestop Device*** – Snapped into top of metal deck adapter in accordance with accompanying installation instructions. The device shall be trimmed flush with top surface of floor.
3M COMPANY – 3M Fire Barrier Cast-In Device, 6MCID
3. **Through Penetrants** – One metallic pipe, tubing or conduit installed within the firestop system. Pipe, tubing or conduit to be rigidly supported on both sides of floor assembly. The following types of metallic pipes, tubing or conduits may be used:
 - A. **Steel Pipe** – Nom 6 in. (152 mm) diam Schedule 5 (or heavier) steel pipe.
 - B. **Iron Pipe** – Nom 6 in. (152 mm) diam cast or ductile iron pipe.
 - C. **Conduit** – Nom 6 in. (152 mm) diam steel conduit.
 - D. **Copper Tubing** – Nom 6 in. (152 mm) diam Type L (or heavier) copper tubing.
 - E. **Copper Pipe** – Nom 6 in. (152 mm) diam Regular (or heavier) copper pipe.
4. **Packing Material** – Min 2 in. (51 mm) thickness of min 4 pcf (64 kg/m³) mineral wool batt insulation shall be tightly packed within the firestop device around the penetrant, flush with the top surface of floor.

*Bearing the UL Classification Mark

Reprinted from the Online Certifications Directory with permission from Underwriters Laboratories Inc.
 Copyright © 2010 Underwriters Laboratories Inc.®

System No. F-A-1102

February 14, 2008

F Rating – 2 Hr

T Rating – 3/4 Hr

L Rating at Ambient – Less than 1 CFM/sq ft

L Rating at 400°F – Less than 1 CFM/sq ft

W Rating – Class 1

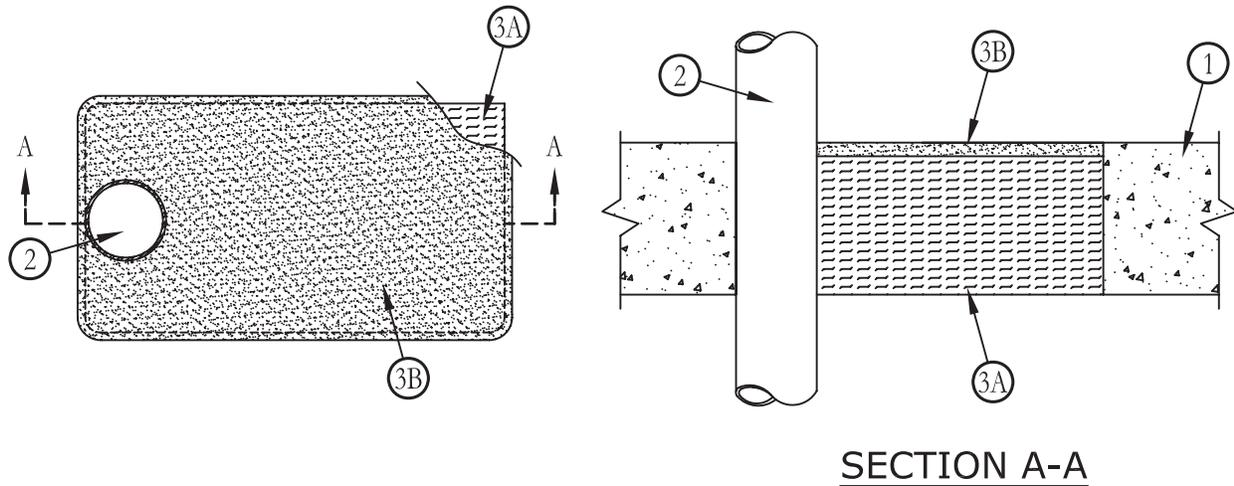

- Floor Assembly** – Min 4-1/2 in. (114 mm) thick reinforced lightweight or normal weight (100-150 pcf or 1600-2400 kg/m³) concrete. Max area of opening 98 in.² (632 cm²) with max dimension of 14 in. (356 mm).
- Through-Penetrant** – One or more metallic pipes, conduit or tubing installed concentrically or eccentrically within opening. Annular space between penetrant and periphery of opening shall be min 0 in. (point contact) to max 11-5/8 in. (295 mm). Minimum separation between penetrants shall be 1 in. (25 mm). Penetrants to be rigidly supported on both sides of floor or wall assembly. The following types and sizes of penetrants may be used:
 - Steel Pipe** – Nom 2 in. (51 mm) diam (or smaller) Schedule 40 (or heavier) steel pipe.
 - Iron Pipe** – Nom 2 in. (51 mm) diam (or smaller) cast or ductile iron pipe.
- Firestop System** – The details of the firestop system shall be as follows:
 - Packing Material** – Min 4 in. (102 mm) thickness of min 4 pcf (64 kg/m³) mineral wool batt insulation firmly packed into opening as a permanent form. Packing material to be recessed from top surface of floor to accommodate the required thickness of fill material.
 - Fill, Void or Cavity Materials* – Sealant** – Min 1/2 in. (13 mm) thickness of sealant applied within the annulus, flush with top surface of floor. Additional material to lap min 1/2 in. (13 mm) onto top surface of concrete around entire perimeter of opening. At point contact, apply min 1/4 in. (6 mm) bead at penetrant/concrete interface on top surface of floor.

3M COMPANY

3M FIRE PROTECTION PRODUCTS – FB-1003 SL Sealant

*Bearing the UL Classification Mark

Reprinted from the Online Certifications Directory with permission from Underwriters Laboratories Inc.
Copyright © 2010 Underwriters Laboratories Inc.®



System No. F-A-1112

March 27, 2009

F Rating – 2 Hr

T Rating – 0 Hr

L Rating at Ambient – Less Than 1 CFM/sq ft

L Rating at 400 F – 3 CFM/sq ft

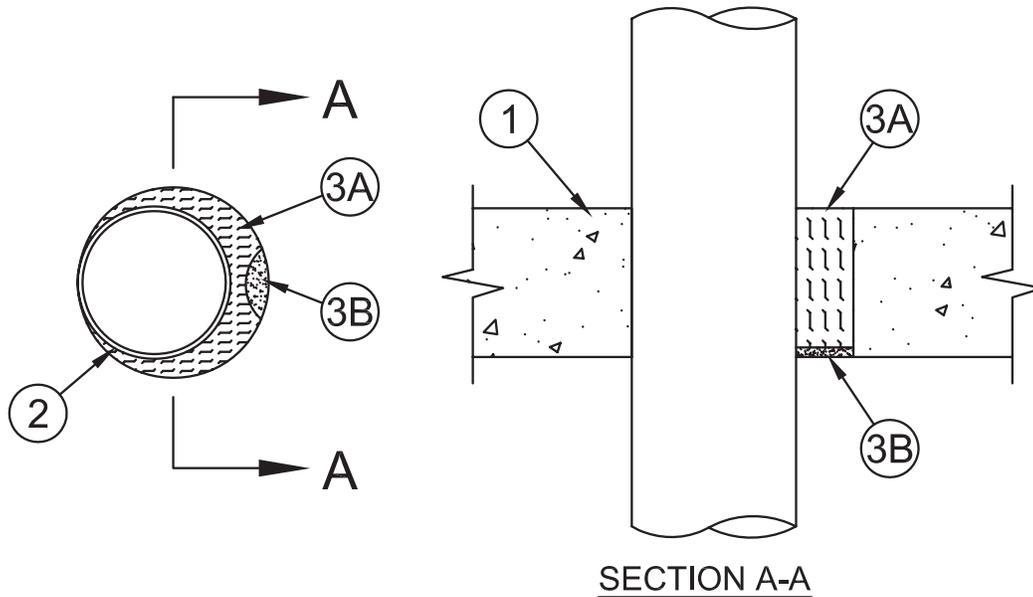

1. **Floor or Wall Assembly** – Min 4-1/2 in. thick reinforced lightweight or normal weight (100-150 pcf) concrete. Max diam of opening is 10-1/2 in.
2. **Through-Penetrant** – One metallic pipe, conduit or tubing installed either concentrically or eccentrically within the firestop system. The annular space between pipe, conduit or tubing and periphery of opening or sleeve shall be min of 0 in. (point contact) to max 1-7/8 in. Pipe, conduit or tubing to be rigidly supported on both sides of floor assembly. The following types and sizes of metallic pipes, conduits or tubing may be used:
 - A. **Steel Pipe** – Nom 8 in. diam (or smaller) Schedule 10 (or heavier) steel pipe.
 - B. **Iron Pipe** – Nom 8 in. diam (or smaller) service weight (or heavier) cast iron soil pipe, nom 8 in. diam (or smaller) or Class 50 (or heavier) ductile iron pressure pipe.
 - C. **Conduit** – Nom 6 in. diam (or smaller) steel conduit or nom 4 in. diam (or smaller) steel electrical metallic tubing.
 - D. **Copper Tubing** – Nom 4 in. diam (or smaller) Type M (or heavier) copper tubing.
 - E. **Copper Pipe** – Nom 4 in. diam (or smaller) Regular (or heavier) copper pipe.
3. **Firestop System** – The details of the firestop system shall be as follows:
 - A. **Packing Material** – Min 3-3/4 in. thickness of min 4 pcf mineral wool batt insulation firmly packed into opening as a permanent form. Packing material to be recessed from bottom surface of floor as required to accommodate the required thickness of fill material.
 - B. **Fill, Void or Cavity Materials* – Sealant** – Min 1/4 in. thickness of fill material applied within the annulus, flush with bottom surface of floor. Min 1/4 in. diam bead of caulk applied to the penetrant/concrete interface at the point contact location on the bottom surface of floor.

3M COMPANY
3M FIRE PROTECTION PRODUCTS – FB-1000 NS sealant

*Bearing the UL Classification Mark

Reprinted from the Online Certifications Directory with permission from Underwriters Laboratories Inc.
 Copyright © 2010 Underwriters Laboratories Inc.®





UL System No. F-A-1131
XHEZ – Through-penetration Firestop Systems
XHEZ7 – Through-penetration Firestop Systems Certified for Canada

January 08, 2018

| ANSI/UL1479 (ASTM E814) | CAN/ULC S115 |
|-------------------------|-------------------|
| F Rating – 2 Hr | F Rating – 2 Hr |
| T Rating – 2 Hr | FT Rating – 2 Hr |
| | FH Rating – 2 Hr |
| | FTH Rating – 2 Hr |

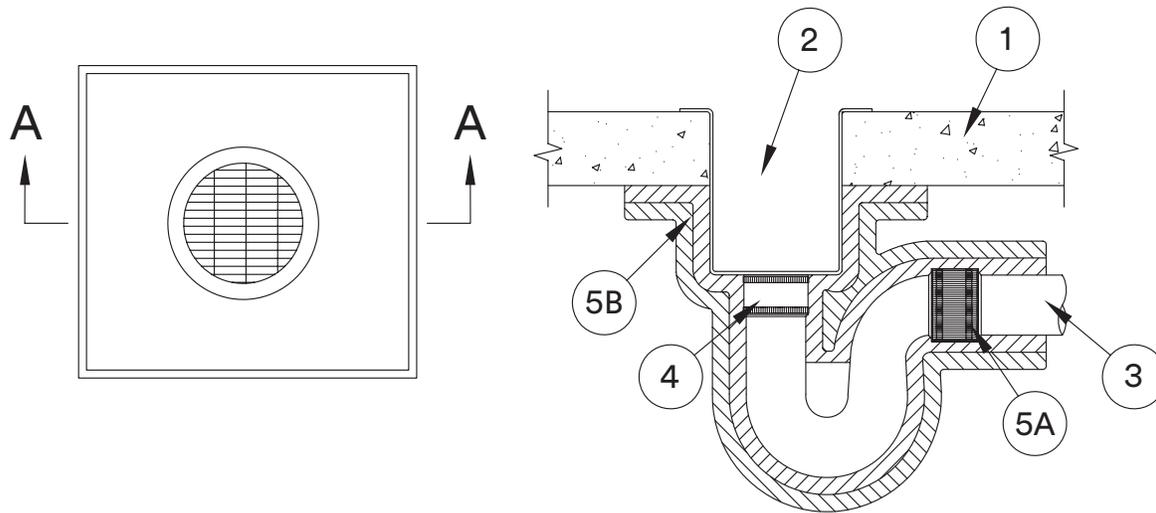

SECTION A-A

1. **Floor Assembly** – Min 2-1/2 in. (64 mm) thick reinforced lightweight or normal weight (100-150 pcf or 1600-2400 kg/m³) concrete.
2. **Floor Sink** – Max 12 in. wide by 12 in. long by 10 in. (305 by 305 by 254 mm) deep iron waste drain floor sink permanently embedded during concrete pour or grouted into concrete assembly. Sink to be max 1/4 in. (7 mm) above plane of floor assembly. Opening to be max 2 in. (51 mm) wider and longer than the in-floor dimension of the floor sink.
3. **Iron Pipe** – Nom 4 in. (102 mm) diam (or smaller) cast or ductile iron pipe to be secured to outlet of floor sink with no-hub coupling and to be rigidly support beneath floor away from floor sink with suitable hangers.
4. **Compression Coupling** – Nom 4 in. diam (or smaller) compression type high pressure pipe coupling with elastomeric plastic and a stainless steel shield. Coupling to be secured to pipe with stainless steel hose clamps at any point beyond the bottom of floor.
5. **Firestop System** – The firestop system shall consist of the following:
 - A. **Fill, Void or Cavity Materials*-Wrap Strip** – Nom 3/16 in. (5 mm) thick intumescent material supplied in 2-1/2 in. (64 mm) wide strips. Wrap strip tightly wrapped around each compression coupling. Wrap strip layers held in position using aluminum foil tape, steel wire tie, or equivalent.
3M COMPANY 3M FIRE PROTECTION PRODUCTS – 3M Fire Barrier Tuck-In WS Wrap Strip
 - B. **Duct Wrap Materials*** – Nom 1-1/2 in. (45 mm) thick duct wrap tightly wrapped around sink and drain pipe. An additional layer of nominal 1-3/4 in. (45 mm) thick duct wrap tightly wrapped around the first layer. Both layers of duct wrap shall extend a minimum of 24 in. (610 mm) beyond the bottom of floor and are held in position using filament tape or equivalent. Flared wrap extending around penetrant to overlap minimum 4 in. (102 mm) on underside of floor and secured with min. 1 in. (25 mm) wide by 1/8 in. (3 mm) wide by 15 in. (381 mm) long steel bar stock, nom 3/4 in. (20 mm) fender washers, nom 3-3/4 in. (95 mm) long masonry anchors and min 1/2 in. (13 mm) wide by 0.020 in. (0.5 mm) thick carbon or stainless steel straps. Banding straps spaced max 8 in. (203 mm) OC and extend to secure duct wrap layers to the steel bar.
3M COMPANY 3M FIRE PROTECTION PRODUCTS – 3M Fire Barrier Duct Wrap 615+

*Indicates such products shall bear the UL or cUL Certification Mark for jurisdictions employing the UL or cUL Certification (such as Canada), respectively.

Reprinted from the Online Certifications Directory with permission from UL©



UL System No. F-A-1160
XHEZ.F-A-1160

February 6, 2017

ANSI/UL1479 (ASTM E814)

F Rating – 2 Hr
T Rating – 2 Hr

CAN/ULC S115

F Rating – 2 Hr
FT Rating – 2 Hr
FH Rating – 2 Hr
FTH Rating – 2 Hr

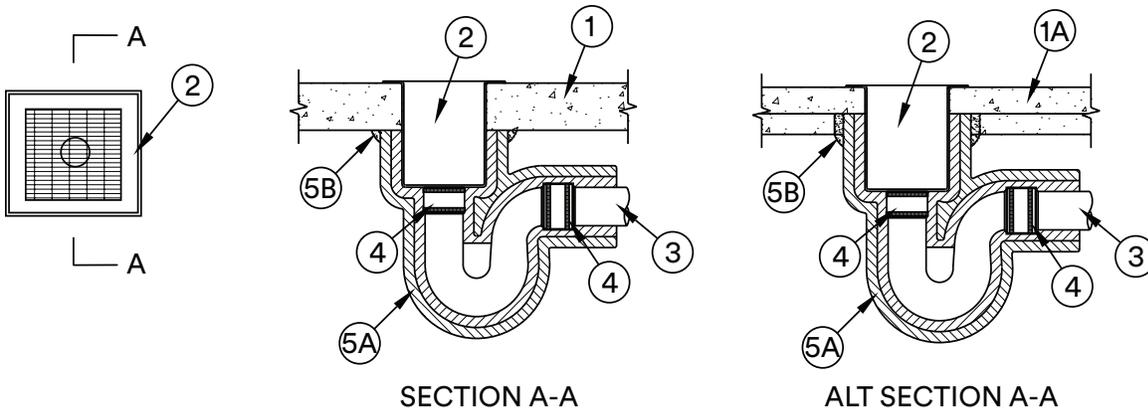

1. **Floor Assembly** – Min 2-1/2 in. (64 mm) thick reinforced lightweight or normal weight (100–150 pcf or 1600–2400 kg/m³) concrete.
- 1A. **Floor Assembly** – The fire rated protected or unprotected concrete and steel floor shall be constructed of the materials and in the manner specified in the individual D700 or D900 Series designs in the UL Fire Resistance Directory and as summarized below:
 - A. **Concrete** – Min 2-1/2 in. (64 mm) thick reinforced lightweight or normal weight (100–150 pcf or 1600–2400 kg/m³) concrete.
 - B. **Steel Floor and Form Units*** – Composite or non-composite max 2 in. (51 mm) deep galv steel fluted units as specified in the individual Floor-Ceiling Design.
 - C. **Spray-Applied Fire Resistive Material** – (Optional. Not Shown.) – Steel floor units may be sprayed with the type and thickness of fire resistive material indicated in the individual D700 Series Design.

UNITED STATES MINERAL PRODUCTS CO, DBA ISOLATEK INTERNATIONAL — Type 300
GCP APPLIED TECHNOLOGIES INC — MK-6/HY+
2. **Floor Sink and Grate** – Max 12 in. wide by 12 in. long by 10 in. (305 by 305 by 254 mm) deep cast iron waste drain floor sink permanently embedded during concrete pour or grouted into concrete assembly. Cast iron floor grating to be installed at top of sink. Metal dome strainer may be used in sink drain. Sink flanges to bear on top plane of floor assembly.
3. **Iron Pipe** – Nom 4 in. (102 mm) diam (or smaller) cast or ductile iron pipe to be secured to outlet of floor sink with no-hub coupling and to be rigidly supported beneath floor away from floor sink with suitable hangers.
4. **Compression Coupling** – Nom 4 in. diam (or smaller) compression type high pressure pipe coupling with elastomeric plastic and a stainless steel shield. Coupling to be secured to pipe with stainless steel hose clamps at any point beyond the bottom of floor.
5. **Firestop System** – The firestop system shall consist of the following:
 - A. **Duct Wrap Materials*** – Two layers of nom 1-1/2 in. (38 mm) thick faced or unfaced duct wrap to be tightly wrapped around sink and drain pipe. Both layers of duct wrap shall extend a minimum of 24 in. (610 mm) beyond the bottom of floor or the valley of the steel floor units and are held in position using wire ties. Duct wrap layers to butt tightly against bottom surface of floor. When fluted steel floor units (Item 1A) are used, the duct wrap layers shall be castle cut to follow the profile of and butt tightly against the fluted deck. Duct wrap held in position using nom 16 ga steel wire ties spaced max 8 in. (203 mm) on center and max 1 in. (25 mm) from ends of layers and bottom of floor or bottom valley of fluted deck.

3M COMPANY
3M FIRE PROTECTION PRODUCTS – 3M™ Fire Barrier Duct Wrap 615+
 - B. **Fill, Void or Cavity Material* – Sealant** – Min 1/2 in. (13 mm) bead of fill material applied around periphery of duct wrap floor at interface with bottom surface of floor or steel floor units. Sealant shall be applied to the contour of the steel floor units.

3M COMPANY
3M FIRE PROTECTION PRODUCTS – IC 15WB+, CP 25WB+ caulk, FB-3000 WT sealant

*Indicates such products shall bear the UL or cUL Certification Mark for jurisdictions employing the UL or cUL Certification (such as Canada), respectively. 
Reprinted from the Online Certifications Directory with permission from UL©

System No. F-B-1006

September 07, 2004

F Rating – 1 Hr

T Rating – 0 Hr

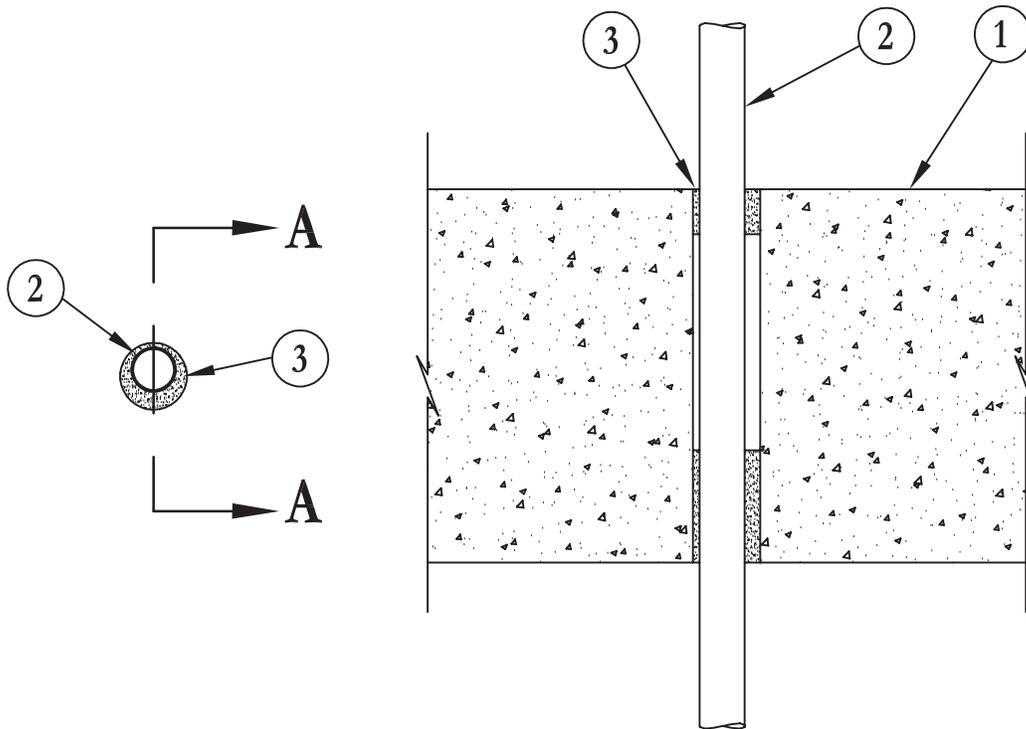

SECTION A-A

1. **Floor or Wall Assembly** – Min 6 in. thick reinforced lightweight or normal weight (100-150 pcf) concrete. Floor may also be constructed of any min 6 in. thick UL Classified hollow-core **Precast Concrete Units***. Max diam of opening is 2 in.
See **Precast Concrete Units** (CFTV) category in the Fire Resistance Directory for names of manufacturers.
2. **Conduit** – Nom 1 in. diam (or smaller) steel conduit, steel EMT or steel flexible conduit. The space between conduit and periphery of opening shall be min 1/8 in. to max 1/2 in. Conduit to be rigidly supported on both sides of floor assembly.
3. **Fill, Void or Cavity Materials* – Caulk or Sealant** – Min 1-1/4 in. thickness of fill material applied within the annulus, flush with bottom surface of floor. Min 1/2 in. thickness of fill material applied within the annulus, flush with top surface of floor.

3M COMPANY – CP 25WB+ caulk or FB-3000 WT sealant.

++Bearing the UL Listing Mark

*Bearing the UL Classification Marking

Reprinted from the Online Certifications Directory with permission from Underwriters Laboratories Inc.

Copyright © 2010 Underwriters Laboratories Inc.®



Through Penetrations

Metallic Pipes

1000 Series

Concrete

FB

System No. F-B-1011

November 22, 2004

F Rating – 3 Hr

T Rating – 1/4 Hr

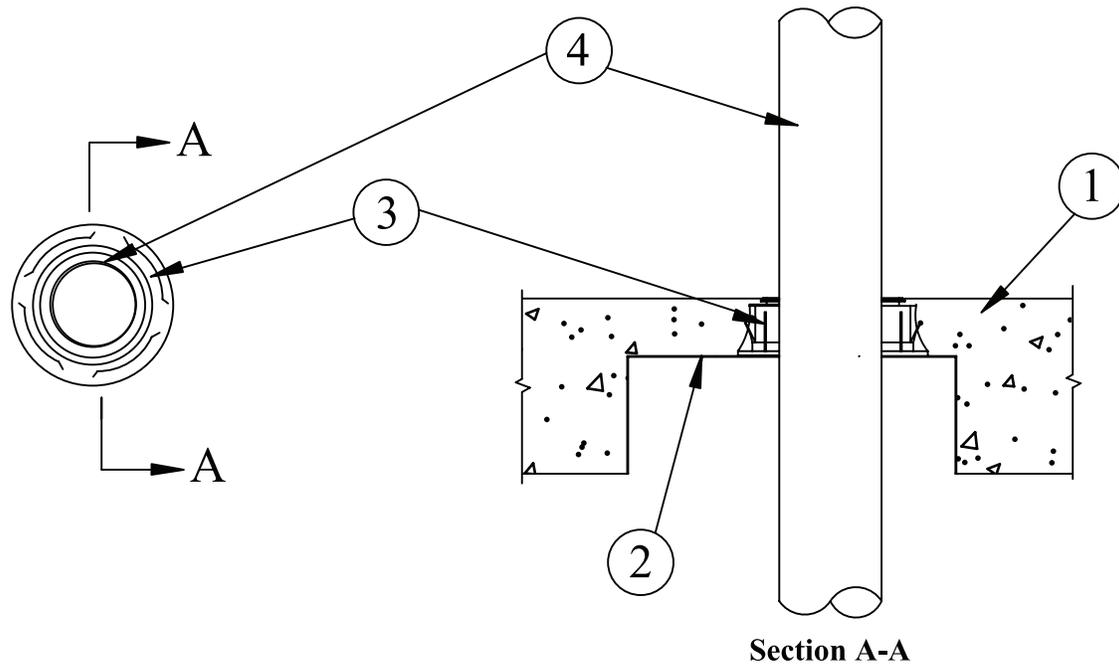

Section A-A

1. **Floor Assembly** – Min 6-1/2 in. thick reinforced lightweight or normal weight (100-150 pcf) concrete.
2. **Aerator Adapter** – Nom 14 in. by 9 in., min 4 in. deep cast-in-place galv steel adapter box provided with max 5 in. diam opening on top side. Firestop device (Item 3) mechanically fastened to the top side of box prior to placement of the concrete. The concrete thickness on top of adapter box shall be a min 2-1/2 in.
- 2A. **Firestop Device-Aerator Adapter*** – As an alternate to Item 2, a nom 10 in. by 7 in. by 4 in. deep nonmetallic adapter box may be used. Firestop device (Item 3) latched to the top side of box with snaps provided as part of the adapter prior to placement of the concrete. The concrete thickness on top of adapter box shall be a min 2-1/2 in.
 - 3M COMPANY** – 3M Fire Barrier Cast-In Device, 3MCID, 4MCID
3. **Firestop Device*** – The firestop device is mechanically attached to top of adapter (Item 2) with a min of four No. 8 (or larger) steel sheet metal screws or latched to the top side of nonmetallic box and cast in place and permanently embedded during concrete placement in accordance with accompanying installation instructions.
 - 3M COMPANY** – 3M Fire Barrier Cast-In Device, 3MCID, 4MCID
4. **Drain Piping** – Nom 3 in. or 4 in. diam cast or ductile iron pipe. Drain piping rigidly supported on both sides of floor assembly.
5. **Aerator Fitting** – (Not Shown) – Nom 3 in. or 4 in. diam cast iron aerator fitting attached to drain piping below floor assembly. Fitting shall not penetrate the firestop device.

*Bearing the UL Classification Mark

Reprinted from the Online Certifications Directory with permission from Underwriters Laboratories Inc.

Copyright © 2010 Underwriters Laboratories Inc.®

System No. W-J-1010

June 15, 2005

F Rating – 3 Hr

T Ratings – 1, 1-1/2 and 2 Hr (See Item 2)

L Rating At Ambient – 2 CFM/sq ft

L Rating At 400 F – less than 1 CFM/sq ft

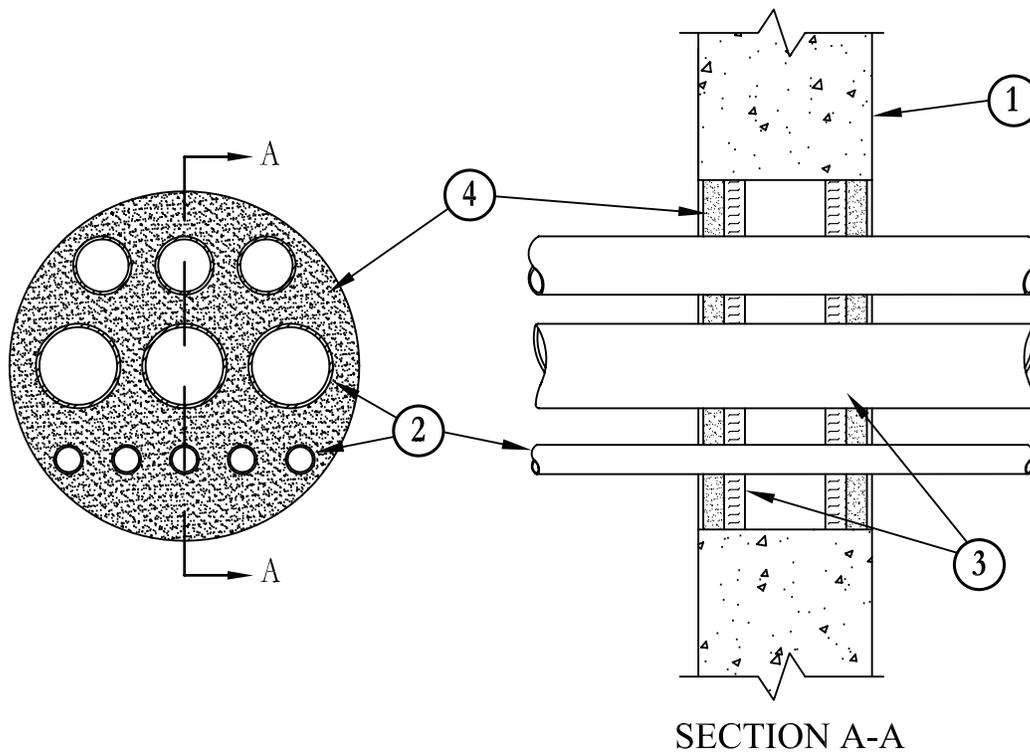

- Wall Assembly** – Min 6 in. (152 mm) thick lightweight or normal weight (100-150 pcf or 1600-2400 kg/m³) concrete. Wall may also be constructed of any UL Classified **Concrete Blocks***. Max diam of opening is 12 in. (305 mm).
See **Concrete Blocks** (CAZT) category in the Fire Resistance Directory for names of manufacturers.
- Steel Pipe or Conduit** – Nom 3 in. (76 mm) diam (or smaller) Schedule 10 (or heavier) steel pipe, steel conduit or steel electrical metallic tubing. Multiple pipes and/or conduit permitted in opening provided a min separation of 1/4 in. (6 mm) is maintained between pipes or conduits. Pipes and/or conduits to be rigidly supported on both sides of the wall assembly. The T Rating of the firestop system is dependent upon the max diam of the pipes or conduits, as tabulated below:

| Max Pipe or Conduit Diam In. (mm) | T Rating Hr |
|-----------------------------------|-------------|
| 3 (76 mm) | 1 |
| 1 (25 mm) | 1-1/2 |
| 3/4 (19 mm) | 2 |

- Packing Material** – Min 1 in. (25 mm) thick rigid glass fiber insulation or mineral wool batt insulation firmly packed into opening on both sides of wall assembly as a permanent form. Packing material to be recessed min 1 in. (25 mm) from surface of wall on both sides of wall assembly.
- Fill, Void or Cavity Materials* – Caulk or Sealant** – Applied to fill the through opening to a min depth of 1 in. (25 mm) on both sides of wall assembly.
3M COMPANY – CP 25WB+ caulk or FB-3000 WT sealant.

*Bearing the UL Classification Marking

Reprinted from the Online Certifications Directory with permission from Underwriters Laboratories Inc.

Copyright © 2010 Underwriters Laboratories Inc.®



System No. W-J-1111

September 20, 2011

ANSI/UL1479 (ASTM E814)

F Rating – 2 Hr

T Rating – 1/2 Hr

L Rating At Ambient – 7 CFM/sq ft

L Rating At 400 F – 4 CFM/sq ft

CAN/ULC S115

F Rating – 2 Hr

FT Rating – 1/2 Hr

FH Rating – 2 Hr

FTH Rating – 1/2 Hr

L Rating At Ambient – 7 CFM/sq ft

L Rating At 400 F – 4 CFM/sq ft

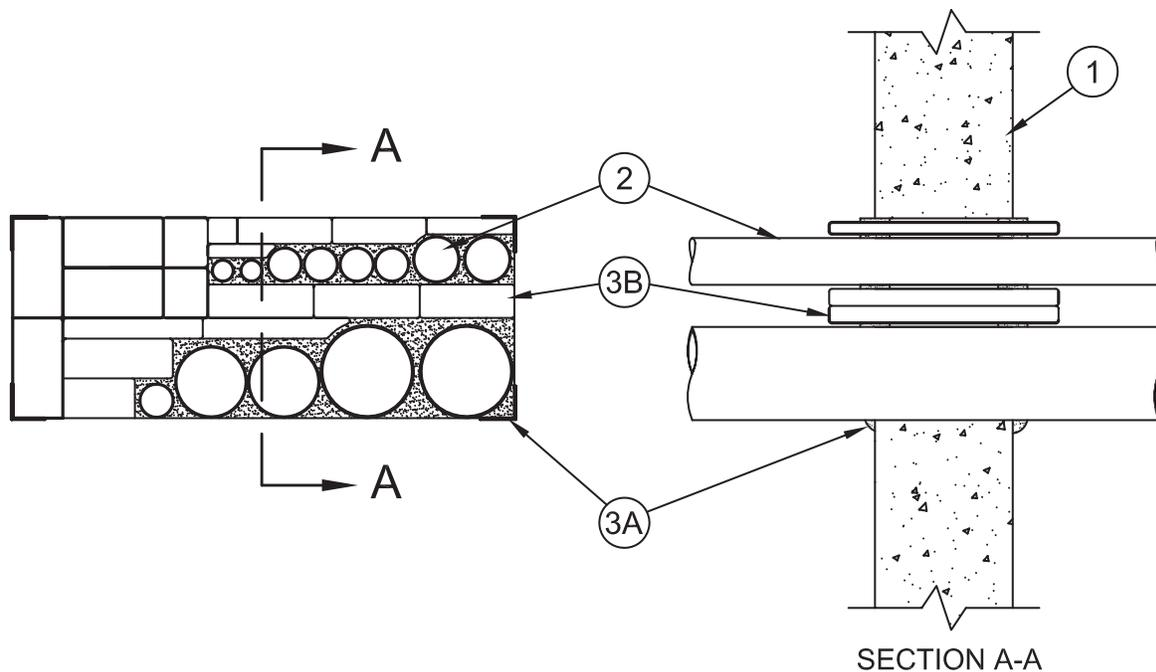

1. **Wall Assembly** – Min 4-1/2 in. (114 mm) thick reinforced lightweight or normal weight (100-150 pcf or 1600-2400 kg/m³) concrete. Wall may also be constructed of any UL Classified **Concrete Blocks***. Max area of opening is 225 in² (0.15 m²) with a max dimension of 22-1/2 in. (572 mm).

See **Concrete Blocks (CAZT)** category in the Fire Resistance Directory for names of manufacturers.

2. **Through-Penetrant** – One or more nom 4 in. (102 mm) diam (or smaller) rigid steel conduit or electrical metallic tubing (EMT) installed either concentrically or eccentrically within the firestop system. The annular space between conduits or tubing and periphery of opening shall be min 0 in. (0 mm, point contact) to max 4 in. (102 mm). The horizontal space between conduits or tubing shall be min 1/4 in. (6 mm) to max 4 in. (102 mm). The vertical space between conduits or tubing shall be min 1-1/2 in. (38 mm) to max 4 in. (102 mm) Conduit or tubing to be rigidly supported on both sides of wall assembly.
3. **Firestop System** – The firestop system shall consist of the following:

A. **Fill Void or Cavity Material* – Putty** – Min 2 in. (51 mm) thickness of putty formed to a min 1 in. (25 mm) width and applied within annulus at all corners of opening and extending a min 1 in. (25 mm) both directions from each corner, flush with both surfaces of wall. Min 1/4 in. (6 mm) thickness, min 2 in. (51 mm) width of putty wrapped around each penetrant such that putty extends approximately 1/2 in. (13 mm) beyond both surfaces of wall. After installation of pillows (Item 4B) all voids within the opening shall be filled with a min 1 in. (25 mm) thickness of putty.

3M COMPANY – MPS-2+

B. **Fill Void or Cavity Material* – Pillows** – Max 9 in. (229 mm) long by 6 in. (152 mm) wide by 2 and 3 in. (51 and 76 mm) thick plastic covered pillows tightly-packed to fill annular space between penetrants and periphery of opening and installed with 9 in. (229 mm) dimension projecting through wall and centered within the opening.

3M COMPANY – Fire Barrier Pillow or Fire Barrier Self-Locking Pillows

*Bearing the UL Classification Mark

Reprinted from the Online Certifications Directory with permission from Underwriters Laboratories Inc.
Copyright © 2011 Underwriters Laboratories Inc.®



System No. W-J-1122

May 18, 2005
 F Rating – 2 Hr
 T Rating – 1/4 Hr

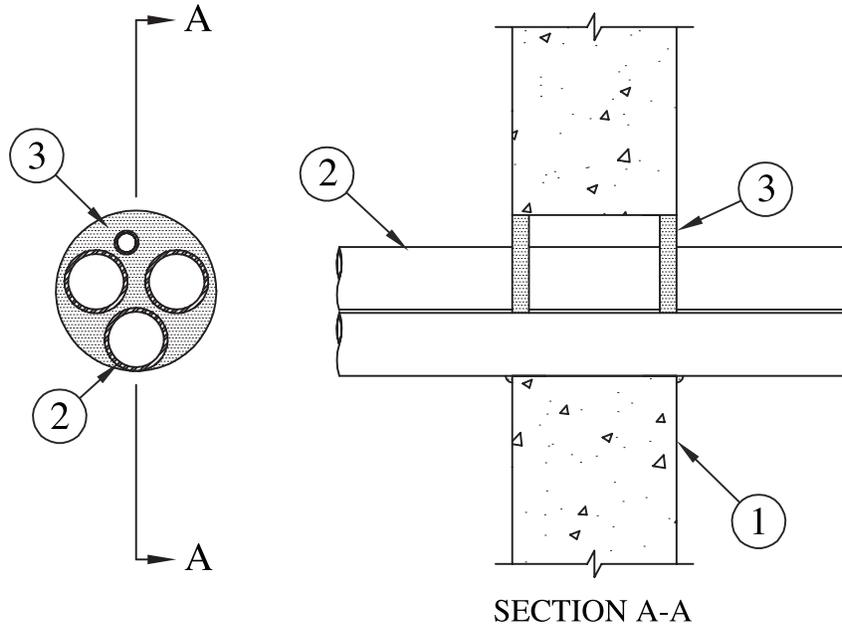

1. **Wall Assembly** – Min 6 in. (152 mm) thick reinforced lightweight or normal weight (100-150 pcf or 1600-2400 kg/m³) concrete wall. Wall may also be constructed of any UL Classified **Concrete Blocks***. Max diam of opening is 8 in.(203 mm).
 See **Concrete Blocks** (CAZT) category in the Fire Resistance Directory for names of manufacturers.
2. **Through Penetrants** – One or more metallic pipes, conduits, tubes or flexible metal pipes installed concentrically or eccentrically within opening. Annular space between penetrants and periphery of opening to be min 0 in. (point contact) to max 2 in. (0 mm to max 51 mm) Space between penetrants to be min 1/4 in. to max 2 in. (6 mm to max 51 mm). Penetrants to be rigidly supported on both sides of wall assembly. The following types and sizes of penetrants may be used:
 - A. **Steel Pipe** – Nom 3 in. (76 mm) diam (or smaller) Schedule 5 (or heavier) steel pipe.
 - B. **Iron Pipe** – Nom 3 in. (76 mm) diam (or smaller) cast or ductile iron pipe.
 - C. **Conduit** – Nom 3 in. (76 mm) diam (or smaller) steel conduit or steel electrical metallic tubing.
 - D. **Copper Tubing** – Nom 2 in. (51 mm) diam (or smaller) Type L (or heavier) copper tubing.
 - E. **Copper Pipe** – Nom 2 in. (51 mm) diam (or smaller) Regular (or heavier) copper pipe.
- F. **Through Penetrating Product*** – Flexible Metal Piping – The following types of steel flexible metal gas piping may be used:
 1. Nom 2 in. (51 mm) diam (or smaller) steel flexible metal gas piping. Plastic covering on piping may or may not be removed on both sides of floor or wall assembly.
OMEGA FLEX INC.
 2. Nom 1 in. (25 mm) diam (or smaller) steel flexible metal gas piping. Plastic covering on piping may or may not be removed on both sides of floor or wall assembly.
TITFLEX CORP, A BUNDY CO.
 3. Nom 1 in. (25 mm) diam (or smaller) steel flexible metal gas piping. Plastic covering on piping may or may not be removed on both sides of floor or wall assembly.
WARD MFG INC.
3. **Fill, Void or Cavity Material* – Caulk or Sealant** – Min 5/8 in. (16 mm) thickness of caulk applied within annulus, flush with both surfaces of wall. Min 1/4 in. (6 mm) diam bead of caulk applied to penetrant/wall interface at point contact location on both sides of wall.
3M COMPANY – CP 25WB+, IC 15WB+ caulk or FB-3000 WT sealant.

*Bearing the UL Classification Marking

Reprinted from the Online Certifications Directory with permission from Underwriters Laboratories Inc.
 Copyright © 2010 Underwriters Laboratories Inc.®



System No. W-J-1127

May 18, 2005
F Rating – 2 Hr
T Rating – 1/4 Hr

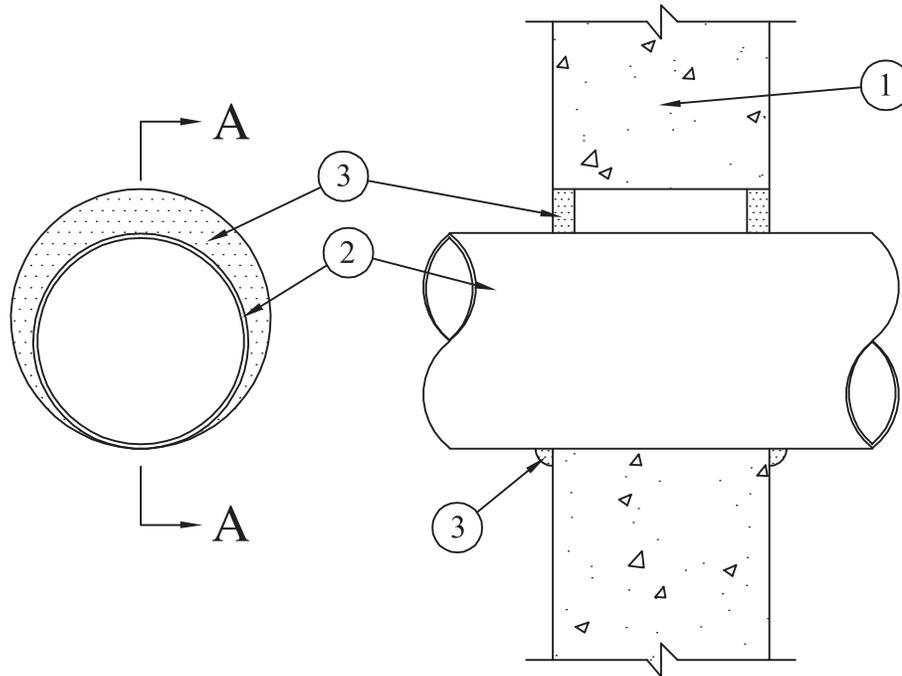

SECTION A-A

- Wall Assembly** – Min 6 in. (152 mm) thick reinforced lightweight or normal weight (100-150 pcf or 1600-2400 kg/m³) concrete wall. Wall may also be constructed of any UL Classified **Concrete Blocks***. Max diam of opening is 10-1/2 in. (267 mm).
See **Concrete Blocks** (CAZT) category in the Fire Resistance Directory for names of manufacturers.
- Through Penetrants** – One metallic pipe, conduit, tubing or flexible metal pipe installed concentrically or eccentrically within opening. Annular space between penetrant and periphery of opening to be min 0 in. (point contact) to max 1-7/8 in. (0 mm to max 48 mm) Penetrant to be rigidly supported on both sides of wall. The following types and sizes of penetrants may be used:
 - Steel Pipe** – Nom 8 in. (203 mm) diam (or smaller) Schedule 5 (or heavier) steel pipe.
 - Iron Pipe** – Nom 8 in. (203 mm) diam (or smaller) cast or ductile iron pipe.
 - Conduit** – Nom 4 in. (102 mm) diam (or smaller) steel electrical metallic tubing (EMT) or nom 6 in. (152 mm) rigid steel conduit.
 - Copper Tubing** – Nom 4 in. (102 mm) diam (or smaller) Type L (or heavier) copper tubing.
 - Copper Pipe** – Nom 4 in. (102 mm) diam (or smaller) Regular (or heavier) copper pipe.
 - Through Penetrating Product*** – **Flexible Metal Piping** – The following types of steel flexible metal gas piping may be used:
 - Nom 2 in. (51 mm) diam (or smaller) steel flexible metal gas piping. Plastic covering on piping may or may not be removed on both sides of floor or wall assembly.
OMEGA FLEX INC.
 - Nom 1 in. (25 mm) diam (or smaller) steel flexible metal gas piping. Plastic covering on piping may or may not be removed on both sides of floor or wall assembly.
TITFLEX CORP, A BUNDY CO.
 - Nom 1 in. (25 mm) diam (or smaller) steel flexible metal gas piping. Plastic covering on piping may or may not be removed on both sides of floor or wall assembly.
WARD MFG INC.
- Fill, Void or Cavity Material*** – **Caulk or Sealant** – Min 5/8 in. (16 mm) thickness of caulk applied within annulus, flush with both surfaces of wall. Min 1/4 in. (6 mm) diam bead of caulk applied to penetrant/wall interface at point contact location on both sides of wall.
3M COMPANY – CP 25WB+, IC 15WB+ caulk or FB-3000 WT sealant.

*Bearing the UL Classification Marking

Reprinted from the Online Certifications Directory with permission from Underwriters Laboratories Inc.
Copyright © 2010 Underwriters Laboratories Inc.®



System No. W-J-1139

May 18, 2005
 F Rating – 2 Hr
 T Rating – 0 Hr

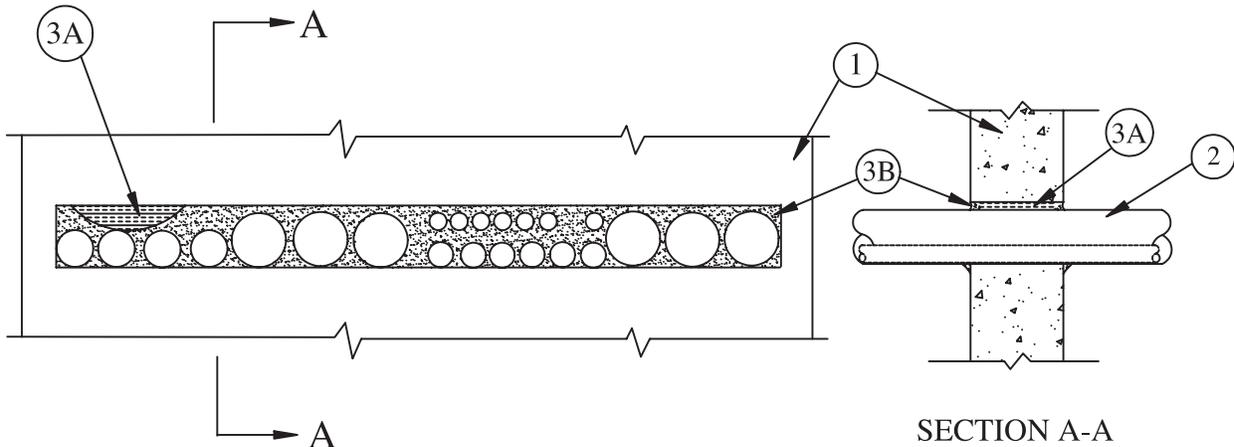

1. **Wall Assembly** – Min 6 in. (152 mm) thick reinforced lightweight or normal weight (100-150 pcf or 1600-2400 kg/m³) concrete wall. Wall may also be constructed of any UL Classified **Concrete Blocks***. Max size of opening to be 182 in.² (1174 cm²) with a max dimension of 45-1/2 in. (1156 mm).
 See **Concrete Blocks** (CAZT) category in the Fire Resistance Directory for names of manufacturers.
2. **Through Penetrants** – One or more metallic pipes or conduits installed within opening. Annular space between penetrants and periphery of opening to be min 0 in. (point contact) to max 2 in. (0 mm to max 51 mm). Space between penetrants to be min 1/4 in. to max 2 in. (6 mm to max 51 mm). Penetrants to be rigidly supported on both sides of wall. The following types and sizes of penetrants may be used:
 - A. **Steel Pipe** – Nom 3 in. (76 mm) diam (or smaller) Schedule 5 (or heavier) steel pipe.
 - B. **Conduit** – Nom 3 in. (76 mm) diam (or smaller) rigid steel conduit or steel electrical metallic tubing.
3. **Firestop System** – The firestop system shall consist of the following:
 - A. **Packing Material** – Min 5 in. (127 mm) thickness of min 4 pcf (64 kg/m³) mineral-wool batt insulation firmly packed into opening. Packing material to be recessed from both sides of wall assembly to accommodate the required thickness of fill material.
 - B. **Fill, Void or Cavity Material*** – **Caulk or Sealant** – Min 1/2 in. (13 mm) thickness of caulk applied within annulus, flush with both surfaces of wall. Min 1/4 in. (6 mm) diam bead of caulk applied to penetrant/wall interface at point contact location on both sides of wall.
3M COMPANY – CP 25WB+, IC 15WB+ caulk or FB-3000 WT sealant.

*Bearing the UL Classification Marking

Reprinted from the Online Certifications Directory with permission from Underwriters Laboratories Inc.
 Copyright © 2010 Underwriters Laboratories Inc.®



System No. W-J-1155

May 18, 2005

F Rating – 2 Hr

T Rating – 0 Hr

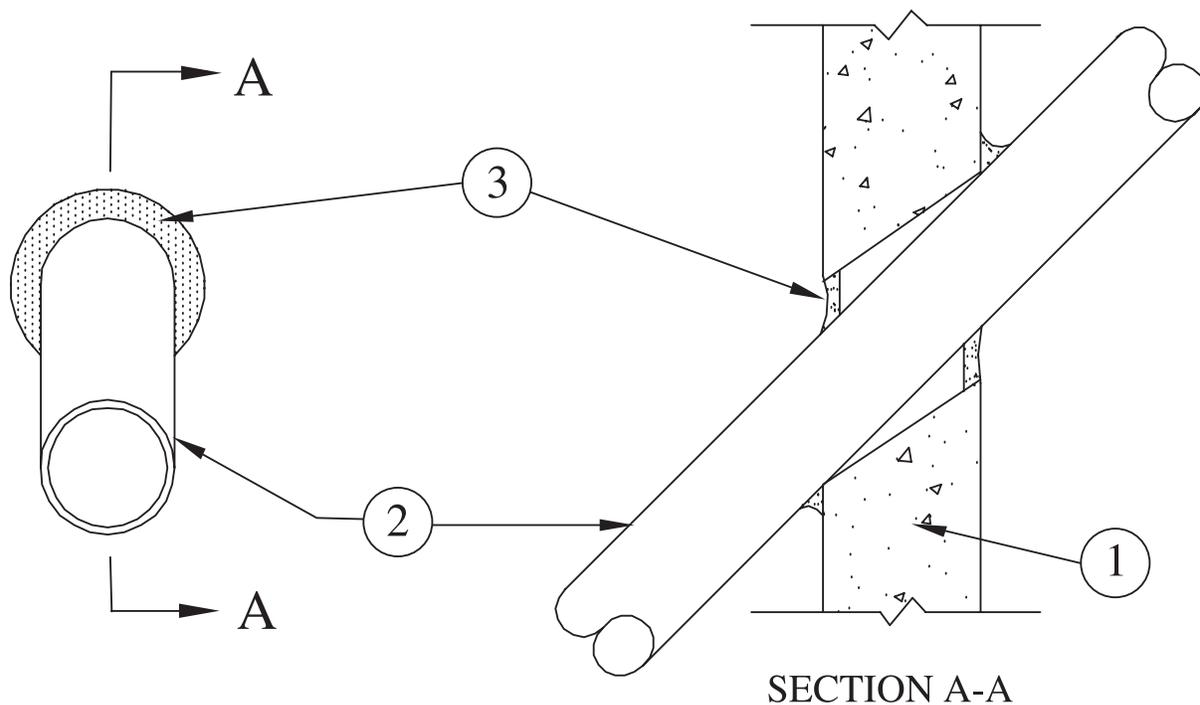

- Wall Assembly** – Min 6 in. (152 mm) thick reinforced lightweight or normal weight (100-150 pcf or 1600-2400 kg/m³) concrete wall. Wall may also be constructed of any UL Classified Concrete Blocks*. Max diam of opening is 12 in. (305 mm).
See **Concrete Blocks (CAZT)** category in the Fire Resistance Directory for names of manufacturers.
- Through Penetrants** – One metallic pipe, conduit or tubing installed concentrically or eccentrically within opening. Annular space between penetrant and periphery of opening to be min 0 in. (0 mm) (point contact) to max 3-1/2 in. (89 mm). The penetrant may be installed at an angle not greater than 45 degrees from perpendicular. Penetrant to be rigidly supported on both sides of wall. The following types and sizes of penetrants may be used:
 - Steel Pipe** – Nom 8 in. (203 mm) diam (or smaller) Schedule 10 (or heavier) steel pipe.
 - Iron Pipe** – Nom 8 in. (203 mm) diam (or smaller) cast or ductile iron pipe.
 - Conduit** – Nom 4 in. (102 mm) diam (or smaller) steel electrical metallic tubing (EMT) or nom 6 in. (152 mm) rigid steel conduit.
 - Copper Tubing** – Nom 4 in. (102 mm) diam (or smaller) Type L (or heavier) copper tubing.
 - Copper Pipe** – Nom 4 in. (102 mm) diam (or smaller) Regular (or heavier) copper pipe.
- Fill, Void or Cavity Material* – Caulk or Sealant** – Min 5/8 in. (16 mm) thickness of caulk applied within annulus, flush with both surfaces of wall. Min 1/2 in. (13 mm) diam bead of caulk applied to concrete/penetrant interface at point contact location on both sides of wall.

3M COMPANY – CP 25WB+, IC 15WB+ caulk or FB-3000 WT sealant.

*Bearing the UL Classification Marking

Reprinted from the Online Certifications Directory with permission from Underwriters Laboratories Inc.
Copyright © 2010 Underwriters Laboratories Inc.®



Through Penetrations

Metallic Pipes

1000 Series

Concrete

WJ

System No. W-J-1156

November 25, 2003

F Rating – 2 Hr

T Rating – 0 Hr

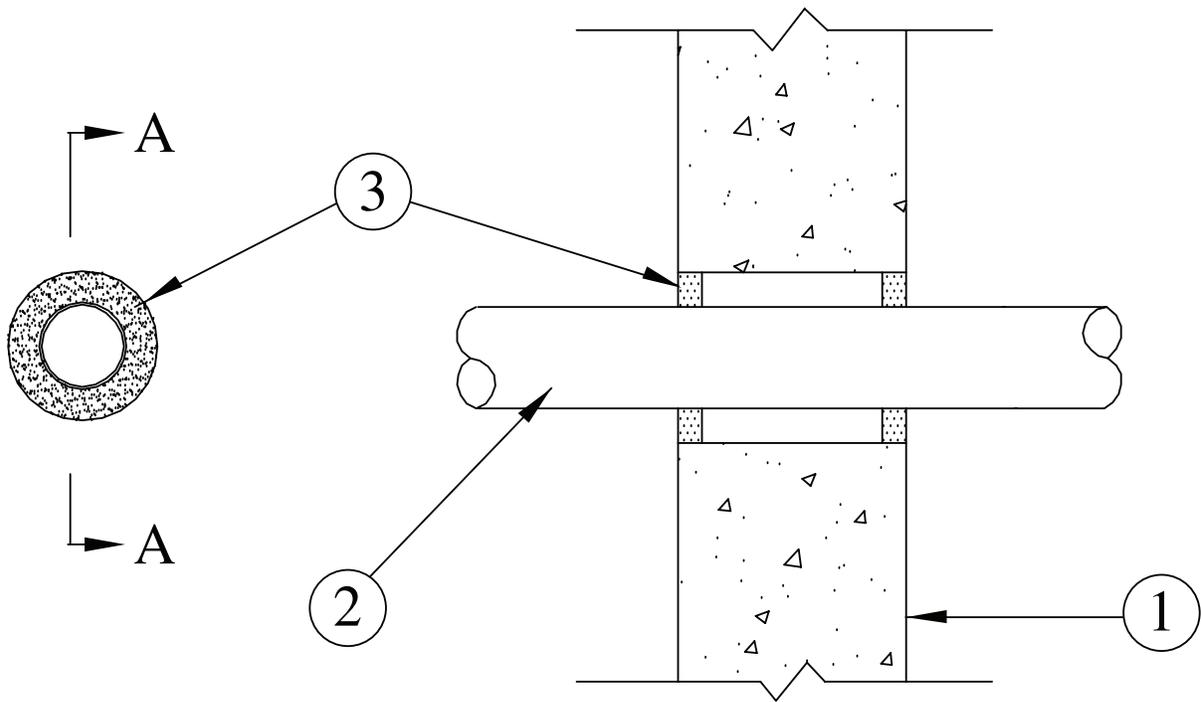

SECTION A-A

- Wall Assembly** – Min 6 in. (152 mm) thick reinforced lightweight or normal weight (100-150 pcf or 1600-2400 kg/m³) concrete wall. Wall may also be constructed of any UL Classified Concrete Blocks*. Diam of opening to be min 1/2 in. (13 mm) to max 4 in. (102 mm) greater than outside diam of through-penetrant.
See **Concrete Blocks (CAZT)** category in the Fire Resistance Directory for names of manufacturers.
- Through Penetrants** – One metallic pipe, conduit or tubing centered within opening. Annular space between penetrant and periphery of opening to be min 1/4 in. (6 mm) to max 2 in. (51 mm). Penetrant to be rigidly supported on both sides of wall. The following types and sizes of penetrants may be used:
 - Steel Pipe** – Nom 6 in. (152 mm) diam (or smaller) Schedule 10 (or heavier) steel pipe.
 - Iron Pipe** – Nom 6 in. (152 mm) diam (or smaller) cast or ductile iron pipe.
 - Conduit** – Nom 4 in. (102 mm) diam (or smaller) steel electrical metallic tubing (EMT) or nom 6 in. (152 mm) rigid steel conduit.
 - Copper Tubing** – Nom 3 in. (76 mm) diam (or smaller) Type L (or heavier) copper tubing.
 - Copper Pipe** – Nom 3 in. (76 mm) diam (or smaller) Regular (or heavier) copper pipe.
- Fill, Void or Cavity Material* – Sealant** – Min 5/8 in. (16 mm) thickness of sealant applied within annulus, flush with both surfaces of wall.
3M COMPANY – FB-1000 NS

*Bearing the UL Classification Marking

Reprinted from the Online Certifications Directory with permission from Underwriters Laboratories Inc.

Copyright © 2010 Underwriters Laboratories Inc.®



System No. W-J-1205

December 02, 2008

F Rating – 2 Hr

T Rating – 0 Hr

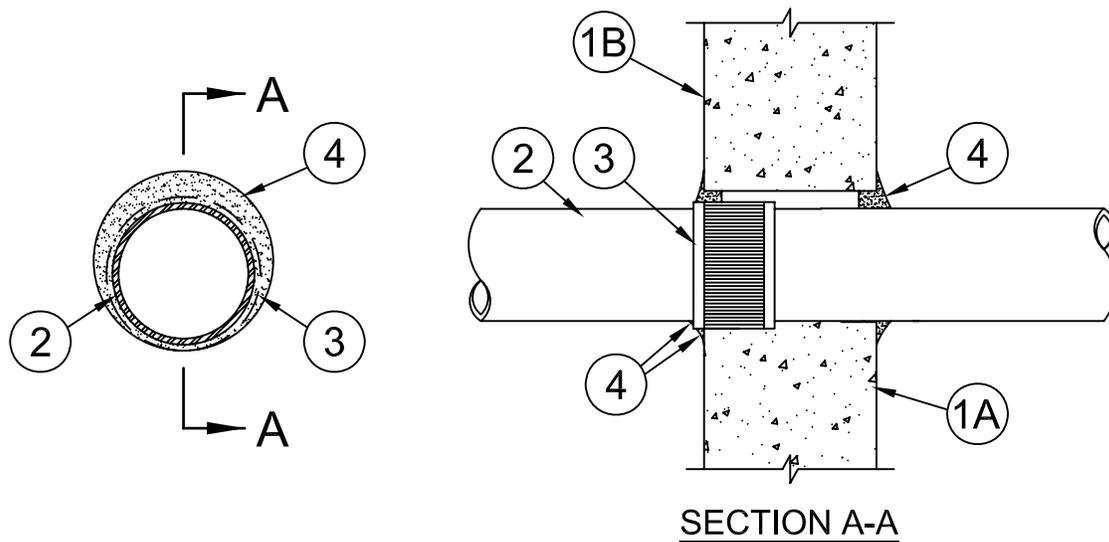

1. **Wall Assembly** – Min 6 in. (152 mm) thick reinforced lightweight or normal weight (100-150 pcf or 1600-2400 kg/m³) concrete. Wall may also be constructed of any UL Classified **Concrete Blocks***. Max diam of opening is 5-1/2 in. (140 mm).
See **Concrete Blocks** (CAZT) category in the Fire Resistance Directory for names of manufacturers.
2. **Through Penetrant** – One metallic pipe to be installed eccentrically or concentrically within the firestop system. Pipe to be rigidly supported on both sides of the wall assembly. The following types and sizes of metallic pipes may be used:
 - A. **Steel Pipe** – Nom 4 in. (102 mm) diam (or smaller) Schedule 10 (or heavier) steel pipe.
 - B. **Iron Pipe** – Nom 4 in. (102 mm) diam (or smaller) cast or ductile iron pipe.
3. **Compression Coupling** – Metallic pipes to be secured together with compression type pipe coupling with elastomeric gasket and a stainless steel jacket with stainless steel band clamps. Coupling to be installed partially within opening with min 1/2 in. (13 mm) of coupling protruding from wall. The annular space between the pipe or coupling and the periphery of the opening shall be min 0 in. (0 mm, point contact) to max 1/2 in. (13 mm).
4. **Fill, Void or Cavity Material* – Caulk or Sealant** – Min 5/8 in. (16 mm) thickness of fill material applied within annulus, flush with each surface of the wall assembly. Where annular space ranges from point contact to 1/4 in. (6 mm) wide a min 1/2 in. (13 mm) diam bead of fill material is to be applied at the coupling/wall or pipe/wall interface on both sides of wall. An additional min 1/8 in. (3.2 mm) diam bead of fill material is to be applied at the end of the compression coupling at the coupling/pipe interface where the coupling extends outside of the wall.

3M COMPANY

3M FIRE PROTECTION PRODUCTS – IC 15WB+, CP 25WB+ or FB-3000 WT

*Bearing the UL Classification Mark

Reprinted from the Online Certifications Directory with permission from UL

© 2012 UL LLC



System No. W-J-1218

April 07, 2009

F Rating – 2 Hr

T Rating – 0 Hr

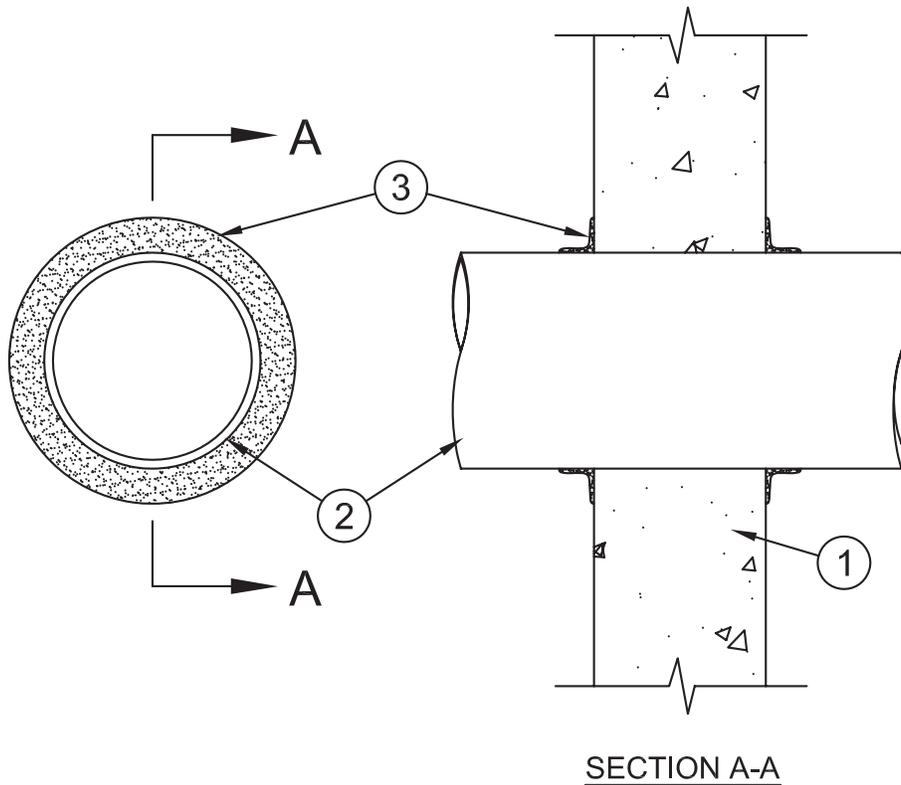

- Wall Assembly** – Min 6 in. (152 mm) thick reinforced lightweight or normal weight (100-150 pcf or 1600-2400 kg/m³) concrete. Wall may also be constructed of any UL Classified **Concrete Blocks***. Max diam of opening is 12-3/4 in. (324 mm).
See **Concrete Blocks (CAZT)** category in the Fire Resistance Directory for names of manufacturers.
- Through-Penetrant** – One metallic pipe, conduit or tubing installed within the firestop system. The through penetrant to be installed with continuous point contact. Pipe, conduit or tubing to be rigidly supported on both sides of wall assembly. The following types and sizes of metallic pipes, conduits or tubing may be used:
 - Steel Pipe** – Nom 12 in. (305 mm) (diam (or smaller) Schedule 10 (or heavier) steel pipe.
 - Iron Pipe** – Nom 12 in. (305 mm) diam (or smaller) service weight (or heavier) cast iron soil pipe or Class 50 (or heavier) ductile iron pressure pipe.
 - Conduit** – Nom 6 in. (152 mm) diam (or smaller) galv steel conduit or nom 4 in. (102 mm) diam (or smaller) steel electrical metallic tubing.
 - Copper Tubing** – Nom 6 in. (152 mm) diam (or smaller) Type L (or heavier) copper tubing.
 - Copper Pipe** – Nom 6 in. (152 mm) diam (or smaller) Regular (or heavier) copper pipe.
- Fill, Void or Cavity Material*** – **Caulk** – Bead of fill material lapping min 1 in. (25 mm) onto concrete and min 1/2 in. (13 mm) onto penetrant around outer circumference of through penetrant on both surfaces of wall assembly

3M COMPANY

3M FIRE PROTECTION PRODUCTS – CP 25WB+ Caulk, IC 15WB+ Caulk, FB-3000 WT Sealant

*Bearing the UL Classification Mark

Reprinted from the Online Certifications Directory with permission from Underwriters Laboratories Inc.
Copyright © 2010 Underwriters Laboratories Inc.®



Through Penetrations

Metallic Pipes

1000 Series

Concrete

WJ

System No. W-J-1229

November 02, 2012

ANSI/UL1479 (ASTM E814)

F Rating – 2 Hr

T Rating – 0 Hr

CAN/ULC S115

F Rating – 2 Hr

FT Rating – 0 Hr

FH Rating – 2 Hr

FTH Rating – 0 Hr

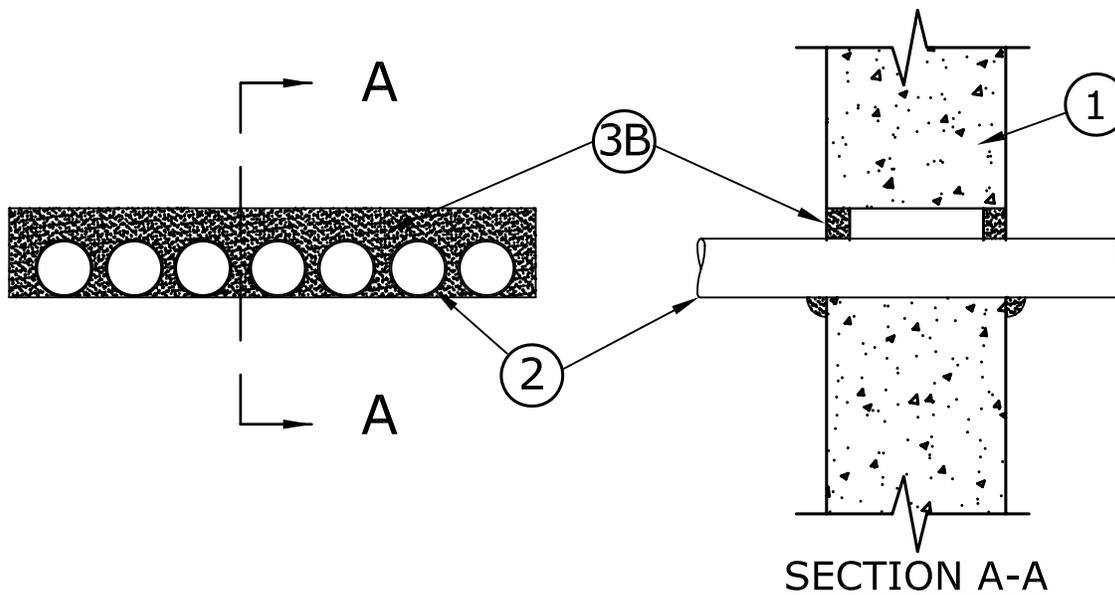

1. **Wall Assembly** – Min 6 in. (152 mm) thick reinforced lightweight or normal weight (100-150 pcf or 1600-2400 kg/m³) concrete. Wall may also be constructed of any UL Classified **Concrete Blocks***. Max height of opening is 6 in. (152 mm). Max width of opening is 36 in. (914 mm).

See **Concrete Blocks** (CAZT) category in the Fire Resistance Directory for names of manufacturers.

2. **Through Penetrants** – Multiple tubes, pipes or conduits installed in single layer array within the firestop system. The annular space between the penetrants and the edges of the opening shall be min 0 in. (point contact) to max 2 in. (51 mm). The separation between penetrants to be min 1-1/4 in. (32 mm) to max 2 in. (51 mm). Penetrants to be rigidly supported on both sides of wall assembly. The following types and sizes of penetrants may be used:
 - A. **Steel Pipe** – Nom 4 in. (102 mm) diam (or smaller) Schedule 5 (or heavier) steel pipe.
 - B. **Conduit** – Nom 4 in. (102 mm) diam (or smaller) rigid steel conduit or steel electrical metallic tubing (EMT).
 - C. **Iron Pipe** – Nom 4 in. (102 mm) diam (or smaller) cast or ductile iron pipe.
 - D. **Copper Tubing** – Nom 4 in. (102 mm) diam (or smaller) Type L (or heavier) copper tubing.
 - E. **Copper Pipe** – Nom 4 in. (102 mm) diam (or smaller) Regular (or heavier) copper pipe.
3. **Firestop System** – The firestop system shall consist of the following:
 - A. **Forming Material** – (Optional, Not Shown) – Foam backer rod, mineral wool batt insulation or glass fiber insulation packed into opening and recessed min 1-1/4 in. (32 mm) from each surface of the wall to accommodate fill material.
 - B. **Fill Void or Cavity Materials* – Sealant** – Min 1-1/4 in. (32 mm) thickness of fill material installed to completely fill annular space between penetrants and gypsum board, flush with each surface of wall. Min 1/4 in. diam bead of fill material applied to the penetrant/wall interface at the point contact locations on both sides of the wall.

3M COMPANY

3M FIRE PROTECTION PRODUCTS – IC 15WB+, CP 25WB+ caulk or FB-3000 WT sealant

*Bearing the UL Classification Mark

Reprinted from the Online Certifications Directory with permission from UL
© 2013 UL LLC



System No. W-J-1231

August 20, 2013

ANSI/UL1479 (ASTM E814)

F Rating – 2 Hr

T Rating – 3/4 Hr

CAN/ULC S115

F Rating – 2 Hr

FT Rating – 3/4 Hr

FH Rating – 2 Hr

FTH Rating – 3/4 Hr

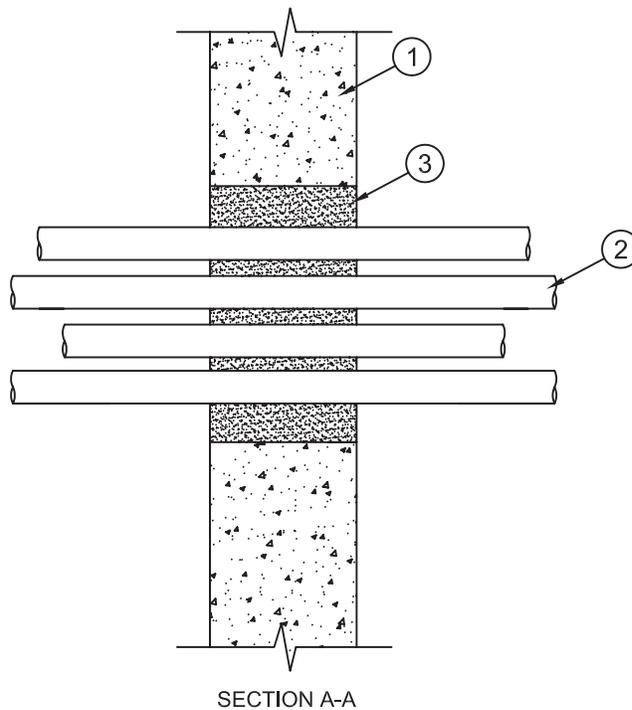
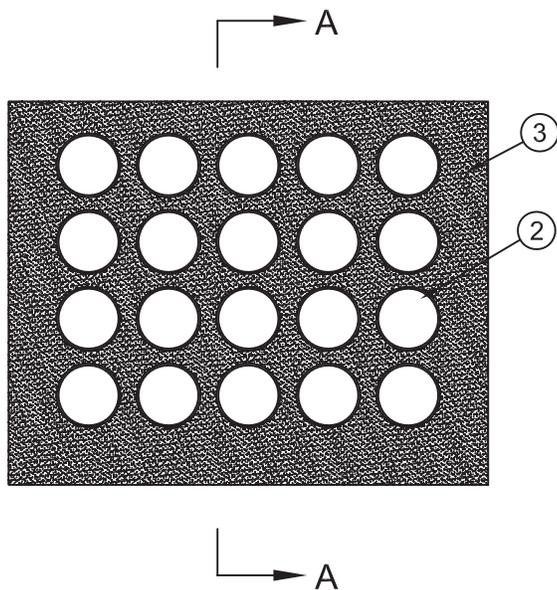

1. **Wall Assembly** – Min 6 in. (152 mm) thick reinforced lightweight or normal weight (100-150 pcf or 1600 - 2400 kg/m³) concrete wall. Wall may also be constructed of any UL Classified **Concrete Blocks***. Max area of opening is 720 in² (4645 cm²) with max dimension of 30 in. (762 mm).
See **Concrete Blocks** (CAZT) in the Fire Resistance Directory for names of manufacturers.
2. **Through Penetrant** – One or more metallic penetrants to be installed within the opening. The annular space between penetrants shall be min 1 in. (25 mm) to max 2 in. (51 mm). The annular space between penetrants and periphery of opening shall be min 1 in. (25 mm) to max 3 in. (76 mm). Penetrants to be rigidly supported on both sides of wall assembly. The following types and sizes of penetrants may be used:
A. **Conduit** – Nom 4 in. (102 mm) diam (or smaller) steel electrical metallic tubing or 4 in. (102 mm) diam (or smaller) steel conduit.
3. **Fill, Void or Cavity Material* – Foam** – Foam fill material shall be applied to completely fill the annular space between penetrants and between penetrants and periphery of wall opening to the full thickness of the wall.

3M COMPANY 3M FIRE PROTECTION PRODUCTS – Fire Barrier Rated Foam, FIP 1-Step

*Bearing the UL Classification Mark

Reprinted from the Online Certifications Directory with permission from UL
© 2013 UL LLC



System No. W-J-1232

August 01, 2013

ANSI/UL1479 (ASTM E814)

F Ratings – 2 Hr

T Rating – 1/2 Hr

L Rating at Ambient - Less than 1 CFM/sq ft

L Rating at 400 F - Less than 1 CFM/sq ft

CAN/ULC S115

F Ratings – 2 Hr

FT Rating – 1/2 Hr

FH Ratings – 2 Hr

FTH Rating – 1/2 Hr

L Rating at Ambient - Less than 1 CFM/sq ft

L Rating at 400 F - Less than 1 CFM/sq ft

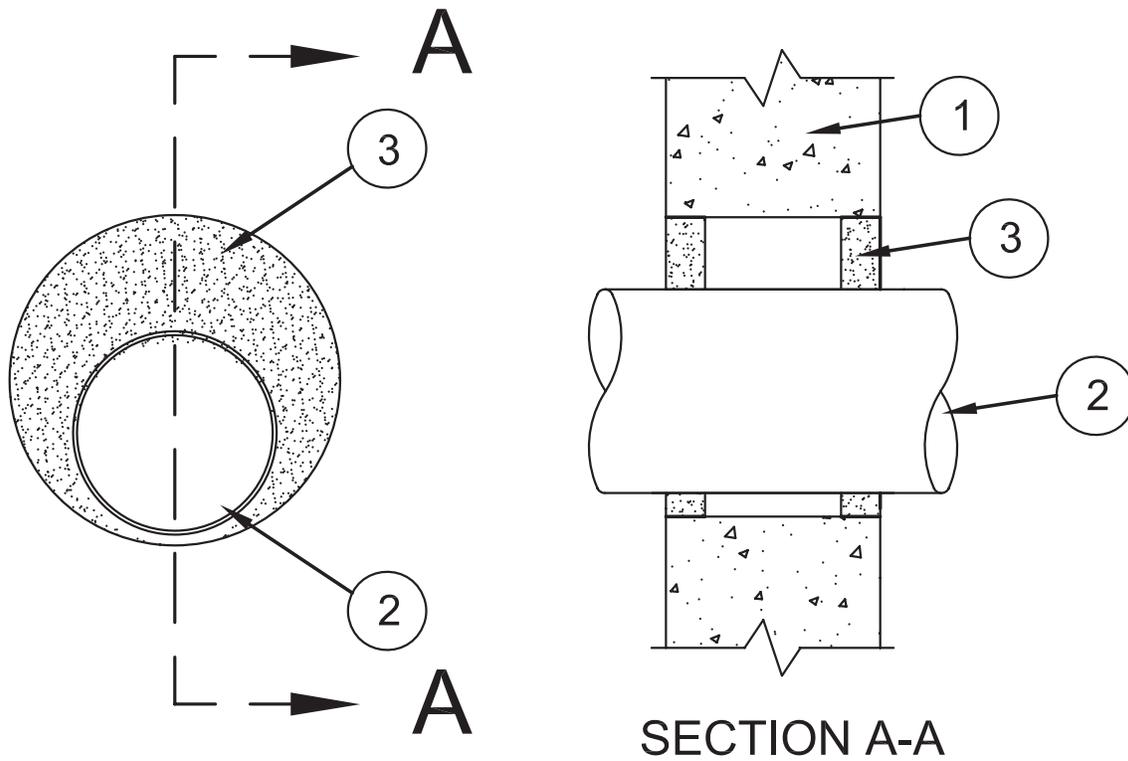

- Wall Assembly** – Min 6 in. (152 mm) thick reinforced lightweight or normal weight (100-150 pcf or 1600 - 2400 kg/m³) concrete wall. Wall may also be constructed of any UL Classified **Concrete Blocks***. Max diam of opening is 12-1/2 in. (318 mm). See **Concrete Blocks** (CAZT) in the Fire Resistance Directory for names of manufacturers.
- Through-Penetrant** – One metallic pipe, conduit or tubing installed either concentrically or eccentrically within the firestop system. The annular space between pipe, conduit or tubing and periphery of opening shall be min of 1/2 in. (13 mm) to max 3-3/8 in. (86 mm). Pipe, conduit or tubing to be rigidly supported on both sides of wall assembly. The following types and sizes of metallic pipes, conduits or tubing may be used:
 - Steel Pipe** – Nom 8 in. (203 mm) diam (or smaller) Schedule 10 (or heavier) steel pipe.
 - Iron Pipe** – Nom 8 in. (203 mm) diam (or smaller) service weight (or heavier) cast iron soil pipe, nom 12 in. diam (or smaller) or Class 50 (or heavier) ductile iron pressure pipe.
 - Conduit** – Nom 6 in. (152 mm) diam (or smaller) steel conduit or nom 4 in. (102 mm) diam (or smaller) steel electrical metallic tubing.
 - Copper Tubing** – Nom 4 in. (102 mm) diam (or smaller) Type L (or heavier) copper tubing.
 - Copper Pipe** – Nom 4 in. (102 mm) diam (or smaller) Regular (or heavier) copper pipe.
- Fill, Void or Cavity Material*** – **Foam** – Min 1-1/4 in. (32 mm) thickness of fill material applied within the annulus, flush with both surfaces of wall.

3M COMPANY – Fire Barrier Rated Foam, FIP 1-Step

*Bearing the UL Classification Mark

Reprinted from the Online Certifications Directory with permission from UL
© 2013 UL LLC



System No. W-J-1247

May 20, 2014

ANSI/UL1479 (ASTM E814)

F Rating — 2 Hr
T Rating — 1/2 Hr

CAN/ULC S115

F Rating — 2 Hr
FT Rating — 1/2 Hr
FH Rating — 2 Hr
FTH Rating — 1/2 Hr

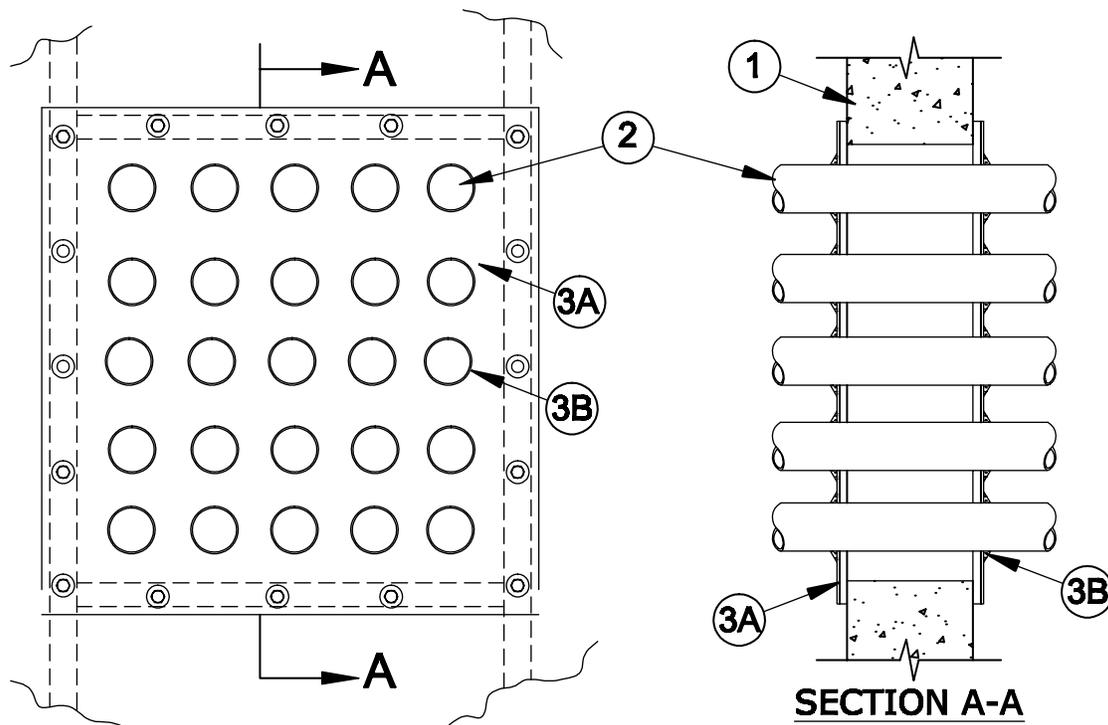

- Wall Assembly** — Min 6 in. (152 mm) thick reinforced lightweight or normal weight (100-150 pcf or 1600-2400 kg/m³) concrete wall. Wall may also be constructed of any UL Classified solid core **Concrete Blocks***. Max area of opening in the wall is 720 in² (4645 cm²) with a max dimension of 30 in. (762 mm).

See **Concrete Blocks (CAZT)** in the Fire Resistance Directory for names of manufacturers.

- Metallic Penetrants** — One or more penetrants may be installed within the through opening. The space between penetrants shall be min 1 in. (25 mm). The space between penetrants and periphery of opening shall be min 0 in. (point contact). Penetrants to be rigidly supported on both sides of wall assembly. The following types and sizes of metallic penetrants may be used:

A. **Tubing** — Nom 6 in. (152 mm) diam (or smaller) electrical metallic tubing (EMT). A maximum of one tube within the opening shall exceed nom 4 in. (102 mm) diam.

- Firestop System** — The firestop system shall consist of the following:

A. **Fill, Void or Cavity Materials* — Intumescent Sheet** — Rigid aluminum foil-faced sheet with galv sheet steel backer applied over opening at each side of wall. Sheets cut to tightly-follow the contours of the individual metallic penetrants. Sheets cut to lap a min of 2 in. (51 mm) on the wall on all sides of the opening on both sides of the wall. Prior to installation, a min 1/2 in. (13 mm) diam bead of putty (Item 3B) shall be applied as a gasket approx 1 in. (25 mm) from and on all sides of the through opening. Sheet to be installed with the galv sheet steel backer exposed (aluminum foil facing against wall surface) and secured to wall with min 1/4 in. (6 mm) diam by 2-1/4 in. (57 mm) long steel masonry anchors in conjunction with min 1-1/4 in. (32 mm) diam steel washers. Max spacing of fasteners not to exceed 6 in. (152 mm) with one fastener in each corner. See Item 3C below for splicing of sheets.

3M COMPANY — Type CS-195+

B. **Fill, Void or Cavity Material* — Putty** — Min 1/2 in. (13 mm) diam bead of putty applied to edge of intumescent sheet at its interface with surface of wall around entire perimeter of through opening. In addition, min 1/2 in. (13 mm) bead of putty applied around periphery of each penetrant at its egress from the intumescent sheet on each side of wall.

3M COMPANY — MP+ Stix putty

C. **Steel Cover Strip** — (Not Shown) - Intumescent sheets (Item 3A) may be spliced. Min 2 in. (51 mm) wide strip of min 0.020 in. (0.51 mm) thick (26 gauge) galv steel centered over entire length of each butted seam or slit made in the intumescent sheet. Prior to installation of the steel strip, the seam or slit in the intumescent sheet shall be covered with a nom 1/4 in. (6 mm) diam bead of sealant or caulk (Item 3D). Steel cover strip secured to galv steel sheet backer of intumescent sheet with steel sheet metal screws or steel rivets spaced max 3 in. (76 mm) OC on each side of seam or slit.

D. **Fill, Void or Cavity Materials* — Caulk or Sealant (Not Shown)** — Used with Item 3C. Prior to installation of the steel strip (Item 3C), the seam or slit in the intumescent sheet shall be covered with a min 1/4 in. (6 mm) diam bead of sealant or caulk.

3M COMPANY — CP 25WB+, IC 15WB+ caulk or FB-3000 WT sealant

*Bearing the UL Classification Mark

Reprinted from the Online Certifications Directory with permission from UL

© 2014 UL LLC





UL System No. W-J-1281
XHEZ – Through-penetration Firestop Systems
XHEZ7 – Through-penetration Firestop Systems Certified for Canada

March 22, 2017

| ANSI/UL1479 (ASTM E814) | CAN/ULC S115 |
|-------------------------|-------------------|
| F Rating – 2 Hr | F Rating – 2 Hr |
| T Rating – 0 Hr | FT Rating – 0 Hr |
| | FH Rating – 2 Hr |
| | FTH Rating – 0 Hr |

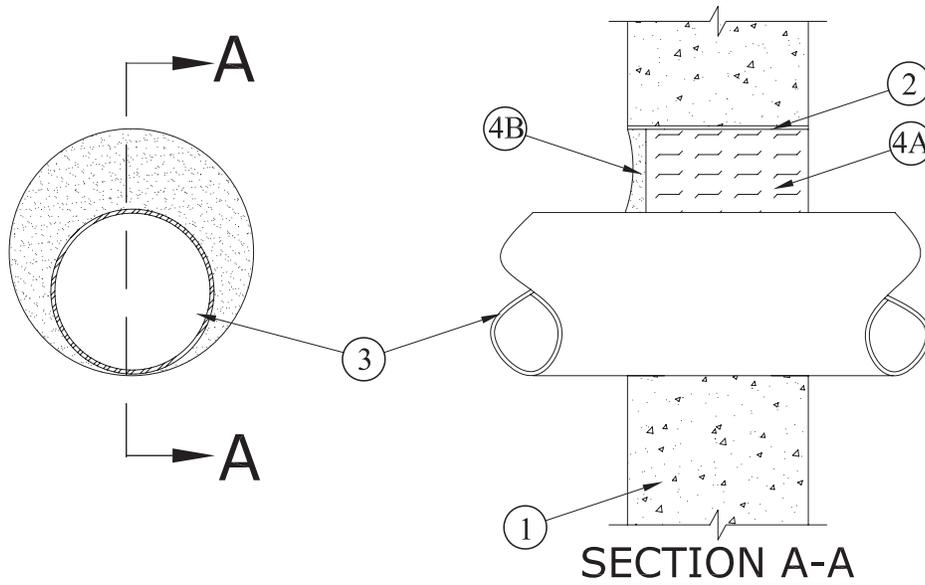

- Wall Assembly** – Min 5 in. (127 mm) thick reinforced lightweight or normal weight (100-150 pcf or 1600-2400 kg/m³) concrete. Wall may also be constructed of any UL Classified Concrete Blocks*. Max diam of opening is 10-1/2 in. (267 mm)
 See **Concrete Blocks** (CAZT) in the Fire Resistance Directory for names of manufacturers.
- Steel Sleeve** – (Optional) - Cylindrical sleeve fabricated from min 0.019 in. (0.49 mm) thick (28 gauge) galv sheet steel and having a min 2 in. (51 mm) lap along the longitudinal seam. Length of steel sleeve to be equal to thickness of wall or up to 2 in. (51 mm) longer than the thickness of wall such that, when installed, the ends of the sleeve will be flush with wall surface or project up to 1 in. (25 mm) beyond the surface of the wall on each side of the wall assembly. Sleeve installed by coiling the sheet steel to a diam smaller than the max 10-1/2 in. (254 mm) diam through opening, inserting the coil through the opening and releasing the coil to let it uncoil against both surfaces of the wall.
- Through Penetrants** – One metallic pipe, tubing or conduit installed within the firestop system. Penetrant to be rigidly supported on both sides of wall assembly. Annular space between the penetrant and sleeve shall be min 0 in. (0 mm point contact) to max 2 in. (51 mm). The following types of metallic pipes or conduits may be used:
 - Steel Pipe** – Nom 8 in. (203 mm) schedule 5 (or heavier) steel pipe.
 - Iron Pipe** – Nom 8 in. (203 mm) cast or ductile iron pipe.
 - Copper Tubing** – Nom 4 in. (102 mm) Type L (or heavier) copper tubing.
 - Copper Pipe** – Nom 4 in. (102 mm) Regular (or heavier) copper pipe.
 - Conduit** – Nom 4 in. (102 mm) (or smaller) steel electrical metallic tubing or nom 6 in. (152 mm) (or smaller) rigid steel conduit.
- Firestop System** – The firestop system shall consist of the following:
 - Packing Material** – Min 4-3/8 in. (111 mm) thickness of min 4 pcf (64 kg/m³) mineral wool batt insulation firmly packed into opening as a permanent form. Packing material to be recessed from either or both surfaces of wall to accommodate the required thickness of fill material.
 - Fill, Void or Cavity Materials*-Caulk or Sealant** – Min 5/8 in. (16 mm) thickness of caulk applied within annulus, flush with either or both surfaces of wall assembly.
3M COMPANY – IC 15WB+, CP-25 WB+ caulk or FB-3000 WT sealan

*Indicates such products shall bear the UL or cUL Certification Mark for jurisdictions employing the UL or cUL Certification (such as Canada), respectively.

Reprinted from the Online Certifications Directory with permission from UL©

3M Industrial Adhesive and Tapes
 Fire Protection Products
 3M Center, Building 230-B-S-37
 St. Paul, MN 55144-1000





UL System No. W-J-1282
XHEZ – Through-penetration Firestop Systems
XHEZ7 – Through-penetration Firestop Systems Certified for Canada

January 08, 2018

| ANSI/UL1479 (ASTM E814) | CAN/ULC S115 |
|-------------------------|-------------------|
| F Rating – 2 Hr | F Rating – 2 Hr |
| T Rating – 0 Hr | FT Rating – 0 Hr |
| | FH Rating – 2 Hr |
| | FTH Rating – 0 Hr |

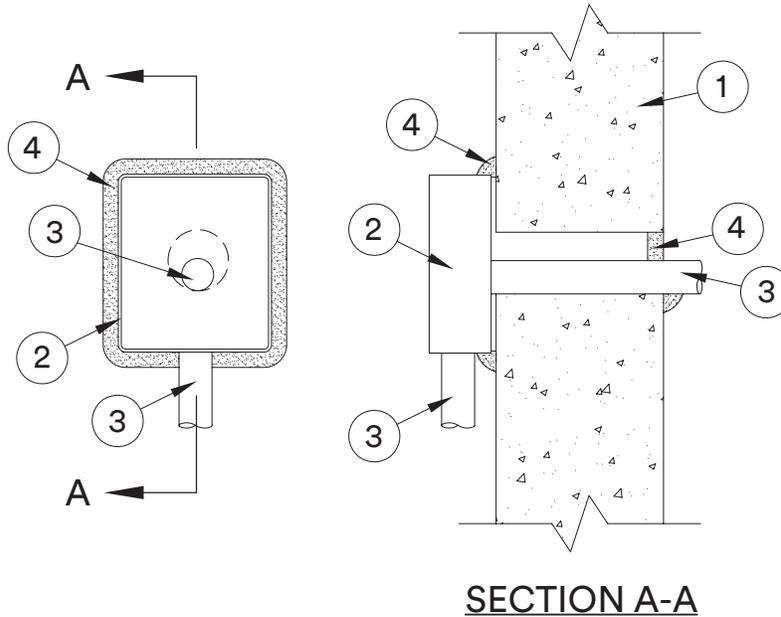

- 1. Wall Assembly** – Min 6 in. (152 mm) thick lightweight or normal weight (100-150 pcf or 1600-2400 kg/m³) concrete. Wall may also be constructed of any UL Classified **Concrete Blocks***. Diam of opening to be 1/2 in. (13 mm) to 1 in. (25 mm) larger than outside diam of through penetrant (Item 3). Max diam of opening is 2-1/4 in. (57 mm).
See **Concrete Blocks** (CAZT) in the Fire Resistance Directory for names of manufacturers.
 - 2. Pull or Junction Box+** – Min 16 ga steel pull or junction box mounted flush with or max 1/4 in. (6 mm) from surface of wall.
See **Junction and Pull Boxes** (BGUZ) category in the Electrical Construction Material Directory for names of manufacturers.
 - 3. Conduit** – One nom 1 in. (25 mm) diam (or smaller) steel conduit or steel electrical metallic tubing to be installed either concentrically or eccentrically within the firestop system. The annular space shall be min 0 in. (point contact) to max 1 in. (25 mm). Conduit or EMT to be secured to back surface of pull or junction box with steel connector and rigidly supported on both sides of wall assembly.
 - 4. Fill, Void or Cavity Material* – Sealant** – Min 5/8 in. (16 mm) thickness of sealant applied within the annulus, flush with surface of wall opposite the pull or junction box. When Putty is used, the min thickness of fill material within the annulus shall be 1 in. (25 mm). In addition, a min 1/2 in. (13 mm) diam bead of fill material shall be applied at the point contact location between the conduit and wall. A min 1/2 in. (13 mm) diam bead of fill material shall be applied around the entire perimeter of the pull or junction box at its interface with the wall surface. The fill material shall lap min 1/2 in. (13 mm) onto both the wall and the sides of the pull or junction box.
- 3M COMPANY 3M FIRE PROTECTION PRODUCTS** – FD 150+ Sealant, IC 15 WB+ Caulk, CP 25WB+ Caulk, 1000 NS Sealant or FB-3000 WT Sealant or 3M Fire Barrier Moldable Putty Stix MP+

+Bearing the UL Listing Mark

*Indicates such products shall bear the UL or cUL Certification Mark for jurisdictions employing the UL or cUL Certification (such as Canada), respectively.

Reprinted from the Online Certifications Directory with permission from UL©



Through Penetrations
 Metallic Pipes
 1000 Series
 WJ



UL System No. W-J-1283
XHEZ – Through-penetration Firestop Systems
XHEZ7 – Through-penetration Firestop Systems Certified for Canada

April 25, 2017

| ANSI/UL1479 (ASTM E814) | CAN/ULC S115 |
|-------------------------|-------------------|
| F Rating – 2 Hr | F Rating – 2 Hr |
| T Rating – 0 Hr | FT Rating – 0 Hr |
| | FH Rating – 2 Hr |
| | FTH Rating – 0 Hr |

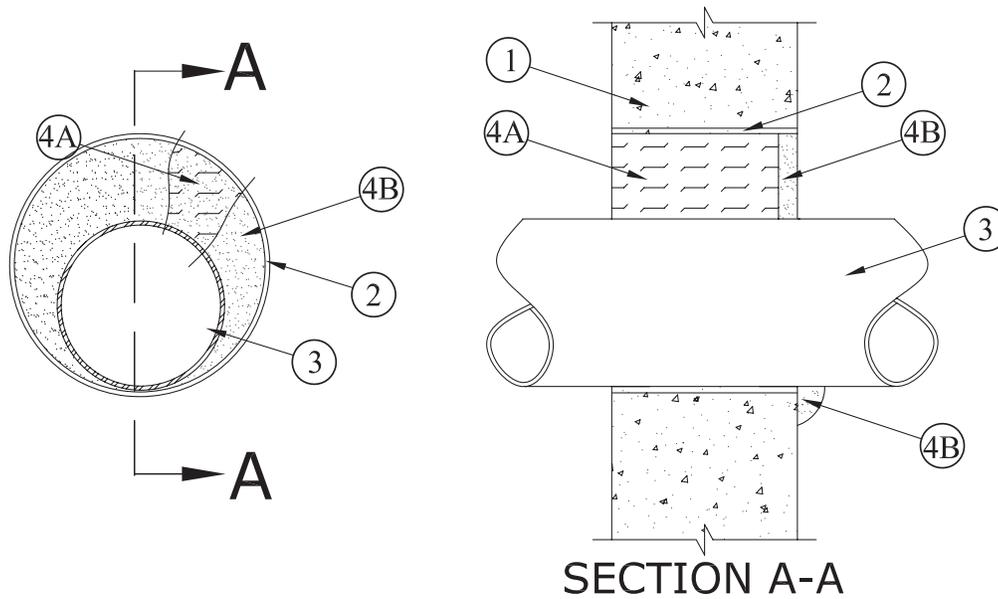

- Wall Assembly** – Min 6 in. (152 mm) thick lightweight or normal weight (100-150 pcf or 1600-2400 kg/m³) concrete. Wall may also be constructed of any UL Classified solid filled Concrete Blocks*. Maximum diam of opening is 11 in. (279 mm).
See **Concrete Blocks** (CAZT) in the Fire Resistance Directory for names of manufacturers.
 - Metallic Sleeve** – (Optional) - Cylindrical sleeve fabricated from min No. 30 gauge galv sheet steel and having a min 2 in. (51 mm) lap along the longitudinal seam. Length of the sleeve to be equal to the thickness of the wall. The ends of the steel sleeve shall be flush with each surface of the wall.
 - Through Penetrant** – One metallic pipe, tube or conduit installed concentrically or eccentrically within the firestop system. The annular space between the pipe, tube or conduit and the periphery of the sleeved opening to be min 0 in. (0 mm, point contact) to max 2-3/8 in. (60 mm). Pipe, tube or conduit to be rigidly supported on both sides of wall assembly. One of the following types and sizes of pipe, tube or conduit may be used:
 - Steel Pipe** – Nom 8 in. (203 mm) diam (or smaller) Schedule 5 (or heavier) steel pipe.
 - Iron Pipe** – Nom 8 in. (203 mm) diam (or smaller) cast or ductile iron pipe.
 - Conduit** – Nom 4 in. (102 mm) diam (or smaller) rigid steel conduit, steel electrical metallic tubing (EMT) or flexible steel conduit.
 - Copper Pipe or Tube** – Nom 4 in. (102 mm) diam (or smaller) Regular (or heavier) copper pipe or Type M (or heavier) copper tube.
 - Firestop System** – The firestop system consist of the following items:
 - Packing Material** – A. Packing Material — Min 4 pcf (64 kg/m³) mineral wool batt insulation firmly packed into sleeve or opening as a permanent form. Packing material to extend throughout thickness of wall except for a 5/8 in. (16 mm) deep recess on one side of wall to accommodate the fill material.
 - Fill Void or Cavity Materials* – Caulk or Sealant** – Min 5/8 in. (16 mm) thickness of fill material applied within sleeve or opening, flush with surface of wall. At the point contact location, a min 3/8 in. (10 mm) diam bead of fill material shall be applied at the penetrant/ opening interface.
- 3M COMPANY 3M FIRE PROTECTION PRODUCTS** – FB-1000 NS Sealant, IC 15WB+ Caulk, CP 25WB+ Caulk or FB-3000 WT Sealant

*Indicates such products shall bear the UL or cUL Certification Mark for jurisdictions employing the UL or cUL Certification (such as Canada), respectively.
 Reprinted from the Online Certifications Directory with permission from UL©



Metallic Pipes • Gypsum

| 3M UL Systems | "F" Rating | 3M Product | Through Penetrant Details |
|---------------|------------|---|--|
| W-L-1001 | 1, 2, 3, 4 | 3M™ Fire Barrier Sealant CP 25WB+ | 12" steel, cast iron, 6" conduit or EMT, 6" copper. Also referred as WL1001. |
| W-L-1003 | 1, 2 | 3M™ Fire Barrier Sealant CP 25WB+ 3M™ Fire Barrier Sealant IC 15WB+ 3M™ Fire Barrier Water Tight Sealant 3000 WT | 12" steel, 12", cast iron, 6" conduit, 6" copper, 4" EMT, 28 gauge steel sleeve. Concentric or eccentric installation. Point contact to max 2-3/4" annular. Max opening 15 in. U300, U400, or V400 series walls. 1&2 hour F rating. No T rating. Also known as WL1003. |
| W-L-1009 | 2 | 3M™ Fire Barrier Silicone Sealant 2000+ 3M™ Fire Barrier Water Tight Sealant 1000 NS | U300 or U400 Series gypsum wall. Max 12 in. steel, max 4 in. EMT, max 4 in. conduit, max 2 in. copper tubing. Max diam of opening 14-1/4 in. Concentric installation. 3/4 in. annular. 2 hour F rating. Also known as WL1009. |
| W-L-1010 | 2 | 3M™ Fire Barrier Silicone Sealant 2000+ 3M™ Fire Barrier Water Tight Sealant 1000 NS | U300 or U400 Series gypsum wall. Max 24 in. steel, max 4 in. EMT, max 4 in. conduit, max 2 in. copper tubing. Max diam of opening dependent upon penetrant and stud type. Concentric installation. 3/4 in. annular. 2 hour F rating. Also known as WL1010. |
| W-L-1016 | 2 | 3M™ Fire Barrier Sealant CP 25WB+ | 3" steel or EMT: 12" 28 gauge steel sleeve. Also referred as WL1016. |
| W-L-1017 | 1, 2 | 3M™ Fire Barrier Sealant CP 25WB+ | 4" steel or aluminum flexible conduit. Also referred as WL1017. |
| W-L-1032 | 2 | 3M™ Fire Barrier Sealant CP 25WB+ | 2" aluminum flexible conduit. Also referred as WL1032. |
| W-L-1037 | 2 | 3M™ Fire Barrier Sealant CP 25WB+ 3M™ Fire Barrier Sealant IC 15WB+ 3M™ Fire Barrier Composite Sheet CS-195+ 3M™ Fire Barrier Wrap Strips FS-195+ 3M™ Fire Barrier Moldable Putty Stix MP+ 3M™ Expantrol™ Flexible Intumescent Strip E-FIS | 2" steel, EMT or copper. Also referred as WL1037. |
| W-L-1073 | 1, 2 | 3M™ Fire Barrier Sealant CP 25WB+ | 4" steel or aluminum flexible conduit: 28 gauge steel sleeve. Also referred as WL1073. |
| W-L-1077 | 2 | 3M™ Fire Barrier Sealant CP 25WB+ | 1" flexible metal piping. Also referred as WL1077. |
| W-L-1080 | 2 | 3M™ Fire Barrier Moldable Putty Stix MP+ | 4" steel, EMT, cast iron, conduit, 2" copper. Also referred as WL1080. |
| W-L-1082 | 2 | 3M™ Fire Barrier Silicone Sealant 2000+ | 12" steel, 6" conduit, 6" copper, 4" EMT. Also referred as WL1082. |
| W-L-1084 | 1 | 3M™ Fire Barrier Silicone Sealant 2000+ | 12" steel, 6" EMT, conduit, 6" copper. Also referred as WL1084. |
| W-L-1096 | 2 | 3M™ Fire Barrier Sealant CP 25WB+ | 1" flexible metal piping. Also referred as WL1096. |
| W-L-1112 | 1 | 3M™ Fire Barrier Sealant CP 25WB+ | 2 in. flexible metallic piping penetrating a 1 hour rated gypsum wallboard assembly. |
| W-L-1133 | 1 | 3M™ Fire Barrier Sealant CP 25WB+ | 6 in. steel, 6 in. cast or ductile iron, 4 in. EMT or steel conduit. Max diam of opening 11-1/2 in. Concentric or eccentric installation. Point contact to max 7/8 in. annular between pipe covering and opening. 12 in. long 2 in. thick fiberglass jacketing required. 1 hour F Rating. Caulk only system. Also known as WL1133. |
| W-L-1137 | 1 | 3M™ Fire Barrier Wrap Strips FS-195+ 3M™ Fire Barrier Moldable Putty Stix MP+ 3M™ Fire Barrier Sealant CP 25WB+ 3M™ Fire Barrier Water Tight Sealant 3000 WT | Max 6 in. No. 11 MSG aluminum pipe with beverage lines of max 12 1/2 PE and max 2 1/2 in. copper bundled within 3/4 in. AB/PVC or max 10 3/8 polyolefin tubes bundles within PVC jacket and 3/4 in. AB/PVC insulation. Up to 45 degree angle. Sleeve required. Max opening 1/2 in. larger than OD of sleeve. See system for annular. 1 hour F. Also known as WL1137. |
| W-L-1146 | 1, 2 | 3M™ Fire Barrier Sealant CP 25WB+ | 24" steel, iron, cast iron, 6" conduit, copper tubing, copper pipe, 4" EMT. Also referred as WL1146. |
| W-L-1157 | 1, 2 | 3M™ Fire Barrier Water Tight Sealant 1000 NS | 24" schedule 10 steel, iron, 6" copper tubing or copper pipe. Also referred as WL1157. |
| W-L-1166 | 1, 2 | 3M™ Fire Barrier Sealant CP 25WB+ 3M™ Fire Barrier Moldable Putty Stix MP+ 3M™ Fire Barrier Water Tight Sealant 3000 WT | 4" copper tubing or pipe, steel pipe, conduit, iron, EMT. Also referred as WL1166. |
| W-L-1167 | 1, 2 | 3M™ Fire Barrier Sealant FD 150+ | 12" steel, cast iron, 4" EMT, 4" copper tubing or pipe, 6" conduit. Also referred as WL1167. |
| W-L-1202 | 4 | 3M™ Fire Barrier Sealant CP 25WB+ | 24" steel, cast, iron, 6" conduit, 4" EMT, 6" copper. Also referred as WL1202. |
| W-L-1228 | 1, 2 | 3M™ Fire Barrier Sealant CP 25WB+ 3M™ Fire Barrier Sealant IC 15WB+ | Multiple 2" steel conduit, EMT. Also referred as WL1228. |

Metallic Pipes • Gypsum

| 3M UL Systems | "F" Rating | 3M Product | Through Penetrant Details |
|---------------|------------|--|--|
| W-L-1255 | 1, 2 | 3M™ Fire Barrier Sealant CP 25WB+ 3M™ Fire Barrier Moldable Putty Stix MP+ 3M™ Fire Barrier Pillows 3M™ Fire Barrier Self-Locking Pillows | 4" EMT multiple, 225 sq. in., 22-1/2" maximum. Also referred as WL1255. |
| W-L-1287 | 1, 2 | 3M™ Fire Barrier Sealant CP 25WB+ 3M™ Fire Barrier Sealant IC 15WB+ | Multiple 3" steel, iron, cast, 2" copper tubing or pipe, 2" flexible metal piping. Also referred as WL1287. |
| W-L-1296 | 1, 2 | 3M™ Fire Barrier Sealant CP 25WB+ 3M™ Fire Barrier Sealant IC 15WB+ 3M™ Fire Barrier Water Tight Sealant 3000 WT | 8" steel, 8" iron, 8" cast iron, 6" rigid steel conduit, 4" EMT, 4" conduit, 4" copper tubing or pipe. See system for metal gas piping details. U300, U400, V400 series walls. Point contact to max 2 in. annular. Max opening 10-5/8". Concentric or eccentric installation. Optional 28 ga. steel sleeve. 1 & 2 hour F rating. See system for T rating. Also known as WL1296. |
| W-L-1299 | 1, 2 | 3M™ Fire Barrier Sealant CP 25WB+ 3M™ Fire Barrier Sealant IC 15WB+ | Multiple max. 3" steel pipes or conduits through max. 182 sq. in. with max. dimension of 14-1/2". Also referred as WL1299. |
| W-L-1310 | 2 | 3M™ Fire Barrier Sealant CP 25WB+ 3M™ Fire Barrier Sealant IC 15WB+ 3M™ Fire Barrier Water Tight Sealant 3000 WT | Single metallic pipe penetrating a 2 hour rated gypsum shaft wall assembly. Single side installation utilizing a steel sleeve, mineral wool, and sealant on the finished side of the wall only. |
| W-L-1323 | 2 | 3M™ Fire Barrier Sealant CP 25WB+ 3M™ Fire Barrier Moldable Putty Stix MP+ 3M™ Fire Barrier Duct Wrap 615 3M™ Fire Barrier Duct Wrap 615+ | Max 10 in. steel, max 10 iron, max 4 in. copper tubing, max 4 in. copper pipe. U300 or U400 series walls. Max diameter of opening 12-3/4 in. Point contact to 2 in. annular space. Concentric/ eccentric installation. 3M Fire Barrier Duct Wrap 20A or 615 or 615+ to extend min. 24 in. from each surface of wall assembly. Also known as WL1323. |
| W-L-1340 | 1, 2 | 3M™ Fire Barrier Sealant CP 25WB+ 3M™ Fire Barrier Sealant IC 15WB+ | 8" steel, 8" iron, 4" EMT, 6" rigid steel conduit, 4" copper pipe or tubing. Max opening 12". Concentric or eccentric installation. Angle of installation up to 45 degrees from perpendicular. Annular point contact to max 3-1/2". 1 & 2 hr. F. Also known as WL1340. |
| W-L-1341 | 1, 2 | 3M™ Fire Barrier Water Tight Sealant 1000 NS | 6" steel, 6" iron, 4" EMT, 6" rigid steel conduit, 3" copper pipe or tubing. Diam of opening min 1/2" to max 4" greater than outside diam of penetrant. Penetrant centered. Annular min 1/4" to max 2". 1 & 2 hr F. Also known as WL1341. |
| W-L-1353 | 1, 2 | 3M™ Fire Barrier Sealant CP 25WB+ 3M™ Fire Barrier Sealant IC 15WB+ | 2" steel, 2" iron, 2" copper pipe, 2" copper tubing penetrates one side of wall. Penetrant connected to metal tee for closed or vented systems. Point contact to max 1" annular. 1 & 2 Hour F Rating. Also known as WL1353. |
| W-L-1391 | 1, 2, 3, 4 | 3M™ Fire Barrier Pass-Through Products 3M™ Fire Barrier Water Tight Sealant 3000 WT 3M™ Fire Barrier Sealant CP 25WB+ 3M™ Fire Barrier Sealant IC 15WB+ 3M™ Fire Barrier Moldable Putty Stix MP+ | Square device: max area 98-1/2 sq. in. w/ max dimension of 12-1/8 in. Round device: max diam of opening 4-1/2 in. One or more penetrants through each device w/ concentric or eccentric installation. Max 3 in. steel, max 3 in. iron, max 3 in. copper tubing, max 3 in. copper pipe, max 3 in. EMT, max 1-4 in. flexible metal piping. Max 6 square devices ganged or 1 round. 1 and 2 hour F. Also known as WL1391. |
| W-L-1413 | 1, 2 | 3M™ Fire Barrier Sealant CP 25WB+ 3M™ Fire Barrier Water Tight Sealant 3000 WT | Max 8 in. steel, max 8 in. iron, max 6 in. conduit, max 4 in. EMT, max 6 in. copper tubing, max 6 in. copper pipe. Max diam of opening 10 in. U400 or V400 series gypsum shaft wall assembly. Concentric or eccentric installation. Point contact to max 2 in. annular. 1 and 2 hour F rating. Caulk only system. Also known as WL1413. |
| W-L-1414 | 1, 2 | 3M™ Fire Barrier Sealant CP 25WB+ 3M™ Fire Barrier Water Tight Sealant 3000 WT | Max 3 in. steel, max 3 in. iron, max 3 in. conduit, max 3 in. EMT, max 3 in. copper tubing, max 3 in. copper pipe, max 1 in. flexible metal piping. Max diam of opening 4-1/2 in. U400 or V400 series gypsum shaft wall assembly. Multiple penetrants. Concentric or eccentric installation. Point contact to max 2 in. annular. 1/4 to 1 in. space between penetrants. 1 & 2 hour F rating. Also known as WL1414. |
| W-L-1426 | 1, 2 | 3M™ Fire Barrier Sealant CP 25WB+ 3M™ Fire Barrier Water Tight Sealant 3000 WT 3M™ Fire Barrier Sealant IC 15WB+ | U300, U400 or V400 wall. Max 4 in. steel, max 4 in. cast iron, max 4 in. ductile iron. Concentric or eccentric installation. Max diam of opening 5-1/2 in. Compression coupling installed partially in opening with min 1/2 in. protruding. Point contact to max 1/2 in. annular space. Caulk only system. 1 & 2 hour F. Also known as WL1426. |
| W-L-1450 | 1, 2 | 3M™ Fire Barrier Sealant IC 15WB+ 3M™ Fire Barrier Sealant CP 25WB+ 3M™ Fire Barrier Water Tight Sealant 3000 WT | Max 12 in. steel, max 12 in. iron, max 6 in. steel conduit, max 4 in. EMT, max 6 in. copper tubing, max 6 in. copper pipe. Min 6 in. Gypsum wall. Max diam of opening 12-3/4 in. Continuous point contact only. 2 hour F rating. Also known as WL1450. |

Metallic Pipes • Gypsum

| 3M UL Systems | "F" Rating | 3M Product | Through Penetrant Details |
|---------------|------------|--|---|
| W-L-1453 | 1, 2 | 3M™ Fire Barrier Water Tight Sealant 3000 WT 3M™ Fire Barrier Water Tight Sealant 1000 NS | Max 8 in. steel, 8 in. iron, 4 in. conduit, 4 in. EMT, 4 in. copper. U400 or V400 gypsum shaft wall assembly. Max opening 11 in. Point contact to max 2-3/8 in. annular space. Concentric or eccentric installation. Min 30 gauge sleeve required. Mineral wool and sealant flush with gypsum side only. 1 and 2 hour F. Also known as WL1453. |
| W-L-1466 | 1, 2 | 3M™ Fire Barrier Water Tight Sealant 3000 WT 3M™ Fire Barrier Sealant CP 25WB+ 3M™ Fire Barrier Sealant IC 15WB+ | U300/U400/W400 gypsum wall. Max 6: max 4 in. steel, max 4 in. iron, max 4 in. conduit, max 4 in. EMT, max 4 in. copper pipe, max 4 in. copper tubing. Max area of opening 192 sq. in. with max dimension of 6 in. height. Concentric/eccentric installation. Point contact to max 1-7/8 in. Two-piece gypsum patch. 1 & 2 hour F. Also known as WL1466. |
| W-L-1474 | 2 | 3M™ Fire Barrier Water Tight Sealant 3000 WT 3M™ Fire Barrier Sealant CP 25WB+ 3M™ Fire Barrier Sealant IC 15WB+ | One or more in single row: max 4 in. steel, max 4 in. EMT, max 4 in. conduit, max 4 in. iron, max 4 in. copper tubing or pipe. U400, V400 or W400 series gypsum wallboard assembly. Max 6 in. high by max 36 in. wide opening. Point contact to max 2 in. annular. Penetrant spacing min 1-1/4 in. to max 2 in. 2 hour F rating. Optional backing material. Also known as WL1474. |
| W-L-1478 | 1, 2 | 3M™ Fire Barrier Rated Foam FIP 1-Step | One or more: max 4 in. EMT, max 4 in. steel conduit. U300, U400 or V400 gypsum wall with steel or wood studs. Max 720 sq. in. opening with max 30 in. dimension. Min 1 in. to max 3 in. annular. Spacing min 1 in. to max 2 in. apart. Framed opening. 1 and 2 hour F rating. See system for T rating. Also known as WL1478. |
| W-L-1479 | 2 | 3M™ Fire Barrier Rated Foam FIP 1-Step | Max 8 in. steel, max 8 in. iron, max 6 in. conduit, max 4 in. EMT, max 4 in. copper tubing, max 4 in. copper pipe. U400, V400 or W400 gypsum wallboard assemblies with steel studs. Max diameter of opening 12-1/2 in. Min 1/2 in. to max 3-3/8 in. annular space. Concentric/eccentric installation. 2 hour F rating. 1/2 hour T rating. Also known as WL1479. |
| W-L-1499 | 1, 2 | 3M™ Fire Barrier Sealant CP 25WB+ 3M™ Fire Barrier Sealant IC 15WB+ 3M™ Fire Barrier Moldable Putty Stix MP+ 3M™ Fire Barrier Water Tight Sealant 3000 WT 3M™ Fire Barrier Composite Sheet CS-195+ | U400, V400, or W400 series wall. 3-1/2 in. steel studs spaced max. 24 in. on center. One or more nominal 6 in. diameter electrical metallic tubing. A max. of one tube within opening shall exceed nominal 4 in. diameter. |
| W-L-1500 | 1, 2 | 3M™ Fire Barrier Moldable Putty Pads MPP+ | Max four station outlets for use in medical gas distribution in 1 or 2 hour gypsum wallboard/stud assembly constructed to U300, U400, or V400 designs. 1 or 2 hour F and T rating. Also known as WL1500 |
| W-L-1520 | 1, 2 | 3M™ Fire Barrier Pillows 3M™ Fire Barrier Self-Locking Pillows 3M™ Fire Barrier Rated Foam FIP 1-Step | U400, V400, or W400 series wall. 3-1/2 in. steel studs spaced max. 24 in. on center. One or more nominal 4 in. diameter electrical metallic tubing or steel conduit penetrating. |
| W-L-1521 | 1, 2 | 3M™ Fire Barrier Sealant FD 150+ 3M™ Fire Barrier Sealant IC 15WB+ 3M™ Fire Barrier Sealant CP 25WB+ 3M™ Fire Barrier Water Tight Sealant 3000 WT 3M™ Fire Barrier Water Tight Sealant 1000 NS | Steel pull box or junction box mounted flush with one surface of a 1 or 2 hour rated gypsum wallboard assembly. Max. 1 in. steel conduit or EMT exiting the box, penetrating the wall. |
| W-L-1524 | 1, 2 | 3M™ Fire Barrier Sealant FD 150+ 3M™ Fire Barrier Sealant IC 15WB+ 3M™ Fire Barrier Sealant CP 25WB+ 3M™ Fire Barrier Water Tight Sealant 3000 WT | Single metallic pipe penetrating a 1 or 2 hour rated gypsum wallboard assembly. Max. 12 in. steel or iron pipe, 6 in. steel conduit, 4 in. EMT or copper pipe. |
| W-L-1525 | 1, 2 | 3M™ Fire Barrier Sealant IC 15WB+ 3M™ Fire Barrier Sealant CP 25WB+ 3M™ Fire Barrier Water Tight Sealant 3000 WT | Single metallic pipe having max. 2 in. thick fiberglass insulation extending minimum 3-5/8 in. beyond both wall surfaces. Max. 8 in. steel or iron pipe, max. 4 in. copper pipe. |
| W-L-1526 | 1, 2 | 3M™ Fire Barrier Block 3M™ Fire Barrier Plank 3M™ Fire Barrier Rated Foam FIP 1-Step | Gypsum wallboard assembly with a 1080 sq. in. opening with max 36 in. dimension. Penetrating items are max 4 in. conduit or copper pipe and max 8 in. iron or steel pipe. |
| W-L-1528 | 1, 2 | 3M™ Fire Barrier Blocks 3M™ Fire Barrier Planks 3M™ Fire Barrier Sealant CP 25WB+ 3M™ Fire Barrier Water Tight Sealant 3000 WT | Multiple max. 4 in. steel or copper pipes/conduits, with one max. 8 in. steel pipe, penetrating the same max. 1296 square in. opening in a 1 or 2 hour rated gypsum wallboard assembly. |

System No. W-L-1001

June 15, 2005

F Ratings – 1, 2, 3 and 4 Hr (See Items 2 and 3)

T Ratings – 0, 1, 2, 3, and 4 Hr (See Item 3)

L Rating At Ambient – less than 1 CFM/sq ft

L Rating At 400 F – less than 1 CFM/sq ft

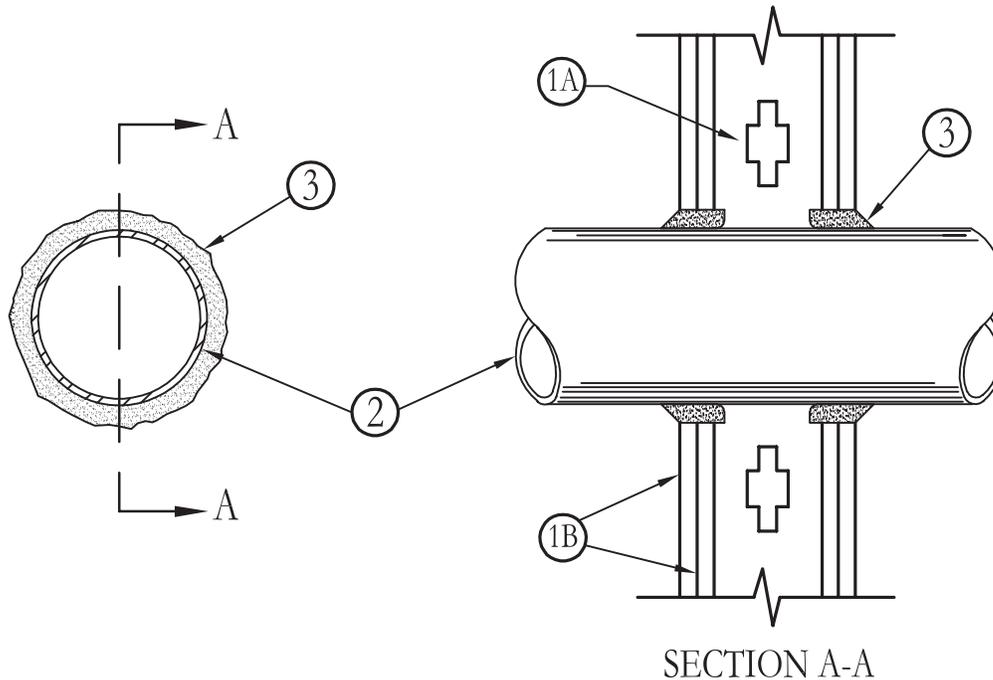

- Wall Assembly** – The 1, 2, 3 or 4 hr fire-rated gypsum wallboard/stud wall assembly shall be constructed of the materials and in the manner described in the individual U300 or U400 Series Wall or Partition Designs in the UL Fire Resistance Directory and shall include the following construction features:
 - Studs** – Wall framing may consist of either wood studs (max 2 hr fire rated assemblies) or steel channel studs. Wood studs to consist of nom 2 by 4 in. (51 by 102 mm) lumber spaced 16 in. (406 mm) OC with nom 2 by 4 in. (51 by 102 mm) lumber end plates and cross braces. Steel studs to be min 3-5/8 in. (92 mm) wide by 1-3/8 in. (35 mm) deep channels spaced max 24 in. (610 mm) OC.
 - Gypsum Board*** – Nom 1/2 or 5/8 in. (13 or 16 mm) thick, 4 ft. (122 cm) wide with square or tapered edges. The gypsum wallboard type, thickness, number of layers, fastener type and sheet orientation shall be as specified in the individual U300 or U400 Series Design in the UL Fire Resistance Directory. Max diam of opening is 26 in. (660 mm).
- Through Penetrant** – One metallic pipe, conduit or tubing installed either concentrically or eccentrically within the firestop system. The annular space between pipe, conduit or tubing and periphery of opening shall be min of 0 in. (0 mm) (point contact) to max 2 in. (51 mm). Pipe, conduit or tubing to be rigidly supported on both sides of wall assembly. The following types and sizes of metallic pipes, conduits or tubing may be used:
 - Steel Pipe** – Nom 24 in. (610 mm) diam (or smaller) Schedule 10 (or heavier) steel pipe.
 - Iron Pipe** – Nom 24 in. (610 mm) diam (or smaller) service weight (or heavier) cast iron soil pipe, nom 12 in. (305 mm) diam (or smaller) or Class 50 (or heavier) ductile iron pressure pipe.
 - Conduit** – Nom 6 in. (152 mm) diam (or smaller) steel conduit or nom 4 in. (102 mm) diam (or smaller) steel electrical metallic tubing
 - Copper Tubing** – Nom 6 in. (152 mm) diam (or smaller) Type L (or heavier) copper tubing
 - Copper Pipe** – Nom 6 in. (152 mm) diam (or smaller) Regular (or heavier) copper pipe.
 - Through Penetrating Product* – Flexible Metal Piping** – The following types of steel flexible metal gas piping may be used:
 - Nom 2 in. (51 mm) diam (or smaller) steel flexible metal gas piping. Plastic covering on piping may or may not be removed on both sides of floor or wall assembly.
OMEGA FLEX INC
 - Nom 1 in. (25 mm) diam (or smaller) steel flexible metal gas piping. Plastic covering on piping may or may not be removed on both sides of floor or wall assembly.
TITFLEX CORP
A BUNDY CO
 - Nom 1 in. (25 mm) diam (or smaller) steel flexible metal gas piping. Plastic covering on piping may or may not be removed on both sides of floor or wall assembly.
WARD MFG INC

Through Penetrations

Metallic Pipes

1000 Series

Gypsum

WL

System No. W-L-1001 *continued*

Through Penetrations

Metallic Pipes

1000 Series

Gypsum

W/L

3. **Fill, Void or Cavity Material* – Caulk or Sealant** – Min 5/8, 1-1/4, 1-7/8 and 2-1/2 in. (16, 32, 48 and 64 mm) thickness of caulk for 1, 2, 3 and 4 hr rated assemblies, respectively, applied within annulus, flush with both surfaces of wall. Min 1/4 in. (6 mm) diam bead of caulk applied to gypsum board/penetrant interface at point contact location on both sides of wall. The hourly F Rating of the firestop system is dependent upon the hourly fire rating of the wall assembly in which it is installed, as shown in the following table. The hourly T Rating of the firestop system is dependent upon the type or size of the pipe or conduit and the hourly fire rating of the wall assembly in which it is installed, as tabulated below:

| Max Pipe or Conduit Diam In. (mm) | F Rating Hr | T Rating Hr |
|--------------------------------------|----------------|----------------|
| 1 (25) | 1 or 2 | 0+, 1 or 2 |
| 1 (25) | 3 or 4 | 3 or 4 |
| 4 (102) | 1 or 2 | 0 |
| 6 (152) | 3 or 4 | 0 |
| 12 (305) | 1 or 2 | 0 |

+When copper pipe is used, T Rating is 0 hr.

3M COMPANY – CP 25WB+ caulk or FB-3000 WT sealant,

*Bearing the UL Classification Marking

Reprinted from the Online Certifications Directory with permission from Underwriters Laboratories Inc.
Copyright © 2010 Underwriters Laboratories Inc.®



System No. W-L-1003

February 14, 2008
F Ratings – 1 and 2 Hr (See Item 1)
T Rating – 0 Hr

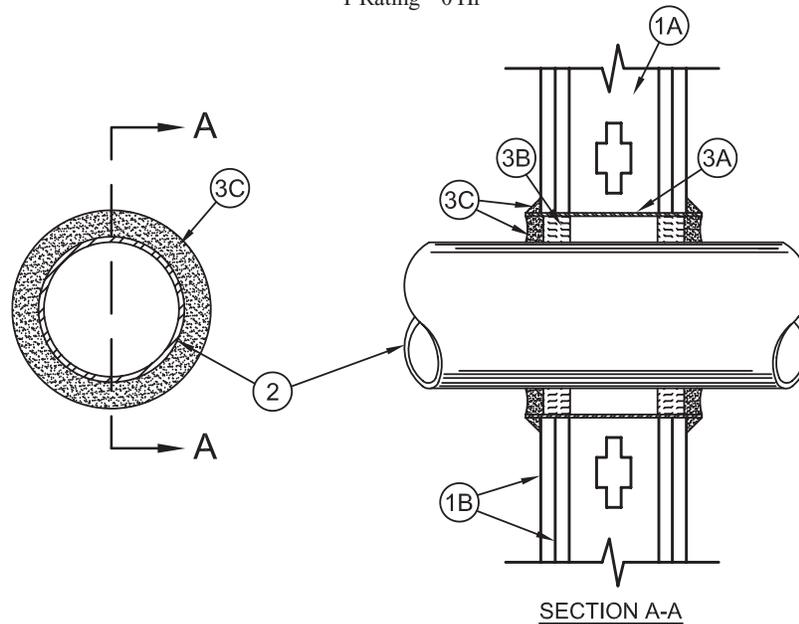

- Wall Assembly** – The 1 or 2 hr fire-rated gypsum board/stud wall assembly shall be constructed of the materials and in the manner described in the individual U300, U400 or V400 Series Wall and Partition Design in the UL Fire Resistance Directory and shall include the following construction features:
 - Studs** – Wall framing may consist of either wood studs or steel channel studs. Wood studs to consist of nom 2 by 4 in. (51 by 102 mm) lumber spaced 16 in. (406 mm) OC with nom 2 by 4 in. (51 by 102 mm) lumber end plates and cross braces. Steel studs to be min 3-1/2 in. (89 mm) wide by 1-3/8 in. (35 mm) deep channels spaced max 24 in. (610 mm) OC.
 - Gypsum Board*** – Nom 5/8 in. (16 mm) thick, 4 ft (1.2 m) wide with square or tapered edges. The gypsum board type, thickness, number of layers, fastener type and sheet orientation shall be as specified in the individual U300, U400 or V400 Series Design in the UL Fire Resistance Directory. Max diam of opening is 15 in. (381 mm).

The hourly F Rating of the firestop system is equal to the hourly fire rating of the wall assembly in which it is installed.
- Through Penetrant** – One metallic pipe, conduit or tubing to be installed either concentrically or eccentrically within the firestop system. The space between pipes, conduits or tubing and the steel sleeve (Item 3A) shall be min of 0 in. (point contact) to max 2-3/8 in. (60 mm). Pipe, conduit or tubing to be rigidly supported on both sides of wall assembly. The following types and sizes of metallic pipes, conduits or tubing may be used:
 - Steel Pipe** – Nom 12 in. (305 mm) diam (or smaller) Schedule 10 (or heavier) steel pipe.
 - Iron Pipe** – Nom 12 in. (305 mm) diam (or smaller) service weight (or heavier) cast iron soil pipe, nom 12 in. (305 mm) diam (or smaller) or Class 50 (or heavier) ductile iron pressure pipe.
 - Conduit** – Nom 6 in. (152 mm) diam (or smaller) steel conduit or nom 4 in. (102 mm) diam (or smaller) steel electrical metallic tubing.
 - Copper Tubing** – Nom 6 in. (152 mm) diam (or smaller) Type L (or heavier) copper tubing.
 - Copper Pipe** – Nom 6 in. (152 mm) diam (or smaller) Regular (or heavier) copper pipe.
- Firestop System** – Installed symmetrically on both sides of wall assembly. The details of the firestop system shall be as follows.
 - Steel Sleeve** – Cylindrical sleeve fabricated from min 0.019 in. thick (0.48 mm) galv sheet steel and having a min 2 in. (51 mm) lap along the longitudinal seam. Length of steel sleeve to be equal to thickness of wall plus 1 to 4 in. (25 to 102 mm) such that, when installed, the ends of the sleeve will project approx 1/2 to 2 in. (13 to 51 mm) beyond the surface of the wall on both sides of the wall assembly. Sleeve installed by coiling the sheet steel to a diam smaller than the through opening, inserting the coil through the openings and releasing the coil to let it uncoil against the circular cutouts in the gypsum board layers.
 - Packing Material** – Min 1 in. (25 mm) thickness of mineral wool batt insulation firmly packed into steel sleeve on both sides of the wall assembly as permanent forms. Packing material to be recessed min 1/2 in. (13 mm) from end of steel sleeve (flush with or recessed into gypsum board surface) on both sides of wall assembly.
 - Packing Material** – (Not shown) – As an alternate to Item B, nom 1 in. (25 mm) thick polyethylene backer rod may be used. The backer rod is to be recessed within the steel sleeve a min of 1 in. (25 mm) from each surface of wall.
 - Fill, Void or Cavity Materials* – Caulk or Sealant** – When mineral wool batt insulation is used, caulk or sealant applied to fill the steel sleeve to a min depth of 1/2 in. (13 mm) on both sides of wall assembly. When backer rod is used, a min thickness of 1 in. (25 mm) of caulk or sealant is required flush with both sides of wall. A nom 1/4 in. (6 mm) diam continuous bead of caulk or sealant shall be applied around the circumference of the steel sleeve at its egress from the gypsum board layers on both sides of the wall assembly.

3M COMPANY – CP 25WB+, IC 15WB+ or FB-3000 WT

*Bearing the UL Classification Mark

Reprinted from the Online Certifications Directory with permission from Underwriters Laboratories Inc.
Copyright © 2010 Underwriters Laboratories Inc.®



System No. W-L-1009

May 09, 2013

F Rating – 2 Hr

T Rating – 0 Hr

L Rating At Ambient – Less Than 1 CFM/sq ft

L Rating At 400 F – Less Than 1 CFM/sq ft

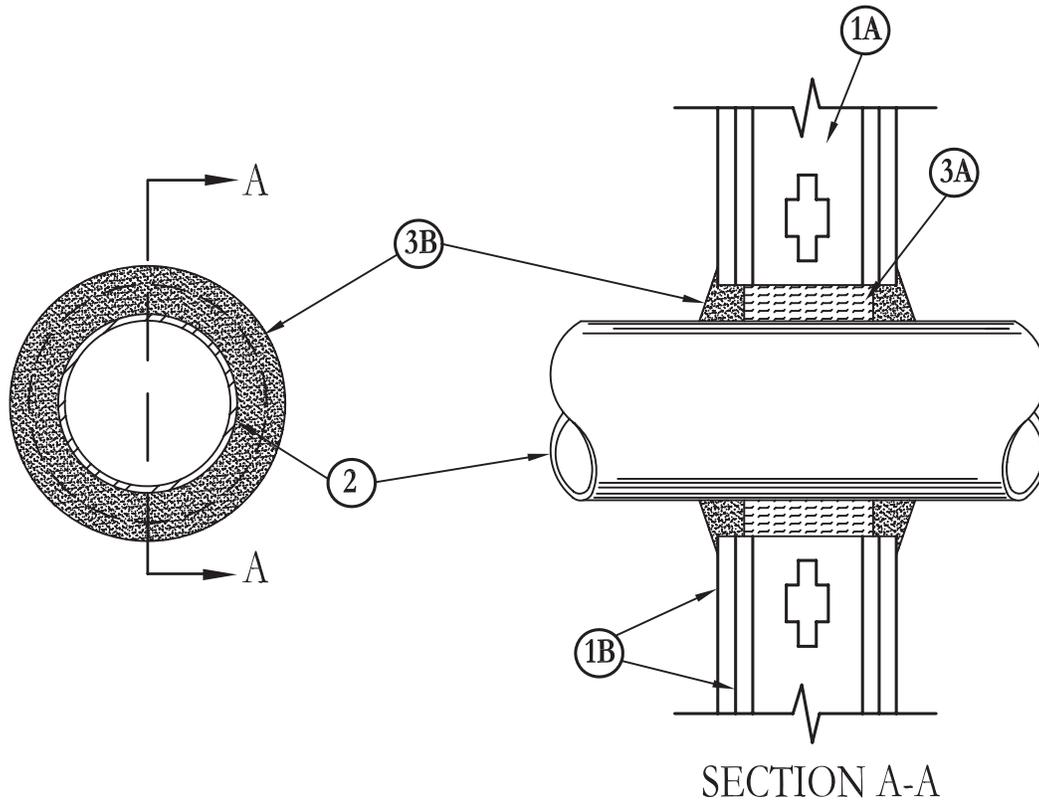

SECTION A-A

- Wall Assembly** – The fire rated gypsum wallboard/stud wall assembly shall be constructed of the materials and in the manner specified in the individual U300 or U400 Series Wall and Partition Designs in the UL Fire Resistance Directory and shall include the following construction features:
 - Studs** – Wall framing may consist of either wood studs or steel channel studs. Wood studs to consist of nom 2 by 4 in. (51 by 104 mm) lumber spaced 16 in. (406 mm) OC. Steel studs to be min 2-1/2 in. (64 mm) wide and spaced max 24 in. (610 mm) OC.
 - Gypsum Board*** – Two layers of nom 5/8 in. (16 mm) thick gypsum wallboard, as specified in the individual Wall and Partition Design. Max diam of opening is 14-1/4 in. (362 mm).
- Through Penetrants** – One metallic pipe, conduit or tubing to be centered within the firestop system. Pipe, conduit or tubing to be rigidly supported on both sides of wall assembly. The following types and sizes of metallic pipes, conduits or tubing may be used:
 - Steel Pipe** – Nom 12 in. (305 mm) diam (or smaller) Schedule 10 (or heavier) steel pipe. A nom annular space of 3/4 in. (19 mm) is required within the firestop system.
 - Steel Pipe** – Nom 4 in. (102 mm) diam (or smaller) Schedule 5 (or heavier) steel pipe. A nom annular space of 3/4 in. (19 mm) is required within the firestop system.
 - Conduit** – Nom 4 in. (102 mm) diam (or smaller) steel electrical metallic tubing or steel conduit. A nom annular space of 3/4 in. (19 mm) is required with the firestop system.
 - Copper Tubing** – Nom 2 in. (51 mm) diam (or smaller) Type L (or heavier) copper tubing. A nom annular space of 3/4 in. (19 mm) is required within the firestop system.
- Firestop System** – The firestop system shall consist of the following:
 - Packing Material** – Min 3 in. (76 mm) thickness of min 4 pcf (64 kg/m³) mineral wool batt insulation firmly packed into opening as a permanent form. Packing material to be recessed from both surfaces of wall as required to accommodate the required thickness of fill material.
 - Fill, Void or Cavity Material* – Sealant** – Min 1 in. (25 mm) thickness of fill material applied within the annulus on both surfaces of wall. Additional fill material to be installed such that a min 1/4 in. (6 mm) crown is formed around the penetrating item.

3M COMPANY – Types FB-1000 NS, FB-2000 or FB-2000+.

*Bearing the UL Classification Mark

Reprinted from the Online Certifications Directory with permission from UL

© 2013 UL LLC



System No. W-L-1010

May 09, 2013

F Rating – 2 Hr

T Rating – 0 Hr

L Rating At Ambient – Less Than 1 CFM/sq ft

L Rating At 400 F – Less Than 1 CFM/sq ft

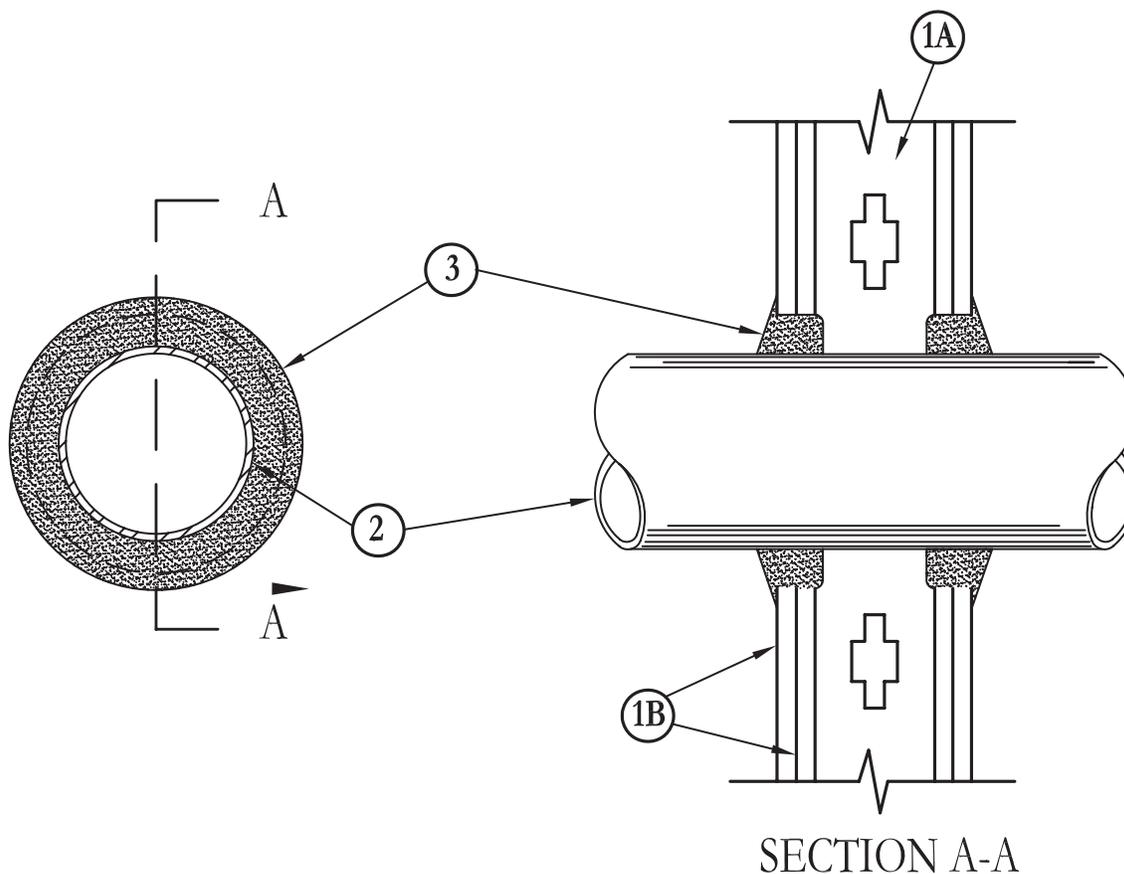

- Wall Assembly** – The fire rated gypsum wallboard/stud wall assembly shall be constructed of the materials and in the manner specified in the individual U300 or U400 Series Wall and Partition Designs in the UL Fire Resistance Directory and shall include the following construction features:
 - Studs** – Wall framing may consist of either wood studs or steel channel studs. Wood studs to consist of nom 2 by 4 in. (51 by 102 mm) lumber spaced 16 in. (406 mm) OC. Steel studs to be min 2-1/2 in. (64 mm) wide and spaced max 24 in. (610 mm) OC. When steel studs are used and the diam of opening exceeds the width of stud cavity, the opening shall be framed on all sides using lengths of steel stud installed between the vertical studs and screw-attached to the steel studs at each end. The framed opening in the wall shall be 4 to 6 in. (102 to 152 mm) wider and 4 to 6 in. (102 to 152 mm) higher than the diam of the penetrating item such that, when the penetrating item is centered in the opening, a 2 to 3 in. (51 to 76 mm) clearance is present between the penetrating item and the framing in all four sides.
 - Gypsum Board*** – Two layers of nom 5/8 in. (16 mm) thick gypsum wallboard, as specified in the individual Wall and Partition Design. Max diam of opening is 14-1/2 in. (368 mm) for wood stud walls and 25-1/2 in. (648 mm) for steel stud walls.
- Through Penetrants** – One metallic pipe, conduit or tubing to be centered within the firestop system. Pipe, conduit or tubing to be rigidly supported on both sides of wall assembly. The following types and sizes of metallic pipes, conduits or tubing may be used:
 - Steel Pipe** – Nom 24 in. (610 mm) diam (or smaller) Schedule 10 (or heavier) steel pipe. A nom annular space of 3/4 in. (19 mm) is required within the firestop system.
 - Steel Pipe** – Nom 4 in. (102 mm) diam (or smaller) Schedule 5 (or heavier) steel pipe. A nom annular space of 3/4 in. (19 mm) is required within the firestop system.
 - Conduit** – Nom 4 in. (102 mm) diam (or smaller) steel electrical metallic tubing or steel conduit. A nom annular space of 3/4 in. (19 mm) is required within the firestop system.
 - Copper Tubing** – Nom 6 in. (152 mm) diam (or smaller) Type L (or heavier) copper tubing. A nom annular space of 3/4 in. (19 mm) is required within the firestop system.
- Fill, Void or Cavity Material* – Sealant** – Min 1-1/4 in. (32 mm) thickness of fill material applied within the annulus on both surfaces of wall. Additional fill material to be installed such that a min 1/4 in. (6 mm) crown is formed around the penetrating item.

3M COMPANY – Types FB-1000 NS, FB-2000, FB-2000+.

*Bearing the UL Classification Mark

Reprinted from the Online Certifications Directory with permission from UL

© 2013 UL LLC



System No. W-L-1016

September 03, 2004

(Formerly System No. 322)

F Rating – 2 Hr

T Ratings – 1, 1-1/2 and 2 Hr (See Item 3)

L Rating At Ambient – 2 CFM/sq ft.

L Rating At 400 F – 1 CFM/sq ft.

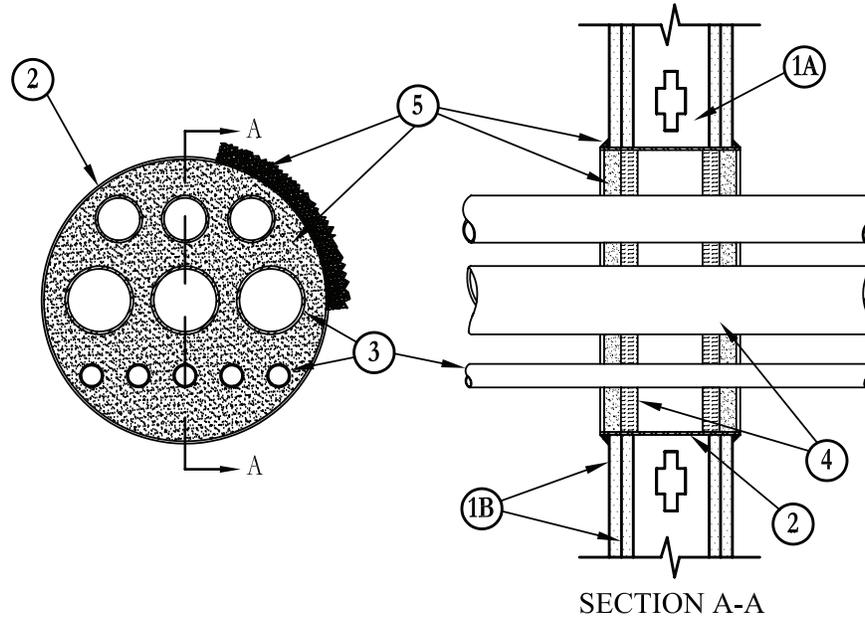

1. **Wall Assembly** – The fire-rated gypsum wallboard/stud wall assembly shall be constructed of the materials and in the manner described in the individual U300 or U400 Series Wall or Partition Design in the UL Fire Resistance Directory and shall include the following construction features:
 - A. **Studs** – Wall framing may consist of either wood studs or steel channel studs. Wood studs to consist of nom 2 by 4 in. lumber spaced 16 in. OC with nom 2 by 4 in. lumber end plates and cross braces. Steel studs to be min 3-5/8 in. wide by 1-3/8 in deep channels spaced max 24 in. OC.
 - B. **Gypsum Board*** – Two layers of nom 5/8 in. thick gypsum wallboard as specified in the individual Wall or Partition Design. Max diam of through openings cut in wallboard layers is 12 in. Max dimensions for rectangular opening is 12 in. by 9 in.
 - C. **Fasteners** – When wood stud framing is employed, gypsum wallboard attached to studs with cement coated nails as specified in the individual U300-Series design. When steel channel stud framing is employed, gypsum wallboard attached to studs with Type S self-drilling, self-tapping bugle-head steel screws as specified in the individual U400-Series design.
2. **Steel Sleeve** – No. 28 gauge galv sheet steel formed into max 12 in. diam or Max 12 in. by 9 in. sleeve with nom 2 in. overlap at seam. Length of sleeve to be approx 1 in. greater than overall thickness of wall assembly, such that, when installed, the ends of the sleeve will project approx 1/2 in. beyond the surface of the wall on both sides of the wall assembly. Max diam of circular through openings in gypsum wallboard layers on each side of wall assembly to be 12 in. Max dimensions for rectangular opening is 12 in. by 9 in. Sleeve installed by coiling the sheet steel to a diam smaller than the through opening, inserting the coil through the openings and releasing the coil to let it uncoil against the circular cutouts in the gypsum wallboard layers.
3. **Steel Pipe or Conduit** – Nom 3 in. diam (or smaller) Schedule 10 (or heavier) steel pipe, steel conduit or steel electrical metallic tubing. Multiple pipes and/or conduit permitted in sleeved opening provided a min separation of 1/4 in. is maintained between pipes or conduits. Pipes and/or conduits to be rigidly supported on both sides of the wall assembly. The T Rating of the firestop system is dependent upon the max diam of the pipes or conduits, as tabulated below:

| Max Pipe or Conduit Diam In. | T Rating Hr |
|------------------------------|-------------|
| 3 | 1 |
| 1 | 1-1/2 |
| 3/4 | 2 |

4. **Packing Material** – Min 1 in. thickness of rigid glass fiber insulation or mineral wool batt insulation firmly packed into steel sleeve on both sides of wall assembly as a permanent form. Packing material to be recessed min 5/8 in. from surface of wall on both sides of wall assembly.
5. **Fill, Void or Cavity Materials* – Caulk or Sealant** – Applied to fill the steel sleeve to a min depth of 1 in. on both sides of wall assembly. A nom 1/4 in. diam continuous bead of caulk shall be applied around the circumference of the steel sleeve at its egress from the gypsum wallboard layers on both sides of the wall assembly.

3M COMPANY – CP 25WB+ caulk or FB-3000 WT sealant.

*Bearing the UL Classification Marking

Reprinted from the Online Certifications Directory with permission from Underwriters Laboratories Inc.

Copyright © 2010 Underwriters Laboratories Inc.®



System No. W-L-1017

April 30, 1998

(Formerly System No. 328)

F Ratings – 1 and 2 Hr. (See Item 3)

T Rating – 0 Hr

L Rating At Ambient – less than 1 CFM/sq ft

L Rating At 400 F – less than 1 CFM/sq ft

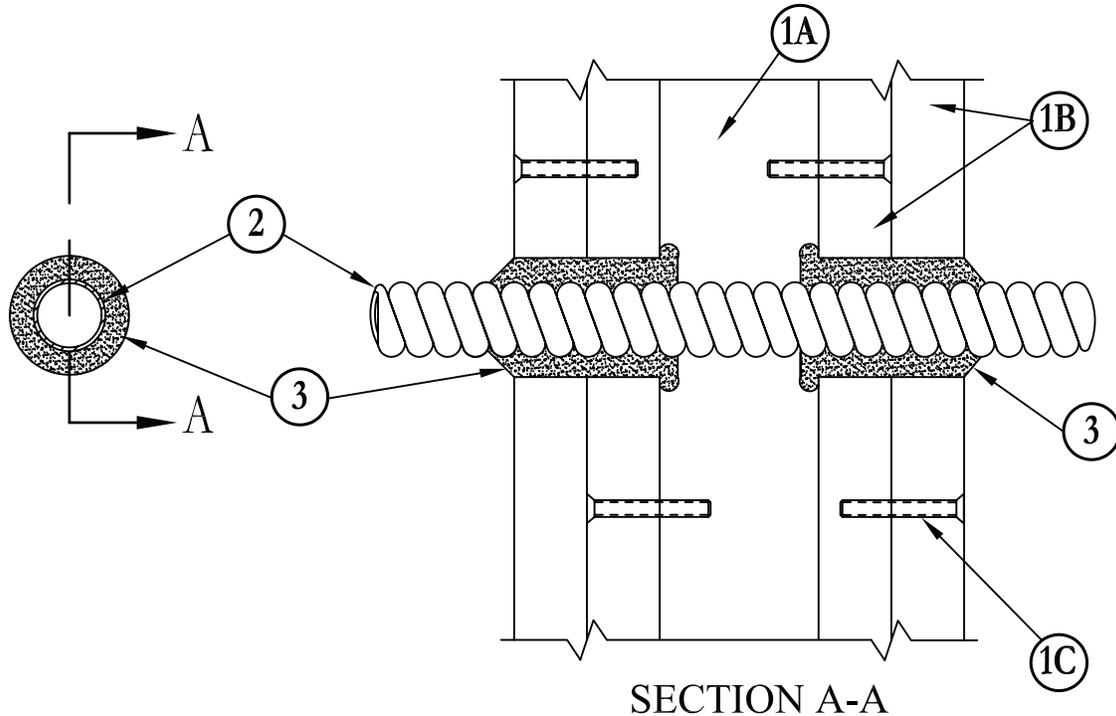

- Wall Assembly** – The 1 or 2 hr fire rated gypsum wallboard/stud wall assembly shall be constructed of the materials and in the manner described in the individual U300 or U400 Series Wall or Partition Designs in the UL Fire Resistance Directory and shall include the following construction features:
 - Studs** – Wall framing may consist of either wood studs or steel channel studs. Wood studs to consist of nom 2 by 4 in. lumber spaced 16 in. OC with nom 2 by 4 in. lumber end plates and cross braces. Steel studs to be min 3-5/8 in. wide by 1-3/8 in. deep channels spaced max 24 in. OC.
 - Gypsum Board*** – Nom 5/8 in. thick, 4 ft. wide with square or tapered edges. The gypsum wallboard type, number of layers and sheet orientation shall be as specified in the individual Wall and Partition Design. Diam of circular through opening cut through gypsum wallboard on each side of wall assembly to be min 0 in. (point contact) to max 1 in. larger than outside diam of flexible metal conduit (Item 2) installed in through opening. Side edge of circular opening to be min 3 in. from nearest stud in wall cavity.
 - Fasteners** – When wood stud framing is employed, gypsum wallboard attached to studs with cement coated nails as specified in the individual Wall or Partition Design. When steel channel stud framing is employed, gypsum wallboard attached to studs with Type S self-drilling, self-tapping bugle-head steel screws as specified in the individual Wall or Partition Design.
- Through Penetrating Product* – Flexible Metal Conduit** – Nom 4 in. diam (or smaller) aluminum or steel **Flexible Metal Conduit**+. Max one flexible metal conduit to be installed near center of circular opening in gypsum wallboard. Flexible metal conduit to be rigidly supported on both sides of wall assembly.
- Fill, Void or Cavity Material* – Caulk** – Caulk fill material forced into annular space around entire circumference of through penetrating product to completely fill opening in gypsum wallboard layers on each side of the wall assembly. A min 5/8 in. thickness of caulk is required for the 1 hr F Rating. A min 1-1/4 in. thickness of caulk is required for the 2 hr F Rating.

AFC CABLE SYSTEMS INC

3M COMPANY – CP 25WB+

*Bearing the UL Classification Marking

Reprinted from the Online Certifications Directory with permission from Underwriters Laboratories Inc.
Copyright © 2010 Underwriters Laboratories Inc.®



System No. W-L-1032

December 20, 1995

(Formerly System No. 480)

F Rating – 2 Hr

T Ratings – 0, 1-1/2 and 2 Hr (See Item 2)

L Rating At Ambient – less than 1 CFM/sq ft

L Rating At 400 F – less than 1 CFM/sq ft

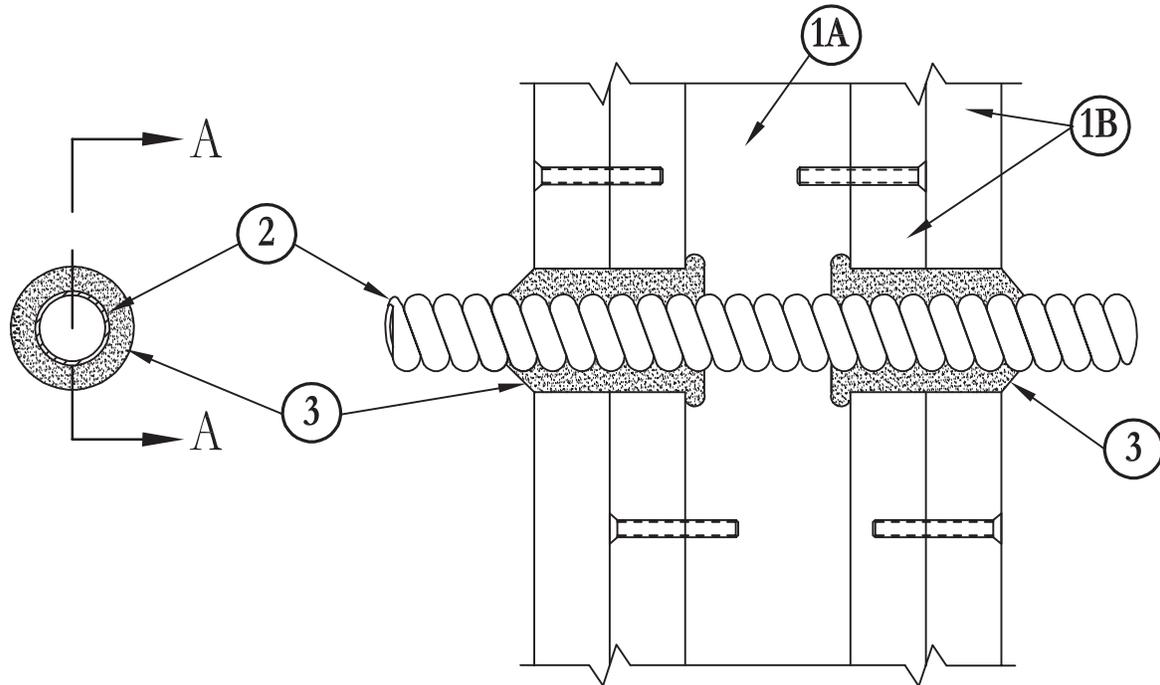

SECTION A-A

- Wall Assembly** – The fire rated gypsum wallboard/stud wall assembly shall be constructed of the materials and in the manner described in the individual U300 and U400 Series Wall and Partition Designs in the UL Fire Resistance Directory and shall include the following construction features:
 - Studs** – Wall framing may consist of either wood studs or steel channel studs. Wood studs to consist of nom 2 by 4 in. lumber spaced 16 in. OC. Steel studs to be min 2-1/2 in. wide and spaced max 24 in. OC.
 - Gypsum Board*** – Two layers of nom 4 ft wide by 5/8 in. thick gypsum wallboard, as specified in the individual Wall and Partition design. Max diam of opening is 3 in.
- Through Penetrating Product* – Flexible Metal Conduit** – Nom 2 in. diam (or smaller) aluminum Flexible Metal Conduit+. Max one flexible metal conduit installed near center of through opening in gypsum wallboard layers. Diam of opening cut through both layers of gypsum wallboard on each side of wall to min 1/4 in. to max 1 in. larger than diam of flexible metal conduit. When nom 1-1/4 in. to 2 in. diam conduit is used, T Rating is 0 hr. **When nom 1/2 in. to 1 in. diam conduit is used, T Rating is 1-1/2 hr. When nom 3/8 in. diam conduit is used, T Rating is 2 hr.** Flexible metal conduit to be rigidly supported on both sides of wall assembly.

ANAMET INDUSTRIAL INC**3M COMPANY** – CP 25WB+

*Bearing the UL Classification Marking

Reprinted from the Online Certifications Directory with permission from Underwriters Laboratories Inc.

Copyright © 2010 Underwriters Laboratories Inc.®



System No. W-L-1037

May 19, 2005

F Rating – 2 Hr

T Ratings – 0 and 1 Hr (See Item 2)

L Rating At Ambient – 2 CFM/sq ft

L Rating At 400 F – less than 1 CFM/sq ft

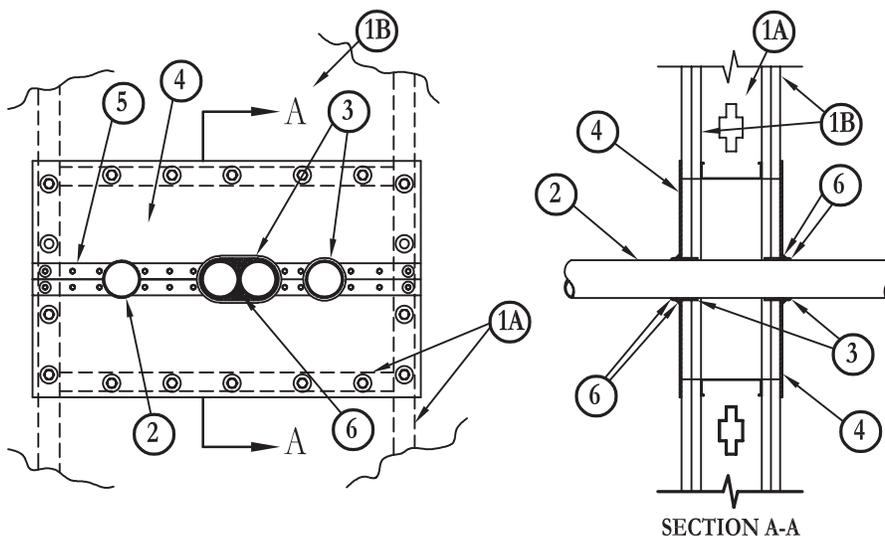

1. **Wall Assembly** – The fire-rated gypsum board/steel stud wall assembly shall be constructed of the materials and in the manner described in the individual U400 or V400 Series Wall and Partition Design in the UL Fire Resistance Directory and shall include the following construction features:

- A. **Steel Studs** – Steel studs to be min 3-5/8 in. (92 mm) deep and spaced max 24 in. (610 mm) OC. The opening in the wall to accommodate the pipes and/or conduits (Item 2) shall be framed on all sides using lengths of steel stud installed between the vertical studs and screw-attached to the steel studs at each end. The framed opening in the wall shall be max 22-1/2 in. (572 mm) wide and 8 in. (203 mm) high.

- B. **Gypsum Board*** – Two layers of nom 5/8 in. (16 mm) thick gypsum board, as specified in the individual Wall and Partition Design.

2. **Pipe or Conduit** – Nom 2 in. (51 mm) diam (or smaller) Schedule 10 (or heavier) steel pipe, steel conduit, steel EMT or Type L (or heavier) copper tubing. Min clearance between pipe or conduit and edge of opening is 1 in. (25 mm). Pipes and conduits to be rigidly supported on both sides of wall assembly. **When copper tubing is used, T Rating is 0 hr. When steel pipe is used, T Rating is 1 hr.**

3. **Fill, Void or Cavity Materials* – Wrap Strip** – Nom 1/4 in. (6 mm) thick intumescent elastomeric material faced on one side with aluminum foil, supplied in nom 2 in. (51 mm) wide strips. When two metallic pipes or conduits are in close proximity or in contact with one another such that the intumescent sheet (Item 4) can not readily be cut to follow their contours, a nom 2 in. (51 mm) wide wrap strip shall be tightly-wrapped around the two pipes and secured with steel wire ties. Wrap strips to project approx 7/8 in. (22 mm) beyond each face of the intumescent sheet (Item 4) on each side of wall. When diam of circular cutout in intumescent sheet is max 1/4 in. (6 mm) larger than diam of metallic pipe or conduit, no wrap strip is required on pipe or conduit.

3M COMPANY – FS-195+

4. **Fill, Void or Cavity Materials* – Intumescent Sheet** – Rigid aluminum foil-faced sheet with galv sheet steel backer. Sheets cut to tightly follow the contours of the individual metallic pipe or conduit or the wrap strip (Item 3) on the grouped metallic pipes. Sheets cut to lap a min of 2 in. (51 mm) on the wall on all sides of the opening on both sides of the wall. Prior to installation, a min 1/4 in. (6 mm) diam bead of caulk (Item 6) shall be applied as a gasket approx 1 in. (25 mm) from and on all sides of the through opening. Sheet to be installed with the galv steel sheet backer exposed (aluminum foil facing against wall surface) and secured to steel framing, through gypsum board layers, with min 1/4 in. (6 mm) diam by 2-1/4 in. (57 mm) long steel screws in conjunction with min 1-1/4 in. (32 mm) diam steel fender washers. Max spacing of fasteners not to exceed 6 in. (152 mm) with additional fasteners located on each side of butted seams or slits made to permit installation of the sheet around the pipes or conduits.

3M COMPANY – CS-195+

5. **Steel Cover Strip** – Min 2 in. (51 mm) wide strip of min 0.020 in. (0.51 mm) thick (26 gauge) galv steel centered over entire length of each butted seam or slit made in the intumescent sheet (Item 4). Prior to installation of the steel strip, the seam or slit in the intumescent sheet shall be covered with a nom 1/4 in. (6 mm) diam bead of caulk (Item 6). Steel cover strip secured to galv steel sheet backer of intumescent sheet with steel sheet metal screws or steel rivets spaced max 3 in. (76 mm) OC on each side of seam or slit.

6. **Fill, Void or Cavity Materials* – Graphite Seal, Caulk, Sealant or Putty** – One layer of 1/2 in. x 1/16 in. (13 mm x 1.6 mm) adhesive backed graphite intumescent seal positioned under intumescent sheet around entire perimeter of through opening or min 1/4 in. (6 mm) diam continuous bead of caulk or putty applied to edge of intumescent sheet at its interface with surface of floor or wall around entire perimeter of through opening. Generous application of caulk to be applied around base of pipe or wrap strip at its egress from the intumescent sheet on each side of wall. An additional bead of caulk shall be applied to the exposed edge of each wrap strip layer. When two metallic pipes or conduits are grouped tightly together and enclosed in a single wrap strip, pieces of mineral wool batt packing material shall be installed inside wrap strip layer and a min 1 in. (25 mm) depth of caulk shall be installed to fill all interstices between the pipes within the confines of the wrap strip.

3M COMPANY – E-FIS or Ultra GS seals, CP 25WB+, IC 15WB+ caulk, FB-3000 WT sealant, MP+ Stix putty.

*Bearing the UL Classification Marking

Reprinted from the Online Certifications Directory with permission from Underwriters Laboratories Inc.

Copyright © 2010 Underwriters Laboratories Inc.®



System No. W-L-1073

December 20, 1995

F Ratings – 1 and 2 Hr (See Item 5)

T Rating – 0 Hr

L Rating At Ambient – less than 1 CFM per sq ft

L Rating At 400 F – less than 1 CFM per sq ft

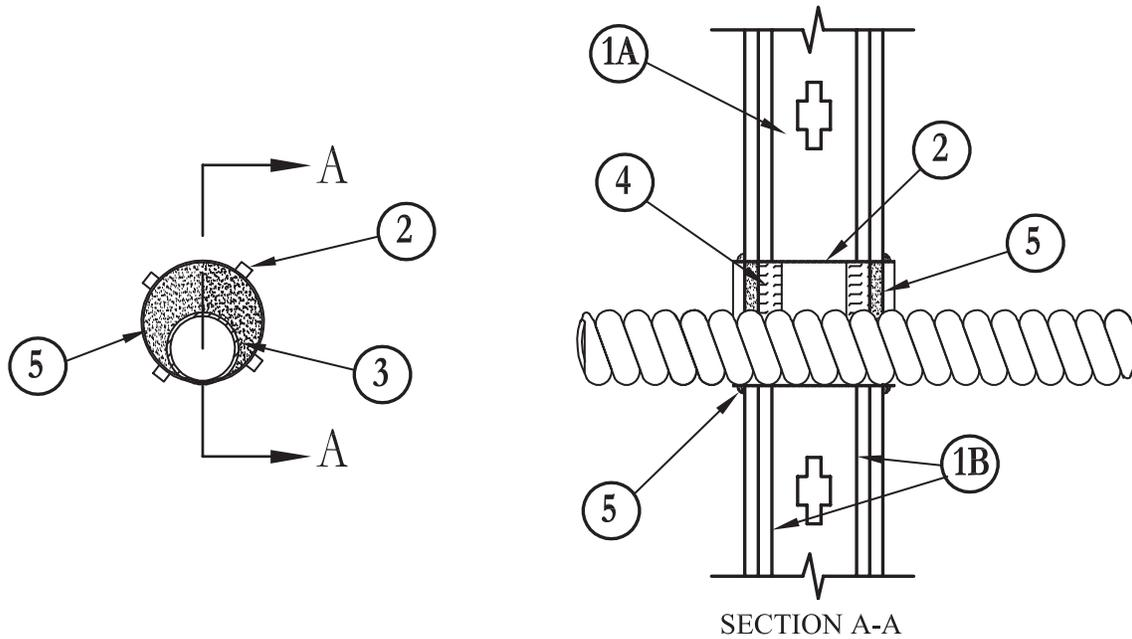

1. **Wall Assembly** – The 1 or 2 hr fire-rated gypsum wallboard/stud wall assembly shall be constructed of the materials and in the manner specified in the individual U300 or U400 Series Wall or Partition Designs in the UL Fire Resistance Directory and shall include the following construction features:

- A. **Studs** – Wall framing may consist of either wood studs or steel channel studs. Wood studs to consist of nom 2 by 4 in. lumber spaced 16 in. OC. Steel studs to be min 3-5/8 in. wide and spaced max 24 in. OC.
- B. **Gypsum Board*** – Nom 5/8 in. thick, 4 ft. wide with square or tapered edges. The gypsum wallboard type, number of layers, fastener type and sheet orientation shall be as specified in the individual Wall and Partition Design. Max diam of opening in gypsum wallboard is 6 in.

2. **Steel Sleeve** – Cylindrical sleeve fabricated from min 0.019 in. thick (No. 28 gauge) galv sheet steel and having a min 2 in. lap along the longitudinal seam. Length of sleeve to be equal to thickness of wall plus 1 in. such that, when installed, the ends of the sleeve will project approx 1/2 in. beyond each surface of the wall on both sides of the wall assembly. The diam of the openings cut in the gypsum wallboard on each side of the wall assembly to be 1 to 1-3/4 in. larger than outside diam of flexible metal conduit. Sleeve installed by coiling the sheet steel to a diam smaller than the through opening, inserting the coil through the openings and releasing the coil to let it uncoil against the circular cutouts in the gypsum wallboard. The sleeve is to be mechanically secured in the wall by cutting longitudinal slits in the ends of the sleeve to form tabs and by bending the tabs 90 degrees against the wallboard surface on each side of the wall.
3. **Through Penetrating Product*** – Nom 4 in. diam (or smaller) aluminum or steel Flexible Metal Conduit#. Max one conduit per sleeved opening. Max annular space between conduit and inside of steel sleeve not to exceed 1-3/4 in. Min annular space between conduit and inside of steel sleeve is zero in. (point contact). Flexible metal conduit to be rigidly supported on both sides of wall assembly.

AFC CABLE SYSTEMS INC

4. **Packing Material** – Polyethylene backer rod or min 1 in. thickness of mineral wool batt insulation firmly packed into opening as a permanent form. Packing material to be recessed min 1/2 in. from wallboard surface on both sides of wall.
5. **Fill, Void or Cavity Material* – Caulk** – Applied to fill the annular space around the flexible metal conduit. A min 1/2 in. depth of fill material is to be installed flush with wall surface on both sides of wall assembly. A min 1/2 in. diam bead of caulk shall be applied to the steel sleeve/wallboard interface around the entire perimeter of the sleeve on each side of the wall. A bead of caulk shall also be applied between the conduit and the steel sleeve at the point contact location on both sides of wall. The hourly F Rating of the firestop system is 1 hr when installed in a 1 hr fire rated wall and 2 hrs when installed in a 2 hr fire rated wall.

3M COMPANY – CP 25WB+

#Bearing the UL Listing Mark

*Bearing the UL Classification Marking

Reprinted from the Online Certifications Directory with permission from Underwriters Laboratories Inc.

Copyright © 2010 Underwriters Laboratories Inc.®



System No. W-L-1077

December 15, 1998

F Rating – 2 Hr

T Rating – 0 Hr

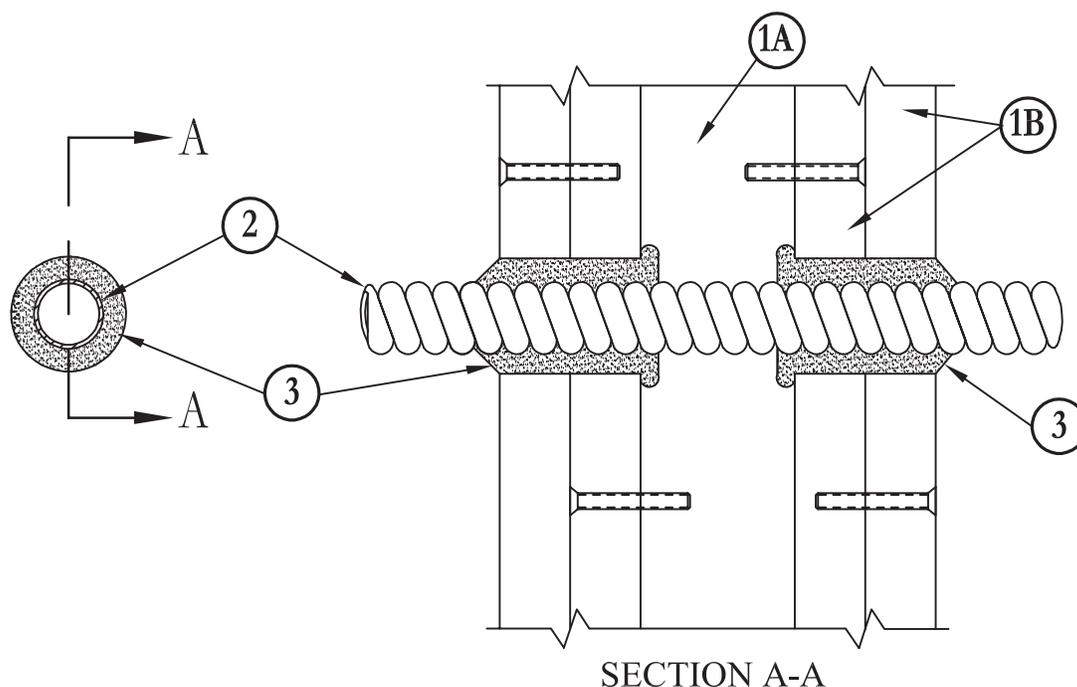

- Wall Assembly** – The fire rated gypsum wallboard/stud wall assembly shall be constructed of the materials and in the manner described in the individual U300 or U400 Series Wall or Partition Designs in the UL Fire Resistance Directory and shall include the following construction features:
 - Studs** – Wall framing may consist of either wood studs or steel channel studs. Wood studs to consist of nom 2 by 4 in. lumber spaced 16 in. OC with nom 2 by 4 in. lumber end plates and cross braces. Steel studs to be min 3-5/8 in. wide by 1-3/8 in. deep channels spaced max 24 in. OC.
 - Gypsum Board*** – Two layers of nom 5/8 in. thick gypsum wallboard, as specified in the individual Wall and Partition Design. Max diam of opening cut in gypsum wallboard layers is 1-15/16 in.
 - Fasteners** – When wood stud framing is employed, gypsum wallboard attached to studs with cement coated nails as specified in the individual Wall or Partition Design. When steel channel stud framing is employed, gypsum wallboard attached to studs with Type S self-drilling, self-tapping bugle-head steel screws as specified in the individual Wall or Partition Design.

Diam of circular through opening cut through both layers of gypsum wallboard on each side of wall assembly to be min 1/4 in. to max 11/16 in. larger than outside diam of flexible metal piping (Item 2) installed in through opening. Side edge of circular opening to be min 3 in. from nearest stud in wall cavity.
- Through Penetrating Product* – Flexible Metal Piping** – Nom 1 in. diam (or smaller) steel Flexible Metal Piping. Max one flexible metal piping to be installed near center of circular opening in gypsum wallboard layers. Flexible metal piping to be rigidly supported on both sides of wall assembly. Plastic covering on piping shall be removed for a distance of 2 ft on both sides of wall assembly.

TITFLEX CORP, A BUNDY CO

- Fill, Void or Cavity Material* – Caulk** – Caulk fill material forced into annular space around entire circumference of through penetrating product to completely fill nom 1-1/4 in. deep opening in gypsum wallboard layers on each side of the wall assembly.

3M COMPANY – CP 25WB+

*Bearing the UL Classification Marking

Reprinted from the Online Certifications Directory with permission from Underwriters Laboratories Inc.
Copyright © 2010 Underwriters Laboratories Inc.®



Through Penetrations

Metallic Pipes

1000 Series

Gypsum

WL

System No. W-L-1080

November 22, 1994

F Rating – 2 Hr

T Ratings – 0 and 3/4 Hr (See Item 2)

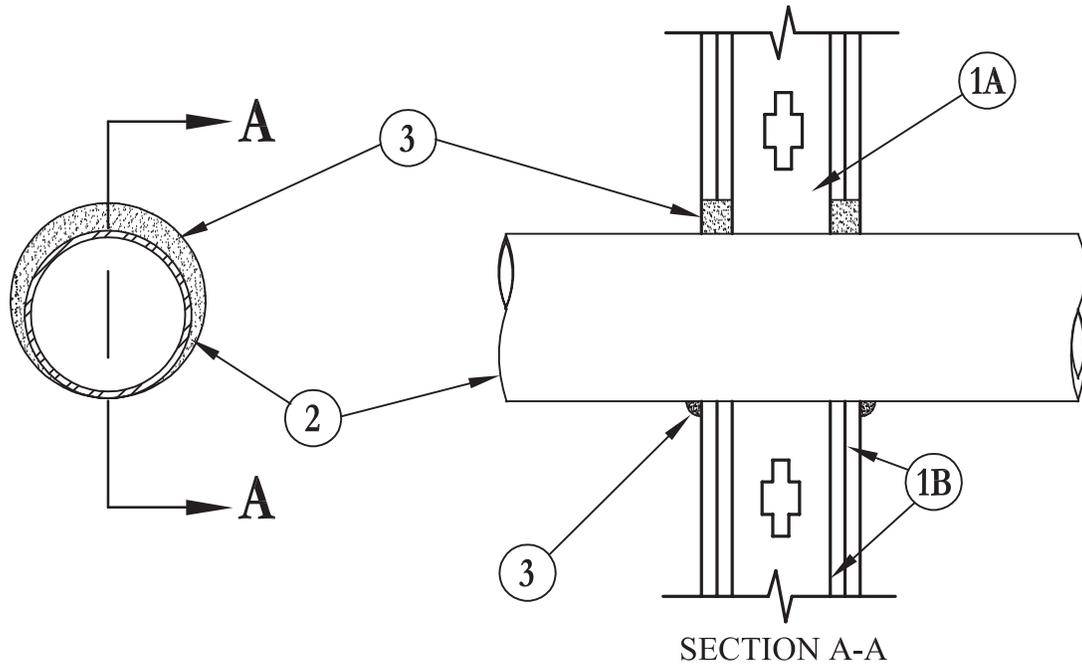

- Wall Assembly** – The 2 hr fire-rated gypsum wallboard/stud wall assembly shall be constructed of the materials and in the manner described in the individual U300 or U400 Series Wall or Partition Designs in the UL Fire Resistance Directory and shall include the following construction features:
 - Studs** – Wall framing may consist of either wood studs or steel channel studs. Wood studs to consist of nom 2 by 4 in. lumber spaced 16 in. OC with nom 2 by 4 in. lumber end plates and cross braces. Steel studs to be min 3-5/8 in. wide channels spaced max 24 in. OC.
 - Gypsum Board*** – Two layers of nom 5/8 in. thick gypsum wallboard as specified in the individual U300 and U400 Series Design in the UL Fire Resistance Directory. Max diam of opening is 5-1/4 in. Diam of circular opening cut through both layers of gypsum wallboard on each side of wall assembly to be min 3/4 in. to max 1-1/2 in. larger than outside diam of pipe, conduit or tube. Side edge of through opening to be min 3 in. from nearest stud in wall cavity.
- Pipe or Conduit** – Nom 4 in. diam (or smaller) Schedule 10 (or heavier) steel pipe, nom 4 in. diam (or smaller) service weight (or heavier) cast iron soil pipe, nom 4 in. diam (or smaller) Class 50 (or heavier) ductile iron pressure pipe, nom 4 in. diam (or smaller) steel conduit, nom 4 in. diam (or smaller) steel electrical metallic tubing or nom 2 in. diam Type L (or heavier) copper tubing. When steel or iron pipe, conduit or tube is used, T Rating of firestop system (Item 3) is 3/4 h. When copper tubing is used, T Rating of firestop system (Item 3) is 0 h. A max of one pipe, conduit or tube is permitted in the firestop system. Max annular space between pipe, conduit or tube and edge of opening is 3/4 in. Min annular space between pipe, conduit or tube and edge of opening is zero in. (point contact). Pipe, conduit or tube to be rigidly supported on both sides of wall assembly.
- Fill, Void or Cavity Material* – Putty** – Putty fill material installed to fill annular space throughout thickness of gypsum wallboard layers on each side of wall assembly. A min 1/4 in. diam bead of putty is to be applied to the wall surface where the pipe, conduit or tube is installed in point contact with the edge of the through opening. Putty installed symmetrically on both sides of wall assembly.

3M COMPANY – MP+ Stix

*Bearing the UL Classification Marking

Reprinted from the Online Certifications Directory with permission from Underwriters Laboratories Inc.
Copyright © 2010 Underwriters Laboratories Inc.®



System No. W-L-1082

July 29, 1995

F Rating – 2 Hr

T Rating – 0 Hr

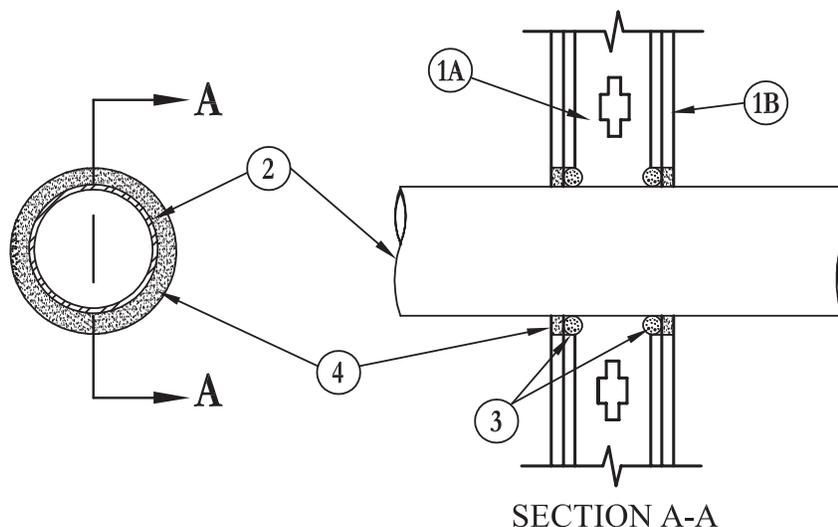
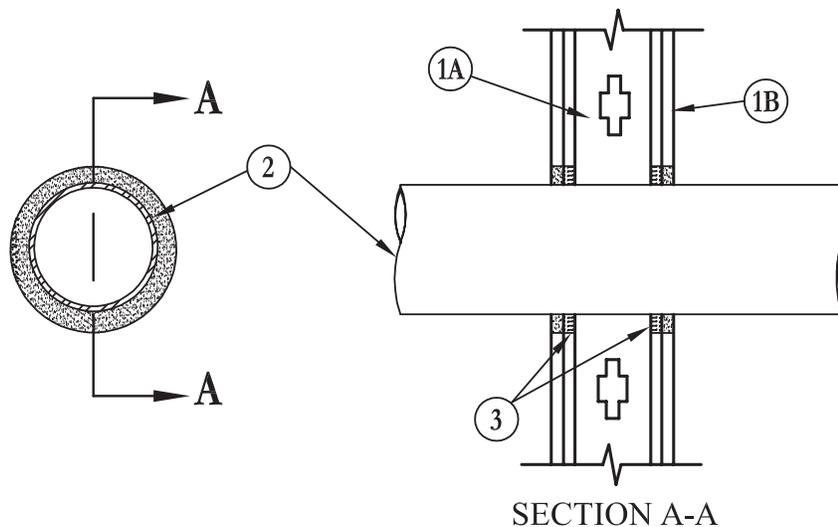

1. **Wall Assembly** – The fire rated gypsum wallboard/stud wall assembly shall be constructed of the materials and in the manner specified in the individual U300 or U400 Series Wall and Partition Designs in the UL Fire Resistance Directory and shall include the following construction features:
 - A. **Studs** – Wall framing may consist of either wood studs or steel channel studs. Wood studs to consist of nom 2 by 4 in. lumber spaced 16 in. OC. Steel studs to be min 3-1/2 in. wide and spaced max 24 in. OC.
 - B. **Gypsum Board*** – Two layers of nom 5/8 in. thick gypsum wallboard, as specified in the individual Wall and Partition Design. Diam of opening is 1-1/2 in. larger than the outside diam of pipe.
2. **Through Penetrant** – One metallic pipe, conduit or tubing to be centered within the firestop system. An annular space of 3/4 in. is required within the firestop system. Pipe, conduit or tubing to be rigidly supported on both sides of wall assembly. The following types and sizes of metallic pipes, conduits or tubing may be used:
 - A. **Steel Pipe** – Nom 12 in. diam (or smaller) Schedule 10 (or heavier) steel pipe.
 - B. **Conduit** – Nom 6 in. diam (or smaller) steel conduit.
 - C. **Conduit** – Nom 4 in. diam (or smaller) steel electrical metallic tubing.
 - D. **Copper Tubing** – Nom 6 in. diam (or smaller) Type L (or heavier) copper tubing.
 - E. **Copper Pipe** – Nom 6 in. diam (or smaller) Regular (or heavier) copper pipe.
3. **Forming Material** – Nom 1 in. diam polyethylene backer rod friction fitted into opening as a permanent form. Forming material to be recessed from both surfaces of wall as required to accommodate the required thickness of fill material.
4. **Fill, Void or Cavity Material* – Sealant** – Min 5/8 in. thickness of fill material applied within annulus, flush with both surfaces of wall assembly.

3M COMPANY – FB-2000+

*Bearing the UL Classification Marking

Reprinted from the Online Certifications Directory with permission from Underwriters Laboratories Inc.
Copyright © 2010 Underwriters Laboratories Inc.®



System No. W-L-1084

July 29, 1995
 F Rating – 1 Hr
 T Rating – 0 Hr

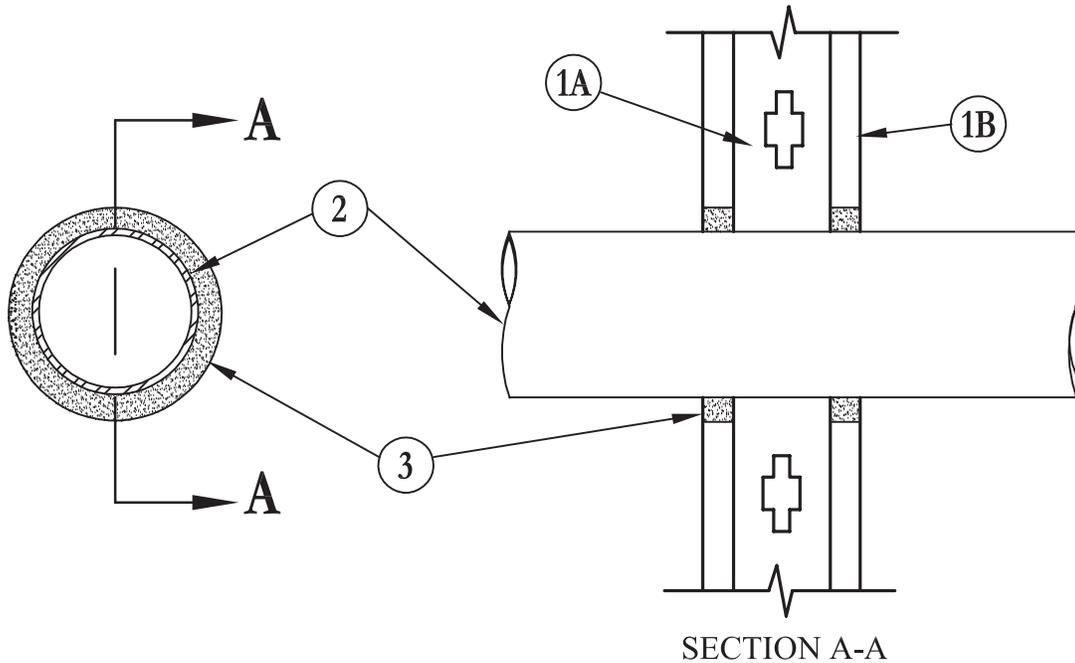

- Wall Assembly** – The fire rated gypsum wallboard/stud wall assembly shall be constructed of the materials and in the manner specified in the individual U300 or U400 Series Wall and Partition Designs in the UL Fire Resistance Directory and shall include the following construction features:
 - Studs** – Wall framing may consist of either wood studs or steel channel studs. Wood studs to consist of nom 2 by 4 in. lumber spaced 16 in. OC. Steel studs to be min 3-5/8 in. wide and spaced max 24 in. OC.
 - Gypsum Board*** – Nom 5/8 in. thick gypsum wallboard, as specified in the individual Wall and Partition Design. Diam of opening is 1-1/2 in. larger than the outside diam of pipe.
- Through Penetrant** – One metallic pipe, conduit or tubing to be centered within the firestop system. An annular space of 3/4 in. is required within the firestop system. Pipe, conduit or tubing to be rigidly supported on both sides of wall assembly. The following types and sizes of metallic pipes, conduits or tubing may be used:
 - Steel Pipe** – Nom 12 in. diam (or smaller) Schedule 10 (or heavier) steel pipe.
 - Conduit** – Nom 6 in. diam (or smaller) electrical metallic tubing or steel conduit.
 - Copper Tubing** – Nom 6 in. diam (or smaller) Type L (or heavier) copper tubing.
 - Copper Pipe** – Nom 6 in. diam (or smaller) Regular (or heavier) copper pipe.
- Fill, Void or Cavity Material* – Sealant** – Min 5/8 in. thickness of fill material applied within annulus, flush with both surfaces of wall assembly.

3M COMPANY – FB-2000+

*Bearing the UL Classification Marking

Reprinted from the Online Certifications Directory with permission from Underwriters Laboratories Inc.
 Copyright © 2010 Underwriters Laboratories Inc.®



System No. W-L-1096

October 19, 2011

F Rating – 2 Hr

T Rating – 0 Hr

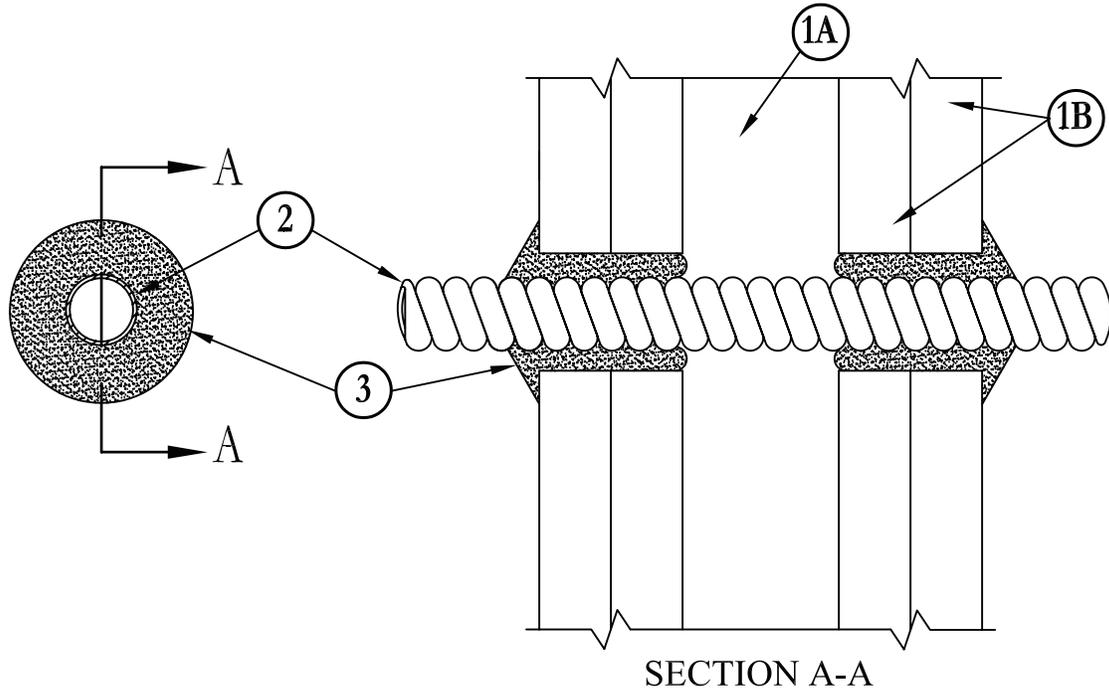

- Wall Assembly** – The fire rated gypsum board/stud wall assembly shall be constructed of the materials and in the manner described in the individual U300, U400, V400 or W400 Series Wall and Partition Designs in the UL Fire Resistance Directory and shall include the following construction features:
 - Studs** – Wall framing may consist of either wood studs or steel channel studs. Wood studs to consist of nom 2 by 4 in. (51 by 102 mm) lumber spaced 16 in. (406 mm) OC with nom 2 by 4 in. (51 by 102 mm) lumber end plates and cross braces. Steel studs to be min 3-5/8 in. (92 mm) wide by 1-3/8 in. (35 mm) deep channels spaced max 24 in. (610 mm) OC.
 - Gypsum Board*** – Two layers of nom 5/8 in. (16 mm) thick gypsum board, as specified in the individual Wall and Partition Design. Max diam of opening cut in gypsum board layers is 3-9/16 in. (90 mm).
 - Fasteners** – When wood stud framing is employed, gypsum wallboard attached to studs with cement-coated nails as specified in the individual Wall and Partition Design. When steel channel stud framing is employed, gypsum board attached to studs with Type S self-drilling, self-tapping bugle-head steel screws as specified in the individual Wall and Partition Design.
Diam of circular through opening cut through both layers of gypsum board on each side of wall assembly to be min 1/4 in. (6 mm) to max 11/16 in. (17 mm) larger than outside diam of flexible metal piping (Item 2) installed in through opening. Side edge of circular opening to be min 3 in. (76 mm) from nearest stud in wall cavity.
- Through-Penetrating Product*** – **Flexible Metal Piping** – Nom 2 in. (51 mm) diam (or smaller) steel flexible metal piping. Max one flexible metal piping to be installed near center of circular opening in gypsum board layers. Flexible metal piping to be rigidly supported on both sides of wall assembly.
WARD MFG L L C – Wardflex or Wardflex II
- Fill, Void or Cavity Material*** – **Caulk** – Caulk fill material forced into annular space around entire circumference of through penetrating product to completely fill nom 1-1/4 in. (32 mm) deep opening in gypsum board layers on each side of the wall assembly.
3M COMPANY – CP-25 WB+

*Bearing the UL Classification Mark

Reprinted from the Online Certifications Directory with permission from UL

© 2012 UL LLC



Through Penetrations

Metallic Pipes

1000 Series

Gypsum

WL

System No. W-L-1112

November 19, 1999

F Rating – 1 Hr

T Rating – 0 Hr

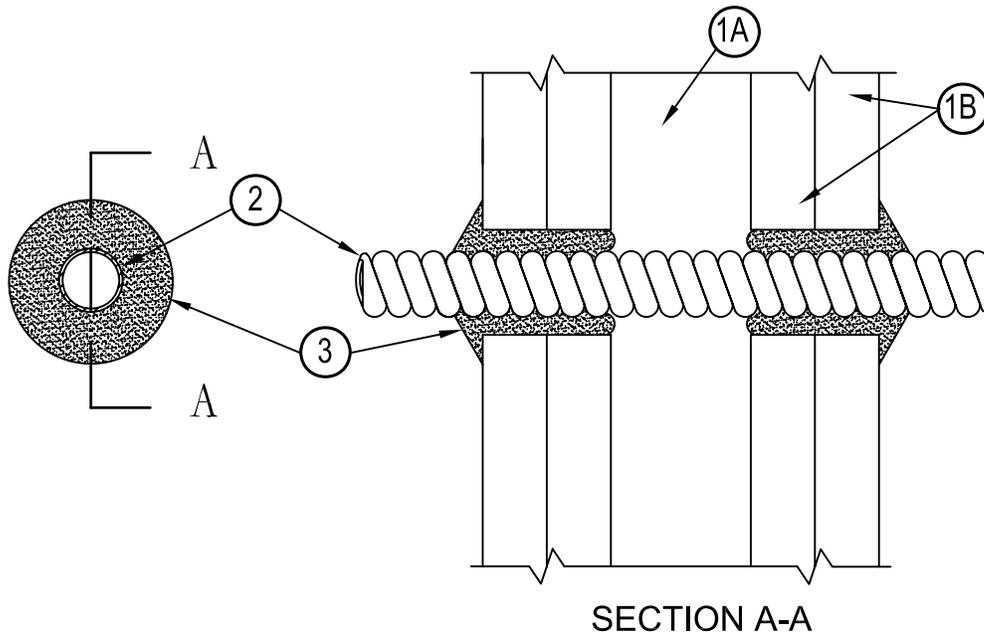

- Wall Assembly** – The fire rated gypsum wallboard/stud wall assembly shall be constructed of the materials and in the manner described in the individual U300 or U400 Series Wall or Partition Designs in the UL Fire Resistance Directory and shall include the following construction features:
 - Studs** – Wall framing may consist of either wood studs or steel channel studs. Wood studs to consist of nom 2 by 4 in. lumber spaced 16 in. OC with nom 2 by 4 in. lumber end plates and cross braces. Steel studs to be min 3-5/8 in. wide by 1-3/8 in. deep channels spaced max 24 in. OC.
 - Gypsum Board*** – Two layers of nom 5/8 in. thick gypsum wallboard, as specified in the individual Wall and Partition Design. Diam of circular through opening cut through both layers of gypsum wallboard on each side of wall assembly to be min 1/4 in. to max 11/16 in. larger than outside diam of flexible metal piping (Item 2) installed in through opening. Side edge of circular opening to be min 3 in. from nearest stud in wall cavity. Max diam of opening cut in gypsum wallboard layers is 3-1/8 in.
 - Fasteners** – When wood stud framing is employed, gypsum wallboard attached to studs with cement-coated nails as specified in the individual Wall or Partition Design. When steel channel stud framing is employed, gypsum wallboard attached to studs with Type S self-drilling, self-tapping bugle-head steel screws as specified in the individual Wall or Partition Design.
- Through-Penetrating Product* – Flexible Metal Piping** – Nom 2 in. diam (or smaller) steel Flexible Metal Piping. Max one flexible metal piping to be installed near center of circular opening in gypsum wallboard layers. Flexible metal piping to be rigidly supported on both sides of wall assembly. Plastic covering on piping shall be removed for a distance of 2 ft on both sides of wall assembly.

OMEGA FLEX INC

- Fill, Void, or Cavity Material* – Caulk** – Caulk fill material forced into annular space around entire circumference of through penetrating product to completely fill nom 1-1/4 in. deep opening in gypsum wallboard layers on each side of the wall assembly.

3M COMPANY – CP 25WB+

*Bearing the UL Classification Mark

Reprinted from the Online Certifications Directory with permission from UL

© 2012 UL LLC

Through Penetrations

Metallic Pipes

1000 Series

Gypsum

WL

System No. W-L-1133

September 03, 2004

F Rating – 1 Hr

T Rating – 1/4 Hr

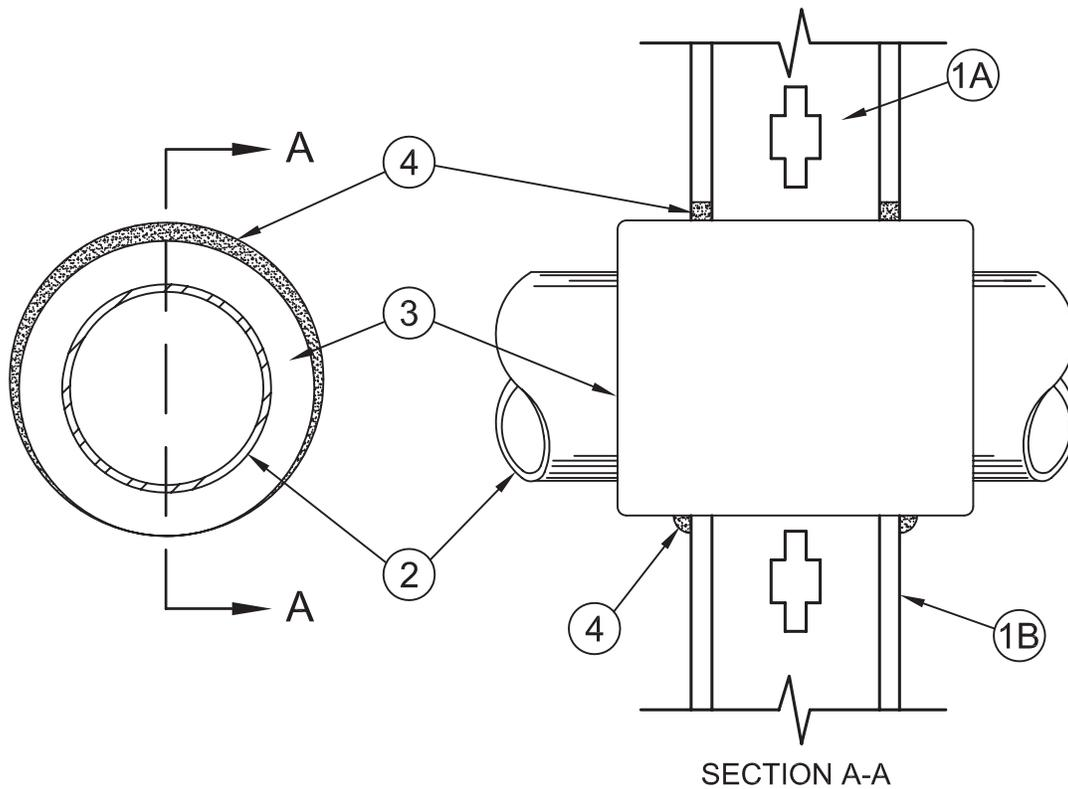

1. **Wall Assembly** – The fire-rated gypsum wallboard/stud wall assembly shall be constructed of the materials and in the manner described in the individual U300 or U400 Series Wall and Partition Design in the UL Fire Resistance Directory and shall include the following construction features:
 - A. **Studs** – Wall framing may consist of either wood studs or steel channel studs. Wood studs to consist of nom 2 by 4 in. lumber spaced 16 in. OC. Steel studs to be min 3-1/2 in. wide and spaced max 24 in. OC.
 - B. **Gypsum Board*** – One layer of nom 5/8 in. thick gypsum wallboard, as specified in the individual Wall and Partition Design. Max diam of opening is 11-1/2 in.
2. **Through Penetrants** – One metallic pipe, conduit or tubing to be installed either concentrically or eccentrically within the firestop system. Pipe, conduit or tubing to be rigidly supported on both sides of wall assembly. The following types and sizes of metallic pipes, conduits or tubing may be used:
 - A. **Steel Pipe** – Nom 6 in. diam (or smaller) Schedule 10 (or heavier) steel pipe.
 - B. **Iron Pipe** – Nom 6 in. diam (or smaller) cast or ductile iron pipe.
 - C. **Conduit** – Nom 4 in. diam (or smaller) steel electrical metallic tubing or steel conduit.
3. **Pipe Covering*** – Nom 2 in. thick hollow cylindrical heavy density glass fiber units with an all service jacket. Pipe covering to be min 12 in. long and installed on penetrant to extend a min of 3-5/8 in. beyond both sides of wall surface. Longitudinal joints sealed with metal fasteners or factory-applied self-sealing lap tape. Transverse joints secured with metal fasteners or with butt tape supplied with the product. Min 18 gauge steel wire ties shall be tightly fastened around outside of pipe covering approximately 1 in. from each end of pipe covering. The annular space between the pipe covering and periphery of opening shall be min 0 in. (point contact) to max 7/8 in.
 See **Pipe and Equipment Covering – Materials** (BRGU) category in the Building Materials Directory for names of manufacturers. Any pipe covering material meeting the above specifications and bearing the UL Classification Marking with a Flame Spread Index of 25 or less and a Smoke Developed Index of 50 or less may be used.
4. **Fill, Void or Cavity Materials* – Caulk or Sealant** – Min 5/8 in. thickness of fill material applied within annulus, flush with each surface of wall. A min 1/4 in. diam bead of caulk shall be applied to the pipe covering/wallboard interface at the point contact location on both sides of wall.

3M COMPANY – CP 25WB+ caulk or FB-3000 WT sealant.

*Bearing the UL Classification Marking

Reprinted from the Online Certifications Directory with permission from Underwriters Laboratories Inc.
 Copyright © 2010 Underwriters Laboratories Inc.®



System No. W-L-1137

September 03, 2004

F Rating – 1 Hr

T Rating – 0 Hr

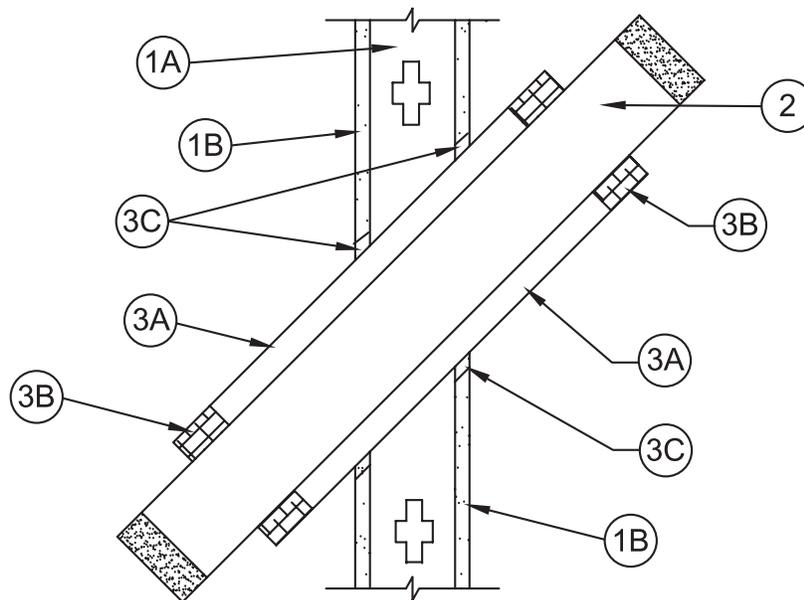

1. **Wall Assembly** – The fire rated gypsum wallboard/stud wall assembly shall be constructed of the materials and in the manner specified in the individual U300 or U400 Series Wall and Partition Designs in the UL Fire Resistance Directory and shall include the following construction features:
 - A. **Studs** – Wall framing may consist of either wood studs or steel channel studs. Wood studs to consist of nom 2 by 4 in. lumber spaced 16 in. OC. Steel studs to be min 3-1/2 in. wide and spaced max 24 in. OC.
 - B. **Gypsum Board*** – Thickness, type, number of layers and fasteners as required in the individual Wall and Partition Design. Diam of opening is max 1/2 in. larger than the outside diam of steel sleeve (Item 3A).
2. **Through Penetrants** – One 6 in. diam (or smaller) No. 11 MSG aluminum pipe (or heavier) to be centered within the firestop system. Pipe to be rigidly supported on both sides of wall assembly. The pipe may be installed at an angle not greater than 45 degrees from perpendicular. Through penetrant may contain the following beverage service lines:
 - A. Max 12 nom 1/2 in. diam polyethylene tubes and max 2 nom 1/2 in. diam (or smaller) copper tubes, with the entire bundle insulated with nom 3/4 in. thick acrylonitrile butadiene/polyvinyl chloride (AB/PVC) insulation.
 - B. Max 10 nom 3/8 in. diam polyolefin tubes, with the entire bundle insulated with a PVC jacket and nom 3/4 in. thick acrylonitrile butadiene/polyvinyl chloride (AB/PVC) insulation.
3. **Firestop System** – The firestop system shall consist of the following:
 - A. **Metallic Sleeve** – Cylindrical sleeve fabricated from min 0.019 in. thick (26 gauge) galv sheet steel and having a min 1 in. lap along the longitudinal seam. Sleeve to extend a min of 2 in. beyond both sides of the wall. The inside diam of the sleeve shall be larger than the outside diam of aluminum pipe or such that an annular space will be present between the steel sleeve and the pipe around the entire circumference of the pipe to accommodate the layer of wrap strip (Item 3B). The annular space between the outside of the wrap strip and the inside of the sleeve shall be min 0 in. to max 1/4 in. The annular space between the outside of the sleeve and the periphery of the opening shall be min 0 in. (point contact) to max 1/2 in.
 - B. **Fill, Void or Cavity Materials* – Wrap Strip** – Nom 1/4 in. thick intumescent elastomeric material faced on one side with aluminum foil, supplied in 2 in. wide strips. One nom 2 in. wide strip tightly wrapped around aluminum pipe (foil side exposed) and slid into sleeve on both sides of wall such that the outer edges of wrap strip are flush with the outer edges of the sleeve. Wrap strip installed with seam butted. Wrap strip layers held in position using aluminum foil tape, steel wire tie, or equivalent. A min 1/2 in. wide stainless steel hose clamp shall be secured around the outside of the sleeve over the center of the wrap strip on both ends of the sleeve.
3M COMPANY – FS-195+
 - C. **Fill, Void or Cavity Materials* – Caulk or Sealant** – Min 5/8 in. thickness of caulk applied within the annulus between metallic sleeve and periphery of the opening, flush with both surfaces of wall assembly. At the point contact location between sleeve and gypsum wallboard, a min 1/2 in. diam bead of caulk shall be applied at the sleeve/wallboard interface on both surfaces of wall assembly. A min 1/4 in. bead of caulk shall also be applied over the outer edges of the wrap strips and within the annular space between the wrap strip and sleeve on both sides of wall.
3M COMPANY – CP 25WB+ or FB-3000 WT
 - D. **Fill, Void or Cavity Materials* – Putty** – Min 1 in. thickness of putty, packed into both ends of through penetrant where beverage lines enter and exit.
3M COMPANY – MP+

*Bearing the UL Classification Mark

Reprinted from the Online Certifications Directory with permission from Underwriters Laboratories Inc.
 Copyright © 2010 Underwriters Laboratories Inc.®



Through Penetrations

Metallic Pipes

1000 Series

Gypsum

WL

System No. W-L-1146

September 03, 2004

F Ratings – 1 and 2 Hr (See Item 1)

T Rating – 0 Hr

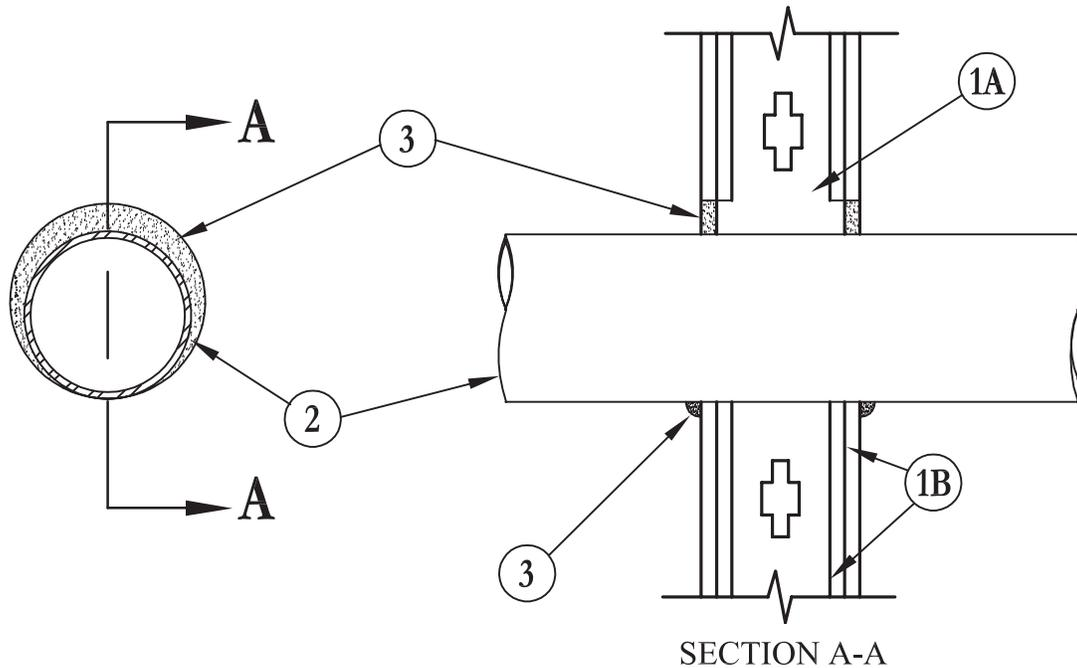

1. **Wall Assembly** – The 1 or 2 hr fire rated gypsum wallboard/stud wall assembly shall be constructed of the materials and in the manner described in the individual U300 or U400 Series Wall or Partition Design in the UL Fire Resistance Directory and shall include the following construction features:
 - A. **Studs** – Wall framing may consist of either wood studs or steel channel studs. Wood studs to consist of nom 2 in. by 4 in. (51 mm by 102 mm) lumber spaced 16 in. (406 mm) OC. Steel studs to be min 3-1/2 in. (89 mm) wide and spaced max 24 in. (610 mm) OC. When steel studs are used and the diam of opening exceeds the width of stud cavity, the opening shall be framed on all sides using lengths of steel stud installed between the vertical studs and screw-attached to the steel studs at each end. The framed opening in the wall shall be 4 in. to 6 in. (102 to 152 mm) wider and 4 in. to 6 in. (102 to 152 mm) higher than the diam of the penetrating item such that, when the penetrating item is centered in the opening, a 2 in. to 3 in. (51 mm to 76 mm) clearance is present between the penetrating item and the framing in all four sides.
 - B. **Gypsum Board*** – The gypsum wallboard type, thickness, number of layers, fastener type and sheet orientation shall be as specified in the individual U300 or U400 Series Design in the UL Fire Resistance Directory. Max diam of opening is 26 in. (660 mm) for steel stud walls. Max diam of opening is 14-1/2 in. (368 mm) for wood stud walls.

The hourly F Rating of the firestop system is equal to the hourly fire rating of the wall assembly in which it is installed.
2. **Through Penetrant** – One metallic pipe, conduit or tubing installed either concentrically or eccentrically within the firestop system. The annular space between pipe, conduit or tubing and periphery of opening shall be min of 0 in. (point contact) to max 2 in. (0 mm to 51 mm). Pipe, conduit or tubing to be rigidly supported on both sides of wall assembly. The following types and sizes of metallic pipes, conduits or tubing may be used:
 - A. **Steel Pipe** – Nom 24 in. (610 mm) diam (or smaller) Schedule 10 (or heavier) steel pipe.
 - B. **Iron Pipe** – Nom 24 in. (610 mm) diam (or smaller) service weight (or heavier) cast iron soil pipe, nom 12 in (305 mm) diam (or smaller) or Class 50 (or heavier) ductile iron pressure pipe.
 - C. **Conduit** – Nom 6 in. (152 mm) diam (or smaller) steel conduit or nom 4 in (102 mm) diam (or smaller) steel electrical metallic tubing
 - D. **Copper Tubing** – Nom 6 in. (152 mm) diam (or smaller) Type L (or heavier) copper tubing
 - E. **Copper Pipe** – Nom 6 in. (152 mm) diam (or smaller) Regular (or heavier) copper pipe.
3. **Fill, Void or Cavity Materials* – Caulk or Sealant** – Min 5/8 in. (16 mm) thickness of fill material applied within the annulus, flush with both surfaces of wall. Min 1/2 in. (13 mm) diam bead of caulk applied to the penetrant/wallboard interface at the point contact location on both sides of wall.

3M COMPANY – CP 25WB+ caulk or FB-3000 WT sealant.

*Bearing the UL Classification Mark

Reprinted from the Online Certifications Directory with permission from Underwriters Laboratories Inc.
Copyright © 2010 Underwriters Laboratories Inc.®



System No. W-L-1157

February 08, 2010

F Ratings – 1 and 2 Hr (See Item 1)

T Ratings – 0 & 1/4 Hr (See Item 2)

L Rating At Ambient – Less Than 1 CFM/sq ft

L Rating At 400 F – 2 CFM/sq ft

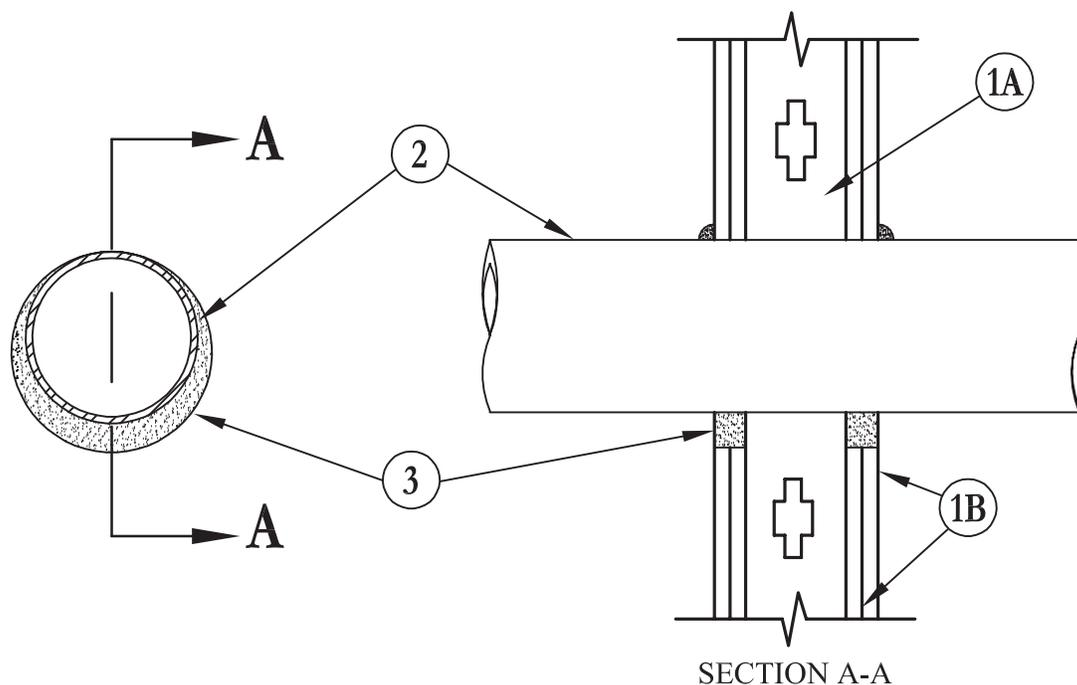

- Wall Assembly** – The 1 or 2 hr fire-rated gypsum wallboard/stud wall assembly shall be constructed of the materials and in the manner specified in the individual U300 or U400 Series Wall and Partition Designs in the UL Fire Resistance Directory and shall include the following construction features:
 - Studs** – Wall framing may consist of either wood studs or steel channel studs. Wood studs to consist of nom 2 by 4 in. (51 by 102 mm) lumber spaced 16 in. (406 mm) OC. Steel studs to be min 2-1/2 in. (64 mm) wide and spaced max 24 in. (610 mm) OC. When steel studs are used and the diam of opening exceeds the width of stud cavity, the opening shall be framed on all sides using lengths of steel stud installed between the vertical studs and screw attached to the steel studs at each end. The framed opening in the wall shall be 4 to 6 in. (102 to 152 mm) wider and 4 to 6 in. (102 to 152 mm) higher than the diam of the penetrating item such that, when the penetrating item is installed in the opening, a 2 to 3 in. (51 to 76 mm) clearance is present between the penetrating item and the framing in all four sides.
 - Gypsum Board*** – Thickness, type, number of layers and fasteners as required in the individual Wall and Partition Design. Max diam of opening is 25-1/2 in. (648 mm) for steel stud walls. Max diam of opening is 14-1/2 in. (368 mm) for wood stud walls.

The hourly F Rating of the firestop system is equal to the hourly fire rating of the wall assembly in which it is installed.
- Through-Penetrant** – One metallic pipe, conduit or tubing installed either concentrically or eccentrically within the firestop system. The annular space shall be min 0 in. (point contact) to max 1-1/2 in. (38 mm). Pipe, conduit or tubing to be rigidly supported on both sides of wall assembly. The following types of pipe, conduit or tubing may be used:
 - Steel Pipe** – Nom 4 in. (102 mm) diam (or smaller) Schedule 5 (or heavier) steel pipe.
 - Copper Tubing** – Nom 6 in. (152 mm) diam (or smaller) Type L (or heavier) copper tubing.
 - Copper Pipe** – Nom 6 in. (152 mm) diam (or smaller) Regular (or heavier) copper pipe.
 - Conduit** – Nom 4 in. (102 mm) diam (or smaller) steel electrical metallic tubing (EMT) or nom 6 in. diam (or smaller) steel conduit.
 - Steel Pipe** – Nom 24 in. (610 mm) diam (or smaller) Schedule 10 (or heavier) steel pipe.

T Rating is 1/4 hr for Items A, D and E, 0 hr for Items B and C.
- Fill, Void or Cavity Material* – Sealant** – Min 5/8 in. (16 mm) or 1-1/4 in. (32 mm) thickness of fill material applied within the annulus, flush with both surfaces of wall for 1 or 2 hr walls, respectively.

3M COMPANY – FB-1000 NS or FB-3000 WT

*Bearing the UL Classification Mark

Reprinted from the Online Certifications Directory with permission from Underwriters Laboratories Inc.
Copyright © 2010 Underwriters Laboratories Inc.®



System No. W-L-1166

June 15, 2005

F Ratings – 1 and 2 Hr (See Item 1B)

T Rating – 0 Hr

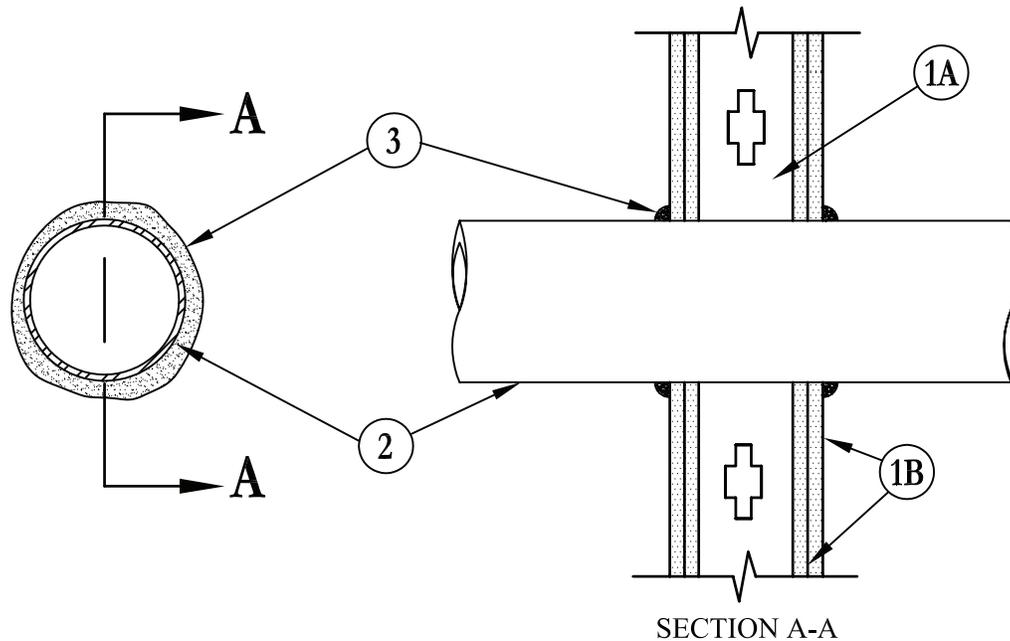

1. **Wall Assembly** – The 1 or 2 hr fire rated gypsum wallboard/stud wall assembly shall be constructed of the materials and in the manner specified in the individual U300 or U400 Series Wall and Partition Designs in the UL Fire Resistance Directory and shall include the following construction features:
 - A. **Studs** – Wall framing may consist of either wood studs or steel channel studs. Wood studs to consist of nom 2 by 4 in. (51 by 102 mm) lumber spaced 16 in. (406 mm) OC. Steel studs to be min 3-1/2 in. (89 mm) wide and spaced max 24 in. (610 mm) OC.
 - B. **Gypsum Board*** – Thickness, type, number of layers and fasteners as required in the individual Wall and Partition Design. Max diam of opening is 5 in. (127 mm).

The hourly F Rating of the firestop system is equal to the hourly fire rating of the wall assembly in which it is installed.

2. **Through Penetrants** – One metallic pipe, conduit or tubing installed either concentrically or eccentrically within the firestop system. The annular space between pipe, conduit or tubing and periphery of opening shall be min of 0 in. (0 mm) (point contact) to max 1/8 in. (3.2 mm) Pipe, conduit or tubing to be rigidly supported on both sides of wall assembly. The following types and sizes of metallic pipes, conduits or tubing may be used:
 - A. **Copper Tubing** – Nom 4 in. (102 mm) diam (or smaller) Type M (or heavier) copper tubing.
 - B. **Copper Pipe** – Nom 4 in. (102 mm) diam (or smaller) Regular (or heavier) copper pipe.
 - C. **Steel Pipe** – Nom 4 in. (102 mm) diam (or smaller) Schedule 5 (or heavier) steel pipe.
 - D. **Conduit** – Nom 4 in. (102 mm) diam (or smaller) steel electrical metallic tubing or rigid steel conduit.
 - E. **Iron Pipe** – Nom 4 in. (102 mm) diam (or smaller) cast or ductile iron pipe.
3. **Fill, Void or Cavity Materials* – Caulk, Sealant or Putty** – Min 1/2 in. (13 mm) diameter bead of caulk or putty applied continuously around the penetrant on the wall surfaces on both sides of the wall.

3M COMPANY – CP 25WB+ caulk, FB-3000 WT sealant, MP+ Stix putty.

*Bearing the UL Classification Marking

Reprinted from the Online Certifications Directory with permission from Underwriters Laboratories Inc.

Copyright © 2010 Underwriters Laboratories Inc.®

System No. W-L-1167

August 03, 2001

F Ratings – 1 and 2 Hr (See Item 1)

T Rating – 0 Hr

L Rating At Ambient – Less Than 1 CFM/sq ft

L Rating At 400 F – 2 CFM/sq ft

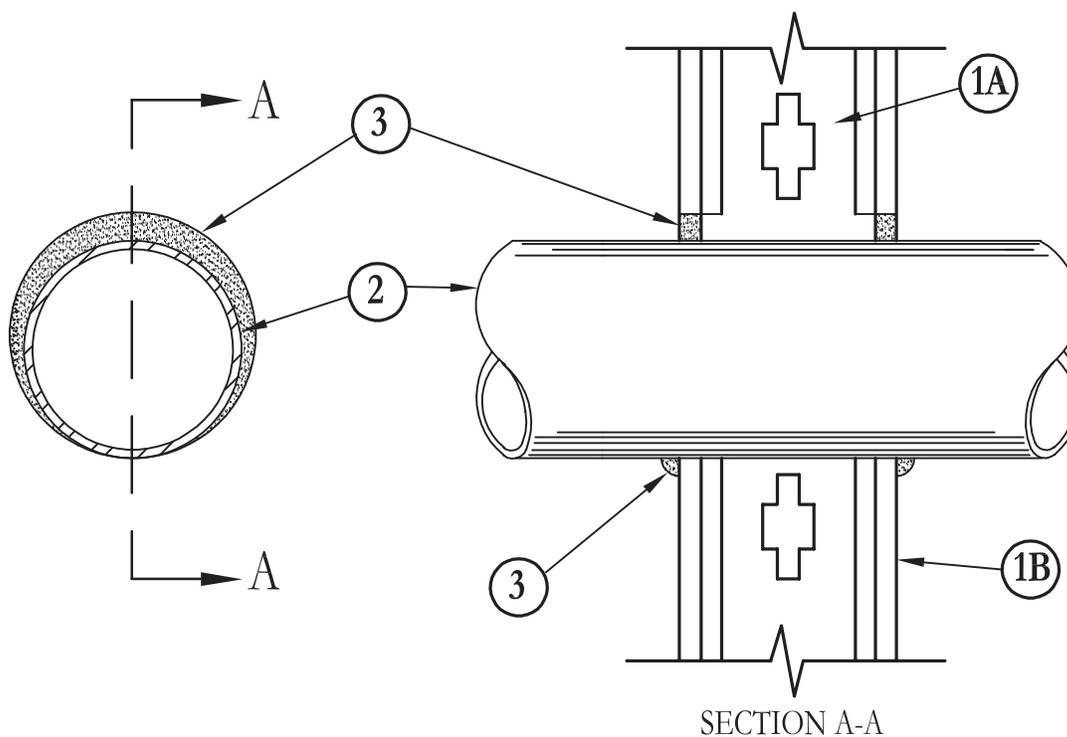

- Wall Assembly** – The 1 or 2 hr fire-rated gypsum wallboard/stud wall assembly shall be constructed of the materials and in the manner described in the individual U300 or U400 Series Wall or Partition Design in the UL Fire Resistance Directory and shall include the following construction features:
 - Studs** – Wall framing may consist of either wood studs or steel channel studs. Wood studs to consist of nom 2 by 4 in. lumber spaced 16 in. OC with nom 2 by 4 in. lumber end plates and cross braces. Steel studs to be min 3-1/2 in. wide by 1-3/8 in. deep channels spaced max 24 in. OC.
 - Gypsum Board*** – The gypsum wallboard type, thickness, number of layers, fastener type and sheet orientation shall be as specified in the individual U300 or U400 Series Design in the UL Fire Resistance Directory. Max diam of opening is 14 in.

The hourly F Rating of the firestop system is equal to the hourly fire rating of the wall assembly in which it is installed.
- Through Penetrant** – One metallic pipe, conduit or tubing installed either concentrically or eccentrically within the firestop system. The annular space between pipe, conduit or tubing and periphery of opening shall be min of 0 in. (point contact) to max 1-3/8 in. Pipe, conduit or tubing to be rigidly supported on both sides of wall assembly. The following types and sizes of metallic pipes, conduits or tubing may be used:
 - Steel Pipe** – Nom 12 in. diam (or smaller) Schedule 10 (or heavier) steel pipe.
 - Iron Pipe** – Nom 12 in. diam (or smaller) service weight (or heavier) cast iron soil pipe, nom 12 in. diam (or smaller) or Class 50 (or heavier) ductile iron pressure pipe.
 - Conduit** – Nom 6 in. diam (or smaller) steel conduit or nom 4 in. diam (or smaller) steel electrical metallic tubing.
 - Copper Tubing** – Nom 4 in. diam (or smaller) Type L (or heavier) copper tubing.
 - Copper Pipe** – Nom 4 in. diam (or smaller) Regular (or heavier) copper pipe.
- Fill Void or Cavity Materials* – Caulk** – Min 5/8 in. thickness of fill material applied within the annulus, flush with both surfaces of wall. Min 1/2 in. diam bead of caulk applied to the penetrant/wallboard interface at the point contact location on both sides of wall.

3M COMPANY – FireDam 150+

*Bearing the UL Classification Mark

Reprinted from the Online Certifications Directory with permission from Underwriters Laboratories Inc.
Copyright © 2010 Underwriters Laboratories Inc.®



System No. W-L-1202

September 03, 2004

F Rating – 4 Hr

T Rating – 1/4 Hr

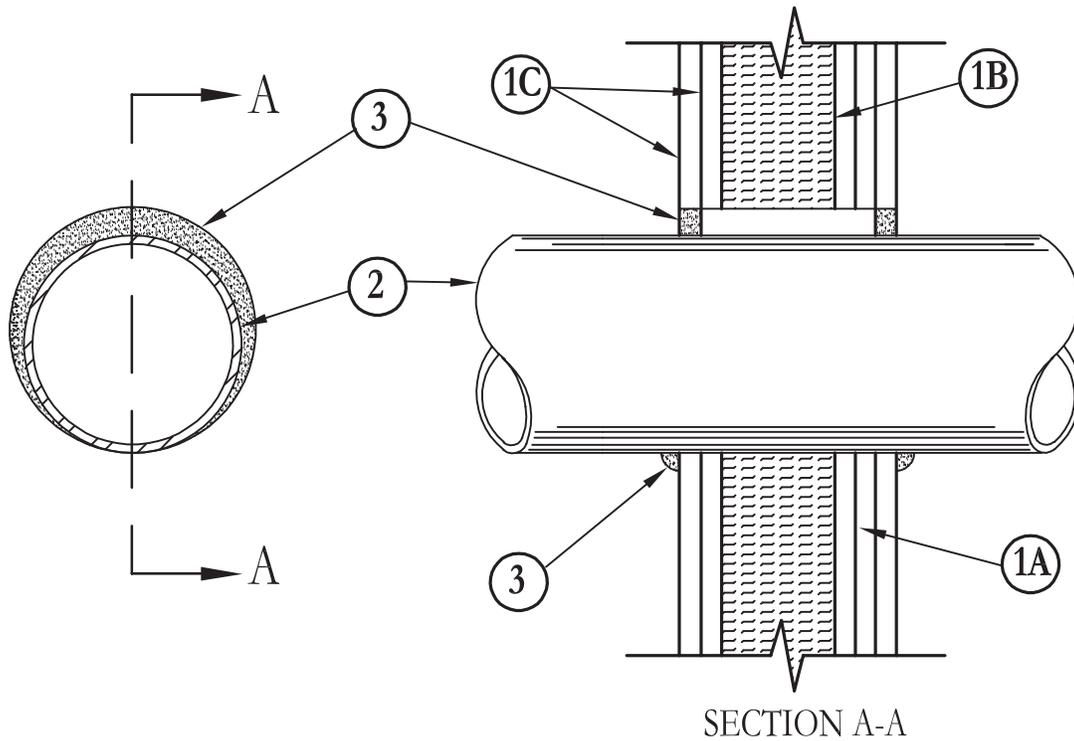

1. **Wall Assembly** - The 4 hr fire rated gypsum board/stud wall assembly shall be constructed of the materials and in the manner specified in the individual U400 Series Wall and Partition Designs in the UL Fire Resistance Directory and shall include the following construction features:
 - A. **Studs** – Wall framing consist of min 20 gauge steel channel studs. Steel studs to be min 3-5/8 in. wide and spaced max 24 in. OC. When opening size exceeds width of stud cavity additional framing members shall be installed between the vertical studs and screw attached at each end.
 - B. **Batts and Blankets** – Min 3 in. thickness of min 4 pcf mineral wool batt insulation to be placed in the stud cavity.
 - C. **Gypsum* Board** – Two layers of nom 3/4 in. thick gypsum board, as specified in the individual Wall and Partition Design. Max size of opening is 25 in.
2. **Through Penetrants** – One metallic pipe, conduit or tubing installed either concentrically or eccentrically within the firestop system. The annular space between pipe, conduit or tubing and periphery of opening shall be min of 0 in. (point contact) to max 1 in. Pipe, conduit or tubing to be rigidly supported on both sides of wall assembly. The following types and sizes of metallic pipes, conduits or tubing may be used:
 - A. **Conduit** – Nom 6 in. diam (or smaller) steel conduit or nom 4 in. diam (or smaller) steel electrical metallic tubing.
 - B. **Copper Tubing** – Nom 6 in. diam (or smaller) Type L (or heavier) copper tubing.
 - C. **Copper Pipe** – Nom 6 in. diam (or smaller) Regular (or heavier) copper pipe.
 - D. **Steel Pipe** – Nom 24 in. diam (or smaller) Schedule 10 (or heavier) steel pipe.
 - E. **Iron Pipe** – Nom 24 in. diam (or smaller) service weight (or heavier) cast iron soil pipe, nom 24 in. diam (or smaller) or Class 50 (or heavier) ductile iron pressure pipe.
3. **Fill, Void or Cavity Materials* – Caulk or Sealant** – Min thickness of 3/4 in. of fill material applied within annulus, flush with both surfaces of wall assembly. Min 1/2 in. diam bead of caulk applied to the penetrant/wallboard interface at point contact location on both surfaces of wall assembly.

3M COMPANY – CP 25WB+ caulk or FB-3000 WT sealant.

*Bearing the UL Classification Marking

Reprinted from the Online Certifications Directory with permission from Underwriters Laboratories Inc.
Copyright © 2010 Underwriters Laboratories Inc.®



UL System No. W-L-1228
XHEZ - Through-penetration Firestop Systems
XHEZ7 - Through-penetration Firestop Systems Certified for Canada

June 28, 2010

F Rating — 1 and 2 Hr (See Item 1)

T Ratings — 0, 1/2 and 1 Hr (See Item 3)

L Rating At Ambient — Less Than 1 CFM/sq ft

L Rating At 400 F — 2 CFM/sq ft

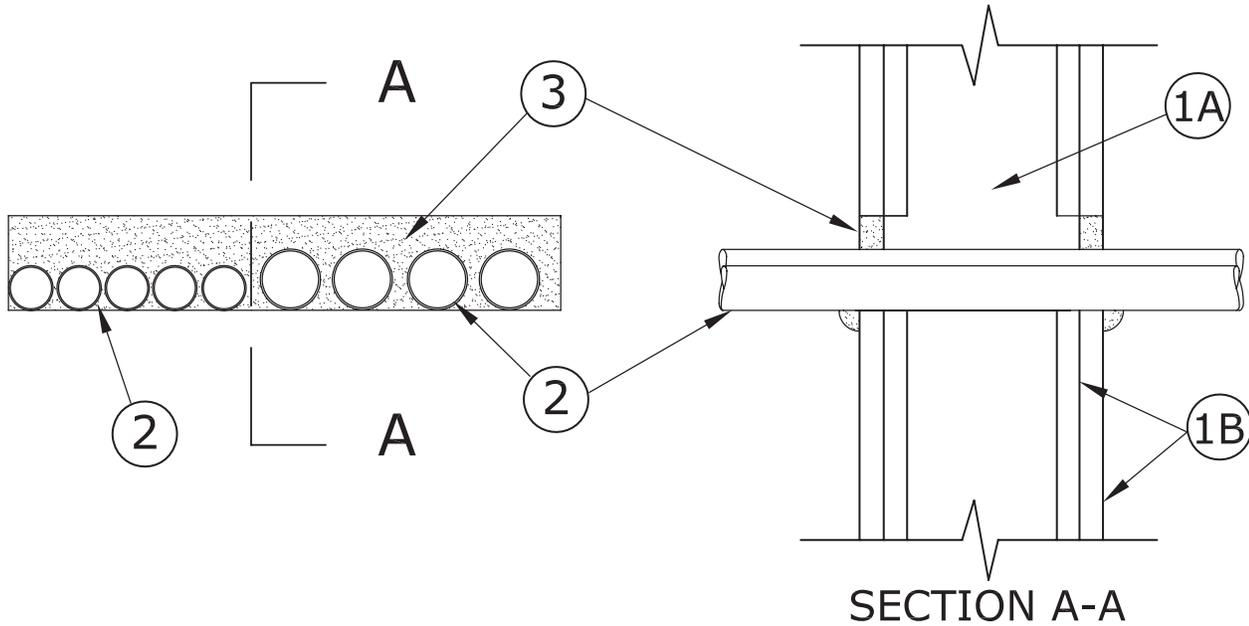

1. Wall Assembly – The 1 or 2 hr fire rated gypsum board/stud wall assembly shall be constructed of the materials and in the manner described in the individual U400 or V400 series Wall and Partition Design in the UL Fire Resistance Directory and shall include the following construction features:

A. Studs – Wall framing shall consist of min 3-5/8 in. (92 mm) wide steel channel studs spaced max 24 in. (610 mm) OC.

B. Gypsum Board* – Thickness, type, number of layers and fasteners shall be as specified in the individual U400 or V400 series Wall and Partition Design in the UL Fire Resistance Directory. Max area of opening is 67-1/2 sq. in. (435 sq cm) with max dimension of 22-1/2 in. (572 mm).

The hourly F Rating of the firestop system is equal to the hourly fire rating of the wall assembly in which it is installed.

2. Through-Penetrant – One or more nom 2 in. (51 mm) diam (or smaller) rigid steel conduit or electrical metallic tubing (EMT) installed either concentrically or eccentrically within the firestop system. The annular space between conduits or tubing and periphery of opening shall be min 0 in. (0 mm, point contact) to max 1-1/4 in. (32 mm). The space between conduits or tubing shall be min 1/4 in. (6 mm) to max 1 in. (25 mm). Conduit or tubing to be rigidly supported on both sides of wall assembly.

3. Fill, Void or Cavity Material* - Caulk or Sealant – Min 5/8 in. (16 mm) thickness of fill material applied within the annulus, flush with both surfaces of wall. Min 1/2 in. (13 mm) diam bead of caulk applied to the penetrant/gypsum board interface at the point contact location on both sides of wall.

The hourly T Rating of the firestop system is 0 Hr when used in 1 Hr rated assemblies. The T Rating for 2 Hr rated assemblies is 1/2 Hr for FireDam 150+ and IC 15WB and is 1 Hr for CP-25WB+ and FB-3000 WT .

3M COMPANY – CP 25WB+, FireDam 150+, IC 15WB+ caulk or FB-3000 WT sealant

* Indicates such products shall bear the UL or cUL Certification Mark for jurisdictions employing the UL or cUL Certification (such as Canada), respectively.



System No. W-L-1255

September 20, 2011

ANSI/UL1479 (ASTM E814)

F Ratings – 1 and 2 Hr (See Item 1)
 T Ratings – 0 and 1/2 Hr (See Item 1)
 L Rating At Ambient – 7 CFM/sq ft
 L Rating At 400 F – 4 CFM/sq ft

CAN/ULC S115

F Ratings – 1 and 2 Hr (See Item 1)
 FT Ratings – 0 and 1/2 Hr (See Item 1)
 FH Ratings – 1 and 2 Hr (See Item 1)
 FTH Ratings – 0 and 1/2 Hr (See Item 1)
 L Rating At Ambient – 7 CFM/sq ft
 L Rating At 400 F – 4 CFM/sq ft

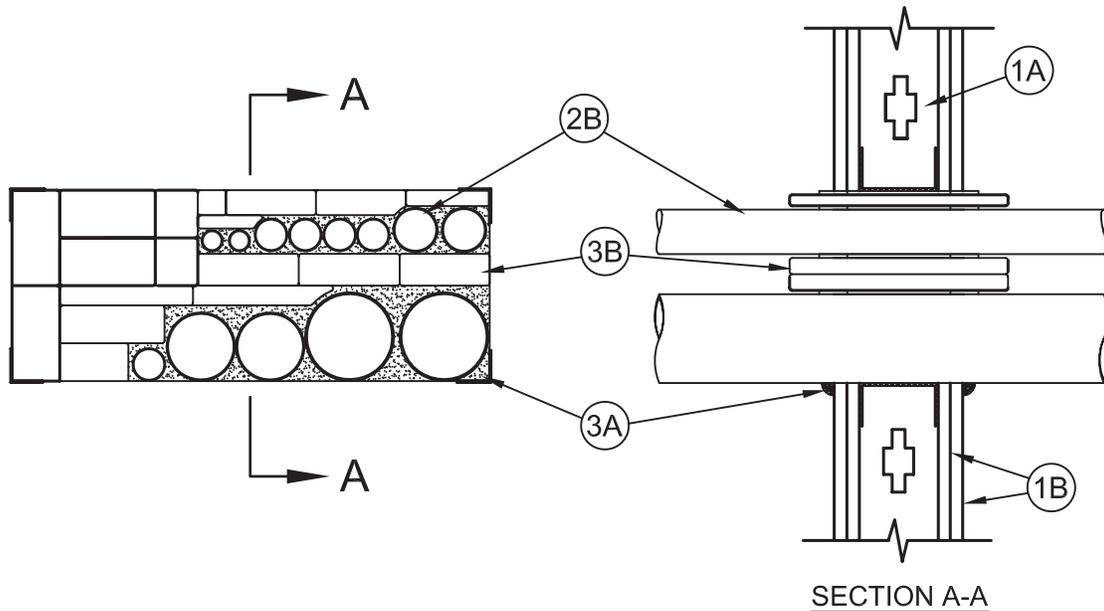

- Wall Assembly** – The 1 or 2 hr fire-rated gypsum board/stud wall assembly shall be constructed of the materials and in the manner specified in the individual U300, U400, V400 or W400 Series Wall and Partition Designs in the UL Fire Resistance Directory and shall include the following construction features:

- Studs** – Wall framing may consist of either wood studs or steel channel studs. Wood studs to consist of nom 2 by 4 in. (51 by 102 mm) lumber spaced 16 in. (406 mm) OC. Steel studs to be min 3-5/8 in. (92 mm) wide spaced max 24 in. (610 mm) OC. Additional framing members shall be used to completely frame around opening.
- Gypsum Board*** – Thickness, type, number of layers and fasteners as required in the individual Wall and Partition Design. Max area of opening is 225 sq in. (0.15 m²) with a max dimension of 22-1/2 in. (572 mm).

The hourly F and FH Ratings for the firestop system are equal to the hourly fire rating of the wall assembly in which it is installed. The hourly T, FT and FTH Ratings for the firestop system are 0 and 1/2 hr for 1 and 2 hr rated assemblies, respectively.

- Through-Penetrant** – One or more nom 4 in. (102 mm) diam (or smaller) rigid steel conduit or electrical metallic tubing (EMT) installed either concentrically or eccentrically within the firestop system. The annular space between conduits or tubing and periphery of opening shall be min 0 in. (0 mm) (point contact) to max 4 in. (102 mm). The horizontal space between conduits or tubing shall be min 1/4 in. (6 mm) to max 4 in. (102 mm). The vertical space between conduits or tubing shall be min 1-1/2 in. (38 mm) to max 4 in. (102 mm). Conduit or tubing to be rigidly supported on both sides of wall assembly.
- Firestop System** – The firestop system shall consist of the following:
 - Fill Void or Cavity Material* – Caulk, Sealant or Putty** – Min 1/2 in. (13 mm) thickness of caulk or putty formed to a min 1 in. (25 mm) width and applied within annulus at all corners of opening and extending a min 1 in. (25 mm) in both directions from each corner, flush with both surfaces of wall. Min 1/4 in. (6 mm) thickness, min 2 in. (51 mm) width of caulk or putty wrapped applied around each penetrant such that caulk or putty extends approximately 1/2 in. (51 mm) beyond both surfaces of wall. After installation of pillows (Item 4B) all voids within the opening shall be filled with a min 1 in. (25 mm) thickness of caulk or putty.

3M COMPANY – MPS-2+ or CP 25 WB+ or FB-3000 WT

- Fill Void or Cavity Material* – Pillows** – Max 9 in. (229 mm) long by 6 in. (152 mm) wide by 2 and 3 in. (51 and 76 mm) thick plastic covered pillows tightly-packed to fill annular space between penetrants and periphery of opening. Pillows installed with 9 in. (229 mm) dimension projecting through wall and centered within the opening.

3M COMPANY – Fire Barrier Pillow or Fire Barrier Self-Locking Pillows

*Bearing the UL Classification Mark

Reprinted from the Online Certifications Directory with permission from Underwriters Laboratories Inc.
 Copyright © 2011 Underwriters Laboratories Inc.®



System No. W-L-1287

May 19, 2005

F Ratings – 1 & 2 Hr (See Item 1)

T Ratings – 0 & 1/4 Hr (See Item 1)

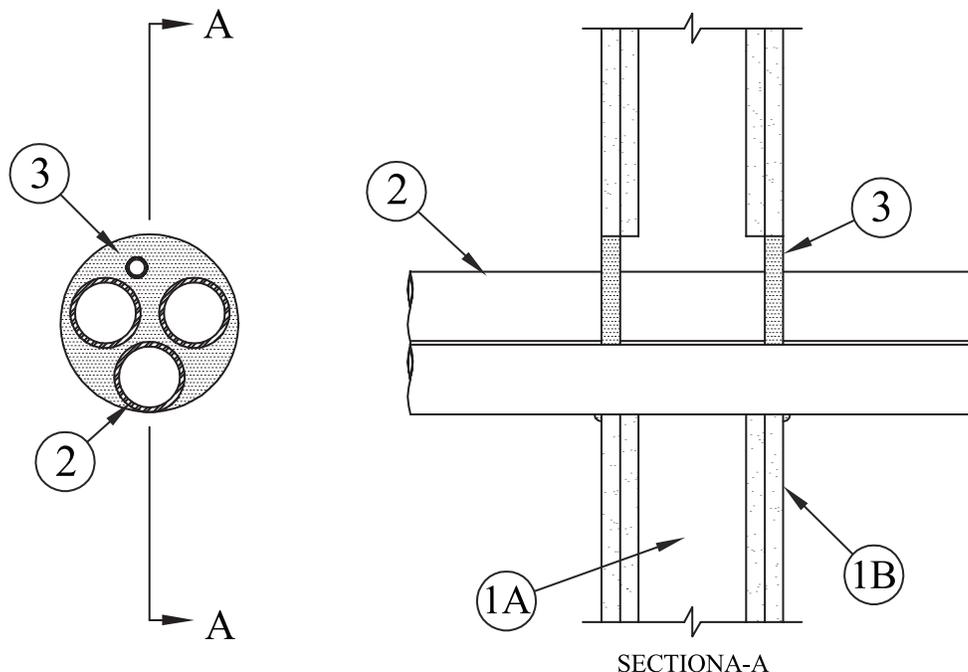

1. **Wall Assembly** – The 1 or 2 hr fire rated gypsum board/stud wall assembly shall be constructed of the materials and in the manner described in the individual U300, U400 or V400 Series Wall or Partition Design in the UL Fire Resistance Directory and shall include the following construction features:

- A. **Studs** – Wall framing may consist of either wood studs or steel channel studs. Wood studs to consist of nom 2 in. by 4 in. (51 mm by 102 mm) lumber spaced 16 in. (406 mm) OC. Steel studs to be min 3-1/2 in. (89 mm) wide spaced max 24 in. (610 mm) OC.
- B. **Gypsum Board*** – The gypsum board type, thickness, number of layers, fastener type and sheet orientation shall be as specified in the individual U300 or U400 Series Design in the UL Fire Resistance Directory. Max diam of opening is 8 in. (203 mm)

The hourly F Rating of the firestop system is equal to the hourly fire rating of the wall assembly in which it is installed. The hourly T Rating is 0 and 1/4 Hr for 1 and 2 Hr rated assemblies, respectively.

2. **Through Penetrants** – One or more metallic pipes, conduits, tubes or flexible metal pipes installed concentrically or eccentrically within opening. Annular space between penetrants and periphery of opening to be min 0 in. (point contact) to max 2 in. (0 mm to max 51 mm). Space between penetrants to be min 1/4 in. to max 2 in. (6 mm to max 51 mm). Penetrants to be rigidly supported on both sides of wall. The following types and sizes of penetrants may be used:
 - A. **Steel Pipe** – Nom 3 in. (76 mm) diam (or smaller) Schedule 5 (or heavier) steel pipe.
 - B. **Iron Pipe** – Nom 3 in. (76 mm) diam (or smaller) cast or ductile iron pipe.
 - C. **Conduit** – Nom 3 in. (76 mm) diam (or smaller) steel conduit or steel electrical metallic tubing.
 - D. **Copper Tubing** – Nom 2 in. (51 mm) diam (or smaller) Type L (or heavier) copper tubing.
 - E. **Copper Pipe** – Nom 2 in. (51 mm) diam (or smaller) Regular (or heavier) copper pipe.
 - F. **Through Penetrating Product* – Flexible Metal Piping** – The following types of steel flexible metal gas piping may be used:
 1. Nom 2 in. (51 mm) diam (or smaller) steel flexible metal gas piping. Plastic covering on piping may or may not be removed on both sides of floor or wall assembly.
OMEGA FLEX INC.
 2. Nom 1 in. (25 mm) diam (or smaller) steel flexible metal gas piping. Plastic covering on piping may or may not be removed on both sides of floor or wall assembly.
TITFLEX CORP, A BUNDY CO
 3. Nom 1 in. (25 mm) diam (or smaller) steel flexible metal gas piping. Plastic covering on piping may or may not be removed on both sides of floor or wall assembly.
WARD MFG INC.
3. **Fill, Void or Cavity Material* – Caulk or Sealant** – Min 5/8 in. (16 mm) thickness of caulk applied within annulus, flush with both surfaces of wall. Min 1/4 in. (6 mm) diam bead of caulk applied to gypsum board/penetrant interface at point contact location on both sides of wall.

3M COMPANY – IC 15WB+, CP 25WB+ caulk or FB-3000 WT sealant.

*Bearing the UL Classification Marking

Reprinted from the Online Certifications Directory with permission from Underwriters Laboratories Inc.
Copyright © 2010 Underwriters Laboratories Inc.®



System No. W-L-1296

February 14, 2008

F Ratings – 1 and 2 Hr (See Item 1)

T Ratings – 0 and 1/4 Hr (See Item 1)

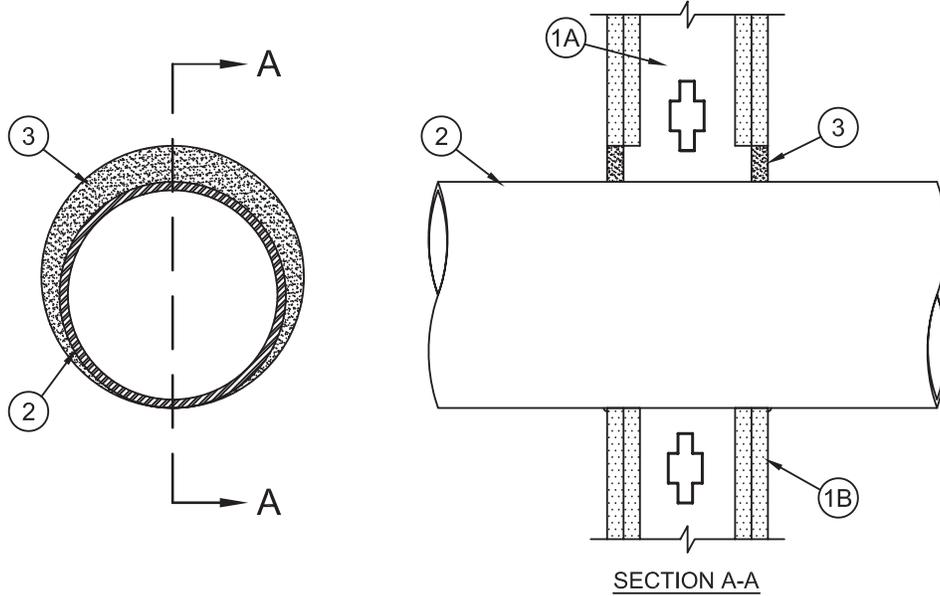

- Wall Assembly** – The 1 or 2 hr fire rated gypsum board/stud wall assembly shall be constructed of the materials and in the manner described in the individual U300, U400 or V400 Series Wall and Partition Design in the UL Fire Resistance Directory and shall include the following construction features:

- Studs** – Wall framing may consist of either wood studs or steel channel studs. Wood studs to consist of nom 2 by 4 in. (51 by 102 mm) lumber spaced 16 in. (406 mm) OC. Steel studs to be min 3-1/2 in. (89 mm) wide spaced max 24 in. (610 mm) OC.
- Gypsum Board*** – The gypsum board type, thickness, number of layers, fastener type and sheet orientation shall be as specified in the individual U300, U400 or V400 Series Design in the UL Fire Resistance Directory. Max diam of opening is 10-5/8 in. (270 mm).
- Steel Sleeve** – (Optional, Not Shown) - Cylindrical sleeve fabricated from min 0.019 in. thick (0.48 mm) galv sheet steel and having a min 2 in. (51 mm) lap along the longitudinal seam. Length of steel sleeve to be equal to thickness of wall. Sleeve installed by coiling the sheet steel to a diam smaller than the through opening, inserting the coil through the openings and releasing the coil to let it uncoil against the circular cutouts in the gypsum wallboard layers.

The hourly F Rating of the firestop system is equal to the hourly fire rating of the wall assembly in which it is installed. The hourly T Rating is 0 and 1/4 Hr for 1 and 2 Hr rated assemblies, respectively.

- Through Penetrants** – One metallic pipe, conduit, tubing or flexible metal pipe installed concentrically or eccentrically within opening. Annular space between penetrant and periphery of opening to be min 0 in. (0 mm point contact) to max 2 in. (51 mm). Penetrant to be rigidly supported on both sides of wall. The following types and sizes of penetrants may be used:
 - Steel Pipe** – Nom 8 in. (203 mm) diam (or smaller) Schedule 5 (or heavier) steel pipe.
 - Iron Pipe** – Nom 8 in. (203 mm) diam (or smaller) cast or ductile iron pipe.
 - Conduit** – Nom 4 in. (102 mm) diam (or smaller) steel electrical metallic tubing (EMT) or nom 6 in. (152 mm) rigid steel conduit.
 - Copper Tubing** – Nom 4 in. (102 mm) diam (or smaller) Type L (or heavier) copper tubing.
 - Copper Pipe** – Nom 4 in. (102 mm) diam (or smaller) Regular (or heavier) copper pipe.
 - Through Penetrating Product* – Flexible Metal Piping** – The following types of steel flexible metal gas piping may be used:
 - Nom 2 in. (51 mm) diam (or smaller) steel flexible metal gas piping. Plastic covering on piping may or may not be removed on both sides of floor or wall assembly.
OMEGA FLEX INC
 - Nom 1 in. (25 mm) diam (or smaller) steel flexible metal gas piping. Plastic covering on piping may or may not be removed on both sides of floor or wall assembly.
GASTITE, DIV OF TITEFLEX
 - Nom 1 in. (25 mm) diam (or smaller) steel flexible metal gas piping. Plastic covering on piping may or may not be removed on both sides of floor or wall assembly.
WARD MFG INC
- Fill, Void or Cavity Material* – Caulk or Sealant** – Min 5/8 in. (16 mm) thickness of caulk applied within annulus, flush with both surfaces of wall. Min 1/4 in. (6 mm) diam bead of caulk applied to gypsum board/penetrant interface at point contact location on both sides of wall.

3M COMPANY – IC 15WB+, CP 25WB+ caulk or FB-3000 WT sealant

*Bearing the UL Classification Mark

Reprinted from the Online Certifications Directory with permission from Underwriters Laboratories Inc.
Copyright © 2010 Underwriters Laboratories Inc.®



System No. W-L-1299

May 23, 2005

F Ratings – 1 & 2 Hr (See Item 1)

T Rating – 0 Hr

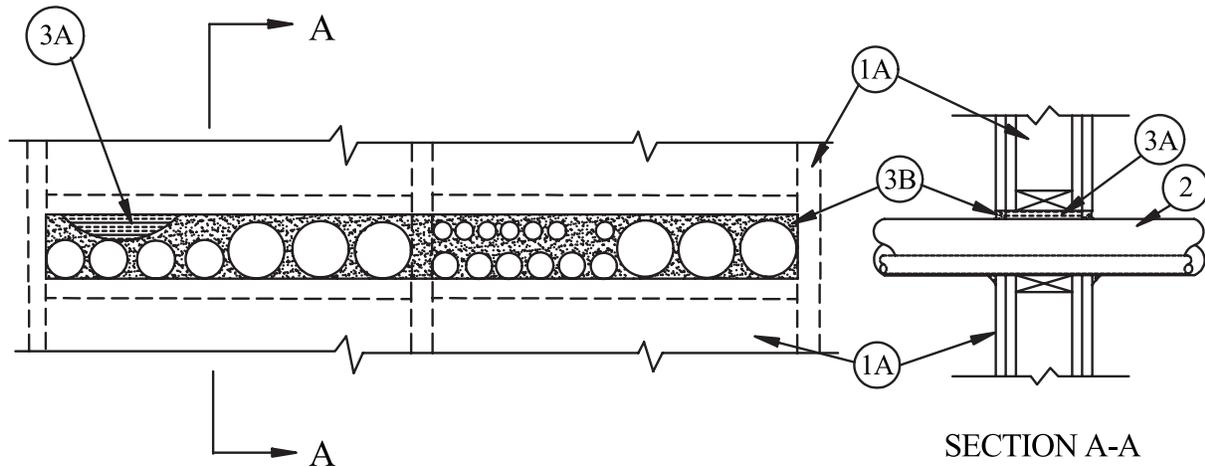

- Wall Assembly** – The 1 or 2 hr fire rated gypsum board/stud wall assembly shall be constructed of the materials and in the manner described in the individual U400 or V400 Series Wall or Partition Design in the UL Fire Resistance Directory and shall include the following construction features:
 - Studs** – Wall framing shall consist of min 3-1/2 in. (89 mm) wide steel channel studs spaced max 24 in. (610 mm) OC. Additional min 3-1/2 in. (89 mm) wide steel studs shall be used to completely frame opening.
 - Gypsum Board*** – The gypsum board type, thickness, number of layers, fastener type and sheet orientation shall be as specified in the individual U400 Series Design in the UL Fire Resistance Directory. Max size of opening to be 182 in.² (1174 cm²) with a max dimension of 45-1/2 in. (1156 mm). All vertical studs in opening to remain intact.

The hourly F Rating of the firestop system is equal to the hourly fire rating of the wall assembly in which it is installed.
- Through Penetrants** – One or more metallic pipes or conduits installed within opening. Annular space between penetrants and periphery of opening to be min 0 in. (point contact) to max 2 in. (0 mm to max 51 mm). Space between penetrants to be min 1/4 in. to max 2 in. (6 mm to max 51 mm). Penetrants to be rigidly supported on both sides of wall. The following types and sizes of penetrants may be used:
 - Steel Pipe** – Nom 3 in. (76 mm) diam (or smaller) Schedule 5 (or heavier) steel pipe.
 - Conduit** – Nom 3 in. (76 mm) diam (or smaller) rigid steel conduit or steel electrical metallic tubing.
- Firestop System** – The firestop system shall consist of the following:
 - Packing Material** – Min 3-3/4 in. or 5 in. (95 mm or 127 mm) thickness of min 4 pcf (64 kg/m³) mineral-wool batt insulation firmly packed into opening for 1 and 2 hr rated assemblies, respectively. Packing material to be recessed from both sides of wall assembly to accommodate the required thickness of fill material.
 - Fill, Void or Cavity Material* – Caulk or Sealant** – Min 1/2 in. (13 mm) thickness of caulk applied within annulus, flush with both surfaces of wall. Min 1/4 in. (6 mm) diam bead of caulk applied to gypsum board/penetrant interface at point contact location on both sides of wall.

3M COMPANY – IC 15WB+, CP 25WB+ caulk or FB-3000 WT sealant.

*Bearing the UL Classification Marking

Reprinted from the Online Certifications Directory with permission from Underwriters Laboratories Inc.
Copyright © 2010 Underwriters Laboratories Inc.®



Through Penetrations

Metallic Pipes

1000 Series

Gypsum

WL



UL System No. W-L-1310
XHEZ – Through-penetration Firestop Systems
XHEZ7 – Through-penetration Firestop Systems Certified for Canada

March 22, 2017

| ANSI/UL1479 (ASTM E814) | CAN/ULC S115 |
|-------------------------|-------------------|
| F Rating – 2 Hr | F Rating – 2 Hr |
| T Rating – 0 Hr | FT Rating – 0 Hr |
| | FH Rating – 2 Hr |
| | FTH Rating – 0 Hr |

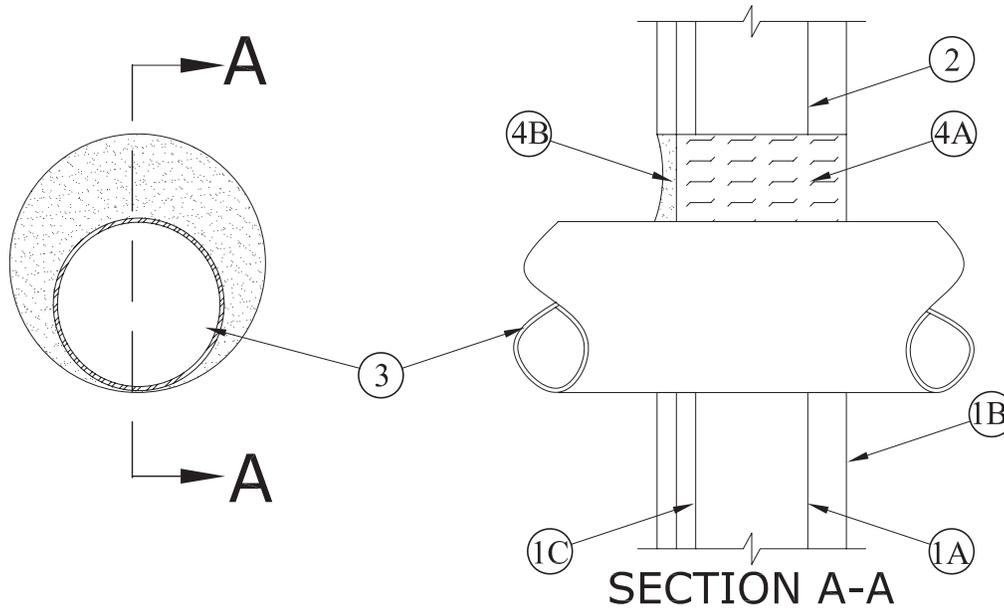

- Wall Assembly** – The 2 hr fire-rated shaft wall assembly shall be constructed of the materials and in the manner specified in the individual U400, V400 or W400 Series Wall and Partition Designs in the UL Fire Resistance Directory and shall include the following construction features:
 - Steel Studs** – C-H -shaped studs, 2-1/2 in. (64 mm) wide by 1-1/2 in. (38 mm) deep, spaced 24 in. (610 mm) OC.
 - Gypsum Board*** – 1 in. (25 mm) thick gypsum board liner panels, supplied in nom 24 in. (610 mm) widths as specified in the individual Wall and Partition Design. Max diam of opening is 10-1/2 in. (267 mm).
 - Gypsum Board*** – Two layers of 5/8 in. (16 mm) thick gypsum board as specified in the individual Wall and Partition Design. Max diam of opening is 10-1/2 in. (267 mm).
- Steel Sleeve** – Cylindrical sleeve fabricated from min 0.019 in. (0.49 mm) thick (28 gauge) galv sheet steel and having a min 2 in. (51 mm) lap along the longitudinal seam. Length of steel sleeve to be equal to thickness of wall or up to 2 in. (51 mm) longer than the thickness of wall such that, when installed, the ends of the sleeve will be flush with wall surface or project up to 1 in. (25 mm) beyond the surface of the wall on each side of the wall assembly. Sleeve installed by coiling the sheet steel to a diam smaller than the max 10-1/2 in. (267 mm) diam through opening, inserting the coil through the opening and releasing the coil to let it uncoil against the circular cutouts in the gypsum board layers.
- Through Penetrants** – One metallic pipe, tubing or conduit installed within the firestop system. Penetrant to be rigidly supported on both sides of wall assembly. Annular space between the penetrant and sleeve shall be min 0 in. (0 mm point contact) to max 2 in. (51 mm). The following types of metallic pipes or conduits may be used:
 - Steel Pipe** – Nom 8 in. (203 mm) schedule 5 (or heavier) steel pipe.
 - Iron Pipe** – Nom 8 in. (203 mm) cast or ductile iron pipe.
 - Copper Tubing** – Nom 4 in. (102 mm) Type L (or heavier) copper tubing.
 - Copper Pipe** – Nom 4 in. (102 mm) Regular (or heavier) copper pipe.
 - Conduit** – Nom 4 in. (102 mm) (or smaller) steel electrical metallic tubing or nom 6 in. (152 mm) (or smaller) rigid steel conduit.

Through Penetrations

Metallic Pipes

1000 Series

WL

UL System No. W-L-1310 (cont.)

4. **Firestop System** – The firestop system shall consist of the following:

- A. **Packing Material** – Min 4-1/8 in. (105 mm) thickness of min 4 pcf (64 kg/m³) mineral wool batt insulation firmly packed into opening as a permanent form. Packing material to be recessed from finished surface of wall (Item 1C) to accommodate the required thickness of fill material.
- B. **Fill, Void or Cavity Materials*-Caulk or Sealant** – Min 5/8 in. (16 mm) thickness of caulk applied within annulus, flush with finished surface of wall assembly.
3M COMPANY – IC 15WB+, CP-25 WB+ caulk or FB-3000 WT sealant

Through Penetrations

Metallic Pipes

1000 Series

WL



*Indicates such products shall bear the UL or cUL Certification Mark for jurisdictions employing the UL or cUL Certification (such as Canada), respectively.

Reprinted from the Online Certifications Directory with permission from UL©

3M Industrial Adhesive and Tapes
Fire Protection Products
3M Center, Building 230-B-S-37
St. Paul, MN 55144-1000

System No. W-L-1323

September 21, 2009

F Rating – 2 Hr

T Ratings – 1-1/4 and 2 Hr (See Item 2)

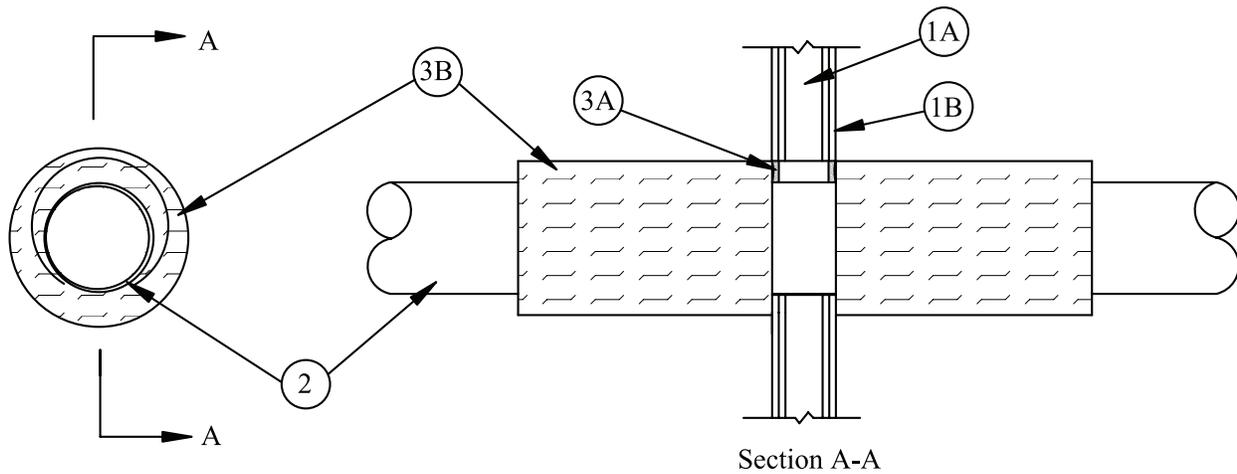

- Wall Assembly** – The 2 hr fire rated gypsum board/stud wall assembly shall be constructed of the materials and in the manner specified in the individual U300 or U400 Series Wall and Partition Designs in the UL Fire Resistance Directory and shall include the following construction features.
 - Studs** – Wall framing may consist of either wood studs or steel channel studs. Wood studs to consist of nom 2 by 4 in. (51 by 102 mm) lumber spaced 16 in. (406 mm) OC. Steel studs to be min 3-1/2 in. (89 mm) wide spaced max 24 in. (610 mm) OC.
 - Gypsum Board*** – Two layers of nom 5/8 in. (16 mm) thick gypsum board, as specified in the individual Wall and Partition Design. Max diam of opening is 12-3/4 in. (324 mm).
- Through-Penetrant** – One metallic pipe or tubing installed concentrically or eccentrically within opening. Annular space between penetrant and periphery of opening shall be min of 0 in. (0 mm) (point contact) to max 2 in. (51 mm). Penetrant to be rigidly supported on both sides of wall assembly. The following types and sizes of penetrants may be used:
 - Steel Pipe** – Nom 10 in. (254 mm) diam (or smaller) Schedule 10 (or heavier) steel pipe.
 - Iron Pipe** – Nom 10 in. (254 mm) diam (or smaller) cast or ductile iron pipe.
 - Copper Tubing** – Nom 4 in. (102 mm) diam (or smaller) Type L (or heavier) copper tubing.
 - Copper Pipe** – Nom 4 in. (102 mm) diam (or smaller) Regular (or heavier) copper pipe.

The Hourly T Rating is 2 Hr for penetrants A and B. The Hourly T Rating is 1-1/4 Hr for penetrants C and D.
- Firestop System** – The firestop system shall consist of the following:
 - Fill, Void or Cavity Materials* – Caulk, Sealant or Putty** – Min 5/8 in. (16 mm) thickness of caulk or putty applied within the annulus, flush with both surfaces of wall.
3M COMPANY – CP 25WB+ caulk, MP+ putty or FB-3000 WT sealant
 - Duct Wrap Material*** – Nom 2 in. (51 mm) thick duct wrap tightly wrapped around penetrant, butted to wall and extending 24 in. (610 mm) beyond both surfaces of wall. Longitudinal seams sealed with foil tape.
3M COMPANY – FireBarrier Duct Wrap 20A, 615 or 615+

*Bearing the UL Classification Mark

Reprinted from the Online Certifications Directory with permission from Underwriters Laboratories Inc.
Copyright © 2010 Underwriters Laboratories Inc.®



System No. W-L-1340

May 23, 2005

F Ratings – 1 and 2 Hr (See Item 1)

T Rating – 0 Hr

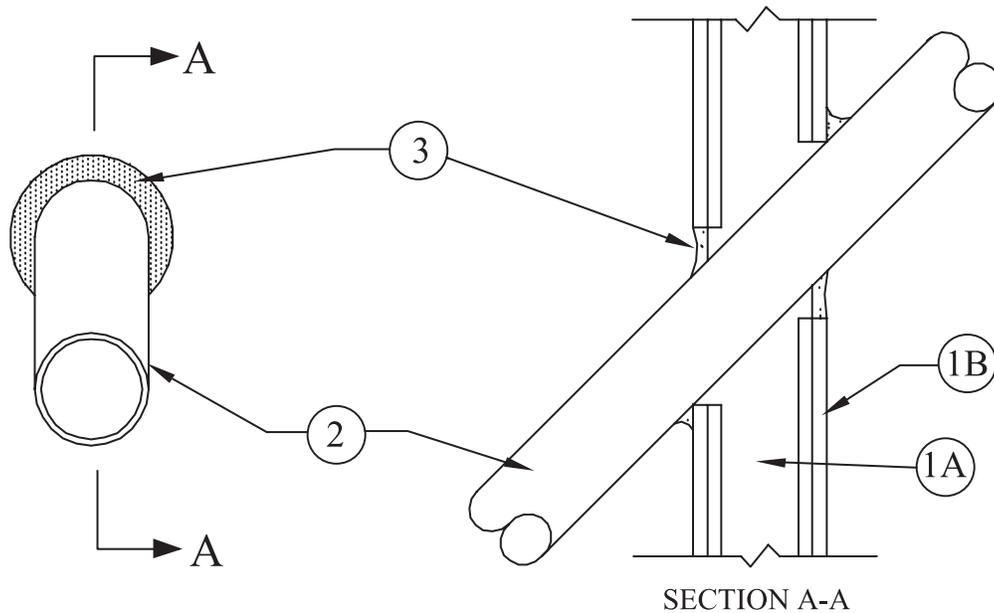

- Wall Assembly** – The 1 or 2 hr fire rated gypsum board/stud wall assembly shall be constructed of the materials and in the manner described in the individual U300, U400 or V400 Series Wall or Partition Design in the UL Fire Resistance Directory and shall include the following construction features:
 - Studs**–Wall framing may consist of either wood studs or steel channel studs. Wood studs to consist of nom 2 in. by 4 in. (51 mm by 102 mm) lumber spaced 16 in. (406 mm) OC. Steel studs to be min 3-1/2 in. (89 mm) wide spaced max 24 in. (610 mm) OC.
 - Gypsum Board*** – The gypsum board type, thickness, number of layers, fastener type and sheet orientation shall be as specified in the individual U300 or U400 Series Design in the UL Fire Resistance Directory. Max diam of opening is 12 in. (305 mm).

The hourly F Rating of the firestop system is equal to the hourly fire rating of the wall assembly in which it is installed.
- Through Penetrants** – One metallic pipe, conduit or tubing installed concentrically or eccentrically within opening. Annular space between penetrant and periphery of opening to be min 0 in. (point contact) to max 3-1/2 in. (0 mm to max 89 mm). The penetrant may be installed at an angle not greater than 45 degrees from perpendicular. Penetrant to be rigidly supported on both sides of wall. The following types and sizes of penetrants may be used:
 - Steel Pipe** – Nom 8 in. (203 mm) diam (or smaller) Schedule 10 (or heavier) steel pipe.
 - Iron Pipe** – Nom 8 in. (203 mm) diam (or smaller) cast or ductile iron pipe.
 - Conduit** – Nom 4 in. (102 mm) diam (or smaller) steel electrical metallic tubing (EMT) or nom 6 in. (152 mm) rigid steel conduit.
 - Copper Tubing** – Nom 4 in. (102 mm) diam (or smaller) Type L (or heavier) copper tubing.
 - Copper Pipe** – Nom 4 in. (102 mm) diam (or smaller) Regular (or heavier) copper pipe.
- Fill, Void or Cavity Material* – Caulk or Sealant** – Min 5/8 in. (16 mm) thickness of caulk applied within annulus, flush with both surfaces of wall. Min 1/2 in. (13 mm) diam bead of caulk applied to gypsum board/penetrant interface at point contact location on both sides of wall.

3M COMPANY – IC 15WB+, CP 25WB+ caulk or FB-3000 WT sealant.

*Bearing the UL Classification Marking

Reprinted from the Online Certifications Directory with permission from Underwriters Laboratories Inc.
Copyright © 2010 Underwriters Laboratories Inc.®



System No. W-L-1341

November 25, 2003

F Ratings – 1 and 2 Hr (See Item 1)

T Rating – 0 Hr

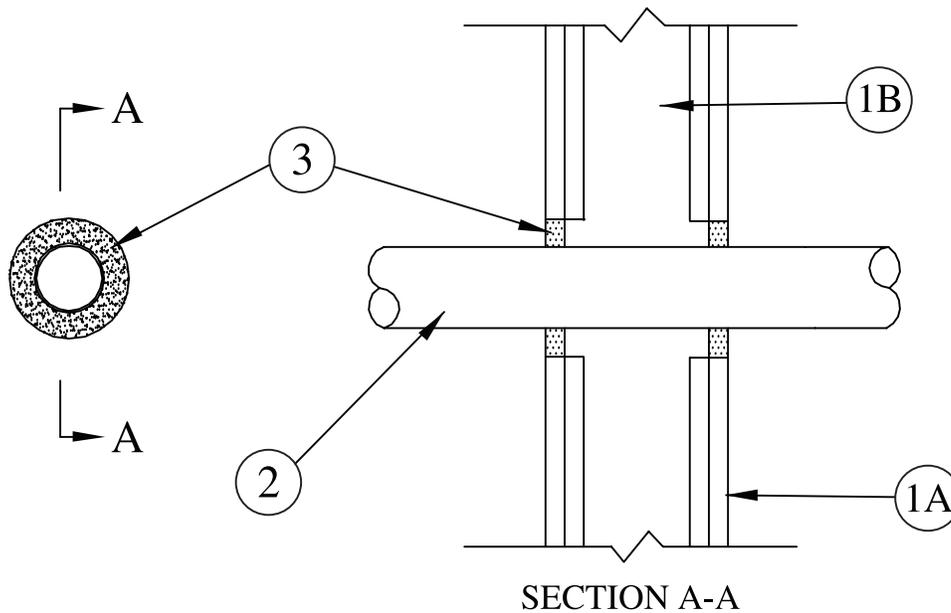

1. **Wall Assembly** – The 1 or 2 hr fire rated gypsum board/stud wall assembly shall be constructed of the materials and in the manner described in the individual U300 or U400 Series Wall or Partition Design in the UL Fire Resistance Directory and shall include the following construction features:

- A. **Studs** – Wall framing may consist of either wood studs or steel channel studs. Wood studs to consist of nom 2 in. by 4 in. (51 mm by 102 mm) lumber spaced 16 in. (406 mm) OC. Steel studs to be min 3-1/2 in. (89 mm) wide spaced max 24 in. (610 mm) OC.
- B. **Gypsum Board*** – The gypsum board type, thickness, number of layers, fastener type and sheet orientation shall be as specified in the individual U300 or U400 Series Design in the UL Fire Resistance Directory. Diam of opening to be min 1/2 in. (13 mm) to max 4 in. (102 mm) greater than outside diam of through-penetrant.

The hourly F Rating of the firestop system is equal to the hourly fire rating of the wall assembly in which it is installed.

2. **Through Penetrants** – One metallic pipe, conduit or tubing centered within opening. Annular space between penetrant and periphery of opening to be min 1/4 in. (6 mm) to max 2 in. (51 mm). Penetrant to be rigidly supported on both sides of wall. The following types and sizes of penetrants may be used:
 - A. **Steel Pipe** – Nom 6 in. (152 mm) diam (or smaller) Schedule 10 (or heavier) steel pipe.
 - B. **Iron Pipe** – Nom 6 in. (152 mm) diam (or smaller) cast or ductile iron pipe.
 - C. **Conduit** – Nom 4 in. (102 mm) diam (or smaller) steel electrical metallic tubing (EMT) or nom 6 in. (152 mm) rigid steel conduit.
 - D. **Copper Tubing** – Nom 3 in. (76 mm) diam (or smaller) Type L (or heavier) copper tubing.
 - E. **Copper Pipe** – Nom 3 in. (76 mm) diam (or smaller) Regular (or heavier) copper pipe.

3. **Fill, Void or Cavity Material*** – Sealant – Min 5/8 in. (16 mm) thickness of sealant applied within annulus, flush with both surfaces of wall.

3M COMPANY – FB-1000 NS

*Bearing the UL Classification Marking

Reprinted from the Online Certifications Directory with permission from Underwriters Laboratories Inc.

Copyright © 2010 Underwriters Laboratories Inc.®



Through Penetrations

Metallic Pipes

1000 Series

Gypsum

WL



UL System No. W-L-1353
XHEZ – Through-penetration Firestop Systems
XHEZ7 – Through-penetration Firestop Systems Certified for Canada

May 02, 2017

| ANSI/UL1479 (ASTM E814) | CAN/ULC S115 |
|-------------------------------------|--------------------------------------|
| F Ratings – 1 and 2 Hr (See Item 1) | F Ratings – 1 and 2 Hr (See Item 1) |
| T Rating – 0 Hr | FT Rating – 0 Hr |
| | FH Ratings – 1 and 2 Hr (See Item 1) |
| | FTH Rating – 0 Hr |

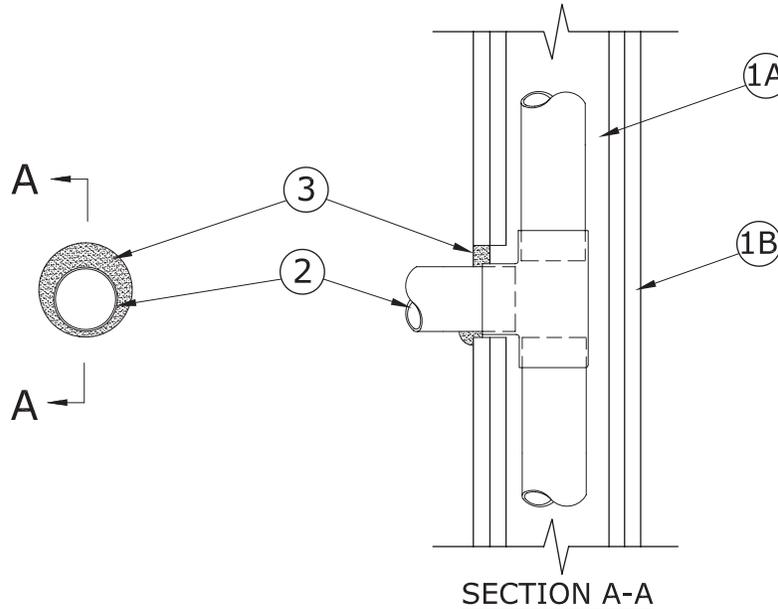

1. Wall Assembly – The 1 or 2 hr fire rated gypsum board/stud wall assembly shall be constructed of the materials and in the manner specified in the individual U300, U400 or V400 Series Wall and Partition Designs in the UL Fire Resistance Directory and shall include the following construction features:

- A. Studs** – Wall framing may consist of either wood studs or steel channel studs. Wood studs to consist of nom 2 by 4 in. (51 by 102 mm) (or larger) lumber spaced 16 in. (406 mm) OC. Steel studs to be min 3-1/2 in. (89 mm) wide and spaced max 24 in. (610 mm) OC.
- B. Gypsum Board*** – Thickness, type, number of layers and fasteners as required in the individual Wall and Partition Design. Max diam of opening is 3-1/2 in. (89 mm).

The hourly F Rating of the firestop system is equal to the hourly fire rating of the wall assembly in which it is installed.

2. Metallic Pipe – Metallic pipe, tube or conduit installed within the stud cavity and connected to metallic tee for use in closed (process or supply) or vented (drain, waste or vent) piping systems. Pipe, tube or conduit penetrating wall assembly on one side of wall to be installed either concentrically or eccentrically with the annular space between the penetrant and the periphery of opening of min 0 in. (0 mm, point contact) to max 1 in. (25 mm). The following types of metallic pipes, tubes, conduits and tees may be used:

- A. Steel Pipe** – Nom 2 in. (51 mm) diam (or smaller) Schedule 10 (or heavier) steel pipe.
- B. Iron Pipe** – Nom 2 in. (51 mm) diam (or smaller) cast or ductile iron pipe.
- C. Copper Tubing** – Nom 2 in. (51 mm) diam (or smaller) Type L (or heavier) copper tubing.
- D. Copper Pipe** – Nom 2 in. (51 mm) diam (or smaller) Regular (or heavier) copper pipe.
- E. Conduit** – Nom 2 in. (51 mm) diam (or smaller) rigid steel conduit or electrical metallic steel tubing (EMT).

2A. Conduit Body* – (Not Shown) - When a steel conduit or EMT is used, nom 2 in. size (or smaller) steel conduit body with steel fittings as an alternate to the metallic tee. Refer to Conduit Fittings (DWTT) category in the UL Electrical Construction Directory.

3. Fill, Void or Cavity Material* – Caulk – Min 5/8 in. (16 mm) thickness of fill material applied within the annulus, flush with surface of wall. At the point contact location between duct and wallboard, a min 1/2 in. (13 mm) diam bead of sealant shall be applied at the wallboard/duct interface on both surfaces of wall assembly.

3M COMPANY – IC 15WB+ caulk, CP 25WB+ caulk or FB-3000 WT Sealant

*Indicates such products shall bear the UL or cUL Certification Mark for jurisdictions employing the UL or cUL Certification (such as Canada), respectively.

Reprinted from the Online Certifications Directory with permission from UL©

Through Penetrations
Metallic Pipes
1000 Series
WL



System No. W-L-1391

May 23, 2011

F Ratings – 1, 2, 3 and 4 Hr (See Item 1)

T Rating – 0 Hr

L Rating At Ambient – 1 CFM/sq ft. (See Item 3B)

L Rating At 400 F – Less Than 1 CFM/sq ft. (See Item 3B)

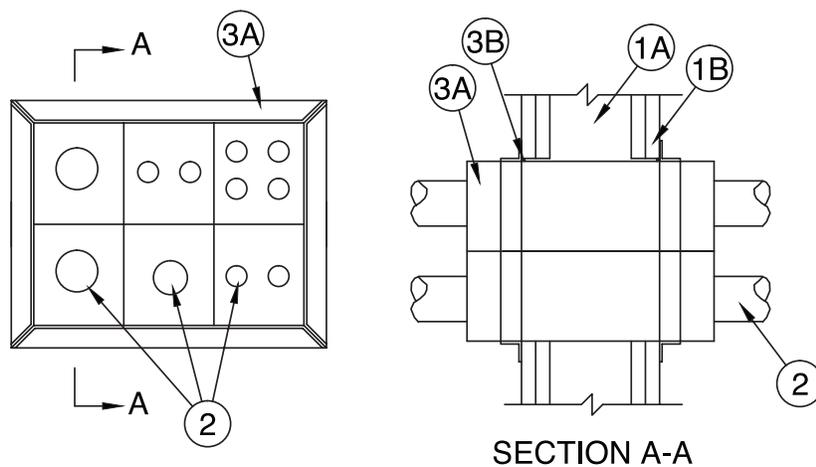

1. **Wall Assembly** – The 1, 2, 3 or 4 hr fire rated gypsum board/stud wall assembly shall be constructed of the materials and in the manner described in the individual U300, U400 or V400 Series Wall and Partition Design in the UL Fire Resistance Directory and shall include the following construction features:

- A. **Studs** – Wall framing may consist of either wood or steel channel studs. Wood studs to consist of nom 2 by 4 in. (51 by 102 mm) lumber spaced 16 in. (406 mm) OC. Steel studs to be min 3-1/2 in. (89 mm) wide spaced max 24 in. (610 mm) OC.
- B. **Gypsum Board*** – The gypsum board type, thickness, number of layers, fastener type and sheet orientation shall be as specified in the individual Wall and Partition Design in the UL Fire Resistance Directory. Max area of opening is 98.5 in.² (635 cm²) with a max dimension of 12-1/8 in. (308 mm) for square devices. Max diam of opening is 2-1/4 in. (57 mm) for nom 2 in. (51 mm) round devices and 4-1/4 in. (108 mm) for nom 4 in. (102 mm) round devices.

The hourly F Rating of the firestop system is equal to the hourly fire rating of the wall assembly in which it is installed.

2. **Through Penetrant** – One or more metallic pipe, tubing or conduit may be installed concentrically or eccentrically within each firestop device (Item 3A). Through penetrant to be rigidly supported on both sides of wall assembly. The following types and sizes of through penetrants may be used:

- A. **Steel Pipe** – Nom 3 in. (76 mm) diam (or smaller) Schedule 10 (or heavier) steel pipe.
- B. **Iron Pipe** – Nom 3 in. (76 mm) diam (or smaller) cast or ductile iron pipe.
- C. **Copper Tubing** – Nom 3 in. (76 mm) diam (or smaller) Type L (or heavier) copper tube.
- D. **Copper Pipe** – Nom 3 in. (76 mm) diam (or smaller) Regular (or heavier) copper pipe.
- E. **Conduit** – Nom 3 in. (76 mm) diam (or smaller) steel electric metallic tubing (EMT) or rigid steel conduit.
- F. **Through-Penetrating Product* – Flexible Metal Piping** – Nom 1-1/4 in. (32 mm) diam (or smaller) steel flexible metal piping.

OMEGA FLEX INC – TracPipe Flexible Gas Piping

3. **Firestop System** – The firestop system shall consist of the following:

- A. **Firestop Device*** – A max of six square firestop devices may be ganged together for 1 and 2 hr rated assemblies. A max of three square firestop devices may be ganged together for 3 and 4 hr rated assemblies. As an alternate, one round device may be centered within a round opening. Each device consists of a nom 2-1/2 by 2-1/2 by 10 in. (64 by 64 by 254 mm), a nom 4 by 4 by 10 in. (102 by 102 by 254 mm), a nom 2 in. (51 mm) diam by 10 in. (254 mm) or a nom 4 in. (102 mm) diam by 10 in. (254 mm) powder coated steel transit incorporating internal intumescent material, foam plugs and mounting flanges. In nom 2-1/2 by 2-1/2 in. (64 by 64 mm) devices, the max nom diam of the through penetrant (Item 2) shall not exceed 1-1/4 in. (32 mm). Firestop device(s) to be installed within opening with nom projecting an equal distance beyond each surface of wall assembly in accordance with the accompanying installation instructions. The annular space between device(s) and periphery of opening shall be min 0 in. (0 mm, point contact) to max 1/8 in. (3.2 mm). Firestop device(s) secured in place by means of fill material (Item 3B) and steel split mounting flanges sized to accommodate the firestop device. Steel split mounting flanges installed on both sides of wall after installation of fill material, and secured together with supplied steel set screws. Nom 1 in. (25 mm) thick pre-cut foam plugs sized to accommodate the through penetrant and installed flush with each end of device on both sides of wall assembly. The foam plug in one or both ends of the device is optional except when L Rating is required (See Item 3B).

3M COMPANY – 3M Fire Barrier Pass-Through Device

- B. **Fill, Void or Cavity Materials* – Putty or Caulk** – Min 1/8 in. (3 mm) bead of fill material applied at interface of gypsum board and firestop devices immediately prior to the installation of the mounting flanges. If three or less cable transits (Item 3A) are ganged together, the fill material may be optional. Also as an option, foam plugs may be recessed into device and the recess filled with putty or caulk flush with the ends of the device. L Rating applies only when fill material is applied at interface of gypsum board and device(s) prior to mounting flanges and with both ends of firestop device(s) filled with nominal 1/8 in. (3.2 mm) of Moldable Putty+.

3M COMPANY – Moldable Putty+, CP 25WB+, IC 15WB+, 3000 WT

*Bearing the UL Classification Mark

Reprinted from the Online Certifications Directory with permission from Underwriters Laboratories Inc.
Copyright © 2011 Underwriters Laboratories Inc.®



System No. W-L-1413

February 07, 2007
 F Ratings – 1 and 2 Hr (See Item 1)
 T Rating – 0 Hr

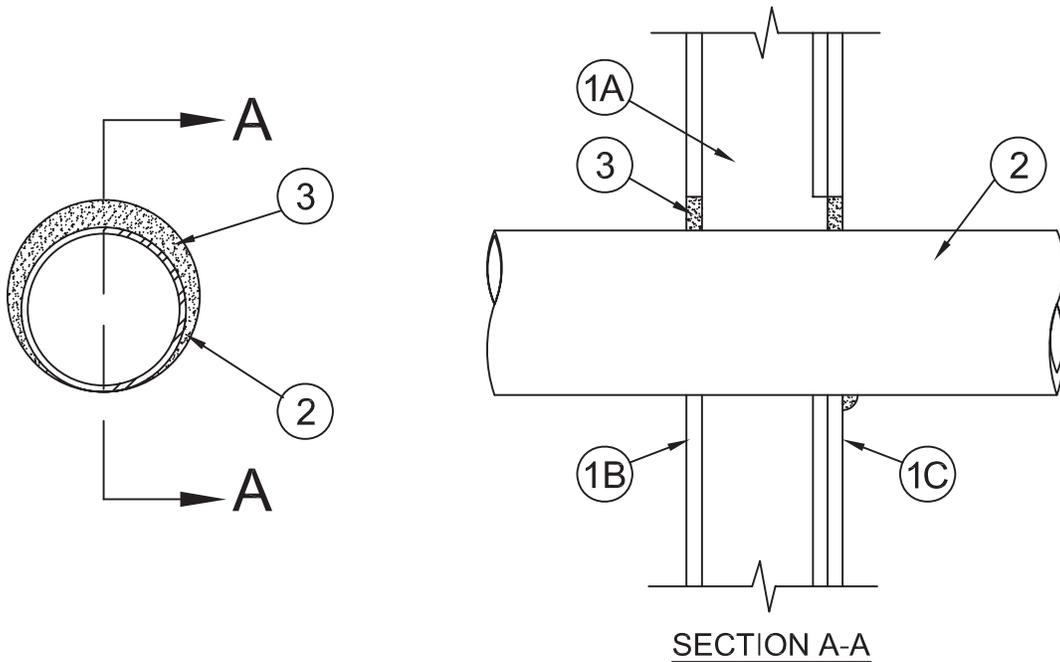

1. **Wall Assembly** – The 1 or 2 hr fire-rated gypsum board/stud shaft wall assembly shall be constructed of the materials and in the manner specified in the individual U400 or V400 Series Wall and Partition Designs in the UL Fire Resistance Directory and shall incorporate the following construction features:
 - A. **Steel Studs** – “C-H” or “C-T” shaped studs, min 2-1/2 in. (64 mm) wide by 1-1/2 in. (38 mm) deep, fabricated from min No. 25 gauge (0.6 mm thick) galv steel, spaced max 24 in. (610 mm) OC.
 - B. **Gypsum Board*** – 1 in. (25 mm) thick, 24 in. (610 mm) wide gypsum liner panels installed vertically. Max diam of circular cutout in gypsum liner panel is 10 in. (254 mm).
 - C. **Gypsum Board*** – 1/2 in. or 5/8 in. (13 or 16 mm) thick, 48 in. (1.2 m) wide gypsum boards. The gypsum board type, thickness, number of layers, fastener type and sheet orientation shall be as specified in the individual Wall and Partition Design. Max diam of circular cutout in gypsum board is 10 in. (254 mm).

The hourly F Rating of the firestop system is equal to the hourly fire rating of the wall assembly in which it is installed.

2. **Through Penetrant** – One metallic pipe, conduit or tubing installed either concentrically or eccentrically within the firestop system. The annular space between pipe, conduit or tubing and periphery of opening shall be min of 0 in. (0 mm, point contact) to max 2 in. (51 mm). Pipe, conduit or tubing to be rigidly supported on both sides of wall assembly. The following types and sizes of metallic pipes, conduits or tubing may be used:
 - A. **Steel Pipe** – Nom 8 in. (203 mm) diam (or smaller) Schedule 10 (or heavier) steel pipe.
 - B. **Iron Pipe** – Nom 8 in. (203 mm) diam (or smaller) service weight (or heavier) cast iron soil pipe, nom 8 in. (203 mm) diam (or smaller) or Class 50 (or heavier) ductile iron pressure pipe.
 - C. **Conduit** – Nom 6 in. (152 mm) diam (or smaller) steel conduit or nom 4 in (102 mm) diam (or smaller) steel electrical metallic tubing.
 - D. **Copper Tubing** – Nom 6 in. (152 mm) diam (or smaller) Type L (or heavier) copper tubing.
 - E. **Copper Pipe** – Nom 6 in. (152 mm) diam (or smaller) Regular (or heavier) copper pipe.
3. **Fill, Void or Cavity Materials* – Caulk or Sealant** – Min 1 in. (25 mm) thickness of fill material applied within the gypsum board liner panel flush with the faces of the liner panel. Min 5/8 in. (16 mm) thickness of fill material applied within the gypsum board annulus, flush with the finished side of the wall. Min 1/2 in. (13 mm) diam bead of caulk applied to the penetrant/gypsum board interface at the point contact location on the finished side of the wall.

3M COMPANY – CP25WB+ Caulk or FB-3000 WT Sealant

*Bearing the UL Classification Mark

Reprinted from the Online Certifications Directory with permission from Underwriters Laboratories Inc.

Copyright © 2010 Underwriters Laboratories Inc.®



System No. W-L-1414

February 07, 2007

F Ratings – 1 and 2 Hr (See Item 1)

T Rating – 0 Hr

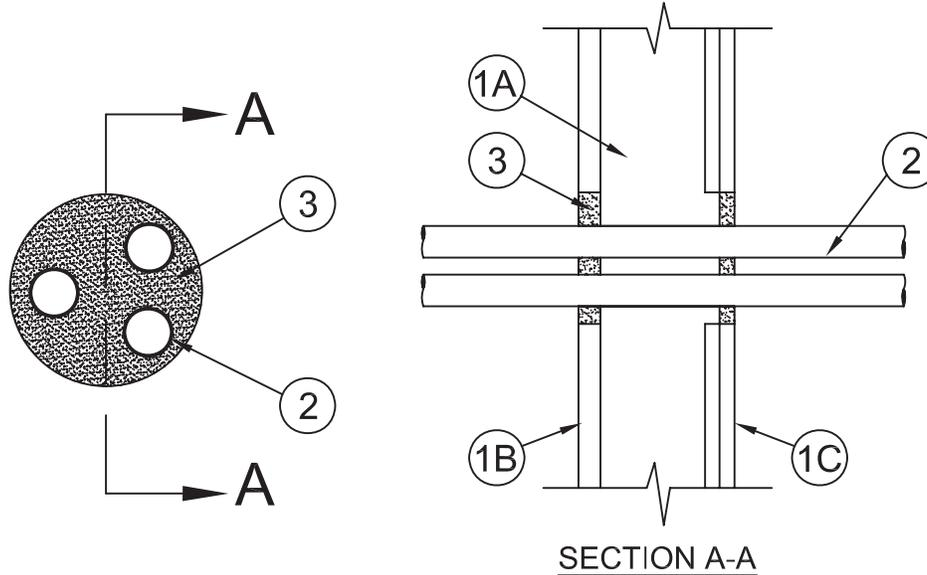

- Wall Assembly** – The 1 or 2 hr fire-rated gypsum board/stud shaft wall assembly shall be constructed of the materials and in the manner specified in the individual U400 or V400 Series Wall and Partition Designs in the UL Fire Resistance Directory and shall incorporate the following construction features:
 - Steel Studs** – “C-H” or “C-T” shaped studs, min 2-1/2 in. (64 mm) wide by 1-1/2 in. (38 mm) deep, fabricated from min No. 25 gauge (0.6 mm thick) galv steel, spaced max 24 in. (610 mm) OC.
 - Gypsum Board*** – 1 in. (25 mm) thick, 24 in. (610 mm) wide gypsum liner panels installed vertically. Max diam of circular cutout in gypsum liner panel is 4-1/2 in. (114 mm).
 - Gypsum Board*** – 1/2 in. or 5/8 in. (13 or 16 mm) thick, 48 in. (1.2 m) wide gypsum boards. The gypsum board type, thickness, number of layers, fastener type and sheet orientation shall be as specified in the individual Wall and Partition Design. Max diam of circular cutout in gypsum board is 4-1/2 in. (114 mm).

The hourly F Rating of the firestop system is equal to the hourly fire rating of the wall assembly in which it is installed.

- Through Penetrants** – One or more metallic pipes, conduits or tubes or flexible metal pipes installed concentrically or eccentrically within opening. Annular space between penetrants and periphery of opening to be min 1/4 in. (6 mm) to max 1 in. (25 mm). Space between penetrants shall be min 1/4 in. (6 mm) to max 1 in. (25 mm). Penetrants to be rigidly supported on both sides of wall. The following types and sizes of penetrants may be used:
 - Steel Pipe** – Nom 3 in. (76 mm) diam (or smaller) Schedule 5 (or heavier) steel pipe.
 - Iron Pipe** – Nom 3 in. (76 mm) diam (or smaller) cast or ductile iron pipe.
 - Conduit** – Nom 3 in. (76 mm) diam (or smaller) steel conduit or steel electrical metallic tubing.
 - Copper Tubing** – Nom 2 in. (51 mm) diam (or smaller) Type L (or heavier) copper tubing.
 - Copper Pipe** – Nom 2 in. (51 mm) diam (or smaller) Regular (or heavier) copper pipe.
 - Through Penetrating Product* – Flexible Metal Piping** – Nom 1 in. (25 mm) diam (or smaller) steel flexible metal gas piping. Plastic covering on piping may or may not be removed on both sides of floor or wall assembly.

OMEGA FLEX INC

GASTITE, DIV OF TITEFLEX

WARD MFG INC

- Fill, Void or Cavity Materials* – Caulk or Sealant** – Min 1 in. (25 mm) thickness of fill material applied within the gypsum board liner panel flush with the faces of the liner panel. Min 5/8 in. (16 mm) thickness of fill material applied within the gypsum board annulus, flush with the finished side of the wall.

3M COMPANY – CP 25WB+ Caulk or FB-3000 WT Sealant

*Bearing the UL Classification Mark

Reprinted from the Online Certifications Directory with permission from Underwriters Laboratories Inc.
Copyright © 2010 Underwriters Laboratories Inc.®



System No. W-L-1426

December 02, 2008

F Ratings – 1 and 2 Hr (See Item 1)

T Rating – 0 Hr

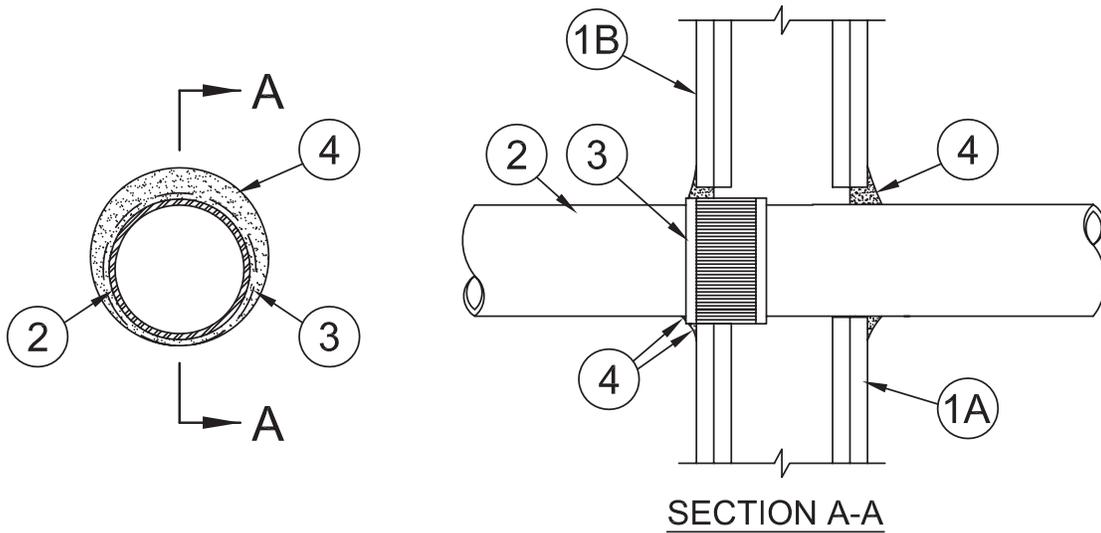

- Wall Assembly** – The 1 or 2 h fire-rated gypsum board/stud wall assembly shall be constructed of the materials and in the manner described in the individual U300, U400 or V400 Series Wall and Partition Designs in the UL Fire Resistance Directory and shall include the following construction features:

- Studs** – Wall framing may consist of either wood studs or steel channel studs. Wood studs to consist of nom 2 by 4 in. (51 by 102 mm) lumber spaced 16 in. (406 mm) OC. Steel studs to be min 3-1/2 in. (89 mm) wide and spaced max 24 in. (610 mm) OC.
- Gypsum Board*** – Thickness, type, number of layers and fasteners as specified in the individual Wall and Partition Design. Max diam of opening is 5-1/2 in. (140 mm).

The hourly F Rating of the firestop system is equal to the hourly assembly rating of the wall assembly in which it is installed.

- Through Penetrant** – One metallic pipe to be installed eccentrically or concentrically within the firestop system. Pipe to be rigidly supported on both sides of the wall assembly. The following types and sizes of metallic pipes may be used:
 - Steel Pipe** – Nom 4 in. (102 mm) diam (or smaller) Schedule 10 (or heavier) steel pipe.
 - Iron Pipe** – Nom 4 in. (102 mm) diam (or smaller) cast or ductile iron pipe.
- Compression Coupling** – Metallic pipes to be secured together with compression type pipe coupling with elastomeric gasket and a stainless steel jacket with stainless steel band clamps. Coupling to be installed partially within opening with min 1/2 in. (13 mm) of coupling protruding from wall. The annular space between the pipe or coupling and the periphery of the opening shall be min 0 in. (0 mm, point contact) to max 1/2 in. (13 mm).
- Fill, Void or Cavity Material* – Caulk or Sealant** – Min 5/8 in. (16 mm) thickness of fill material applied within annulus, flush with each surface of the wall assembly. Where annular space ranges from point contact to 1/4 in. (6 mm) wide a min 1/2 in. (13 mm) diam bead of fill material is to be applied at gypsum board/coupling or gypsum board/pipe interface on both sides of wall. An additional min 1/8 in. (3.2 mm) diam bead of fill material is to be applied at the end of the compression coupling at the coupling/pipe interface where the coupling extends outside of the wall.

3M COMPANY

3M FIRE PROTECTION PRODUCTS – IC 15WB+, CP 25WB+ or FB-3000 WT

*Bearing the UL Classification Mark

Reprinted from the Online Certifications Directory with permission from Underwriters Laboratories Inc.
Copyright © 2010 Underwriters Laboratories Inc.®



System No. W-L-1450

April 07, 2009

F Ratings – 1 and 2 Hr (See Item 1)

T Rating – 0 Hr

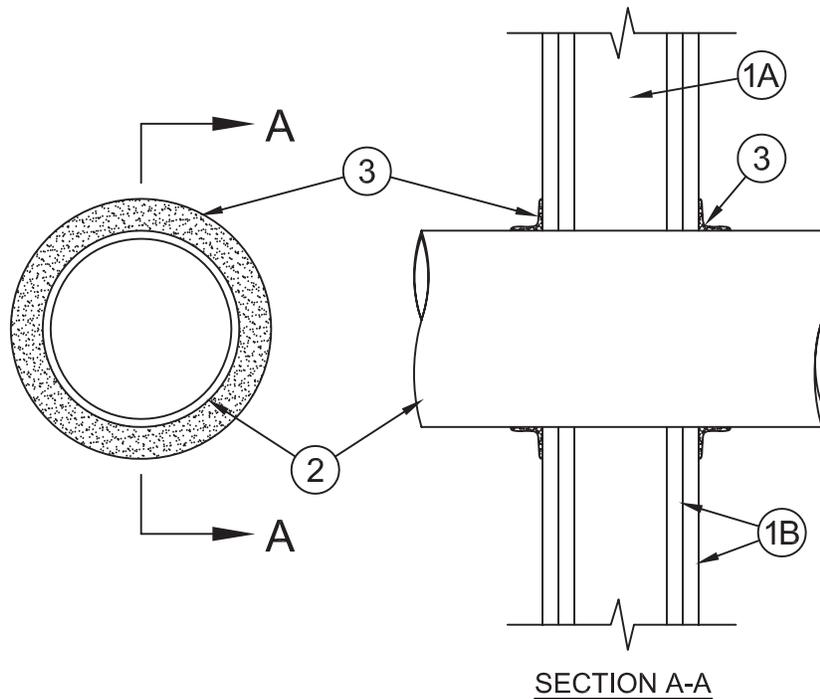

- Wall Assembly** – The 1 or 2 hr fire rated gypsum board/stud wall assembly shall be constructed of the materials and in the manner described in the individual U300, U400 or V400 Series Wall and Partition Design in the UL Fire Resistance Directory and shall include the following construction features:
 - Studs** – Wall framing may consist of either wood studs or steel channel studs. Wood studs to consist of nom 2 by 4 in. (51 by 102 mm) lumber spaced 16 in. (406 mm) OC. Steel studs to be min 3-5/8 in. (92 mm) wide and spaced max 24 in. (610 mm) OC.
 - Gypsum Board*** – The gypsum board type, thickness, number of layers, fastener type and sheet orientation shall be as specified in the individual U300, U400 or V400 Series Design in the UL Fire Resistance Directory. Max diam of opening is 12-3/4 in. (324 mm).

The hourly F Rating of the firestop system is equal to the hourly fire rating of the wall assembly in which it is installed.
- Through-Penetrant** – One metallic pipe, conduit or tubing installed within the firestop system. The through penetrant to be installed with continuous point contact. Pipe, conduit or tubing to be rigidly supported on both sides of wall assembly. The following types and sizes of metallic pipes, conduits or tubing may be used:
 - Steel Pipe** – Nom 12 in. (305 mm) (diam (or smaller) Schedule 10 (or heavier) steel pipe.
 - Iron Pipe** – Nom 12 in. (305 mm) diam (or smaller) service weight (or heavier) cast iron soil pipe or Class 50 (or heavier) ductile iron pressure pipe.
 - Conduit** – Nom 6 in. (152 mm) diam (or smaller) galv steel conduit or nom 4 in. (102 mm) diam (or smaller) steel electrical metallic tubing.
 - Copper Tubing** – Nom 6 in. (152 mm) diam (or smaller) Type L (or heavier) copper tubing.
 - Copper Pipe** – Nom 6 in. (152 mm) diam (or smaller) Regular (or heavier) copper pipe.
- Fill, Void or Cavity Material*** – **Caulk** – Bead of fill material lapping min 1 in. (25 mm) onto gypsum board and min 1/2 in. (13 mm) onto penetrant around outer circumference of through penetrant on both surfaces of wall assembly.

3M COMPANY

3M FIRE PROTECTION PRODUCTS – CP 25WB+ Caulk, IC 15WB+ Caulk, FB-3000 WT Sealant

*Bearing the UL Classification Mark

Reprinted from the Online Certifications Directory with permission from Underwriters Laboratories Inc.
Copyright © 2010 Underwriters Laboratories Inc.®



Through Penetrations

Metallic Pipes

1000 Series

Gypsum

WL

System No. W-L-1453

March 27, 2009

F Ratings – 1 and 2 Hr (See Item 1)

T Rating – 0 Hr

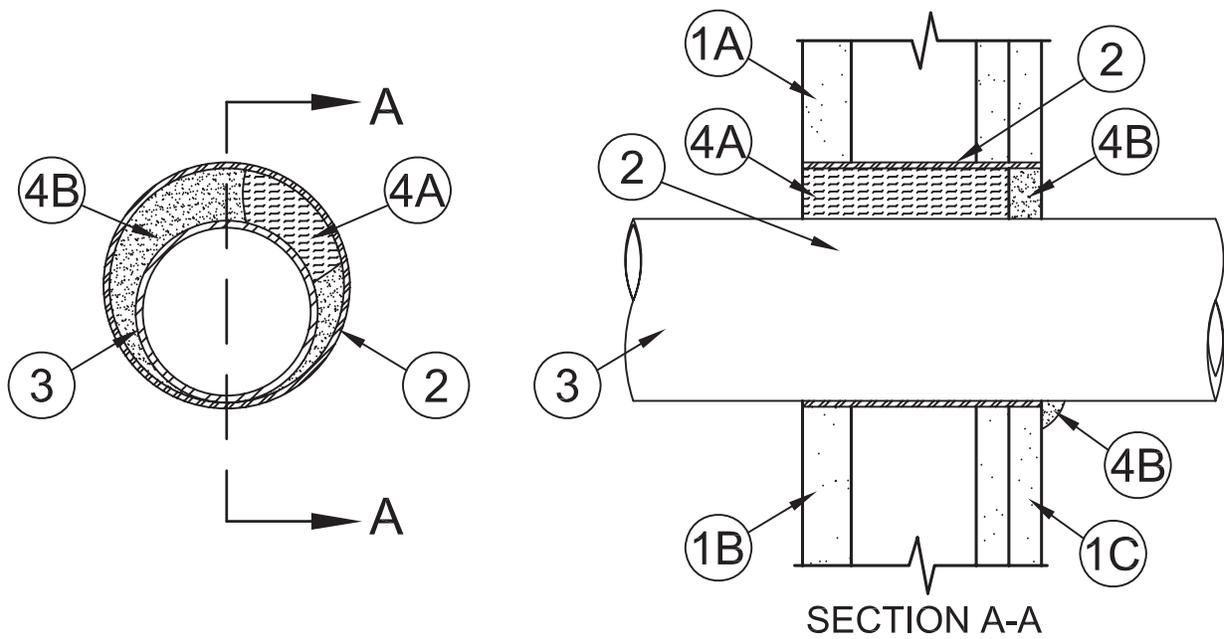

1. **Wall Assembly** – The 1 or 2 hr fire-rated gypsum board/stud shaft wall assembly shall be constructed of the materials and in the manner specified in the individual U400 and V400 Series Wall and Partition Designs in the UL Fire Resistance Directory and shall incorporate the following construction features:
 - A. **Steel Studs** – “C-H”, “C-T” or “T” shaped studs, min 2-1/2 in. (64 mm) wide by 1-1/2 in. (38 mm) deep, fabricated from min No. 25 gauge galv steel, spaced max 24 in. (610 mm) OC.
 - B. **Gypsum Board*** – 1 in. (25 mm) thick, 24 in. (610 mm) wide gypsum liner panels installed vertically. Circular cutout in gypsum liner panel to be min 1 in. (25 mm) to max 2-1/2 in. (64 mm) larger than outside diam of through penetrant (Item 3). Max diam of circular cutout in gypsum liner panel is 11 in. (279 mm).
 - C. **Gypsum Board*** – 1/2 in. (13 mm) or 5/8 in. (16 mm) thick, 48 in. (1220 mm) wide gypsum boards. The gypsum board type, thickness, number of layers, fastener type and sheet orientation shall be as specified in the individual Wall and Partition Design. Circular cutout in gypsum board to align with and be equal in diam to the circular cutout in the liner panel (Item 1B).

The hourly F Rating of the firestop system is equal to the hourly fire rating of the wall assembly in which it is installed.
2. **Metallic Sleeve** – Cylindrical sleeve fabricated from min No. 30 gauge galv sheet steel and having a min 2 in. (51 mm) lap along the longitudinal seam. Length of the sleeve to be equal to the thickness of the wall. Sleeve installed by coiling the sheet steel to a diam smaller than the through opening, inserting the coil through the opening and releasing the coil to let it uncoil against the circular cutouts in the gypsum board layers. The ends of the steel sleeve shall be flush with each surface of the wall.
3. **Through Penetrant** – One metallic pipe, tube or conduit installed concentrically or eccentrically within the firestop system. The annular space between the pipe, tube or conduit and the periphery of the sleeved opening to be min 0 in. (0 mm, point contact) to max 2-3/8 in. (60 mm). Pipe, tube or conduit to be rigidly supported on both sides of wall assembly. One of the following types and sizes of pipe, tube or conduit may be used:
 - A. **Steel Pipe** – Nom 8 in. (203 mm) diam (or smaller) Schedule 5 (or heavier) steel pipe.
 - B. **Iron Pipe** – Nom 8 in. (203 mm) diam (or smaller) cast or ductile iron pipe.
 - C. **Conduit** – Nom 4 in. (102 mm) diam (or smaller) rigid steel conduit, steel electrical metallic tubing (EMT) or flexible steel conduit.
 - D. **Copper Pipe or Tube** – Nom 4 in. (102 mm) diam (or smaller) Regular (or heavier) copper pipe or Type M (or heavier) copper tube.
4. **Firestop System** – The firestop system consist of the following items:
 - A. **Packing Material** – Min 4 pcf (64 kg/m³) mineral wool batt insulation firmly packed into sleeved opening as a permanent form. Packing material to extend throughout thickness of wall except for a 5/8 in. (16 mm) deep recess on the finished side of wall to accommodate the fill material.
 - B. **Fill Void or Cavity Materials* – Sealant** – Min 5/8 in. (16 mm) thickness of fill material applied within sleeve, flush with finished surface of wall. At the point contact location, a min 3/8 in. (10 mm) diam bead of fill material shall be applied at the penetrant/sleeve interface.

3M COMPANY

3M FIRE PROTECTION PRODUCTS – FB-3000 WT or FB-1000 NS Sealant

*Bearing the UL Classification Mark

Reprinted from the Online Certifications Directory with permission from Underwriters Laboratories Inc.

Copyright © 2010 Underwriters Laboratories Inc.®



System No. W-L-1466

April 30, 2013

F Rating – 1 and 2 Hr (See Item 1)
T Ratings – 0 and 1/2 Hr (See Item 1)
F Rating – 1 and 2 Hr (See Item 1)
FT Ratings – 0 and 1/2 Hr (See Item 1)
FH Rating – 1 and 2 Hr (See Item 1)
FTH Ratings – 0 and 1/2 Hr (See Item 1)

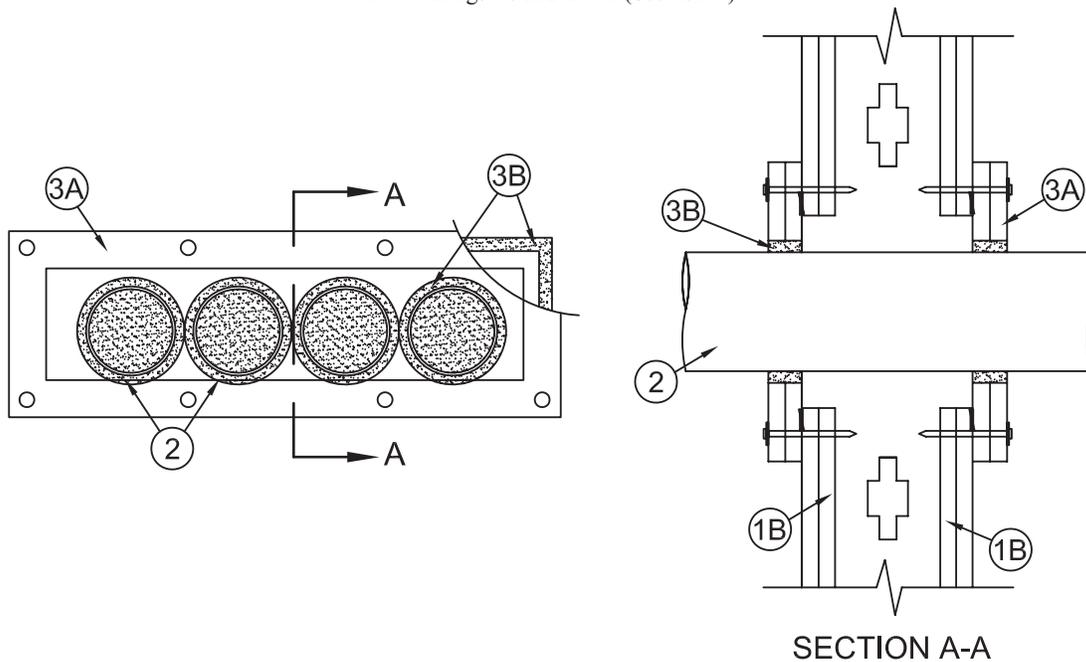

- Wall Assembly** – The 1 or 2 hr fire rated gypsum board/stud wall assembly shall be constructed of the materials and in the manner specified in the individual U300, U400, V400 or W400 Series Wall and Partition Designs in the UL Fire Resistance Directory and shall include the following construction features:
 - Studs** – Wall framing may consist of either wood studs or steel channel studs. Wood studs to consist of nom 2 by 4 in. (51 by 102 mm) lumber spaced 16 in. (406 mm) OC. Steel studs to be min 3-5/8 in. (92 mm) wide and spaced max 24 in. (610 mm) OC.
 - Gypsum Board*** – The gypsum board type, thickness, number of layers, fastener type and sheet orientation shall be as specified in the individual U300, U400, V400 or W400 Series Design in the UL Fire Resistance Directory. Max area of rectangular opening is 192 sq in. (0.12 m²) with max height dimension of 6 in. (152 mm).

The hourly F Rating of the firestop system is equal to the hourly fire rating of the wall assembly in which it is installed. The hourly T Rating of the firestop system is 0 Hr or 1/2 Hr when installed in 1 Hr or 2 Hr fire rated wall assembly, respectively.
- Through Penetrants** – A maximum of six metallic pipes, conduit or tubing installed either concentrically or eccentrically within the firestop system. The annular space between penetrant and periphery of opening shall be min 0 in. (point contact) to max 1-7/8 in. Penetrant to be rigidly supported on both sides of wall assembly. The following types and sizes of penetrants may be used:
 - Steel Pipe** – Nom 4 in. diam (or smaller) Schedule 10 (or heavier) steel pipe.
 - Iron Pipe** – Nom 4 in. diam (or smaller) cast or ductile iron pipe.
 - Conduit** – Nom 4 in. diam (or smaller) rigid steel conduit or steel electrical metallic tubing (EMT).
 - Copper Tubing** – Nom 4 in. diam (or smaller) Type L (or heavier) copper tubing.
 - Copper Pipe** – Nom 4 in. diam (or smaller) Regular (or heavier) copper pipe.
- Firestop System** – The firestop system shall consist of the following:
 - Gypsum Board*** – Two-piece patch consisting of two layers of min 5/8 in. (16 mm) thick gypsum board cut to follow the contours of the penetrants with a nom 1/4 in. (6 mm) annulus around each penetrant. Patch to be sized to overlap wall opening min 2 in. (51 mm) on all sides and cut into two halves such that a horizontal seam traverses the opening to permit installation around the penetrants. Each layer of the patch to be individually installed and secured to underlying gypsum board with caulk (Item 3B) and with No. 10 by 1-1/4 in. (32 mm) long Type G laminating screws. Top and bottom half of each patch layer shall be tightly butted together. Laminating screws for each layer to be located 1 in. (25 mm) from patch edges and spaced max 6 in. (152 mm) OC around perimeter of patch.
 - Fill, Void or Cavity Materials* – Caulk or Sealant** – Min 1/4 in. (6 mm) diam continuous bead of fill material applied beneath first layer of gypsum patch and between first and second layers of gypsum patch. Fill material bead located approx 1 in. (25 mm) from edges of patch. Additional fill material installed to fill all seams between patch sections and to fill the annular spaces around the individual penetrants flush with both surfaces of the gypsum board patch. An additional 5/8 in. (16 mm) crown bead of fill material shall be applied over the butted seam of the gypsum board patch and around the entire perimeter of each penetrant.

3M COMPANY

3M FIRE PROTECTION PRODUCTS – IC 15 WB+ Caulk, CP 25WB+ Caulk or FB-3000 WT Sealant

*Bearing the UL Classification Mark

Reprinted from the Online Certifications Directory with permission from UL
© 2013 UL LLC



System No. W-L-1474

November 02, 2012

ANSI/UL1479 (ASTM E814)

F Rating – 2 Hr

T Rating – 0 Hr

CAN/ULC S115

F Rating – 2 Hr

FT Rating – 0 Hr

FH Rating – 2 Hr

FTH Rating – 0 Hr

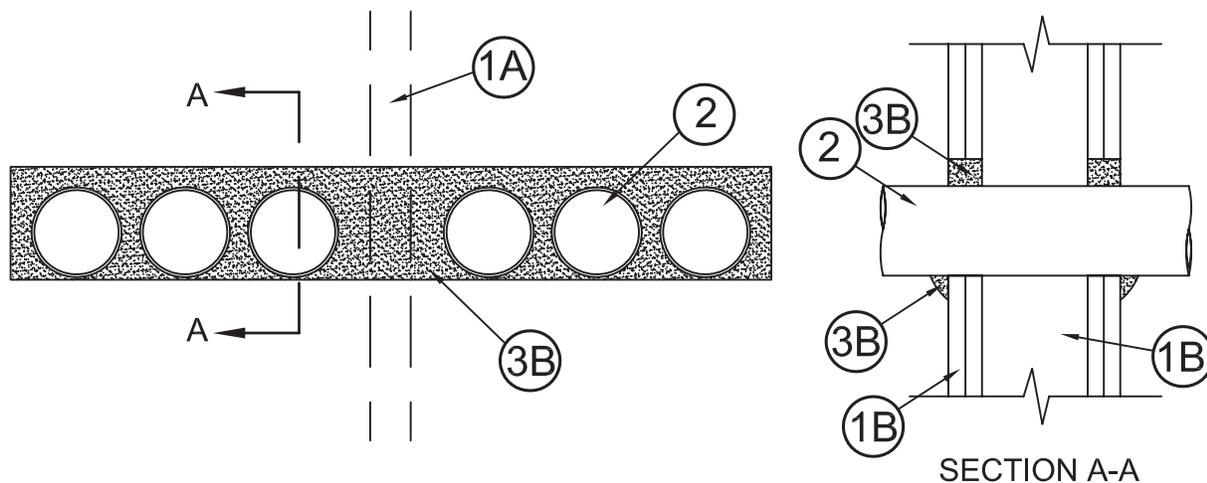

- Wall Assembly** – The 2 hr fire-rated gypsum board/stud wall assembly shall be constructed of the materials and in the manner described in the individual U400, V400 or W400 Series Wall or Partition Designs in the UL Fire Resistance Directory and shall include the following construction features:
 - Studs** – Wall framing shall consist of min 3-1/2 in. (89 mm) wide steel studs spaced max 24 in. (610 mm) OC. If stud is removed within the area opening, the opening is to be completely framed with additional studs (not shown).
 - Gypsum Board*** – Min two layers of 5/8 in. gypsum board attached to studs with fasteners, as specified in the individual U400, V400 or W400 Series design. Max height of opening is 6 in. (152 mm). Max width of opening is 36 in. (914 mm).
- Through Penetrants** – Multiple tubes, pipes or conduits installed in single layer array within the firestop system. The annular space between the penetrants and the edges of the opening shall be min 0 in. (point contact) to max 2 in. (51 mm). The separation between penetrants to be min 1-1/4 in. (32 mm) to max 2 in. (51 mm). Penetrants to be rigidly supported on both sides of wall assembly. The following types and sizes of penetrants may be used:
 - Steel Pipe** – Nom 4 in. (102 mm) diam (or smaller) Schedule 5 (or heavier) steel pipe.
 - Conduit** – Nom 4 in. (102 mm) diam (or smaller) rigid steel conduit or steel electrical metallic tubing (EMT).
 - Iron Pipe** – Nom 4 in. (102 mm) diam (or smaller) cast or ductile iron pipe.
 - Copper Tubing** – Nom 4 in. (102 mm) diam (or smaller) Type L (or heavier) copper tubing.
 - Copper Pipe** – Nom 4 in. (102 mm) diam (or smaller) Regular (or heavier) copper pipe.
- Firestop System** – The firestop system shall consist of the following:
 - Forming Material** – (Optional, Not Shown) - Foam backer rod, mineral wool batt insulation or glass fiber insulation packed into opening and recessed min 1-1/4 in. (32 mm) from each surface of the wall to accommodate fill material.
 - Fill Void or Cavity Materials* – Sealant** – Min 1-1/4 in. (32 mm) thickness of fill material installed to completely fill annular space between penetrants and gypsum board, flush with each surface of wall. Min 1/4 in. diam bead of fill material applied to the penetrant/wall interface at the point contact locations on both sides of the wall.

3M COMPANY

3M FIRE PROTECTION PRODUCTS – IC 15WB+, CP 25WB+ caulk or FB-3000 WT sealant

*Bearing the UL Classification Mark

Reprinted from the Online Certifications Directory with permission from UL

© 2013 UL LLC



System No. W-L-1478

August 20, 2013

ANSI/UL1479 (ASTM E814)

F Ratings – 1 and 2 Hr (See Item 1)

T Ratings – 0 and 3/4 Hr (See Item 1)

CAN/ULC S115

F Ratings – 1 and 2 Hr (See Item 1)

FT Ratings – 0 and 3/4 Hr (See Item 1)

FH Ratings – 1 and 2 Hr (See Item 1)

FTH Ratings – 0 and 3/4 Hr (See Item 1)

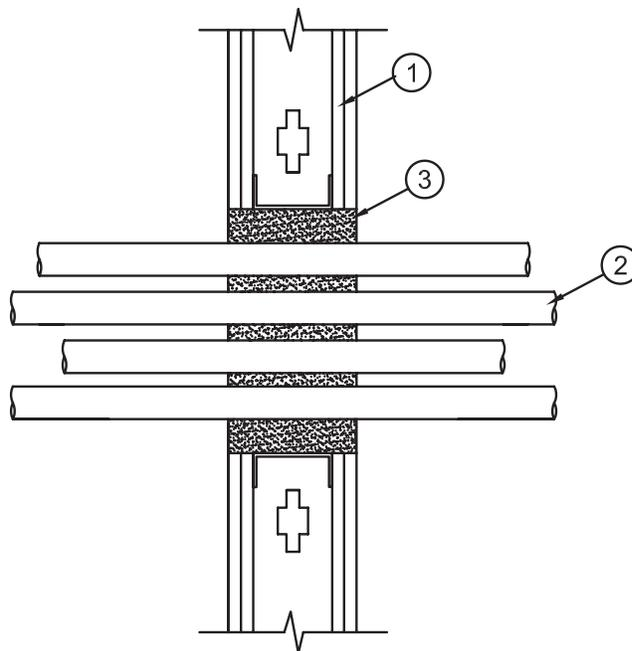
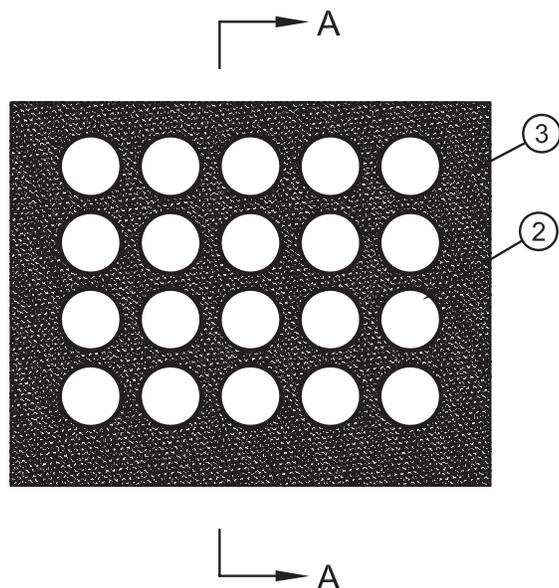

SECTION A-A

- Wall Assembly** – The 1 or 2 hr fire rated wallboard/stud wall assembly shall be constructed of the materials and in the manner specified in the individual U300, U400 or V400 Series Wall and Partition Designs in the UL Fire Resistance Directory and shall include the following construction features.
 - Studs** – Wall framing shall consist of either wood studs or steel channel studs. Wood studs to consist of nom 2 by 4 in. (51 by 102 mm) lumber spaced 16 in. (406 mm) OC. Steel studs to be min 3-1/2 in. (89 mm) wide and spaced max 24 in. (610 mm) OC. Additional framing members shall be used to frame all sides of opening.
 - Gypsum Board*** – The gypsum board type, thickness, number of layers, fastener type and sheet orientation shall be as specified in the individual Wall and Partition Design in the UL Fire Resistance Directory. Max area of opening is 720 in² (4645 cm²) with max dimension of 30 in. (762 mm).

The hourly F and FH Rating of the firestop system is equal to the hourly fire rating of the wall assembly in which it is installed. The hourly T, FT and FTH Rating of the firestop system is 3/4 hr for 2 hr rated walls and 0 hr for 1 hr rated walls.
- Through Penetrant** – One or more metallic penetrants to be installed within the opening. The annular space between penetrants shall be min 1 in. (25 mm) to max 2 in. (51 mm). The annular space between penetrants and periphery of opening shall be min 1 in. (25 mm) to max 3 in. (76 mm). Penetrants to be rigidly supported on both sides of wall assembly. The following types and sizes of penetrants may be used:
 - Conduit** – Nom 4 in. (102 mm) diam (or smaller) steel electrical metallic tubing or 4 in. (102 mm) diam (or smaller) steel conduit.
- Fill, Void or Cavity Material* – Foam** – Foam fill material shall be applied to completely fill the annular space between penetrants and between penetrants and periphery of wall opening to the full thickness of the wall.

3M COMPANY 3M FIRE PROTECTION PRODUCTS – Fire Barrier Rated Foam, FIP 1-Step

*Bearing the UL Classification Mark

Reprinted from the Online Certifications Directory with permission from UL

© 2013 UL LLC



System No. W-L-1479

August 01, 2013

ANSI/UL1479 (ASTM E814)

F Ratings – 2 Hr

T Rating – 1/2 Hr

L Rating at Ambient - Less than 1 CFM/sq ft

L Rating at 400 F - Less than 1 CFM/sq ft

CAN/ULC S115

F Ratings – 2 Hr

FT Rating – 1/2 Hr

FH Ratings – 2 Hr

FTH Rating – 1/2 Hr

L Rating at Ambient - Less than 1 CFM/sq ft

L Rating at 400 F - Less than 1 CFM/sq ft

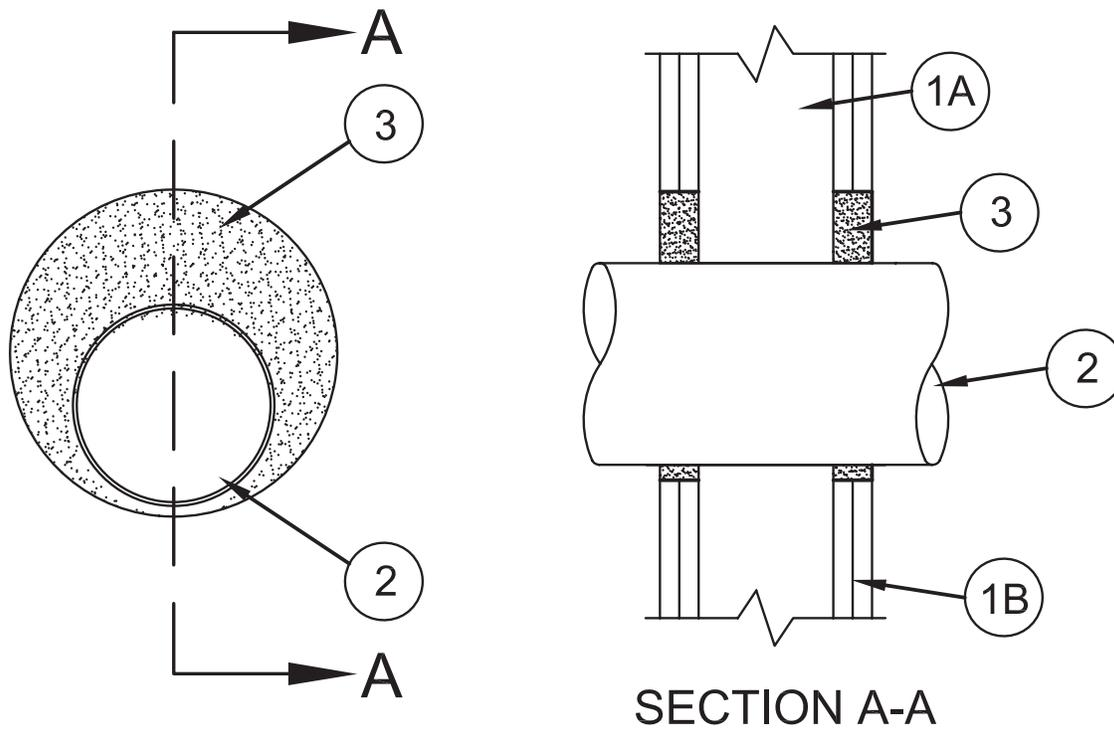

- Wall Assembly** – The 2 hr fire-rated gypsum board/stud wall assembly shall be constructed of the materials and in the manner described in the individual U400, V400 or W400 Series Wall or Partition Designs in the UL Fire Resistance Directory and shall include the following construction features:
 - Studs** – Wall framing shall consist of min 3-1/2 in. (89 mm) wide steel studs spaced max 24 in. (610 mm) OC.
 - Gypsum Board*** – Min two layers of 5/8 in. gypsum board attached to studs with fasteners, as specified in the individual U400, V400 or W400 Series design. Max diam of opening is 12-1/2 in. (318 mm).
- Through-Penetrant** – One metallic pipe, conduit or tubing installed either concentrically or eccentrically within the firestop system. The annular space between pipe, conduit or tubing and periphery of opening shall be min of 1/2 in. (13 mm) to max 3-3/8 in. (86 mm). Pipe, conduit or tubing to be rigidly supported on both sides of wall assembly. The following types and sizes of metallic pipes, conduits or tubing may be used:
 - Steel Pipe** – Nom 8 in. (203 mm) diam (or smaller) Schedule 10 (or heavier) steel pipe.
 - Iron Pipe** – Nom 8 in. (203 mm) diam (or smaller) service weight (or heavier) cast iron soil pipe, nom 12 in. diam (or smaller) or Class 50 (or heavier) ductile iron pressure pipe.
 - Conduit** – Nom 6 in. (152 mm) diam (or smaller) steel conduit or nom 4 in. (102 mm) diam (or smaller) steel electrical metallic tubing.
 - Copper Tubing** – Nom 4 in. (102 mm) diam (or smaller) Type L (or heavier) copper tubing.
 - Copper Pipe** – Nom 4 in. (102 mm) diam (or smaller) Regular (or heavier) copper pipe.
- Fill, Void or Cavity Material*** – **Foam** – Min 1-1/4 in. (32 mm) thickness of fill material applied within the annulus, flush with both surfaces of wall.

3M COMPANY – Fire Barrier Rated Foam, FIP 1-Step

*Bearing the UL Classification Mark

Reprinted from the Online Certifications Directory with permission from UL
© 2013 UL LLC



System No. W-L-1499

May 20, 2014

ANSI/UL1479 (ASTM E814)
 F Ratings — 1 and 2 Hr (See Item 1)
 T Rating — 1/2 Hr

CAN/ULC S115
 F Ratings — 1 and 2 Hr (See Item 1)
 FT Rating — 1/2 Hr
 FH Ratings — 1 and 2 Hr (See Item 1)
 FTH Rating — 1/2 Hr

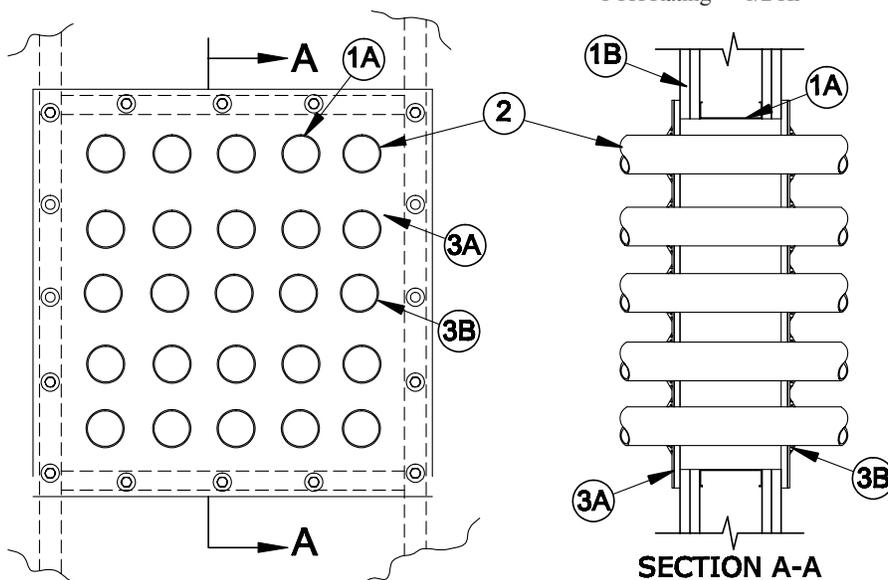

1. **Wall Assembly** — The 1 or 2 hr fire-rated gypsum board/steel stud wall assembly shall be constructed of the materials and in the manner described in the individual U400, V400 or W400 Series Wall and Partition Design in the UL Fire Resistance Directory and shall include the following construction features:

- A. **Steel Studs** — Steel studs to be min 3-1/2 in. (89 mm) deep and spaced max 24 in. (610 mm) OC. The opening in the wall to accommodate the penetrants shall be framed on all sides using lengths of steel stud installed between the vertical studs and screw-attached to the steel studs at each end.
- B. **Gypsum Board*** — One or two layers of nom 5/8 in. (16 mm) thick gypsum board as specified in the individual Wall and Partition Design. The framed opening in the wall shall have a max area of 720 in² (4645 cm²) with a max dimension of 30 in. (762 mm).

The hourly F and FH Ratings of the firestop system are equal to the hourly fire rating of the wall assembly in which it is installed.

2. **Metallic Penetrants** — One or more penetrants may be installed within the through opening. The space between penetrants shall be min 1 in. (25 mm). The space between penetrants and periphery of opening shall be min 0 in. (point contact). Penetrants to be rigidly supported on both sides of wall assembly. The following types and sizes of metallic penetrants may be used:

- A. **Tubing** — Nom 6 in. (152 mm) diam (or smaller) electrical metallic tubing (EMT). A maximum of one tube within the opening shall exceed nom 4 in. (102 mm) diam.

3. **Firestop System** — The firestop system shall consist of the following:

- A. **Fill, Void or Cavity Material* — Intumescent Sheet** — Rigid aluminum foil-faced sheet with galv sheet steel backer applied over opening at each side of wall. Sheets cut to tightly-follow the contours of the individual metallic penetrants. Sheets cut to lap a min of 2 in. (51 mm) on the wall on all sides of the opening on both sides of the wall. Prior to installation, a min 1/2 in. (13 mm) diam bead of putty (Item 3B) shall be applied as a gasket approx 1 in. (25 mm) from and on all sides of the through opening. Sheet to be installed with the galv steel sheet backer exposed (aluminum foil facing against wall surface) and secured to steel framing, through gypsum board layers, with min 1/4 in. (6 mm) diam by 2-1/4 in. (57 mm) long steel screws in conjunction with min 1-1/4 in. (32 mm) diam steel fender washers. Max spacing of fasteners not to exceed 6 in. (152 mm) with one fastener in each corner. See Item 3C below for splicing of sheets.

3M COMPANY — Type CS-195+

- B. **Fill, Void or Cavity Material* — Putty** — Min 1/2 in. (13 mm) diam bead of putty applied to edge of intumescent sheet at its interface with surface of wall around entire perimeter of through opening. In addition, min 1/2 in. (13 mm) bead of putty applied around periphery of each penetrant at its egress from the intumescent sheet on each side of wall.

3M COMPANY — MP+ Stix putty

- C. **Steel Cover Strip** — (Not Shown) - Intumescent sheets (Item 3A) may be spliced. Min 2 in. (51 mm) wide strip of min 0.020 in. (0.51 mm) thick (26 gauge) galv steel centered over entire length of each butted seam or slit made in the intumescent sheet. Prior to installation of the steel strip, the seam or slit in the intumescent sheet shall be covered with a nom 1/4 in. (6 mm) diam bead of sealant or caulk (Item 3D). Steel cover strip secured to galv steel sheet backer of intumescent sheet with steel sheet metal screws or steel rivets spaced max 3 in. (76 mm) OC on each side of seam or slit.

- D. **Fill, Void or Cavity Material* — Caulk or Sealant (Not Shown)** — Used with Item 3C. Prior to installation of the steel strip (Item 3C), the seam or slit in the intumescent sheet shall be covered with a min 1/4 in. (6 mm) diam bead of sealant or caulk.

3M COMPANY — CP25WB+, IC 15WB+ caulk or FB-3000 WT sealant

*Bearing the UL Classification Mark

Reprinted from the Online Certifications Directory with permission from UL

© 2014 UL LLC



System No. W-L-1500

May 22, 2014

ANSI/UL1479 (ASTM E814)

F Rating — 1 and 2 Hr (See Item 1)

T Rating — 1 and 2 Hr (See Item 1)

CAN/ULC S115

F Rating — 1 and 2 Hr (See Item 1)

FT Rating — 1 and 2 Hr (See Item 1)

FH Ratings — 1 and 2 Hr (See Item 1)

FTH Rating — 1 and 2 Hr (See Item 1)

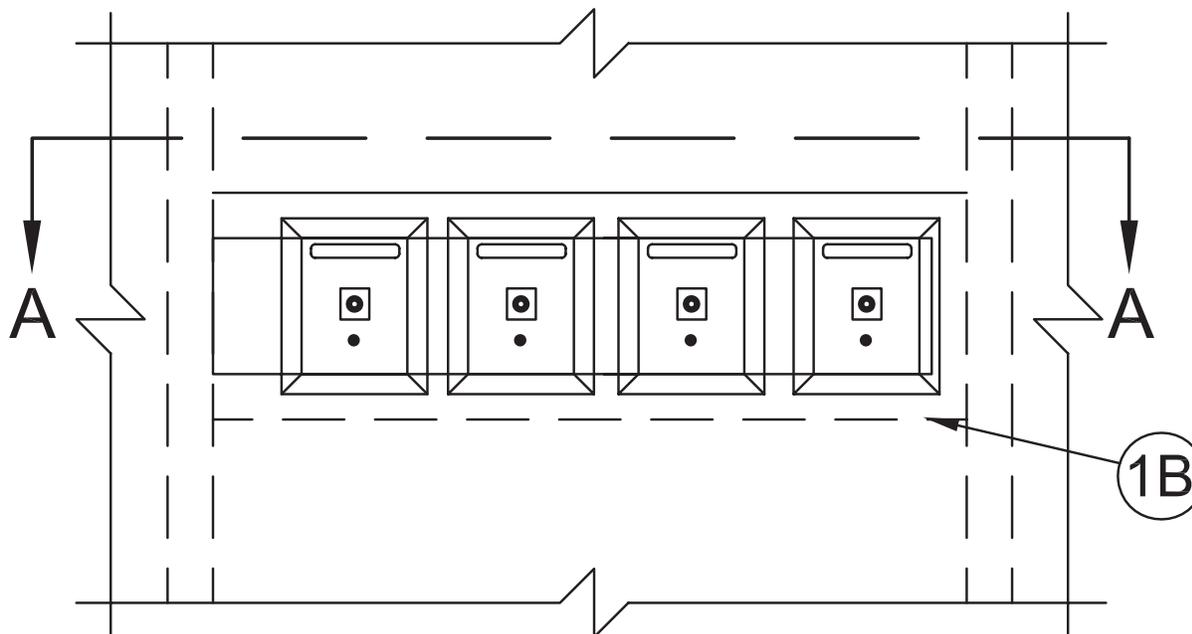

1. **Wall Assembly** — The 1 or 2 hr fire-rated gypsum wallboard/stud wall assembly shall be constructed of the materials and in the manner specified in the individual U300, U400 or V400 Series Wall and Partition Designs in the UL Fire Resistance Directory and shall include the following construction features:

- A. **Studs** — Wall framing may consist of either wood studs or steel channel studs. Wood studs to consist of nom 2 by 4 in. (51 by 102 mm) lumber spaced max 16 in. (406 mm) OC. Steel studs to be min 3-1/2 in. (89 mm) wide and spaced max 24 in. (610 mm) OC.
- B. **Steel Straps** — Min 1 in. (25 mm) wide, 20 gauge (or heavier) galvanized steel straps secured to studs with two steel screws at each end. Straps to be located across top and bottom of the openings, 4-1/2 in. (114 mm) apart.
- C. **Gypsum Board*** — The gypsum wallboard type, thickness, number of layers and orientation shall be as specified in the individual Wall and Partition Design. Individual openings to be 2-1/8 in. (54 mm) wide by 3-11/16 in. (94 mm) high.
- D. **Batts and Blankets*** — (Not shown) - Min R11 glass fiber or mineral wool insulation fitted in stud cavity.

The hourly F and T Rating of the firestop system is equal to the hourly fire rating of the wall assembly in which it is installed.

2. **Station Outlets+** — Max four station outlets ganged together with a center line spacing of 5 in. (127 mm) for use in medical gas systems distributing oxygen, nitrous oxide, vacuum, evacuation, air and nitrogen in hospitals in rigid piping systems at pressures not exceeding 100 to 200 psig. Station outlet provided with a steel mounting plate rough-in assembly, latch valve assembly and fire retardant Cycholoy® trim plate. The steel mounting plate rough-in assembly is screw attached to the steel straps (Item 1B). The installation within the wall assembly shall be in accordance with the manufacturer's installation instructions.

OHIO MEDICAL CORPORATION — Series 261000 DISS

3. **Fill, Void or Cavity Materials*** — **Putty Pad** — Nom 1/8 in. (3 mm) moldable putty pads to be installed to completely cover the back side of the station outlet rough-in plate and extending to span between and fully cover the steel straps to which the rough-in plate is connected across the span of the stud cavity. Putty pads to lap min 1 in. onto and to completely seal against the gypsum board and wall studs around periphery of rough-in plate/strap assembly. Putty pads to overlap each other a min 1/4 in. (6 mm). Additional amount of putty pad to completely cover horizontal section of pipe fitting at exterior of box and extend approximately 1 in. (25 mm) up the vertical section of piping.

3M COMPANY 3M FIRE PROTECTION PRODUCTS — MPP+ Moldable Putty Pads

*Bearing the UL Classification Mark

+Bearing the UL Listing Mark

Reprinted from the Online Certifications Directory with permission from UL

© 2014 UL LLC



Through Penetrations

Metallic Pipes

1000 Series

Gypsum

WL

System No. W-L-1520

February 16, 2016

| ANSI/UL1479 (ASTM E814) | CAN/ULC S115 |
|-------------------------------------|--------------------------------------|
| F Ratings — 1 and 2 Hr (See Item 1) | F Ratings — 1 and 2 Hr (See Item 1) |
| T Ratings — 0 Hr | FT Rating — 0 Hr |
| | FH Ratings — 1 and 2 Hr (See Item 1) |
| | FTH Rating — 0 Hr |

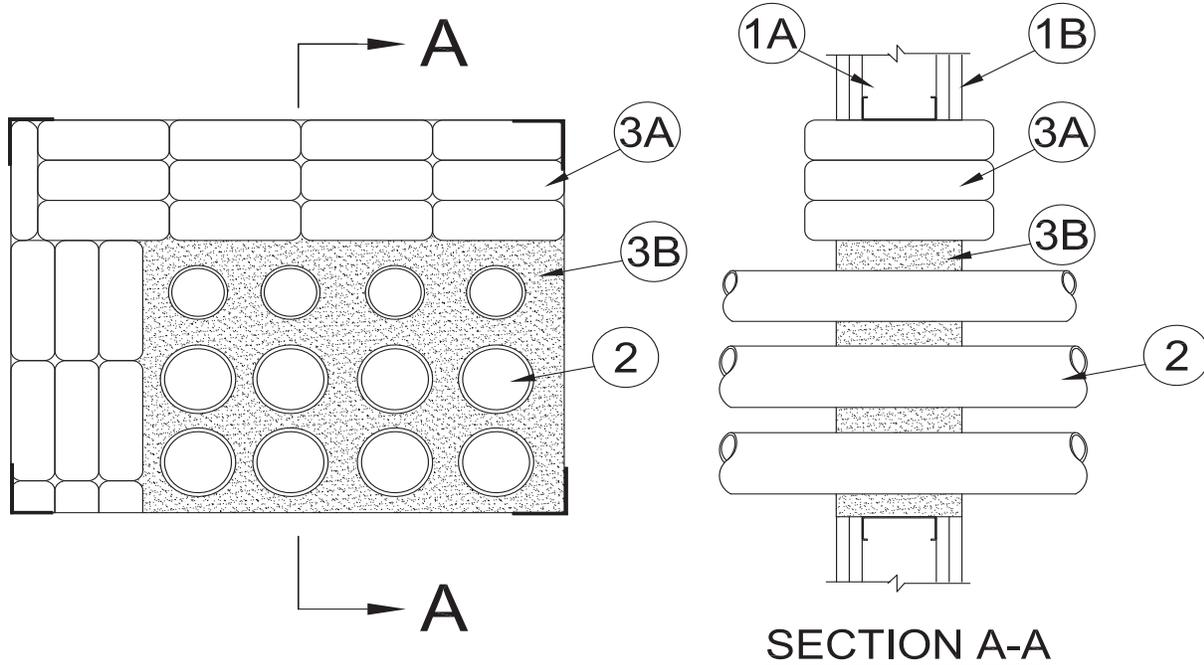

1. **Wall Assembly** — The 1 or 2 hr fire rated wallboard/stud wall assembly shall be constructed of the materials and in the manner specified in the individual U400, V400 or W400 Series Wall and Partition Designs in the UL Fire Resistance Directory and shall include the following construction features.

A. **Studs** — Wall framing shall consist of steel channel studs. Steel studs to be min 3-1/2 in. (89 mm) wide and spaced max 24 in. (610 mm) OC. Additional framing members shall be used to frame all sides of opening.

B. **Gypsum Board*** — One or two layers of nom 5/8 in. (16 mm) thick gypsum board, as specified in the individual Wall and Partition Design. Max area of opening is 540 sq in. (0.35 m2) with a max dimension of 30 in. (762 mm).

The hourly F and FH Rating of the firestop system is equal to the hourly fire rating of the wall assembly in which it is installed.

2. **Through Penetrant** — One or more metallic penetrants to be installed within the opening. The annular space between penetrants shall be min 1 in. (25 mm) to max 3 in. (76 mm). The annular space between penetrants and periphery of opening shall be min 1 in. (25 mm) to max 6 in. (152 mm). Penetrants to be rigidly supported on both sides of wall assembly. The following types and sizes of penetrants may be used:

A. **Conduit** — Nom 4 in. (102 mm) diam (or smaller) steel electrical metallic tubing or 4 in. (102 mm) diam (or smaller) steel conduit.

3. **Firestop System** — The firestop system shall consist of the following:

A. **Fill, Void or Cavity Material* — Pillows** — Max 9 in. (229 mm) long by 6 in. (152 mm) wide by 2 and 3 in. (51 and 76 mm) thick plastic covered pillows tightly-packed to fill annular space between penetrants and periphery of opening. Pillows installed with 9 in. (229 mm) dimension projecting through wall and centered within the opening. The pillows may be cut to decrease their width and repaired with min 0.002 in. (0.05mm) thick polyester tape with acrylic adhesive. The tape must overlap onto the existing pillow a min of 1/2 in. (13 mm).

3M COMPANY 3M FIRE PROTECTION PRODUCTS — Fire Barrier Pillows or Fire Barrier Self-Locking Pillows

B. **Fill, Void or Cavity Material* — Foam** — Foam fill material shall be applied to completely fill the annular space between and around penetrants to the full thickness of the wall. After installation of pillows (Item 3A), all voids within the opening shall be filled with a min 1 in. (25 mm) thickness of foam.

3M COMPANY 3M FIRE PROTECTION PRODUCTS — Fire Barrier Rated Foam, FIP 1-Step

* Indicates such products shall bear the UL or cUL Certification Mark for jurisdictions employing the UL or cUL Certification (such as Canada), respectively.



Through Penetrations

Metallic Pipes

1000 Series

Gypsum

WL

System No. W-L-1521

February 19, 2016

| ANSI/UL1479 (ASTM E814) | CAN/ULC S115 |
|-------------------------------------|--------------------------------------|
| F Ratings — 1 and 2 Hr (See Item 1) | F Ratings — 1 and 2 Hr (See Item 1) |
| T Ratings — 0 Hr | FT Rating — 0 Hr |
| | FH Ratings — 1 and 2 Hr (See Item 1) |
| | FTH Rating — 0 Hr |

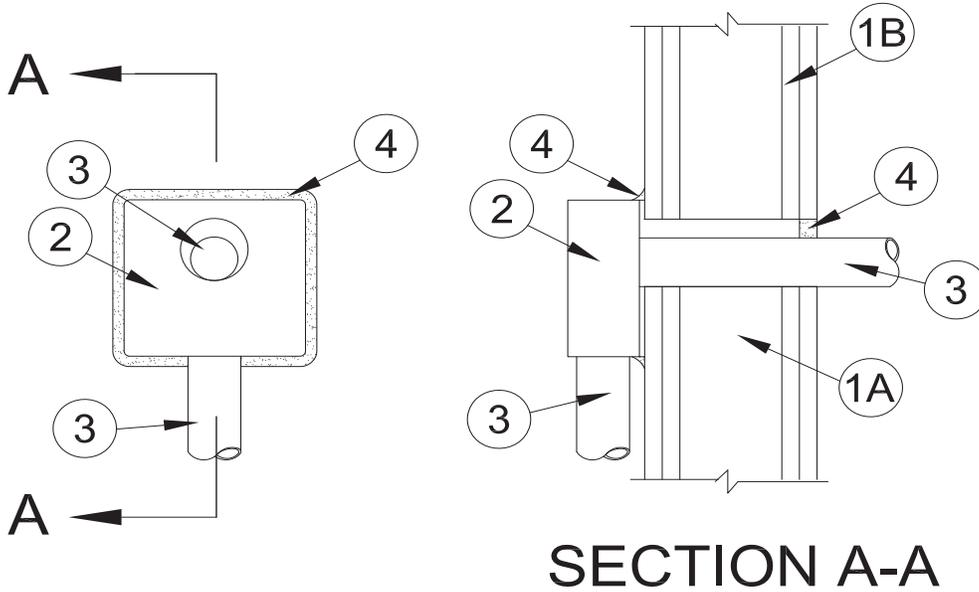

SECTION A-A

1. **Wall Assembly** — The 1 or 2 hr fire-rated gypsum board/stud wall assembly shall be constructed of the materials and in the manner specified in the individual U300, U400, V400 or W400 Series Wall and Partition Designs in the UL Fire Resistance Directory and shall include the following construction features:

A. **Studs** — Wall framing may consist of either wood studs or steel channel studs. Wood studs to consist of nom 2 by 4 in. (51 by 102 mm) lumber spaced 16 in. (406 mm) OC. Steel studs to be min 3 1/2 in. (89 mm) wide and spaced max 24 in. (610 mm) OC.

B. **Gypsum Board*** — 5/8 in. (16 mm) thick, 4 ft (1.2 m) wide with square or tapered edges. The gypsum board type, thickness, number of layers, fastener type and sheet orientation shall be as specified in the individual Wall and Partition Design in the UL Fire Resistance Directory. Diam of opening to be 1/2 in. (13 mm) to 1 in. (25 mm) larger than outside diam of through penetrant. Max diam of opening is 2-1/4 in. (57 mm).

The F and FH Rating of the firestop system is equal to the fire rating of the wall assembly.

2. **Pull or Junction Box+** — Min 16 ga steel pull or junction box mounted flush with or max 1/4 in. (6 mm) from surface of wall.

See **Junction and Pull Boxes** (BGUZ) category in the Electrical Construction Material Directory for names of manufacturers.

3. **Conduit** — One nom 1 in. (25 mm) diam (or smaller) steel conduit or steel electrical metallic tubing to be installed either concentrically or eccentrically within the firestop system. The annular space shall be min 0 in. (point contact) to max 1 in. (25 mm). Conduit or EMT to be secured to back surface of pull or junction box with steel connector and rigidly supported on both sides of wall assembly.

4. **Fill, Void or Cavity Material*** — **Sealant** — Min 5/8 in. (16 mm) thickness of fill material applied within the annulus, flush with surface of wall opposite the pull or junction box. A min 1/2 in. (13 mm) diam bead of fill material shall be applied at the point contact location between the conduit and wall. A min 1/2 in. (13 mm) diam bead of fill material shall be applied around the entire perimeter of the pull or junction box at its interface with the wall surface. The fill material shall lap min 1/2 in. (13 mm) onto both the wall and the sides of the pull or junction box.

3M COMPANY 3M FIRE PROTECTION PRODUCTS — FD 150+ Sealant, IC 15 WB+ Caulk, CP 25WB+ Caulk, 1000 NS Sealant or FB-3000 WT Sealant

+ Bearing the UL Listing Mark

* **Indicates such products shall bear the UL or cUL Certification Mark for jurisdictions employing the UL or cUL Certification (such as Canada), respectively.**



Through Penetrations

Metallic Pipes

1000 Series

Gypsum

WL

System No. W-L-1524

May 20, 2016

| ANSI/UL1479 (ASTM E814) | CAN/ULC S115 |
|-------------------------------------|--------------------------------------|
| F Ratings — 1 and 2 Hr (See Item 1) | F Ratings — 1 and 2 Hr (See Item 1) |
| T Rating — 0 Hr | FT Rating — 0 Hr |
| | FH Ratings — 1 and 2 Hr (See Item 1) |
| | FTH Rating — 0 Hr |

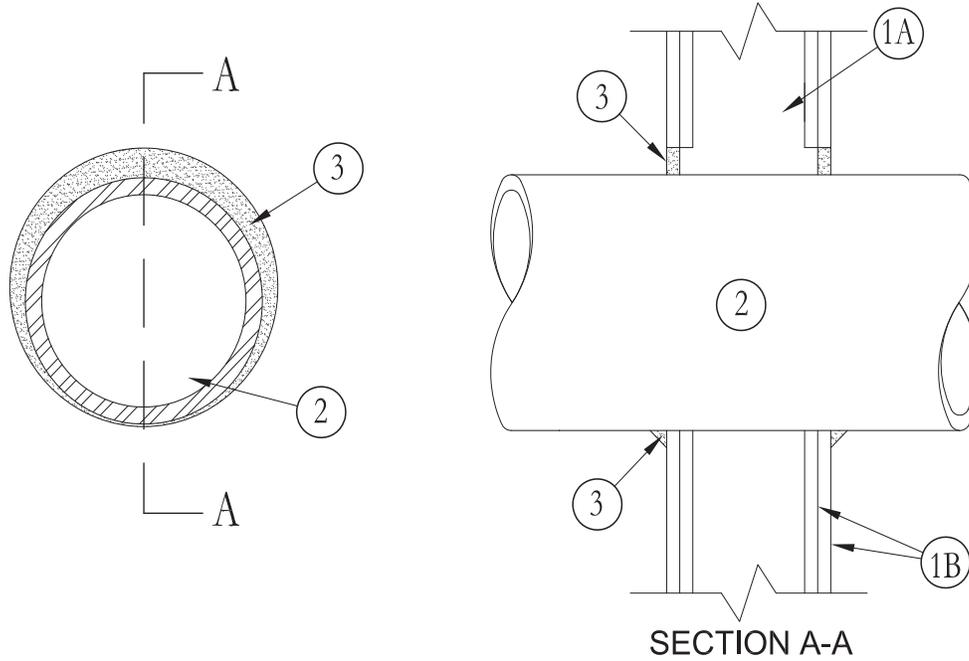

1. **Wall Assembly** — The 1 or 2 hr fire-rated gypsum board/stud wall assembly shall be constructed of the materials and in the manner described in the individual U300, U400, W400 Series Wall or Partition Design in the UL Fire Resistance Directory and shall include the following construction features:

- A. **Studs** — Wall framing may consist of either wood studs or steel channel studs. Wood studs to consist of nom 2 by 4 in. (51 by 102 mm) lumber spaced 16 in. (406 mm) OC with nom 2 by 4 in. (51 by 102 mm) lumber end plates and cross braces. Steel studs to be min 3-1/2 in. (89 mm) wide by 1-3/8 in. (35 mm) deep channels spaced max 24 in. (610 mm) OC.
- B. **Gypsum Board*** — The gypsum board type, thickness, number of layers, fastener type and sheet orientation shall be as specified in the individual Design in the UL Fire Resistance Directory. Max diam of opening is 14 in. (356 mm)

The hourly F and FH Ratings of the firestop system are equal to the hourly fire rating of the wall assembly in which it is installed.

2. **Through-Penetrant** — One metallic pipe, conduit or tubing installed either concentrically or eccentrically within the firestop system. The annular space between pipe, conduit or tubing and periphery of opening shall be min of 0 in. (point contact) to max 1-3/8 in. (35 mm). Pipe, conduit or tubing to be rigidly supported on both sides of wall assembly. The following types and sizes of metallic pipes, conduits or tubing may be used:

- A. **Steel Pipe** — Nom 12 in. (305 mm) diam (or smaller) Schedule 10 (or heavier) steel pipe.
- B. **Iron Pipe** — Nom 12 in. (305 mm) diam (or smaller) service weight (or heavier) cast iron soil pipe, nom 12 in. (305 mm) diam (or smaller) or Class 50 (or heavier) ductile iron pressure pipe.
- C. **Conduit** — Nom 6 in. (152 mm) diam (or smaller) steel conduit or nom 4 in. (102 mm) diam (or smaller) steel electrical metallic tubing.
- D. **Copper Tubing** — Nom 4 in. (102 mm) diam (or smaller) Type L (or heavier) copper tubing.
- E. **Copper Pipe** — Nom 4 in. (102 mm) diam (or smaller) Regular (or heavier) copper pipe.

3. **Fill Void or Cavity Materials*** — **Caulk** — Min 5/8 in. (16 mm) thickness of fill material applied within the annulus, flush with both surfaces of wall. Min 1/2 in. (13 mm) diam bead of caulk applied to the penetrant/gypsum board interface at the point contact location on both sides of wall.

3M COMPANY — FD-150+, IC 15WB+, CP 25WB+ or FB-3000WT Sealant.

* Indicates such products shall bear the UL or cUL Certification Mark for jurisdictions employing the UL or cUL Certification (such as Canada), respectively.



System No. W-L-1525

May 24, 2016
UL1479 (ASTM E814)

| ANSI/UL1479 (ASTM E814) | CAN/ULC S115 |
|------------------------------------|------------------------------------|
| F Rating — 1 and 2 Hr (See Item 1) | F Rating — 1 and 2 Hr (See Item 1) |
| T Rating — 0 | FT Rating — 0 |
| | FH Rating — 2 Hr |
| | FTH Rating — 0 |

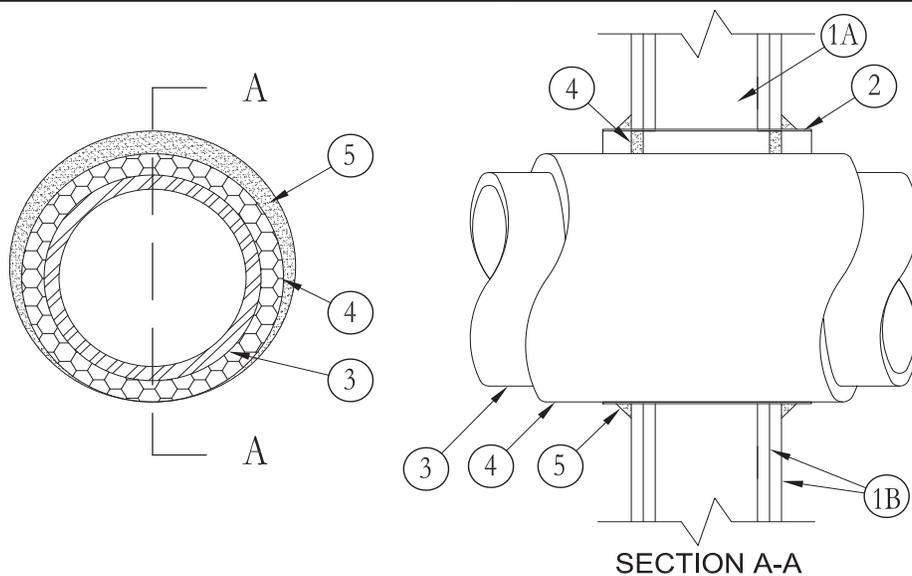

1. **Wall Assembly** — The 1 or 2 hr fire rated gypsum board/stud wall assembly shall be constructed of the materials and in the manner described in the individual U300, U400, V400 or W400 Series Wall or Partition Design in the UL Fire Resistance Directory and shall include the following construction features:

A. **Studs** — Wall framing may consist of either wood studs or steel channel studs. Wood studs to consist of nom 2 by 4 in. (51 by 102 mm) lumber spaced 16 in. (406 mm) OC. Steel studs to be min 3-1/2 in. (89 mm) wide spaced max 24 in. (610 mm) OC.

B. **Gypsum Board*** — The gypsum board type, thickness, number of layers, fastener type and sheet orientation shall be as specified in the individual Design in the UL Fire Resistance Directory. Max diam of opening is 12-1/2 in. (318 mm).

The hourly F and FH Ratings of the firestop system is equal to the hourly fire rating of the wall assembly in which it is installed.

2. **Steel Sleeve** — Cylindrical sleeve fabricated from min 0.019 in. (0.49 mm) thick (28 gauge) galv sheet steel and having a min 2 in. (51 mm) lap along the longitudinal seam. Length of steel sleeve to be equal to thickness of wall or up to 2 in. (51 mm) longer than the thickness of wall such that, when installed, the ends of the sleeve will be flush with wall surface or project up to 1 in. (25 mm) beyond the surface of the wall on each side of the wall assembly. Sleeve installed by coiling the sheet steel to a diam smaller than the max 12-1/2 in. (318 mm) diam through opening, inserting the coil through the opening and releasing the coil to let it uncoil against the circular cutouts in the gypsum board layers.

3. **Through-Penetrants** — One metallic pipe or tubing installed concentrically or eccentrically within opening. Penetrant to be rigidly supported on both sides of wall. The following types and sizes of penetrants may be used:

A. **Steel Pipe** — Nom 8 in. (203 mm) diam (or smaller) Schedule 10 (or heavier) steel pipe.

B. **Iron Pipe** — Nom 8 in. (203 mm) diam (or smaller) cast or ductile iron pipe.

C. **Copper Tubing** — Nom 4 in. (102 mm) diam (or smaller) Type L (or heavier) copper tubing.

D. **Copper Pipe** — Nom 4 in. (102 mm) diam (or smaller) Regular (or heavier) copper pipe.

4. **Pipe Covering*** — Nom 1 in. (25 mm), 1-1/2 in. (38 mm) or 2 in. (51 mm) thick hollow cylindrical heavy density (min 3.5 pcf or 56 kg/m³) glass fiber units jacketed on the outside with an all service jacket. Pipe covering to be min 12 in (305 mm) long and installed on penetrant to extend a min. of 3-5/8 in. (92 mm) beyond both sides of wall surface. Longitudinal joints sealed with metal fasteners or factory-applied SSL tape. Transverse joints secured with metal fasteners or with butt tape supplied with the product. Annular space between pipe covering and periphery of opening to be min 0 in. (0 mm, point contact) to max 1-7/8 in. (48 mm). When the steel sleeve (Item 2) is used the annular space between the pipe covering and the periphery of the opening is to be min 1/8 in. (3 mm) to max 1-3/4 in. (44 mm).

See **Pipe and Equipment Covering-Materials** (BRGU) category in the Building Materials Directory for names of manufacturers. Any pipe covering material meeting the above specifications and bearing the UL Classification Marking with a Flame Spread Index of 25 or less and a Smoke Developed Index of 50 or less may be used.

5. **Fill, Void or Cavity Material*** — **Caulk or Sealant** — Min 5/8 in. (16 mm) thickness of caulk applied within annulus, flush with both surfaces of wall. Min 1/4 in. (6 mm) diam bead of caulk applied to gypsum board/pipe covering interface or gypsum board/sleeve at point contact location on both sides of wall.

3M COMPANY 3M FIRE PROTECTION PRODUCTS — IC 15WB+, CP25WB+ caulk or FB-3000 WT sealant

* Indicates such products shall bear the UL or cUL Certification Mark for jurisdictions employing the UL or cUL Certification (such as Canada), respectively.



System No. W-L-1526

June 03, 2016

| ANSI/UL1479 (ASTM E814) | CAN/ULC S115 |
|---|---|
| F Ratings — 1 and 2 Hr (See Item 1) | F Ratings — 1 and 2 Hr (See Item 1) |
| T Ratings — 0 and 1/4 Hr (See Item 2) | FT Ratings — 0 and 1/4 Hr (See Item 2) |
| L Rating At Ambient — Less Than 1 CFM/sq ft | FH Ratings — 1 and 2 Hr (See Item 1) |
| L Rating At 400 F — Less Than 1 CFM/sq ft | FTH Ratings — 0 and 1/4 Hr (See Item 2) |
| | L Rating At Ambient — Less Than 1 CFM/sq ft |
| | L Rating At 400 F — Less Than 1 CFM/sq ft |

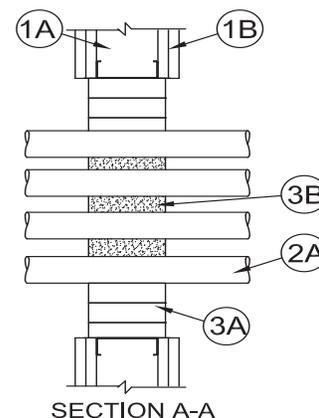
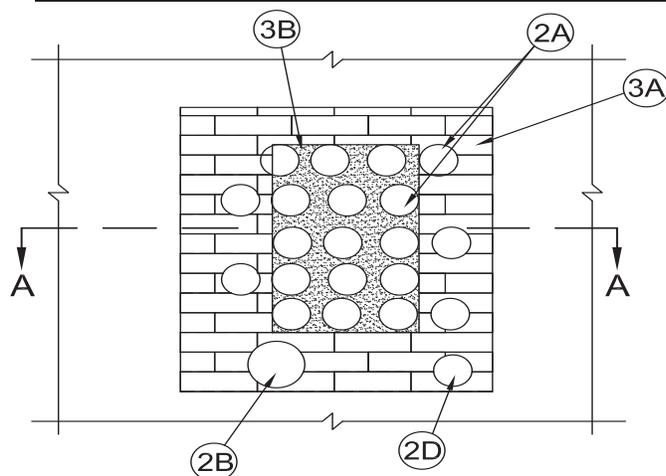

1. **Wall Assembly** — The 1 or 2 hr fire rated wallboard/stud wall assembly shall be constructed of the materials and in the manner specified in the individual U300, U400, V400 or W400 Series Wall and Partition Designs in the UL Fire Resistance Directory and shall include the following construction features.

- A. **Studs** — Wall framing shall consist of either wood studs or steel channel studs. Wood studs to consist of nom 2 by 4 in. (51 by 102 mm) lumber spaced 16 in. (406 mm) OC. Steel studs to be min 3-1/2 in. (89 mm) wide and spaced max 24 in. (610 mm) OC. Additional framing members shall be used to frame all sides of opening.
- B. **Gypsum Board*** — The gypsum board type, thickness, number of layers, fastener type and sheet orientation shall be as specified in the individual Wall and Partition Design in the UL Fire Resistance Directory. Max size of opening is 1296 in.2 (0.836 m2) with a max dimension of 36 in. (914 mm).

The hourly F and FH Ratings of the firestop system are equal to the hourly fire rating of the wall assembly in which it is installed. The hourly T, FT and FTH Ratings are 1/4 hr when installed in 2 hr rated walls, and 0 hr when installed in 1 hr rated walls.

2. **Through Penetrants** — One or more pipes, conduit or tubing to be installed within the opening. The space between the pipes, conduit or tubing shall be min 1/2 in. (13 mm) to max 9-1/2 in. (241 mm), except that for copper penetrants, the min annular space shall be 2 in. (51 mm). The space between pipes, conduit or tubing and periphery of opening shall be min 3/4 in. (19 mm) to max 14 in. (356 mm), except that for copper penetrants, the min annular space shall be 2 in. (51 mm). Pipe, conduit or tubing to be rigidly supported on both sides of floor or wall. The following types and sizes of metallic pipes, conduits or tubing may be used:

- A. **Conduit** — Nom 4 in. (102 mm) diam (or smaller) electrical metallic tubing or steel conduit. A maximum of twenty conduit may be installed within the opening.
- B. **Copper Tubing or Pipe** — Nom 4 in. (102 mm) diam (or smaller) Type L (or heavier) copper tubing or Regular (or heavier) copper pipe. A maximum of one copper penetrant may be installed within the opening.
- C. **Steel Pipe** — Nom 8 in. (203 mm) diam (or smaller) Schedule 5 (or heavier) steel pipe. A maximum of one penetrant exceeding 4 in. (102 mm) diam may be installed within the opening.
- D. **Iron Pipe** — Nom 4 in. (102 mm) diam (or smaller) cast or ductile iron pipe.

3. **Firestop System** — The firestop system shall consist of the following:

- A. **Fill, Void or Cavity Material*** — Blocks to be firmly packed to fill the opening area between the grouping of conduit (Item 2A) and periphery of opening, and between and around all other individual penetrants to the periphery of the opening. Blocks installed with 5 in. (127 mm) dimension projecting through opening, centered within thickness of wall. In walls greater than 6 in. (152 mm) thick, additional blocks shall be installed or blocks shall be installed with 8 in. (203 mm) dimension projecting through opening, such that blocks are recessed max 1/2 in. (13 mm) from both surfaces of wall. Blocks can be cut to fit around penetrants and within smaller annular spaces.

3M COMPANY 3M FIRE PROTECTION PRODUCTS — 3M™ Fire Barrier Block B258, 3M™ Fire Barrier Plank PK39

- B. **Fill, Void or Cavity Materials*** — **Foam** — Fill material installed to fill the entire annular space within and around the grouping of conduit penetrating items to a min thickness of 5 in. (127 mm). Fill material to be forced between blocks and periphery of opening to the max extent possible. Fill material to be injected in-between blocks and penetrants to the full depth of the blocks, as well as in any visible voids/openings between blocks (Item 3A).

3M COMPANY 3M FIRE PROTECTION PRODUCTS — Fire Barrier Rated Foam, FIP I-Step

* Indicates such products shall bear the UL or cUL Certification Mark for jurisdictions employing the UL or cUL Certification (such as Canada), respectively.



System No. W-L-1528

November 15, 2016

| ANSI/UL1479 (ASTM E814) | CAN/ULC S115 |
|--|---|
| F Ratings — 1 and 2 Hr (See Item 1) | F Ratings — 1 and 2 Hr (See Item 1) |
| T Rating — 0 Hr | FT Rating — 0 Hr |
| | FH Ratings — 1 and 2 Hr (See Item 1) |
| | FTH Rating — 0 Hr |

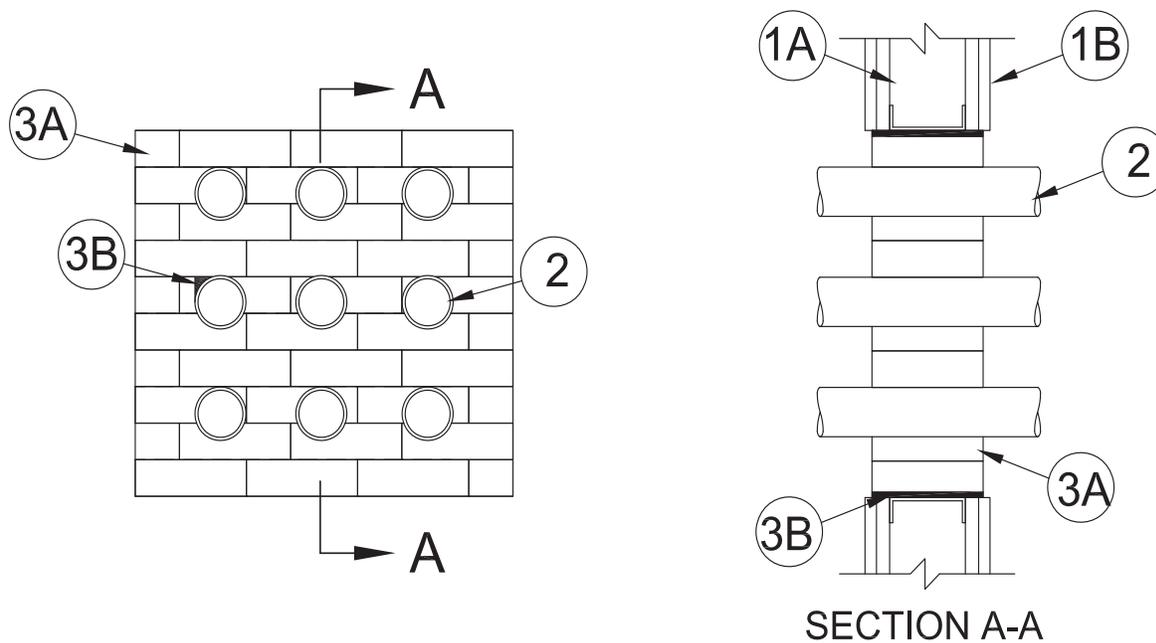

1. **Wall Assembly** — The 1 or 2 hr fire rated wallboard/stud wall assembly shall be constructed of the materials and in the manner specified in the individual U300, U400, V400 or W400 Series Wall and Partition Designs in the UL Fire Resistance Directory and shall include the following construction features.

- A. **Studs** — Wall framing shall consist of either wood studs or steel channel studs. Wood studs to consist of nom 2 by 4 in. (51 by 102 mm) lumber spaced 16 in. (406 mm) OC. Steel studs to be min 3-1/2 in. (89 mm) wide and spaced max 24 in. (610 mm) OC. Additional framing members shall be used to frame all sides of opening.
- B. **Gypsum Board*** — The gypsum board type, thickness, number of layers, fastener type and sheet orientation shall be as specified in the individual Wall and Partition Design in the UL Fire Resistance Directory. Max size of opening is 900 in.2 (5806 cm²) with a max dimension of 30 in. (762 mm).

The hourly F and FH Ratings of the firestop system are equal to the hourly fire rating of the wall assembly in which it is installed.

2. **Through Penetrants** — A maximum of nine pipes, conduit or tubing to be installed within the opening. The space between the pipes, conduit or tubing shall be min 3-1/2 in. (13 mm) to max 9-1/2 in. (241 mm). The space between pipes, conduit or tubing and periphery of opening shall be min 2 in. (51 mm) to max 14 in. (356 mm). Pipe, conduit or tubing to be rigidly supported on both sides of wall. The following types and sizes of metallic pipes, conduits or tubing may be used:

- A. **Conduit** — Nom 4 in. (102 mm) diam (or smaller) electrical metallic tubing or steel conduit.
- B. **Copper Tubing or Pipe** — Nom 4 in. (102 mm) diam (or smaller) Type L (or heavier) copper tubing or Regular (or heavier) copper pipe. A maximum of one copper penetrant may be installed within the opening.
- C. **Steel Pipe** — Nom 8 in. (203 mm) diam (or smaller) Schedule 5 (or heavier) steel pipe. A maximum of one penetrant exceeding 4 in. (102 mm) diam may be installed within the opening.
- D. **Iron Pipe** — Nom 4 in. (102 mm) diam (or smaller) cast or ductile iron pipe.

3. **Firestop System** — The firestop system shall consist of the following:

A. **Fill, Void or Cavity Material*** — Blocks installed with 5 in. (127 mm) dimension projecting through opening and centered in wall such that it is recessed max 1/2 in. (13 mm) from each surface of wall. Blocks to be firmly packed to fill the opening area between and around all penetrants. Blocks can be cut to fit around penetrants and within smaller annular spaces.

3M COMPANY 3M FIRE PROTECTION PRODUCTS — 3M™ Fire Barrier Block B258, 3M™ Fire Barrier Plank PK39

B. **Fill, Void or Cavity Material*** — **Sealant or Caulk** — Sealant to be forced between blocks and periphery of opening to the max extent possible. Sealant to be forced in-between blocks and all penetrants to the full depth of the blocks, as well as in any visible voids/openings between blocks.

3M COMPANY 3M FIRE PROTECTION PRODUCTS — CP 25WB+ Caulk or FB-3000 WT Sealant

* Indicates such products shall bear the UL or cUL Certification Mark for jurisdictions employing the UL or cUL Certification (such as Canada), respectively.



Metallic Pipes • Wood Frame Floor/Ceiling

| 3M UL Systems | "F" Rating | 3M Product | Through Penetrant Details |
|---------------|------------|---|--|
| F-C-1002 | 1, 2 | 3M™ Fire Barrier Sealant CP 25WB+ | 10" steel, iron, 6" conduit, 4" EMT, 4" copper tubing or pipe, chase wall option. Also referred as FC1002. |
| F-C-1003 | 2 | 3M™ Fire Barrier Silicone Sealant 2000+ 3M™ Fire Barrier Water Tight Sealant 1000 NS 3M™ Fire Barrier Water Tight Sealant 1003 SL | L505, L511, L536 assembly. Max 3 in. steel, max 3 in. EMT, max 3 in. conduit, max 1-1/2 in. copper tubing. Max diam of opening 3/8 in. larger than OD of pipe. Concentric installation. 2 hour F rating, 1/2 hour T rating. Also known as FC1003. |
| F-C-1006 | 1 | 3M™ Fire Barrier Sealant CP 25WB+ 3M™ Fire Barrier Water Tight Sealant 3000 WT | 10" steel, 10" cast iron, 4" steel conduit, 4" steel EMT, 3" copper tubing. Pipe installed midway between joists or trusses and centered in circular cutouts. Diam of cutout min 1/4" to max 1/2" larger than diam of pipe. Chase wall option. 1 hour F Rating. Also known as FC1006. |
| F-C-1015 | 1, 2 | 3M™ Fire Barrier Sealant CP 25WB+ | 1" steel flexible metal piping. Also referred as FC1015. |
| F-C-1029 | 1, 2 | 3M™ Fire Barrier Sealant CP 25WB+ | 1" steel flexible metal piping. Also referred as FC1029. |
| F-C-1036 | 1, 2 | 3M™ Fire Barrier Sealant CP 25WB+ | 2" steel flexible metal piping. Also referred as FC1036. |
| F-C-1060 | 1 | 3M™ Fire Barrier Sealant FD 150+ | 4" steel, iron, conduit, ENT, copper tubing or pipe, chase wall option. Also referred as FC1060. |
| F-C-1094 | 1 | 3M™ Fire Barrier Sealant CP 25WB+ 3M™ Fire Barrier Sealant IC 15WB+ 3M™ Fire Barrier Water Tight Sealant 3000 WT | 4" steel, 4" iron, 4" steel EMT, 6" steel conduit, 4" copper tubing, 4" copper pipe. See system for steel flexible gas piping. Chase wall optional. Max diam of opening 5-1/2". One or more penetrants installed concentrically or eccentrically. Point contact to max 1-3/8" annular between penetrants and opening. 1 hour F Rating. Also known as FC1094. |
| F-C-1095 | 1 | 3M™ Fire Barrier Sealant CP 25WB+ 3M™ Fire Barrier Sealant IC 15WB+ 3M™ Fire Barrier Water Tight Sealant 3000 WT | 2" steel, 2" cast iron, 2" ductile iron, 2" steel EMT, 6" rigid steel conduit, 1-1/2" copper tubing, 1-1/2" copper pipe. See system for flexible metal gas piping. Chase wall optional. Max opening 5". One or more penetrants concentrically or eccentrically installed. Point contact to max 1-1/2" annular. 1 hour F Rating. Also known as FC1095. |
| F-C-1159 | 1 | 3M™ Fire Barrier Sealant IC 15WB+ 3M™ Fire Barrier Sealant CP 25WB+ 3M™ Fire Barrier Water Tight Sealant 3000 WT | L500 Series floor ceiling assembly. One or more: max 4 in. steel, max 4 in. iron, max 4 in. conduit, max 4 in. EMT, max 4 in. copper tubing or pipe. Max 48 in. x 6 in. opening. Point contact to max 2 in. annular. Min 1/4 in. to max 2 in. spacing. No mineral wool required. 1 hour F. See system for T. Also known as FC1159. |
| F-C-1161 | 1 | 3M™ Fire Barrier Sealant IC 15WB+ 3M™ Fire Barrier Sealant CP 25WB+ 3M™ Fire Barrier Water Tight Sealant 3000 WT | Max 4 in. iron (vented), max 4 in. copper DWV (vented). L500 floor ceiling assembly. Max 5-1/2 in. opening. Min 1/2 in. to max 1-1/2 in. annular. 1 hour F rating. Floor mounted toilet. Also known as FC1161. |
| F-C-1165 | 1 | 3M™ Fire Barrier Wrap Ultra GS | Max 6 in. diam opening. Nonmetallic shower base receptor with 4 in. plastic drain connected to 4 in. metallic pipe with compression coupling. 1 hour F. Also Known as FC1165 |
| F-C-1166 | 1 | 3M™ Fire Barrier Sealant IC 15WB+ 3M™ Fire Barrier Sealant CP 25WB+ 3M™ Fire Barrier Water Tight Sealant 3000 WT | Max 5-1/2 in. diam opening. Nom 4in. Steel Pipe, Iron Pipe, Copper Tubing, or Copper Pipe. Min 0 in. to 1-3/8 in. annular. Optional Branch Piping, nom 3 in. Steel Pipe, Iron Pipe, Copper Tubing, Copper Pipe. Min 0 in. to 1/2 in. annular. 1 hour F. Also known as FC1166 |
| F-C-1167 | 1 | 3M™ Fire Barrier Sealant IC 15WB+ 3M™ Fire Barrier Sealant CP 25WB+ 3M™ Fire Barrier Water Tight Sealant 3000 WT | Max 5-1/2 in. diam opening in plywood or gypsum wallboard patch. Nom 4in. Steel Pipe or Iron Pipe. 1 hour F. Also known as FC1167 |
| F-E-1001 | 1 | 3M™ Fire Barrier Sealant CP 25WB+ 3M™ Fire Barrier Water Tight Sealant 3000 WT | 10" steel pipe, 10" cast iron pipe, 10" ductile steel pipe, 6" steel conduit, 4" EMT, 3" copper tubing, 3" copper pipe. Max diam of opening 11-1/4" Concentric or eccentric installation. Min 1/4" to max 1/2" annular. 1 hour F & T Rating. Also known as FE1001. |
| F-E-1009 | 1 | 3M™ Fire Barrier Sealant CP 25WB+ 3M™ Fire Barrier Sealant IC 15WB+ 3M™ Fire Barrier Water Tight Sealant 3000 WT | 4" steel pipe, 4" cast iron pipe, 4" ductile iron pipe, 4" copper tubing, 4" copper pipe. See system for specific flexible metal piping. Max diam of opening 5-1/2". Concentric or eccentric installation. Point contact to max 1-3/8" annular. 1 hour F Rating. Also known as FE1009. |
| F-E-1010 | 1 | 3M™ Fire Barrier Sealant CP 25WB+ 3M™ Fire Barrier Sealant IC 15WB+ 3M™ Fire Barrier Water Tight Sealant 3000 WT | Multiple: 2" steel pipe, 2" cast iron pipe, 2" ductile iron pipe, 2" steel EMT, 6" rigid steel conduit, 1-1/2" copper tubing, 1-1/2" copper pipe. Max diam of opening 5". Concentric or eccentric installation. Space between penetrants min 1/4" to max 2". Point contact to max 1-1/2" annular. 1 hour F Rating. Also known as FE1010. |

Metallic Pipes • Wood Frame Floor/Ceiling

| 3M UL Systems | "F" Rating | 3M Product | Through Penetrant Details |
|---------------|------------|--|--|
| F-E-1028 | 1 | 3M™ Fire Barrier Sealant IC 15WB+ 3M™ Fire Barrier Sealant CP 25WB+ 3M™ Fire Barrier Water Tight Sealant 3000 WT | Max 4 in. iron (vented), max 4 in. copper DWV (vented). G500 floor ceiling assembly. Max 5-1/2 in. opening. Min 1/2 in. to max 1-1/2 in. annular. 1 hour F rating. Toilet flange within the firestop system. Floor mounted toilet. Also known as FE1028. |
| F-E-1029 | 1 | 3M™ Fire Barrier Sealant IC 15WB+ 3M™ Fire Barrier Sealant CP 25WB+ 3M™ Fire Barrier Water Tight Sealant 3000 WT | Max. 4 in. steel, iron, EMT, RMC, or copper pipe/tube penetrating a G500 Series floor/ceiling assembly. |
| F-E-1030 | 1 | 3M™ Fire Barrier Sealant IC 15WB+ 3M™ Fire Barrier Sealant CP 25WB+ 3M™ Fire Barrier Water Tight Sealant 3000 WT | Multiple max. 2 in. metallic pipes penetrating the same max. 5 in. diameter opening in a G500 series floor/ceiling assembly. |
| F-E-1031 | 1 | 3M™ Fire Barrier Sealant IC 15WB+ 3M™ Fire Barrier Sealant CP 25WB+ 3M™ Fire Barrier Water Tight Sealant 3000 WT | Multiple max. 4 in. metallic pipes penetrating the same max. 288 square in. opening in a G500 Series floor/ceiling assembly. |

System No. F-C-1002

September 03, 2004

(Formerly System No. 169)

F Ratings – 1 and 2 Hr (See Item 1)

T Rating – 1 Hr

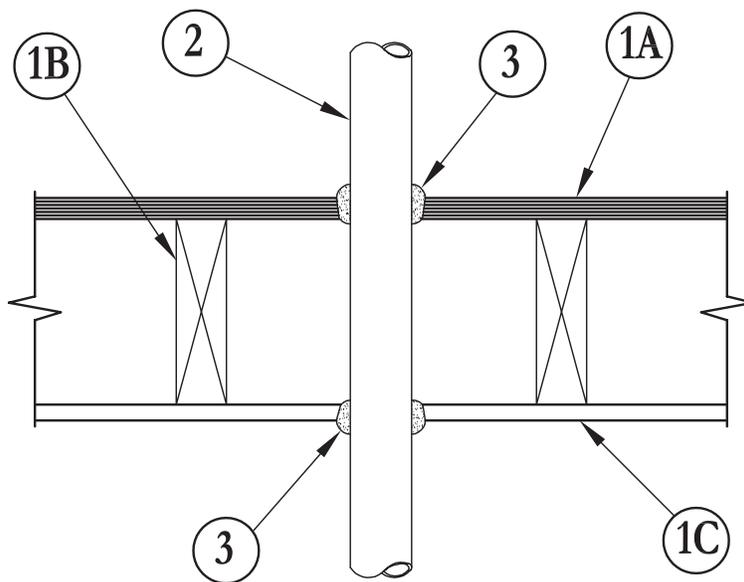

1. **Floor-Ceiling Assembly** – The 1 or 2 hr fire-rated wood joist floor-ceiling assembly shall be constructed of the materials and in the manner specified in the UL Fire Resistance Directory. The 1 hr fire rated assembly shall be constructed as specified in Design No. L501, L512 or L537. The 2 hr fire rated assembly shall be constructed as specified in Design No. L505, L511 or L536. **The F Rating of the firestop system is equal to the fire rating of the floor-ceiling assembly.** The general construction details of the floor-ceiling assembly are summarized below:
 - A. **Flooring System** – Lumber or plywood subfloor with finish floor of lumber, plywood or **Floor Topping Mixture*** as specified in the individual Floor-Ceiling Design. Max diam of opening is 1 in. larger than outside diam of penetrant.
 - B. **Wood Joists** – Nom 2 by 10 in. lumber joists spaced 16 in. O.C. with nom 1 by 3 in. lumber bridging and with ends firestopped.
 - C. **Furring Channels (Not Shown)** – Resilient galv steel furring channels installed perpendicular to wood joists between first and second layers of wallboard (Item 1D) in 2 hr fire rated assembly. Furring channels spaced max 24 in. O.C.
 - D. **Gypsum Board*** – Nom 4 ft wide by 5/8 in. thick as specified in the individual Floor-Ceiling Design. First layer of wallboard nailed to wood joists. Second layer of wallboard (2 hr fire rated assembly only) screw-attached to furring channels. Max diam of opening is 1 in. larger than outside diam of penetrant.
- 1.1 **Chase Wall (Optional, not shown)** – The through penetrants (Item No. 2) may be routed through a fire-rated single, double or staggered wood stud/gypsum wallboard chase wall having a fire rating consistent with that of the floor-ceiling assembly. The chase wall shall be constructed of the materials and in the manner specified in the individual U300 Series Wall and Partition Designs in the UL Fire Resistance Directory and shall include the following construction features:
 - A. **Studs** – Nom 2 by 6 in. or double nom 2 by 4 in. lumber studs.
 - B. **Sole Plate** – Nom 2 by 6 in. or parallel 2 by 4 in. lumber plates, tightly butted.
 - C. **Top Plate** – The double top plate shall consist of two nom 2 by 6 in. or two sets of parallel 2 by 4 in. lumber plates, tightly butted. Max diam of opening is 5 in..
 - D. **Gypsum Board*** – Thickness, type, number of layers and fasteners shall be as specified in individual Wall and Partition Design.
2. **Through Penetrants** – One metallic pipe, conduit or tubing to be installed either concentrically or eccentrically within the firestop system. The annular space between pipe, conduit or tubing and periphery of opening shall be min 0 in. (point contact) to max 1 in. Pipe, conduit or tubing to be rigidly supported on both sides of floor assembly. The following types and sized of metallic pipe, conduit or tubing may be used:
 - A. **Steel Pipe** – Nom 10 in. diam (or smaller) Schedule 40 (or heavier) steel pipe.
 - B. **Iron Pipe** – Nom 10 in. diam (or smaller) cast or ductile iron pipe.
 - C. **Conduit** – Nom 6 in. diam (or smaller) steel conduit, or nom 4 in. (or smaller) steel electrical metallic tubing.
 - D. **Copper Tubing** – Nom 4 in. diam (or smaller) Type L (or heavier) copper tubing.
 - E. **Copper Pipe** – Nom 4 in. diam (or smaller) Regular (or heavier) copper pipe.
3. **Fill, Void or Cavity Material* – Caulk or Sealant** – Min 3/4 in. thickness of fill material applied within the annulus, flush with top surface of floor or sole plate. Min 5/8 in. or 1-1/4 in. thickness of fill material, for 1 and 2 hr rated assemblies, respectively, applied within the annulus, flush with bottom surface of ceiling or top plate. An additional min 1/4 in. crown of fill material applied to perimeter of penetrant at its egress from the top of flooring and underside of ceiling or from top of sole plate and underside of top plate.

3M COMPANY – CP 25WB+ caulk or FB-3000 WT sealant.

*Bearing the UL Classification Mark

Reprinted from the Online Certifications Directory with permission from Underwriters Laboratories Inc.
Copyright © 2010 Underwriters Laboratories Inc.®



System No. F-C-1003

May 09, 2013

F Rating – 2 Hr

T Rating – 1/2 Hr

L Rating At Ambient – Less Than 1 CFM/sq ft

L Rating At 400 F – Less Than 1 CFM/sq ft

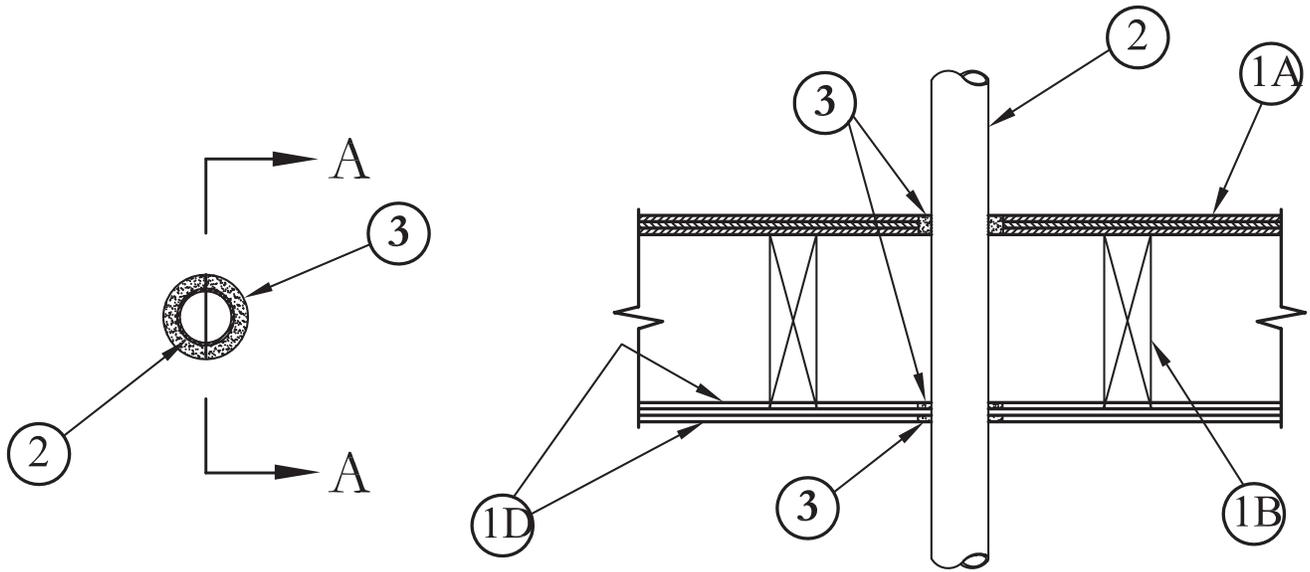
**SECTION A-A**

1. **Floor-Ceiling Assembly** – The fire rated wood joist floor-ceiling assembly shall be constructed of the materials and in the manner specified in Design No. L505, L511 or L536 in the UL Fire Resistance Directory, as summarized below:
 - A. **Flooring System** – Lumber or plywood subfloor with finish floor of lumber, plywood or **Floor Topping Mixture*** as specified in the individual Floor-Ceiling Design.
 - B. **Wood Joists** – Nom 2 by 10 in. (51 by 254 mm) lumber joists spaced 16 in. (406 mm) OC with nom 1 by 3 in. (25 by 76 mm) lumber bridging and with ends firestopped.
 - C. **Furring Channels** – (Not shown) – Resilient galv steel furring channels installed perpendicular to wood joists between first and second layers of wallboard (Item 1D) and spaced max 24 in. (610 mm) OC.
 - D. **Gypsum Board*** – Nom 4 ft (1219 mm) wide by 5/8 in. (16 mm) thick as specified in the individual Floor-Ceiling Design. First layer of wallboard nailed to wood joists. Second layer of wallboard screw-attached to furring channels. Max diam of ceiling opening is 3/8 in. (10 mm) greater than the outside diameter of pipe.
2. **Through Penetrants** – One metallic pipe, conduit or tubing to be centered within the firestop system. Pipe, conduit or tubing to be rigidly supported on both sides of floor and ceiling. The following types and sizes of metallic pipes, conduits or tubing may be used:
 - A. **Steel Pipe** – Nom 3 in. (76 mm) diam (or smaller) Schedule 5 (or heavier) steel pipe.
 - B. **Conduit** – Nom 3 in. (76 mm) diam (or smaller) electrical metallic tubing or steel conduit.
 - C. **Copper Tubing** – Nom 1-1/2 in. (38 mm) diam (or smaller) Type L (or heavier) copper tubing.
3. **Fill, Void or Cavity Material* – Sealant** – Fill material forced into annular spaces to fill space to max extent possible. Sealant shall be installed flush with floor and ceiling.

3M COMPANY – Types FB-1000 NS, FB-1003SL, FB-2000 or FB-2000+.

*Bearing the UL Classification Mark

Reprinted from the Online Certifications Directory with permission from UL

© 2013 UL LLC



System No. F-C-1006

April 03, 2007

F Rating – 1 Hr

T Ratings – 0 and 1 Hr (See Item 2)

L Rating At Ambient – Less Than 1 CFM/sq ft

L Rating At 400 F – Less Than 1 CFM/sq ft

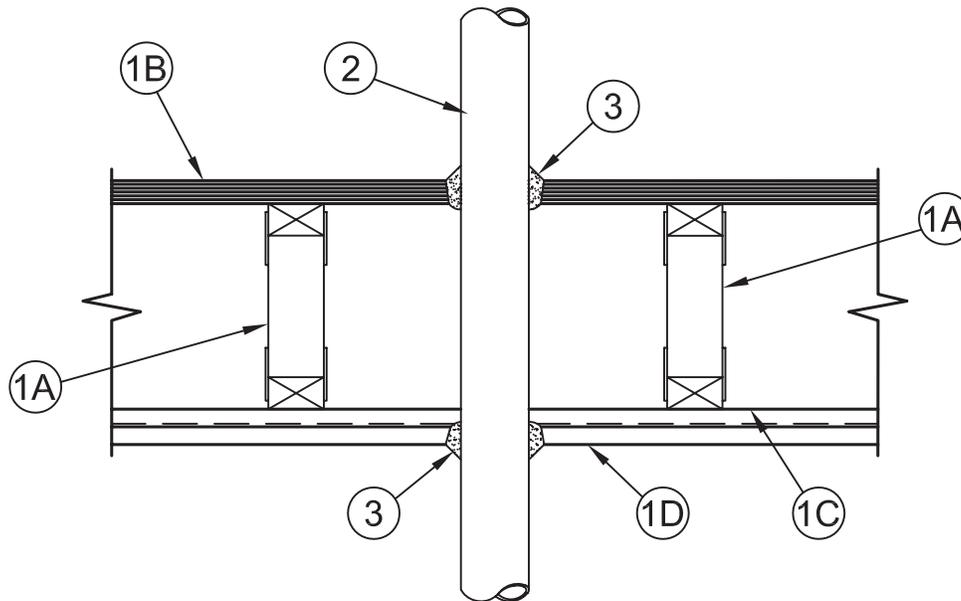

1. **Floor-Ceiling Assembly** – The 1 hr fire rated wood joist, wood truss or combination wood and steel truss Floor-Ceiling assembly shall be constructed of the materials and in the manner described in the individual L500-Series Design in the UL Fire Resistance Directory, as summarized below:
 - A. **Joists or Trusses** – Nom 2 by 10 in. (51 by 254 mm) lumber joists, min 12 in. (305 mm) deep parallel chord trusses fabricated from nom 2 by 4 in. (51 by 102 mm) lumber in conjunction with galv steel truss plates or **Structural Wood Members*** with bridging as required.
 - B. **Flooring** – Nom 3/4 in. (19 mm) thick plywood flooring with or without **Floor Topping Mixture***. Diam of circular cutouts is 1/4 to 1/2 in. (6 to 13 mm) larger than outside diam of the pipe.
 - C. **Furring Channels** – Rigid or resilient galv steel furring channels installed perpendicular to bottom chord of trusses.
 - D. **Gypsum Board*** – Nom 4 ft (1.2 m) wide by 5/8 in. (16 mm) thick, screw-attached to furring channels. Diam of circular cutouts is 1/4 to 1/2 in. (6 to 13 mm) larger than outside diam of the pipe.
- 1.1 **Chase Wall** (Optional, now shown) – The through penetrants (Item No. 2) may be routed through a 1 hr fire-rated single, double or staggered wood stud/gypsum wallboard chase wall constructed of the materials and in the manner specified in the individual U300 Series Wall and Partition Designs in the UL Fire Resistance Directory and shall include the following construction features:
 - A. **Studs** – Nom 2 by 6 in. (51 by 152 mm) or double nom 2 by 4 in. (51 by 102 mm) lumber studs.
 - B. **Sole Plate** – Nom 2 by 6 in. (51 by 152 mm) or parallel 2 by 4 in. (51 by 102 mm) lumber plates, tightly butted. Diam of circular cutouts is 1/4 to 1/2 in. (6 to 13 mm) larger than outside diam of the pipe.
 - C. **Top Plate** – The double top plate shall consist of two nom 2 by 6 in. (51 by 152 mm) or two sets of parallel 2 by 4 in. (51 by 102 mm) lumber plates, tightly butted. Diam of circular cutouts is 1/4 to 1/2 in. (6 to 13 mm) larger than outside diam of the pipe.
 - D. **Gypsum Board*** – Thickness, type, number of layers and fasteners shall be as specified in individual Wall and Partition Design.
2. **Through Penetrant** – Nom 10 in. (254 mm) diam (or smaller) Schedule 10 (or heavier) steel pipe or cast iron pipe, nom 4 in. (102 mm) diam (or smaller) steel conduit or steel EMT or nom 3 in. (76 mm) diam (or smaller) Type L (or heavier) copper tubing. Pipe to be installed approx midway between joists or trusses and centered in circular cutouts. Annular space between penetrant and periphery of opening shall be min 1/8 in. (3 mm) to max 1/4 in. (6 mm). Pipe to be rigidly supported on both sides of Floor-Ceiling assembly.

T Rating is 1 hr for nom 4 in. (102 mm) diam (or smaller) penetrants. T Rating is 0 hr for all penetrants greater than nom 4 in. (102 mm) diam.
3. **Fill, Void or Cavity Materials* – Caulk or Sealant** – Min 3/4 in. (19 mm) thickness of fill material applied within the annulus, flush with top surface of floor or sole plate. Min 5/8 in. (16 mm) thickness of fill material applied within the annulus, flush with bottom surface of ceiling or top plate. An additional min 1/4 in. (6 mm) crown of fill material applied to perimeter of penetrant at its egress from the top of flooring and underside of ceiling or from top of sole plate and underside of top plate.

3M COMPANY – CP 25WB+ or FB-3000 WT

*Bearing the UL Classification Marking

Reprinted from the Online Certifications Directory with permission from Underwriters Laboratories Inc.
Copyright © 2010 Underwriters Laboratories Inc.®



System No. F-C-1015

July 16, 1996

F Ratings – 1 and 2 Hr (See Item 1)

T Rating – 1 Hr

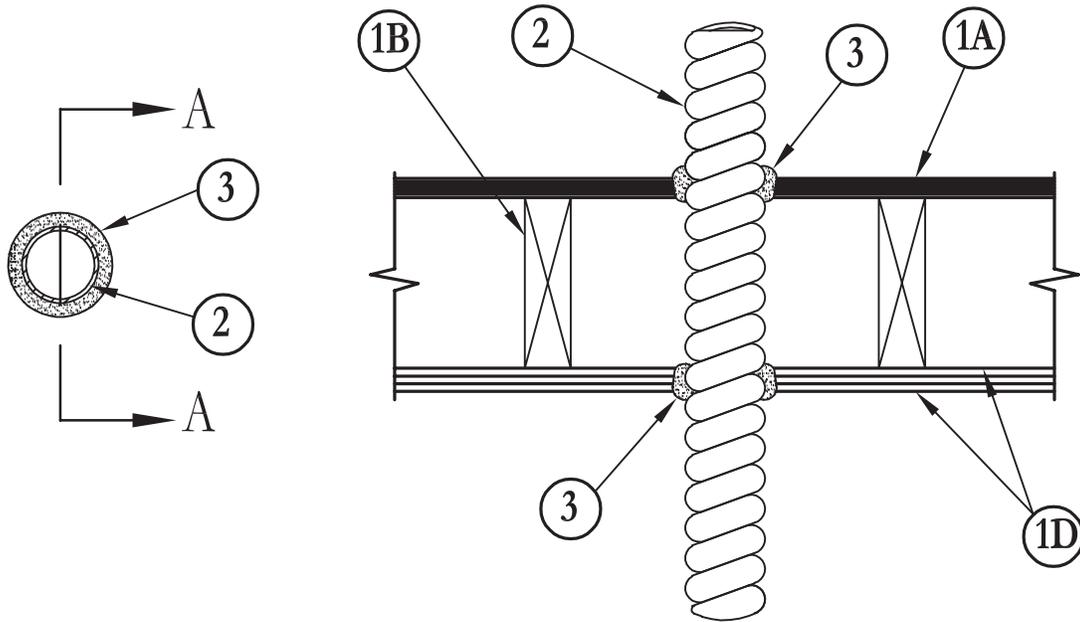
**SECTION A-A**

- Floor-Ceiling Assembly** – The 1 or 2 hr fire-rated wood joist floor-ceiling assembly shall be constructed of the materials and in the manner specified in the UL Fire Resistance Directory. The 1 hr fire rated assembly shall be constructed as specified in Design No. L501, L512, or L537. The 2 hr fire rated assembly shall be constructed as specified in Design No. L505, L511 or L536. The F Rating of the firestop system is equal to the fire rating of the floor-ceiling assembly. The general construction details of the floor-ceiling assembly are summarized below:
 - Floor System** – Lumber or plywood subfloor with finish floor of lumber, plywood or **Floor Topping Mixture*** as specified in the individual Floor-Ceiling Design. Max diam of opening in flooring to accommodate piping is 1-3/4 in.
 - Wood Joists** – Nom 2 by 10 in. lumber joists spaced 16 in. OC with nom 1 by 3 in. lumber bridging and with ends firestopped.
 - Furring Channels** – (Not Shown) – Resilient galv steel furring channels installed perpendicular to wood joists between first and second layers of wallboard (Item 1D) in 2 hr fire rated assembly. Furring channels spaced max 24 in. OC.
 - Gypsum Board*** – Nom 4 ft wide by 5/8 in. thick as specified in the individual Floor-Ceiling Design. First layer of wallboard nailed to wood joists. Second layer of wallboard (2 hr fire rated assembly only) screw-attached to furring channels. Max diam of opening in ceiling to accommodate piping is 1-3/4 in.
- Through Penetrating Product*** – **Flexible Metal Piping** – Nom 1 in. diam (or smaller) Steel Flexible Metal piping. Max one flexible metal piping to be installed in the opening. Circular openings hole-sawed through flooring system and through gypsum wallboard ceiling to be 1/2 in. larger than outside diam of pipe. Piping to be installed approx midway between wood joists and centered in circular openings such that a 1/4 in. annular space is present around its perimeter at each through opening location. Flexible metal piping to be rigidly supported on both sides of floor assembly. Plastic covering on piping shall be removed for a distance of 2 ft on both sides of floor.

TITEFLEX CORP, A BUNDY CO

- Fill, Void or Cavity Material* – Caulk** – Caulk fill material forced into annular spaces to fill spaces to max extent possible and with a min 1/4 in. high by 3/8 in. wide bead of caulk applied to the perimeter of the flexible piping at its egress from the finished floor and ceiling.

3M COMPANY – CP 25WB+

*Bearing the UL Classification Marking

Reprinted from the Online Certifications Directory with permission from Underwriters Laboratories Inc.

Copyright © 2010 Underwriters Laboratories Inc.®

System No. F-C-1029

October 19, 2011

F Ratings – 1 and 2 Hr (See Item 1)

T Rating – 1 Hr

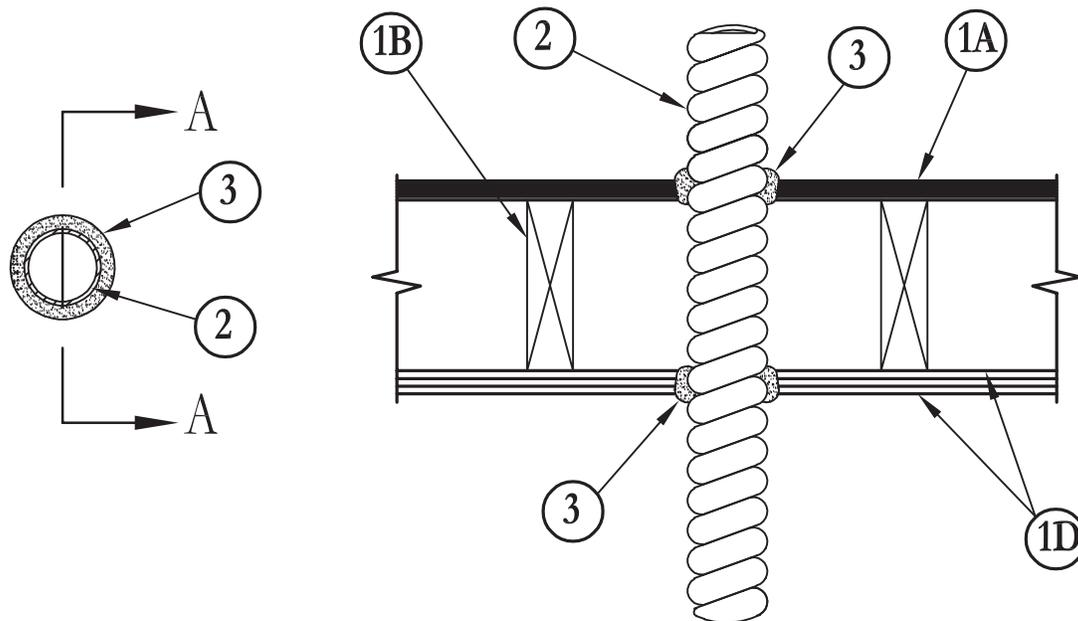

SECTION A-A

- Floor-Ceiling Assembly** – The 1 or 2 h fire-rated wood joist floor-ceiling assembly shall be constructed of the materials and in the manner specified in the UL Fire Resistance Directory. The 1 h fire rated assembly shall be constructed as specified in Design No. L501, L512, or L537. The 2 h fire rated assembly shall be constructed as specified in Design No. L505, L511 or L536. The F Rating of the firestop system is equal to the fire rating of the floor-ceiling assembly. The general construction details of the floor-ceiling assembly are summarized below:
 - Floor System** – Lumber or plywood subfloor with finish floor of lumber, plywood or **Floor Topping Mixture*** as specified in the individual Floor-Ceiling Design. Max diam of opening in flooring to accommodate piping is 3-1/8 in. (79 mm).
 - Wood Joists** – Nom 2 by 10 in. (51 by 254 mm) lumber joists spaced 16 in. (406 mm) OC with nom 1 by 3 in. (25 by 76 mm) lumber bridging and with ends firestopped.
 - Furring Channels** – (Not Shown) – Resilient galv steel furring channels installed perpendicular to wood joists between first and second layers of wallboard (Item 1D) in 2 h fire rated assembly. Furring channels spaced max 24 in. (610 mm) OC.
 - Gypsum Board*** – Nom 4 ft (1.2 m) wide by 5/8 in. (16 mm) thick as specified in the individual Floor-Ceiling Design. First layer of gypsum board nailed to wood joists. Second layer of gypsum board (2 h fire rated assembly only) screw-attached to furring channels. Max diam of opening in ceiling to accommodate piping is 3-1/8 in. (79 mm).
- Through Penetrating Product* – Flexible Metal Piping** – Nom 2 in. (51 mm) diam (or smaller) steel flexible metal piping. Max one flexible metal piping to be installed in the opening. Circular openings hole-sawed through flooring system and through gypsum board ceiling to be 1/2 in. (13 mm) larger than outside diam of pipe. Piping to be installed approx midway between wood joists and centered in circular openings such that a 1/4 in. (6 mm) annular space is present around its perimeter at each through opening location. Flexible metal piping to be rigidly supported on both sides of floor assembly.

WARD MFG L L C – Wardflex or Wardflex II
- Fill, Void or Cavity Material* – Caulk** – Caulk fill material forced into annular spaces to fill spaces to max extent possible and with a min 1/4 in. (6 mm) high by 3/8 in. (10 mm) wide bead of caulk applied to the perimeter of the flexible piping at its egress from the finished floor and ceiling.

3M COMPANY – CP-25 WB+

*Bearing the UL Classification Mark

Reprinted from the Online Certifications Directory with permission from UL
© 2012 UL LLC

Through Penetrations

Metallic Pipes

1000 Series

Floor/Ceiling

FC

System No. F-C-1036

November 19, 1999

F Ratings – 1 and 2 Hr (See Item 1)

T Rating – 1 Hr

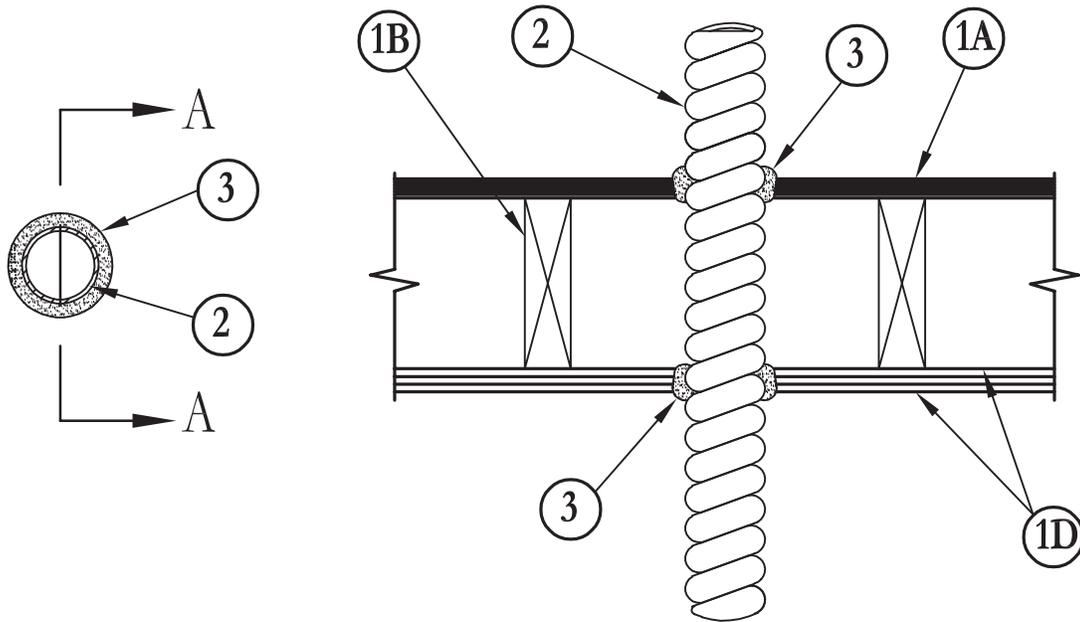
**SECTION A-A**

1. **Floor-Ceiling Assembly** – The 1 or 2 hr fire-rated wood joist floor-ceiling assembly shall be constructed of the materials and in the manner specified in the UL Fire Resistance Directory. The 1 hr fire rated assembly shall be constructed as specified in Design No. L501, L512 or L537. The 2 hr fire rated assembly shall be constructed as specified in Design No. L505, L511 or L536. The F Rating of the firestop system is equal to the fire rating of the floor-ceiling assembly. The general construction details of the floor-ceiling assembly are summarized below:
 - A. **Floor System** – Lumber or plywood subfloor with finish floor of lumber, plywood or Floor Topping Mixture* as specified in the individual Floor-Ceiling Design. Max diam of opening in flooring to accommodate piping is 2-15/16 in.
 - B. **Wood Joists** – Nom 2 by 10 in. lumber joists spaced 16 in OC with nom 1 by 3 in. lumber bridging and with ends firestopped.
 - C. **Furring Channels** (Not Shown) – Resilient galv steel furring channels installed perpendicular to wood joists between first and second layers of wallboard (Item 1D) in. 2 hr fire rated assembly. Furring channels spaced max 24 in. OC.
 - D. **Gypsum Board*** – Nom 4 ft wide by 5/8 in. thick as specified in the individual Floor-Ceiling Design. First layer of wallboard nailed to wood joists. Second layer of wallboard (2 hr fire rated assembly only) screw-attached to furring channels. Max diam of opening in ceiling to accommodate piping is 2-15/16 in.
2. **Through Penetrating Product* – Flexible Metal Piping** – Nom 2 in. diam (or smaller) steel Flexible Metal Piping. Max one flexible metal piping to be installed in the opening. Circular openings hole-sawed through flooring system and through gypsum wallboard ceiling to be 1/2 in. larger than outside diam of pipe. Piping to be installed approx midway between wood joists and centered in circular openings such that a 1/4 in. annular space is present around its perimeter at each through opening location. Flexible metal piping to be rigidly supported on both sides of floor assembly. Plastic covering on piping shall be removed for a distance of 2 ft on both sides of floor.

OMEGA FLEX INC

3. **Fill, Void or Cavity Material* – Caulk** – Caulk fill material forced into annular spaces to fill spaces to max extent possible and with a min 1/4 in. high by 3/8 in. wide bead of caulk applied to the perimeter of the flexible piping at its egress from the finished floor and ceiling.

3M COMPANY – CP 25WB+

*Bearing the UL Classification Marking

Reprinted from the Online Certifications Directory with permission from Underwriters Laboratories Inc.

Copyright © 2010 Underwriters Laboratories Inc.®



System No. F-C-1060

August 03, 2001

F Rating – 1 Hr

T Rating – 1/4 Hr

L Rating At Ambient – Less Than 1 CFM/sq ft

L Rating At 400 F – 2 CFM/sq ft

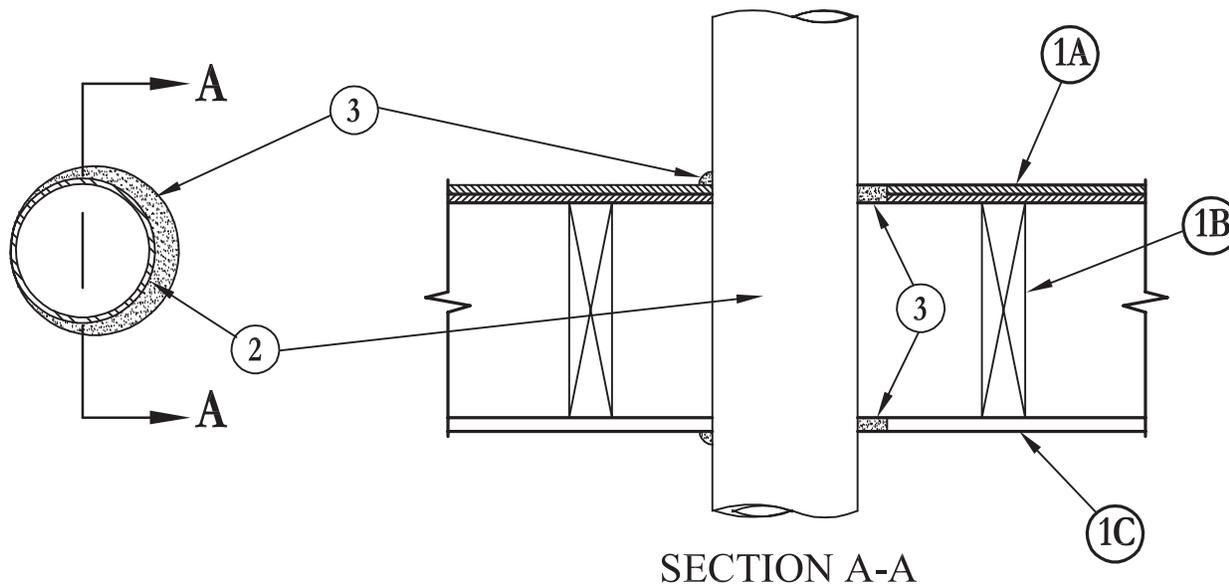

- 1. Floor-Ceiling Assembly** – The 1 hr fire-rated solid or trussed lumber joist floor-ceiling assembly shall be constructed of the materials and in the manner specified in the individual L500 Series Floor-Ceiling Designs in the UL Fire Resistance Directory. The general construction details of the floor-ceiling assembly are summarized below:
 - A. Flooring System** – Lumber or plywood subfloor with finish floor of lumber, plywood or **Floor Topping Mixture*** as specified in the individual Floor-Ceiling Design. Max diam of opening is 5 in.
 - B. Wood Joists** – Nom 10 in. deep (or deeper) lumber, steel or combination lumber and steel joists, trusses or **Structural Wood Members*** with bridging as required and with ends firestopped.
 - C. Gypsum Board*** – Nom 4 ft wide by 5/8 in. thick as specified in the individual Floor-Ceiling Design. Max diam of opening is 5 in.
- 1.1 Chase Wall (Optional, not shown)** – The through penetrants (Item No. 2) may be routed through a fire-rated single, double or staggered wood stud/gypsum wall board chase wall having a fire rating consistent with that of the floor-ceiling assembly. The chase wall shall be constructed of the materials and in the manner specified in the individual U300 Series Wall and Partition Designs in the UL Fire Resistance Directory and shall include the following construction features:
 - A. Studs** – Nom 2 by 6 in. or double nom 2 by 4 in. lumber studs.
 - B. Sole Plate** – Nom 2 by 6 in. or parallel 2 by 4 in. lumber plates, tightly butted. Max diam of opening is 5 in.
 - C. Top Plate** – The double top plate shall consist of two nom 2 by 6 in. or two sets of parallel 2 by 4 in. lumber plates, tightly butted. Max diam of opening is 5 in.
 - D. Gypsum Board*** – Thickness, type, number of layers and fasteners shall be as specified in individual Wall and Partition Design.
- 2. Through Penetrants** – One metallic pipe, conduit or tubing to be installed either concentrically or eccentrically within the opening, approx midway between joists or trusses. The annular space between penetrant and periphery of opening shall be min 0 in. to max 7/8 in. Penetrants to be rigidly supported on both sides of floor or wall assembly. The following types and sizes of metallic pipes, conduits or tubings may be used:
 - A. Steel** – Nom 4 in. diam (or smaller) Schedule 10 (or heavier) steel pipe.
 - B. Iron Pipe** – Nom 4 in. diam (or smaller) cast or ductile iron pipe.
 - C. Conduit** – Nom 4 in. diam (or smaller) steel conduit, or nom 4 in. (or smaller) steel electrical metallic tubing.
 - D. Copper** – Tubing Nom 4 in. diam (or smaller) Type M (or heavier) copper tube.
 - E. Copper Pipe** – Nom 4 in. diam (or smaller) Regular (or heavier) copper pipe.
- 3. Fill Void or Cavity Materials* – Caulk** – Min 3/4 in. thickness of caulk applied within the annulus, flush with top surface of floor or sole plate. Min 5/8 in. thickness of caulk applied within the annulus, flush with bottom surface of ceiling or top plate. Min 1/2 in. diam bead of caulk applied to the penetrant/floor or sole plate interface at point contact location on the top surface of floor or sole plate and at the penetrant/ceiling or top plate interface at point contact location on lower surface of assembly.

3M COMPANY – FireDam 150+

*Bearing the UL Classification Mark

Reprinted from the Online Certifications Directory with permission from Underwriters Laboratories Inc.

Copyright © 2010 Underwriters Laboratories Inc.®



System No. F-C-1094

May 18, 2005
 F Rating – 1 Hr
 T Rating – 1/4 Hr

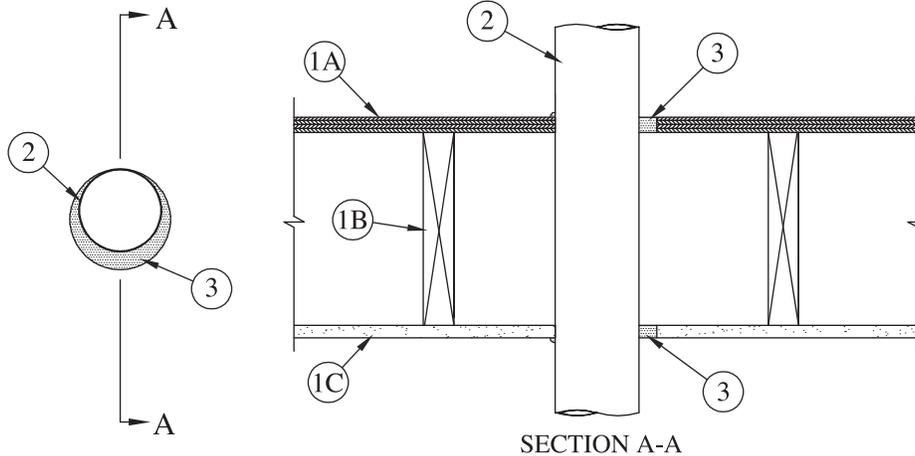

1. **Floor-Ceiling Assembly** – The 1 hr fire-rated solid or trussed lumber joist floor-ceiling assembly shall be constructed of the materials and in the manner specified in the individual L500 Series Floor-Ceiling Designs in the UL Fire Resistance Directory. The general construction details of the floor-ceiling assembly are summarized below:
 - A. **Flooring System** – Lumber or plywood subfloor with finish floor of lumber, plywood or **Floor Topping Mixture*** as specified in the individual Floor-Ceiling Design. Max diam of opening is 5-1/2 in. (140 mm).
 - B. **Wood Joists** – Nom 10 in. (254 mm) deep (or deeper) lumber, steel or combination lumber and steel joists, trusses or **Structural Wood Members*** with bridging as required and with ends firestopped.
 - C. **Gypsum Board*** – Nom 4 ft (122 cm) wide by 5/8 in. (16 mm) thick as specified in the individual Floor-Ceiling Design. Max diam of opening is 5-1/2 in. (140 mm).
- 1.1 **Chase Wall** (Optional, not shown) – The through penetrants (Item No. 2) may be routed through a fire-rated single, double or staggered wood stud/gypsum board chase wall having a fire rating consistent with that of the floor-ceiling assembly. The chase wall shall be constructed of the materials and in the manner specified in the individual U300 Series Wall and Partition Designs in the UL Fire Resistance Directory and shall include the following construction features:
 - A. **Studs** – Nom 2 in. by 6 in. (51 mm by 152 mm) or double nom 2 in. by 4 in. (51 mm by 102 mm) lumber studs.
 - B. **Sole Plate** – Nom 2 in. by 6 in. (51 mm by 152 mm) or parallel 2 in. by 4 in. (51 mm by 102 mm) lumber plates, tightly butted. Max diam of opening is 5-1/2 in. (140 mm).
 - C. **Top Plate** – The double top plate shall consist of two nom 2 in. by 6 in. (51 mm by 152 mm) or two sets of parallel 2 in. by 4 in. (51 mm by 102 mm) lumber plates, tightly butted. Max diam of opening is 5-1/2 in. (140 mm).
 - D. **Gypsum Board*** – Thickness, type, number of layers and fasteners shall be as specified in individual Wall and Partition Design.
2. **Through Penetrants** – One or more metallic pipes, conduits, tubes or flexible metal pipes installed concentrically or eccentrically within opening. Annular space between penetrants and periphery of opening to be min 0 in. (point contact) to max 1-3/8 in. (0 mm to max 35 mm). Penetrants to be rigidly supported on both sides of floor-ceiling. The following types and sizes of penetrants may be used:
 - A. **Steel Pipe** – Nom 4 in. (102 mm) diam (or smaller) Schedule 5 (or heavier) steel pipe.
 - B. **Iron Pipe** – Nom 4 in. (102 mm) diam (or smaller) cast or ductile iron pipe.
 - C. **Conduit** – Nom 4 in. (102 mm) diam (or smaller) steel electrical metallic tubing (EMT) or nom 6 in. (152 mm) rigid steel conduit.
 - D. **Copper Tubing** – Nom 4 in. (102 mm) diam (or smaller) Type L (or heavier) copper tubing.
 - E. **Copper Pipe** – Nom 4 in. (102 mm) diam (or smaller) Regular (or heavier) copper pipe.
 - F. **Through Penetrating Product*** – **Flexible Metal Piping** – The following types of steel flexible metal gas piping may be used:
 1. Nom 2 in. (51 mm) diam (or smaller) steel flexible metal gas piping. Plastic covering on piping may or may not be removed on both sides of floor or wall assembly.
OMEGA FLEX INC.
 2. Nom 1 in. (25 mm) diam (or smaller) steel flexible metal gas piping. Plastic covering on piping may or may not be removed on both sides of floor or wall assembly.
TITEFLEX CORP, A BUNDY CO.
 3. Nom 1 in. (25 mm) diam (or smaller) steel flexible metal gas piping. Plastic covering on piping may or may not be removed on both sides of floor or wall assembly.
WARD MFG INC.
3. **Fill, Void or Cavity Materials*** – **Caulk or Sealant** – Min 3/4 in. (19 mm) thickness of caulk applied within annulus, flush with top surface of floor or sole plate. Min 5/8 in. (16 mm) thickness of caulk applied within annulus, flush with bottom surface of ceiling or top plate. Min 1/4 in. (6 mm) diam bead of caulk applied at point contact locations at penetrant/floor or sole plate interface on top surface of floor or sole plate and at penetrant/ceiling or top plate interface.
3M COMPANY – IC 15WB+, CP 25WB+ caulk or FB-3000 WT sealant.

*Bearing the UL Classification Marking

Reprinted from the Online Certifications Directory with permission from Underwriters Laboratories Inc.
 Copyright © 2010 Underwriters Laboratories Inc.®



System No. F-C-1095

May 18, 2005
F Rating – 1 Hr
T Rating – 3/4 Hr

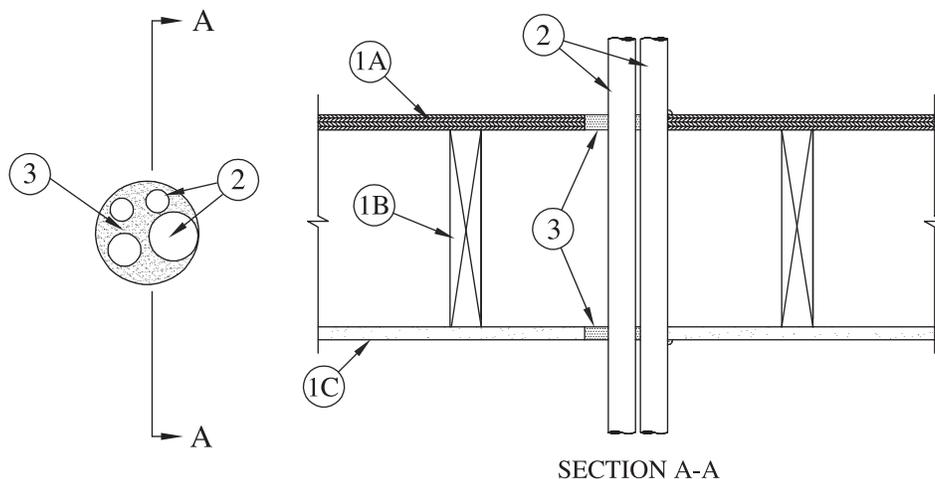

1. **Floor-Ceiling Assembly** – The 1 hr fire-rated solid or trussed lumber joist floor-ceiling assembly shall be constructed of the materials and in the manner specified in the individual L500 Series Floor-Ceiling Designs in the UL Fire Resistance Directory. The general construction details of the floor-ceiling assembly are summarized below:
 - A. **Flooring System** – Lumber or plywood subfloor with finish floor of lumber, plywood or **Floor Topping Mixture*** as specified in the individual Floor-Ceiling Design. Max diam of opening is 5 in. (127 mm).
 - B. **Wood Joists** – Nom 10 in. (254 mm) deep (or deeper) lumber, steel or combination lumber and steel joists, trusses or **Structural Wood Members*** with bridging as required and with ends firestopped.
 - C. **Gypsum Board*** – Nom 4 ft (122 cm) wide by 5/8 in. (16 mm) thick as specified in the individual Floor-Ceiling Design. Max diam of opening is 5 in. (127 mm).
- 1.1 **Chase Wall** (Optional, not shown) – The through penetrants (Item No. 2) may be routed through a fire-rated single, double or staggered wood stud/gypsum board chase wall having a fire rating consistent with that of the floor-ceiling assembly. The chase wall shall be constructed of the materials and in the manner specified in the individual U300 Series Wall and Partition Designs in the UL Fire Resistance Directory and shall include the following construction features:
 - A. **Studs** – Nom 2 in. by 6 in. (51 mm by 152 mm) or double nom 2 in. by 4 in. (51 mm by 102 mm) lumber studs.
 - B. **Sole Plate** – Nom 2 in. by 6 in. (51 mm by 152 mm) or parallel 2 in. by 4 in. (51 mm by 102 mm) lumber plates, tightly butted. Max diam of opening is 5 in. (127 mm).
 - C. **Top Plate** – The double top plate shall consist of two nom 2 in. by 6 in. (51 mm by 152 mm) or two sets of parallel 2 by 4 in. (51 mm by 102 mm) lumber plates, tightly butted. Max diam of opening is 5 in. (127 mm).
 - D. **Gypsum Board*** – Thickness, type, number of layers and fasteners shall be as specified in individual Wall and Partition Design.
2. **Through Penetrants** – One or more metallic pipes, conduits, tubes or flexible metal pipes installed concentrically or eccentrically within opening. Annular space between penetrants and periphery of opening to be min 0 in. (point contact) to max 1-1/2 in. (0 mm to max 38 mm). Space between penetrants to be min 1/4 in. to max 2 in. (6 mm to max 51 mm). Penetrants to be rigidly supported on both sides of floor-ceiling. The following types and sizes of penetrants may be used:
 - A. **Steel Pipe** – Nom 2 in. (51 mm) diam (or smaller) Schedule 5 (or heavier) steel pipe.
 - B. **Iron Pipe** – Nom 2 in. (51 mm) diam (or smaller) cast or ductile iron pipe.
 - C. **Conduit** – Nom 2 in. (51 mm) diam (or smaller) steel electrical metallic tubing (EMT) or nom 6 in. rigid steel conduit.
 - D. **Copper Tubing** – Nom 1-1/2 in. (38 mm) diam (or smaller) Type L (or heavier) copper tubing.
 - E. **Copper Pipe** – Nom 1-1/2 in. (38 mm) diam (or smaller) Regular (or heavier) copper pipe.
 - F. **Through Penetrating Product*** – Flexible Metal Piping – The following types of steel flexible metal gas piping may be used:
 1. Nom 1 in. (25 mm) diam (or smaller) steel flexible metal gas piping. Plastic covering on piping may or may not be removed on both sides of floor or wall assembly.
OMEGA FLEX INC.
 2. Nom 1 in. (25 mm) diam (or smaller) steel flexible metal gas piping. Plastic covering on piping may or may not be removed on both sides of floor or wall assembly.
TITFLEX CORP, A BUNDY CO.
 3. Nom 1 in. (25 mm) diam (or smaller) steel flexible metal gas piping. Plastic covering on piping may or may not be removed on both sides of floor or wall assembly.
WARD MFG INC.
3. **Fill, Void or Cavity Materials*** – **Caulk or Sealant** – Min 3/4 in. (19 mm) thickness of caulk applied within annulus, flush with top surface of floor or sole plate. Min 5/8 in. (16 mm) thickness of caulk applied within annulus, flush with bottom surface of ceiling or top plate. Min 1/4 in. (6 mm) diam bead of caulk applied at point contact locations at penetrant/floor or sole plate interface on top surface of floor or sole plate and at penetrant/ceiling or top plate interface.

3M COMPANY – IC 15WB+, CP 25WB+ caulk or FB-3000 WT sealant.

*Bearing the UL Classification Marking

Reprinted from the Online Certifications Directory with permission from Underwriters Laboratories Inc.
Copyright © 2010 Underwriters Laboratories Inc.®



System No. F-C-1159

September 25, 2008

F Rating – 1 Hr

T Rating – 0 or 1/2 Hr (See Item 2)

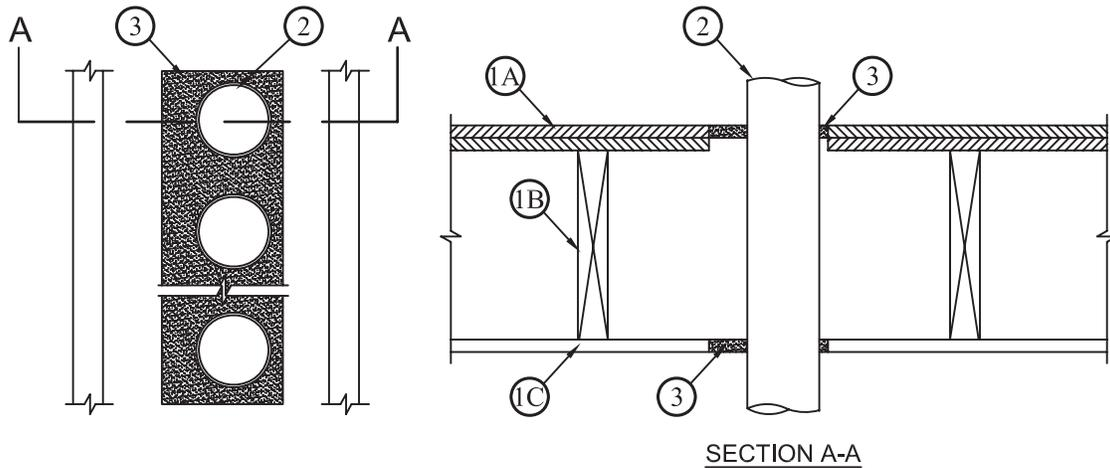

1. **Floor-Ceiling Assembly** – The 1 hr fire-rated solid or trussed lumber joist floor-ceiling assembly shall be constructed of the materials and in the manner specified in the individual L500 Series Floor-Ceiling Designs in the UL Fire Resistance Directory. The general construction details of the floor-ceiling assembly are summarized below:
 - A. **Flooring System** – Lumber or plywood subfloor with finish floor of lumber, plywood or **Floor Topping Mixture*** as specified in the individual Floor-Ceiling Design. Max area of opening is 288 in² (1471 cm²) with max dimension of 48 in. (1219 mm). The longer dimension of rectangular opening to be parallel to the wood joist direction and opening center between joists.
 - B. **Wood Joists** – Nom 10 in. (254 mm) deep (or deeper) lumber, steel or combination lumber and steel joists, trusses or **Structural Wood Members*** with bridging as required and with ends firestopped.
 - C. **Gypsum Board*** – Nom 4 ft (122 cm) wide by 5/8 in. (16 mm) thick as specified in the individual Floor-Ceiling Design. Max area of opening is 288 in² (1471 cm²) with max dimension of 48 in. (1219 mm). The longer dimension of rectangular opening to be parallel to the wood joist direction and opening center between joists.
2. **Through Penetrants** – One or more metallic pipes, conduits or tubes installed concentrically or eccentrically within opening. Annular space between penetrants and periphery of opening to be min 0 in. (0 mm) (point contact) to max 2 in. (51 mm). Space between penetrants to be min 1/4 in. (6 mm) to max 2 in. (51 mm). Penetrants to be rigidly supported on both sides of floor-ceiling. The following types and sizes of penetrants may be used:
 - A. **Steel Pipe** – Nom 4 in. (102 mm) diam (or smaller) Schedule 5 (or heavier) steel pipe.
 - B. **Iron Pipe** – Nom 4 in. (102) diam (or smaller) cast or ductile iron pipe.
 - C. **Conduit** – Nom 4 in. (102 mm) diam (or smaller) steel electrical metallic tubing (EMT) or nom 4 in. rigid steel conduit.
 - D. **Copper Tubing** – Max three lengths of Nom 4 in. (102mm) diam (or smaller) Type L (or heavier) copper tubing.
 - E. **Copper Pipe** – Max three lengths of Nom 4 in. (102 mm) diam (or smaller) Regular (or heavier) copper pipe.

The T Rating of the firestop system is dependent upon the max nom diam and type of through penetrant used within the firestop system as shown in the table below:

| Type of Through Penetrant | Max Nom Diam. In. (mm) | T Rating Hr |
|------------------------------------|------------------------|-------------|
| Copper Tube, CU Pipe | 4 (102) | 1/2 |
| Conduit steel pipe, EMT, Iron pipe | 4 (102) | 1/2 |
| Conduit steel pipe, EMT, Iron pipe | 2 (51) | 1 |

3. **Fill, Void or Cavity Materials*** – Caulk or Sealant – Min 3/4 in. (19 mm) thickness of caulk applied within annulus, flush with top surface of floor. Min 5/8 in. (16 mm) thickness of caulk applied within annulus, flush with bottom surface of ceiling. Min 1/4 in. (6 mm) diam bead of caulk applied at point contact locations at penetrant/floor on top surface of floor and at penetrant/ceiling interface.

3M COMPANY

3M FIRE PROTECTION PRODUCTS – IC 15WB+, CP 25WB+ or FB-3000 WT

*Bearing the UL Classification Marking

Reprinted from the Online Certifications Directory with permission from UL

© 2012 UL LLC



System No. F-C-1161

July 30, 2009
 F Rating – 1 Hr
 T Rating – 0 Hr

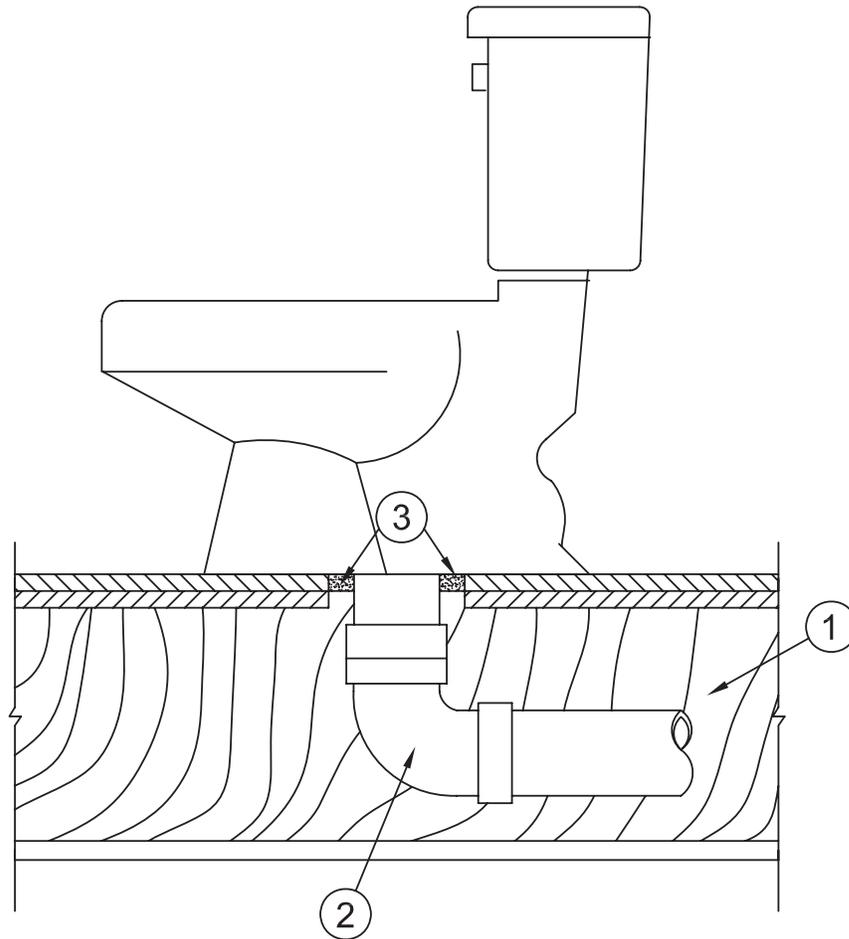

1. **Floor-Ceiling Assembly** – The 1 hr fire-rated solid or trussed lumber joist floor-ceiling assembly shall be constructed of the materials and in the manner specified in the individual L500 Series Floor-Ceiling Designs in the UL Fire Resistance Directory. The general construction details of the floor-ceiling assembly are summarized below:
 - A. **Flooring System** – Lumber or plywood subfloor with finish floor of lumber, plywood or **Floor Topping Mixture*** as specified in the individual Floor-Ceiling Design. Diam of opening shall be 1 in. (25 mm) larger than diam of pipe. Max diam of opening is 5-1/2 in. (140 mm).
 - B. **Wood Joists** – Nom 10 in. (254 mm) deep (or deeper) lumber, steel or combination lumber and steel joists, trusses or **Structural Wood Members*** with bridging as required and with ends firestopped.
 - C. **Gypsum Board*** – Nom 4 ft (1.2 m) wide by 5/8 in. (16 mm) thick as specified in the individual Floor-Ceiling Design. Diam of opening shall be 1 in. (25 mm) larger than diam of pipe. Max diam of opening is 5-1/2 in. (140 mm).
2. **Metallic Pipe** – One metallic drain pipe with max 4 in. (102 mm) diam toilet flange installed within the firestop system. The annular space between drain pipe and periphery of opening shall be min 1/2 in. to max 1-1/2 in. Pipe to be rigidly supported on lower side of floor assembly. The following types and sizes of metallic pipes, fittings and flanges may be used:
 - A. **Iron Pipe** – Nom 4 in. diam (or smaller) Schedule 40 cast iron pipe for use in vented (drain, waste or vent) piping system. Pipe and elbow reliably supported above ceiling.
 - B. **Copper Pipe** – Nom 4 in. diam (or smaller) Type DWV copper pipe for use in vented (drain, waste or vent) piping systems. Pipe and elbow reliably supported above ceiling.
3. **Fill, Void or Cavity Materials* – Caulk or Sealant** – Min 1/2 in. (13 mm) thickness of caulk applied within annular space around perimeter of ABS Pipe (Item 2), flush with top surface of floor.
3M COMPANY – IC 15WB+, CP 25WB+, FB-3000WT
4. **Water Closet** – Floor mounted vitreous china water closet.

*Bearing the UL Classification Mark

Reprinted from the Online Certifications Directory with permission from Underwriters Laboratories Inc.
 Copyright © 2010 Underwriters Laboratories Inc.®



System No. F-C-1165

April 02, 2015

F Rating — 1 Hr

T Rating — 0 Hr

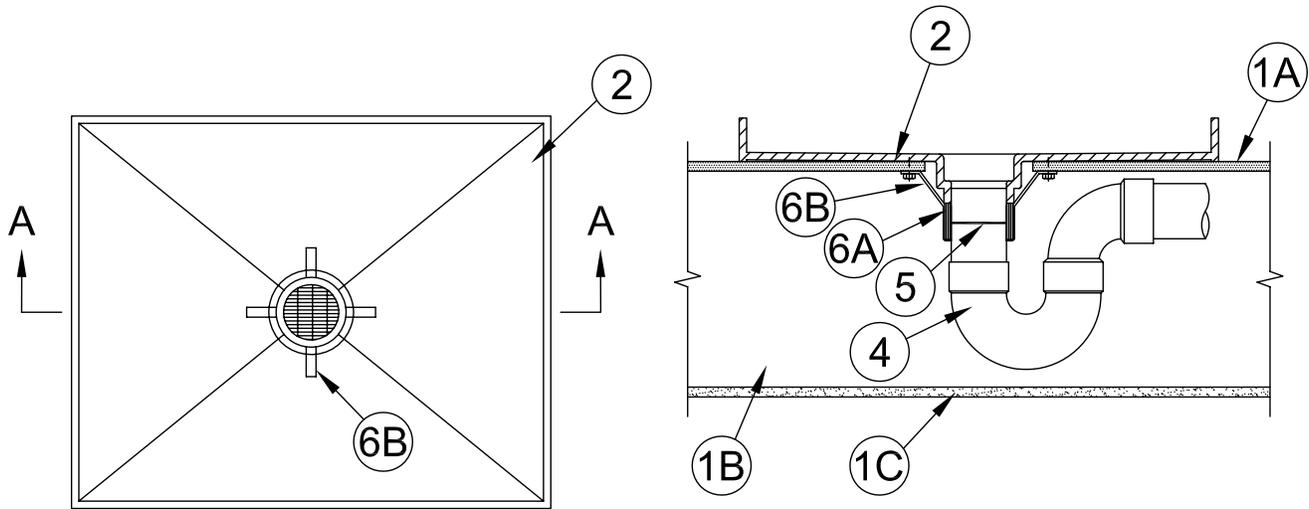

SECTION A-A

- Floor-Ceiling Assembly** — The 1 hr fire-rated wood joist floor-ceiling assembly shall be constructed of the materials and in the manner specified in the individual L500 Designs in the UL Fire Resistance Directory, as summarized below:
 - Flooring System** — Lumber or plywood subfloor with finish floor of lumber, plywood or **Floor Topping Mixture*** as specified in the individual Floor-Ceiling Design. Max diam of opening is 6 in. (152 mm).
 - Wood Joists** — Nom 10 in. (254 mm) deep (or deeper) lumber, steel or combination lumber and steel joists, trusses or **Structural Wood Members*** with bridging as required and with ends firestopped.
 - Gypsum Board*** — Thickness, type, number of layers and fasteners as required in the individual Floor-Ceiling Design.
- Plastic Plumbing Fixtures+ - Shower Base Receptor** — One-piece molded nonmetallic shower base receptor with max 4 in. (102 mm) diam plastic drain and stainless steel drain plate. Shower base receptor to be installed centrally within the annular space in accordance with the manufacturer's instructions.

TILE-REDI USA LLC — Model 3360L, 3360R, 37NEO, 3737, 4837, 4837ADA, 4837MB or 4848
- Tile** — (Not Shown) - Ceramic or stone tile applied to shower pan floor with epoxy adhesive in accordance with shower base receptor installation instructions.
- Metallic Pipe** — One metallic pipe installed into PVC shower drain at bottom of the shower base receptor using compression coupling. Penetrant to be rigidly supported in floor-ceiling assembly. The following types and sizes of penetrants may be used:
 - Steel Pipe** — Nom 4 in. (102 mm) diam (or smaller) Schedule 10 (or heavier) steel pipe.
 - Iron Pipe** — Nom 4 in. (102 mm) diam (or smaller) cast or ductile iron pipe.
- Compression Coupling** — Nonmetallic shower drain (Item 2) to be secured to metallic pipe with compression type high pressure pipe coupling with elastomeric gasket and a stainless steel jacket with stainless steel band clamps.
- Firestop System** — The details of the firestop system shall be as follows:
 - Fill, Void or Cavity Materials* - Wrap Strip** — Nom 1/8 in. (3.2 mm) thick intumescent material supplied in 2 in. (51 mm) wide strips. Four layers of wrap strip tightly wrapped around PVC shower drain pipe/compression coupling (Item 5) with butted seams or continuous layers and with the top edge of the wrap strip flush with bottom surface of plywood. Wrap strip layer temporarily held in position using tape.

3M COMPANY 3M FIRE PROTECTION PRODUCTS — Ultra GS
 - Steel Collar** — Nom 2 in. (51 mm) deep collar with 1-1/4 in. (32 mm) wide by 2 in. (51 mm) long anchor tabs and tabs to retain wrap strip layer. Coils of precut 0.016 in. (0.41 mm) thick (28 gauge) galv sheet steel available from wrap strip manufacturer. Steel collar, with anchor tabs bent outward 90 deg, wrapped tightly around wrap strip with min 1 in. (25 mm) overlap at seam. Anchor tabs to be pressed tightly against compression coupling/drain pipe, and collar to be compressed around wrap strip using a min 1/2 in. (13 mm) wide stainless steel clamp at the collar midheight. Collar to be secured to underside of flooring system with steel screws with min 1-1/4 in. (32 mm) diam steel washers through anchor tabs of collar bent 90 deg to rest against plywood subfloor. Min of four screws symmetrically located are required.

* Indicates such products shall bear the UL or cUL Certification Mark for jurisdictions employing the UL or cUL Certification (such as Canada), respectively.

Reprinted from the Online Certifications Directory with permission from UL

© 2015 UL LLC



System No. F-C-1166

March 24, 2015

ANSI/UL1479 (ASTM E814)

F Rating — 1 Hr

T Rating — 0 Hr

CAN/ULC S115

F Rating — 1 Hr

FT Rating — 0 Hr

FH Rating — 1 Hr

FTH Rating — 0 Hr

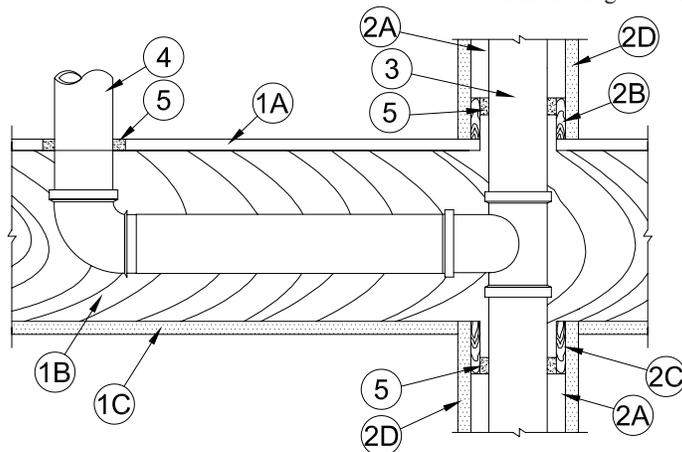

1. **Floor Assembly** — The 1 hr fire rated wood truss or combination wood and steel truss Floor-Ceiling assembly shall be constructed of the materials and in the manner described in the individual L500 Series Design in the UL Fire Resistance Directory, as summarized below:
 - A. **Flooring System** — Lumber or plywood subfloor with finish floor of lumber, plywood or **Floor Topping Mixture*** as specified in the individual Floor-Ceiling Design. Max diam of opening is 5-1/2 in. (140 mm).
 - B. **Joists** — Nom 10 in. (254 mm) deep (or deeper) lumber, steel or combination lumber and steel joists, trusses or **Structural Wood Members*** with bridging as required and ends firestopped.
 - C. **Gypsum Board*** — Nom 4 ft (1.2 m) wide by 5/8 in. (16 mm) thick, attached as described in the individual Floor-Ceiling Design.
2. **Chase Wall** — The through penetrant (Item No. 3) shall be routed through a 1 hr fire-rated single, double or staggered wood studs/gypsum board chase wall constructed of the materials and in the manner specified in the individual U300 Series Wall and Partition Designs in the UL Fire Resistance Directory and shall include the following construction features:
 - A. **Studs** — Nom 2 by 4 in. (51 by 102 mm) or 2 by 6 in. (51 by 152 mm) lumber studs.
 - B. **Sole Plate** — Nom 2 by 4 in. (51 by 102 mm) or 2 by 6 in. (51 by 152 mm) lumber plates. Diam of opening or length of notch-out in sole plate to be max 5-1/2 in. (140 mm). Plate may be discontinuous over opening, terminating at both sides of periphery of opening (see Item C1).
 - C. **Top Plate** — The double top plate shall consist of two nom 2 by 4 in. (51 by 102 mm) or 2 by 6 in. (51 by 152 mm) lumber plates. Diam of opening or length of notch-out in top plate to be max 5-1/2 in. (140 mm). Plate may be discontinuous over opening, terminating at both sides of periphery of opening (see Item C1).
 - C1. **Steel Plate** — Nom 16 gauge (or heavier) 1-1/2 in. (38 mm) wide steel plate, connecting both sides of discontinuous top and sole plate. Steel plates to be sized in length to overlap a min of 4 in. (102 mm) onto each side of the discontinuous top or sole plates and secured with a min of two 1/2 in. (13 mm) long (or longer) No. 8 (or larger) wood screws on each side of each plate.
 - D. **Gypsum Board*** — Thickness, type, number of layers and fasteners shall be as specified in individual Wall and Partition Design.
3. **Through Penetrant** — One metallic pipe to be installed within the firestop system. Pipe to be rigidly supported on both sides of floor-ceiling assembly. The annular space between pipe and periphery of opening shall be min 0 in. (point contact) to max 1-3/8 in. (35 mm). The following types and sizes of nonmetallic pipes may be used:
 - A. **Steel Pipe** — Nom 4 in. (102 mm) diam (or smaller) Schedule 5 (or heavier) steel pipe.
 - B. **Iron Pipe** — Nom 4 in. (102 mm) diam (or smaller) cast or ductile iron pipe.
 - C. **Copper Tubing** — Nom 4 in. (102 mm) diam (or smaller) Type L (or heavier) copper tubing.
 - D. **Copper Pipe** — Nom 4 in. (102 mm) diam (or smaller) Regular (or heavier) copper pipe.
4. **Branch Piping** — (Optional) — One metallic pipe to be connected to through penetrant (Item 3) and installed within opening in subfloor. The annular space between pipe and periphery of opening shall be min 0 in. (point contact) to max 1/2 in. (13 mm). The following types and sizes of metallic pipes may be used:
 - A. **Steel Pipe** — Nom 3 in. (76 mm) diam (or smaller) Schedule 5 (or heavier) steel pipe.
 - B. **Iron Pipe** — Nom 3 in. (76 mm) diam (or smaller) cast or ductile iron pipe.
 - C. **Copper Tubing** — Nom 3 in. (76 mm) diam (or smaller) Type L (or heavier) copper tubing.
 - D. **Copper Pipe** — Nom 3 in. (76 mm) diam (or smaller) Regular (or heavier) copper pipe.
5. **Fill, Void or Cavity Materials*** — **Caulk or Sealant** — Min 3/4 in. (19 mm) thickness of caulk applied within annular space around perimeter of through penetrant (Item 3), flush with top surface of floor or sole plate and flush with bottom surface of top plate. Min 3/4 in. (19 mm) thickness of caulk applied within annular space around perimeter of branch piping (Item 4), flush with top surface of floor. Min 1/2 in. (13 mm) diam bead applied at the pipe/floor interface and the pipe/plate interface.

3M COMPANY — CP 25WB+ caulk, IC 15WB+ caulk or FB-3000 WT sealant

* Indicates such products shall bear the UL or cUL Certification Mark for jurisdictions employing the UL or cUL Certification (such as Canada), respectively.

Reprinted from the Online Certifications Directory with permission from UL

© 2015 UL LLC



System No. F-C-1167

April 02, 2015

ANSI/UL1479 (ASTM E814)

F Rating — 1 Hr

T Rating — 0 Hr

CAN/ULC S115

F Rating — 1 Hr

FT Rating — 0 Hr

FH Rating — 1 Hr

FTH Rating — 0 Hr

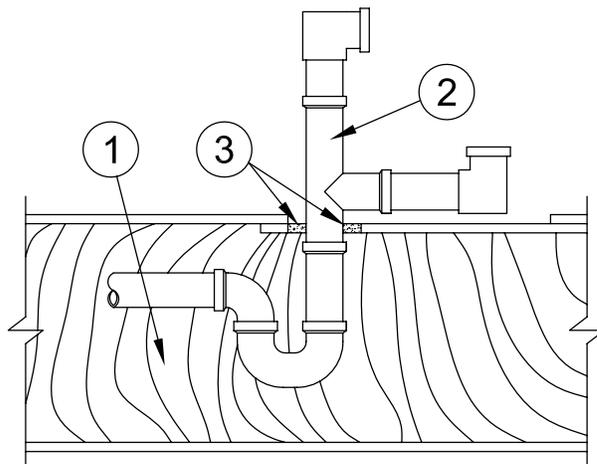
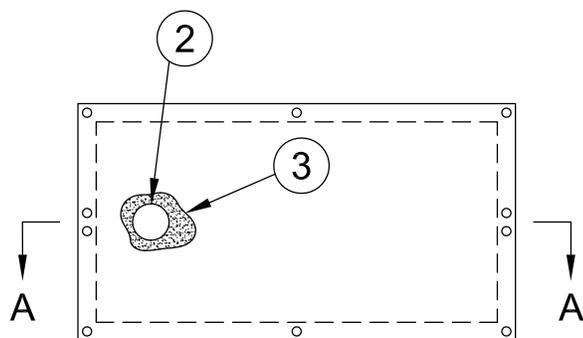

SECTION A-A

1. **Floor-Ceiling Assembly** — The 1 hr fire-rated solid or trussed lumber joist floor-ceiling assembly shall be constructed of the materials and in the manner specified in the individual L500 Series Floor-Ceiling Designs in the UL Fire Resistance Directory. The general construction details of the floor-ceiling assembly are summarized below:
 - A. **Flooring System** — Lumber or plywood subfloor with finish floor of lumber, plywood or **Floor Topping Mixture*** as specified in the individual Floor-Ceiling Design. Rectangular cutout in flooring to accommodate the bathtub drain piping (Item 2) to be max 8 by 12 in. (203 by 305 mm). Cutout to be patched using one layer of min 3/4 in. (19 mm) thick plywood or min 5/8 in. (16 mm) thick gypsum board (Item 1C). One piece of plywood or gypsum board, min 2 in. (51 mm) longer and wider than the cutout in the flooring, cut in half in short dimension at opening hole-sawed for bathtub drain piping (Item 2). Two halves positioned below flooring, concentric with cutout, with cut edges tightly butted with no visible openings, and screw attached by means of 1-1/2 in. (38 mm) long laminate screw spaced max 4-1/2 in. (114 mm) OC, at every corner and max 1/2 in. (13 mm) from cut edges. Max diameter opening is 5-1/2 in. (140 mm).
 - B. **Wood Joists** — Nom 10 in. (254 mm) deep (or deeper) lumber, steel or combination lumber and steel joists, trusses or **Structural Wood Members*** with bridging as required and with ends firestopped.
 - C. **Gypsum Board*** — Nom 4 ft (1.2 m) wide by 5/8 in. (16 mm) thick as specified in the individual Floor-Ceiling Design.
2. **Drain Piping** — One metallic pipe or tube with drain fittings and bathtub waste/overflow fittings installed concentrically or eccentrically within opening. Annular space between penetrant and periphery of opening to be min 0 in. (point contact) to max 1-3/8 in. (35 mm). Penetrant to be rigidly supported on both sides of floor-ceiling. The following types and sizes of penetrants may be used:
 - A. **Steel Pipe** — Nom 4 in. (102 mm) diam (or smaller) Schedule 10 (or heavier) steel pipe.
 - B. **Iron Pipe** — Nom 4 in. (102 mm) diam (or smaller) cast or ductile iron pipe.
 - C. **Packing Material** — Min 3 in. thickness of min 6 pct loose ceramic fiber or mineral wool insulation firmly packed into opening.
3. **Fill, Void or Cavity Materials*** — **Caulk or Sealant** — OMin 5/8 in. (16 mm) thickness of sealant applied within annular space around perimeter of Drain Piping, flush with top surface of plywood or gypsum wallboard patch.

3M COMPANY 3M FIRE PROTECTION PRODUCTS — IC 15WB+ Sealant, CP 25WB+ Caulk, or FB-3000 WT

* Indicates such products shall bear the UL or cUL Certification Mark for jurisdictions employing the UL or cUL Certification (such as Canada), respectively.

Reprinted from the Online Certifications Directory with permission from UL

© 2015 UL LLC



Through Penetrations

Metallic Pipes

1000 Series

Wood Frame Floor/Ceiling

FC

System No. F-E-1001

March 23, 2012

F Rating – 1 Hr

T Rating – 1 Hr

L Rating At Ambient – Less Than 1 CFM/Sq Ft (See Item 3)

L Rating At 400°F – Less Than 1 CFM/Sq Ft (See Item 3)

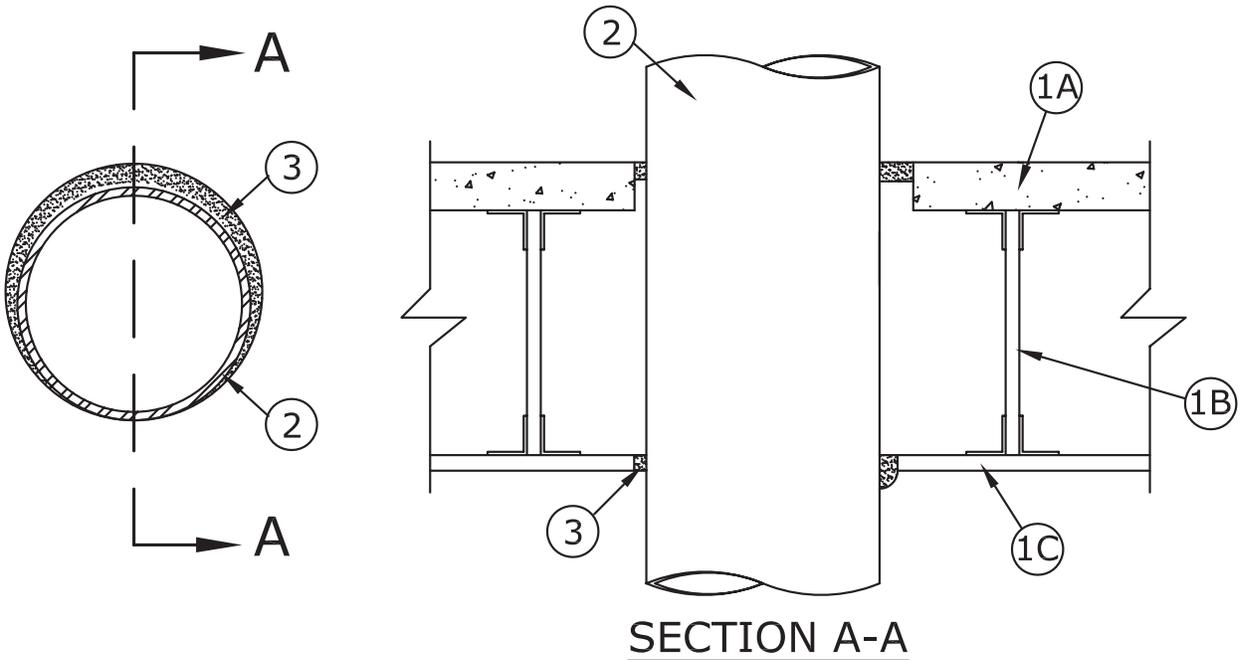

1. **Floor-Ceiling Assembly** – The 1 hr fire rated concrete and steel joist Floor-Ceiling assembly shall be constructed of the materials and in the manner described in the individual G500 Series Design in the UL Fire Resistance Directory, as summarized below:
 - A. **Flooring** – Normal or Lightweight or normal weight (100-150 pcf or 1600-2400 kg/m³) concrete as specified in the individual G500 Series Design. Max diam of opening is 11-1/4 in. (286 mm).
 - B. **Joists** – Steel joists or **Structural Steel Members*** as specified in the individual G500 Series Design.
 - C. **Gypsum Board*** – Min 5/8 in. (16 mm) thick, screw-attached to furring channels as specified in the individual G500 Series Design. Max diam of opening is 11-1/4 in. (286 mm).
2. **Through Penetrant** – One metallic pipe, conduit or tubing to be installed either concentrically or eccentrically within the opening, approx midway between joists. The annular space between penetrant and periphery of opening shall be min 1/4 in. (6 mm) to max 1/2 in. (13 mm). Penetrant to be rigidly supported on both sides of floor assembly. The following types and sizes of metallic pipe, conduit or tubing may be used:
 - A. **Steel Pipe** – Nom 10 in. (254 mm) diam (or smaller) Schedule 10 (or heavier) steel pipe.
 - B. **Iron Pipe** – Nom 10 in. (254 mm) diam (or smaller) cast or ductile iron pipe.
 - C. **Conduit** – Nom 6 in. (152 mm) diam (or smaller) steel conduit, or nom 4 in. (102 mm) diam (or smaller) electrical metallic tubing.
 - D. **Copper Tubing** – Nom 3 in. (76 mm) diam (or smaller) Type L (or heavier) copper tube.
 - E. **Copper Pipe** – Nom 3 in. (76 mm) diam (or smaller) Regular (or heavier) copper pipe.
3. **Fill, Void or Cavity Materials* – Caulk or Sealant** – Min 3/4 in. (19 mm) thickness of fill material applied within the annulus, flush with top surface of floor. Min 5/8 in. (16 mm) thickness of fill material applied within the annulus, flush with bottom surface of ceiling. An additional min 1/4 in. (6 mm) crown of fill material applied to perimeter of penetrant at its egress from the underside of ceiling.

3M COMPANY – CP-25 WB+ Caulk, IC-15 WB+ Caulk or FB-3000 WT Sealant

(Note: L Rating applies only when CP 25 WB+ Caulk or FB-3000 WT Sealant is used.)

*Bearing the UL Classification Mark

Reprinted from the Online Certifications Directory with permission from UL

© 2013 UL LLC



System No. F-E-1009

May 19, 2005
 F Rating – 1 Hr
 T Rating – 1/4 Hr

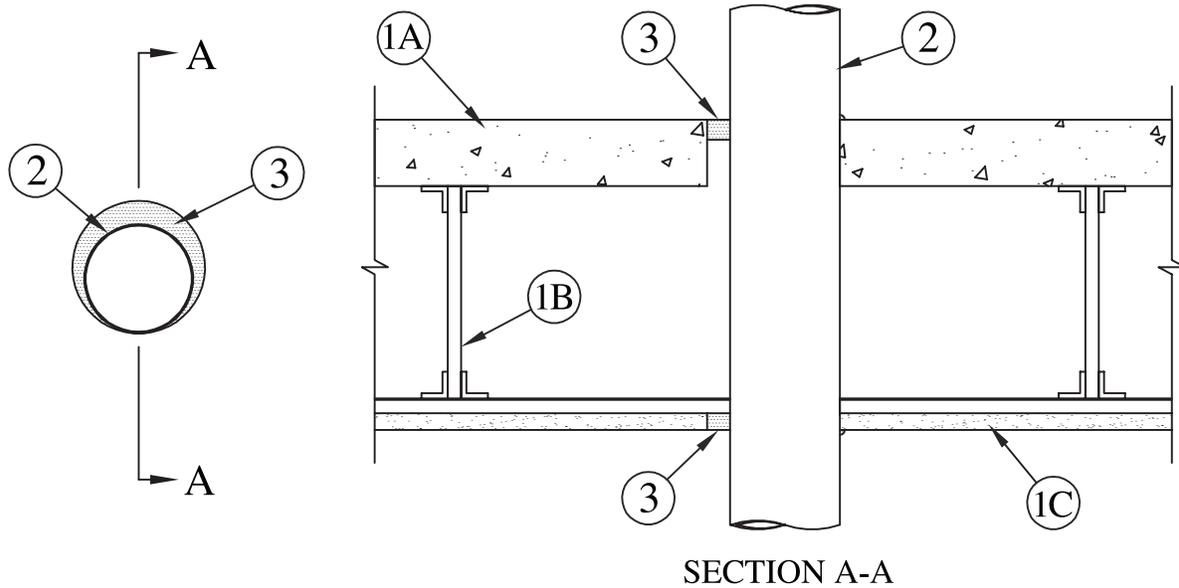

1. **Floor-Ceiling Assembly** – The 1 hr fire rated concrete and steel joist Floor-Ceiling assembly shall be constructed of the materials and in the manner described in the individual G500 Series Design in the UL Fire Resistance Directory, as summarized below:
 - A. **Flooring** – Normal or Lightweight concrete as specified in the individual G500 Series Design. Max diam of opening is 5-1/2 in. (140 mm).
 - B. **Joists** – Steel joists or **Structural Steel Members*** as specified in the individual G500 Series Design.
 - C. **Gypsum Board*** – Min 5/8 in. (16 mm) thick, screw-attached to furring channels as specified in the individual G500 Series Design. Max diam of opening is 5-1/2 in. (140 mm).
2. **Through Penetrants** – One metallic pipe, conduit, tubing or flexible metal pipe installed concentrically or eccentrically within opening. Annular space between penetrant and periphery of opening to be min 0 in. (point contact) to max 1-3/8 in. (0 mm to max 35 mm). Penetrant to be rigidly supported on both sides of floor-ceiling. The following types and sizes of penetrants may be used:
 - A. **Steel Pipe** – Nom 4 in. (102 mm) diam (or smaller) Schedule 5 (or heavier) steel pipe.
 - B. **Iron Pipe** – Nom 4 in. (102 mm) diam (or smaller) cast or ductile iron pipe.
 - C. **Conduit** – Nom 4 in. (102 mm) diam (or smaller) steel electrical metallic tubing (EMT) or nom 6 in. rigid steel conduit.
 - D. **Copper Tubing** – Nom 4 in. (102 mm) diam (or smaller) Type L (or heavier) copper tubing.
 - E. **Copper Pipe** – Nom 4 in. (102 mm) diam (or smaller) Regular (or heavier) copper pipe.
 - F. **Through Penetrating Product* – Flexible Metal Piping** – The following types of steel flexible metal gas piping may be used:
 1. Nom 2 in. (51 mm) diam (or smaller) steel flexible metal gas piping. Plastic covering on piping may or may not be removed on both sides of floor or wall assembly.
OMEGA FLEX INC.
 2. Nom 1 in. (25 mm) diam (or smaller) steel flexible metal gas piping. Plastic covering on piping may or may not be removed on both sides of floor or wall assembly.
TITFLEX CORP, A BUNDY CO.
 3. Nom 1 in. (25 mm) diam (or smaller) steel flexible metal gas piping. Plastic covering on piping may or may not be removed on both sides of floor or wall assembly.
WARD MFG INC.
3. **Fill, Void or Cavity Materials* – Caulk or Sealant** – Min 3/4 in. (19 mm) thickness of caulk applied within annulus, flush with top surface of floor. Min 5/8 in. (16 mm) thickness of caulk applied within annulus, flush with bottom surface of ceiling. Min 1/4 in. (6 mm) diam bead of caulk applied at point contact locations at penetrant/floor interface on top surface of floor and at penetrant/ceiling interface.
3M COMPANY – IC 15WB+, CP 25WB+ caulk or FB-3000 WT sealant.

*Bearing the UL Classification Marking

Reprinted from the Online Certifications Directory with permission from Underwriters Laboratories Inc.
 Copyright © 2010 Underwriters Laboratories Inc.®



System No. F-E-1010

May 19, 2005
F Rating – 1 Hr
T Rating – 3/4 Hr

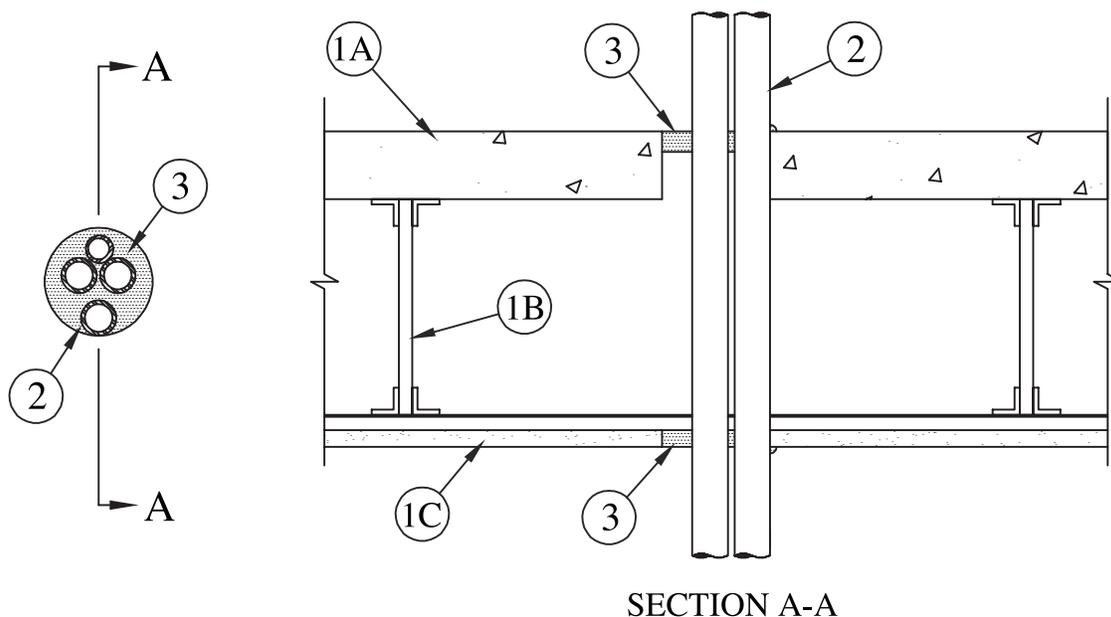

SECTION A-A

1. **Floor-Ceiling Assembly** – The 1 hr fire rated concrete and steel joist Floor-Ceiling assembly shall be constructed of the materials and in the manner described in the individual G500 Series Design in the UL Fire Resistance Directory, as summarized below:
 - A. **Flooring** – Normal or Lightweight concrete as specified in the individual G500 Series Design. Max diam of opening is 5 in. (127 mm).
 - B. **Joists** – Steel joists or **Structural Steel Members*** as specified in the individual G500 Series Design.
 - C. **Gypsum Board*** – Min 5/8 in. (16 mm) thick, screw-attached to furring channels as specified in the individual G500 Series Design. Max diam of opening is 5 in. (127 mm).
2. **Through Penetrants** – One or more metallic pipes, conduits, tubes or flexible metal pipes installed concentrically or eccentrically within opening. Annular space between penetrants and periphery of opening to be min 0 in. (point contact) to max 1-1/2 in. (0 mm to max 38 mm) Space between penetrants to be min 1/4 in. to max 2 in. (6 mm to max 51 mm). Penetrants to be rigidly supported on both sides of floor-ceiling. The following types and sizes of penetrants may be used:
 - A. **Steel Pipe** – Nom 2 in. (51 mm) diam (or smaller) Schedule 5 (or heavier) steel pipe.
 - B. **Iron Pipe** – Nom 2 in. (51 mm) diam (or smaller) cast or ductile iron pipe.
 - C. **Conduit** – Nom 2 in. (51 mm) diam (or smaller) steel electrical metallic tubing (EMT) or nom 6 in. (152 mm) rigid steel conduit.
 - D. **Copper Tubing** – Nom 1-1/2 in. (38 mm) diam (or smaller) Type L (or heavier) copper tubing.
 - E. **Copper Pipe** – Nom 1-1/2 in. (38 mm) diam (or smaller) Regular (or heavier) copper pipe.
 - F. **Through Penetrating Product* – Flexible Metal Piping** – The following types of steel flexible metal gas piping may be used:
 1. Nom 1 in. (25 mm) diam (or smaller) steel flexible metal gas piping. Plastic covering on piping may or may not be removed on both sides of floor or wall assembly.
OMEGA FLEX INC.
 2. Nom 1 in. (25 mm) diam (or smaller) steel flexible metal gas piping. Plastic covering on piping may or may not be removed on both sides of floor or wall assembly.
TITFLEX CORP, A BUNDY CO.
 3. Nom 1 in. (25 mm) diam (or smaller) steel flexible metal gas piping. Plastic covering on piping may or may not be removed on both sides of floor or wall assembly.
WARD MFG INC.
3. **Fill, Void or Cavity Materials* – Caulk or Sealant** – Min 3/4 in. (19 mm) thickness of caulk applied within annulus, flush with top surface of floor. Min 5/8 in. (16 mm) thickness of caulk applied within annulus, flush with bottom surface of ceiling. Min 1/4 in. (6 mm) diam bead of caulk applied at point contact locations at penetrant/floor interface on top surface of floor and at penetrant/ceiling interface.
3M COMPANY – IC 15WB+, CP 25WB+ caulk or FB-3000 WT sealant.

*Bearing the UL Classification Marking

Reprinted from the Online Certifications Directory with permission from Underwriters Laboratories Inc.
Copyright © 2010 Underwriters Laboratories Inc.®



System No. F-E-1028

July 30, 2009

F Rating – 1 Hr

T Rating – 0 Hr

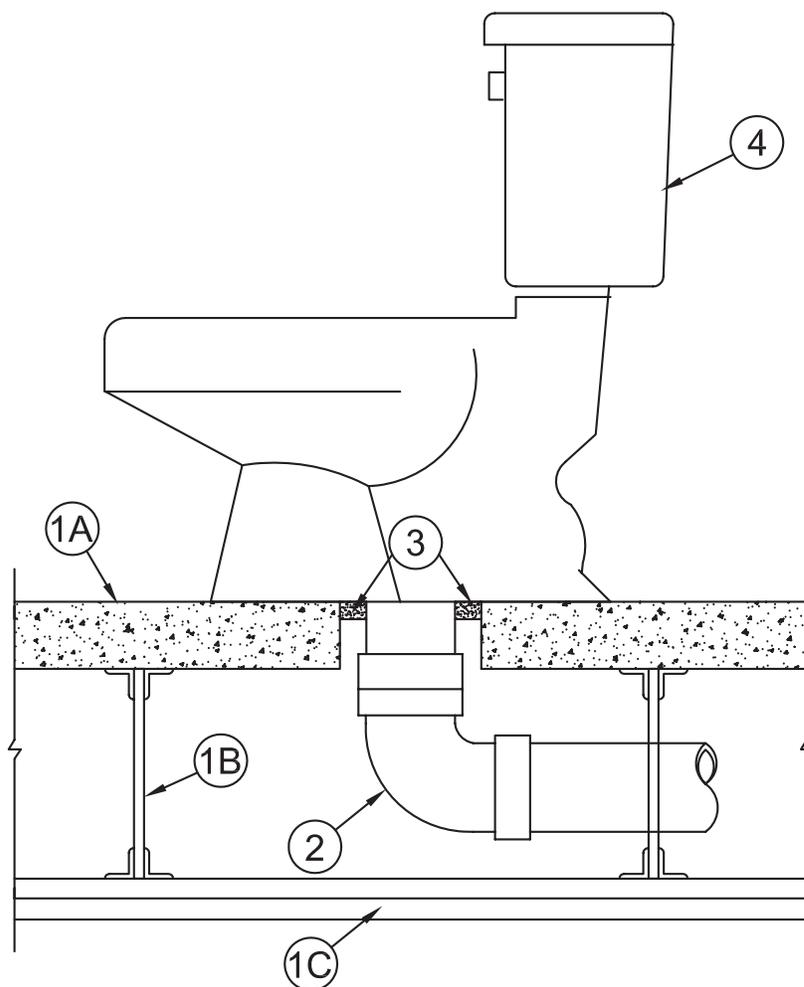

1. **Floor-Ceiling Assembly** – The 1 hr fire rated concrete and steel joist Floor-Ceiling assembly shall be constructed of the materials and in the manner described in the individual G500 Series Design in the UL Fire Resistance Directory, as summarized below:
 - A. **Flooring** – Lightweight or normal weight (100-150 pcf or 1600-2400 kg/m³) concrete as specified in the individual G500 Series Design. Diam of opening shall be max 1 in. (25 mm) larger than the nom diam of pipe (Items 2 and 3).
 - B. **Joists** – Steel joists or **Structural Steel Members*** as specified in the individual G500 Series Design.
 - C. **Gypsum Board*** – Min 5/8 in. (16 mm) thick, screw-attached to furring channels as specified in the individual G500 Series Design. Max diam of opening is 5-1/2 in. (140 mm).
2. **Metallic Pipe** – One metallic drain pipe with max 4 in. (102 mm) diam toilet flange installed within the firestop system. The annular space between drain pipe and periphery of opening shall be min 1/2 in. to max 1-1/2 in. Pipe to be rigidly supported on lower side of floor assembly. The following types and sizes of metallic pipes, fittings and flanges may be used:
 - A. **Iron Pipe** – Nom 4 in. diam (or smaller) Schedule 40 cast iron pipe for use in vented (drain, waste or vent) piping system. Pipe and elbow reliably supported above ceiling.
 - B. **Copper Pipe** – Nom 4 in. diam (or smaller) Type DWV copper pipe for use in vented (drain, waste or vent) piping systems. Pipe and elbow reliably supported above ceiling.
3. **Fill, Void or Cavity Materials* – Caulk or Sealant** – Min 1/2 in. (13 mm) thickness of caulk applied within annular space around perimeter of ABS Pipe (Item 2), flush with top surface of floor.
3M COMPANY – IC 15WB+, CP 25WB+, FB-3000WT
4. **Water Closet** – Floor mounted vitreous china water closet.

*Bearing the UL Classification Mark

Reprinted from the Online Certifications Directory with permission from UL
 © 2012 UL LLC



Through Penetrations

Metallic Pipes

1000 Series

Wood Frame Floor/Ceiling

FE

System No. F-E-1029

March 16, 2012

ANSI/UL1479 (ASTM E814)

F Rating — 1 Hr
T Rating — 1/4 Hr

CAN/ULC S115

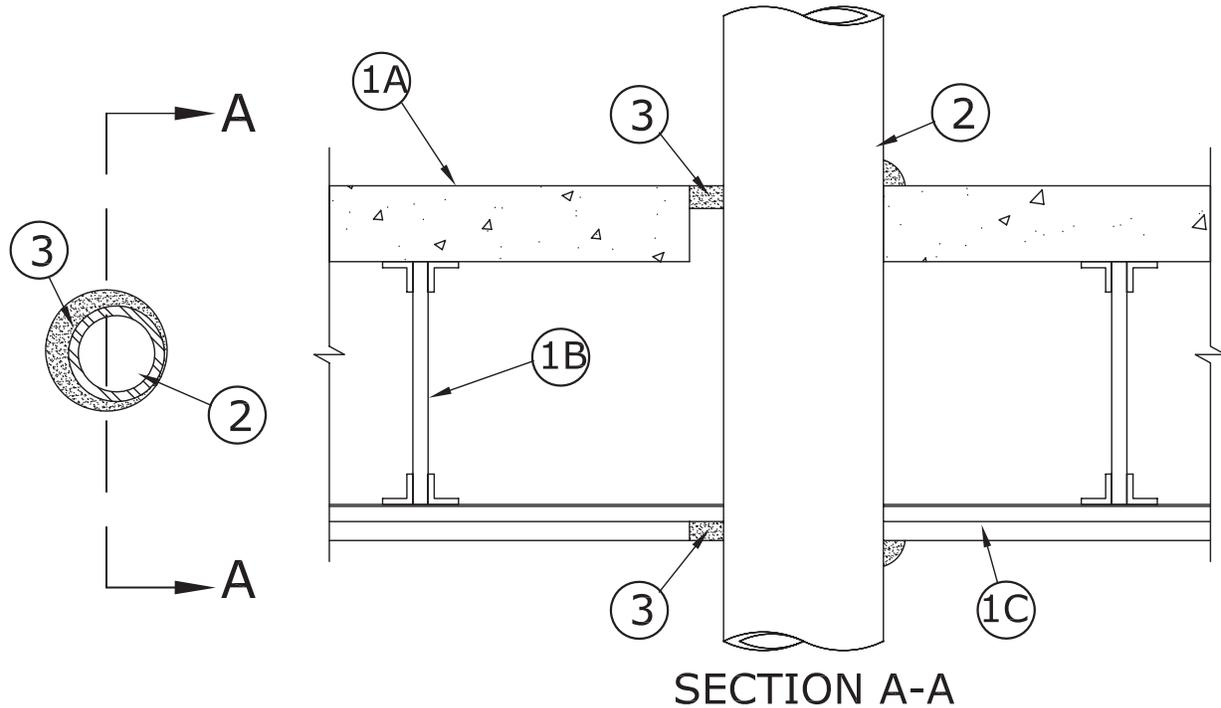
F Rating — 1 Hr
FT Rating — 1/4 Hr
FH Rating — 1 Hr
FTH Rating — 1/4 Hr

SECTION A-A

1. **Floor-Ceiling Assembly** – The minimum 1 hr fire rated concrete and steel joist Floor-Ceiling assembly shall be constructed of the materials and in the manner described in the individual G500 Series Design in the UL Fire Resistance Directory, as summarized below:
 - A. **Concrete Floor** – Normal weight or lightweight (100-150 pcf or 1600-2400 kg/m³) concrete over metal lath or steel deck as specified in the individual G500 Series Design. Max diam of floor opening is 5-1/2 in. (140 mm).
 - B. **Joists** – Steel joists or **Structural Steel Members*** as specified in the individual G500 Series Design.
 - C. **Gypsum Board*** – Min 5/8 in. (16 mm) thick, screw-attached to furring channels as specified in the individual G500 Series Design. Max diam of ceiling opening is 5-1/2 in. (140 mm).
- 1.1. **Chase Wall** – (Optional, Not Shown) – The through penetrant (Item 2) may be routed through a fire-rated single, double or staggered wood stud/gypsum board or steel stud/gypsum board chase wall having a fire rating consistent with that of the Floor-Ceiling assembly. The chase wall shall be constructed of the materials and in the manner specified in the individual U300, U400, V400 or W400 Series Wall and Partition Designs in the UL Fire Resistance Directory and shall include the following construction features:
 - A. **Studs** – Nom 2 by 4 in. (51 by 102 mm), nom 2 by 6 in. (51 by 152 mm) or double nom 2 by 4 in. (51 by 102 mm) lumber or min 3-1/2 in. (89 mm) steel studs.
 - B. **Sole Plate or Floor Runner** – Nom 2 by 4 in. (51 by 102 mm), nom 2 by 6 in. (51 by 152 mm) or parallel nom 2 by 4 in. (51 by 102 mm) lumber plates or steel floor runners sized to accommodate the steel studs, tightly butted. The steel floor runners may be discontinuous over opening, terminating at both sides of opening. Max diam of opening is 5-1/2 in. (140 mm).
 - C. **Top Plate or Ceiling Runner** – The double top plate shall consist of two nom 2 by 4 in. (51 by 102 mm), two nom 2 by 6 in. (51 by 152 mm) or two sets of parallel 2 by 4 in. (51 by 102 mm) lumber plates, tightly butted. The steel ceiling runners shall be sized to accommodate the steel studs, tightly butted. The steel ceiling runners may be discontinuous over opening, terminating at both sides of opening. Max diam of opening is 5-1/2 in. (140 mm).
 - D. **Gypsum Board*** – Thickness, type, number of layers and fasteners shall be as specified in individual Wall and Partition Design.
2. **Through Penetrants** – One metallic pipe, conduit, tubing or flexible metal pipe installed concentrically or eccentrically within opening. Annular space between penetrant and periphery of opening to be min 0 in. (0 mm) (point contact) to max 1-3/8 in. (35 mm). Penetrant to be rigidly supported on both sides of floor-ceiling. The following types and sizes of penetrants may be used:
 - A. **Steel Pipe** – Nom 4 in. (102 mm) diam (or smaller) Schedule 5 (or heavier) steel pipe.
 - B. **Iron Pipe** – Nom 4 in. (102 mm) diam (or smaller) cast or ductile iron pipe.
 - C. **Conduit** – Nom 4 in. (102 mm) diam (or smaller) steel electrical metallic tubing (EMT) or rigid steel conduit.
 - D. **Copper Tubing** – Nom 4 in. (102 mm) diam (or smaller) Type L (or heavier) copper tubing.
 - E. **Copper Pipe** – Nom 4 in. (102 mm) diam (or smaller) Regular (or heavier) copper pipe.
 - F. **Through Penetrating Product*** – **Flexible Metal Piping** – The following types of steel flexible metal gas piping may be used:
 - 1.) Nom 2 in. (51 mm) diam (or smaller) steel flexible metal gas piping. Plastic covering on piping may or may not be removed on both sides of floor or wall assembly.

System No. F-E-1029 *continued*

OMEGA FLEX INC

2.) Nom 1 in. (25 mm) diam (or smaller) steel flexible metal gas piping. Plastic covering on piping may or may not be removed on both sides of floor or wall assembly.

GASTITE, DIV OF TITEFLEX

3.) Nom 1 in. (25 mm) diam (or smaller) steel flexible metal gas piping. Plastic covering on piping may or may not be removed on both sides of floor or wall assembly.

WARD MFG LLC

3. **Fill, Void or Cavity Materials* – Caulk or Sealant** – Min 3/4 in. (19 mm) thickness of caulk applied within annulus, flush with top surface of floor or sole plate. Min 5/8 in. (16 mm) thickness of caulk applied within annulus, flush with bottom surface of ceiling or top plate. Min 1/4 in. (6 mm) diam bead of caulk applied at point contact locations at penetrant/floor or sole plate interface on top surface of floor or sole plate and at penetrant/ceiling or top plate interface.

3M COMPANY

3M FIRE PROTECTION PRODUCTS – IC 15WB+ Caulk, CP 25WB+ Caulk or FB-3000 WT Sealant

*Bearing the UL Classification Mark

Reprinted from the Online Certifications Directory with permission from UL
© 2012 UL LLC



Through Penetrations

Metallic Pipes

1000 Series

Wood Frame Floor/Ceiling

FE

System No. F-E-1030

March 16, 2012

ANSI/UL1479 (ASTM E814)

F Rating — 1 Hr
T Rating — 3/4 Hr

CAN/ULC S115

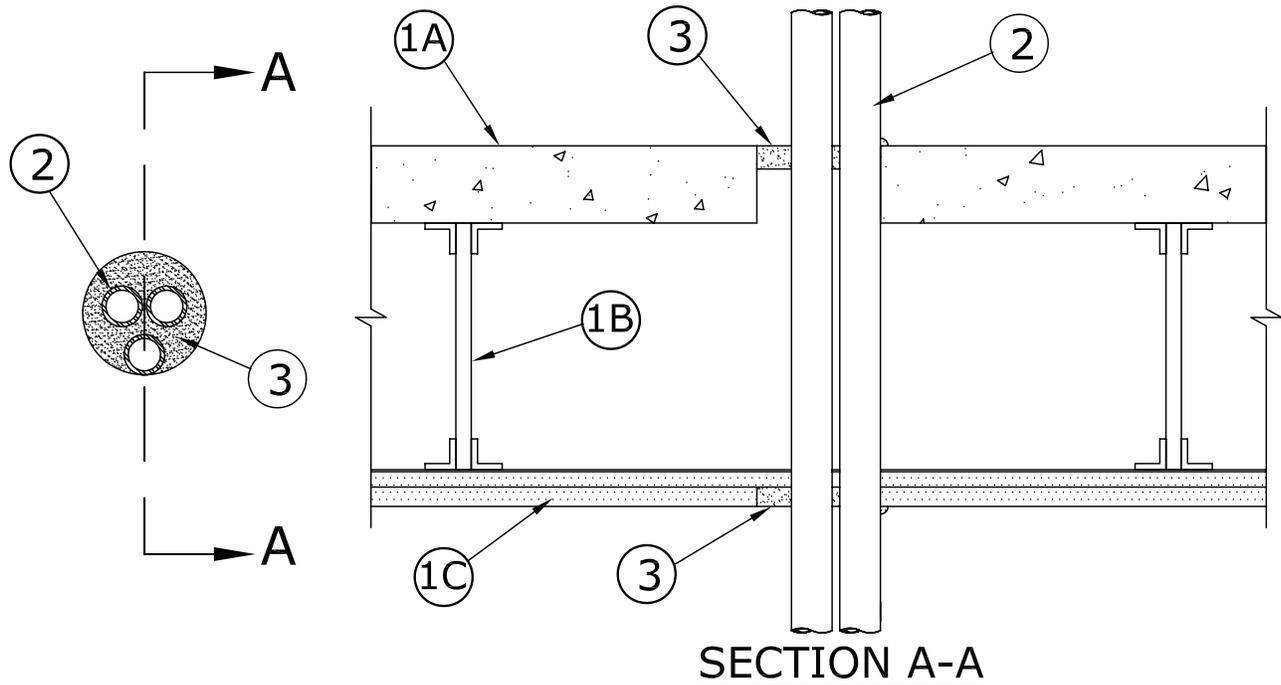
F Rating — 1 Hr
FT Rating — 3/4 Hr
FH Rating — 1 Hr
FTH Rating — 3/4 Hr

1. **Floor-Ceiling Assembly** – The minimum 1 hr fire rated concrete and steel joist Floor-Ceiling assembly shall be constructed of the materials and in the manner described in the individual G500 Series Design in the UL Fire Resistance Directory, as summarized below:
 - A. **Concrete Floor** – Normal weight or lightweight (100-150 pcf or 1600-2400 kg/m³) concrete over metal lath or steel deck as specified in the individual G500 Series Design. Max diam of floor opening is 5 in. (127 mm).
 - B. **Joists** – Steel joists or **Structural Steel Members*** as specified in the individual G500 Series Design.
 - C. **Gypsum Board*** – Min 5/8 in. (16 mm) thick, screw-attached to furring channels as specified in the individual G500 Series Design. Max diam of ceiling opening is 5 in. (127 mm).
- 1.1. **Chase Wall** – (Optional, Not Shown) – The through penetrant (Item 2) may be routed through a fire-rated single, double or staggered wood stud/gypsum board or steel stud/gypsum board chase wall having a fire rating consistent with that of the Floor-Ceiling assembly. The chase wall shall be constructed of the materials and in the manner specified in the individual U300, U400, V400 or W400 Series Wall and Partition Designs in the UL Fire Resistance Directory and shall include the following construction features:
 - A. **Studs** – Nom 2 by 4 in. (51 by 102 mm), nom 2 by 6 in. (51 by 152 mm) or double nom 2 by 4 in. (51 by 102 mm) lumber or min 3-1/2 in. (89 mm) steel studs.
 - B. **Sole Plate or Floor Runner** – Nom 2 by 4 in. (51 by 102 mm), nom 2 by 6 in. (51 by 152 mm) or parallel nom 2 by 4 in. (51 by 102 mm) lumber plates or steel floor runners sized to accommodate the steel studs, tightly butted. The steel floor runners may be discontinuous over opening, terminating at both sides of opening. Max diam of opening is 5 in. (127 mm).
 - C. **Top Plate or Ceiling Runner** – The double top plate shall consist of two nom 2 by 4 in. (51 by 102 mm), two nom 2 by 6 in. (51 by 152 mm) or two sets of parallel 2 by 4 in. (51 by 102 mm) lumber plates, tightly butted. The steel ceiling runners shall be sized to accommodate the steel studs, tightly butted. The steel ceiling runners may be discontinuous over opening, terminating at both sides of opening. Max diam of opening is 5 in. (127 mm).
 - D. **Gypsum Board*** – Thickness, type, number of layers and fasteners shall be as specified in individual Wall and Partition Design.
2. **Through Penetrants** – One or more metallic pipes, conduits, tubes or flexible metal pipes installed concentrically or eccentrically within opening. Annular space between penetrants and periphery of opening to be min 0 in (point contact) to max 1-1/2 in. (38 mm). Space between penetrants to be min 1/4 in. (6 mm) to max 2 in. (51 mm). Penetrants to be rigidly supported on both sides of floor-ceiling. The following types and sizes of penetrants may be used:
 - A. **Steel Pipe** – Nom 2 in. (51 mm) diam (or smaller) Schedule 5 (or heavier) steel pipe.
 - B. **Iron Pipe** – Nom 2 in. (51 mm) diam (or smaller) cast or ductile iron pipe.
 - C. **Conduit** – Nom 2 in. (51 mm) diam (or smaller) steel electrical metallic tubing (EMT) or nom 6 in. rigid steel conduit.
 - D. **Copper Tubing** – Nom 1-1/2 in. (38 mm) diam (or smaller) Type L (or heavier) copper tubing.
 - E. **Copper Pipe** – Nom 1-1/2 in. (38 mm) diam (or smaller) Regular (or heavier) copper pipe.
 - F. **Through Penetrating Product* – Flexible Metal Piping** – The following types of steel flexible metal gas piping may be used:
 - 1.) Nom 1 in. (25 mm) diam (or smaller) steel flexible metal gas piping. Plastic covering on piping may or may not be removed on both sides of floor or wall assembly.

System No. F-E-1030 *continued*

OMEGA FLEX INC

2.) Nom 1 in. (25 mm) diam (or smaller) steel flexible metal gas piping. Plastic covering on piping may or may not be removed on both sides of floor or wall assembly.

GASTITE, DIV OF TITEFLEX

3.) Nom 1 in. (25 mm) diam (or smaller) steel flexible metal gas piping. Plastic covering on piping may or may not be removed on both sides of floor or wall assembly.

WARD MFG LLC

3. **Fill, Void or Cavity Materials* – Caulk or Sealant** – Min 3/4 in. (19 mm) thickness of caulk applied within annulus, flush with top surface of floor or sole plate. Min 5/8 in. (16 mm) thickness of caulk applied within annulus, flush with bottom surface of ceiling or top plate. Min 1/4 in. (6 mm) diam bead of caulk applied at point contact locations at penetrant/floor or sole plate interface on top surface of floor or sole plate and at penetrant/ceiling or top plate interface.

3M COMPANY

3M FIRE PROTECTION PRODUCTS – IC 15WB+ Caulk, CP 25WB+ Caulk or FB-3000 WT Sealant

*Bearing the UL Classification Mark

Reprinted from the Online Certifications Directory with permission from UL
© 2012 UL LLC



System No. F-E-1031

March 16, 2012

ANSI/UL1479 (ASTM E814)
F Rating — 1 Hr
T Ratings — 0, 1/2 or 1 Hr (See Item 2)

CAN/ULC S115
F Rating — 1 Hr
FT Ratings — 0, 1/2 or 1 Hr (See Item 2)
FH Rating — 1 Hr
FTH Ratings — 0, 1/2 or 1 Hr (See Item 2)

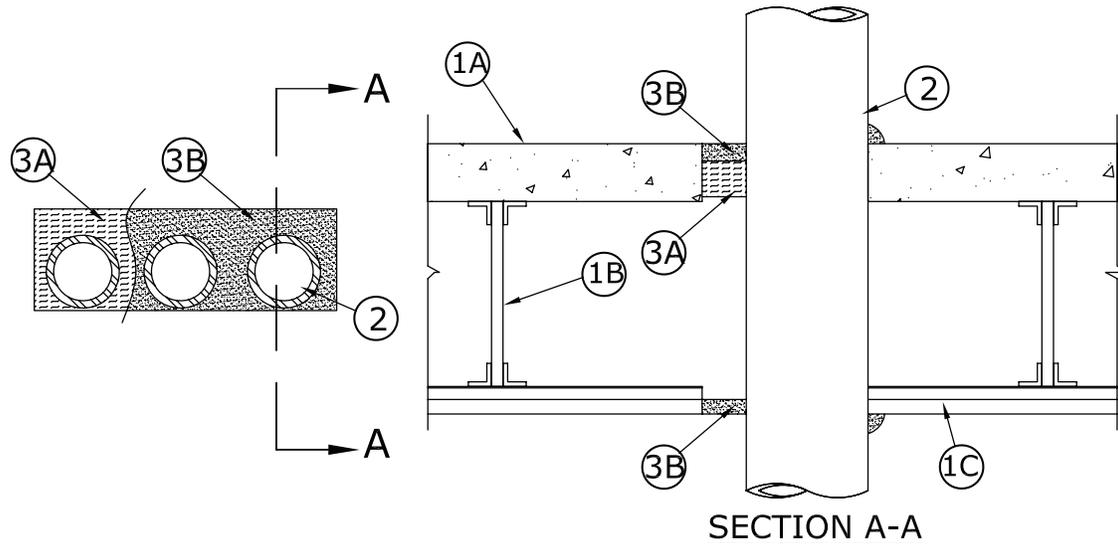

- Floor-Ceiling Assembly** – The minimum 1 hr fire rated concrete and steel joist Floor-Ceiling assembly shall be constructed of the materials and in the manner described in the individual G500 Series Design in the UL Fire Resistance Directory, as summarized below:
 - Concrete Floor** – Normal weight or lightweight (100-150 pcf or 1600-2400 kg/m³) concrete over metal lath or steel deck as specified in the individual G500 Series Design. Max area of floor opening is 288 in.² (1471 cm²) with max dimension of 48 in. (1.22 m). The longer dimension of rectangular opening to be parallel with the steel joist direction and opening to be centered between joists.
 - Joists** – Steel joists or **Structural Steel Members*** as specified in the individual G500 Series Design.
 - Gypsum Board*** – Min 5/8 in. (16 mm) thick, screw-attached to furring channels as specified in the individual G500 Series Design. Max area of ceiling opening is 288 in.² (1471 cm²) with max dimension of 48 in. (1.22 m). The longer dimension of rectangular opening to be parallel with the steel joist direction and opening to be centered between joists.
- Through Penetrants** – One or more metallic pipes, conduits or tubes installed concentrically or eccentrically within opening. Annular space between penetrants and periphery of opening to be min 0 in. (0 mm) (point contact) to max 2 in. (51 mm). Space between penetrants to be min 1/4 in. (6 mm) to max 2 in. (51 mm). Penetrants to be rigidly supported on both sides of floor-ceiling. The following types and sizes of penetrants may be used:
 - Steel Pipe** – Nom 4 in. (102 mm) diam (or smaller) Schedule 5 (or heavier) steel pipe.
 - Iron Pipe** – Nom 4 in. (102) diam (or smaller) cast or ductile iron pipe.
 - Conduit** – Nom 4 in. (102 mm) diam (or smaller) steel electrical metallic tubing (EMT) or nom 4 in. rigid steel conduit.
 - Copper Tubing** – Max three lengths of Nom 4 in. (102mm) diam (or smaller) Type L (or heavier) copper tubing.
 - Copper Pipe** – Max three lengths of Nom 4 in. (102 mm) diam (or smaller) Regular (or heavier) copper pipe.

The T, FT and FTH Ratings of the firestop system are dependent upon the max diam and type of through penetrant used within the firestop system as shown in the table below:

| Type of Through Penetrant | Max Diam. In. (mm) | T, FT and FTH Ratings, Hr |
|-------------------------------------|--------------------|---------------------------|
| Copper tube, copper pipe | 4 (102) | 0 |
| Conduit, steel pipe, EMT, iron pipe | 4 (102) | 1/2 |
| Conduit, steel pipe, EMT, iron pipe | 2 (51) | 1 |

- Firestop System** – The details of the firestop system shall be as follows:
 - Packing Material** – (Optional) – Min 1 in. (25 mm) thickness of min 4 pcf (64 kg/m³) mineral wool batt insulation firmly packed into opening as a permanent form. Packing material to be recessed from top surface of floor as required to accommodate the required thickness of fill material.
 - Fill, Void or Cavity Materials* – Caulk or Sealant** – Min 3/4 in. (19 mm) thickness of caulk applied within annulus, flush with top surface of floor. Min 5/8 in. (16 mm) thickness of caulk applied within annulus, flush with bottom surface of ceiling. Min 1/4 in. (6 mm) diam bead of caulk applied at point contact locations at penetrant/floor on top surface of floor and at penetrant/ceiling interface.

3M COMPANY

3M FIRE PROTECTION PRODUCTS – IC 15WB+ Caulk, CP 25WB+ Caulk or FB-3000 WT Sealant

*Bearing the UL Classification Mark

Reprinted from the Online Certifications Directory with permission from UL

© 2012 UL LLC



Non-Metallic Pipes

CAJ

Concrete floors with a minimum thickness less than or equal to 5 inches (127 mm)
Concrete or masonry walls with a minimum thickness less than or equal to 8 inches (203 mm)

CBJ

Concrete floors with a minimum thickness greater than 5 inches (127 mm)
Concrete or masonry walls with a minimum thickness less than or equal to 8 inches (203 mm)

FA

Concrete floors/Steel decks
Concrete or masonry walls with a minimum thickness less than or equal to 8 inches (203 mm)

FB

Concrete floors/Steel decks
Concrete floors with a minimum thickness greater than 5 inches (127 mm)

FC

Floor assemblies
Framed floors

FE

Truss floor assemblies

WJ

Floor assemblies
Concrete or masonry walls with a minimum thickness less than or equal to 8 inches (203 mm)

WL

Wall assemblies
Framed walls

WK

Wall assemblies
Concrete or masonry walls with a thickness greater than 8 inches (203 mm)

Non-Metallic Pipes • Concrete

| 3M UL Systems | "F" Rating | 3M Product | Through Penetrant Details |
|---------------|------------|--|--|
| C-AJ-2001 | 2 | 3M™ Fire Barrier Sealant CP 25WB+ 3M™ Fire Barrier Sealant IC 15WB+ 3M™ Fire Barrier Wrap Strips FS-195+ 3M™ Fire Barrier Ultra Plastic Pipe Device 3M™ Fire Barrier Moldable Putty Stix MP+ 3M™ Fire Barrier RC-1 Restricting Collar 3M™ Fire Barrier Water Tight Sealant 3000 WT | Single nonmetallic pipe penetrating a min. 4.5 in. concrete floor or wall utilizing FS 195+ Wrap Strips and RC-1 Restricting Collar(s) or a Plastic Pipe Device. Max. 6 in. nonmetallic pipe. |
| C-AJ-2002 | 2 | 3M™ Fire Barrier Sealant CP 25WB+ 3M™ Fire Barrier Sealant IC 15WB+ 3M™ Fire Barrier Wrap Strips FS-195+ 3M™ Fire Barrier Water Tight Sealant 3000 WT | Single nonmetallic pipe penetrating a min. 4.5 in. concrete floor or wall with access to the top side only. Utilizing a FS 195+ Wrap Strips recessed below the floor surface with steel support clips and RC-1 Restricting Collar. |
| C-AJ-2003 | 2, 3 | 3M™ Fire Barrier Sealant CP 25WB+ 3M™ Fire Barrier Sealant IC 15WB+ 3M™ Fire Barrier Composite Sheet CS-195+ 3M™ Fire Barrier Wrap Strips FS-195+ 3M™ Fire Barrier RC-1 Restricting Collar 3M™ Fire Barrier Water Tight Sealant 3000 WT 3M™ Fire Barrier Wrap Ultra GS 3M™ Expanrol™ Flexible Intumescent Strip E-FIS | Single max. 2 in. PVC or RNC penetrating a max. 64 square inch opening in a concrete floor or wall utilizing FS 195+ Wrap Strips and CS 195+ Composite Sheet. |
| C-AJ-2005 | 1, 2, 3 | 3M™ Fire Barrier Sealant CP 25WB+ 3M™ Fire Barrier Sealant IC 15WB+ 3M™ Fire Barrier Wrap Strips FS-195+ 3M™ Fire Barrier RC-1 Restricting Collar 3M™ Fire Barrier Water Tight Sealant 3000 WT | Single max. 10 in. PVC pipe penetrating a concrete floor or wall utilizing FS 195+ Wrap Strips and RC-1 Restricting Collar(s). |
| C-AJ-2006 | 2, 3 | 3M™ Fire Barrier Sealant CP 25WB+ 3M™ Fire Barrier Wrap Strips FS-195+ 3M™ Fire Barrier Water Tight Sealant 3000 WT | Single max. 6 in. diameter glass pipe penetrating a concrete floor or wall. |
| C-AJ-2019 | 1, 2 | 3M™ Fire Barrier Silicone Sealant 2000+ 3M™ Fire Barrier Water Tight Sealant 1000 NS 3M™ Fire Barrier Water Tight Sealant 1003 SL | Single max. 4 in. diameter glass pipe penetrating a concrete floor or wall. |
| C-AJ-2027 | 2, 3 | 3M™ Fire Barrier Sealant CP 25WB+ 3M™ Fire Barrier Wrap Strips FS-195+ 3M™ Fire Barrier Water Tight Sealant 3000 WT | Single max. 1 inch Electrical NonMetallic Tubing (ENT) penetrating a min. 4.5 in. thick concrete floor or wall. |
| C-AJ-2028 | 2 | 3M™ Fire Barrier Wrap Strips FS-195+ 3M™ Fire Barrier Moldable Putty Stix MP+ | Single max. 2 inch Electrical NonMetallic Tubing (ENT) penetrating a min. 4.5 in. thick concrete floor or wall. |
| C-AJ-2029 | 2 | 3M™ Fire Barrier Wrap Strips FS-195+ 3M™ Fire Barrier Ultra Plastic Pipe Device 3M™ Fire Barrier Moldable Putty Stix MP+ 3M™ Fire Barrier RC-1 Restricting Collar | Multiple max. 2 in. Electrical Nonmetallic Tubing penetrating the same max. 5 in. diameter opening in a concrete floor or wall. |
| C-AJ-2030 | 2 | 3M™ Fire Barrier Sealant CP 25WB+ 3M™ Fire Barrier Sealant IC 15WB+ 3M™ Fire Barrier Wrap Strips FS-195+ 3M™ Fire Barrier Moldable Putty Stix MP+ 3M™ Fire Barrier Water Tight Sealant 3000 WT 3M™ Fire Barrier Composite Sheet CS-195+ | Single or multiple max. 2 in. Electrical Nonmetallic Tubing penetrating a max. 240 square inch opening in a concrete floor or wall utilizing CS 195+ Composite Sheet and FS 195+ Wrap Strip. |
| C-AJ-2044 | 2, 3 | 3M™ Fire Barrier Sealant CP 25WB+ 3M™ Fire Barrier Wrap Strips FS-195+ 3M™ Fire Barrier Water Tight Sealant 3000 WT | Single or multiple max. 1-1/2 in. PVC pipes penetrating a max. 45 square inch opening in a concrete floor or wall. |
| C-AJ-2117 | 2, 3 | 3M™ Fire Barrier Sealant CP 25WB+ 3M™ Fire Barrier Sealant IC 15WB+ 3M™ Fire Barrier Sealant FD 150+ 3M™ Fire Barrier Wrap Strips FS-195+ 3M™ Fire Barrier Ultra Plastic Pipe Device 3M™ Fire Barrier Moldable Putty Stix MP+ 3M™ Fire Barrier RC-1 Restricting Collar 3M™ Fire Barrier Water Tight Sealant 3000 WT | Single max. 4 in. PVC or CPVC pipe penetrating a concrete floor or wall utilizing FS 195+ Wrap Strips within an RC-1 Restricting Collar or a Plastic Pipe Device. |
| C-AJ-2133 | 2 | 3M™ Fire Barrier Sealant CP 25WB+ 3M™ Fire Barrier Sealant IC 15WB+ 3M™ Fire Barrier Sealant FD 150+ 3M™ Fire Barrier Wrap Strips FS-195+ 3M™ Fire Barrier Moldable Putty Stix MP+ 3M™ Fire Barrier RC-1 Restricting Collar 3M™ Fire Barrier Water Tight Sealant 3000 WT | Double wall polypropylene or PVDF pipe penetrating a sleeved opening in a concrete floor or wall. |

Non-Metallic Pipes • Concrete

Through Penetrations • Non-Metallic Pipes • Concrete

| 3M UL Systems | "F" Rating | 3M Product | Through Penetrant Details |
|------------------|------------|--|--|
| C-AJ-2143 | 2 | 3M™ Fire Barrier Sealant CP 25WB+ | Single max. 4 in. PVC, RNC, or CPVC pipe with a pipe coupling flush with one surface of a concrete floor or wall utilizing FS 195+ Wrap Strips within an RC-1 Restricting Collar. |
| | | 3M™ Fire Barrier Sealant IC 15WB+ | |
| | | 3M™ Fire Barrier Sealant FD 150+ | |
| | | 3M™ Fire Barrier Wrap Strips FS-195+ | |
| | | 3M™ Fire Barrier Moldable Putty Stix MP+ | |
| | | 3M™ Fire Barrier RC-1 Restricting Collar | |
| C-AJ-2144 | 2 | 3M™ Fire Barrier Sealant CP 25WB+ | Single max. 6 in. glass pipe penetrating a concrete floor or wall utilizing CP 25WB+ Sealant. |
| C-AJ-2161 | 2 | 3M™ Fire Barrier Sealant CP 25WB+ 3M™ Fire Barrier Water Tight Sealant 3000 WT | Single max. 2 in. PVC, RNC, or CPVC pipe penetrating a min. 4-1/2 in. thick concrete floor or wall utilizing CP 25WB+ Sealant or FB 3000WT Silicone Sealant. |
| C-AJ-2189 | 2 | 3M™ Fire Barrier Sealant CP 25WB+ | Single max. 4 in. nonmetallic pipe penetrating a min. 4.5 in. concrete floor or wall with the pipe tightly abutting an adjacent substrate. FS 195+ Wrap Strips are installed within an RC-1 Retaining Collar, abutting the adjacent substrate. |
| | | 3M™ Fire Barrier Sealant IC 15WB+ | |
| | | 3M™ Fire Barrier Sealant FD 150+ | |
| | | 3M™ Fire Barrier Wrap Strips FS-195+ | |
| | | 3M™ Fire Barrier Moldable Putty Stix MP+ | |
| | | 3M™ Fire Barrier RC-1 Restricting Collar | |
| C-AJ-2204 | 2 | 3M™ Fire Barrier Silicone Sealant 2000+ | Single max. 1 in. PEX/Al/PEX or PE/Al/PE pipe penetrating a concrete floor or wall. |
| C-AJ-2213 | 2 | 3M™ Fire Barrier Sealant IC 15WB+ 3M™ Fire Barrier Sealant CP 25WB+ 3M™ Fire Barrier Water Tight Sealant 3000 WT | Single max. 1 in. PEX pipe penetrating a min. 4-1/2 in. thick concrete floor or wall. |
| C-AJ-2214 | 2, 3 | 3M™ Fire Barrier Sealant CP 25WB+ | Single max. 6 in. nonmetallic pipe penetrating a min. 4.5 in. thick concrete floor or wall utilizing Ultra GS Wrap Strips. Steel sleeve optional. Max. 6 in. PVC, CPVC, RNC, ABS, or FRPP pipe. Max. 4 in. PVDF. |
| | | 3M™ Fire Barrier Sealant IC 15WB+ | |
| | | 3M™ Fire Barrier Sealant FD 150+ | |
| | | 3M™ Fire Barrier Moldable Putty Stix MP+ | |
| | | 3M™ Fire Barrier Wrap Ultra GS | |
| | | 3M™ Fire Barrier RC-1 Restricting Collar | |
| C-AJ-2216 | 2, 3 | 3M™ Fire Barrier Water Tight Sealant 1000 NS | Single max. 4 in. nonmetallic pipe penetrating a minimum 2-1/2 in. thick concrete floor or wall. Utilizing Ultra GS Wrap Strips within an RC-1 Restricting Collar. |
| | | 3M™ Fire Barrier Sealant CP 25WB+ | |
| | | 3M™ Fire Barrier Sealant IC 15WB+ | |
| | | 3M™ Fire Barrier Sealant FD 150+ | |
| | | 3M™ Fire Barrier Moldable Putty Stix MP+ | |
| | | 3M™ Fire Barrier Wrap Ultra GS | |
| C-AJ-2226 | 2, 3 | 3M™ Fire Barrier Water Tight Sealant 1000 NS | Single max. 4 in. nonmetallic pipe penetrating a minimum 4-1/2 in. thick concrete floor or wall. Optional steel sleeve. Utilizing a Plastic Pipe Device. |
| | | 3M™ Fire Barrier Sealant CP 25WB+ | |
| | | 3M™ Fire Barrier Sealant IC 15WB+ | |
| | | 3M™ Fire Barrier Sealant FD 150+ | |
| | | 3M™ Fire Barrier Moldable Putty Stix MP+ | |
| | | 3M™ Fire Barrier Ultra Plastic Pipe Device | |
| C-AJ-2227 | 2 | 3M™ Fire Barrier Water Tight Sealant 1000 NS | Single max. 4 in. nonmetallic pipe penetrating a minimum 2-1/2 in. thick concrete floor or wall. Utilizing a Plastic Pipe Device. |
| | | 3M™ Fire Barrier Sealant CP 25WB+ | |
| | | 3M™ Fire Barrier Sealant IC 15WB+ | |
| | | 3M™ Fire Barrier Sealant FD 150+ | |
| | | 3M™ Fire Barrier Moldable Putty Stix MP+ | |
| | | 3M™ Fire Barrier Ultra Plastic Pipe Device | |
| C-AJ-2228 | 2, 3 | 3M™ Fire Barrier Water Tight Sealant 1000 NS | Single max. 3 in. nonmetallic pipe penetrating a min. 4.5 in. thick concrete floor or wall. Steel sleeve optional. Utilizing Ultra GS Wrap Strip(s) and sealant installed within the opening. |
| | | 3M™ Fire Barrier Sealant CP 25WB+ | |
| | | 3M™ Fire Barrier Sealant IC 15WB+ | |
| | | 3M™ Fire Barrier Sealant FD 150+ | |
| | | 3M™ Fire Barrier Wrap Ultra GS | |
| | | 3M™ Fire Barrier Water Tight Sealant 3000 WT | |
| C-AJ-2241 | 1 | 3M™ Fire Barrier Water Tight Sealant 1000 NS | Single max. 4 in. nonmetallic pipe penetrating a minimum 2-1/2 in. thick concrete floor or wall. Utilizing Ultra GS Wrap Strips within an RC-1 Restricting Collar. |
| | | 3M™ Fire Barrier Sealant CP 25WB+ | |
| | | 3M™ Fire Barrier Sealant IC 15WB+ | |
| | | 3M™ Fire Barrier Sealant FD 150+ | |
| | | 3M™ Fire Barrier Wrap Ultra GS | |
| | | 3M™ Fire Barrier RC-1 Restricting Collar | |
| | | 3M™ Fire Barrier Water Tight Sealant 3000 WT | |

Non-Metallic Pipes • Concrete

| 3M UL Systems | "F" Rating | 3M Product | Through Penetrant Details |
|---------------|------------|--|--|
| C-AJ-2242 | 2 | 3M™ Fire Barrier Sealant IC 15WB+ | Single max. 4 in. nonmetallic pipe penetrating a minimum 4-1/2 in. thick concrete floor or wall. Optional steel sleeve. Utilizing Ultra GS Wrap Strips within an RC-1 Restricting Collar or a Plastic Pipe Device. |
| | | 3M™ Fire Barrier Sealant CP 25WB+ | |
| | | 3M™ Fire Barrier Water Tight Sealant 3000 WT | |
| | | 3M™ Fire Barrier Sealant FD 150+ | |
| | | 3M™ Fire Barrier Water Tight Sealant 1000 NS | |
| | | 3M™ Fire Barrier Wrap Ultra GS | |
| C-AJ-2255 | 2 | 3M™ Fire Barrier Sealant CP 25WB+ | Single max. 4 in. PVC or CPVC pipe penetrating a min. 4.5 in. thick concrete floor or wall utilizing Ultra GS Wrap Strips within an RC-1 Restricting Collar installed within the through opening. |
| | | 3M™ Fire Barrier Sealant IC 15WB+ | |
| | | 3M™ Fire Barrier Water Tight Sealant 1000 NS | |
| | | 3M™ Fire Barrier Wrap Ultra GS | |
| | | 3M™ Fire Barrier RC-1 Restricting Collar | |
| | | 3M™ Fire Barrier Water Tight Sealant 3000 WT | |
| C-AJ-2256 | 2 | 3M™ Fire Barrier Sealant CP 25WB+ | Single max. 3 in. PVC or CPVC pipe penetrating a min. 4.5 in. thick concrete floor or wall utilizing Ultra GS Wrap Strips installed within the through opening. |
| | | 3M™ Fire Barrier Sealant IC 15WB+ | |
| | | 3M™ Fire Barrier Wrap Ultra GS | |
| | | 3M™ Fire Barrier Water Tight Sealant 3000 WT | |
| C-AJ-2268 | 2 | 3M™ Fire Barrier Sealant CP 25WB+ | Single max. 4 in. nonmetallic pipe penetrating a min. 4.5 in. concrete floor or wall with a pipe coupling located flush with one floor or wall surface. |
| | | 3M™ Fire Barrier Moldable Putty Stix MP+ | |
| | | 3M™ Fire Barrier Wrap Ultra GS | |
| | | 3M™ Fire Barrier RC-1 Restricting Collar | |
| | | 3M™ Fire Barrier Water Tight Sealant 3000 WT | |
| C-AJ-2278 | 2 | 3M™ Fire Barrier Water Tight Sealant 1003 SL | Single max. 3 in. nonmetallic pipe penetrating a min. 4.5 in. thick concrete floor or wall utilizing Ultra GS wrap strip and sealant within the opening. |
| | | 3M™ Fire Barrier Wrap Ultra GS | |
| | | 3M™ Fire Barrier Water Tight Sealant 3000 WT | |
| C-AJ-2299 | 2 | 3M™ Fire Barrier Sealant CP 25WB+ | Single max. 2 in. nonmetallic pipe penetrating a min. 4.5 in. thick concrete floor or wall utilizing packing material and sealant. |
| | | 3M™ Fire Barrier Sealant IC 15WB+ | |
| | | 3M™ Fire Barrier Sealant FD 150+ | |
| | | 3M™ Fire Barrier Water Tight Sealant 3000 WT | |
| | | 3M™ Fire Barrier Packing Material PM4 | |
| C-AJ-2312 | 2 | 3M™ Fire Barrier Wrap Ultra GS | Single max. 4 in. nonmetallic pipe penetrating a max. 9 in. diameter opening in a min. 4.5 in. thick concrete floor or wall. Utilizing packing material, steel cover plate(s), and Ultra GS Wrap Strips within an RC-1 Restricting Collar. |
| | | 3M™ Fire Barrier RC-1 Restricting Collar | |
| C-AJ-2313 | 2 | 3M™ Fire Barrier Wrap Ultra GS | Two nonmetallic pipes, one max. 4 in. and one max. 2 in., penetrating the same max. 10.5 in. diameter opening in a min. 4.5 in. thick concrete floor or wall. |
| | | 3M™ Fire Barrier RC-1 Restricting Collar | |
| C-AJ-2377 | 2 | 3M™ Fire Barrier Sealant IC 15WB+ | Single 3 in. diameter closed process PVC or CPVC pipe penetrating a min. 4.5 in. thick concrete floor or wall utilizing packing material and sealant only. |
| | | 3M™ Fire Barrier Sealant CP 25WB+ | |
| | | 3M™ Fire Barrier Water Tight Sealant 3000 WT | |
| C-AJ-2378 | 2 | 3M™ Fire Barrier Sealant IC 15WB+ | Multiple max. 1.5 in. nonmetallic pipes penetrating the same max. 5 in. diameter opening in a min. 4.5 in. thick concrete floor or wall. Utilizing packing material and sealant. |
| | | 3M™ Fire Barrier Sealant CP 25WB+ | |
| | | 3M™ Fire Barrier Water Tight Sealant 3000 WT | |
| C-AJ-2510 | 2 | 3M™ Fire Barrier Water Tight Sealant 3000 WT | Single max. 3 in. nonmetallic pipe penetrating a min. 4.5 in. thick concrete floor or wall utilizing FB 3000WT Silicone Sealant. |
| C-AJ-2536 | 2 | 3M™ Fire Barrier Pass-Through Products | Multiple max. 2 in. nonmetallic pipes penetrating a min. 2.5 in. thick concrete floor or wall utilizing Fire Barrier Pass Through Device(s). |
| | | 3M™ Fire Barrier Water Tight Sealant 3000 WT | |
| | | 3M™ Fire Barrier Sealant CP 25WB+ | |
| | | 3M™ Fire Barrier Sealant IC 15WB+ | |
| | | 3M™ Fire Barrier Moldable Putty Stix MP+ | |
| C-AJ-2626 | 1, 2 | 3M™ Fire Barrier Water Tight Sealant 3000 WT | Single max. 2 in. nonmetallic pipe penetrating a 1 or 2 hour rated concrete floor utilizing FB 3000WT Silicone Sealant. Steel sleeve optional. Both side access required. |
| C-AJ-2627 | 2 | 3M™ Fire Barrier Water Tight Sealant 3000 WT | Single max. 2 in. nonmetallic pipe penetrating a 2 hour rated concrete floor utilizing FB 3000WT Silicone Sealant. Steel sleeve optional. |
| C-AJ-2637 | 2, 3 | 3M™ Fire Barrier Sealant IC 15WB+ | Single max. 4 in. nonmetallic pipe penetrating a minimum 4.5 in. thick concrete floor or wall. Utilizing sealant and Tuck-In Wrap Strip. |
| | | 3M™ Fire Barrier Sealant CP 25WB+ | |
| | | 3M™ Fire Barrier Water Tight Sealant 3000 WT | |
| | | 3M™ Fire Barrier Tuck-In Wrap Strips | |
| | | 3M™ Aluminum Foil Tape 425 | |
| C-AJ-2640 | 2 | 3M™ Fire Barrier Sealant IC 15WB+ | Single max. 2 in. schedule 80 PVC pipe penetrating a min. 2.5 in. thick concrete floor or wall. Utilizing packing material and sealant. |
| | | 3M™ Fire Barrier Sealant CP 25WB+ | |
| | | 3M™ Fire Barrier Water Tight Sealant 3000 WT | |

Non-Metallic Pipes • Concrete

Through Penetrations • Non-Metallic Pipes • Concrete

| 3M UL Systems | "F" Rating | 3M Product | Through Penetrant Details |
|---------------|------------|---|---|
| C-AJ-2643 | 2,3 | 3M™ Fire Barrier Sealant IC 15WB+ 3M™ Fire Barrier Sealant CP 25WB+ 3M™ Fire Barrier Water Tight Sealant 3000 WT 3M™ Fire Barrier Tuck-In Wrap Strips 3M™ Aluminum Foil Tape 425 | Single max. 4 in. nonmetallic pipe penetrating a minimum 2-1/2 in. thick concrete floor or wall. Utilizing sealant and Tuck-In Wrap Strip. |
| C-AJ-2648 | 2 | 3M™ Fire Barrier Tuck-In Wrap Strips 3M™ Fire Barrier Sealant CP 25WB+ 3M™ Fire Barrier Sealant IC 15WB+ 3M™ Fire Barrier Water Tight Sealant 3000 WT | Single max. 6 in. nonmetallic pipe penetrating a minimum 4.5 in. thick concrete floor or wall. Top side access, utilizing Tuck-In Wrap Strips and sealant. |
| C-AJ-2668 | 2 | 3M™ Fire Barrier Tuck-In Wrap Strips 3M™ Fire Barrier Sealant CP 25WB+ 3M™ Fire Barrier Sealant IC 15WB+ 3M™ Fire Barrier Water Tight Sealant 3000 WT 3M™ Aluminum Foil Tape 425 | Single max. 8 in. PVC or CPVC, or max. 6 in. RNC, penetrating a minimum 4.5 in. thick concrete floor or wall. Top side access utilizing Tuck-In Wrap Strips within an RC-1 Restricting Collar. |
| C-AJ-2685 | 2 | 3M™ Fire Barrier Sealant IC 15WB+ | Single 4 in. glass pipe penetrating a minimum 2.5 in. thick concrete floor or wall. Utilizing packing material and IC 15WB+ Sealant. |
| C-AJ-2686 | 2 | 3M™ Fire Barrier Sealant IC 15WB+ 3M™ Fire Barrier Sealant CP 25WB+ 3M™ Fire Barrier Water Tight Sealant 3000 WT | Single 4 in. glass pipe penetrating a minimum 2.5 in. thick concrete floor or wall. Utilizing packing material and sealant. |
| C-AJ-2698 | 2 | 3M™ Fire Barrier Water Tight Sealant 3000 WT | Single max. 3 in. PEX pipe penetrating a 2 hour rated concrete floor or wall utilizing FB 3000WT Silicone Sealant. |
| C-AJ-2699 | 2 | 3M™ Fire Barrier Water Tight Sealant 3000 WT | Multiple max. 2 in. diameter ENT penetrating the same sleeved opening in a 2 hour rated concrete floor or wall. Utilizing packing material and FB 3000WT Silicone Sealant. |
| C-AJ-2731 | 2, 3 | 3M™ Fire Barrier Sealant IC 15WB+ 3M™ Fire Barrier Sealant CP 25WB+ 3M™ Fire Barrier Water Tight Sealant 3000 WT | Single max. 2 in. CPVC or PVC pipe penetrating a min. 4.5 in. thick concrete floor or wall. Bottom side access utilizing packing material and sealant. |
| C-AJ-2738 | 2 | 3M™ Fire Barrier Sealant IC 15WB+ 3M™ Fire Barrier Sealant CP 25WB+ 3M™ Fire Barrier Water Tight Sealant 3000 WT | Single max. 2 in. nonmetallic pipe penetrating a minimum 4.5 in. thick concrete floor or wall. Utilizing packing material and sealant. Sleeve optional. |
| C-AJ-2746 | 2, 3 | 3M™ Fire Barrier Sealant IC 15WB+ 3M™ Fire Barrier Sealant CP 25WB+ 3M™ Fire Barrier Water Tight Sealant 3000 WT 3M™ Fire Barrier Tuck-In Wrap Strips | Single max. 4 in. polypropylene (PP) pipe penetrating a minimum 4-1/2 in. thick concrete floor or wall assembly. Utilizing a Tuck-In Wrap Strip, packing material, and sealant. |
| C-AJ-2758 | 2 | 3M™ Fire Barrier Wrap Ultra GS 3M™ Fire Barrier Sealant IC 15WB+ 3M™ Fire Barrier Sealant CP 25WB+ 3M™ Fire Barrier Water Tight Sealant 3000 WT 3M™ Fire Barrier RC-1 Restricting Collar | Single max. 6 in. HDPE pipe penetrating a minimum 2.5 in. thick concrete floor or wall. Utilizing sealant and Ultra GS Wrap Strips with two RC-1 Restricting Collars. |
| C-AJ-2759 | 2 | 3M™ Fire Barrier Wrap Ultra GS 3M™ Fire Barrier Sealant CP 25WB+ 3M™ Fire Barrier Water Tight Sealant 3000 WT 3M™ Fire Barrier RC-1 Restricting Collar | Single max. 4 in. HDPE pipe penetrating a minimum 4.5 in. thick concrete floor or wall. Utilizing Ultra GS Wrap Strips, packing material, and sealant within the opening. |
| C-BJ-2002 | 4 | 3M™ Fire Barrier Sealant CP 25WB+ 3M™ Fire Barrier Sealant IC 15WB+ 3M™ Fire Barrier Moldable Putty Stix MP+ 3M™ Fire Barrier Ultra Plastic Pipe Device 3M™ Fire Barrier Water Tight Sealant 3000 WT | Single max. 4 in. nonmetallic pipe penetrating a 4 hour, min. 5.5 in. thick concrete floor or wall. Utilizing a Plastic Pipe Device. |
| C-BJ-2007 | 2 | 3M™ Fire Barrier Sealant CP 25WB+ 3M™ Fire Barrier Sealant IC 15WB+ 3M™ Fire Barrier Water Tight Sealant 3000 WT | Single max. 2 in. nonmetallic pipe penetrating a 4 hour, min. 6 in. thick concrete floor or wall. Hollow core floor option. Utilizing mineral wool and sealant. |
| F-A-2002 | 1, 2 | 3M™ Fire Barrier Sealant CP 25WB+ 3M™ Fire Barrier Composite Sheet CS-195+ 3M™ Fire Barrier Wrap Strips FS-195+ 3M™ Fire Barrier Ultra Plastic Pipe Device 3M™ Fire Barrier Moldable Putty Stix MP+ 3M™ Fire Barrier RC-1 Restricting Collar 3M™ Fire Barrier Water Tight Sealant 3000 WT | Single max. 8 in. nonmetallic pipe penetrating a concrete floor over fluted steel deck assembly. Utilizing CS 195+ Composite Sheet, FS 195+ Wrap Strips within an RC-1 Retaining Collar, and sealant. |
| F-A-2021 | 1, 2 | 3M™ Fire Barrier Composite Sheet CS-195+ 3M™ Fire Barrier Wrap Strips FS-195+ 3M™ Fire Barrier Moldable Putty Pads MPP+ 3M™ Fire Barrier Moldable Putty Stix MP+ 3M™ Fire Barrier RC-1 Restricting Collar | Single 6 in. FRPP penetrating a concrete floor over fluted steel deck assembly. Utilizing CS 195+ Composite Sheet, FS 195+ Wrap Strips within an RC-1 Retaining Collar, and Putty. |

Non-Metallic Pipes • Concrete

| 3M UL Systems | "F" Rating | 3M Product | Through Penetrant Details |
|---------------|------------|--|---|
| F-A-2027 | 1, 2 | 3M™ Fire Barrier Sealant CP 25WB+ 3M™ Fire Barrier Sealant IC 15WB+ 3M™ Fire Barrier Wrap Strips FS-195+ 3M™ Fire Barrier RC-1 Restricting Collar 3M™ Fire Barrier Water Tight Sealant 3000 WT | Single max. 4 in. nonmetallic pipe penetrating a concrete floor over fluted steel deck. Utilizing a steel cover plate, FS 195+ Wrap Strips within an RC-1 Retaining Collar, and sealant. |
| F-A-2033 | 1, 2 | 3M™ Fire Barrier Water Tight Sealant 1000 NS 3M™ Fire Barrier Water Tight Sealant 1003 SL 3M™ Fire Barrier Sealant CP 25WB+ 3M™ Fire Barrier Sealant IC 15WB+ 3M™ Fire Barrier Wrap Ultra GS 3M™ Fire Barrier RC-1 Restricting Collar 3M™ Fire Barrier Ultra Plastic Pipe Device 3M™ Fire Barrier Water Tight Sealant 3000 WT | Single max. 4 in. nonmetallic pipe penetrating a concrete floor over fluted steel deck. Utilizing a steel cover plate, Ultra GS Wrap Strips within an RC-1 Retaining Collar or Plastic Pipe Device, and sealant. |
| F-A-2041 | 1, 2 | 3M™ Fire Barrier Water Tight Sealant 1000 NS 3M™ Fire Barrier Water Tight Sealant 1003 SL 3M™ Fire Barrier Sealant CP 25WB+ 3M™ Fire Barrier Wrap Ultra GS 3M™ Fire Barrier RC-1 Restricting Collar 3M™ Fire Barrier Water Tight Sealant 3000 WT | Single max. 4 in. nonmetallic pipe penetrating a concrete floor slab with top side access. Utilizing Ultra GS Wrap Strips within an RC-1 Retaining Collar, hanger straps, packing material, and sealant. |
| F-A-2045 | 1, 2 | 3M™ Fire Barrier Water Tight Sealant 1000 NS 3M™ Fire Barrier Water Tight Sealant 1003 SL 3M™ Fire Barrier Sealant CP 25WB+ 3M™ Fire Barrier Sealant IC 15WB+ 3M™ Fire Barrier RC-1 Restricting Collar 3M™ Fire Barrier Water Tight Sealant 3000 WT 3M™ Fire Barrier Wrap Ultra GS | Single max. 4 in. nonmetallic pipe penetrating a concrete floor over fluted steel deck with top side access. Steel sleeve optional. Utilizing Ultra GS Wrap Strips within an RC-1 Retaining Collar, hanger straps, packing material, and sealant. |
| F-A-2055 | 1, 2 | 3M™ Fire Barrier Sealant CP 25WB+ 3M™ Fire Barrier Sealant IC 15WB+ 3M™ Fire Barrier Water Tight Sealant 3000 WT 3M™ Fire Barrier Wrap Ultra GS | Single max. 6 in. nonmetallic pipe penetrating a concrete floor over fluted steel deck. Utilizing a steel cover plate, Ultra GS Wrap Strips within an RC-1 Retaining Collar or Plastic Pipe Device, and sealant. |
| F-A-2097 | 1, 2 | 3M™ Fire Barrier Cast-In Devices for Plastic Pipes 3M™ Fire Barrier Water Tight Sealant 1000 NS 3M™ Fire Barrier Water Tight Sealant 1003 SL 3M™ Fire Barrier Water Tight Sealant 3000 WT | 4 in. and smaller Plastic Cast-In Device system for single plastic pipe penetrating concrete floor. |
| F-A-2098 | 1, 2, 3 | 3M™ Fire Barrier Cast-In Devices for Plastic Pipes 3M™ Fire Barrier Water Tight Sealant 1000 NS 3M™ Fire Barrier Water Tight Sealant 1003 SL | 4 in. and smaller Plastic Cast-In Device system for single plastic pipe penetrating concrete floor. |
| F-A-2109 | 1, 2 | 3M™ Fire Barrier Cast-In Devices for Metal Pipes 3M™ Fire Barrier Water Tight Sealant 1000 NS 3M™ Fire Barrier Water Tight Sealant 1003 SL 3M™ Fire Barrier Cast-In Tub Box Assemblies | Fire Barrier Tub Box Device system for nonmetallic drain pipes. |
| F-A-2110 | 1, 2 | 3M™ Fire Barrier Cast-In Devices for Plastic Pipes 3M™ Fire Barrier Water Tight Sealant 1000 NS 3M™ Fire Barrier Water Tight Sealant 1003 SL | Max 4 in. closed or vented PVC or ccPVC, max 4 in. RNC, max 4 in. closed SDR 13.5 CPVC, max for in closed or vented ABS or ccABS, Max 4 in. closed or vented FRPP. Min. 2-1/2 in. concrete over fluted metal deck. 2 hour F rating. Class I W rating. |
| F-A-2115 | 1, 2 | 3M™ Fire Barrier Cast-In Devices for Metal Pipes 3M™ Fire Barrier Cast-In Devices for Plastic Pipes 3M™ Fire Barrier Water Tight Sealant 1000 NS 3M™ Fire Barrier Water Tight Sealant 1003 SL | Max three penetrants. Max 1 in. closed or vented PVC or ccPVC, max 1 in. RNC, max 1 in. closed SDR 13.5 CPVC, Max 3/4 in. PEX. 2MCID or 2PCID only. Minimum 2-1/2 in. over fluted metal deck. Point contact to max 1 in. annular. Space between penetrants min 1/4 in. to max 1 in. Packing material required. 2 hour F rating. Class I W rating. |
| F-A-2129 | 1, 2 | 3M™ Fire Barrier Wrap Ultra GS | Transition system. Max 4" Sched 10 steel pipe cast or grouted in place. Pipe terminates 2-1/2" to 3-1/2" below floor surface and min 2" above floor. Compression couplings. Max 4" PVC (closed or vented). 4" ccPVC (closed or vented). 4" ABS (closed or vented), 4" ccABS (closed or vented). 4" FRPP (closed or vented). 2 hour F Rating. Wrap strip and steel collar. Hangar straps required. |
| F-A-2130 | 1, 2 | 3M™ Fire Barrier Mortar | 4" PVC, CPVC, Rigid Nonmetallic Conduit in min 4-1/2" concrete. Max 9" opening. Min 24 gauge steel cover plate. Ultra GS Wrap Strips and steel collar. |
| F-A-2137 | 2, 3 | 3M™ Fire Barrier Cast-In Devices for Plastic Pipes | 6" PVC (closed or vented), 6" ccPVC (closed or vented), 6" rigid non-metallic conduit (RNC). Cast-in place device. Must be trimmed flush with top surface of floor. Height adapter for floors greater than 8" thick. 2 & 3 hour F Rating. |

Non-Metallic Pipes • Concrete

| 3M UL Systems | "F" Rating | 3M Product | Through Penetrant Details |
|---------------|------------|--|--|
| F-A-2167 | 2, 3 | 3M™ Fire Barrier Cast-In Devices for Plastic Pipes | Nominal 6 in. closed or vented PVC or ccPVC, nominal 6 in. RNC. Cast-In Device system. Minimum 4-1/2 in. concrete over fluted metal deck. 2 and 3 hour F ratings-dependent on penetrant. |
| F-A-2175 | 1, 2 | 3M™ Fire Barrier Wrap Ultra GS | Nonmetallic shower base receptor with stainless steel drain plate. Nom 2 in. PVC or ccPVC solvent welded to drain and centered in opening. Minimum 4-1/2 in. concrete. Max diam of opening 6 in. 1 hour F. Tile installed on shower pan. Steel collar required. Packing material required. Also known as FA2175. |
| F-A-2212 | 1, 2 | 3M™ Fire Barrier Cast-In Devices for Plastic Pipes 3M™ Fire Barrier Cast-In Device Metal Deck Adaptors | Max. 4 inch PVC, RNC, CPVC, or ABS pipe penetrating a concrete floor slab. Utilizing a steel cover plate, Ultra GS Wrap Strips within an RC-1 Retaining Collar or Plastic Pipe Device, and sealant. |
| F-A-2268 | 1, 2 | 3M™ Fire Barrier Tuck-In Wrap Strips 3M™ Fire Barrier Sealant IC 15WB+ 3M™ Fire Barrier Sealant CP 25WB+ 3M™ Fire Barrier Water Tight Sealant 3000 WT | Nominal 8 in. PPR pipe penetrating min. 4-1/2 in. concrete floor through a max. 9 in. diameter opening. |
| F-B-2005 | 1, 2 | 3M™ Fire Barrier Water Tight Sealant 1000 NS 3M™ Fire Barrier Sealant CP 25WB+ 3M™ Fire Barrier Sealant IC 15WB+ 3M™ Fire Barrier Sealant FD 150+ 3M™ Fire Barrier Wrap Ultra GS 3M™ Fire Barrier Moldable Putty Stix MP+ 3M™ Fire Barrier Water Tight Sealant 3000 WT | 3" PVC (closed or vented), 3" ccPVC (closed or vented), 3" RNC, 3" SDR 13.5 CPVC (closed), 2" PVC (closed or vented), 2" ccPVC (closed or vented). Hollow core included. Diam of opening min 1" to max 1-1/4" larger than nom pipe diam. Concentric installation. Min 1/4" to max 5/16" annular space. 2 hour F Rating. CP 25WB+ not for CPVC. Also known as FB2005. |
| F-B-2006 | 1, 2 | 3M™ Fire Barrier Water Tight Sealant 1000 NS 3M™ Fire Barrier Sealant CP 25WB+ 3M™ Fire Barrier Sealant IC 15WB+ 3M™ Fire Barrier Sealant FD 150+ 3M™ Fire Barrier Wrap Ultra GS 3M™ Fire Barrier Moldable Putty Stix MP+ 3M™ Fire Barrier Water Tight Sealant 3000 WT | 3" PVC (closed or vented), 3" ccPVC (closed or vented), 3" RNC, 3" SDR 13.5 CPVC (closed), 3" ABS (closed or vented), 3" ccABS (closed or vented), 3" FRPP (closed or vented). Min 28 gauge steel sleeve required. Diam of opening min 1" to max 1-1/4" larger than pipe diam. Concentric installation. Hollow core included. Min 1/4" to max 5/16" annular. 2 hour F Rating. CP 25WB+ not for CPVC. Also known as FB2006. |
| F-B-2015 | 1, 2, 3 | 3M™ Fire Barrier Cast-In Devices for Metal Pipes 3M™ Fire Barrier Cast-In Tub Box Assemblies | Nom 8 by 12 by 2 in. deep polyethylene tub box. Also referred as FB2015. |
| F-B-2018 | 1, 2, 3 | 3M™ Fire Barrier Cast-In Devices for Plastic Pipes 3M™ Fire Barrier Cast-In Device Metal Deck Adaptors | Single max. 4 in. PVC drain pipe penetrating a concrete floor with the use of a Fire Barrier Metallic Cast-In Device and Aerator Adapter. |
| W-J-2012 | 1, 2 | 3M™ Fire Barrier Sealant CP 25WB+ 3M™ Fire Barrier Sealant IC 15WB+ 3M™ Fire Barrier Sealant FD 150+ 3M™ Fire Barrier Wrap Strips FS-195+ 3M™ Fire Barrier Ultra Plastic Pipe Device 3M™ Fire Barrier RC-1 Restricting Collar | 4" PVC (closed or vented), 4" SDR 13.5 CPVC (closed). Max diam of opening 5 in. Concentric installation. Point contact to max 1/4 in. annular. 2 Hour F. CP 25WB+ not for CPVC. Also known as WJ2012. |
| W-J-2029 | 1, 2 | 3M™ Fire Barrier Sealant CP 25WB+ 3M™ Fire Barrier Sealant IC 15WB+ 3M™ Fire Barrier Moldable Putty Stix MP+ | 2" PVC (closed or vented), 3" PVC (closed), 3" SDR13.5 CPVC (closed), 3" RNC, 1" ENT, 2" ABS (closed or vented), 2" ccABS (closed or vented). Diam of opening 7/8" to 1" larger than OD of pipe. Concentric installation. Annular for max 1-1/4" pipe point contact to max 7/8". Annular for larger than 1-1/4" min 1/2" to max 1". 1 & 2 Hour F. CP 25WB+ not for CPVC. Also known as WJ2029. |
| W-J-2109 | 1, 2 | 3M™ Fire Barrier Sealant CP 25WB+ 3M™ Fire Barrier Sealant IC 15WB+ | 2" PVC (closed or vented), 2" ccPVC (closed or vented), 2" SDR13.5 CPVC (closed), 2" RNC, 1-1/2" ABS (closed or vented), 1-1/2" ccABS (closed or vented), 1-1/4" ENT. Max diam of opening 3-1/2". Concentric or eccentric installation. Point contact to max 1-1/8" annular. 2 Hour F. CP 25WB+ not for CPVC. Also known as WJ2109. |
| W-J-2110 | 1, 2 | 3M™ Fire Barrier Sealant CP 25WB+ 3M™ Fire Barrier Sealant IC 15WB+ | One or more: 1-1/2" PVC (closed or vented), 1-1/2" ccPVC (closed or vented), 1-1/2" RNC, 1-1/2" SDR 13.5 CPVC (closed), 1" SDR9 PEX (closed or vented). Max diam of opening 4". Concentric or eccentric installation. Annular between penetrant & opening periphery point contact to max 1". Space between penetrants point contact to max 1". Caulk only system. 2 Hour F. CP 25WB+ not for CPVC. Also known as WJ2110. |
| W-J-2152 | 1, 2 | 3M™ Fire Barrier Wrap Ultra GS 3M™ Fire Barrier Sealant CP 25WB+ 3M™ Fire Barrier Sealant IC 15WB+ 3M™ Fire Barrier Water Tight Sealant 3000 WT | 3" PVC (closed or vented), 3" ccPVC (closed or vented), 3" RNC, 3" CPVC (closed or vented), 3" ABS (closed or vented), 3" ccPVC (closed or vented). Max diam of opening 4-1/2". Concentric or eccentric installation. 2 Hour F & T Rating. Tuck in system. Min 3/8" to max 5/8" annular. CP 25WB+ not for CPVC. Also known as WJ2152 |

Non-Metallic Pipes • Concrete

| 3M UL Systems | "F" Rating | 3M Product | Through Penetrant Details |
|-----------------|------------|--|--|
| W-J-2231 | 1, 2 | 3M™ Fire Barrier Sealant IC 15WB+ 3M™ Fire Barrier Sealant CP 25WB+ 3M™ Fire Barrier Water Tight Sealant 3000 WT | Max 2 in. SDR 9 PEX (closed only). Min 6 in. concrete wall or concrete block wall. Max diam of opening 1-1/2 in. larger than OD of penetrant. Point contact to max 1-1/2 in. annular space. Concentric or eccentric installation. 2 hour F & T rating. No mineral wool required. Also known as WJ2231. |
| W-J-2248 | 1, 2 | 3M™ Fire Barrier Sealant IC 15WB+ 3M™ Fire Barrier Sealant CP 25WB+ 3M™ Fire Barrier Water Tight Sealant 3000 WT 3M™ Fire Barrier Wrap Ultra GS | Min 6 in. concrete wall. Concrete block wall. Max 3 in. SDR 7.4 PP (closed or vented). Max 3 in. SDR 11 PP (closed or vented). Diam of opening 1-1/2 in. larger than OD of pipe. Concentric/eccentric installation. Min 1/4 in. to max 1 in. annular space. 2 hour F & T. Also known as WJ2248. |
| W-J-2253 | 1, 2 | 3M™ Fire Barrier Tuck-In Wrap Strips 3M™ Fire Barrier Sealant IC 15WB+ 3M™ Fire Barrier Sealant CP 25WB+ | 2" PVC, 2 in. CPVC, 2" RNC through a concrete wall assembly. Max opening size of 5-1/2 in. |
| W-J-2256 | 1, 2 | 3M™ Fire Barrier Wrap Strips FS-195+ 3M™ Fire Barrier Sealant IC 15WB+ 3M™ Fire Barrier Sealant CP 25WB+ 3M™ Fire Barrier Sealant FD 150+ 3M™ Fire Barrier Water Tight Sealant 3000 WT | Min 4-1/2 in. concrete wall or concrete block wall. Max diam of opening 6-5/8 in. One nom 4in. PVC, CPVC, or ABS pipe installed at angle not greater than 45 degrees from perpendicular. Also known as WJ2256 |
| W-J-2305 | 1, 2 | 3M™ Fire Barrier Tuck-In Wrap Strips 3M™ Fire Barrier Sealant IC 15WB+ 3M™ Fire Barrier Sealant CP 25WB+ 3M™ Fire Barrier Water Tight Sealant 3000 WT | 8 in. polypropylene pipe penetrating a 2 hour concrete wall assembly. |
| W-K-2001 | 3, 4 | 3M™ Fire Barrier Sealant CP 25WB+ 3M™ Fire Barrier Sealant IC 15WB+ 3M™ Fire Barrier Wrap Ultra GS | 1-1/2" PVC (closed or vented), 1-1/2" ccPVC (closed or vented), 1-1/2" SDR13.5 CPVC (closed), 1-1/2" RNC, 1-1/2" ABS (closed or vented), 1-1/2" ccABS (closed or vented), 1-1/2" FRPP (closed or vented). Max diam of opening 3 in. Concentric or eccentric installation. Min 1/4" to max 7/8" annular. Tuck-in system. 4 Hour F. CP 25WB+ not for CPVC. Also known as WK2001. |

System No. C-AJ-2001

May 18, 2005

F Rating – 2 Hr

T Ratings – 0, 1-1/2 and 2 Hr (See Item 3)

L Rating at Ambient – 7 CFM/sq ft (See Item 3B)

L Rating at 400 F – 1 CFM/sq ft (See Item 3B)

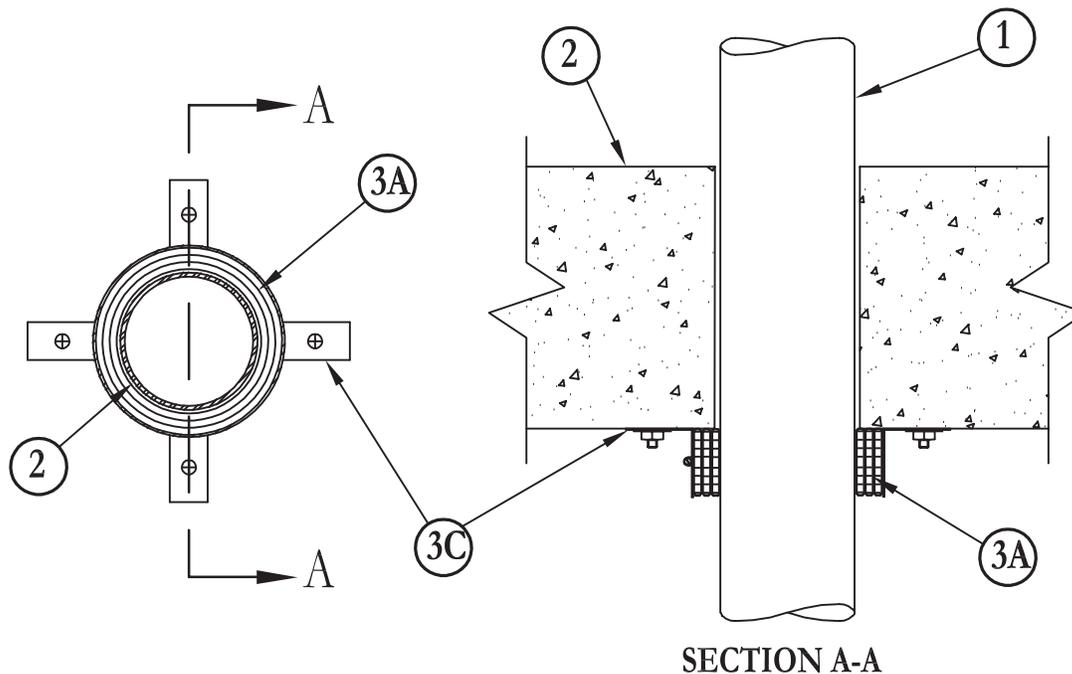

- 1. Floor or Wall Assembly** – Lightweight or normal weight (100-150 pcf or 1600-2400 kg/m³) concrete. Except as footnoted for floor assembly in table under Item 3, min thickness of solid concrete floor or wall assembly is 4-1/2 in. (114 mm). Floor assembly may also be constructed of any min 6 in. (152 mm) thick UL Classified hollow core **Precast Concrete Units***. Wall may also be constructed of any UL Classified **Concrete Blocks***. Diam of opening through floor or wall to be 0 in. to 1/4 in. (0 mm to 6 mm) larger than the outside diam of nom 2 in. (51 mm) diam and smaller pipes or conduits. Diam of opening to be 0 in. to 1/2 in. (0 mm to 13 mm) larger than the outside diam of nom 2-1/2 in. (64 mm) diam and larger pipes or conduits. Max diam of opening is 7 in. (178 mm).

See **Concrete Blocks (CAZT)** and **Precast Concrete Units (CFTV)** categories in Fire Resistance Directory for names of manufacturers.

- 2. Through Penetrants** – One nonmetallic pipe or conduit to be centered in the through opening. Pipe or conduit to be rigidly supported on both sides of the floor or wall assembly. The following types and sizes of nonmetallic pipes or conduits may be used:
 - A. Polyvinyl Chloride (PVC) Pipe** – Nom 6 in. (152 mm) diam (or smaller) Schedule 40 solid-core PVC pipe for use in closed (process or supply) or vented (drain, waste or vent) piping system.
 - B. Cellular – Core Polyvinyl Chloride (ccPVC) Pipe** – Nom 4 in. (102 mm) diam (or smaller) Schedule 40 cellular core PVC pipe for use in closed (process or supply) or vented (drain, waste or vent) piping system.
 - C. Chlorinated Polyvinyl Chloride (CPVC) Pipe** – Nom 6 in. (152 mm) diam (or smaller) SDR13.5 CPVC pipe for use in closed (process or supply) piping systems.
 - D. Acrylonitrile Butadiene Styrene (ABS) Pipe** – Nom 4 in. (102 mm) diam (or smaller) Schedule 40 solid-core ABS pipe for use in closed (process or supply) or vented (drain, waste or vent) piping systems.
 - E. Cellular Core Acrylonitrile Butadiene Styrene (ccABS) Pipe** – Nom 4 in. (102 mm) diam (or smaller) Schedule 40 cellular core ABS pipe for use in closed (process or supply) or vented (drain, waste or vent) piping systems.
 - F. Polybutylene (PB) Pipe** – Nom 3 in. (76 mm) diam (or smaller) SDR11 (or heavier) PB pipe for use in closed (process or supply) or vented (drain, waste or vent) piping systems.
 - G. Rigid Nonmetallic Conduit++** – Nom 4 in. (102 mm) diam (or smaller) (Schedule 40 or 80) PVC conduit installed in accordance with Article 347 of the National Electric Code (NFPA No. 70).
 - H. Flame Retardant Polypropylene (FRPP) Pipe** – Nom 4 in. (102 mm) diam (or smaller) Schedule 40 (or heavier) FRPP pipe for use in closed (process or supply) or vented (drain, waste or vent) piping systems.

See **Rigid Nonmetallic Conduit (DZKT)** category in UL Electrical Construction Materials Directory for names of manufacturers.

- 3. Firestop System** – The details of the firestop system shall be as follows:
 - A. Fill, Void or Cavity Materials* – Wrap Strip** – Nom 1/4 in. (6 mm) thick intumescent elastomeric material faced on one side with aluminum foil, supplied in 1 in. and 2 in. (25 mm and 51 mm) wide strips. Strips tightly wrapped around nonmetallic pipe (foil side exposed) with the edges butted against the underside of the concrete floor or both sides of wall surface. Sufficient layers of wrap strip shall be installed to lap a min of 3/16 in. (5 mm) on the concrete around the entire perimeter of the through opening. The min wrap strip width and the min number of layers of wrap required is dependent upon the pipe type, the nom pipe diam, the wall of floor thickness and the hourly T Rating required, as shown in the following table.

Through Penetrations

Non-Metallic Pipes

2000 Series

Concrete

CAJ

System No. C-AJ-2001 continued

Through Penetrations

Non-Metallic Pipes

2000 Series

Concrete

CAJ

| Pipe Type | Nom Pipe Diam In. (mm) | Min Wall or Floor Thkns In. (mm) | Wrap Strip Width In.(mm) | Min Wrap Strip Layers | T Rating Hr |
|--|-------------------------|----------------------------------|--------------------------|-----------------------|-------------|
| PVC, ccPVC or CPVC | 1/2 to 1-1/2 (13 to 38) | 2-1/2 (64) | 1 (25) | 1 | 0 |
| ABS, ccABS or FRPP(a) | 1/2 to 1-1/2 (13 to 38) | 2-1/2 (64) | 1 (25) | 1 | 1 |
| PVC, ccPVC or CPVC | 1/2 to 2 (13 to 51) | 2-1/2 (64) | 2 (51) | 1 | 0 |
| PVC, ccPVC or CPVC | 2 (51) | 2-1/2 (64) | 1 (25) | 2 | 0 |
| ABS, ccABS or FRPP(a) | 2 (51) | 2-1/2 (64) | 1 (25) | 2 | 1 |
| PVC, ccPVC or CPVC | 2-1/2 to 3 (64 to 76) | 2-1/2 (64) | 2 (51) | 2 | 0 |
| PVC, ccPVC or CPVC | 3-1/2 to 4 (89 to 102) | 2-1/2 (64) | 2 (51) | 3 | 0 |
| PVC, ccPVC or CPVC, ABS, ccPVC or FRPP(a) | 1/2 to 1-1/2 (13 to 38) | 4-1/2 (114) | 1 (25) | 1 | 2 |
| PVC, ccPVC, CPVC, ABS, ABS, ccABS or FRPP(a) | 2 (51) | 4-1/2 (114) | 1 (25) | 2 | 2 |
| PVC, ccPVC, CPVC, ABS, ccABS or FRPP(a) | 2-1/2 to 3 (64 to 76) | 4-1/2 (114) | 1 (25) | 3 | 2 |
| PVC, ccPVC, CPVC, ABS, ccABS, PB or FRPP(a) | 2-1/2 to 3 (64 to 76) | 4-1/2 (114) | 2 (51) | 2 | 2 |
| PVC, ccPVC or CPVC | 3-1/2 to 4 (89 to 102) | 4-1/2 (114) | 2 (51) | 2 | 1-1/2 |
| PVC, ccPVC, CPVC, ABS, ccABS or FRPP(b) | 3-1/2 to 4 (89 to 102) | 4-1/2 (114) | 2 (51) | 3 | 2 |
| PVC | 6 (152) | 4-1/2 (114) | 3 (76) | 3 | 0 |

(a) – Requires use of aluminum tape detailed in Item 3E.

(b) – Requires use of pipe covering detailed in Item 3D.

(c) – For nom 6 in. (152 mm) diam pipe, 1 in. and 2 in. (25 mm and 51 mm), wide wrap strips are “Stacked” to attain nom 3 in. (76 mm) wrap strip width.

Each layer of wrap strip to be installed with butted seam with butted seams in successive layers staggered. Wrap strip layers temporarily held in position using aluminum foil tape, steel wire tie, or equivalent. In wall assemblies, the wrap strip is to be installed in the same manner used for floor assemblies, but it shall be installed symmetrically on both sides of the wall assembly.

3M COMPANY – FS-195+

- B. **Fill, Void or Cavity Materials* – Caulk, Sealant or Putty** (Not Shown) – Generous bead of caulk or putty to be applied to outer perimeter of wrap strip at its interface with floor or wall surface(s).

3M COMPANY – CP 25WB+, IC 15WB+ caulk, FB-3000 WT sealant or MP+ Stix putty.

(Note: L Ratings apply only when CP 25WB+ caulk or FB-3000 WT sealant is used. CP 25WB+ not suitable for use with CPVC pipes.)

- C. **Steel Collar** – Nom 1 in., 2 in. or 3 in. (25 mm, 51 mm or 76 mm) deep collar, dependent upon wrap strip width, with 1-1/4 in. (32 mm) wide by 2 in. (51 mm) long anchor tabs and min 1/2 in. (13 mm) long tabs to retain wrap strip layers. Coils of precut 0.016 in. (0.41 mm) thick (28 gauge) galv sheet steel available from wrap strip manufacturer. As an alternate, collar may be field-fabricated from min 0.016 in. (0.41 mm) thick (28 gauge) galv sheet steel in accordance with instruction sheet supplied by wrap strip manufacturer. Steel collar, with anchor tabs bent outward 90 deg, wrapped tightly around wrap strip layers with min 1 in. (25 mm) overlap at seam. Anchor tabs to be pressed tightly against floor or wall surface(s), and collar to be compressed around wrap strip layers using a min 1/2 in. (13 mm) wide by 0.028 in. (0.71 mm) thick stainless steel band clamp at the collar midheight. Two band clamps are required for 3 in. (76 mm) high collar on nom 6 in. (152 mm) diam pipe. As an alternate to the band clamps, 1 in. and 2 in. (25 mm and 51 mm) deep collars may be secured by a means No. 10 by 1/2 in. (13 mm) long sheet metal screws installed in the vertical axis at the center of the 1 in. (25 mm) overlap along the perimeter joint of the collar. A min of two and three screws are required for 1 in. and 2 in. (25 mm and 51 mm) deep collars, respectively. Collar to be secured to floor or wall surface(s) with 1/4 in. (6 mm) diam by min 1-1/2 in. (38 mm) long steel expansion bolts, or equivalent, in conjunction with steel nuts and min 1-1/4 in. (32 mm) diam steel fender washers. Anchor bolts to be used with every other anchor tab or as described in the following which ever is greater. Two anchor bolts, symmetrically located, required for nom 1/2 in. (13 mm) to nom 2 in. (51 mm) diam pipes. Three anchor bolts, symmetrically located, required for nom 2-1/2 in. to 3 in. (64 mm to 76 mm) diam pipes. Four anchor bolts, symmetrically located, required for nom 3-1/2 in. and 4 in. (89 mm to 102 mm) diam pipes. For 6 in. (152 mm) diam pipes, anchor bolts to be used with each anchor tab. Retainer tabs to be bent 90 deg toward pipe to lock wrap strip layers in position.
- D. **Pipe Covering*** – Nom 1 in. (25 mm) thick hollow cylindrical heavy density glass fiber units jacketed on the outside with an all service jacket. When required (see table), min 6 in. (152 mm) length of pipe covering installed around pipe at its egress from the steel collar (Item C) on the underside of floor or on both sides of wall. Pipe covering secured to pipe with steel wire ties spaced max 4 in. (102 mm) OC. Edge of pipe covering abutting steel collar to be sealed with a min 1/4 in. (6 mm) diam bead of caulk or putty (Item B).

See **Pipe and Equipment Covering – Materials** (BRGU) category in Building Materials Directory for names of manufacturers. Any pipe covering material meeting the above specifications and bearing the UL Classification Marking with a Flame Spread Index of 25 or less and a Smoke Developed Index of 50 or less may be used.

- E. **Foil Tape** (Not Shown) – When required (see tables), nom 4 in. (102 mm) wide, 3 mil thick aluminum tape installed around pipe prior to installation of wrap strip (Item 3A) or Firestop Device (Item 3F). Min one layer wrapped around pipe with top edge of tape flush with bottom of surface of floor and extending downward. In walls, min one layer wrapped around pipe flush with both sides of wall and extending outward.

System No. C-AJ-2001 continued

- F. **Firestop Device*** (Not Shown) – As an alternate to Items A and C when nom 1-1/2, 2, 3, 4 or 6 in. (38, 51, 76, 102 or 152 mm) diam nonmetallic pipes are used, a firestop device consisting of a sheet-steel split collar lined with intumescent material and provided with steel clips for attachment may be used. Firestop device to be installed on underside of floor or on both sides of wall in accordance with the accompanying installation instructions. The firestop device type to be used is dependent upon the wall of floor thickness, the pipe type and nom pipe diam, as tabulated below:

| Pipe Type | Nom Pipe Diam In. (mm) | Min Wall or Floor Thkns In. (mm) | Firestop Device |
|---|------------------------|----------------------------------|--------------------|
| PVC, ccPVC or CPVC, ABS, ccABS or FRPP(a) | 1-1/2 (38 mm) | 2-1/2 (64) | PPD 1.5 or PPD 150 |
| PVC, ccPVC or CPVC, ABS, ccABS or FRPP(a) | 2 (51 mm) | 2-1/2 (64) | PPD 2 or PPD 200 |
| PVC, ccPVC or CPVC | 3 (76 mm) | 2-1/2 (64) | PPD 300 |
| PVC, ccPVC or CPVC | 4 (102 mm) | 2-1/2 (64) | PPD 400 |
| PB | 1-1/2 (38 mm) | 4-1/2 (114 mm) | PPD 150 |
| PB | 2 (51 mm) | 4-1/2 (114 mm) | PPD 200 |
| PVC, ccPVC or CPVC, ABS, ccABS or FRPP(a) | 3 (76 mm) | 4-1/2 (114 mm) | PPD 3 or PPD 300 |
| PB | 3 (76 mm) | 4-1/2 (114 mm) | PPD 300 |
| PVC, ccPVC or CPVC, ABS, ccABS or FRPP(a) | 4 (102 mm) | 4-1/2 (114 mm) | PPD 4 or PPD 400 |
| PVC | 4 (102 mm) | 4-1/2 (114 mm) | PPD 400 |
| PVC | 6 (152 mm) | 4-1/2 (114 mm) | PPD 6 |

(a) – Requires use of aluminum tape detailed in Item 3E.

(b) – Requires use of pipe covering detailed in Item 3D.

3M COMPANY

++Bearing the UL Listing Mark

*Bearing the UL Classification Mark

Reprinted from the Online Certifications Directory with permission from Underwriters Laboratories Inc.
Copyright © 2011 Underwriters Laboratories Inc.®

System No. C-AJ-2002

May 18, 2005

F Rating – 2 Hr

T Ratings – 0 and 2 Hr

L Rating at Ambient – 7 CFM/sq ft

L Rating at 400 F – less than 1 CFM/sq ft (See Item 3C)

W Rating – Class I (See Item 3)

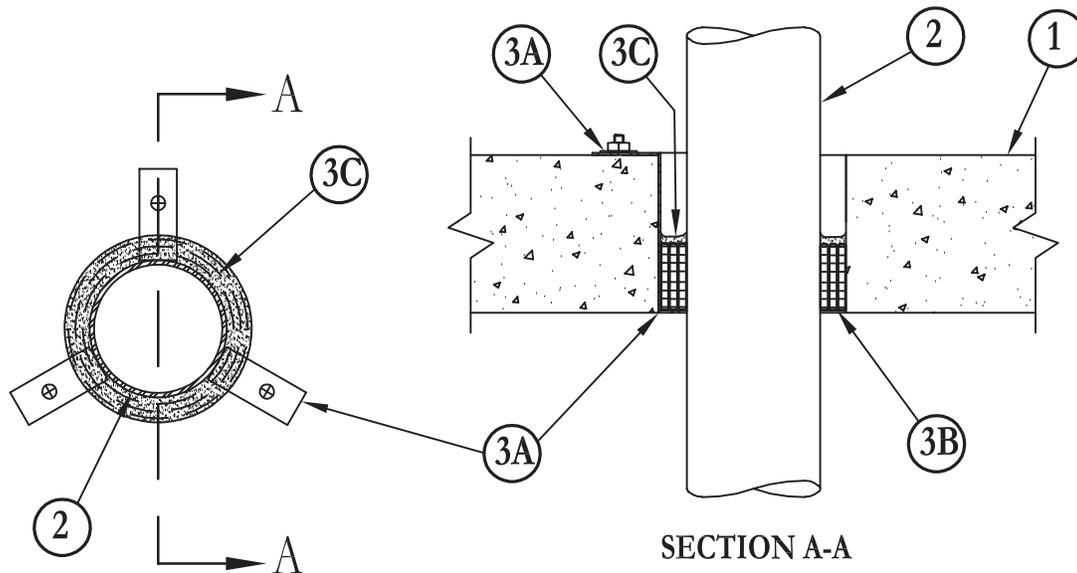

SECTION A-A

- Floor or Wall Assembly** – Min 2-1/2 in. (64 mm) thick lightweight or normal weight (100-150 pcf or 1600-2400 kg/m³) concrete. Wall may also be constructed of any UL Classified **Concrete Blocks***. Max diam of circular opening is 6-1/2 in. (165 mm).
See **Concrete Blocks (CAZT)** category in the Fire Resistance Directory for names of manufacturers.
- Nonmetallic Pipe or Conduit** – Nom 4 in. (102 mm) diam (or smaller) Schedule 40 solid core or cellular core, polyvinyl chloride (PVC) pipe for use in closed (process or supply) or vented (drain, waste or vent) piping systems or **Rigid Nonmetallic Conduit++** or SDR 13.5 chlorinated polyvinyl chloride (CPVC) pipe for use in closed (process or supply) piping systems. A max of one pipe or conduit is permitted in the firestop system. Except as noted in Item B, the pipe or conduit shall be centered in the through opening. Pipe or conduit to be rigidly supported on both sides of floor or wall assembly.
See **Rigid Nonmetallic Conduit (DZKT)** category in the UL Electrical Construction Materials Directory for names of manufacturers.
- Firestop System** – The hourly T Ratings for the firestop system are dependent upon the firestop orientation (wall or floor), the size of the nonmetallic pipe or conduit, and the floor thickness, as tabulated below:

| Orientation (a)Diam In. (mm)Space In. (mm) | Nom Pipe Space In. (mm) | Annular Hr | F Rating Hr | T Rating |
|---|----------------------------|------------------|----------------|----------|
| F(b) | 1/2-2 (13-51 mm) | 1/4-1 (6-25 mm) | 2 | 0 |
| F(b) | 2-1/2, 3 (64, 76 mm) | 1/2-1 (13-25 mm) | 2 | 0 |
| W, F | 1/2-2 (13-51 mm) | 1/4-1 (6-25 mm) | 2 | 2 |
| W, F | 2-1/2, 3 (64, 76 mm) | 1/2-1 (13-25 mm) | 2 | 2 |
| W, F | 3-1/2, 4 (89, 102 mm) | 3/4-1 (19-25 mm) | 2 | 2 |

(a) W = wall, F = floor

(b) Min concrete floor thickness is 2-1/2 in. (64 mm).

The details of the firestop system shall be as follows:

- Steel Support Clips** – Nom 1 in. (25 mm) wide by nom 0.019 in. (0.5 mm) thick (28 gauge) galv steel strips field-formed into “Z”-shape with height of Z-shape equal to the floor thickness and with width of bottom (as installed) leg of sufficient length to span annular space. Top (as installed) leg of Z-shape to be min 2 in. (51 mm) long and may or may not be secured to top surface of floor with masonry anchors. As an alternate to the Z-shape clips, the galv steel strips may be formed into “L”-shape with height equal to 2 in. (51 mm) and with bottom (as installed) leg of sufficient length to span annular space. Clips secured to outermost wrap strip layer with steel wire tie prior to insertion in through opening. Min of three steel support clips to be used, symmetrically located, with bottom leg of clips flush with bottom plane of floor. When annular space around nom 1/2 in. to 2 in. (13 mm to 51 mm) diam pipe in floor assembly is 1/4 in. to 3/8 in. (6 mm to 10 mm), steel support clips are not required.
- Fill, Void or Cavity Materials* – Wrap Strip** – Nom 1/4 in. (6 mm) thick intumescent elastomeric material faced on one side with aluminum foil, supplied in 2 in. (51 mm) wide strips. Nom 2 in. (51 mm) wide strips tightly wrapped around nonmetallic pipe (foil side exposed) to fill annular space around pipe. A min of one layer of wrap strip is required for nom 1/2 in. to 2 in. (13 mm to 51 mm) diam pipes. A min of two layers of wrap strip is required for nom 2-1/2 in. and 3 in. (64 mm and 76 mm) diam pipes. A min of three layers of wrap strip is required for nom 3-1/2 in. and 4 in. (89 mm and 102 mm) diam pipes. Each layer of wrap strip to be installed with butted seam with butted seams in successive layers staggered. Wrap strip layers securely bound with steel wire or aluminum foil tape and slid

System No. C-AJ-2002 *continued*

into through opening such that the bottom edges are flush with the bottom plane of the floor and are resting on the steel support clip legs. When nom 2 in. to 4 in. (51 mm to 102 mm) diam PVC pipe is used in min 4-1/2 in. (114 mm) thick concrete floor, the pipe may be installed eccentrically in the through opening (min zero clearance at point contact location) provided that (1) the inside diam of the through opening is 1.3 to 1.5 times larger than the outside diam of the pipe, (2) the annular space between the pipe and the sides of the opening at the bottom 2 in. (51 mm) of the through opening is completely filled with wrap strip layers installed following the contour of the pipe and (3) the bottom edges of the wrap strip layers are reliably supported by “Z”-shaped steel support clips anchored to the top surface of the concrete floor. In wall assemblies, the wrap strip layers on the nonmetallic pipe are to be installed in the same manner used for floor assemblies, but shall be installed symmetrically on both sides of the wall with the exposed edges of the wrap strip layers flush with the wall surfaces.

3M COMPANY – FS-195+

- C. **Fill, Void or Cavity Materials* – Caulk or Sealant** – Min 1/4 in. (6 mm) diam continuous bead applied to inside walls of through opening prior to installation of steel support clips and/or wrap strip. Caulk bead to be recessed 1 in. (25 mm) from the bottom plane or floor. In wall assemblies, caulk bead to be recessed 1 in. (25 mm) from wall surface on both sides of wall. In floor assemblies, a nom 1/2 in. (13 mm) thick coating of caulk is to be applied to the top edges of the wrap strip layers and to fill all gaps at the wrap strip/concrete interface. In wall assemblies, the exposed edges of the wrap strip layers and all gaps at the wrap strip/concrete interface on both sides of the wall to be coated with thin layer of caulk.

3M COMPANY – CP 25WB+, IC 15WB+ caulk or FB-3000 WT sealant.

(Note: W Rating applies only when FB-3000 WT sealant is used. CP 25WB+ not suitable for use with CPVC pipes.)

*Bearing the UL Classification Marking

++Bearing UL Listing Mark

Reprinted from the Online Certifications Directory with permission from Underwriters Laboratories Inc.
Copyright © 2010 Underwriters Laboratories Inc.®



Note: Systems with Nonmetallic Through Penetrant(s) have not been evaluated with a pressure differential of 50 Pa between the exposed and unexposed surfaces as required by the National Building Code of Canada.

Through Penetrations

Non-Metallic Pipes

2000 Series

Concrete

C-AJ

System No. C-AJ-2003

May 18, 2005

F Rating – 3 Hr

T Rating – 1/2 Hr

L Rating at Ambient – 15 CFM/sq ft

L Rating at 400 F – less than 1 CFM/sq ft

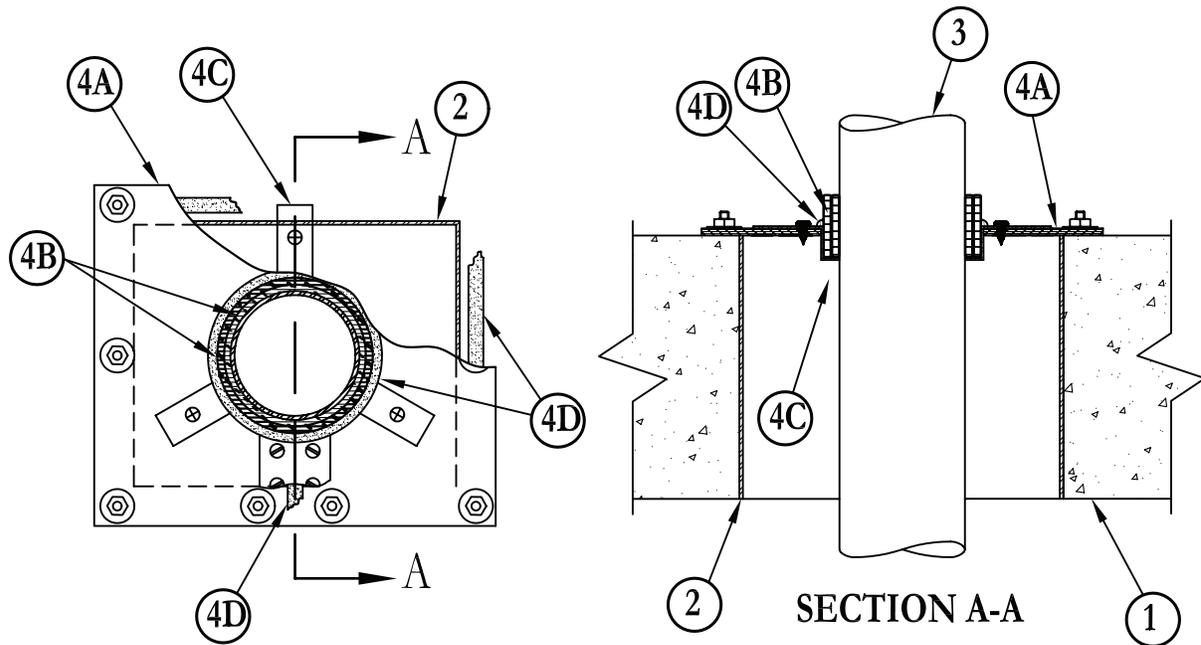

- Floor or Wall Assembly** – Min 4-1/2 in. (114 mm) thick lightweight or normal weight (100-150 pcf or 1600-2400 kg/m³) concrete. Wall may also be constructed of any UL Classified **Concrete Blocks***. Max area of rectangular or square opening 64 sq in. (413 sq cm) with max dimension of 8 in. (203 mm). Max diam of circular opening is 8 in. (203 mm).

See **Concrete Blocks (CAZT)** category in the Fire Resistance Directory for names of manufacturers.

- Steel Sleeve (Optional)** – Min 3/16 in. (5 mm) thick steel welded to form a four sided square or rectangular sleeve. For circular openings, steel sleeve to consist of nom 8 in. (203 mm) diam (or smaller) Schedule 40 (or heavier) steel pipe.
- Nonmetallic Pipe or Conduit** – Nom 2 in. (51 mm) diam (or smaller) Schedule 40 polyvinyl chloride (PVC) pipe for use in closed (process or supply) or vented (drain, waste or vent) piping systems or Rigid Nonmetallic Conduit++ or SDR13.5 chlorinated polyvinyl chloride (CPVC) pipe for use in closed (process or supply) piping systems. One pipe to be installed within the firestop system. A min 1 in. to max 3 in. (25 mm to max 76 mm) annular space is required within the firestop system. Pipe to be rigidly supported on both sides of the floor or wall assembly.
- Firestop System** – The firestop system shall consist of the following:

- Fill, Void or Cavity Material* – Intumescent Sheet** – Rigid aluminum foil-faced sheet with galv steel sheet backer. Diam of hole cut in sheet to accommodate pipe to be 1 in. (25 mm) larger than diam of pipe such that a uniform 1/2 in. (13 mm) space is present between the pipe and perimeter of the sheet cutout. Sheet cut to lap a min of 2 in. (51 mm) on the concrete on all sides of the through opening. A max of one slit may be made in the sheet to permit installation of the sheet about the pipe. The slit shall be made perpendicular to the side of the sheet nearest the circular cutout and shall intersect with the circular cutout in line with the center of the cutout. Sheet to be installed with the galv steel sheet backer exposed (aluminum foil facing against floor or wall surface). Sheet secured to top surface of floor and to both surfaces of wall using 1/4 in. (6 mm) diam by steel expansion bolts in conjunction with steel nuts and min 1-1/4 in. (32 mm) diam steel washers. Max spacing of fasteners not to exceed 6 in. (152 mm) OC, with additional fasteners required max 1 in. (25 mm) from both sides of slit made to permit installation of sheet about pipe. Prior to installation of the sheet(s), a nom 1/4 in. (6 mm) diam bead of caulk or putty (Item D) shall be applied to the top surface of the floor and on both surfaces of the wall around the perimeter of the through opening. Min 2 in. (51 mm) wide strip of min 0.016 in. (0.41 mm) thick (30 gauge) galv steel sheet to be centered over slit in sheet and secured to galv steel sheet backer on both sides of slit with steel sheet metal screws located max 1/2 in. (13 mm) from edge of cutout and max 1/2 in. (13 mm) from edge of through opening. Prior to installation of the steel cover strip, the slit in the sheet shall be covered with a nom 1/4 in. (6 mm) diam bead of caulk or putty (Item D).

3M COMPANY – CS-195+

- Fill, Void or Cavity Materials* – Wrap Strip** – Nom 1/4 in. (6 mm) thick intumescent elastomeric material faced on one side with aluminum foil, supplied in 2 in. (51 mm) wide strips. Nom 2 in. (51 mm) wide strips tightly wrapped around nonmetallic pipe (foil side exposed). Two layers of wrap strip are required. Each layer of wrap strip to be installed with butted seam with butted seam of second layer offset from butted seam of first layer. Wrap strip layers temporarily held in position using aluminum foil tape, steel wire tie, or equivalent. In wall assemblies, the wrap strip is to be installed in the same manner used for floor assemblies, but it shall be installed symmetrically on both sides of wall assembly.

3M COMPANY – FS-195+

System No. C-AJ-2003 *continued*

- C. **Steel Collar** – Nom 1-1/4 in. (32 mm) deep collar with 1-1/4 in. (32 mm) wide by 2 in. (51 mm) long anchor tabs and 1/2 in. (13 mm) long tabs to retain wrap strip layers. Coils of precut 0.016 in. (0.41 mm) thick (30 gauge) galv sheet steel available from pipe wrap manufacturer. As an alternate, collar may be field-fabricated from min 0.016 in. (0.41 mm) thick (30 gauge) galv sheet steel in accordance with instruction sheet supplied by wrap strip manufacturer. Steel collar, with anchor tabs bent outward 90 degrees and with retainer tabs bent inward 90 degrees wrapped tightly around wrap strip layers with min 1 in. (25 mm) overlap at seam. Steel collar and wrap strip slid into cutout in intumescent sheet such that the bottom edges of wrap strip layers and steel collar project 1 in. (25 mm) below top plane of floor and such that anchor tabs rest on top surface of intumescent sheet. Secure anchor tabs to galv steel sheet backer of intumescent sheet with steel sheet metal screws. Compress wrap strip layers around pipe above intumescent sheet using a min 1/2 in. (13 mm) wide by 0.028 in. (0.71 mm) thick stainless steel band clamp with worm drive tightening mechanism. Steel collar not required for firestops in wall assemblies. Instead, the wrap strip layers are slid into cutout in intumescent sheet on each side of wall such that the exposed edges of wrap strip layers project 1 in. (25 mm) from exposed face of intumescent sheet. Compress wrap strip layers around pipe using a min 1/2 in. (13 mm) wide by 0.028 in. (0.71 mm) thick stainless steel band clamp with worm drive tightening mechanism at the projecting wrap strip midheight.
- D. **Fill, Void or Cavity Materials*** – **Caulk or Sealant** – Generous application of caulk to be applied to the base of the wrap strip at its egress from the intumescent sheet(s) in addition to coating all exposed seams in wrap strip layers. Nom 1/4 in. (6 mm) bead of caulk to be applied to slit in intumescent sheet(s) prior to installation of steel cover strip.
3M COMPANY – CP 25WB+ caulk or FB-3000WT sealant. (CP 25WB+ not suitable for use with CPVC pipes.)
- E. **Fill, Void or Cavity Materials*** – **Graphite Seal, Caulk, Sealant or Putty** (Not Shown) – One layer of 1/2 in. x 1/16 in. (13 mm x 1.6 mm) adhesive backed graphite intumescent seal positioned under intumescent sheet around entire perimeter of through opening or min 1/4 in. (6 mm) diam continuous bead of caulk or putty applied to edge of intumescent sheet at its interface with surface of floor or wall around entire perimeter of through opening.
3M COMPANY – E-FIS or Ultra GS seals, CP 25WB+, IC 15WB+ caulk, FB-3000WT sealant or MP+ Stix putty.
(Note: CP 25WB+ not suitable for use with CPVC pipes.)

+Bearing the UL Listing Mark

*Bearing the UL Classification Marking

Reprinted from the Online Certifications Directory with permission from Underwriters Laboratories Inc.
Copyright © 2011 Underwriters Laboratories Inc.®

Through Penetrations

Non-Metallic Pipes

2000 Series

Concrete

CAJ

System No. C-AJ-2005

May 18, 2005

F Ratings – 1, 2 and 3 Hr (See Item 3)

T Ratings – 1, 1-1/2, 2 and 3 Hr (See Item 3)

L Rating at Ambient – 7 CMF/sq ft

L Rating at 400 F – less than 1 CMF/sq ft

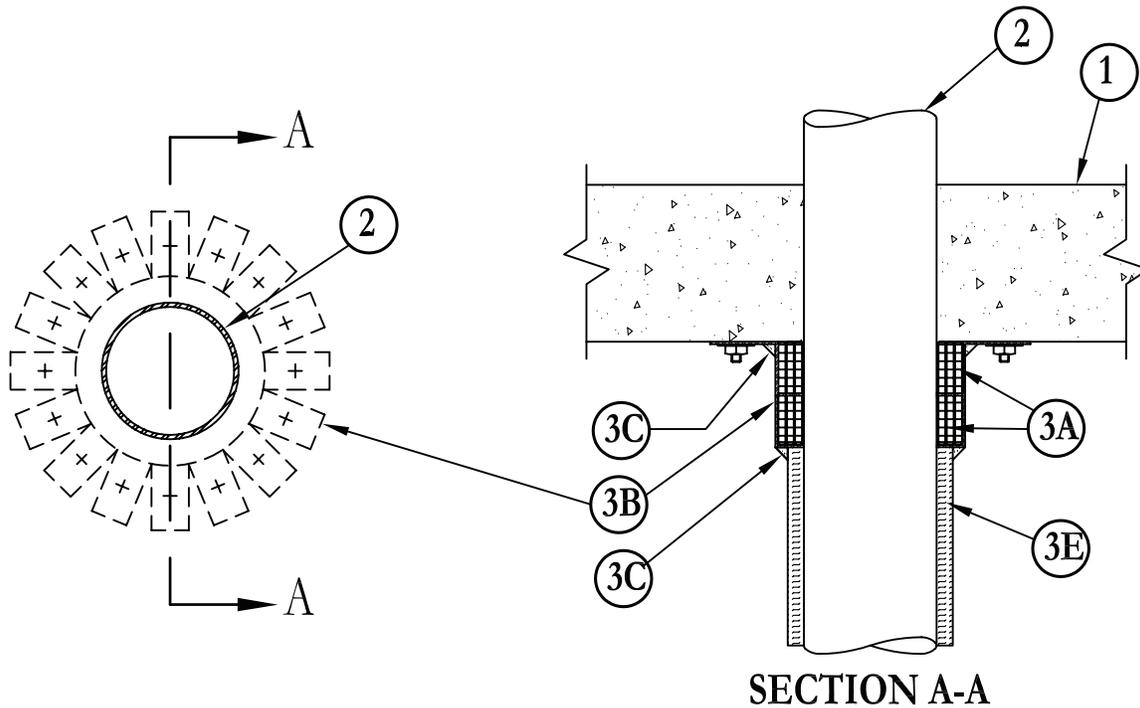

- Floor or Wall Assembly** – Lightweight or normal weight (100-150 pcf or 1600-2400 kg/m³) concrete. Except as noted for floor assembly in table under Item 4, min thickness of solid concrete floor or wall assembly is 4-1/2 in. (114 mm). Wall may also be constructed of any UL Classified **Concrete Blocks***. Max diam of preformed or core-drilled circular opening is 7 in. (178 mm) when nom 6 in. (152 mm) diam pipe is used. When nom 8 in. or 10 in. (203 mm or 254 mm) diam pipe is used, the diam of the circular through opening shall be max 1-1/2 in. (38 mm) larger than the outside diam of the pipe and the annular space around the pipe shall be back filled with hydraulic cement throughout the thickness of the floor or wall assembly.
See **Concrete Blocks** (CAZT) category in the Fire Resistance Directory for names of manufacturers.
- Nonmetallic Pipe** – Nom 6 in., 8 in. or 10 in. (152 mm, 203 mm or 254 mm) diam Schedule 40 solid core polyvinyl chloride (PVC) pipe for use in closed (process or supply) or vented (drain, waste or vent) piping systems. One pipe to be centered within the firestop system. Pipe to be rigidly supported on both sides of the floor or wall assembly.
- Firestop System** – The hourly F and T Ratings for the firestop system are dependent upon the firestop orientation (wall or floor) and the size of the nonmetallic pipe, as tabulated below:

| Orientation (a) | Nom Pipe Diam In. (mm) | Annular Space In. (mm) | F Rating Hr | T Rating Hr |
|--------------------|---------------------------|---------------------------|----------------|----------------|
| F(b) | 6 (152) | 0-1/4 (0-6) | 1 | 1 |
| W, F | 6 (152) | 0-1/4 (0-6) | 2 | 2 |
| W, F | 8, 10 (203, 254) | 0 (0) | 2 | 1-1/2 |
| W, F | 6 (152) | 0-1/4 (0-6) | 3 | 3 |

(a) W=wall, F=floor.

(b) Min concrete floor thickness is 2-1/2 in. (64 mm)

The details of the firestop system shall be as follows:

- Fill, Void or Cavity Materials* – Wrap Strip** – Nom 1/4 in. (6 mm) thick intumescent elastomeric material faced on one side with aluminum foil, supplied in 2 in. (51 mm) wide by 24 in. (610 mm) long strips. Two stacks of wrap strips (nom 4 in. (102 mm) stack height) tightly wrapped around nonmetallic pipe with the top edges butted against the underside of the concrete floor. For 2 hr F Rating with nom 6 in. (152 mm) diam pipes, three layers of wrap strip are required in each stack. For 3 hr F Rating with nom 6 in. (152 mm) diam pipes and for 2 hr F Rating with nom 8 in. (203 mm) diam pipes, four layers of wrap strip are required in each stack. For 2 hr F Rating with nom 10 in. (254 mm) diam pipes, five layers of wrap strip are required in each stack. Each layer of wrap strip to be installed with butted seam with butted seams in successive layers staggered. Wrap strips temporarily held in position using aluminum foil tape, filament tape, steel wire tie, or equivalent. In wall assemblies, the wrap strips are to be installed in the same manner used for floor assemblies, but they shall be installed symmetrically on both sides of the wall assembly.

3M COMPANY – FS-195+

System No. C-AJ-2005 *continued*

- B. **Steel Collar** – Nom 4 in. (102 mm) deep collar with 1-1/4 in. (32 mm) wide by 2 in. (51 mm) long anchor tabs to retain wrap strip layers. Coils of precut min 0.019 in. (0.5 mm) thick (No. 26 gauge) galv sheet steel available from wrap strip manufacturer. As an alternate, collar may be field-fabricated from min 0.019 in. (0.5 mm) thick (No. 26 gauge) galv sheet steel in accordance with instruction sheet supplied by wrap strip manufacturer. Steel collar, with anchor tabs bent outward 90 degree, wrapped tightly around wrap strip layers using two min 1/2 in. (13 mm) wide by 0.028 in. (0.7 mm) thick stainless steel band clamps with worm gear tightening mechanisms, with clamps located approx 1 in. (25 mm) from each end of wrap strips. Secure collar to floor or wall surface(s) with 1/4 in. (6 mm) diam by min 1-1/2 in. (38 mm) long steel expansion bolts, or equivalent, in conjunction with steel nuts and min 1-1/4 in. (32 mm) diam steel fender washers with one anchor bolt in each anchor tab. As a final step, bend retainer tabs 90 deg toward pipe to lock wrap strip layers in position.
- C. **Fill, Void or Cavity Materials*** – **Caulk or Sealant** – Generous bead of caulk to be applied to outer perimeter of wrap strip at interface with floor or wall surface and to perimeter of pipe at its egress from the wrap strip layers.
3M COMPANY – CP 25WB+, IC 15WB+ caulk or FB-3000 WT sealant.
- D. **Roofing Nails** (Not Shown) – Nom 1-1/4 in. (32 mm) long galv steel roofing nails. When nom 10 in. (254 mm) diam PVC pipe is used, roofing nails driven through steel collar (Item B) into wrap strip layers approx 1 in. (25 mm) from each end of wrap strips and spaced approx 1 in. (25 mm) OC around entire circumference of steel collar at each elevation.
- E. **Pipe Covering*** – Nom 1 in. (25 mm) thick hollow cylindrical heavy density (min 3.5 pcf or 56 kg/m³) glass fiber units jacketed on the outside with an all service jacket. Min 6 in. (152 mm) length of pipe covering installed around nonmetallic pipe at its egress from steel collar, the underside of floor or on both sides of the wall. Pipe covering secured to pipe with steel wire ties spaced max 4 in. (102 mm) OC. Edge of pipe covering abutting wrap strip to be sealed with a min 1/4 in. (6 mm) diam bead of caulk (Item D). Pipe covering not required on nom 6 in. (152 mm) diam pipe for 2 hr F Rating.

See **Pipe and Equipment Covering – Materials** (BRGU) category in the Building Materials Directory for names of manufacturers. Any pipe covering material meeting the above specifications and bearing the UL Classification Marking with a Flame Spread Index of 25 or less and a smoke Developed Index of 50 or less may be used.

*Bearing the UL Classification Marking

Reprinted from the Online Certifications Directory with permission from Underwriters Laboratories Inc.
Copyright © 2011 Underwriters Laboratories Inc.®

System No. C-AJ-2006

July 30, 2010

F Ratings – 2 and 3 Hr (See Item 1)

T Ratings – 0, 1/2, and 1 Hr (See Item 3)

L Rating at Ambient – 15 CFM/sq ft

L Rating at 400 F – less than 1 CFM/sq ft

W Rating – Class 1 (See Item 4)

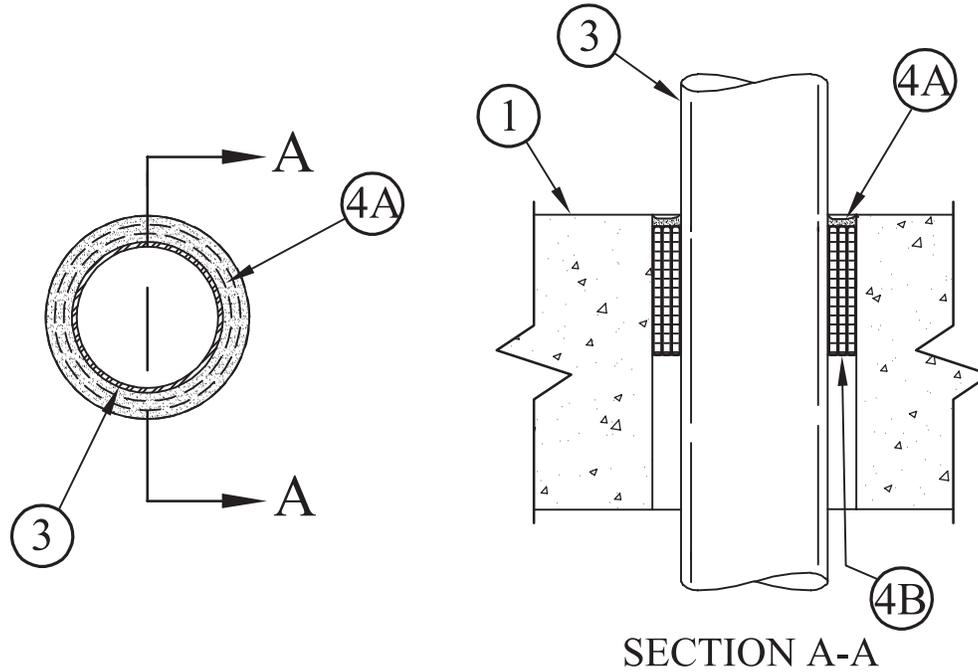

- Floor or Wall Assembly** – Min 3 in. thick solid lightweight or normal weight (100-150 pcf) concrete. **When min thickness of concrete slab (or min concrete topping thickness over crest of corrugated or fluted steel form unit) is 3 in., F Rating of firestop system is 2 h. When min thickness of concrete slab (or min concrete topping thickness over crest of corrugated or fluted steel form unit) is 4-1/2 in., F Rating of firestop system is 3 h.** Wall may also be constructed of any UL Classified **Concrete Blocks***. Max diam of circular opening is 8-1/4 in.
See **Concrete Blocks (CAZT)** category in the Fire Resistance Directory for names of manufacturers.
- Steel Sleeve** – (Optional, Not Shown) – Nom 8 in. diam (or smaller) Schedule 40 (or heavier) steel pipe.
- Through-Penetrants* – Glass Pipe** – Nom 1/2, 3/4, 1, 1-1/2, 2, 3, 4 or 6 in. diam glass drain line or process pipe. Max one glass pipe per opening. Pipe to be rigidly supported on both sides of wall or floor assembly. Pipe couplings to be located min 12 in. from wall or floor surfaces. The annular space between the pipe and the edge of the through opening shall be 3/4 to 1 in. When nom 1-1/2 in. diam glass pipe is used, T Rating is 1 hr. When nom 2 in. to nom 6 in. diam glass pipe is used, T Rating is 0 hr when the piping system is vented (drain pipe) and 1/2 h when the piping system is closed (supply or process pipe).

SCHOTT NORTH AMERICA INC

- Firestop System** – Firestop system consists of wrap strips (Item 4B) in conjunction with caulk fill material (Item 4A).
 - Fill, Void or Cavity Materials* – Caulk or Sealant** – Min 1/4 in. thickness of caulk applied to the exposed edges of the wrap strip (Item 4B) and to fill all voids between the glass pipe and the periphery of the opening on the top surface of floor assemblies and on both surfaces of wall assemblies. When armored glass process pipe is used, the pipe should be wrapped with a 2 to 3 mil thick pressure-sensitive aluminum foil tape to prevent contact between the caulk material and the armored pipe.
3M COMPANY – Types CP 25WB+ or FB-3000 WT
(Note: W Rating applies only when FB-3000 WT is used.)
 - Fill, Void or Cavity Material* – Wrap Strip** – Nom 1/4 in. thick intumescent elastomeric material faced on one side with aluminum foil, supplied in 2 in. wide strips. Nom 2 in. wide strips wrapped around glass pipe (foil side exposed) to fill max 1 in. annular space in circular through opening. Each layer of wrap strip to be installed with butted seam with butted seam in successive layers staggered. Wrap strip tightly bound with steel wire and slid into through opening such that the top edge of the wrap strip is recessed a max of 1/4 in. from the top surface of the floor assembly. In wall assemblies, the wrap strip on the glass pipe is to be installed in the same manner used for floor assemblies, but it shall be located at the middepth of the through opening in the wall assembly. Min 1/4 in. thickness of caulk (Item 4A) to be applied to the exposed edge(s) of the wrap strip and to fill all voids between the glass pipe and the periphery of the opening on the top surface of floor assemblies and on both sides of the wrap strip in wall assemblies.

3M COMPANY – Type FS-195+

*Bearing the UL Classification Mark

Reprinted from the Online Certifications Directory with permission from Underwriters Laboratories Inc.

Copyright © 2010 Underwriters Laboratories Inc.®



Note: Systems with Nonmetallic Through Penetrant(s) have not been evaluated with a pressure differential of 50 Pa between the exposed and unexposed surfaces as required by the National Building Code of Canada.

System No. C-AJ-2019

May 09, 2013

F Ratings – 1 and 2 Hr (See Item 3)

T Ratings – 0 and 1/2 Hr (See Item 3)

L Rating At Ambient – Less Than 1 CFM/sq ft

L Rating At 400 F – Less Than 1 CFM/sq ft

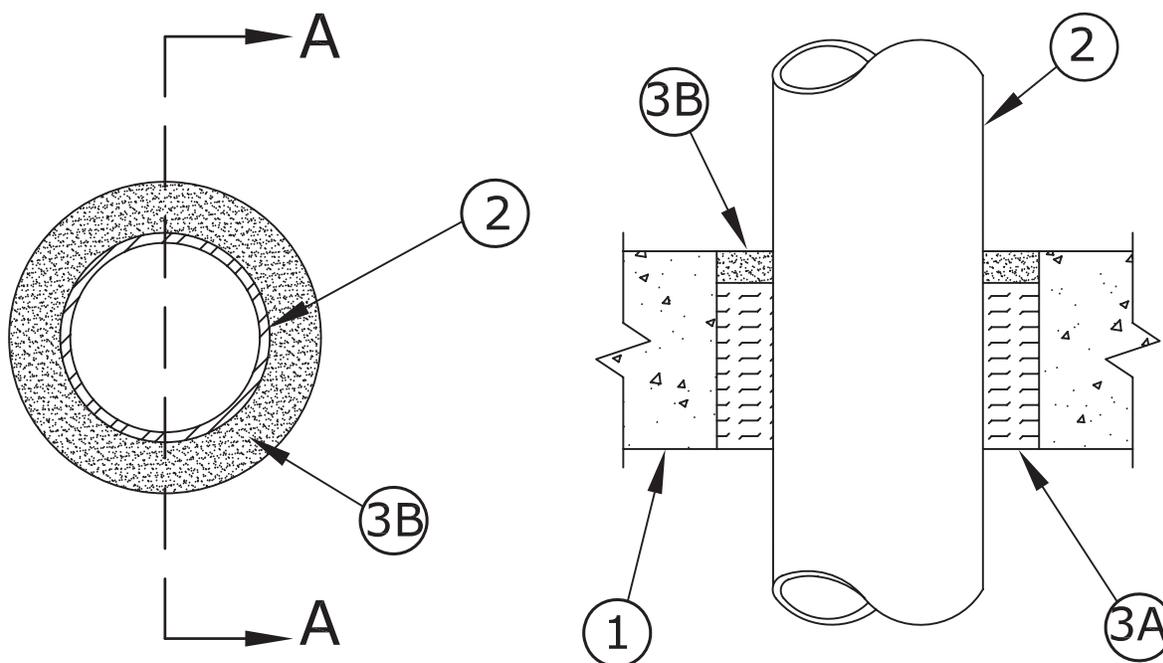

- Floor or Wall Assembly** – Min 4-1/2 in. (114 mm) thick reinforced lightweight or normal weight (100-150 pcf or 1600-2400 kg/m³) concrete floor or min 5 in. (127 mm) thick reinforced lightweight or normal weight concrete wall. Walls may also be constructed of any UL Classified **Concrete Blocks***.

See **Concrete Block (CAZT)** category in the Fire Resistance Directory for names of manufacturers.

- Through-Penetrants* – Glass Pipe** – Nom 1/2, 3/4, 1, 1-1/2, 2, 3, or 4 in. diam (13, 19, 25, 38, 51, 76 or 102 mm) glass pipe for use in closed (process or supply) piping systems. Pipe to be rigidly supported on both sides of floor or wall assembly. Pipe couplings to be located min 12 in. (305 mm) from floor or wall surfaces. The annular space shall be as shown under Item 3.

SCHOTT NORTH AMERICA INC – KG-33.

- Firestop System** – The F and T Rating of the system is dependent upon annular space, thickness of forming material and thickness of caulk as shown in the table below:

| Annular Space In. | Thkns of Forming Mat In. | Thkns of Caulk In. | F Rating Hr | T Rating Hr |
|-------------------|--------------------------|--------------------|-------------|-------------|
| 1/2 (13) | 4 (104) | 1/2 (13) | 1 | 1/2 |
| 3/4 (19) | 3 (76) | 1 (25) | 2 | 0 |

- Packing Material** – Min 4 pcf (64 kg/m³) mineral wool batt insulation firmly packed into opening as a permanent form at the min thickness specified above. Packing material to be recessed from top surface of floor or from both surfaces of wall as required to accommodate the required thickness of fill material.
- Fill, Void or Cavity Material* – Sealant** – Min 1/2 in. (13 mm) thickness of fill material applied with the annulus, flush with the top surface of floor and with both surfaces of the wall assembly at the min thickness specified above.

3M COMPANY – Type FB-1000 NS, FB-1003SL (floors only), FB-2000 or FB-2000+.

*Bearing the UL Classification Mark

Reprinted from the Online Certifications Directory with permission from UL

© 2013 UL LLC



Through Penetrations

Non-Metallic Pipes

2000 Series

Concrete

CAJ

System No. C-AJ-2027

August 23, 2004

(Formerly System No. 394)

F Ratings – 2 and 3 Hr. (See Item 3)

T Ratings – 3/4, 2 and 3 Hr. (See Item 3)

L Rating At Ambient – 15 CFM/sq ft

L Rating At 400 F – less than 1 CFM/sq ft

W Rating – Class I (See Item 3)

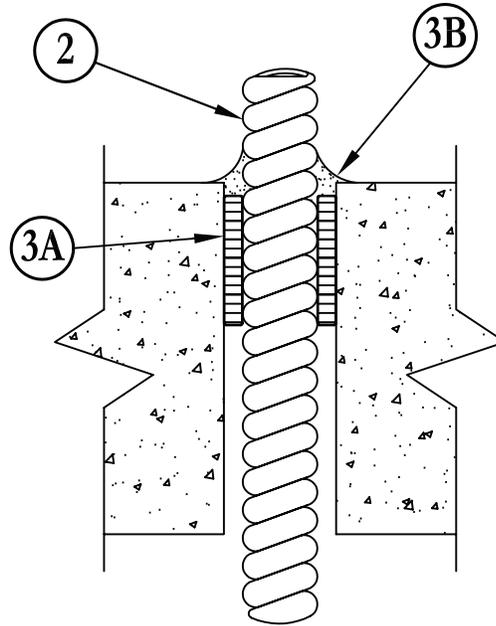
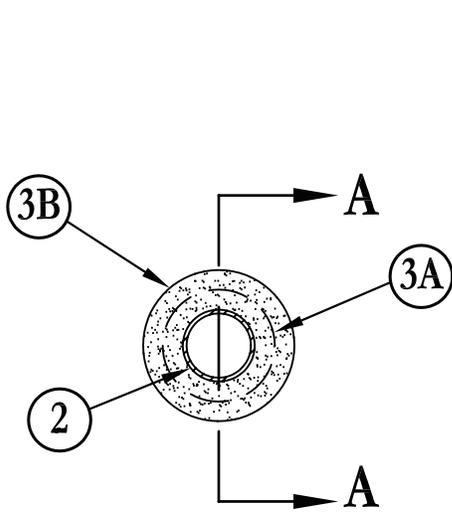

SECTION A-A

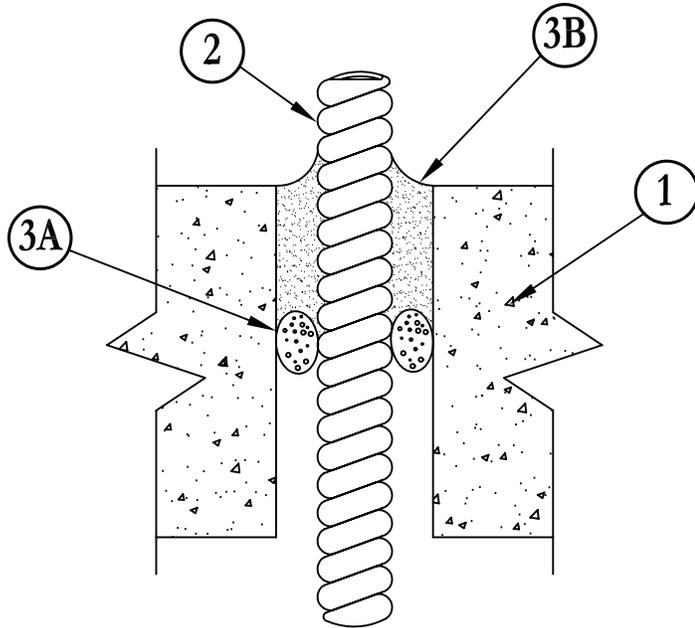
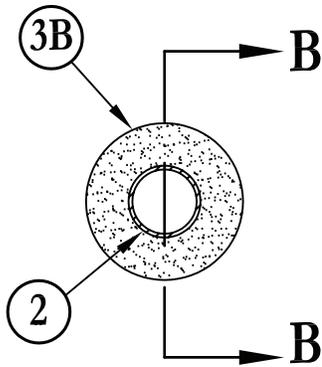

SECTION B-B

System No. C-AJ-2027 continued

1. **Floor or Wall Assembly** – Min 4-1/2 in. thick lightweight or normal weight (100-150 pcf) concrete. Wall may also be constructed of any UL Classified **Concrete Blocks***. Max diam of circular through opening is 3 in.
See **Concrete Blocks (CAZT)** category in the Fire Resistance Directory for names of manufacturers.
2. **Electrical Nonmetallic Tubing++** – Nom 1 in. diam (or smaller) corrugated wall ENT constructed of polyvinyl chloride. ENT to be installed as a complete system with all terminations in junction boxes, outlet boxes or other approved enclosures as specified in the National Electrical Code. Max one ENT per through opening. ENT to be centered in opening and rigidly supported on both sides of the floor or wall assembly.
See **Electrical Nonmetallic Tubing (FKHU)** category in Electrical Construction Materials Directory for names of manufacturers.
- 2A. **Wires++** (Not Shown) – Max No. 12 AWG copper conductor wires with PVC insulation. Wire insulation temperature limitations shall not exceed temperature for which ENT (Item 2) is UL Listed.
See **Wires (ZGZX)** category in Electrical Construction Materials Directory for names of manufacturers.
3. **Firestop System** – The hourly F and T Ratings for the firestop system are dependent upon the firestop configuration. The firestop configuration is dependent upon the size of the annular space between the ENT and the perimeter of the through opening, as tabulated below:

| Nom ENT Diam In. | Annular Space In. | Firestop Config (a) | F Rating Hr | T Rating Hr |
|------------------|-------------------|---------------------|-------------|-------------|
| 1/2-1 | 5/16-1/2 | A | 3 | 3 |
| 1/2-1 | 1/2-5/8 | B | 2 | 2 |

(a) A and B indicate Firestop Configuration, as described in the following:

Firestop Configuration A

- A. **Fill, Void or Cavity Materials* – Wrap Strip** – Nom 1/4 in. thick intumescent elastomeric material faced on one side with aluminum foil, supplied in 2 in. wide strips. One nom 2 in. wide strip tightly-wrapped around ENT (foil side exposed), secured with pressure-sensitive tape or steel wire and slid into through opening such that the top edge is recessed 1/4 in. from top surface of the floor. In wall assemblies the wrap strip layer on the ENT is to be installed in the same manner used for floor assemblies but shall be installed symmetrically on both sides of the wall with the exposed edge of the wrap strip layer recessed 1/4 in. from the wall surface.
3M COMPANY – FS-195+
- B. **Fill, Void or Cavity Material* – Caulk or Sealant** – In floor assemblies, a nom 1/4 in. depth of caulk is to be applied to the top edge of the wrap strip layer and to fill all gaps at the wrap strip/concrete interface. In wall assemblies, the exposed edge of the wrap strip layer and all gaps at the wrap strip/concrete interface are to be covered with a nom 1/4 in. depth of caulk on both sides of the wall.
3M COMPANY – CP 25WB+ caulk or FB-3000 WT sealant.
(Note: W Rating applies only when FB-3000 WT sealant is used.)

Firestop Configuration B

- A. **Forming Material** – Polyethylene backer rod used as a permanent form. In floor assemblies backer rod to be friction-fitted into annular space with its top surface recessed min 1 in. from top surface of the floor. In wall assemblies, backer rod to be friction-fitted into annular space on both sides of wall and recessed min 1 in. from wall surface.
- B. **Fill, Void or Cavity Material* – Caulk or Sealant** – Applied to fill annular space to a min depth of 1 in. In floor assemblies, fill material to be installed flush with top surface of floor. In wall assemblies, fill material to be installed flush with wall surface on both sides of wall.
3M COMPANY – CP 25WB+ caulk or FB-3000 WT sealant.
(Note: W Rating applies only when FB-3000 WT sealant is used.)

++Bearing the UL Listing Mark.

*Bearing the UL Classification Marking.

Reprinted from the Online Certifications Directory with permission from Underwriters Laboratories Inc.
Copyright © 2010 Underwriters Laboratories Inc.®



Note: Systems with Nonmetallic Through Penetrant(s) have not been evaluated with a pressure differential of 50 Pa between the exposed and unexposed surfaces as required by the National Building Code of Canada.

System No. C-AJ-2028

December 14, 1995
 (Formerly System No. 448)
 F Ratings – 2 Hr
 T Ratings – 2 Hr

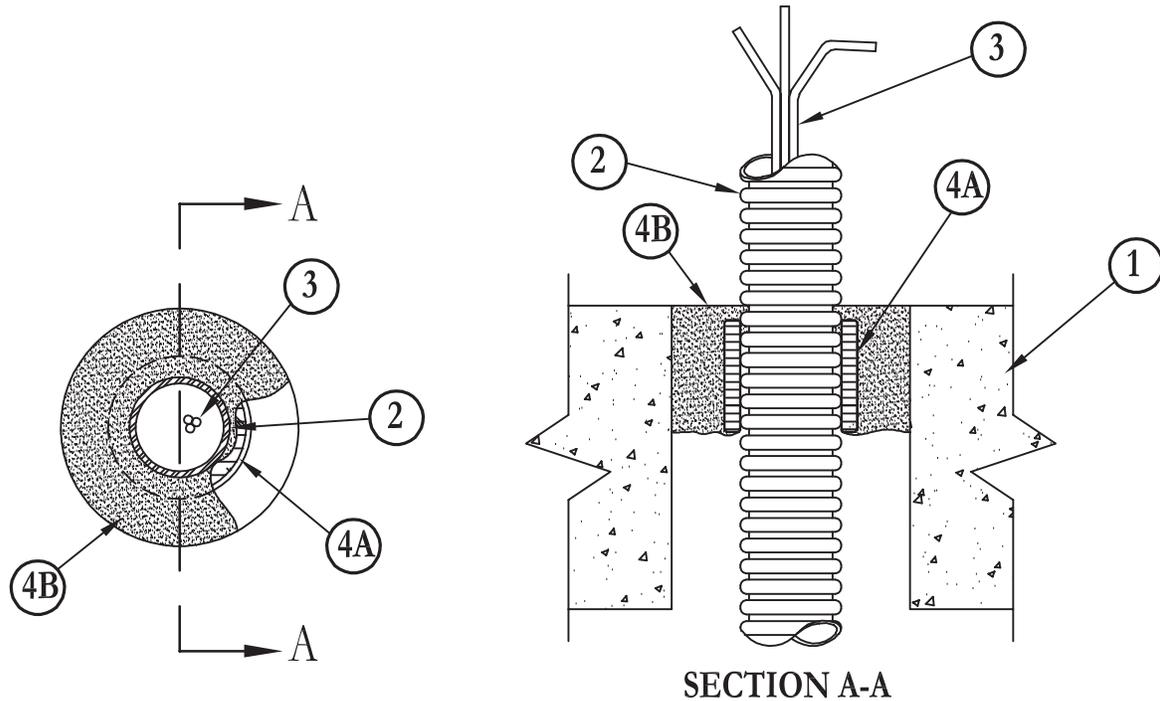

- Floor or Wall Assembly** – Min 4-1/2 in. thick lightweight or normal weight (100-150 pcf) concrete. Wall may also be constructed of any UL Classified **Concrete Blocks***. Max diam of opening not to exceed 4 in.
 See **Concrete Blocks (CAZT)** category in the Fire Resistance Directory for names of manufacturers.
- Electrical Nonmetallic Tubing++** – Nom 1-1/4 in. diam (or smaller) corrugated wall ENT constructed of polyethylene (PE) or nom 2 in. diam (or smaller) corrugated wall ENT constructed of polyvinyl chloride (PVC). ENT to be installed as a complete system with all terminations in junction boxes, outlet boxes or other approved enclosures as specified in the National Electrical Code. A max of one ENT is allowed in the opening. The ends of the ENT shall be sealed with a min 1/4 in. thickness of moldable putty fill material (Item 4B) unless it is determined that the enclosure in which it terminates is relatively air tight and is normally closed. ENT to be rigidly supported on each side of the floor or wall assembly.
 See **Electrical Nonmetallic Tubing (FKHU)** category in Electrical Construction Materials Directory for names of manufacturers.
- Fiber Optic Cables** – Multiple fiber optical communication cables jacketed with PE or PVC and having a max outside diam of 3/4 in. Max cross-sectional area of fiber optic cables in ENT shall not exceed 40 percent.
- Firestop System** – The details of the firestop system shall be as follows:
 - Fill, Void or Cavity Materials* – Wrap Strip** – Nom 1/4 in. thick intumescent elastomeric material faced on one side with aluminum foil, supplied in nom 2 in. wide by 24 in. long strips. Nom 2 in. wide strips tightly-wrapped around ENT (foil side exposed), secured in place with two min 0.062 in. diam (16 gauge) steel tie wires and slid into through opening such that the top edge is recessed 1/4 in. from top surface of the floor. When nom 1-1/4 in. diam (or smaller) ENT is used, a single layer of wrap strip is required. When nom 1-1/2 or 2 in. diam ENT is used, two layers of wrap strip are required. In wall assemblies, wrap strip layer(s) on ENT to be installed in same manner used for floor assemblies but shall be installed symmetrically on both sides of the wall assembly.
3M COMPANY – FS-195+
 - Fill, Void or Cavity Materials* – Putty** – Moldable putty material applied to fill annular space between wrap strip layer(s) and perimeter of through opening to a min depth of 2 in. with an additional 1/4 in. thickness applied over edge(s) of wrap strip layer(s) flush with top surface of floor and both surfaces of wall.
3M COMPANY – MP+ Stix

++Bearing the UL Listing Mark

*Bearing the UL Classification Marking

Reprinted from the Online Certifications Directory with permission from Underwriters Laboratories Inc.
 Copyright © 2010 Underwriters Laboratories Inc.®



Note: This system was tested with a pressure differential of 50 Pa between the exposed and unexposed surfaces with the higher pressure on the exposed side.

System No. C-AJ-2029

December 16, 1995
(Formerly System No. 448-B)
F Rating – 2 Hr
T Rating – 2 Hr

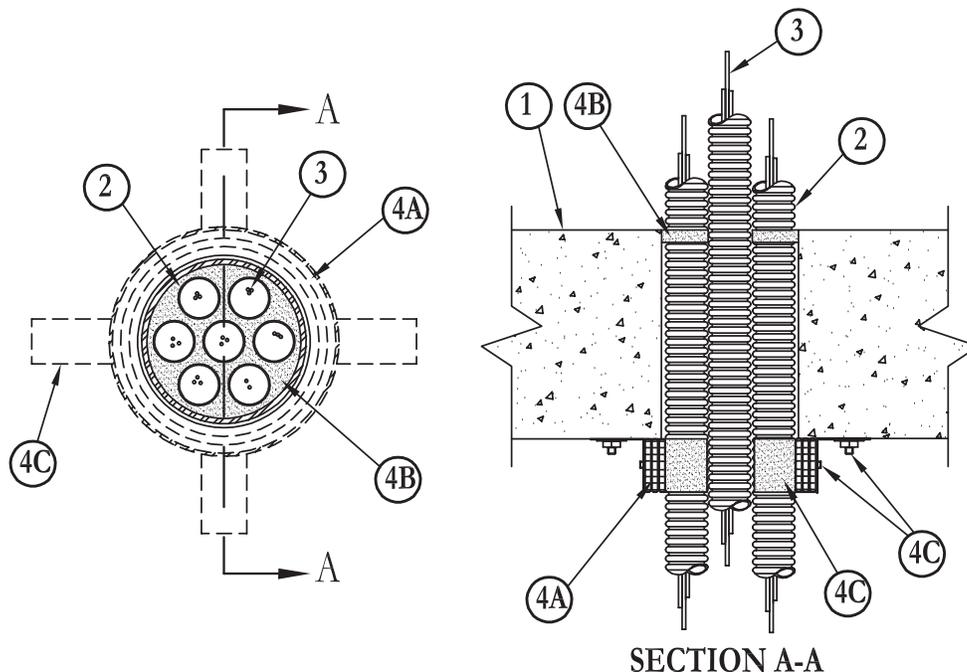

- Floor or Wall Assembly** – Min 4-1/2 in. thick lightweight or normal weight (100-150 pcf) concrete. Wall may also be constructed of any UL Classified **Concrete Blocks***. Max diam of opening not to exceed 5 in.
See **Concrete Blocks (CAZT)** category in the Fire Resistance Directory for names of manufacturers.
- Electrical Nonmetallic Tubing++** – Nom 1-1/4 in. diam (or smaller) corrugated wall ENT constructed of polyethylene (PE) or nom 2 in. diam (or smaller) corrugated wall ENT constructed of polyvinyl chloride (PVC). ENT to be installed as a complete system with all terminations in junction boxes, outlet boxes or other approved enclosures as specified in the National Electrical Code. Individual or multiple (three, four or seven ENT of the same size) ENT may be installed in opening. When individual ENT is installed, max annular space between ENT and edge of circular opening shall be 1/4 in. When multiples of three, four or seven ENT of the same size are installed in the opening, max annular space between the tightly-grouped ENT and the edge of the circular opening is 1/2 in. The ends of each ENT shall be sealed with a min 1/4 in. thickness of moldable putty fill material (Item 4B) unless it is determined that the enclosure in which it terminates is relatively air tight and is normally closed. ENT to be rigidly supported on each side of the floor or wall assembly.
See Electrical Nonmetallic Tubing (FKHU) category in Electrical Construction Materials Directory for names of manufacturers.
- Fiber Optic Cables** – Multiple fiber optical communication cables jacketed with PE or PVC and having a max outside diam of 3/4 in. Max cross-sectional area of fiber optic cables in ENT shall not exceed 40 percent.
- Firestop System** – The details of the firestop system shall be as follows:
 - Fill, Void or Cavity Materials* – Wrap Strip** – Nom 1/4 in. thick intumescent elastomeric material faced on one side with aluminum foil, supplied in nom 2 in. wide by 24 in. long strips. Nom 2 in. wide strips tightly wrapped around individual or tightly-bundled group of ENT (foil side exposed) with the top edges butted against the underside of the concrete floor. Sufficient layers of wrap strip shall be installed to lap a min of 3/16 in. on the concrete around the entire perimeter of the through opening. When a single ENT is installed, a min of one layer of wrap strip is required. When a tightly bundled group of three, four or seven equally sized ENT is installed, a min of three layers of wrap strip is required. Each layer of wrap strip to be installed with butted seam. Butted seams in successive layers staggered. Wrap strip layers temporarily held in position using tape, wire or equivalent. In wall assemblies, wrap strip is to be installed symmetrically on both sides of the wall. Prior to installation of the wrap strip layer(s), moldable putty fill material (Item B) shall be applied to ENT within the 2 in. depth of the wrap strip layers.
3M COMPANY – FS-195+
 - Fill, Void or Cavity Materials* – Putty** – Moldable putty material applied to fill interstices between tightly bundled ENT throughout the 2 in. depth of the wrap strip layers. In floor assemblies, a min 1/4 in. depth of putty shall also be installed in annular space and in interstices between tightly bundled ENT flush with the top surface of the floor.
3M COMPANY – MP+ Stix
 - Steel Collar** – Nom 2 in. deep collar with 1-1/4 wide by 2 in. long anchor tabs and min 3/4 in. tabs to retain wrap strip layers. Coils of precut 0.016 in. thick (No. 30 gauge) galv sheet steel available from wrap strip manufacturer. As an alternate, collar may be field-fabricated from min 0.016 in. thick (No. 30 gauge) galv sheet steel in accordance with instruction sheet supplied by wrap strip manufacturer. Steel collar, with anchor tabs bent outward 90 deg, wrapped tightly around wrap strip layer with min 1 in. overlap at seam. With steel anchor tabs pressed tightly against floor or wall surface, compress collar around wrap strip layers using a min 1/2 in. wide by 0.028 in. thick stainless steel band clamp with worm drive tightening mechanism at the collar midheight. Secure collar to floor or wall surface(s) with min 3/16 in. diam by 1-1/2 in. long steel anchor bolts, or equivalent, in conjunction with 1-1/4 in. diam steel fender

Through Penetrations

Non-Metallic Pipes

2000 Series

Concrete

CAJ

System No. C-AJ-2029 *continued*

washers. Three anchor bolts, symmetrically located, required for steel collars having an outside diam less than 4-1/2 in. Four anchor bolts, symmetrically located, required for steel collars having an outside diam of 4-1/2 in. to 6 in. As a final step, bend retainer tabs 90 deg toward ENT to lock wrap strip layers in position.

- D. **Firestop Device*** (Not shown) – As an alternate to Items A and C for individual or bundled ENT, a firestop device consisting of a sheet-steel split collar lined with intumescent material and provided with steel clips for attachment may be used. Firestop device to be approximately sized to closely conform with outside diam of individual or bundled ENT. Max diam of ENT bundle is 4-1/2 in. Firestop device to be installed on underside of floor or on both sides of wall in accordance with the accompanying installation instructions. Moldable putty fill material (Item B) to be installed to fill annular space and interstices between tightly-bundled ENT throughout the 2 in. depth of the firestop device.

3M COMPANY – PPD 150, PPD 200, PPD 300, PPD 400

++Bearing the UL Listing Mark

*Bearing the UL Classification Marking

Reprinted from the Online Certifications Directory with permission from Underwriters Laboratories Inc.
Copyright © 2010 Underwriters Laboratories Inc.®



Note: This system was tested with a pressure differential of 50 Pa between the exposed and unexposed surfaces with the higher pressure on the exposed side.

Through Penetrations

Non-Metallic Pipes

2000 Series

Concrete

CAJ

System No. C-AJ-2030

May 18, 2005

F Rating – 2 Hr

T Ratings – 0, 1-1/2 and 2 Hr (See Item 4)

L Rating At Ambient – 15 CFM/sq ft (See Item 4B)

L Rating At 400 F – less than 1 CFM/sq ft (See Item 4B)

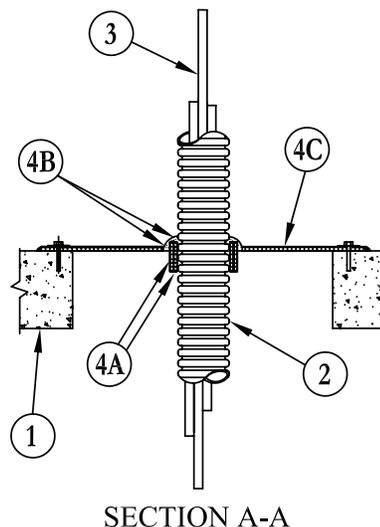
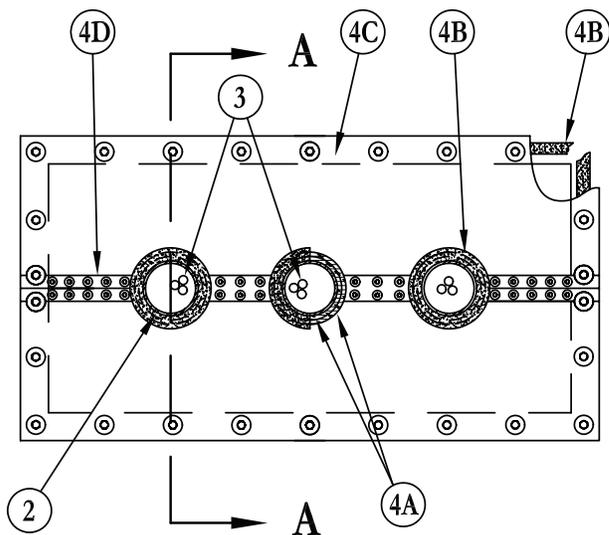

- Floor or Wall Assembly** – Min 4-1/2 in. (114 mm) thick lightweight or normal weight (100-150 pcf or 1600-2400 kg/m³) concrete. Wall may also be constructed of any UL Classified **Concrete Blocks***. Max area of opening not to exceed 240 sq in. (1548 sq cm) with max dimension of 30 in. (762 mm).

See **Concrete Blocks (CAZT)** category in the Fire Resistance Directory for names of manufacturers.

- Electrical Nonmetallic Tubing++** – Nom 1-1/4 in. (32 mm) diam (or smaller) corrugated wall ENT constructed of polyethylene (PE) or nom 2 in. (51 mm) diam (or smaller) corrugated wall ENT constructed of polyvinyl chloride (PVC). ENT to be installed as a complete system with all terminations in junction boxes, outlet boxes or other approved enclosures as specified in the National Electrical Code. The ends of each ENT shall be sealed with a min 1/4 in. (6 mm) thickness of moldable putty fill material (Item 4B) unless it is determined that the enclosure in which it terminates is relatively air tight and is normally closed. A max of twelve ENT may be installed in the through opening. ENT to be rigidly supported on each side of the floor or wall assembly.

See **Electrical Nonmetallic Tubing (FKHU)** category in Electrical Construction Materials Directory for names of manufacturers.

- Fiber Optic Cables** – Multiple fiber optical communication cables jacketed with PE or PVC and having a max outside diam of 3/4 in. (19 mm) Max cross-sectional area of fiber optic cables in ENT shall not exceed 40 percent.
- Firestop System** – The hourly T Rating of the firestop system is dependent upon the firestop orientation (floor or wall) and the firestop configuration, as tabulated below:

| Orientation (a) | Nom ENT Diam In. (mm) | Annular Space In. (mm) | Firestop Config (b) | T Rating Hr |
|--------------------|-----------------------------|------------------------------|---------------------------|-------------------|
| F | 1 to 1-1/4 (25 to 32) | 1/2 to 27 (13 to 686) | A | 0 |
| W, F | 1 to 2 (25 to 51) | 1/2 to 27 (13 to 686) | B | 1-1/2 or 2 |

(a) W = Wall, F = Floor

(b) A and B indicate Firestop Configuration, as described in the following.

Firestop Configuration A

- Fill, Void or Cavity Materials* – Wrap Strip** – Nom 1/4 in. (6 mm) thick intumescent elastomeric material faced on one side with aluminum foil, supplied in nom 2 in. (51 mm) wide by 24 in. (610 mm) long strips. Nom 2 in. (51 mm) wide strip(s) tightly wrapped around ENT (foil side exposed) and secured in place with two min 0.062 in. (1.6 mm) diam (16 gauge) steel tie wires. When nom 1-1/4 in. (32 mm) diam (or smaller) ENT is used, a single layer of wrap strip is required. When nom 1-1/2 in. or 2 in. (38 mm or 51 mm) diam ENT is used, two layers of wrap strip are required. Wrap strip layer(s) on ENT to extend approx 7/8 in. (22 mm) into through opening on top surface of floor such that, when intumescent sheet (Item C) is installed, the top edges of the wrap strip layer(s) extend approx 7/8 in. (22 mm) above the top surface of the intumescent sheet.

3M COMPANY – FS-195+

- Fill, Void or Cavity Materials* – Graphite Seal, Caulk, Sealant or Putty** – One layer of 1/2 in. x 1/16 in. (13 mm x 1.6 mm) adhesive backed graphite intumescent seal positioned under intumescent sheet around entire perimeter of through opening or min 1/4 in. (6 mm) diam continuous bead of caulk or putty applied to edge of intumescent sheet at its interface with surface of floor or wall around entire perimeter of through opening. Rope of putty or bead of caulk applied to perimeter of wrap strip around ENT at interface with intumescent sheet. Additional putty or caulk applied to cover exposed top edge(s) of wrap strip layer(s) around perimeter of ENT.

3M COMPANY – E-FIS or Ultra GS seals, CP 25WB+, IC 15WB+ caulk, FB-3000 WT sealant or MP+ Stix putty.

System No. C-AJ-2030 *continued*

- C. **Fill, Void or Cavity Materials* – Intumescent Sheet** – Rigid aluminum foil faced sheet with galv sheet steel backer. Diam of circular cutout in sheet to accommodate each ENT to closely follow contour of wrap strip (Item A) on ENT. When more than one ENT is installed in through opening, the min separation between cutouts made in the sheet to accommodate each individual ENT is 2 in. (51 mm). Sheet cut to lap a min of 2 in. (51 mm) on the concrete on all sides of the through opening. Sheet to be installed with the galv sheet steel backer exposed (aluminum foil face against top surface of floor). Sheet secured to top surface of floor using min 3/16 in. (5 mm) diam by 1-1/2 in. (38 mm) long steel expansion bolts, or equivalent, in conjunction with 1-1/4 in. (32 mm) diam steel fender washer. Max spacing of fasteners not to exceed 6 in. (152 mm) OC with additional fasteners located on each side of butted seam or slit made to permit installation of the sheet around each ENT.

3M COMPANY – CS-195+

- D. **Steel Cover Strip** – Min 2 in. (51 mm) wide strip of min 0.020 in. (0.51 mm) thick (26 gauge) galv steel centered over entire length of seam or slit made in intumescent sheet (Item C) to permit installation about the ENT(s). Steel cover strip secured to galv steel sheet backer of intumescent sheet with steel sheet metals screws spaced max 2 in. (51 mm) OC on each side of seam or slit.

Firestop Configuration B (Not Shown)

- A. **Fill, Void or Cavity Materials* – Wrap Strip** – Same as Item A, Firestop Configuration A, except that wrap strip layers are installed on ENT symmetrically on both sides of the floor or wall assembly.

3M COMPANY – FS-195+

- B. **Fill, Void or Cavity Materials* – Graphite Seal, Caulk, Sealant or Putty** – Same as Item B, Firestop Configuration A, except that seal, caulk or putty is used on both sides of the floor or wall assembly. **When MP+ Stix putty is used, T Rating is 1-1/2 hr. When CP 25WB+ caulk or GIS seal is used, T Rating is 2 hr.**

3M COMPANY – E-FIS or Ultra GS seals, CP 25WB+, IC 15WB+ caulk, FB-3000 WT sealant or MP+ Stix putty.

- C. **Fill, Void or Cavity Materials* – Intumescent Sheet** – Same as Item C, Firestop Configuration A, except that the intumescent sheets are installed symmetrically on both sides of the floor or wall assembly.

3M COMPANY – CS-195+

- D. **Steel Cover Strip** – Same as Item D, Firestop Configuration A. Steel cover strips required over seams or slits in intumescent sheets (Item C) on both sides of the floor or wall assembly.

*Bearing the UL Classification Marking

++Bearing the UL Listing Mark.

Reprinted from the Online Certifications Directory with permission from Underwriters Laboratories Inc.

Copyright © 2010 Underwriters Laboratories Inc.®



Note: Systems with Nonmetallic Through Penetrant(s) have not been evaluated with a pressure differential of 50 Pa between the exposed and unexposed surfaces as required by the National Building Code of Canada.

Through Penetrations

Non-Metallic Pipes

2000 Series

Concrete

CAJ

System No. C-AJ-2044

September 03, 2004

(Formerly System No. 395)

F Rating – 3 Hr

T Rating – 3 Hr

L Rating At Ambient – 7 CFM per sq ft

L Rating At 400 F – less than 1 CFM per sq ft

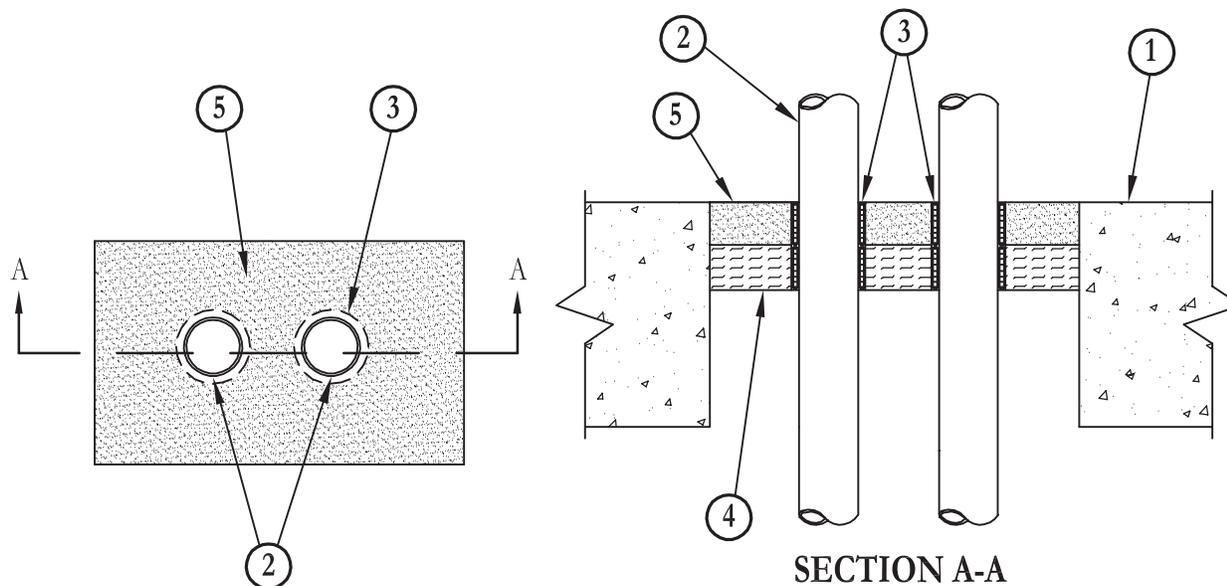

1. **Floor or Wall Assembly** – Min 4-1/2 in. (114 mm) thick lightweight or normal weight (100-150 pcf or 6400-2400 kg/m³) concrete. Wall may also be constructed of any UL Classified **Concrete Blocks***. Max area of square, rectangular or circular opening is 45 in.² (290cm²) with max dimension of 9 in. (229 mm).

See **Concrete Blocks** (CAZT) category in the Fire Resistance Directory for names of manufacturers.

2. **Nonmetallic Pipe** – Nom 1-1/2 in. (38 mm) diam (or smaller) Schedule 40 polyvinyl chloride (PVC) pipe in closed (process or supply) or vented (drain, waste or vent) piping systems. One or more pipes may be installed with a min 1/2 in. to max 1 in. (13 mm to 25 mm) clearance maintained between pipes and with a min 1/4 in. to max 1 in. (6 mm to 25 mm) clearance maintained between pipe and sides of through opening. Pipes to be rigidly supported on both sides of floor or wall assembly.
3. **Fill, Void or Cavity Materials* – Wrap Strip** – Nom 1/4 in. (6 mm) thick intumescent elastomeric material faced on one side with aluminum foil, supplied in 2 in. (51 mm) wide strips. One nom 2 in. (51 mm) wide strip tightly-wrapped around PVC pipe with the foil side exposed and slid into through opening such that the top edge is flush with top surface of floor. The wrap strip layer shall be secured in place with min No. 18 gauge galv steel tie wire. In wall assemblies, the wrap strip layer is to be installed on the PVC pipe in the same manner used for floor assemblies but shall be installed symmetrically on both sides of the wall.

3M COMPANY – FS-195+

4. **Packing Material** – Min 1 in. (25 mm) thick mineral wool batt insulation firmly packed into opening with its top surface recessed min 1 in. (25 mm) from top surface of the floor. In wall assemblies, forming material to be firmly packed into opening on both sides of wall and recessed min 1 in. (25 mm) from wall surface.
5. **Fill, Void or Cavity Materials* – Caulk or Sealant** – Applied to fill through opening to a min depth of 1 (25 mm) in. In floor assemblies, fill material to be installed flush with top surface of floor. In wall assemblies, fill material to be installed flush with wall surface on both sides of wall.

3M COMPANY – CP 25WB+ caulk or FB-3000 WT sealant.

*Bearing the UL Classification Mark

Reprinted from the Online Certifications Directory with permission from Underwriters Laboratories Inc.

Copyright © 2010 Underwriters Laboratories Inc.®



Note: Systems with Nonmetallic Through Penetrant(s) have not been evaluated with a pressure differential of 50 Pa between the exposed and unexposed surfaces as required by the National Building Code of Canada.

System No. C-AJ-2117

November 20, 2009

F Rating – 3 Hr

T Rating – 2 Hr

L Rating at Ambient – 7 CFM/sq ft (See Item 3B)

L Rating at 400 F – 1 CFM/sq ft (See Item 3B)

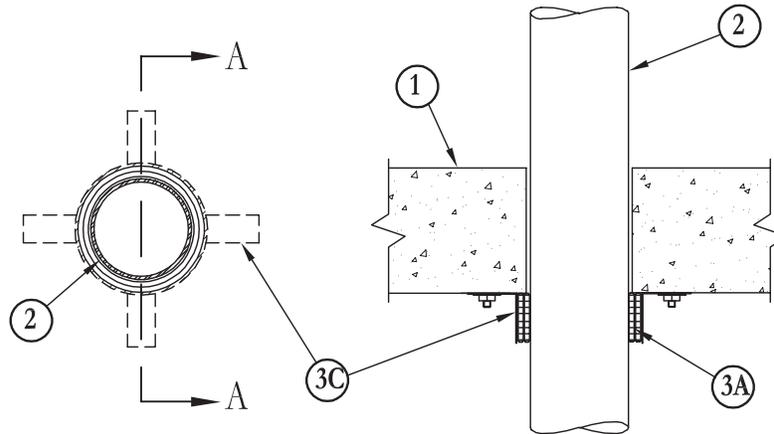

SECTION A-A

- Floor or Wall Assembly** – Lightweight or normal weight (100-150 pcf or 1600- 2400 kg/m³) concrete. Min thickness of solid concrete floor or wall assembly is 4-1/2 in. (114 mm). Wall may also be constructed of any UL Classified **Concrete Blocks***. Diam of opening to be max 1/2 in. (13 mm) larger than diam of nonmetallic pipe (Item 2). Max diam of opening is 5 in. (127 mm).
See **Concrete Blocks (CAZT)** category in Fire Resistance Directory for names of manufacturers.
- Nonmetallic Pipe** – Nom 4 in. (102 mm) diam (or smaller) Schedule 40 solid-core polyvinyl chloride (PVC) pipe for use in closed (process or supply) or vented (drain, waste or vent) piping systems or SDR13.5 chlorinated polyvinyl chloride (CPVC) pipe for use in closed (process or supply) piping systems. A max of one nonmetallic pipe is permitted in the firestop system. The pipe shall be centered in the through opening. Pipe to be rigidly supported on both sides of wall or floor assembly.
- Firestop System** – The details of the firestop system shall be as follows:

A. **Fill, Void or Cavity Materials* – Wrap Strip** – Nom 1/4 in. (6 mm) thick intumescent elastomeric material faced on one side with aluminum foil, supplied in 2 in. (51 mm) wide strips. Nom 2 in. (51 mm) wide strips tightly wrapped around nonmetallic pipe (foil side exposed) with the top edges butted against the underside of the concrete floor. Sufficient layers of wrap strip shall be installed to lap a min of 3/16 in (5 mm). on the concrete around the entire perimeter of the through opening. For nom 1/2 in. (13 mm) to nom 1-1/2 in. (38 mm) diam pipes, a min of one layer of wrap strip is required. For nom 2, 2-1/2 and 3 in. (51, 64 and 76 mm) diam pipes, a min of two layers of wrap strip is required. For nom 3-1/2 and 4 in. (89 and 102 mm) diam pipes, a min of three layers of wrap strip is required. Each layer of wrap strip to be installed with butted seam with butted seams in successive layers staggered. Wrap strip layers temporarily held in position using aluminum foil tape, steel wire tie, or equivalent. In wall assemblies, the wrap strip is to be installed in the same manner used for floor assemblies, but it shall be installed symmetrically on both sides of the wall assembly.

3M COMPANY – FS-195+

B. **Fill, Void or Cavity Materials* – Caulk, Sealant or Putty** – (Not Shown) – Generous bead of caulk or putty to be applied to outer perimeter of wrap strip at its interface with floor or wall surface(s).

3M COMPANY – CP 25WB+ caulk, FB-3000 WT sealant, MP+ putty, IC 15WB+ caulk or FireDam 150+ caulk

(Note: L Ratings apply only when Type CP 25WB+ or FB-3000 WT is used. CP 25WB+ and FireDam 150+ not suitable for use with CPVC pipes.)

C. **Steel Collar** – Nom 2 in. (51 mm) deep collar with 1-1/4 in. (32 mm) wide by 2 in. (51 mm) long anchor tabs and min 1/2 in. (13 mm) long tabs to retain wrap strip layers. Coils of precut 0.016 in. (0.41 mm) thick (30 gauge) galv sheet steel available from wrap strip manufacturer. As an alternate, collar may be field-fabricated from min 0.016 in. (0.41 mm) thick (30 gauge) galv sheet steel in accordance with instruction sheet supplied by wrap strip manufacturer. Steel collar, with anchor tabs bent outward 90 deg, wrapped tightly around wrap strip layers with min 1 in. (25 mm) overlap at seam. With steel collar anchor tabs pressed tightly against floor or wall surface(s), compress collar around wrap strip layers using a min 1/2 in. (13 mm) wide by 0.028 in. (0.71 mm) thick stainless steel band clamp with worm drive tightening mechanism at the collar midheight. Secure collar to floor or wall surface(s) with 1/4 in. (6 mm) diam by min 1-1/2 in. (38 mm) long steel expansion bolts, or equivalent, in conjunction with steel nuts and min 1-1/4 in. (32 mm) diam steel fender washers. Two anchor bolts, symmetrically located, are required for nom 1/2 in. (13 mm) to nom 2 in. (51 mm) diam pipes. Three anchor bolts, symmetrically located, are required for nom 3 in. (76 mm) diam pipes. Four anchor bolts, symmetrically located, are required for nom 3-1/2 and 4 in. (89 and 102 mm) diam pipes. As a final step, bend retainer tabs 90 deg toward pipe to lock wrap strip layers in position.

D. **Firestop Device*** – As an alternate to Items A and C when nom 1-1/2, 2, 3 or 4 in. (38, 51, 76 or 102 mm) diam nonmetallic pipe is used, a firestop device consisting of a sheet-steel split collar lined with intumescent material and provided with steel clips for attachment may be used. Firestop device to be installed on underside of floor or on both sides of wall in accordance with the accompanying installation instructions.

3M COMPANY – Types PPD 150, PPD 200, PPD 300, PPD 400.

*Bearing the UL Classification Mark

Reprinted from the Online Certifications Directory with permission from Underwriters Laboratories Inc.

Copyright © 2011 Underwriters Laboratories Inc.®

System No. C-AJ-2133

May 18, 2005

F Rating – 2 Hr

T Rating – 1-3/4 & 2 Hr (See Item 2)

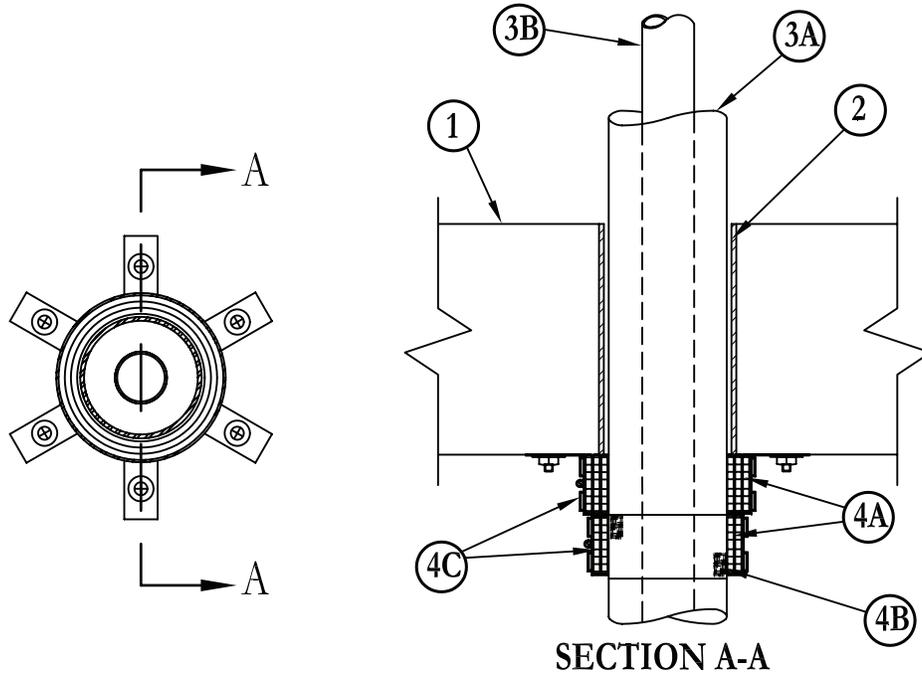

1. **Floor or Wall Assembly** – Min 4-1/2 in. (114 mm) thick reinforced lightweight or normal weight (100-150 pcf or 1600-2400 kg/m³) concrete. Wall may also be constructed of any UL Classified **Concrete Blocks***.
See **Concrete Blocks (CAZT)** category in the Fire Resistance Directory for names of manufacturers.
2. **Metallic Sleeve** – Max 8 in. (203 mm) ID (or smaller) Schedule 10 (or heavier) steel pipe cast or grouted into floor or wall assembly, flush with floor or wall surfaces.
3. **Through Penetrants** – One nonmetallic pipe installed within one nonmetallic pipe and centered within the firestop system. The space between outer pipe and metallic sleeve shall be min 1/16 in. to max 3/8 in. (1.6 mm to 10 mm). The inner pipe shall be centered within the outer pipe. Nonmetallic spacers shall be used to maintain the inner pipe within the center of the outer pipe at a distance no closer than 10 in. (254 mm) from the bottom of floor surface or both wall surfaces. The nom diam of the inner pipe shall be one half the nom diam of the outer pipe. The outer pipe to be rigidly supported on both sides of the floor or wall assembly. The following types and sizes of nonmetallic pipes described in Item A may be used for the outer pipe and the following types and sizes of nonmetallic pipes described in Items B and C may be used for the inner pipe:
 - A. **Polypropylene (PP) Pipe** – Nom 4 in., 6 in. or 8 in. (102 mm, 152 mm or 203 mm) diam SDR 32.5 PP pipe for use in closed (process or supply) or vented (drain, waste or vent) piping system.
 - B. **Polypropylene (PP) Pipe** – Nom 2 in., 3 in. or 4 in. (51 mm, 76 mm or 102 mm) diam SDR 11 PP pipe for use in closed (process or supply) or vented (drain, waste or vent) piping system.
 - C. **Polyvinylidene Fluoride (PVDF) Pipe** – Nom 2 in. (51 mm) diam SDR 11, or nom 3 in. or 4 in. (76 mm or 102 mm) diam SDR 32.5 PVDF pipe for use in closed (process or supply) or vented (drain, waste or vent) piping system.

The T Rating is 1-3/4 Hr when nom 4 in. (102 mm) diam pipe is used as the outer pipe. The T Rating is 2 Hr when nom 6 in. or 8 in. (152 mm or 203 mm) diam pipes are used as the outer pipe.
4. **Firestop System** – The details of the firestop system shall be as follows:
 - A. **Fill, Void or Cavity Materials* – Wrap Strip** – Nom 1/4 in. (6 mm) thick intumescent elastomeric material faced on one side with aluminum foil, supplied in 2 in. (51 mm) wide strips. Strips tightly wrapped around outer nonmetallic pipe (foil side exposed). Multiple stacks of multiple layers to be butted tightly together with the first layer butted tightly against the bottom surface of the floor or both surfaces of the wall. The min number of layers and stacks of layers required is dependent upon the nom diam of the outer pipe, as shown in the following table:

| Outer Pipe Nom Diam In. (mm) | No. of Wrap Stack | No. of Wrap Strip Layers For 1st Stack | No. of Wrap Strip Layers For 2nd Stack | No. of Wrap Strip Layers For 2nd Stack |
|------------------------------|-------------------|--|--|--|
| 4 (102) | 2 | 4 | 2 | N/A |
| 6 (152) | 3 | 4 | 3 | 2 |
| 8 (203) | 3 | 5 | 4 | 3 |

3M COMPANY – FS-195+

System No. C-AJ-2133 *continued*

- B. Foil Tape** – Nom 4 in. (102 mm) wide, 3 mil thick aluminum tape wrapped around pipe prior to the installation of the last stack of wrap strip (Item 3A). Min of one wrap, flush with the bottom of the next to last stack of wrap strip and proceeding downward. In wall assemblies, the foil shall be installed on both sides of the wall, flush with the next to last stack of wrap strip and proceeding outward.
- C. Steel Collars** – Nom 2 in. (51 mm) deep collars with 1-1/4 in. (32 mm) wide by 2 in. (51 mm) long anchor tabs and min 1 in. (25 mm) long tabs to retain wrap strip layers. Coils of pre-cut min 0.016 in. (0.41 mm) thick (28 gauge) galv sheet steel available from wrap strip manufacturer. As an alternate, collar may be field-fabricated from min 0.016 in. (0.41 mm) thick (28 gauge) galv sheet steel in accordance with instruction sheet supplied by wrap strip manufacturer. Steel collar, with anchor tabs bent outward 90 degrees, wrapped tightly around each stack of wrap strip layers with min 1 in. (25 mm) overlap at seam. Anchor tabs for collar over first stack of wrap strip layers to be pressed tightly against floor or wall surface(s), and compressed around wrap strip layers using a min 1/2 in. (13 mm) wide by 0.028 in. (0.71 mm) thick stainless steel band clamp at the collar midheight. Collar to be secured to floor or wall surface(s) with 1/4 in. (6 mm) diam by min 1-1/2 in. (38 mm) long steel expansion bolts, or equivalent, in conjunction with steel nuts and min 1-1/4 in. (32 mm) diam steel fender washers. Anchor bolts to be used with every anchor tab. Retainer tabs to be bent 90 degrees toward pipe to lock wrap strip layers in position. Anchor tabs for collar over second and third stack (if third stack is required) of wrap strip layers to be pressed tightly against preceding collar and compressed around wrap strip layers using a min 1/2 in. (13 mm) wide by 0.028 in. (0.71 mm) thick stainless steel band clamp at the collar midheight. Anchor tabs to be bent 90 degrees outward and then 90 degrees upward, tightly against the preceding collar, and secured to the preceding collar using 1/2 in. (13 mm) long No. 10 sheet metal screws. Anchor screws to be used with every anchor tab. Retainer tabs 90 degrees toward pipe to lock wrap strip layers in position.
- D. Fill, Void or Cavity Materials* – Caulk, Sealant or Putty** – (Not Shown/Not Required) – Generous bead of caulk or putty may be applied to outer perimeter of wrap strip at its interface with floor or wall surface(s).
- 3M COMPANY** – CP 25WB+, IC 15WB+, FireDam 150+ caulk, FB-3000 WT sealant or MP+ Stix putty.

*Bearing the UL Classification Marking

Reprinted from the Online Certifications Directory with permission from Underwriters Laboratories Inc.
Copyright © 2011 Underwriters Laboratories Inc.®

Through Penetrations

Non-Metallic Pipes

2000 Series

Concrete

CAJ

System No. C-AJ-2143

November 20, 2009

F Rating – 2 Hr

T Rating – 1/4 Hr

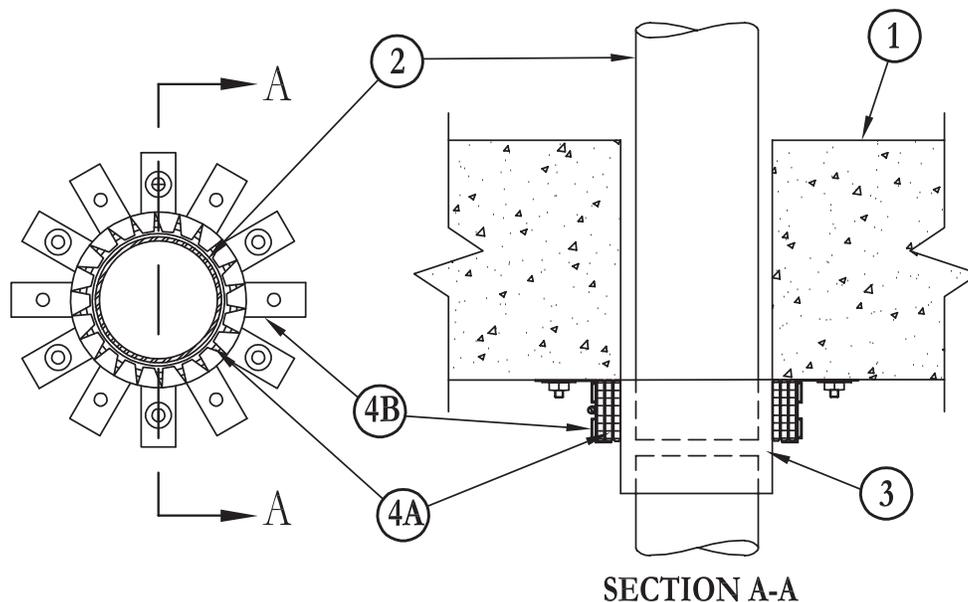

1. **Floor or Wall Assembly** – Min 4-1/2 in. (114 mm) thick lightweight or normal weight (100-150 pcf or 1600 - 2400 kg/m³) concrete. Wall may also be constructed of any UL Classified **Concrete Blocks***. Diam of opening through floor or wall to be 1/2 to 5/8 in. (13 to 16 mm) larger than the outside diam of through-penetrant (Item 2). Max diam of opening is 5 in. (127 mm).

See **Concrete Blocks (CAZT)** category in the Fire Resistance Directory for names of manufacturers.

2. **Through Penetrants** – One nonmetallic pipe or conduit centered in the through opening. Pipe or conduit to be rigidly supported on both sides of floor or wall assembly. The following types and sizes of nonmetallic pipes or conduits may be used.
 - A. **Polyvinyl Chloride (PVC) Pipe** – Nom 4 in. (102 mm) diam (or smaller) Schedule 40 solid core PVC pipe for use in closed (process or supply) or vented (drain, waste or vent) piping system.
 - B. **Rigid Nonmetallic Conduit+** – Nom 4 in. (102 mm) diam (or smaller) Schedule 40 PVC conduit installed in accordance with Article 347 of the National Electrical Code (NFPA No. 70).
 - C. **Chlorinated Polyvinyl Chloride (CPVC) Pipe** – Nom 4 in. (102 mm) diam (or smaller) SDR13.5 CPVC pipe for use in closed (process or supply) piping systems.
3. **Nonmetallic Pipe Coupling** – Nom 4 in. (102 mm) diam (or smaller) Schedule 40 PVC pipe coupling or nom 4 in. (102 mm) diam (or smaller) SDR13.5 CPVC pipe coupling installed such that the top of the coupling is flush with the bottom surface of the floor assembly or flush with either side of the wall assembly and extending outward.
4. **Firestop System** – The details of the firestop system shall be as follows:

- A. **Fill, Void or Cavity Materials* – Wrap Strip** – Nom 1/4 in. (6 mm) thick intumescent elastomeric material faced on one side with aluminum foil, supplied in 2 in. (51 mm) wide strips. Min four layers of wrap strips tightly wrapped around nonmetallic pipe coupling (foil side exposed) with the top edges butted against the underside of the floor. In wall assemblies, a min four layers of wrap strips tightly wrapped around nonmetallic pipe coupling (foil side exposed) and butted tightly against outer surface of wall. For the pipe or conduit on the side of the wall opposite the pipe coupling, the wrap strips shall be wrapped tightly around the pipe or conduit and butted tightly against outer surface of wall. For nom 1/2 in. (13 mm) to nom 1-1/2 in. (38 mm) diam pipes or conduits, a min of one layer of wrap strip is required. For nom 2, 2-1/2 and 3 in. (51, 64 and 76 mm) diam pipes or conduits, a min of two layers of wrap strip is required. For nom 3-1/2 and 4 in. (89 and 102 mm) diam pipes or conduits, a min of three layers of wrap strip is required. Each layer of wrap strip to be installed with butted seam, with butted seams in successive layers staggered. Wrap strip layers temporarily held in position using aluminum foil tape, steel wire tie or equivalent.

3M COMPANY – FS-195+

- B. **Steel Collar** – Nom 2 in. (51 mm) deep collar with 1-1/4 in. (32 mm) wide by 2 in. (51 mm) long anchor tabs and min 1/2 in. (13 mm) long tabs to retain wrap strip. Coils of precut min 0.016 in. (0.41 mm) thick (28 gauge) galv sheet steel available from wrap strip manufacturer. As an alternate, collar may be field-fabricated from min 0.016 in. (0.41 mm) thick (28 gauge) galv sheet steel in accordance with instruction sheet supplied by wrap strip manufacturer. Collar, with anchor tabs bent outward 90 degrees, wrapped tightly around wrap strip with min 1 in. (25 mm) overlap at seam and compressed around wrap strip(s) using a min 1/2 in. (13 mm) wide by min 0.028 in. (0.71 mm) thick stainless steel band at the collar midheight. Collar anchor tabs pressed tightly against floor or wall surface(s) and secured to floor or wall surface(s) with 1/4 in. (6 mm) diam by min 1-1/2 in. (38 mm) long steel expansion bolts or equivalent in conjunction with steel nuts and min 1-1/4 in. (32 mm) diam steel fender washers. Min of five anchor bolts used for collar installed around pipe coupling. For the collars installed around pipes or conduits in wall assemblies on the side opposite the pipe coupling, a min of two anchor bolts are required for nom 1/2 to 2 in. (13 to 51 mm) pipes or conduits, a min of three anchor bolts for nom 2-1/2 and 3 in. (64 and 76 mm) pipes or conduits and a min of four anchor bolts for nom 3-1/2 and 4 in. (89 and 102 mm) pipes or conduits, symmetrically located. Retainer tabs bent 90 degrees toward pipe to lock wrap strip(s) in position.

Through Penetrations

Non-Metallic Pipes

2000 Series

Concrete

CAJ

System No. C-AJ-2143 *continued*

C. **Fill, Void or Cavity Materials* – Caulk, Sealant or Putty** (Optional, not required) – Bead of caulk or putty may be applied to outer perimeter of steel collar at its interface with floor or wall surface(s). In floor assemblies, a bead of caulk may be used within the annular space on the top side of the floor.

3M COMPANY – CP-WB+ caulk, FB-3000 WT sealant, MP+ Stix putty, IC 15WB+ caulk or FireDam 150+ caulk.
(Note: CP 25WB+ and FireDam 150+ not suitable for use with CPVC pipes.)

*Bearing the UL Classification Marking

Reprinted from the Online Certifications Directory with permission from Underwriters Laboratories Inc.
Copyright © 2011 Underwriters Laboratories Inc.®

Through Penetrations

Non-Metallic Pipes

2000 Series

Concrete

CAJ

System No. C-AJ-2144

July 30, 2010
F Rating – 2 HR
T Rating – 1/4 HR

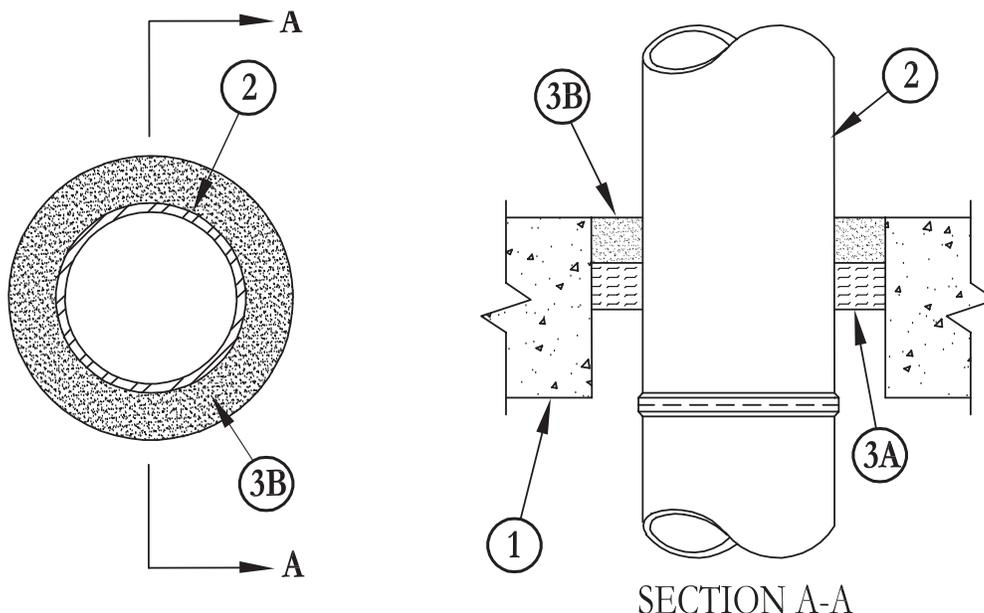

1. **Floor or Wall Assembly** – Min 4-1/2 in. (114 mm) thick lightweight or normal weight (100-150 pcf or 1778 - 2400 kg/m³) concrete. Wall may also be constructed of any UL Classified **Concrete Blocks***. Wall may also be constructed of any UL Classified **Concrete Blocks***. Opening to be 2 in. (51 mm) larger than the nominal diam of glass pipe (Item 2).

See **Concrete Blocks** (CAZT) category in the Fire Resistance Directory for names of manufacturers.

2. **Through Penetrating Products* – Glass Pipe** – Nom 6 in. (152 mm) diam (or smaller) glass pipe centered in opening, for use in closed (process or supply) or vented (drain, waste or vent) piping systems. Max one pipe per opening. Pipe to be rigidly supported on both sides of wall or floor assembly. Pipe connections to be located a min 3 in. (76 mm) from wall or floor surfaces.

SCHOTT NORTH AMERICA INC

3. **Firestop System** – The details of the firestop system shall be as follows:
 - A. **Packing Material** – Min 1 in. (25 mm) thickness of min 4 pcf (64 kg/m³) mineral wool batt insulation firmly packed into opening as a permanent form. Packing material to be recessed from top surface of floor or from both surfaces of wall as required to accommodate the required thickness of fill material.
 - B. **Fill, Void or Cavity Material* – Caulk** – Min 1 in. (25 mm) thickness of caulk applied within the annulus, flush with the top surface of the floor or both surfaces of wall.

3M COMPANY – CP 25WB+

*Bearing the UL Classification Marking

Reprinted from the Online Certifications Directory with permission from Underwriters Laboratories Inc.
Copyright © 2011 Underwriters Laboratories Inc.®

Through Penetrations

Non-Metallic Pipes

2000 Series

Concrete

CAJ

System No. C-AJ-2161

May 20, 2005

F Rating – 2 Hr

T Rating – 2 Hr

W Rating – Class I (See Item 3)

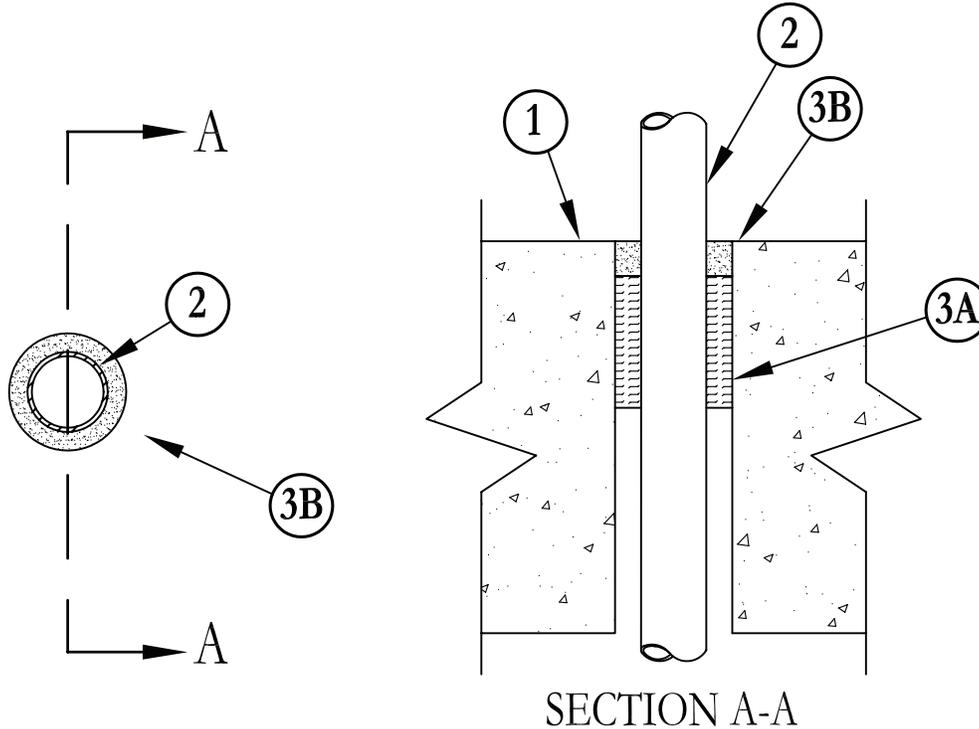

- Floor or Wall Assembly** – Min 4-1/2 in. (114 mm) thick reinforced lightweight or normal weight (100-150 pcf or 1600-2400 kg/m³) concrete. Wall may also be constructed of any UL Classified **Concrete Blocks***. Diam of opening through floor or wall to be 1/2 to 5/8 in. (13 mm to 16 mm) larger than the outside diam of through-penetrant (Item 2). Max diam of opening is 3 in. (76 mm).
See **Concrete Blocks (CAZT)** category in the Fire Resistance Directory for names of manufacturers.
- Through Penetrants** – One nonmetallic pipe or conduit to be centered within the firestop system. Pipe or conduit to be rigidly supported on both sides of floor or wall assembly. The following types and sizes of nonmetallic pipes or conduits may be used.
 - Polyvinyl Chloride (PVC) Pipe** – Nom 2 in. (51 mm) diam (or smaller) Schedule 40 solid core PVC pipe for use in closed (process or supply) piping system.
 - Rigid Nonmetallic Conduit+** – Nom 2 in. (51 mm) diam (or smaller) Schedule 40 PVC conduit installed in accordance with Article 347 of the National Electrical Code (NFPA No. 70).
 - Chlorinated Polyvinyl Chloride (CPVC) Pipe** – Nom 2 in. (51 mm) diam (or smaller) SDR13.5 CPVC pipe for use in closed (process or supply) piping systems.
- Firestop System** – The details of the firestop system shall be as follows:
 - Packing Material** – Nom 2 in. (51 mm) thickness of min 4 pcf (64 kg/m³) mineral wool batt insulation or ceramic (alumina silica) fiber blanket firmly packed into opening as a permanent form. Packing material to be recessed from top surface of floor or both surfaces of wall as required to accommodate the required thickness fill material.
 - Fill, Void or Cavity Material* – Caulk or Sealant** – Min 1/2 in. (13 mm) thickness of fill material applied within the annulus, flush with top surface of floor or with both surfaces of wall.
3M COMPANY – CP 25WB+ caulk or FB-3000 WT sealant.
(Note: W Rating applies only when FB-3000 WT sealant is used. CP 25WB+ not suitable for use with CPVC pipes.)

*Bearing the UL Classification Marking

Reprinted from the Online Certifications Directory with permission from Underwriters Laboratories Inc.
Copyright © 2010 Underwriters Laboratories Inc.®

System No. C-AJ-2189

November 20, 2009

F Rating – 2 Hr

T Ratings – 0 & 2 Hr (See Item 2)

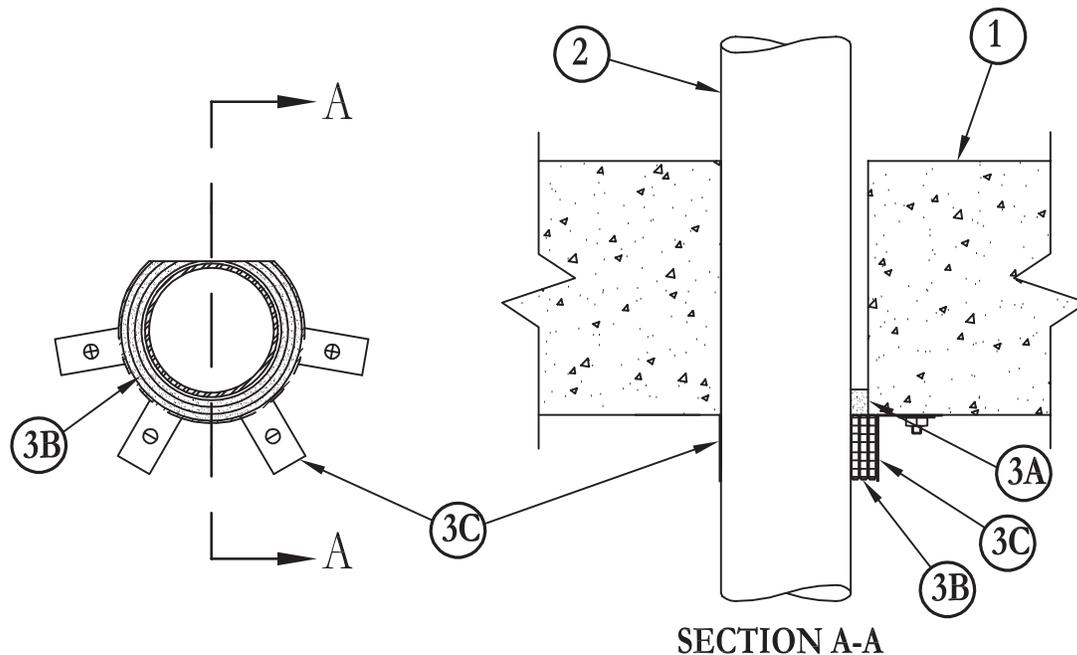

- Floor or Wall Assembly** – Min 4-1/2 in. (114 mm) thick lightweight or normal weight (100-150 pcf or 1600 - 2400 kg/m³) concrete. Wall may also be constructed of any UL Classified **Concrete Blocks***. Max diam of opening is 5 in. (127 mm).
See **Concrete Block** (CAZT) category in the Fire Resistance Directory for names of manufacturers.
- Through Penetrants** – One nonmetallic pipe or conduit to be installed eccentrically within the firestop system. The annular space shall be min 0 in. (0 mm) (point contact) to max 5/8 in. (16 mm) for nom 2 in. (51 mm) diam penetrants and smaller, or min 0 in. (0 mm) (point contact) to max 1/2 in. (13 mm) for penetrants larger than nom 2 in. (51 mm) diam. Pipe or conduit to be rigidly supported on both sides of floor or wall assembly. The following types and sizes of nonmetallic pipes or conduits may be used:
 - Polyvinyl Chloride (PVC) Pipe** – Nom 4 in. (102 mm) diam (or smaller) Schedule 40 solid core PVC pipe for use in closed (process or supply) or vented (drain, waste or vent) piping system.
 - Rigid Nonmetallic Conduit++** – Nom 4 in. (102 mm) diam (or smaller) Schedule 40 PVC conduit installed in accordance with Article 347 of the National Electrical Code (NFPA No. 70).
 - Chlorinated Polyvinyl Chloride (CPVC) Pipe** – Nom 4 in. (102 mm) diam (or smaller) SDR13.5 CPVC pipe for use in closed (process or supply) piping system.
 - Cellular Core Polyvinyl Chloride (ccPVC) Pipe** – Nom 3 in. (76 mm) diam (or smaller) Schedule 40 cellular core PVC pipe for use in closed (process or supply) or vented (drain, waste or vent) piping system.
 - Acrylonitrile Butadiene Styrene (ABS) Pipe** – Nom 3 in. (76 mm) diam (or smaller) Schedule 40 solid core ABS pipe for use in closed (process or supply) or vented (drain, waste or vent) piping systems.
 - Cellular Core Acrylonitrile Butadiene Styrene (ccABS) Pipe** – Nom 3 in. (76 mm) diam (or smaller) Schedule 40 cellular core ABS pipe for use in closed (process or supply) or vented (drain, waste or vent) piping systems.
- Firestop System** – The details of the firestop system shall be as follows:
 - Fill, Void or Cavity Materials* – Caulk, Sealant or Putty** – Min 1/2 in. (13 mm) thickness of fill material applied within the annulus, flush with bottom surface of floor or both sides of wall. Additional caulk or putty may be applied within annulus, flush with top surface of floor.
3M COMPANY – CP 25WB+ caulk, FB-3000 WT sealant, MP+ Stix putty, IC 15WB+ caulk or FireDam 150+ caulk.
(Note: CP 25WB+ and FireDam 150+ not suitable for use with CPVC pipes.)
 - Fill, Void or Cavity Material*** – Nom 1/4 in. (6 mm) thick intumescent material supplied in 2 in. (51 mm) wide strips. For nom 1/2 in. (13 mm) to nom 1 in. (25 mm) diam pipes or conduits, a min of one layer of wrap strip is required. For nom 1-1/2 and 2 in. (38 and 51 mm) diam pipes or conduits, a min of two layers of wrap strip is required. For nom 2-1/2 in. and 3 in. (64 and 76 mm) diam pipes or conduits, a min of three layers of wrap strip is required. For nom 3-1/2 and 4 in. (89 and 102 mm) diam pipes or conduits, a min of four layers of wrap strip is required. The layers of wrap strip to be eccentrically installed such that the layers do not completely encircle the penetrant. The layers are wrapped around the penetrant, foil side exposed, flush with bottom surface of floor such that the ends butt up to the tangent of the periphery of the opening at the point contact location. Layers of wrap strip are held in place with foil tape or steel wire ties.
3M COMPANY – FS-195+

Through Penetrations

Non-Metallic Pipes

2000 Series

Concrete

CAJ

System No. C-AJ-2189 *continued*

- C. **Steel Collar** – Nom 2 in. (51 mm) deep collar with 1-1/4 in. (32 mm) wide by 2 in. (51 mm) long anchor tabs and min 1/2 in. (13 mm) long tabs to retain wrap strip. Coils of precut min 0.016 in. (0.41 mm) thick (28 gauge) galv sheet steel available from wrap strip manufacturer. As an alternate, collar may be field-fabricated from min 0.016 in. (0.41 mm) thick (28 gauge) galv sheet steel in accordance with instruction sheet supplied by wrap strip manufacturer. Collar, with anchor tabs bent outward 90 deg, wrapped tightly around wrap strips and penetrant with min 1 in. (25 mm) overlap at seam and compressed around wrap strips and penetrant using a min 1/2 in. (13 mm) wide by min 0.028 in. (0.71 mm) thick stainless steel band at the collar midheight. Collar to be secured to floor or wall surfaces with 1/4 in. (6 mm) diam by min 1-1/2 in. (38 mm) long steel expansion bolts, or equivalent, in conjunction with steel nuts and min 1-1/4 in. (32 mm) diam steel fender washers. Anchor bolts to be symmetrically located opposite the point contact location. A min of two anchor bolts required for nom 1/2 in. (13 mm) to nom 1 in. (25 mm) diam penetrants. A min of three anchor bolts required for nom 1-1/2 in. (38 mm) to nom 2 in. (51 mm) diam penetrants. A min of four anchor bolts required for nom 2-1/2 in. (64 mm) to nom 3 in. (76 mm) diam penetrants. A min of five anchor bolts required for nom 3-1/2 in. (89 mm) to nom 4 in. (102 mm) diam penetrants. Retainer tabs to be bent 90 deg toward pipe to lock wrap strip layers in position.

++Bearing the UL Listing Mark

*Bearing the UL Classification Mark

Reprinted from the Online Certifications Directory with permission from Underwriters Laboratories Inc.
Copyright © 2011 Underwriters Laboratories Inc.®

Through Penetrations

Non-Metallic Pipes

2000 Series

Concrete

CAJ

System No. C-AJ-2204

June 12, 2000

F Rating – 2 Hr

T Rating – 2 Hr

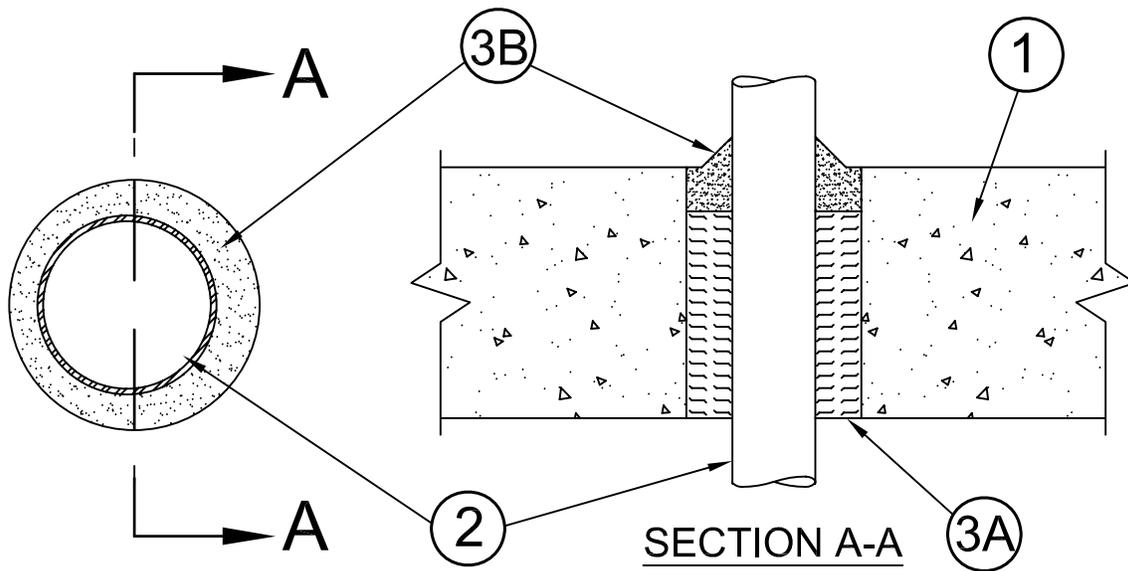

- Floor or Wall Assembly** – Min 4-1/2 in. thick reinforced lightweight or normal weight (100-150 pcf) concrete. Wall may also be constructed of any UL Classified **Concrete Blocks***. Max diam of opening is 1-1/2 in.
See **Concrete Blocks (CAZT)** category in the Fire Resistance Directory for names of manufacturers.
- Through Penetrant** – One nonmetallic pipe for use in closed (process or supply) or vented (drain waste or vent) piping systems, centered within the firestop system. Pipe to be rigidly supported on both sides of floor or wall assembly. The following type and size of nonmetallic pipe may be used:
 - Polyethylene/Aluminum/Polyethylene Composite Pressure Pipe (PE-AL-PE)** – Nom 1 in. diam (or smaller) PE-AL-PE pipe. The annular space shall be 1/8 in.
 - Crosslinked Polyethylene/Aluminum/Crosslinked Polyethylene Composite Pressure Pipe (PEX-AL-PEX)** – Nom 1 in. diam (or smaller) PEX-AL-PEX pipe. The annular space shall be 1/8 in.
- Firestop System** – The firestop system shall consist of the following:
 - Packing Material** – Min 4 in. thickness of min 4 pcf mineral wool batt insulation firmly packed into opening as a permanent form. Packing material to be recessed from top surface of floor or from both surfaces of wall as required to accommodate the required thickness of fill material.
 - Fill, Void or Cavity Material*** – Min 1/2 in. thickness of fill material applied within the annulus, flush with top surface of floor or both surfaces of wall. Additional fill material to be installed such that a min 1/4 in. crown is formed around the penetrating item.
3M COMPANY – FB-2000+ Caulk

*Bearing the UL Classification Mark

Reprinted from the Online Certifications Directory with permission from UL

© 2012 UL LLC

Through Penetrations

Non-Metallic Pipes

2000 Series

Concrete

CAJ

System No. C-AJ-2213

May 18, 2005

F Rating – 2 Hr

T Rating – 2 Hr

W Rating – Class I (See Item 3)

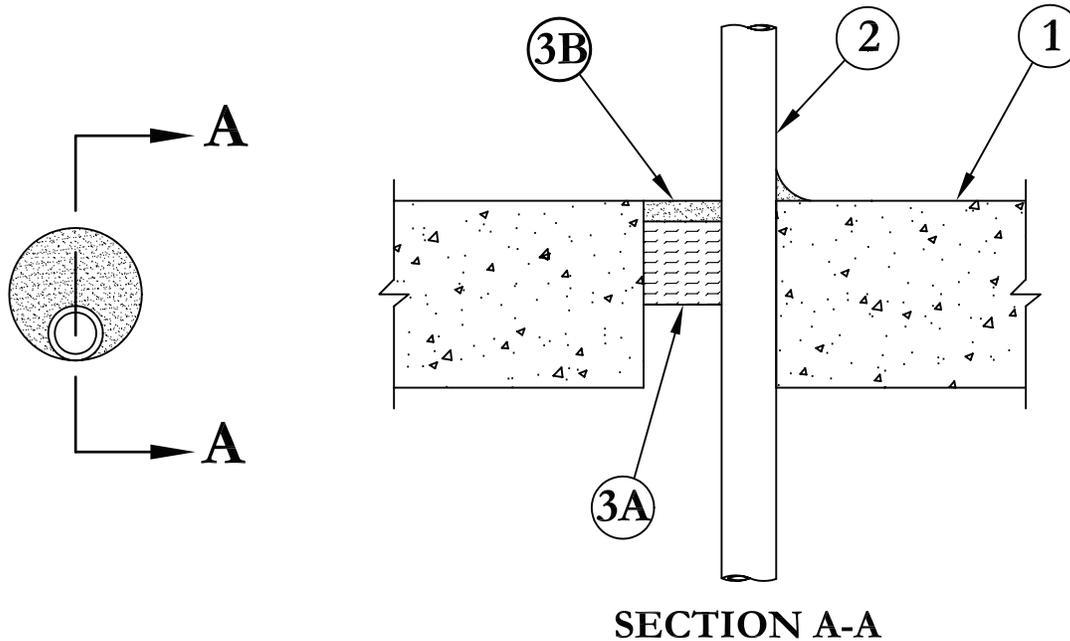

SECTION A-A

1. **Floor or Wall Assembly** – Min 4-1/2 in. (114 mm) thick reinforced lightweight or normal weight (100-150 pcf or 1600-2400 kg/m³) concrete. Wall may also be constructed of any UL Classified **Concrete Blocks***. Max diam of opening is 3 in. (76 mm).
See **Concrete Blocks** (CAZT) category in the Fire Resistance Directory for names of manufacturers.
2. **Cross linked Polyethylene (PEX) Tubing** – Nom 1 in. (25 mm) diam (or smaller) SDR 9 PEX tubing for use in closed (process or supply) piping systems installed either concentrically or eccentrically within the firestop system. The annular space between tubing and periphery of opening shall be min of 0 in. (point contact) to max 1-7/8 in. (0 mm to max 48 mm). Tubing to be rigidly supported on both sides of floor or wall assembly.
3. **Firestop System** – The details of the firestop system shall be as follows:
 - A. **Packing Material** – Min 2 in. (51 mm) thickness of min 4 pcf (64 kg/m³) mineral wool batt insulation firmly packed into opening as a permanent form. Packing material to be recessed from top surface of floor or from both surfaces of wall as required to accommodate the required thickness of fill material.
 - B. **Fill, Void or Cavity Material* – Caulk or Sealant** – Min 1/2 in. (13 mm) thickness of fill material applied within the annulus, flush with top surface of floor or with both surfaces of wall. Min 1/2 in. (13 mm) diam bead of caulk applied to the concrete/tubing interface at the point contact location on the top surface of floor or both surfaces of wall.
3M COMPANY – CP 25WB+, IC 15WB+-caulk or FB-3000 WT sealant. (Note: W Rating applies only when FB-3000 WT sealant is used.)

*Bearing the UL Classification Mark

Reprinted from the Online Certifications Directory with permission from Underwriters Laboratories Inc.
Copyright © 2011 Underwriters Laboratories Inc.®

System No. C-AJ-2214

February 12, 2016

F Rating — 3 Hr

T Rating — 1-3/4, 2-1/4, 2-1/2 And 3 Hr (See Item 2)

W Rating — Class 1 (See Item 3)

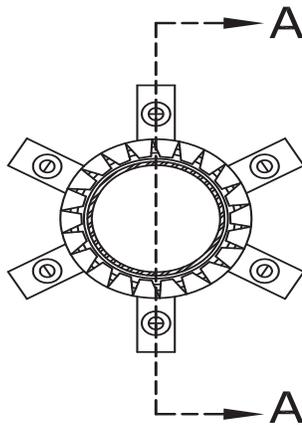

FIRESTOP
CONFIGURATION - A
(NOMINAL 4 IN. DIA. & SMALLER)

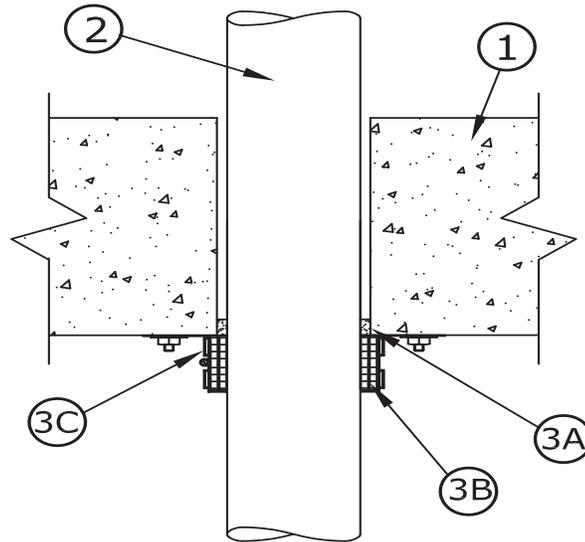

SECTION A-A

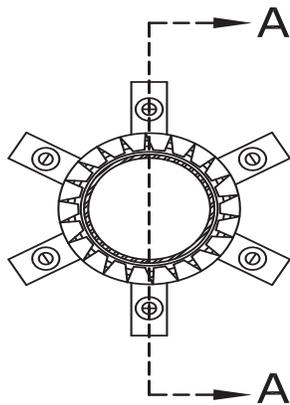

FIRESTOP
CONFIGURATION - B
(NOMINAL 6 IN. DIA.)

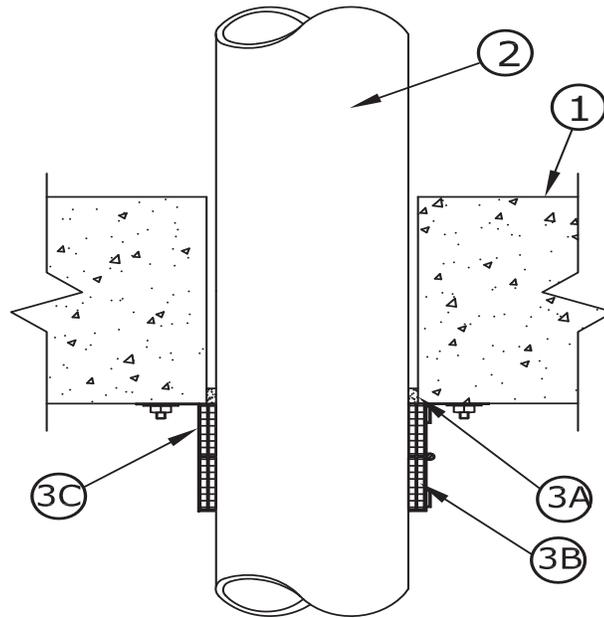

SECTION A-A

- 1. Floor or Wall Assembly** — Min 4-1/2 in. (114 mm) thick reinforced lightweight or normal weight (100-150 pcf or 1600 - 2400 kg/m³) concrete. Wall may also be constructed of any UL Classified **Concrete Blocks***. Floor may also be constructed of any min 8 in. (203 mm) thick UL Classified hollow-core **Precast Concrete Units***. Max diam of opening is 7 in. (178 mm).
See **Concrete Block** and **Precast Concrete Units** (CAZT) (CFTV) categories in the Fire Resistance Directory for names of manufacturers.
1A. **Steel Sleeve** — (Optional, Not Shown)-Nom 5 in(127 mm). diam (or smaller) Schedule 10 (or heavier) steel sleeve cast or grouted into floor or wall assembly. For use with nom 4 in. (102 mm) diam (or smaller) pipes or conduits.
T Rating is 1-3/4 when sleeve is used.
- 2. Through Penetrants** — One nonmetallic pipe or conduit to be centered within opening with a nom 1/4 in. (6 mm) annular space between pipe or conduit and periphery of opening. Pipe or conduit to be rigidly supported on both sides of the floor or wall assembly. The following types and sizes of nonmetallic pipes or conduits may be used:
 - A. Polyvinyl Chloride (PVC) Pipe** — Nom 6 in. (152 mm) diam (or smaller) Schedule 40 solid core 6 or cellular core PVC pipe for use in closed (process or supply) or vented (drain, waste or vent) piping system.

System No. C-AJ-2214 *continued*

- B. **Rigid Nonmetallic Conduit++** — Nom 6 in. (152 mm) diam (or smaller) Schedule 40 PVC conduit installed in accordance with Article 347 of the National Electrical Code (NFPA No. 70).
 - C. **Chlorinated Polyvinyl Chloride (CPVC) Pipe** — Nom 6 in. (152 mm) diam (or smaller) SDR13.5 CPVC pipe for use in closed (process or supply) piping systems.
 - D. **Acrylonitrile Butadiene Styrene (ABS) Pipe** — Nom 6 in. (152 mm) diam (or smaller) Schedule 40 solid core or cellular core ABS pipe for use in closed (process or supply) or vented (drain, waste or vent) piping systems.
 - E. **Fire Retardant Polypropylene (FRPP) Pipe** — Nom 6 in. (152 mm) diam (or smaller) Schedule 40 FRPP pipe for use in closed (process or supply) or vented (drain, waste or vent) piping system.
 - F. **Polyvinylidene Fluoride (PVDF) Pipe** — Nom 2 in. (51 mm) diam (or smaller) SDR 11, or nom 4 in. (102 mm) diam (or smaller) SDR 32.5 PVDF pipe for use in closed (process or supply) or vented (drain, waste or vent) piping system.
- T Rating is 1-3/4 Hr for nom 2-1/2 through 4 in. (64 through 102 mm) diam FRPP pipes and 2 -1/4 hr for 6 in. diam (152 mm) FRPP pipe. T Rating is 2-1/2 Hr for nom 2-1/2 through 4 in. (64 through 102 mm) diam PVC pipes or conduits. T Rating is 3 Hr for all other pipes or conduits.**

3. Firestop System — The details of the firestop system shall be as follows:

- A. **Fill, Void or Cavity Materials* — Caulk, Sealant or Putty** — Min 1/2 in. (13 mm) thickness of caulk or putty applied within annular space, flush with bottom of floor or both sides of wall.
3M COMPANY — CP 25WB+ caulk, FB-3000 WT Sealant, MP+ Stix putty, IC 15WB+ caulk or FireDam 150+ caulk
(Note - W Rating applies only when FB-3000 WT is used. CP 25WB+ and FireDam 150+ not suitable for use with CPVC pipes.)

Firestop Configuration A

- A1. **Fill, Void or Cavity Materials* — Sealant (Optional, Not Shown)** — For floor assemblies, an additional min 1/2 in. (13 mm) thickness of sealant may be applied within the annular space flush with top surface of floor.
3M COMPANY — FB-1000 NS
- B. **Fill, Void or Cavity Materials* — Wrap Strip** — Nom 1/8 in. (3.2 mm) thick intumescent material supplied in 2 in. (51 mm) wide strips. Wrap strip tightly wrapped around nonmetallic pipe with continuous layers and butted tightly against the bottom surface of the floor or both surfaces of the wall. The min number of layers required is dependent upon the nom diam of the pipe. For nom 2 in. (51 mm) diam (and smaller) pipes, two layers are required. For nom 2-1/2 and 3 in. (64 and 76 mm) diam pipes, three layers are required. For nom 3-1/2 and 4 in. (89 and 102 mm) diam pipes, four layers are required. Wrap strip layers temporarily held in position using aluminum foil tape, steel wire tie, or equivalent.
3M COMPANY — Ultra GS
- C. **Steel Collar** — Nom 2 in. (51 mm) deep collar with 1-1/4 in. (32 mm) wide by 2 in. (51 mm) long anchor tabs and min 1/2 in. (13 mm) long tabs to retain wrap strip layers. Coils of precut 0.016 in. (0.41 mm) thick (28 gauge) galv sheet steel available from wrap strip manufacturer. As an alternate, collar may be field-fabricated from min 0.016 in. (0.41 mm) thick (28 gauge) galv sheet steel in accordance with instruction sheet supplied by wrap strip manufacturer. Steel collar, with anchor tabs bent outward 90 deg, wrapped tightly around wrap strip layers with min 1 in. (25 mm) overlap at seam. Anchor tabs to be pressed tightly against floor or wall surface(s), and collar to be compressed around wrap strip layers using a min 1/2 in. (13 mm) wide by 0.028 in. (0.71 mm) thick stainless steel band clamp at the collar midheight. As an alternate to the band clamp, collar for systems with three or more layers of wrap strip may be fastened together along with three No. 6 by 3/8 in. (10 mm) long self-tapping steel screws.

Collar to be secured to floor or wall surface(s) with 1/4 in. (6 mm) diam by min 1-1/2 in. (38 mm) long steel expansion bolts in conjunction with steel nuts and min 1-1/4 in. (32 mm) diam steel fender washers. Min of two, three or four anchor bolts, symmetrically located, for nom 2 in. (51 mm) diam (and smaller), nom 3 in. (76 mm) diam (and smaller) and nom 4 in. (102 mm) diam (and smaller), pipes, respectively.

Firestop Configuration B

- B. **Fill, Void or Cavity Materials* — Wrap Strip** — Nom 1/8 in. (3.2 mm) thick intumescent material supplied in 2 in. (51 mm) wide strips. Min four continuous layers of wrap strip tightly wrapped around nonmetallic pipe and butted tightly against the bottom surface of the floor or both surfaces of the wall. An additional stack of four continuous layers of wrap strip tightly wrapped around nonmetallic pipe and butted tightly against the first layers of wrap strip.
3M COMPANY — Ultra GS
- C. **Steel Collar** — Two nom 2 in. (51 mm) deep collars with 1-1/4 in. (32 mm) wide by 2 in. (51 mm) long anchor tabs and min 1/2 in. (13 mm) long tabs to retain wrap strip layers. Coils of precut 0.016 in. (0.41 mm) thick (28 gauge) galv sheet steel available from wrap strip manufacturer. As an alternate, collars may be field-fabricated from min 0.016 in. (0.41 mm) thick (28 gauge) galv sheet steel in accordance with instruction sheet supplied by wrap strip manufacturer. Steel collars wrapped tightly around wrap strip layers with min 1 in. (25 mm) overlap at seams, with anchor tabs bent outward 90 deg for upper or inner collars for securement to wall or floor. Anchor tabs for lower or outer collars to overlap onto upper or inner collars. Collars to be compressed around wrap strip layers using a min 1/2 in. (13 mm) wide by 0.028 in. (0.71 mm) thick stainless steel band clamp at each collar's midheight. An additional min 1/2 in. (13 mm) wide by 0.028 in. (0.71 mm) thick stainless steel band clamp to be tightly fastened around collars at the point where anchor tabs of lower or outer collars overlap onto upper or inner collars. As an alternate to the band clamps at each collar's midheight, each collar may be fastened together along the overlapping seam with three No. 6 by 3/8 in. (10 mm) long self-tapping steel screws. The additional steel band clamp fastened around collars at the point where anchor tabs of lower or outer collars overlap onto upper or inner collars is still required when collars are fastened together with screws. Upper or inner collars to be secured to floor or wall surface(s) with 1/4 in. (6 mm) diam by min 1-1/2 in. (38 mm) long steel expansion bolts, or equivalent, in conjunction with steel nuts and min 1-1/4 in. (32 mm) diam steel fender washers. Min of six anchor bolts, symmetrically located, required.

*Bearing the UL Classification Marking

++Bearing the UL Listing Mark

Reprinted from the Online Certifications Directory with permission from UL

© 2016 UL LLC



3M Fire Protection Products

System No. C-AJ-2216

November 20, 2009

F Rating – 2 Hr

T Rating – 1 Hr

W Rating – Class 1 (See Item 3)

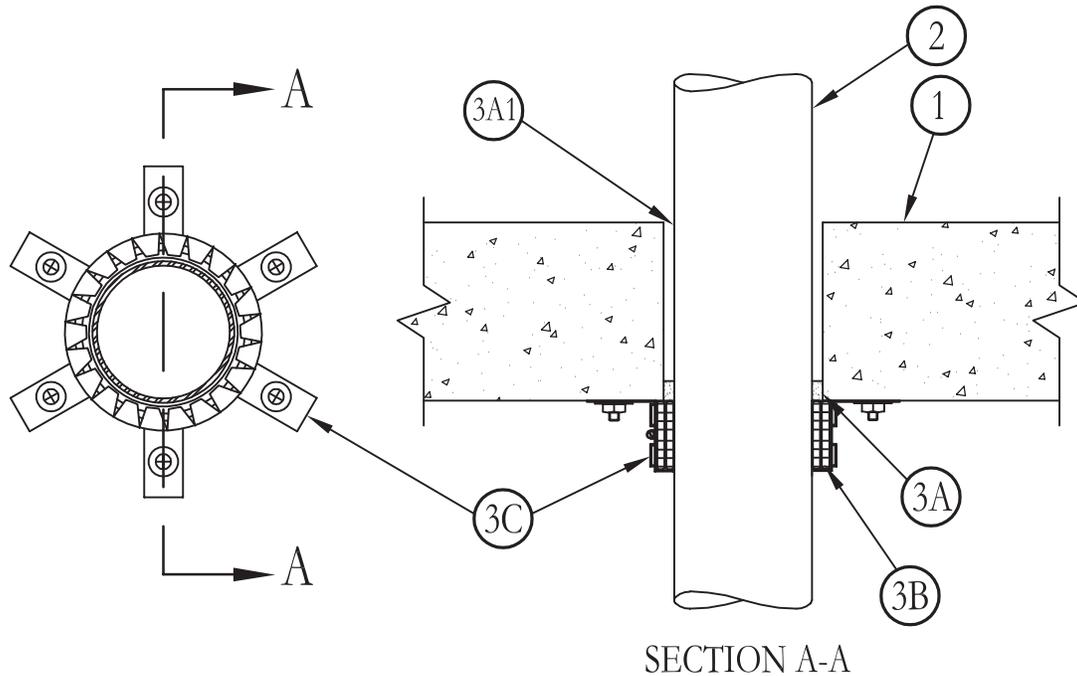

1. **Floor or Wall Assembly** – Min 2-1/2 in. (64 mm) thick reinforced lightweight or normal weight (100-150 pcf or 1600 - 2400 kg/m³) concrete. Wall may also be constructed of any UL Classified **Concrete Blocks***. Floor may also be constructed of any min 6 in. (152 mm) thick UL Classified hollow core **Precast Concrete Units***. Max diam of opening is 5 in. (127 mm)
See **Concrete Block (CAZT)** and **Precast Concrete Units (CFTV)** categories in the Fire Resistance Directory for names of manufacturers.
2. **Through Penetrants** – One nonmetallic pipe or conduit to be centered within opening with a nom 1/4 in. (6 mm) annular space between pipe or conduit and periphery of opening. Pipe or conduit to be rigidly supported on both sides of the floor or wall assembly. The following types and sizes of nonmetallic pipes or conduits may be used:
 - A. **Polyvinyl Chloride (PVC) Pipe** – Nom 4 in. (102 mm) diam (or smaller) Schedule 40 solid core or cellular core PVC pipe for use in closed (process or supply) or vented (drain, waste or vent) piping system.
 - B. **Ridid Nonmetallic Conduit++** – Nom 4 in. (102 mm) diam (or smaller) Schedule 40 PVC conduit installed in accordance with Article 347 of the National Electrical Code (NFPA No. 70).
 - C. **Chlorinated Polyvinyl Chloride (CPVC) Pipe** – Nom 4 in. (102 mm) diam (or smaller) SDR13.5 CPVC pipe for use in closed (process or supply) piping systems.
 - D. **Acrylonitrile Butadiene Styrene (ABS) Pipe** – Nom 4 in. (102 mm) diam (or smaller) Schedule 40 solid core or cellular core ABS pipe for use in closed (process or supply) or vented (drain, waste or vent) piping systems.
 - E. **Fire Retardant Polypropylene (FRPP) Pipe** – Nom 4 in. (102 mm) diam (or smaller) Schedule 40 FRPP pipe for use in closed (process or supply) or vented (drain, waste or vent) piping systems.
 - F. **Polyvinylidene Fluoride (PVDF) Pipe** – Nom 2 in. (51 mm) diam (or smaller) SDR 11, or nom 4 in. (102 mm) diam (or smaller) SDR 32.5 PVDF pipe for use in closed (process or supply) or vented (drain, waste or vent) piping systems.
3. **Firestop System** – The details of the firestop system shall be as follows:
 - A. **Fill, Void or Cavity Materials* – Caulk, Sealant or Putty** – Min 1/2 in. (13 mm) thickness of caulk or putty applied within annular space, flush with bottom of floor or both sides of wall.
3M COMPANY – CP 25WB+ caulk, FB-3000 WT Sealant, MP+ Stix putty, IC 15WB+ caulk or FireDam 150+ caulk
(Note: W Rating applies only when FB-3000 WT is used. CP 25WB+ and FireDam 150+ not suitable for use with CPVC pipes.)
 - A1. **Fill, Void or Cavity Materials* – Sealant** (Optional, Not Shown) – For floor assemblies, an additional min 1/2 in. (13 mm) thickness of sealant may be applied within the annular space flush with top surface of floor.
3M COMPANY – FB-1000 NS or FB-3000 WT Sealant
(Note: W Rating applies when FB-3000 WT or FB-1000 NS is used.)
 - B. **Fill, Void or Cavity Materials* – Wrap Strip** – Nom 1/8 in. (3.2 mm) thick intumescent material supplied in 2 in. (51 mm) wide strips. Wrap strip tightly wrapped around nonmetallic pipe with continuous layers and butted tightly against the bottom surface of the floor or both surfaces of the wall. The min number of layers required is dependent upon the nom diam of the pipe. For nom 2 in. (51 mm) diam (and smaller) pipes, two layers are required. For nom 2-1/2 and 3 in. (64 and 76 mm) diam pipes, three layers are required. For nom 3-1/2 and 4 in. (89 and 102 mm) diam pipes, four layers are required. Wrap strip layers temporarily held in position using aluminum foil tape, steel wire tie, or equivalent.
3M COMPANY – Ultra GS

System No. C-AJ-2216 *continued*

- C. **Steel Collar** – Nom 2 in. (51 mm) deep collars with 1-1/4 in. (32 mm) wide by 2 in. (51 mm) long anchor tabs and min 1/2 in. (13 mm) long tabs to retain wrap strip layers. Coils of precut 0.016 in. (0.41 mm) thick (28 gauge) galv sheet steel available from wrap strip manufacturer. As an alternate, collar may be field-fabricated from min 0.016 in. (0.41 mm) thick (28 gauge) galv sheet steel in accordance with instruction sheet supplied by wrap strip manufacturer. Steel collar, with anchor tabs bent outward 90 deg, wrapped tightly around wrap strip layers with min 1 in. (25 mm) overlap at seam. Anchor tabs to be pressed tightly against floor or wall surface(s), and collar to be compressed around wrap strip layers using a min 1/2 in. (13 mm) wide by 0.028 in. (0.71 mm) thick stainless steel band clamp at the collar midheight. Collar to be secured to floor or wall surface(s) with 1/4 in. (6 mm) diam by min 1-1/2 in. (38 mm) long steel expansion bolts, or equivalent, in conjunction with steel nuts and min 1-1/4 in. (32 mm) diam steel fender washers. Min of two, three or four anchor bolts, symmetrically located, for nom 2 in. (51 mm) diam (and smaller), nom 3 in. (76 mm) diam (and smaller) and nom 4 in. (102 mm) diam (and smaller), pipes, respectively.

*Bearing the UL Classification Marking

++Bearing the UL Listing Mark

Reprinted from the Online Certifications Directory with permission from Underwriters Laboratories Inc.
Copyright © 2011 Underwriters Laboratories Inc.®

Through Penetrations

Non-Metallic Pipes

2000 Series

Concrete

CAJ

System No. C-AJ-2226

November 20, 2009

F Rating – 3 Hr

T Rating – 3 Hr

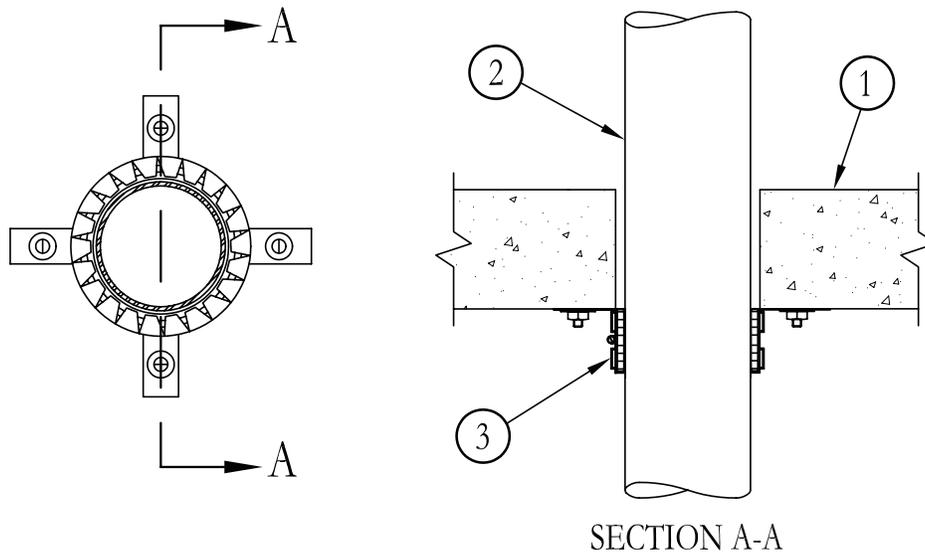

1. **Floor or Wall Assembly** – Min 4-1/2 in. (114 mm) thick reinforced lightweight or normal weight (100-150 pcf or 1600 - 2400 kg/m³) concrete. Wall may also be constructed of any UL Classified **Concrete Blocks***. Floor may also be constructed of any min 6 in. (152 mm) thick UL Classified hollow-core **Precast Concrete Units***. Max diam of opening is 5 in. (127 mm).
See **Concrete Block (CAZT)** and **Precast Concrete units (CFTV)** categories in the Fire Resistance Directory for names of manufacturers.
- 1A. **Steel Sleeve** – (Optional, Not Shown) – Nom 5 in. (127 mm) diam (or smaller) Schedule 10 (or heavier) steel sleeve cast or grouted into floor or wall assembly.
2. **Through Penetrants** – One nonmetallic pipe or conduit to be centered within opening with a nom 1/4 in. (6 mm) annular space between pipe or conduit and periphery of opening. Pipe or conduit to be rigidly supported on both sides of the floor or wall assembly. The following types and sizes of nonmetallic pipes or conduits may be used:
 - A. **Polyvinyl Chloride (PVC) Pipe** – Nom 4 in. (102 mm) diam (or smaller) Schedule 40 solid core or cellular core PVC pipe for use in closed (process or supply) or vented (drain, waste or vent) piping systems.
 - B. **Rigid Nonmetallic Conduit++** – Nom 4 in. (102 mm) diam (or smaller) Schedule 40 PVC conduit installed in accordance with Article 347 of the National Electrical Code (NFPA No. 70).
 - C. **Chlorinated Polyvinyl Chloride (CPVC) Pipe** – Nom 4 in. (102 mm) diam (or smaller) SDR13.5 CPVC pipe for use in closed (process or supply) piping systems.
 - D. **Acrylonitrile Butadiene Styrene (ABS) Pipe** – Nom 4 in. (102 mm) diam (or smaller) Schedule 40 solid core or cellular core ABS pipe for use in closed (process or supply) or vented (drain, waste or vent) piping systems.
 - E. **Fire Retardant Polypropylene (FRPP) Pipe** – Nom 4 in. (102 mm) diam (or smaller) Schedule 40 FRPP pipe for use in closed (process or supply) or vented (drain, waste or vent) piping systems.
 - F. **Polyvinylidene Fluoride (PVDF) Pipe** – Nom 2 in. (51 mm) diam (or smaller) SDR 11, or nom 4 in. (102 mm) diam (or smaller) SDR 32.5 PVDF pipe for use in closed (process or supply) or vented (drain, waste or vent) piping systems.
3. **Firestop Device – Collar** – Collar to be installed in accordance with the accompanying installation instructions. Collar to be installed and latched around pipe and secured to underside of floor or on both sides of wall with 3M Ultra Fast Anchor Straps or with 1/4 in. (6 mm) diam by min 1-1/2 in. (38 mm) long steel expansion bolts in conjunction with steel nuts and min 1-1/4 in. (32 mm) diam steel fender washers. Min of two, three or four anchor straps or anchor bolts, symmetrically located, for nom 2 in. (51 mm) diam (and smaller), nom 3 in. (76 mm) diam and nom 4 in. (102 mm) diam pipes, respectively.
3M COMPANY – Ultra PPD 1.5, 2.0, 3.0 and 4.0
4. **Fill, Void or Cavity Materials* – Caulk, Sealant or Putty** – (Optional, Not Shown) – Min 1/4 in. thickness of caulk or putty applied within annular space, flush with top or bottom of floor on one or both sides of wall.
3M COMPANY – CP 25WB+ caulk, FB-3000 WT sealant, MP+ Stix putty, IC 15WB+ caulk or FireDam 150+ caulk.
(Note: CP 25WB+ and FireDam 150+ not suitable for use with CPVC pipes.)
5. **Fill, Void or Cavity Materials* – Sealant** – (Optional, Not Shown) – For floor assemblies, a min 1/2 in. (13 mm) thickness of sealant may be applied within the annular space flush with top surface of floor.
3M COMPANY – FB-1000 NS or FB-3000 WT

*Bearing the UL Classification Marking

++Bearing the UL Listing Mark

Reprinted from the Online Certifications Directory with permission from Underwriters Laboratories Inc.
Copyright © 2011 Underwriters Laboratories Inc.®

System No. C-AJ-2227

November 20, 2009

F Rating – 2 Hr

T Ratings – 3/4 And 1-1/4 Hr (See Item 2)

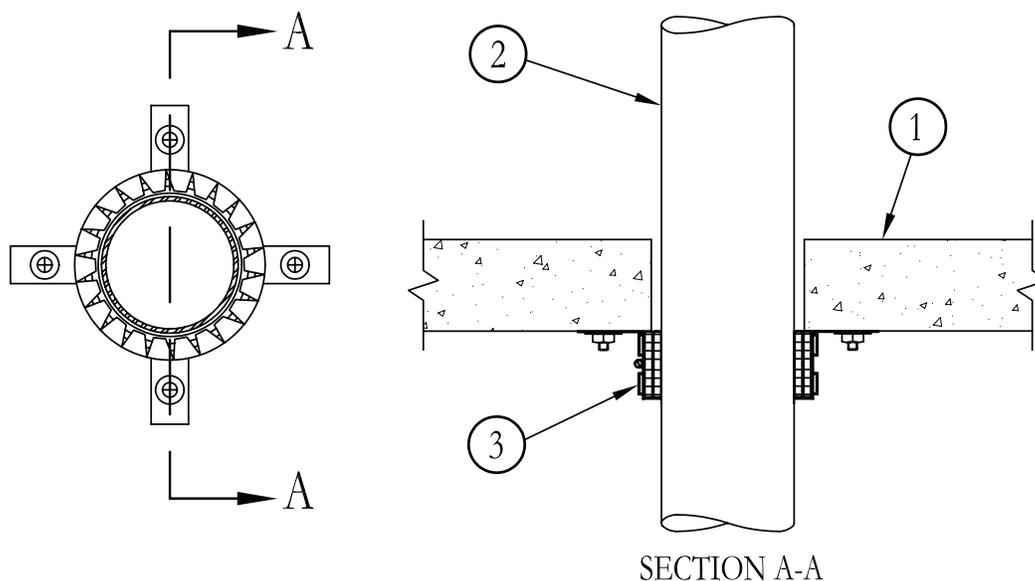

1. **Floor or Wall Assembly** – Min 2-1/2 in. (64 mm) thick reinforced lightweight or normal weight (100-150 pcf or 1600 - 2400 kg/m³) concrete. Wall may also be constructed of any UL Classified **Concrete Blocks***. Max diam of opening is 5 in. (127 mm).
See **Concrete Block (CAZT)** and **Precast Concrete units (CFTV)** categories in the Fire Resistance Directory for names of manufacturers. Floor may also be constructed of any min 6 in. (152 mm) thick UL Classified hollow-core **Precast Concrete units***.
2. **Through Penetrants** – One nonmetallic pipe or conduit to be centered within opening with a nom 1/4 in. (6 mm) annular space between pipe or conduit and periphery of opening. Pipe or conduit to be rigidly supported on both sides of the floor or wall assembly. The following types and sizes of nonmetallic pipes or conduits may be used:
 - A. **Polyvinyl Chloride (PVC) Pipe** – Nom 4 in. (102 mm) diam (or smaller) Schedule 40 solid core or cellular core PVC pipe for use in closed (process or supply) or vented (drain, waste or vent) piping systems.
 - B. **Rigid Nonmetallic Conduit++** – Nom 4 in. (102 mm) diam (or smaller) Schedule 40 PVC conduit installed in accordance with Article 347 of the National Electrical Code (NFPA No. 70).
 - C. **Chlorinated Polyvinyl Chloride (CPVC) Pipe** – Nom 4 in. (102 mm) diam (or smaller) SDR13.5 CPVC pipe for use in closed (process or supply) piping systems.
 - D. **Acrylonitrile Butadiene Styrene (ABS) Pipe** – Nom 4 in. (102 mm) diam (or smaller) Schedule 40 solid core or cellular core ABS pipe for use in closed (process or supply) or vented (drain, waste or vent) piping systems.
 - E. **Fire Retardant Polypropylene (FRPP) Pipe** – Nom 4 in. (102 mm) diam (or smaller) Schedule 40 FRPP pipe for use in closed (process or supply) or vented (drain, waste or vent) piping systems.
 - F. **Polyvinylidene Fluoride (PVDF) Pipe** – Nom 2 in. (51 mm) diam (or smaller) SDR 11, or nom 4 in. (102 mm) diam (or smaller) SDR 32.5 PVDF pipe for use in closed (process or supply) or vented (drain, waste or vent) piping systems.

T Rating is 1-1/4 Hr for PVC pipes or conduits. T Rating is 3/4 Hr for all other pipes or conduits.
3. **Firestop Device – Collar** – Collar to be installed in accordance with the accompanying installation instructions. Collar to be installed and latched around pipe and secured to underside of floor or on both sides of wall with 3M Ultra Fast Anchor Straps or with 1/4 in. (6 mm) diam by min 1-1/2 in. (38 mm) long steel expansion bolts in conjunction with steel nuts and min 1-1/4 in. (32 mm) diam steel fender washers. Min of two, three or four anchor straps or anchor bolts, symmetrically located, for nom 2 in. (51 mm) diam (and smaller), nom 3 in. (76 mm) diam and nom 4 in. (102 mm) diam pipe, respectively.
3M COMPANY – Ultra PPD 1.5, 2.0, 3.0 and 4.0
4. **Fill, Void or Cavity Materials* – Caulk, Sealant or Putty** – (Optional, Not Shown) – Min 1/4 in. (6 mm) thickness of caulk or putty applied within annular space, flush with top or bottom of floor on one or both sides of wall.
3M COMPANY – CP 25WB+ caulk, FB-3000 WT sealant, MP+ Stix putty, IC 15WB+ caulk or FireDam 150+ caulk.
(Note: CP 25WB+ and FireDam 150+ not suitable for use with CPVC pipes.)
5. **Fill, Void or Cavity Materials* – Sealant** (Optional, Not Shown) – For floor assemblies, a min 1/2 in. (13 mm) thickness of sealant may be applied within the annular space flush with top surface of floor.
3M COMPANY – FB-1000 NS or FB-3000 WT

*Bearing the UL Classification Marking

++Bearing the UL Listing Mark

Reprinted from the Online Certifications Directory with permission from Underwriters Laboratories Inc.
Copyright © 2011 Underwriters Laboratories Inc.®

Through Penetrations

Non-Metallic Pipes

2000 Series

Concrete

CAJ

System No. C-AJ-2228

November 20, 2009

F Ratings – 2 and 3 Hr (See Item 3)

T Ratings – 0, 2 and 3 Hr (See Item 2 and 3)

W Rating – Class 1 (See Item 4)

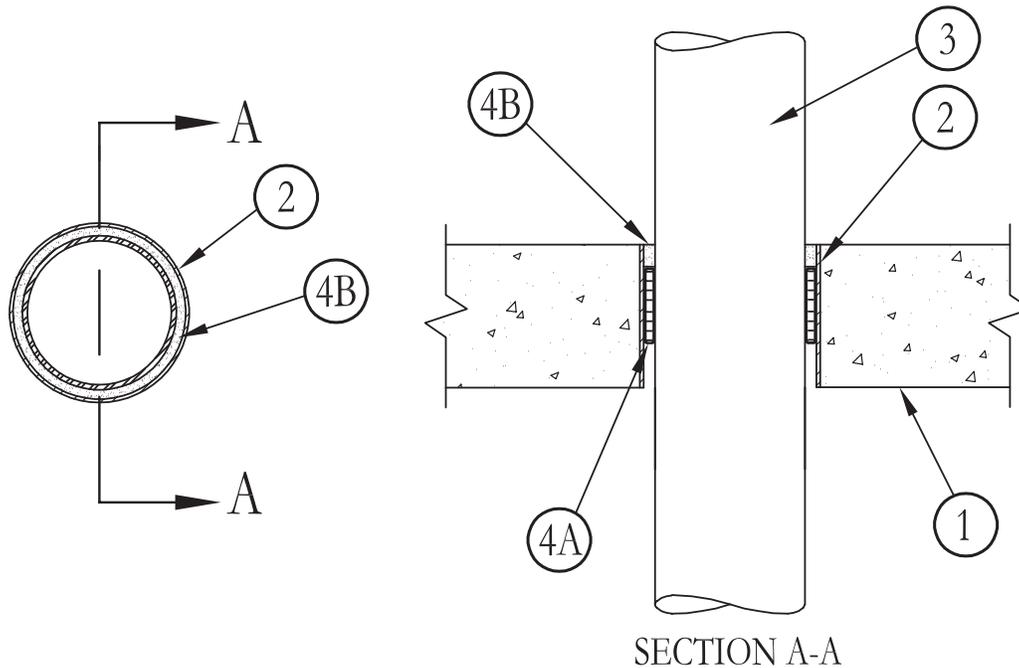

- Floor or Wall Assembly** – Min 4-1/2 in. (114 mm) thick reinforced lightweight or normal weight (100-150 pcf or 1600 - 2400 kg/m³) concrete. Wall may also be constructed of any UL Classified **Concrete Blocks***. Diam of opening shall be 1 in. (25 mm) larger than nom pipe diam.
See **Concrete Block (CAZT)** category in the Fire Resistance Directory for names of manufacturers.
- Steel Sleeve** – (Optional) – Nom 4 in. (102 mm) diam (or smaller) Schedule 10 (or heavier) steel sleeve cast or grouted into floor or wall assembly.
T Rating is 0 Hr when sleeve is used.
- Through Penetrants** – One nonmetallic pipe or conduit to be installed within opening. The annular space between pipe or conduit and periphery of opening or sleeve and the T Ratings for the pipes when no sleeve is used are dependent on the type of pipe and nom pipe sizes as shown in the table below. Pipe or conduit to be rigidly supported on both sides of the floor or wall assembly. The following types and sizes of nonmetallic pipes may be used:
 - Polyvinyl Chloride (PVC) Pipe** – Nom 3 in. (76 mm) diam (or smaller) Schedule 40 solid core or cellular core PVC pipe for use in closed (process or supply) or vented (drain, waste or vent) piping systems.
 - Rigid Nonmetallic Conduit**++ – Nom 3 in. (76 mm) diam (or smaller) Schedule 40 PVC conduit installed in accordance with Article 347 of the National Electrical Code (NFPA No. 70).
 - Chlorinated Polyvinyl Chloride (CPVC) Pipe** – Nom 3 in. (76 mm) diam (or smaller) SDR13.5 CPVC pipe for use in closed (process or supply) piping systems.
 - Acrylonitrile Butadiene Styrene (ABS) Pipe** – Nom 3 in. (76 mm) diam (or smaller) Schedule 40 solid core or cellular ABS pipe for use in closed (process or supply) or vented (drain, waste or vent) piping systems.
 - Fire Retardant Polypropylene (FRPP) Pipe** – Nom 3 in. (76 mm) diam (or smaller) Schedule 40 FRPP pipe for use in closed (process or supply) or vented (drain, waste or vent) piping systems.

| Pipe Type | Nom Pipe Diam, In. (mm) | Annular Space In. (mm) | | F Rating Hr | T Rating Hr |
|-----------|-------------------------|------------------------|----------|-------------|-------------|
| | | Min | Max | | |
| A, B, C | 2 (51) | 1/8 (3.2) | 1/2 (13) | 3 | 2 |
| A, B, C | 3 (76) | 1/4 (6) | 1/4 (6) | 2 | 0 |
| D | 2 (51) | 1/8 (3.2) | 1/2 (13) | 3 | 3 |
| D | 3 (76) | 1/4 (6) | 1/4 (6) | 2 | 2 |
| E | 2 (51) | 1/8 (3.2) | 1/2 (13) | 2 | 0 |
| E | 3 (76) | 1/4 (6) | 1/4 (6) | 2 | 0 |

System No. C-AJ-2228 continued

4. **Firestop System** – The firestop system shall consist of the following:

- A. **Fill, Void or Cavity Materials* – Wrap Strip** – Nom 1/8 in. (3.2 mm) thick intumescent material supplied in 2 in. (51 mm) wide strips. Wrap strip tightly wrapped around nonmetallic pipe with continuous layers and secured with two 1/4 in. (6 mm) wide bands of filament tape placed 1/2 in. (13 mm) from bottom and top of wrap strip. The layers of wrap strip and its position within the opening are dependent on the pipe size. For nom 2 in. (51 mm) diam (or smaller) pipes, one layer is required, recessed within the opening 2-1/4 in. (57 mm) from the bottom surface of the floor or both surfaces of the wall. For nom 2-1/2 and 3 in. (64 and 76 mm) diam pipes, two layers are required, recessed within the opening 1-1/2 in. (38 mm) from the bottom surface of the floor or both surfaces of the wall.

3M COMPANY – Ultra GS

- B. **Fill, Void or Cavity Materials* – Caulk or Sealant** (Optional, Not Shown) – Min 1/4 in. (6 mm) thickness of caulk or sealant applied within annular space, flush with top of floor .

3M COMPANY – CP 25WB+ caulk, FB-3000 WT Sealant, FB-1000 NS sealant, IC 15WB+ caulk or FireDam 150+ caulk.

(Note: W Rating applies only when FB-3000 WT or FB- 1000 NS is used. CP 25WB+ and FireDam 150+ not suitable for use with CPVC pipes.)

*Bearing the UL Classification Marking

++Bearing the UL Listing Mark

Reprinted from the Online Certifications Directory with permission from Underwriters Laboratories Inc.
Copyright © 2011 Underwriters Laboratories Inc.®

Through Penetrations

Non-Metallic Pipes

2000 Series

Concrete

CAJ

System No. C-AJ-2241

November 20, 2009

F Rating – 1 Hr

T Rating – 1 Hr

W Rating – Class 1 (See Item 4)

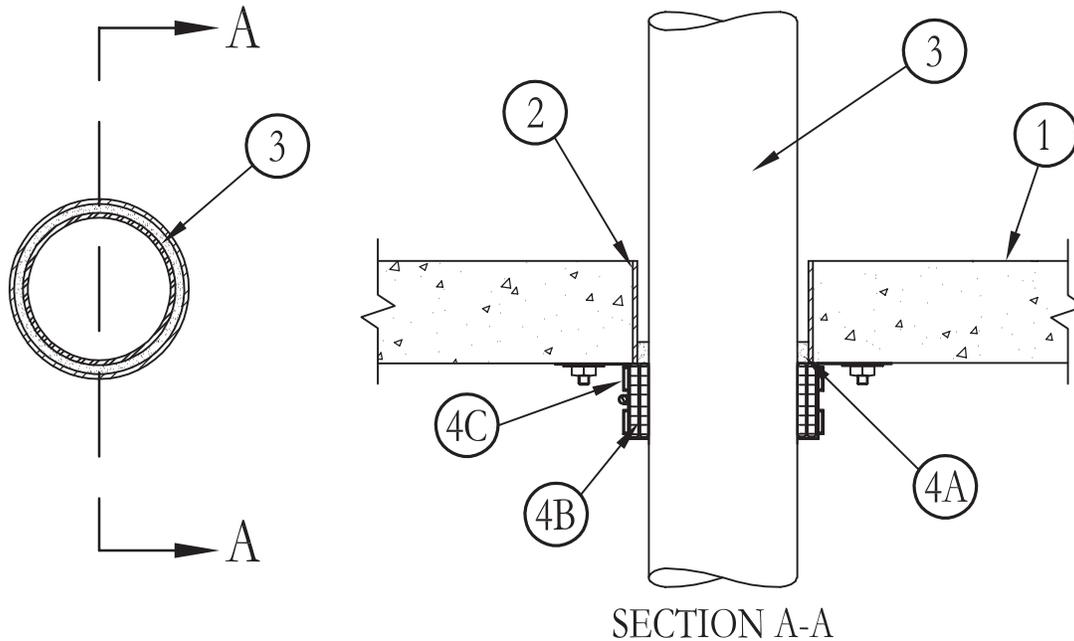

1. **Floor or Wall Assembly** – Min 2-1/2 in. (64 mm) thick reinforced lightweight or normal weight (100-150 pcf or 1600 - 2400 kg/m³) concrete. Wall may also be constructed of any UL Classified **Concrete Blocks***. For nom 2-1/2 in. (64 mm) diam and smaller pipes and conduits, diam of opening shall be 1/2 in. (13 mm) larger than nom pipe diam. For pipes and conduits greater than nom 2-1/2 in. (64 mm) diam of opening shall be 1 in. (25 mm) larger than nom pipe diam.
See **Concrete Block (CAZT)** category in the Fire Resistance Directory for names of manufacturers.
2. **Steel Sleeve** – (Optional) – Nom 5 in. (127 mm) diam (or smaller) Schedule 10 (or heavier) steel sleeve cast or grouted into floor or wall assembly.
3. **Through Penetrants** – One nonmetallic pipe or conduit to be centered within opening with a nom annular space between pipe or conduit and periphery of opening of 1/8 in. (3.2 mm) for nom 2-1/2 in. (64 mm) diam and smaller pipes and conduits and 1/4 in. (6 mm) pipes and conduits greater than nom 2-1/2 in. (64 mm). Pipe or conduit to be rigidly supported on both sides of the floor or wall assembly. The following types and sizes of nonmetallic pipes may be used:
 - A. **Polyvinyl Chloride (PVC) Pipe** – Nom 4 in. (102 mm) diam (or smaller) Schedule 40 solid core or cellular core PVC pipe for use in closed (process or supply) or vented (drain, waste or vent) piping systems.
 - B. **Rigid Nonmetallic Conduit++** – Nom 4 in. (102 mm) diam (or smaller) Schedule 40 PVC conduit installed in accordance with Article 347 of the National Electrical Code (NFPA No. 70).
 - C. **Chlorinated Polyvinyl Chloride (CPVC) Pipe** – Nom 4 in. (102 mm) diam (or smaller) SDR13.5 CPVC pipe for use in closed (process or supply) or vented (drain, waste or vent) piping systems.
 - D. **Acrylonitrile Butadiene Styrene (ABS) Pipe** – Nom 4 in. (102 mm) diam (or smaller) Schedule 40 solid core or cellular core ABS pipe for use in closed (process or supply) or vented (drain, waste or vent) piping systems.
 - E. **Fire Retardant Polypropylene (FRPP) Pipe** – Nom 4 in. (102 mm) diam (or smaller) Schedule 40 FRPP pipe for use in closed (process or supply) or vented (drain, waste or vent) piping systems.
4. **Firestop System** – The details of the firestop system shall be as follows:
 - A. **Fill, Void or Cavity Materials* – Caulk or Sealant** – Min 1/4 in. (6 mm) thickness of caulk applied within annular space, flush with bottom of floor or both sides of wall.
3M COMPANY – CP 25WB+ caulk, FB-3000 WT Sealant, IC 15WB+ caulk or FireDam 150+ caulk
(Note: W Rating applies only when FB-3000 WT is used. CP 25WB+ and FireDam 150+ not suitable for use with CPVC pipes.)
 - A1. **Fill, Void or Cavity Materials* – Sealant** (Optional, Not Shown) – For floor assemblies, an additional min 1/2 in. (13 mm) thickness of sealant may be applied within the annular space flush with top surface of floor.
3M COMPANY – FB-1000 NS or FB-3000 WT
(Note: W Rating applies when FB-3000 WT or FB-1000 NS is used.)
 - B. **Fill, Void or Cavity Materials* – Wrap Strip** – Nom 1/8 in. (3.2 mm) thick intumescent material supplied in 2 in. (51 mm) wide strips. Wrap strip tightly wrapped around nonmetallic pipe with continuous layers and butted tightly against the bottom surface of the floor or both surfaces of the wall. For nom 2 in. (51 mm) diam (and smaller) pipes, one layer is required. For nom 2-1/2 and 3 in. (64 and 76 mm) diam pipes, two layers are required. For nom 3-1/2 and 4 in. (89 and 102 mm) diam pipes, three layers are required. Wrap strip layers temporarily held in position using aluminum foil tape, steel wire tie, or equivalent.
3M COMPANY – Ultra GS

System No. C-AJ-2241 *continued*

- C. **Steel Collar** – Nom 2 in. (51 mm) deep collar with 1-1/4 in. (32 mm) wide by 2 in. (51 mm) long anchor tabs and min 1/2 in. (13 mm) long tabs to retain wrap strip layers. Coils of precut 0.016 in. (0.41 mm) thick (28 gauge) galv sheet steel available from wrap strip manufacturer. As an alternate, collar may be field-fabricated from min 0.016 in. (0.41 mm) thick (28 gauge) galv sheet steel in accordance with instruction sheet supplied by wrap strip manufacturer. Steel collar, with anchor tabs bent outward 90 degree, wrapped tightly around wrap strip layers with min 1 in. (25 mm) overlap at seam. Anchor tabs to be pressed tightly against floor or wall surface(s), and collar to be compressed around wrap strip layers using a min 1/2 in. (13 mm) wide by 0.028 in. (0.71 mm) thick stainless steel band clamp at the collar midheight. As an alternate to the band clamp, collar for systems with three or more layers of wrap strip may be fastened together along the overlapping seam with three No. 6 by 3/8 in. (10 mm) long self-tapping steel screws. Collar to be secured to floor or wall surface(s) with 1/4 in. (6 mm) diam by min 1-1/2 in. (38 mm) long steel expansion bolts in conjunction with steel nuts and min 1-1/4 in. (32 mm) diam steel fender washers. Min of two, three or four anchor bolts, symmetrically located, for nom 2 in. (51 mm) diam (and smaller), nom 3 in. (76 mm) diam (and smaller) and nom 4 in. (102 mm) diam (and smaller), pipes, respectively.

*Bearing the UL Clasification Marking

++Bearing the UL Listing Mark

Reprinted from the Online Certifications Directory with permission from Underwriters Laboratories Inc.
Copyright © 2011 Underwriters Laboratories Inc.®

System No. C-AJ-2242

November 20, 2009

F Rating – 2 Hr

T Ratings – 1-3/4 and 2 Hr (See Item 2)

W Rating – Class 1 (See Item 4)

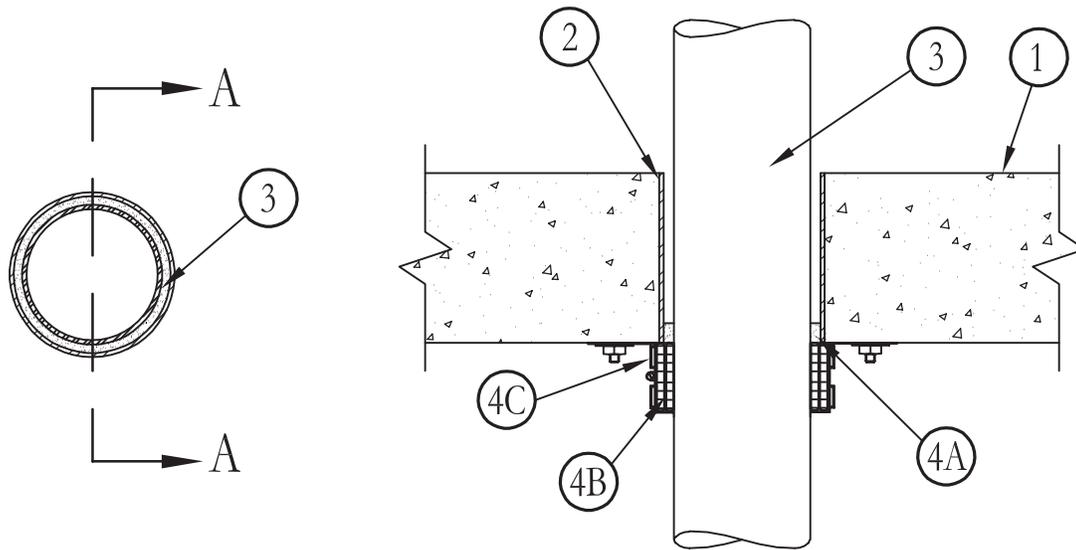

SECTION A-A

1. **Floor or Wall Assembly** – Min 4-1/2 in. (114 mm) thick reinforced lightweight or normal weight (100-150 pcf or 1600 - 2400 kg/m³) concrete. Wall may also be constructed of any UL Classified **Concrete Blocks***. Floor may also be constructed of any 6 in. (152 mm) thick UL Classified hollow core **Precast Concrete Units***. For nom 2-1/2 in. (64 mm) diam and smaller pipes and conduits, diam of opening shall be 1/2 in. (13 mm) larger than nom pipe diam. For pipes and conduits greater than nom 2-1/2 in. (64 mm) diam of opening shall be 1 in. (25 mm) larger than nom pipe diam.
See **Concrete Blocks (CAZT)** and **Precast Concrete Units (CFTV)** categories in the Fire Resistance Directory for names of manufacturers.
2. **Steel Sleeve** – (Optional,) – Nom 4 in. (102 mm) diam (or smaller) Schedule 10 (or heavier) steel sleeve cast or grouted into floor or wall assembly. **When Steel Sleeve is used, T Rating is 1-3/4 hr.**
3. **Through Penetrants** – One nonmetallic pipe or conduit to be centered within opening with a nom annular space between pipe or conduit and periphery of 1/8 in. (3.2 mm) for nom 2-1/2 in. (64 mm) diam and smaller pipes and conduits and 1/4 in. (6 mm) for pipes and conduits greater than nom 2-1/2 in. (64 mm). Pipe or conduit to be rigidly supported on both sides of the floor or wall assembly. The following types and sizes of nonmetallic pipes may be used:
 - A. **Polyvinyl Chloride (PVC) Pipe** – Nom 4 in. (102 mm) diam (or smaller) Schedule 40 solid core or cellular core PVC pipe for use in closed (process or supply) or vented (drain, waste or vent) piping systems.
 - B. **Rigid Nonmetallic Conduit++** – Nom 4 in. (102 mm) diam (or smaller) Schedule 40 PVC conduit installed in accordance with Article 347 of the National Electrical Code (NFPA No. 70).
 - C. **Chlorinated Polyvinyl Chloride (CPVC) Pipe** – Nom 4 in. (102 mm) diam (or smaller) SDR13.5 CPVC pipe for use in closed (process or supply) or vented (drain, waste or vent) piping systems.
 - D. **Acrylonitrile Butadiene Styrene (ABS) Pipe** – Nom 4 in. (102 mm) diam (or smaller) Schedule 40 solid core or cellular core ABS pipe for use in closed (process or supply) or vented (drain, waste or vent) piping systems.
 - E. **Fire Retardant Polypropylene (FRPP) Pipe** – Nom 4 in. (102 mm) diam (or smaller) Schedule 40 FRPP pipe for use in closed (process or supply) or vented (drain, waste or vent) piping systems.
4. **Firestop System** – The firestop system shall consist of the following:
 - A. **Fill, Void or Cavity Materials* – Caulk or Sealant** – Min 1/4 in. (6 mm) thickness of caulk applied within annular space, flush with bottom of floor, or both sides of wall.
3M COMPANY – CP 25WB+ caulk, FB-3000 WT sealant, IC 15WB+ caulk, or FireDam 150+ caulk
(Note: W Rating applies only when FB-3000 WT is used. CP 25WB+ and FireDam 150+ not suitable for use with CPVC pipes.)
 - A1. **Fill, Void or Cavity Materials* – Sealant (Optional, Not Shown)** – For floor assemblies, min 1/2 in. (13 mm) thickness of sealant may be applied within the annular space flush with top surface of floor.
3M COMPANY – FB-1000 NS or FB-3000 WT
(Note: W Rating applies when FB-3000 WT or FB-1000 NS is used.)
 - B. **Fill, Void or Cavity Materials* – Wrap Strip** – Nom 1/8 in. (3.2 mm) thick intumescent material supplied in 2 in. (51 mm) wide strips. Wrap strip tightly wrapped around nonmetallic pipe with continuous layers and butted tightly against the bottom surface of the floor or both surfaces of the wall. For nom 2 in. (51 mm) diam (and smaller) pipes, one layer is required. For nom 2-1/2 and 3 in. (64 and 76 mm) diam pipes, two layers are required. For nom 3-1/2 and 4 in. (89 and 102 mm) diam pipes, three layers are required. Wrap strip layers temporarily held in position using aluminum foil tape, steel wire tie, or equivalent.
3M COMPANY – Ultra GS

System No. C-AJ-2242 *continued*

- C. **Steel Collar** – Nom 2 in. (51 mm) deep collar with 1-1/4 in. (32 mm) wide by 2 in. (51 mm) long anchor tabs and min 1/2 in. (13 mm) long tabs to retain wrap strip layers. Coils of precut 0.016 in. (0.41 mm) thick (28 gauge) galv sheet steel available from wrap strip manufacturer. As an alternate, collar may be field-fabricated from min 0.016 in. (0.41 mm) thick (28 gauge) galv sheet steel in accordance with instruction sheet supplied by wrap strip manufacturer. Steel collar, with anchor tabs bent outward 90 degree, wrapped tightly around wrap strip layers with min 1 in. (25 mm) overlap at seam. Anchor tabs to be pressed tightly against floor or wall surface(s), and collar to be compressed around wrap strip layers using a min 1/2 in. (13 mm) wide by 0.028 in. (0.71 mm) thick stainless steel band clamp at the collar midheight. As an alternate to the band clamp, collar for systems with three or more layers of wrap strip may be fastened together along the overlapping seam with three No. 6 by 3/8 in. (10 mm) long self-tapping steel screws. Collar to be secured to floor or wall surface(s) with 1/4 in. (6 mm) diam by min 1-1/2 in. (38 mm) long steel expansion bolts in conjunction with steel nuts and min 1-1/4 in. (32 mm) diam steel fender washers. Min of two, three or four anchor bolts, symmetrically located, for nom 2 in. (51 mm) diam (and smaller), nom 3 in. (76 mm) diam (and smaller) and nom 4 in. (102 mm) diam (and smaller), pipes, respectively.
- D. **Firestop Device*** – As an alternate to Items 4B and 4C, firestop device to be installed in accordance with the accompanying installation instructions. Firestop device to be installed and latched around pipe and secured to the underside of the floor or both side walls with Ultra Fast Anchor Straps or with 1/4 in. (6 mm) diam by min 1-1/4 in. (32 mm) long steel anchor bolts in conjunction with min 1-1/4 in. (32 mm) diam steel fender washers. Min of two, three or four anchor straps or anchor bolts, symmetrically located, for nom 2, 3 and 4 in. (51, 76 and 102 mm) diam pipes, respectively.
- 3M COMPANY** – Ultra RC Pack 2.0, 3.0, 4.0.

*Bearing the UL Classification Marking

Reprinted from the Online Certifications Directory with permission from Underwriters Laboratories Inc.
Copyright © 2011 Underwriters Laboratories Inc.®

Through Penetrations

Non-Metallic Pipes

2000 Series

Concrete

CAJ

System No. C-AJ-2255

November 20, 2009

F Rating – 2 Hr

T Rating – 2 Hr

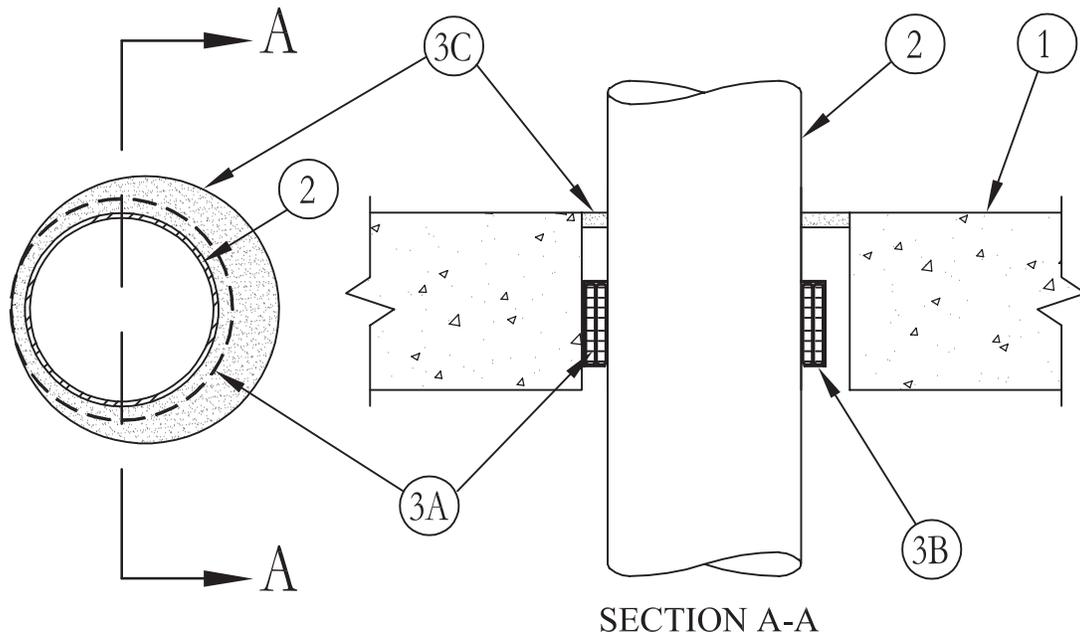

1. **Floor or Wall Assembly** – Min 4-1/2 in. (114 mm) thick reinforced lightweight or normal weight (100-150 pcf or 1600 - 2400 kg/m³) concrete. Wall may also be constructed of any UL Classified **Concrete Blocks***. Max diam of opening is 6 in. (152 mm).
See **Concrete Blocks (CAZT)** category in the Fire Resistance Directory for names of manufacturers.
2. **Through Penetrants** – One nonmetallic pipe or conduit to be installed either concentrically or eccentrically within the firestop system. The annular space between the pipe or conduit and the periphery of the opening shall be a min of 3/8 in. (10 mm) to a max 1-1/8 in. (29 mm). Pipe to be rigidly supported on both sides of the floor or wall assembly. The following types and sizes of nonmetallic pipes or conduits may be used:
 - A. **Polyvinyl Chloride (PVC) Pipe** – Nom 4 in. (102 mm) diam (or smaller) Schedule 40 solid core or cellular core PVC pipe for use in closed (process or supply) or vented (drain, waste or vent) piping systems.
 - B. **Chlorinated Polyvinyl Chloride (CPVC) Pipe** – Nom 4 in. (102 mm) diam (or smaller) SDR13.5 CPVC pipe for use in closed (process or supply) piping systems
3. **Firestop System** – The firestop system shall consist of the following:
 - A. **Fill, void or cavity Materials* – Wrap Strip** – Nom 1/8 in. (3.2 mm) thick intumescent material supplied in 2 in. (51 mm) wide strips. Wrap strip tightly wrapped around nonmetallic pipe with continuous layers recessed 1-1/4 in. (32 mm) below surface of floor. For nom 2 in. (51 mm) diam (and smaller) pipes, one layer is required. For nom 2-1/2 and 3 in. (64 and 76 mm) diam pipes, two layers are required. For nom 3-1/2 and 4 in. (89 and 102 mm) diam pipes, three layers are required. Wrap strip layers temporarily held in position using aluminum foil tape, steel wire tie, or equivalent.
3M COMPANY – Ultra GS
 - B. **Steel Collar** – Nom 2 in. (51 mm) wide collar with 1/2 in. (13 mm) long tabs to retain wrap strip layers. Coils of precut 0.016 in. (0.41 mm) thick (28 gauge) galv sheet steel available from wrap strip manufacturer. As an alternate, collar may be field-fabricated from min 0.016 in. (0.41 mm) thick (28 gauge) galv sheet steel in accordance with instruction sheet supplied by wrap strip manufacturer. Steel collar, with anchor tabs removed wrapped tightly around wrap strip layers with min 1 in. (25 mm) overlap at seam. Collar to be compressed around wrap strip layers and secured with min 1/2 in. (13 mm) wide filament tape or foil tape wrapped completely around collar at the mid height of the collar. Wrap strip/collar assembly to be recessed 1-1/4 in. (32 mm) from bottom surface of floor or both surfaces of wall.
 - C. **Fill, Void or Cavity Materials* – Caulk or Sealant** – Min 1/4 in. (6 mm) thickness of calk installed in annular space, flush with top surface of the floor or both surfaces of wall.
3M COMPANY – CP 25WB+, IC 15WB+, FireDam 150+ caulk or FB-1000 NS, FB-3000 WT sealant.
(Note: CP 25WB+ and FireDam 150+ not suitable for use with CPVC pipes.)

*Bearing the UL Classification Mark

++Bearing the UL Listing Mark

Reprinted from the Online Certifications Directory with permission from Underwriters Laboratories Inc.
Copyright © 2011 Underwriters Laboratories Inc.®

System No. C-AJ-2256

May 18, 2005
F Rating – 2 Hr
T Rating – 1/4 Hr

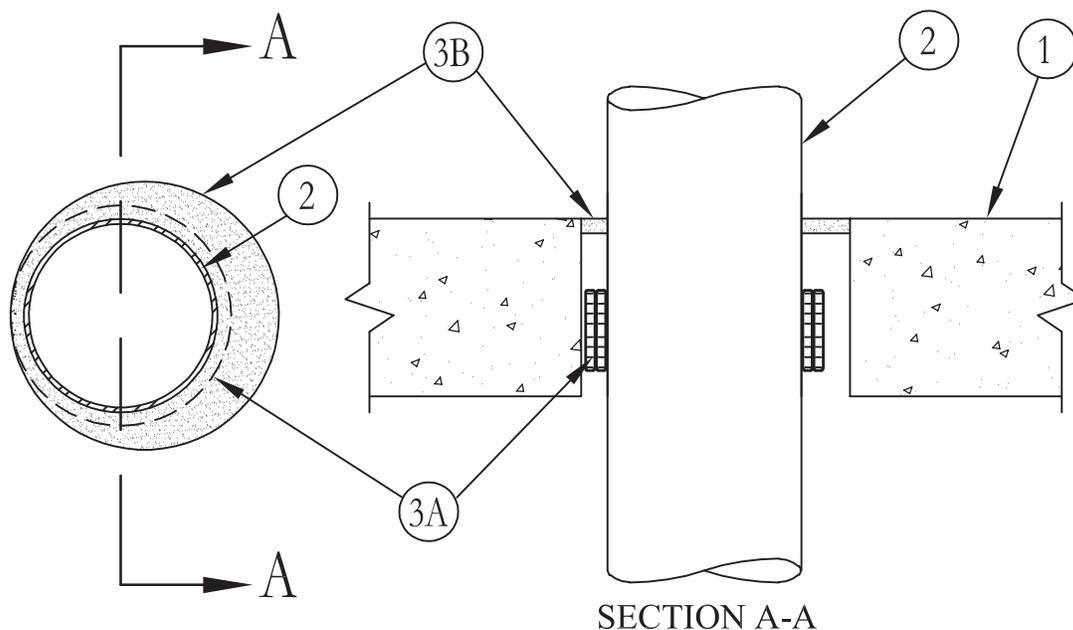

- Floor or Wall Assembly** – Min 4-1/2 in. (114 mm) thick reinforced lightweight or normal weight (100-150 pcf or 1600-2400 kg/m³) concrete. Max diam of opening is 5 in. (127 mm).
- Through Penetrants** – One nonmetallic pipe to be installed either concentrically or eccentrically within the firestop system. The annular space between the pipe and the periphery of the opening shall be a min of 3/8 in. to a max 1-1/8 in. (10 mm to max 29 mm) Pipe to be rigidly supported on both sides of the floor or wall assembly. The following types and sizes of nonmetallic pipes or conduits may be used:
 - Polyvinyl Chloride (PVC) Pipe** – Nom 3 in. (76 mm) diam (or smaller) Schedule 40 solid core PVC pipe for use in closed (process or supply) or vented (drain, waste or vent) piping systems.
 - Chlorinated Polyvinyl Chloride (CPVC) Pipe** – Nom 3 in. (76 mm) diam (or smaller) SDR13.5 CPVC pipe for use in closed (process or supply) piping systems.
- Firestop System** – The firestop system shall consist of the following:
 - Fill, Void or Cavity Materials* – Wrap Strip** – Nom 1/8 in. (3.2 mm) thick intumescent material supplied in 2 in. (51 mm) wide strips. Min three continuous layers of wrap strip tightly wrapped around nonmetallic pipe. Wrap strip secured with two 1/2 in. (13 mm) wide bands of filament tape completely wrapped around layers of wrap 1/2 in. (13 mm) from bottom of wrap strips. Wrap strips to be covered with one layer of 2 in. (51 mm) wide min 3 mil thick foil tape and recessed 1-1/4 in. (32 mm) from bottom of floor or both surfaces of wall.
3M COMPANY – Ultra GS
 - Fill, Void or Cavity Materials* – Caulk or Sealant** – Min 1/2 in. (13 mm) thickness of caulk installed in annular space, flush with top surface of floor or both surfaces of wall.
3M COMPANY – CP 25WB+, IC 15WB+ caulk or FB-3000 WT sealant.
(Note: CP 25WB+ not suitable for use with CPVC pipes.)

*Bearing the UL Classification Mark

+Bearing the UL Listing Mark

Reprinted from the Online Certifications Directory with permission from Underwriters Laboratories Inc.
Copyright © 2011 Underwriters Laboratories Inc.®

System No. C-AJ-2268

May 20, 2005

F Rating – 2 Hr

T Rating – 2 Hr

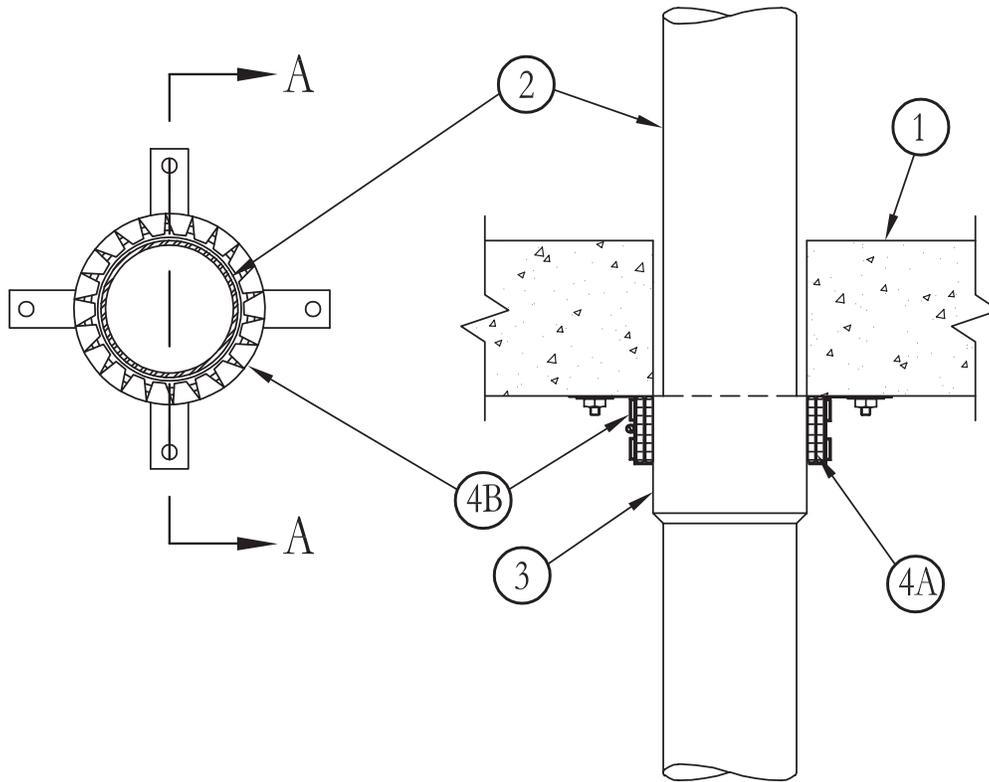

SECTION A-A

1. **Floor or Wall Assembly** – Min 4-1/2 in. (114 mm) thick reinforced lightweight or normal weight (100-150 pcf or 1600-2400 kg/m³) concrete. Wall may also be constructed of any UL Classified **Concrete Blocks***. Floor may also be constructed of any min 6 in. (152 mm) thick UL Classified hollow-core **Precast Concrete Units**. Max diam of opening is 5 in. (127 mm).
See **Concrete Blocks** and **Precast Concrete Units (CAZT)** category in the Fire Resistance Directory for names of manufacturers.
2. **Through Penetrants** – One nonmetallic pipe or conduit to be installed either concentrically or eccentrically within the firestop system. The annular space between the pipe or conduit and the periphery of the opening shall be a min of 0 in. (point contact) to a max 1/2 in. (0 mm to max 13 mm). Pipe or conduit to be rigidly supported on both sides of the floor or wall assembly. The following types and sizes of nonmetallic pipes or conduits may be used:
 - A. **Polyvinyl Chloride (PVC) Pipe** – Nom 4 in. (102 mm) diam (or smaller) Schedule 40 solid core or cellular core PVC pipe for use in closed (process or supply) or vented (drain, waste or vent) piping systems.
 - B. **Rigid Nonmetallic Conduit++** – Nom 4 in. (102 mm) diam (or smaller) Schedule 40 PVC conduit installed in accordance with Article 347 of the National Electrical Code (NFPA No. 70).
 - C. **Chlorinated Polyvinyl Chloride (CPVC) Pipe** – Nom 4 in. (102 mm) diam (or smaller) SDR13.5 CPVC pipe for use in closed (process or supply) piping systems.
 - D. **Acrylonitrile Butadiene Styrene (ABS) Pipe** – Nom 4 in. (102 mm) diam (or smaller) Schedule 40 solid core or cellular core ABS pipe for use in closed (process or supply) or vented (drain, waste or vent) piping systems.
3. **Nonmetallic Pipe Coupling** – Nom 4 in. (102 mm) diam (or smaller) Schedule 40 PVC pipe coupling or nom 4 in. (102 mm) diam (or smaller) SDR 13.5 CPVC pipe coupling installed such that the top of the coupling is flush with the bottom surface of the floor assembly or flush with either side of the wall assembly and extending outward.
4. **Firestop System** – The firestop system shall consist of the following:
 - A. **Fill, Void or Cavity Materials* – Wrap Strip** – Nom 1/8 in. (3.2 mm) thick intumescent material supplied in 2 in. (51 mm) wide strips. Wrap strip tightly wrapped around nonmetallic pipe with continuous layers and butted tightly against the bottom surface of the floor or both surfaces of the wall. For nom 2 in. (51 mm) diam (and smaller) pipes, one layer is required. For nom 2-1/2 in. and 3 in. (64 mm and 76 mm) diam pipes, two layers are required. For nom 3-1/2 in. and 4 in. (89 mm and 102 mm) diam pipes, three layers are required. Wrap strip layers temporarily held in position using aluminum foil tape, steel wire tie, or equivalent.
3M COMPANY – Ultra GS
 - B. **Steel Collar** – Nom 2 in. (51 mm) deep collar with 1-1/4 in. (32 mm) wide by 2 in. (51 mm) long anchor tabs and min 1/2 in. (13 mm) long tabs to retain wrap strip layers. Coils of precut 0.016 in. (0.41 mm) thick (28 gauge) galv sheet steel available from wrap strip manufacturer. As an alternate, collar may be field-fabricated from min 0.016 in. (0.41 mm) thick (28 gauge) galv sheet steel in

System No. C-AJ-2268 *continued*

accordance with instruction sheet supplied by wrap strip manufacturer. Steel collar, with anchor tabs bent outward 90 deg, wrapped tightly around wrap strip layers with min 1 in. (25 mm) overlap at seam. Anchor tabs to be pressed tightly against floor or wall surface(s), and compressed around wrap strip layers using a min 1/2 in. (13 mm) wide by 0.028 in. (0.71 mm) thick stainless steel band clamp at the collar midheight. As an alternate to the band clamp, collar for systems with three or more layers of wrap strip may be fastened together along the overlapping seam with three No. 10 by 3/8 in. (10 mm) long self-tapping steel screws. Collar to be secured to floor or wall surface(s) with min 3/16 in. (5 mm) diam by min 1-1/4 in. (32 mm) long steel masonry anchors in conjunction with steel nuts and min 1-1/4 in. (32 mm) diam steel fender washers. Min of two, three or four anchors, symmetrically located, for nom 2 in. (51 mm) diam (and smaller), nom 3 in. (76 mm) diam (and smaller) and nom 4 in. (102 mm) diam (and smaller), pipes, respectively.

- C. **Fill, Void or Cavity Materials* – Caulk, Sealant or Putty** – In precast hollow-core floor assemblies, a min 1/4 in. (6 mm) thickness of caulk or putty shall be used to fill the annular space on the top side of the floor. An additional 1/4 in. (6 mm) diam bead of caulk or putty shall be applied to the penetrant/concrete interface at the point contact location on the top surface of floor. For solid concrete floors, a bead of caulk or putty may be used to fill the annular space on the top side of the floor as an option (not required). As an option (not required), a bead of caulk or putty may be applied to outer perimeter of steel collar at its interface with floor or wall surfaces.

3M COMPANY – CP 25WB+ caulk, FB-3000 WT sealant or MP+ Stix putty.
(Note: CP 25WB+ not suitable for use with CPVC pipes.)

*Bearing the UL Classification Mark

++Bearing the UL Listing Mark

Reprinted from the Online Certifications Directory with permission from Underwriters Laboratories Inc.
Copyright © 2011 Underwriters Laboratories Inc.®

Through Penetrations

Non-Metallic Pipes

2000 Series

Concrete

CAJ

System No. C-AJ-2278

August 23, 2004

F Rating – 2 Hr

T Rating – 0 Hr

W Rating – Class I (See Item 3)

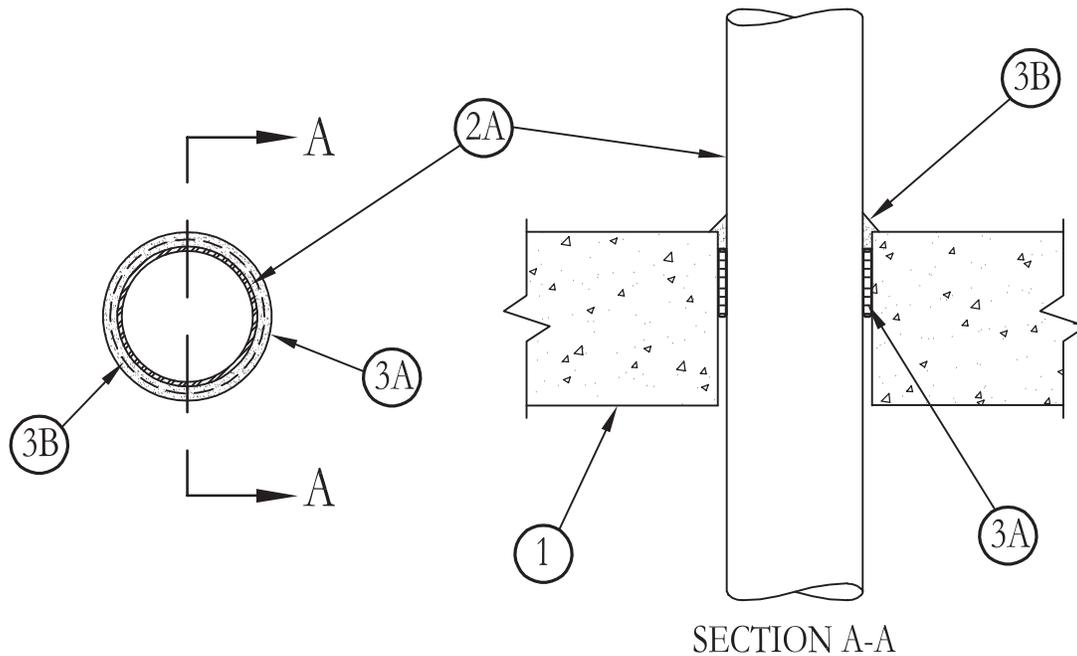

1. **Floor or Wall Assembly** – Min 4-1/2 in. thick reinforced lightweight or normal weight (100-150 pcf) concrete. Wall may also be constructed of any UL Classified **Concrete Blocks***. Max diam of opening is 4 in.
See **Concrete Blocks (CAZT)** category in the Fire Resistance Directory for names of manufacturers.
2. **Through Penetrants** – One nonmetallic pipe or conduit to be installed concentrically within the firestop system. The annular space between the pipe or conduit and the periphery of the opening shall be 1/4 in. Pipe or conduit to be rigidly supported on both sides of the floor or wall assembly. The following types and sizes of nonmetallic pipes or conduits may be used:
 - A. **Polyvinyl Chloride (PVC) Pipe** – Nom 3 in. diam (or smaller) Schedule 40 solid core or cellular core PVC pipe for use in closed (process or supply) or vented (drain, waste or vent) piping systems.
 - B. **Rigid Nonmetallic Conduit++** – Nom 3 in. diam (or smaller) Schedule 40 PVC conduit installed in accordance with Article 347 of the National Electrical Code (NFPA No. 70).
 - C. **Chlorinated Polyvinyl Chloride (CPVC) Pipe** – Nom 3 in. diam (or smaller) SDR13.5 CPVC pipe for use in closed (process or supply) piping systems.
 - D. **Acrylonitrile Butadiene Styrene (ABS) Pipe** – Nom 3 in. diam (or smaller) Schedule 40 solid core or cellular core ABS pipe for use in closed (process or supply) or vented (drain, waste or vent) piping systems.
3. **Firestop System** – The firestop system shall consist of the following:
 - A. **Fill, Void or Cavity Materials* – Wrap Strip** – Min 1/8 in. thick intumescent material supplied in 2 in. wide strips. Wrap strip tightly wrapped around nonmetallic pipe with continuous layers and secured with two 1/4 in. wide bands of filament tape placed 1/2 in. from bottom and top of wrap strip. The layers of wrap strip are to be recessed within the opening such that the top of the wrap strip layers is 1/4 in. below top surface of floor. For wall assemblies, wrap strip layers to be installed on both sides of wall and recessed within wall such that the end of the layers is recessed 1/4 in. from both surfaces of wall. For nom 2 in. diam (and smaller) pipes, one layer is required. For nom 2-1/2 in. and 3 in. diam pipes, two layers are required.
3M COMPANY – Ultra GS
 - B. **Fill, Void or Cavity Materials* – Sealant** – Min 1/4 in. thickness of sealant applied within annular space, flush with top surface of floor or both surfaces of wall.
3M COMPANY – FB-1000 NS, FB-1003 SL or FB-3000 WT sealant.

*Bearing the UL Classification Mark

++Bearing the UL Listing Mark

Reprinted from the Online Certifications Directory with permission from Underwriters Laboratories Inc.

Copyright © 2011 Underwriters Laboratories Inc.®

System No. C-AJ-2299

November 20, 2009

F Rating – 2 Hr

T Rating – 2 Hr

W Rating – Class 1 (See Item 3)

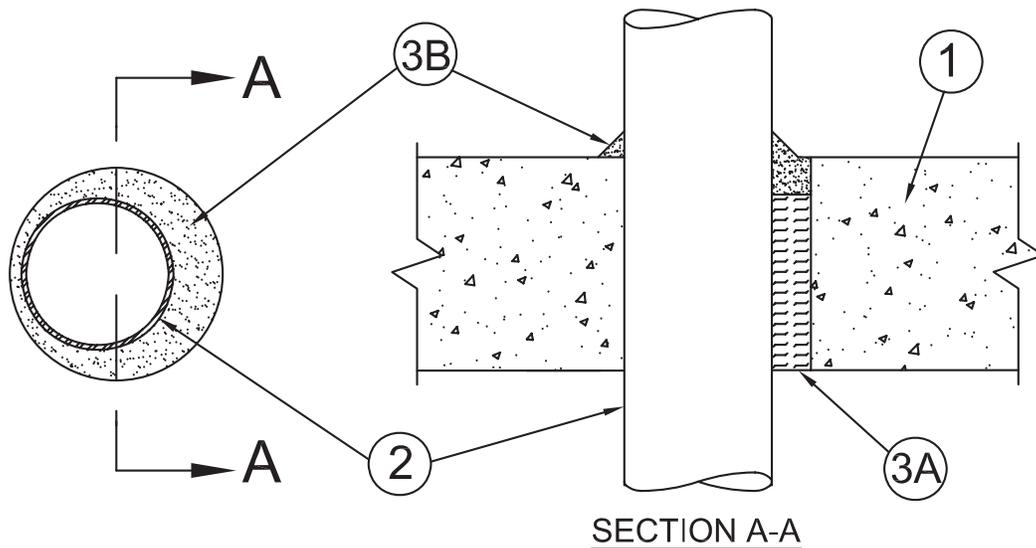

- Floor or Wall Assembly** – Min 4-1/2 in. (114 mm) thick reinforced lightweight or normal weight (100-150 pcf or 1600- 2400 kg/m³) concrete. Wall may also be constructed of any UL Classified **Concrete Blocks***. Max diam of opening is 3 in. (76 mm).
See **Concrete Blocks (CAZT)** in Volume 1 of the Fire Resistance Directory for names of manufacturers.
- Through Penetrants** – One nonmetallic pipe or conduit to be installed either concentrically or eccentrically within the firestop system. The annular space between the pipe or conduit and the periphery of the opening shall be min 0 in. (0 mm, point contact) to max 5/8 in. (16 mm). Pipe or conduit to be rigidly supported on both sides of the floor or wall assembly. The following types and sizes of nonmetallic pipes or conduit may be used:
 - Polyvinyl Chloride (PVC) Pipe** – Nom 2 in. (51 mm) diam (or smaller) Schedule 40 solid core or cellular core PVC pipe for use in closed (process or supply) piping systems.
 - Rigid Nonmetallic Conduit++** – Nom 2 in. (51 mm) diam (or smaller) Schedule 40 PVC conduit installed in accordance with the National Electrical Code (NFPA No. 70).
 - Chlorinated Polyvinyl Chloride (CPVC) Pipe** – Nom 2 in. (51 mm) diam (or smaller) SDR11 CPVC pipe for use in closed (process or supply) piping system.
 - Acrylonitrile Butadiene Styrene (ABS) Pipe** – Nom 2 in. (51 mm) diam (or smaller) Schedule 40 solid core or cellular core ABS pipe for use in closed (process or supply) piping systems.
 - Electrical Nonmetallic Tubing (ENT) ++** – Nom 1 in. (25 mm) diam (or smaller) ENT installed in accordance with the National Electric Code (NFPA No. 70).See **Rigid Nonmetallic Conduit (DZKT)** and **Electrical Nonmetallic Tubing (FKHU)** categories in the Electrical Construction Equipment Directory for names of manufacturers.
- Firestop System** – The firestop system shall consist of the following:
 - Packing Material** – Min 4 in. (102 mm) thickness of min 4 pcf (64 kg/m³) mineral wool batt insulation packed into the opening as a permanent form. Packing material to be recessed from top surface of floor or from both surfaces of wall to accommodate the required thickness of caulk.
 - Forming Material*** – As an alternate to the packing material in Item 3A, nom 4 in. (102 mm) wide strips of min 1/2 in (13 mm) thick compressible mat to be stacked to a thickness greater than the width of the annular space and compression-fitted, edge-first, to fill the annular space to a min 4 in. (102 mm) depth. Top of forming material to be recessed from top surface of floor or from both surfaces of wall as necessary to accommodate the required thickness of caulk fill material.
3M COMPANY – Fire Barrier Packing Material
 - Fill, Void or Cavity Materials* – Caulk or Sealant** – Min 1/2 in. (13 mm) thickness of caulk applied within the annulus, flush with top surface of floor or both surfaces of wall. An additional 1/2 in. (13 mm) diam bead of caulk applied at point contact location between penetrant/floor or penetrant/wall interface.
3M COMPANY – FireDam 150+, CP 25WB+, IC 15WB+ caulk or FB-3000 WT sealant
(Note: W Rating applies only when FB-3000 WT is used. CP 25WB+ and FireDam 150+ not suitable for use with CPVC pipes).

*Bearing the UL Classification Mark

++Bearing the UL Listing Mark

Reprinted from the Online Certifications Directory with permission from Underwriters Laboratories Inc.

Copyright © 2011 Underwriters Laboratories Inc.®

Through Penetrations

Non-Metallic Pipes

2000 Series

Concrete

CAJ

System No. C-AJ-2312

September 26, 2001

F Rating – 2 Hr

T Rating – 2 Hr

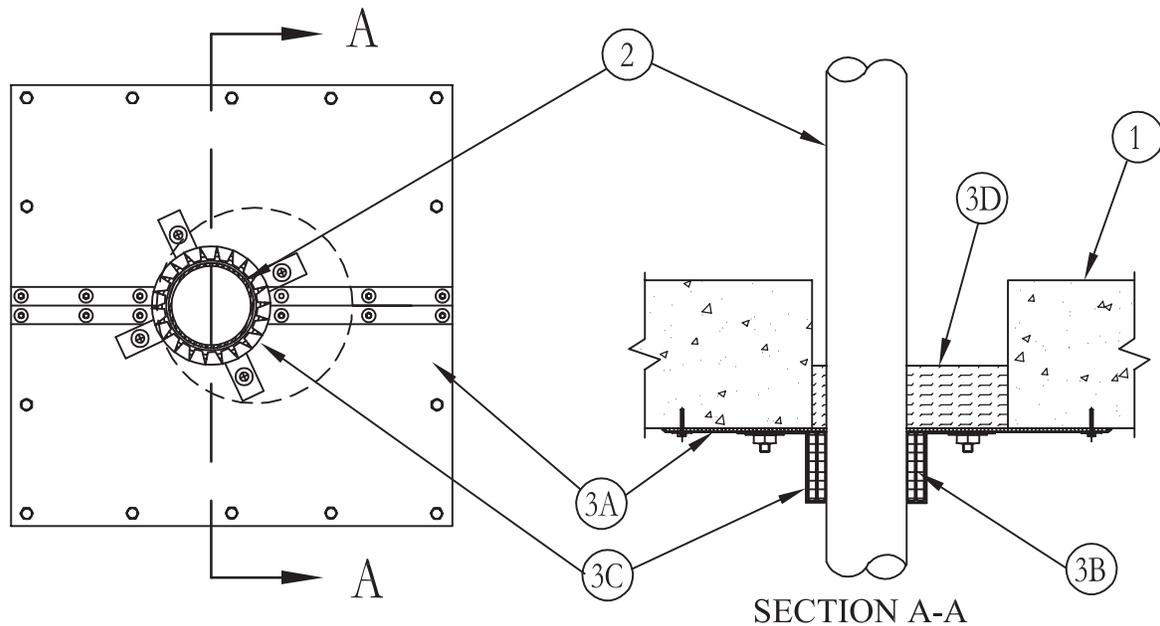

1. **Floor or Wall Assembly** – Min 4-1/2 in. thick reinforced lightweight or normal weight (100-150 pcf) concrete. Wall may also be constructed of any UL Classified **Concrete Blocks***. Max diam of opening is 9 in.
See **Concrete Blocks (CAZT)** category in the Fire Resistance Directory for names of manufacturers.
2. **Through Penetrants** – One nonmetallic pipe or conduit to be installed either concentrically or eccentrically within the firestop system. The annular space between penetrant and periphery of opening shall be min 1/2 in. to max 4 in. Penetrant to be rigidly supported on both sides of floor or wall assembly. The following types and sizes of pipes or conduit may be used:
 - A. **Polyvinyl Chloride (PVC) Pipe** – Nom 4 in. diam (or smaller) Schedule 40 solid core or cellular core PVC pipe for use in closed (process or supply) or vented (drain, waste or vent) piping systems.
 - B. **Chlorinated Polyvinyl Chloride (CPVC) Pipe** – Nom 4 in. diam (or smaller) SDR13.5 CPVC pipe for use in closed (process or supply) piping systems.
 - C. **Rigid Nonmetallic Conduit++** – Nom 4 in. diam (or smaller) Schedule 40 PVC conduit installed in accordance with Article 347 of the National Electric Code (NFPA No. 70).
3. **Firestop System** – The firestop system shall consist of the following:
 - A. **Steel Cover Plate** – Min 18 gauge galv steel cover plate, sized to overlap opening a min of 3 in. on all sides. Opening in plate for penetrant to be sized to the outside diam of penetrant. Plate attached to bottom of floor on both sides of wall with min 3/16 in. by 1-1/4 in. long steel masonry anchors spaced a max of 4 in. OC. Seams in plate covered with min 2 in. wide 28 gauge (or heavier) galv steel and attached to cover plate with No. 10 (or larger) steel screws on each side of seam spaced a max of 3 in. OC.
 - B. **Fill, Void or Cavity Materials* – Wrap Strip** – Nom 1/8 in. thick intumescent material supplied in 2 in. wide strips. Wrap strip tightly wrapped around nonmetallic pipe with continuous layers and butted tightly against the bottom surface of cover plate for floors or tightly against cover plate on both surfaces of the wall. For nom 2 in. diam (and smaller) pipes, two layers are required. For nom 2-1/2 in. to 4 in. diam pipes, four layers are required. Wrap strip layers temporarily held in position using aluminum foil tape, steel wire tie, or equivalent.
3M COMPANY – Ultra GS
 - C. **Steel Collar** – Nom 2 in. deep collar with 1-1/4 in. wide by 2 in. long anchor tabs and min 1/2 in. long tabs to retain wrap strip layers. Coils of precut 0.016 in. thick (28 gauge) galv sheet steel available from wrap strip manufacturer. As an alternate, collar may be field-fabricated from min 0.016 in. thick (28 gauge) galv sheet steel in accordance with instruction sheet supplied by wrap strip manufacturer. Steel collar, with anchor tabs bent outward 90 deg, wrapped tightly around wrap strip layers with min 1 in. overlap at seam. Anchor tabs to be pressed tightly against cover plate, and collar to be compressed around wrap strip layers using a min 1/2 in. wide by 0.028 in. thick stainless steel band clamp at the collar midheight. As an alternate to the band clamp, collar for systems with three or more layers of wrap strip may be fastened together along with three No. 6 by 3/8 in. long self-tapping steel screws. Collar to be secured to cover plate with No. 10 (or larger) by min 3/4 in. long steel screws in conjunction with min 1-1/4 in. diam steel washers. Min of two, three or four anchor bolts, symmetrically located, for nom 2 in. diam (and smaller), nom 2-1/2 to 3 in. diam and nom 3-1/2 to 4 in. diam pipes, respectively.
 - D. **Packing Material** – Min 2 in. thickness of min 4 pcf mineral wool batt insulation firmly packed into opening as a permanent form. Packing material to be installed on top surface of cover plate, flush with bottom surface of floor or both surfaces of wall.

*Bearing the UL Classification Mark

+Bearing the UL Recognized Component Marking

Reprinted from the Online Certifications Directory with permission from Underwriters Laboratories Inc.

Copyright © 2010 Underwriters Laboratories Inc.®

System No. C-AJ-2313

September 26, 2001

F Rating – 2 Hr

T Rating – 2 Hr

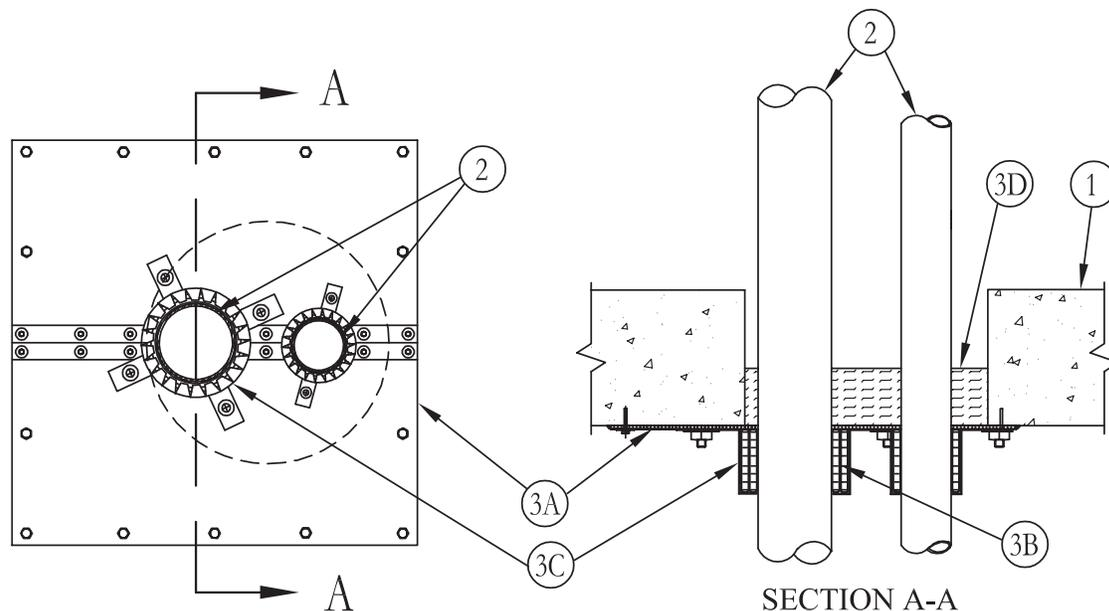

- 1. Floor or Wall Assembly** – Min 4-1/2 in. thick reinforced lightweight or normal weight (100-150 pcf) concrete. Wall may also be constructed of any UL Classified **Concrete Blocks***. Max diam of opening is 10-1/2 in.
See **Concrete Blocks (CAZT)** category in the Fire Resistance Directory for names of manufacturers.
- 2. Through Penetrants** – Two nonmetallic pipes or conduit to be installed either concentrically or eccentrically within the firestop system. The annular space between penetrant and periphery of opening shall be min 1/2 in. to max 3-1/2 in. Penetrant to be rigidly supported on both sides of floor or wall assembly. The annular space between penetrants shall be min 1 in. to max 3-1/2 in. One penetrant not to exceed 4 in. diam in size. Other penetrant not to exceed nom 2 in. diam in size. The following types and sizes of pipes or conduit may be used:
 - A. Polyvinyl Chloride (PVC) Pipe** – Schedule 40 solid core or cellular core PVC pipe for use in closed (process or supply) or vented (drain, waste or vent) piping systems.
 - B. Chlorinated Polyvinyl Chloride (CPVC) Pipe** – SDR13.5 CPVC pipe for use in closed (process or supply) piping systems.
 - C. Rigid Nonmetallic Conduit++** – Schedule 40 PVC conduit installed in accordance with Article 347 of the National Electric Code (NFPA No. 70).
 - D. Acrylonitrile Butadiene (ABS) Pipe** – Schedule 40 solid core or cellular core ABS pipe for use in closed (process or supply) or vented (drain, waste or vent) piping systems.
- 3. Firestop System** – The firestop system shall consist of the following:
 - A. Steel Cover Plate** – Min 18 gauge galv steel cover plate, sized to overlap opening a min of 3 in. on all sides. Openings in plate for penetrants to be sized to the outside diam of penetrant. Plate attached to bottom of floor or both sides of wall with min 3/16 in. by 1-1/4 in. long steel masonry anchors spaced a max of 4 in. OC. Seams in plate covered with min 2 in. wide 28 gauge (or heavier) galv steel and attached to cover plate with No. 10 (or larger) steel screws on each side of seam spaced a max of 3 in. OC.
 - B. Fill, Void or Cavity Materials*** – **Wrap Strip** – Nom 1/8 in. thick intumescent material supplied in 2 in. wide strips. Wrap strip tightly wrapped around nonmetallic pipe with continuous layers and butted tightly against the bottom surface of cover plate for floors or tightly against cover plate on both surfaces of the wall. For nom 2 in. diam (and smaller) pipes, two layers are required. For nom 2-1/2 in. to 4 in. diam pipes, four layers are required. Wrap strip layers temporarily held in position using aluminum foil tape, steel wire tie, or equivalent.
3M COMPANY – Ultra GS
 - C. Steel Collar** – Nom 2 in. deep collar with 1-1/4 in. wide by 2 in. long anchor tabs and min 1/2 in. long tabs to retain wrap strip layers. Coils of precut 0.016 in. thick (28 gauge) galv sheet steel available from wrap strip manufacturer. As an alternate, collar may be field-fabricated from min 0.016 in. thick (28 gauge) galv sheet steel in accordance with instruction sheet supplied by wrap strip manufacturer. Steel collar, with anchor tabs bent outward 90 deg, wrapped tightly around wrap strip layers with min 1 in. overlap at seam. Anchor tabs to be pressed tightly against cover plate, and collar to be compressed around wrap strip layers using a min 1/2 in. wide by 0.028 in. thick stainless steel band clamp at the collar midheight. As an alternate to the band clamp, collar for systems with three or more layers of wrap strip may be fastened together along with three No. 6 by 3/8 in. long self-tapping steel screws. Collar to be secured to cover plate with No. 10 (or larger) by min 3/4 in. long steel screws in conjunction with min 1-1/4 in. diam steel washers. Min of two, three or four anchor bolts, symmetrically located, for nom 2 in. diam (and smaller), nom 2-1/2 to 3 in. diam and nom 3-1/2 to 4 in. diam pipes, respectively.
 - D. Packing Material** – Min 2 in. thickness of min 4 pcf mineral wool batt insulation firmly packed into opening as a permanent form. Packing material to be installed on top surface of cover plate, flush with bottom surface of floor or both surfaces of wall.

*Bearing the UL Classification Mark

+Bearing the UL Recognized Component Marking

Reprinted from the Online Certifications Directory with permission from Underwriters Laboratories Inc.

Copyright © 2010 Underwriters Laboratories Inc.®

System No. C-AJ-2377

May 19, 2005

F Rating – 2 Hr

T Rating – 2 Hr

W Rating – Class I (See Item 3)

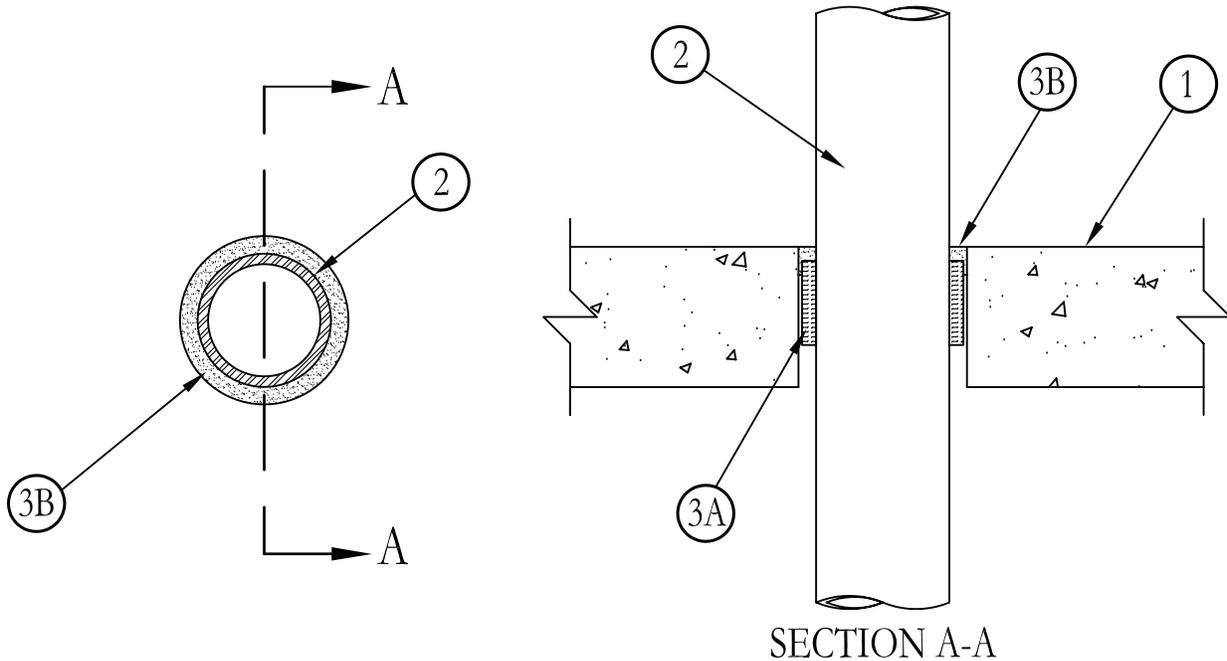

1. **Floor or Wall Assembly** – Min 4-1/2 in. (114 mm) thick reinforced lightweight or normal weight (100-150 pcf or 1600-2400 kg/m³) concrete. Floor assembly may also be constructed of any min 6 in. (152 mm) thick UL Classified hollow-core **Precast Concrete Units***. Wall may also be constructed of any UL Classified **Concrete Blocks***. Max diam of opening 5 in. (127 mm).
See **Concrete Blocks (CAZT)** and **Precast Concrete Units (CFTV)** categories in Fire Resistance Directory for names of manufacturers.
2. **Through Penetrant** – Nom 3 in. (76 mm) diam (or smaller) Schedule 40 polyvinyl chloride (PVC) or SDR13.5 chlorinated polyvinyl chloride (CPVC) pipe for use in closed (process or supply) piping systems. One pipe to be installed concentrically or eccentrically within opening. Annular space between pipe and periphery of opening shall be min 1/2 in. to max 1 in. (13 mm to max 25 mm). Pipe to be rigidly supported on both sides of floor or wall assembly.
3. **Firestop System** – The firestop system shall consist of the following:
 - A. **Packing Material** – Min 3 in. (76 mm) thickness of min 4 pcf (64 kg/m³) mineral wool batt insulation firmly packed into opening as a permanent form. Packing material to be recessed from top surface of floor or from both surfaces of wall as required to accommodate the required thickness of fill material. In floors constructed of hollow-core concrete, packing material to be recessed from top and bottom surfaces of floor as required to accommodate the required thickness of fill material.
 - B. **Fill, Void or Cavity Materials* – Caulk or Sealant** – Min 1/2 in. (13 mm) thickness of caulk applied within the annulus, flush with top surface of floor or with both surfaces of wall. In floors constructed of hollow-core concrete, min 1/2 in. (13 mm) thickness of caulk applied within the annulus, flush with top and bottom surfaces of floor.
3M COMPANY – IC 15WB+, CP 25WB+ caulk or FB-3000 WT sealant.
(Note: W Rating applies only when FB-3000 WT sealant is used. CP 25WB+ not suitable for use with CPVC pipes.)

*Bearing the UL Classification Marking

Reprinted from the Online Certifications Directory with permission from Underwriters Laboratories Inc.
Copyright © 2011 Underwriters Laboratories Inc.®

System No. C-AJ-2378

May 19, 2005

F Rating – 2 Hr

T Rating – 0 Hr

W Rating – Class I (See Item 4)

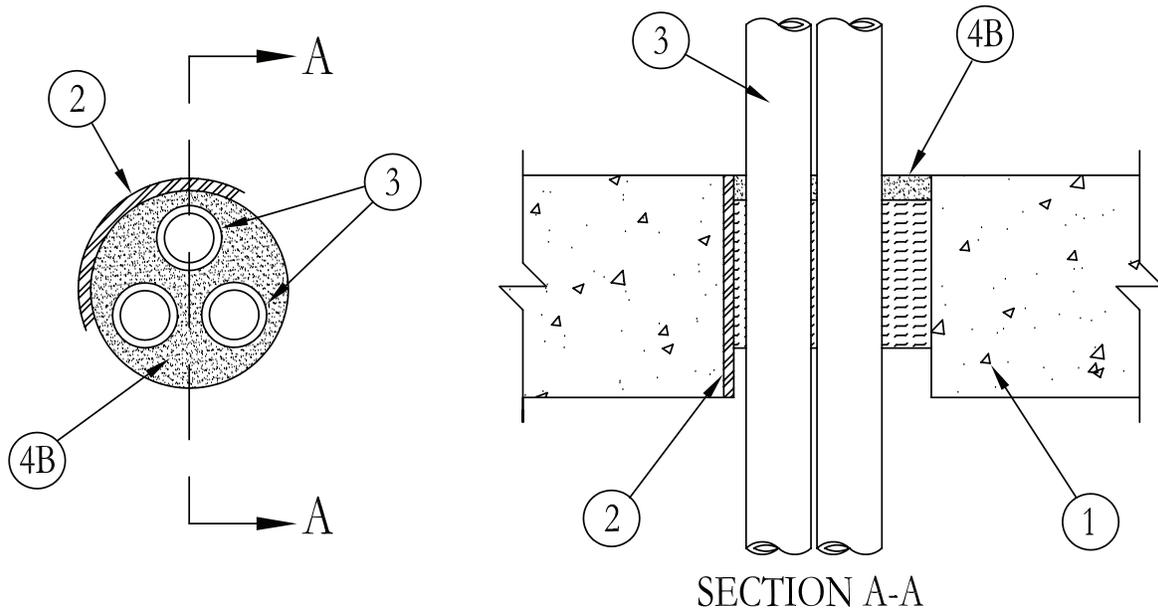

- Floor or Wall Assembly** – Min 4-1/2 in. (114 mm) thick reinforced lightweight or normal weight (100-150 pcf or 1600-2400 kg/m³) concrete. Floor assembly may also be constructed of any min 6 in. (152 mm) thick UL Classified hollow-core **Precast Concrete Units***. Wall may also be constructed of any UL Classified **Concrete Blocks***. Max diam of opening 5 in. (127 mm).
See **Concrete Blocks** (CAZT) and **Precast Concrete Units** (CFTV) categories in Fire Resistance Directory for names of manufacturers.
- Steel Sleeve** (Optional) – Nom 5 in. (127 mm) diam (or smaller) Schedule 10 (or heavier) steel sleeve cast or grouted into floor or wall assembly. Steel sleeve may be installed flush or may project max 2 in. (51 mm) beyond the floor or wall surfaces.
- Through Penetrants** – One or more nonmetallic pipes, conduits or tubes installed concentrically or eccentrically within opening. Annular space between penetrants and periphery of opening or sleeve shall be min of 1/4 in. to max 2 in. (6 mm to max 51 mm). The space between penetrants shall be min of 1/4 in. to max 2 in. (6 mm to max 51 mm). Penetrants to be rigidly supported on both sides of floor or wall assembly. The following types and sizes of penetrants may be used:
 - Polyvinyl Chloride (PVC) Pipe** – Nom 1-1/2 in. (38 mm) diam (or smaller) Schedule 40 solid core PVC pipe for use in closed (process or supply) or vented (drain, waste or vent) piping systems.
 - Rigid Nonmetallic Conduit**+ – Nom 1-1/2 in. (38 mm) diam (or smaller) Schedule 40 PVC conduit installed in accordance with Article 347 of the National Electrical Code (NFPA No. 70).
 - Chlorinated Polyvinyl Chloride (CPVC) Pipe** – Nom 1-1/2 in. (38 mm) diam (or smaller) SDR13.5 CPVC pipe for use in closed (process or supply) piping systems.
 - Crosslinked Polyethylene (PEX) Tubing** – Nom 1 in. (25 mm) diam (or smaller) SDR 9 PEX tubing for use in closed (process or supply) or vented (drain, waste or vent) piping systems.
- Firestop System** – The details of the firestop system shall be as follows:
 - Packing Material** – Min 3 in. (76 mm) thickness of min 4 pcf (64 kg/m³) mineral wool batt insulation firmly packed into opening as a permanent form. Packing material to be recessed from top surface of floor or top edge of sleeve or from both surfaces of wall or both ends of sleeve as required to accommodate the required thickness of fill material. In floors constructed of hollow-core concrete, packing material to be recessed from top and bottom surfaces of floor or sleeve as required to accommodate the required thickness of fill material.
 - Fill, Void or Cavity Materials* – Caulk or Sealant** – Min 1/2 in. (13 mm) thickness of caulk applied within the annulus, flush with top surface of floor or top edge of sleeve or with both surfaces of wall or both ends of sleeves. In floors constructed of hollow-core concrete, min 1/2 in. (13 mm) thickness of caulk applied within the annulus, flush with top and bottom surfaces of floor or sleeve. Min 1/4 in. (6 mm) diam bead of caulk applied to the penetrant/concrete or penetrant/sleeve interface at the point contact location on the top surface of floor or both surfaces of wall or hollow-core concrete.
3M COMPANY – IC 15WB+, CP 25WB+ caulk or FB-3000 WT sealant.
(Note: W Rating applies only when FB-3000 WT sealant is used. CP 25WB+ not suitable for use with CPVC pipes.)

*Bearing the UL Classification Marking

Reprinted from the Online Certifications Directory with permission from Underwriters Laboratories Inc.
Copyright © 2011 Underwriters Laboratories Inc.®

Through Penetrations

Non-Metallic Pipes

2000 Series

Concrete

CAJ

System No. C-AJ-2510

June 30, 2005

F Rating – 2 Hr

T Ratings – 0, 3/4 and 2 Hr (See Item 2)

L Rating at Ambient – Less Than 1 CFM/sq ft

L Rating at 400 F – 5 CFM/sq ft

W Rating – Class 1

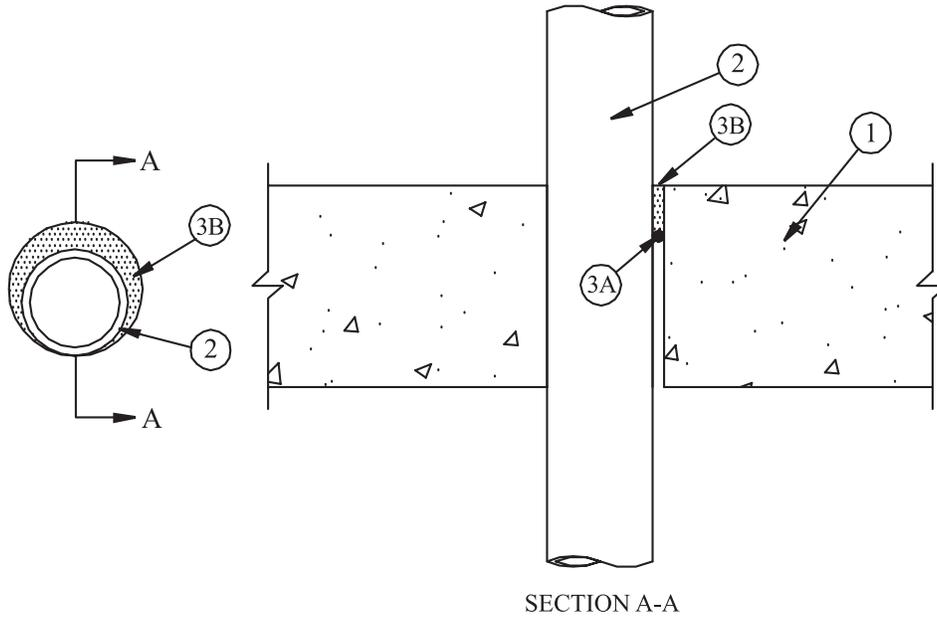

1. **Floor or Wall Assembly** – Min 4-1/2 in. (114 mm) thick reinforced lightweight or normal weight (100-150 pcf or 1600-2400 kg/m³) concrete. Wall may also be constructed of any UL Classified **Concrete Blocks***. The opening shall be 1 in. (25 mm) larger than the nom diam of penetrant.
See **Concrete Blocks (CAZT)** category in Fire Resistance Directory for names of manufacturers.
- 1A. **Steel Sleeve** – (optional, not shown) – Schedule 40 (or heavier) steel sleeve cast or grouted into floor or wall assembly, flush with both surfaces of floor or wall assembly. The nom size of sleeve shall be 1 in. (25 mm) larger than the nom size of through penetrant.
2. **Through Penetrants** – For nom 2 in. (51 mm) diam (or smaller) pipes, one nonmetallic pipe, conduit or tubing to be installed concentrically or eccentrically within the firestop system. The annular space between the penetrant and the periphery of the opening shall be a min of 0 in. (0 mm, point contact) to a max of 5/8 in. (16 mm). For nom 3 in. (76 mm) diam pipes, one nonmetallic pipe, conduit or tubing to be installed concentrically within the firestop system. The annular space between the penetrant and the periphery of the opening shall be 1/4 in. (6 mm). When steel sleeve is used, the annular space between the penetrant and the sleeve shall be a min of 1/4 in. (6 mm) to a max of 3/8 in. (10 mm). Pipe, conduit or tubing to be rigidly supported on both sides of floor or wall assembly. The following types and sizes of nonmetallic pipes, conduits or tubing may be used:
 - A. **Polyvinyl Chloride (PVC) Pipe** – Nom 3 in. (51 mm) diam (or smaller) Schedule 40 solid core PVC pipe for use in closed (process or supply) or vented (drain, waste or vent) piping systems.
 - B. **Chlorinated Polyvinyl Chloride (CPVC) Pipe** – Nom 3 in. (51 mm) diam (or smaller) SDR13.5 CPVC pipe for use in closed (process or supply) piping systems.
 - C. **Rigid Nonmetallic Conduit+** – Nom 3 in. (51 mm) diam (or smaller) Schedule 40 PVC conduit installed in accordance with Article 347 of the National Electrical Code (NFPA No. 70).
 - D. **Crosslinked Polyethylene (PEX) Tubing** – Nom 2 in. (51 mm) diam (or smaller) SDR 7.3 or SDR 9 PEX tubing for use in closed (process or supply) piping systems.
 - E. **Electrical Nonmetallic Tubing (ENT+)** – Nom 2 in. (51 mm) diam (or smaller) corrugated-wall electrical nonmetallic tubing (ENT) constructed of polyvinyl chloride (PVC) and installed in accordance with Article 331 of the National Electrical Code (NFPA No. 70).
See **Electrical Nonmetallic Tubing (FKHU)** category in the Electrical Construction Materials Directory for names of manufacturers.
 - F. **Flexible Nonmetallic Conduit, Liquid-Tight (FNMC)+** – Nom 2 in. (51 mm) diam (or smaller) corrugated-wall flexible nonmetallic conduit, liquid-tight (FNMC) constructed of polyvinyl chloride (PVC) and installed in accordance with Article 351 of the National Electrical Code (NFPA No. 70).
See **Flexible Nonmetallic Conduit, Liquid-Tight (DXOQ)** category in the Electrical Construction Materials Directory for names of manufacturers.
 - G. **Polyvinyl Chloride (PVC) Pipe** – Nom 2 in. (51 mm) diam (or smaller) Schedule 40 cellular core PVC pipe for use in closed (process or supply) or vented (drain, waste or vent) piping systems.
 - H. **Acrylonitrile Butadiene Styrene (ABS) Pipe** – Nom 2 in. (51 mm) diam (or smaller) Schedule 40 solid core or cellular core ABS pipe for use in closed (process or supply) or vented (drain, waste or vent) piping systems. **T Rating is 0 Hr when steel sleeve is used. When sleeve is not used and pipe diam is 2 in. (51 mm) or less, T Rating is 2 Hr for penetrants A, B, C, D, E and F. When sleeve is not used and pipe diam is 3 in. (76 mm), T Rating is 3/4 Hr for penetrants A, B and C. T Rating is 0 Hr for penetrants G and H.**

System No. C-AJ-2510 *continued*

3. **Firestop System** – The details of the firestop system shall be as follows:

- A. **Packing Material** – (Optional) – Nom 3/8 in. (10 mm) diam polyethylene backer rod or min 3/8 in. (10 mm) thickness of mineral wool batt insulation firmly packed into opening as a permanent form and recessed from both surfaces of floor or wall as required to accommodate the required thickness of fill material.
- B. **Fill, Void or Cavity Material* – Sealant** – For nom 2 in. (51 mm) diam (or smaller) pipes, a min 2 in. (51 mm) thickness of fill material applied within the annulus, flush with top surface of floor or with both surfaces of wall. For nom 3 in. (76 mm) diam pipes, a min 2-1/2 in. (64 mm) thickness of fill material applied within the annulus, flush with top surface of floor or with both surfaces of wall. An additional 1/4 in. (6 mm) bead of sealant applied at the penetrant/concrete interface at point contact location.

3M COMPANY – FB-3000 WT

*Bearing the UL Classification Mark

+Bearing the UL Listing Mark

Reprinted from the Online Certifications Directory with permission from Underwriters Laboratories Inc.
Copyright © 2011 Underwriters Laboratories Inc.®

Through Penetrations

Non-Metallic Pipes

2000 Series

Concrete

CAJ

System No. C-AJ-2536

June 23, 2015

F Rating — 2 Hr

T Ratings — 0, 1/2, 1-1/2 and 2 Hr (See Items 1, 2 and 3B)

L Rating At Ambient — 4 CFM/sq ft. (See Item 3B)

L Rating At 400 F — Less Than 1 CFM/sq ft. (See Item 3B)

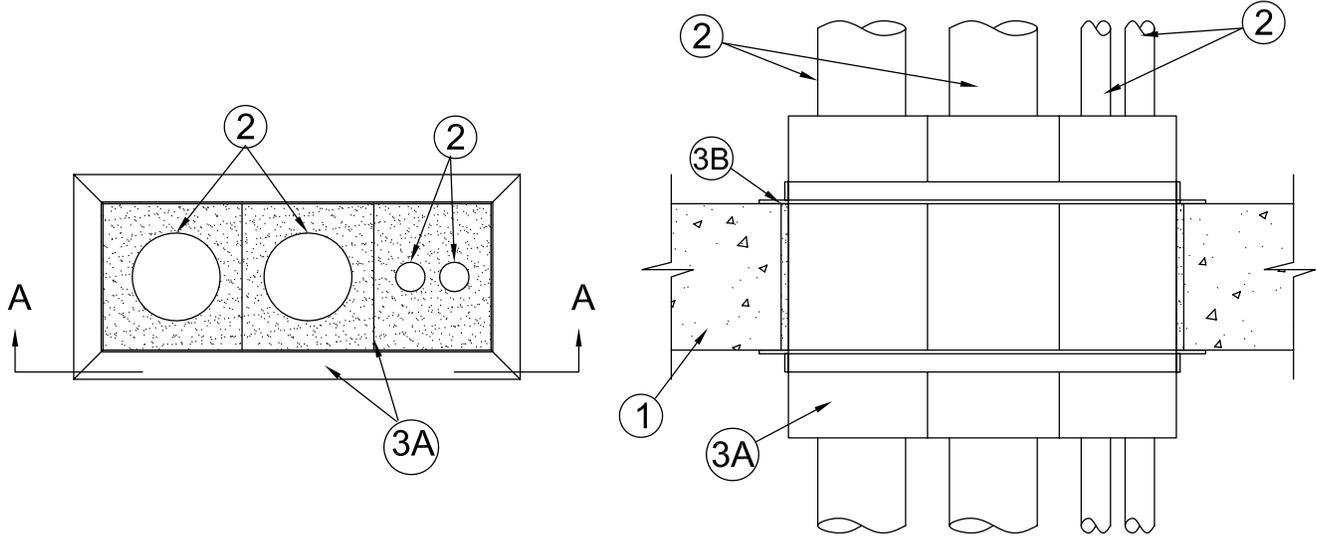

SECTION A-A

1. **Floor or Wall Assembly** — Min 2-1/2 in. (64 mm) thick reinforced lightweight or normal weight (100-150 pcf or 1600-2400 kg/m³) concrete. Wall may also be constructed of any UL Classified **Concrete Blocks***. Max area of opening is 56 in.² (363 cm²) with a max dimension of 12-1/2 in. (318 mm) for square devices. Max diam of opening is 2-1/2 in. (64 mm) for 2 in. (51 mm) round devices and 4-1/2 in. (114 mm) for 4 in. (102 mm) round devices. **When thickness of floor or wall assembly is less than 4-1/2 in. (114 mm), T Rating is 0 Hr.**
See **Concrete Blocks (CAZT)** category in Fire Resistance Directory for names of manufacturers.
2. **Through Penetrants** — One or more nonmetallic pipes, conduits or tubes as described in a single line item below, may be installed concentrically or eccentrically within each firestop device (Item 3A) without any limitation on annular space. If multiple through penetrants are installed within the firestop device, the through penetrants may be bundled together. When min thickness of floor or wall assembly is 4-1/2 in. (114 mm), T Rating shall be the lesser of the T Ratings for the penetrants installed. Through penetrants to be rigidly supported on both sides of floor or wall assembly. The following types and sizes of through penetrants may be used:
 - A. **Polyvinyl Chloride (PVC) Pipe** — One nom 2 in. (51 mm) diam (or smaller) Schedule 40 solid core PVC pipe for use in closed (process or supply) or vented (drain, waste or vent) piping systems. When PVC pipe is used, T Rating is 1-1/2 hr.
 - B. **Rigid Nonmetallic Conduit+** — One nom 2 in. (51 mm) diam (or smaller) Schedule 40 PVC conduit installed in accordance with the National Electrical Code (NFPA No. 70). When conduit is used, T Rating is 1-1/2 hr.
 See **Rigid Nonmetallic, Schedule 40 and 80 PVC Conduit (DZYR)** category in the Electrical Construction Equipment Directory for names of manufacturers.
 - C. **Chlorinated Polyvinyl Chloride (CPVC) Pipe** — One nom 2 in. (51 mm) diam (or smaller) SDR11 CPVC pipe for use in closed (process or supply) piping systems. When CPVC pipe is used, T Rating is 1-1/2 hr.
 - D. **Crosslinked Polyethylene (PEX) Tubing** — One nom 2 in. (51 mm) diam (or smaller) SDR 9 PEX tubing for use in closed (process or supply) piping systems. When PEX tubing is used, T Rating is 0 hr.
 - E. **Electrical Nonmetallic Tubing (ENT)+** — One nom 2 in. (51 mm) diam (or smaller) and max two 1 in. (25 mm) diam (or smaller) ENT installed in accordance with the National Electrical Code (NFPA No. 70). When ENT is used, T Rating is 2 hr.
 See **Electrical Nonmetallic Tubing (FKHU)** category in the Electrical Construction Equipment Directory for names of manufacturers.
 - F. **Optical Fiber/Communications/Signaling/Coaxial Cable Raceways+** — One nom 2 in. (51 mm) diam (or smaller) and max two 1 in. (25 mm) diam (or smaller) plenum rated raceways installed in accordance with the National Electrical Code (NFPA No. 70). When raceway is used, T Rating is 2 hr.
 - G. **Acrylonitrile Butadiene Styrene (ABS) Pipe** — One nom 2 in. (51 mm) diam (or smaller) and max two 1 in. (25 mm) diam (or smaller) plenum rated raceways installed in accordance with the National Electrical Code (NFPA No. 70). When raceway is used, T Rating is 2 hr.
3. **Firestop System** — The firestop system shall consist of the following:
 - A. **Firestop Device*** — A max of three square firestop devices may be ganged together. As an alternate, one round device may be centered within a round opening. Each device consists of a nom 2-1/2 by 2-1/2 by 10 in. (64 by 64 by 254 mm), 4 by 4 by 10 in. (102 by 102 by 254 mm), 2 in. (52 mm) diam by 10 in. (254 mm) or a 4 in. (102 mm) diam by 10 in. (254 mm) powder coated steel transit incorporating internal intumescent material, foam plugs and mounting flanges. In 2-1/2 by 2-1/2 in. (64 by 64 mm) devices, the max nom diam of the through penetrant shall not exceed 1-1/4 in. (32 mm). Firestop device(s) to be centered within opening and installed with ends projecting an equal distance beyond each surface of the floor or wall assembly in accordance with the accompanying installation instructions. The annular space between device(s) and periphery of opening shall be 0 in. (point contact) to max 1/4 in. (6 mm). Firestop device(s)

System No. C-AJ-2536 *continued*

secured in place by means of fill material (Item 3B) and steel split mounting flanges sized to accommodate the firestop device. Steel split mounting flanges installed on both sides of floor or wall after installation of fill material and secured together with supplied steel set screws. Nom 1 in. (25 mm) thick pre-cut foam plugs sized to accommodate the through penetrant and installed flush with each end of device on both sides of floor or wall assembly.

3M COMPANY — 3M Fire Barrier Pass-Through Device

- B. **Fill, Void or Cavity Materials* - Putty or Caulk** — Min 1 in. (25 mm) thickness of fill material applied within the annulus, flush with top surface of floor or both surfaces of wall prior to the installation of the mounting flanges. When the annular space is 1/8 in. (3.2 mm) or less, the fill material in the annulus is optional. Also, as an option, the foam plugs may be recessed into device and the recess filled with putty or caulk flush with the ends of the device. **When no fill material is used in the annulus in min 4-1/2 in. (114 mm) thick floors or walls, the T Rating is 1/2 Hr.** L Rating applies only when fill material is applied within annulus at interface of floor or both sides of wall and device(s) prior to mounting flanges and with both ends of firestop device(s) filled with nominal 1/8 in. (3.2 mm) of Moldable Putty+.

3M COMPANY — Moldable Putty+, CP25WB+, IC 15WB+, 3000 WT. CP 25WB+ not suitable for use with CPVC pipes.

* Indicates such products shall bear the UL or cUL Certification Mark for jurisdictions employing the UL or cUL Certification (such as Canada), respectively.

+ Bearing the UL Listing Mark

| |
|----------------------|
| Through Penetrations |
| Non-Metallic Pipes |
| 2000 Series |
| Concrete |
| CAJ |

System No. C-AJ-2626

March 27, 2009

F Ratings – 1 and 2 Hr (See Item 1)

T Ratings – 0, 1 and 2 Hr (See Item 2)

L Rating at Ambient – Less Than 1 CFM/sq ft

L Rating at 400 F – 5 CFM/sq ft

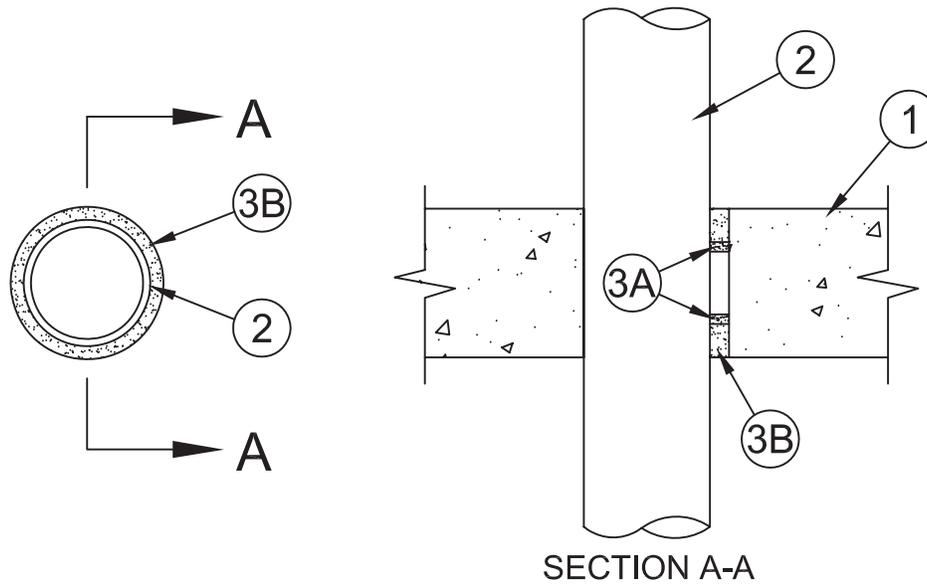

- Floor or Wall Assembly** – Min 3-3/4 in. (95 mm) or 4-1/2 in. (114 mm) thick reinforced lightweight or normal weight (100-150 pcf or 1600-2400 kg/m³) concrete for 1 and 2 Hr rated assemblies, respectively. Wall may also be constructed of any UL Classified **Concrete Blocks***. Floor assembly may also be constructed of any min 6 in. thick UL Classified hollow-core **Precast Concrete Units***. The opening shall be 1 in. (25 mm) larger than the nom diam of penetrant.

See **Concrete Blocks** (CAZT) and **Precast Concrete Units** (CFTV) categories in Fire Resistance Directory for names of manufacturers.

- Steel Sleeve** – (optional) – Schedule 40 (or heavier) steel sleeve cast or grouted into floor or wall assembly, flush with both surfaces of floor or wall assembly. The nom size of sleeve shall be 1 in. (25 mm) larger than the nom size of through-penetrant.
- Through-Penetrants** – One nonmetallic pipe, conduit or tubing to be centered within the firestop system installed concentrically or eccentrically within the firestop system. The annular space between the penetrant and the periphery of the opening shall be a min 0 in. (0 mm) (point contact) to a max 5/8 in. (16 mm). When steel sleeve is used, the annular space between the penetrant and the sleeve shall be a min 1/4 in. (6 mm) to a max 3/8 in. (10 mm). Pipe, conduit or tubing to be rigidly supported on both sides of floor or wall assembly. The following types and sizes of nonmetallic pipes, conduits or tubing may be used:
 - Polyvinyl Chloride (PVC) Pipe** – Nom 2 in. (51 mm) diam (or smaller) Schedule 40 solid core PVC pipe for use in closed (process or supply) or vented (drain, waste or vent) piping systems.
 - Chlorinated Polyvinyl Chloride (CPVC) Pipe** – Nom 2 in. (51 mm) diam (or smaller) SDR13.5 or SDR17 CPVC pipe for use in closed (process or supply) or vented (drain, waste or vent) piping systems.
 - Rigid Nonmetallic Conduit+** – Nom 2 in. (51 mm) diam (or smaller) Schedule 40 PVC conduit installed in accordance with Article 347 of the National Electrical Code (NFPA No. 70).
 - Crosslinked Polyethylene (PEX) Tubing** – Nom 2 in. (51 mm) diam (or smaller) SDR 7.3 tubing for use in closed (process or supply) piping systems or nom 2 in. (51 mm) diam (or smaller) SDR 9 PEX tubing for use in closed (process or supply) or vented (drain, waste or vent) piping systems.
 - Electrical Nonmetallic Tubing (ENT+)** – Nom 2 in. (51 mm) diam (or smaller) corrugated-wall electrical nonmetallic tubing (ENT) constructed of polyvinyl chloride (PVC) and installed in accordance with Article 331 of the National Electrical Code (NFPA No. 70). See **Electrical Nonmetallic Tubing** (FKHU) category in the Electrical Construction Materials Directory for names of manufacturers.
 - Flexible Nonmetallic Conduit, Liquid-Tight (FNMC)+** – Nom 2 in. (51 mm) diam (or smaller) corrugated-wall flexible nonmetallic conduit, liquid-tight (FNMC) constructed of polyvinyl chloride (PVC) and installed in accordance with Article 351 of the National Electrical Code (NFPA No. 70). See **Flexible Nonmetallic Conduit, Liquid-Tight** (DXOQ) category in the Electrical Construction Materials Directory for names of manufacturers.
 - Polyvinyl Chloride (PVC) Pipe** – Nom 2 in. (51 mm) diam (or smaller) Schedule 40 cellular core PVC pipe for use in closed (process or supply) or vented (drain, waste or vent) piping systems.
 - Acrylonitrile Butadiene Styrene (ABS) Pipe** – Nom 2 in. (51 mm) diam (or smaller) Schedule 40 solid core or cellular core ABS pipe for use in closed (process or supply) or vented (drain, waste or vent) piping systems.

T Rating is 0 Hr when steel sleeve is used. When sleeve is not used, T Rating is 1 and 2 Hr for penetrants A, B, C, D, E and F for 1 and 2 Hr rated assemblies, respectively. T Rating is 0 Hr for penetrants G and H.

System No. C-AJ-2626 *continued*

3. **Firestop System** – The details of the firestop system shall be as follows:

- A. **Packing Material** – (Optional) Nom 3/8 in. (10 mm) diam polyethylene backer rod or min 3/8 in. thickness of mineral wool batt insulation firmly packed into opening as a permanent form and recessed from both surfaces of floor or wall as required to accommodate the required thickness of fill material.
- B. **Fill, Void or Cavity Material* – Sealant** – Min 5/8 in. (16 mm) or 1 in. (25 mm) thickness of fill material applied within the annulus, flush with both surfaces of floor or wall for 1 and 2 Hr rated assemblies, respectively. An additional 1/4 in. (6 mm) bead of sealant applied at the penetrant/concrete interface at point contact location.

3M COMPANY

3M FIRE PROTECTION PRODUCTS – FB-3000 WT sealant

*Bearing the UL Classification Mark

+Bearing the UL Listing Mark

Reprinted from the Online Certifications Directory with permission from Underwriters Laboratories Inc.
Copyright © 2011 Underwriters Laboratories Inc.®

Through Penetrations

Non-Metallic Pipes

2000 Series

Concrete

CAJ

System No. C-AJ-2627

March 27, 2009

F Rating – 2 Hr

T Ratings – 0 and 2 Hr (See Item 2)

L Rating at Ambient – Less Than 1 CFM/sq ft

L Rating at 400 F – 5 CFM/sq ft

W Rating – Class 1

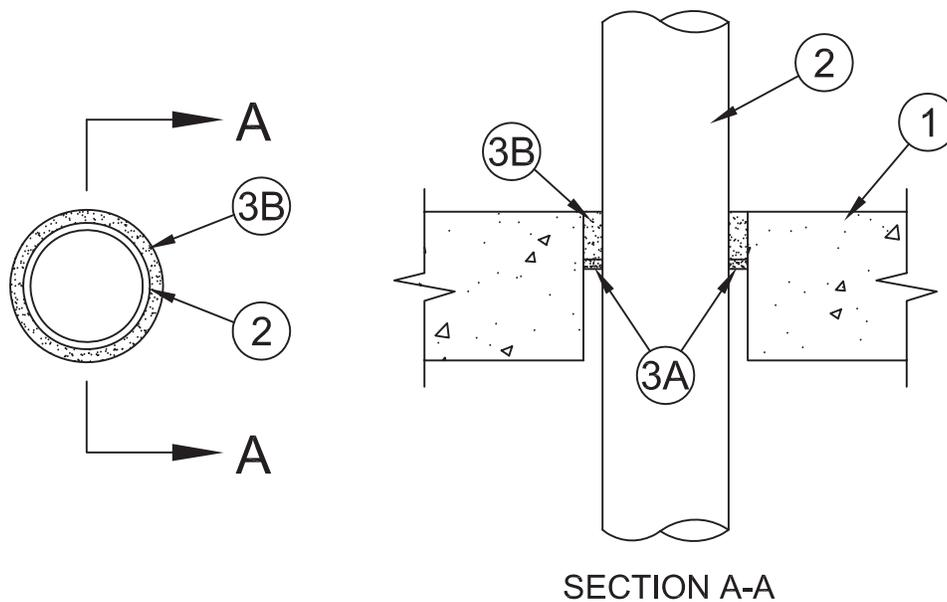

1. **Floor or Wall Assembly** – Min 4-1/2 in. (95 mm) or 4-1/2 in. (114 mm) thick reinforced lightweight or normal weight (100-150 pcf or 1600-2400 kg/m³) concrete. Wall may also be constructed of any UL Classified **Concrete Blocks***. The opening shall be 1 in. (25 mm) larger than the nom diam of penetrant.
See **Concrete Blocks (CAZT)** category in Fire Resistance Directory for names of manufacturers.
- 1A. **Steel Sleeve** – (optional) – Schedule 40 (or heavier) steel sleeve cast or grouted into floor or wall assembly, flush with both surfaces of floor or wall assembly. The nom size of sleeve shall be 1 in. (25 mm) larger than the nom size of through-penetrant.
2. **Through-Penetrants** – One nonmetallic pipe, conduit or tubing to be installed concentrically or eccentrically within the firestop system. The annular space between the penetrant and the periphery of the opening shall be a min 0 in. (0 mm) (point contact) to a max 5/8 in. (16 mm). When steel sleeve is used, the annular space between the penetrant and the sleeve shall be a min of 1/4 in. (6 mm) to a max of 3/8 in. (10 mm). Pipe, conduit or tubing to be rigidly supported on both sides of floor or wall assembly. The following types and sizes of nonmetallic pipes, conduits or tubing may be used:
- Polyvinyl Chloride (PVC) Pipe** – Nom 2 in. (51 mm) diam (or smaller) Schedule 40 solid core PVC pipe for use in closed (process or supply) or vented (drain, waste or vent) piping systems.
 - Chlorinated Polyvinyl Chloride (CPVC) Pipe** – Nom 2 in. (51 mm) diam (or smaller) SDR13.5 or SDR17 CPVC pipe for use in closed (process or supply) or vented (drain, waste or vent) piping systems.
 - Rigid Nonmetallic Conduit+** – Nom 2 in. (51 mm) diam (or smaller) Schedule 40 PVC conduit installed in accordance with Article 347 of the National Electrical Code (NFPA No. 70).
 - Crosslinked Polyethylene (PEX) Tubing** – Nom 2 in. (51 mm) diam (or smaller) SDR 7.3 or SDR 9 PEX tubing for use in closed (process or supply) piping systems.
 - Electrical Nonmetallic Tubing (ENT+)** – Nom 2 in. (51 mm) diam (or smaller) corrugated-wall electrical nonmetallic tubing (ENT) constructed of polyvinyl chloride (PVC) and installed in accordance with Article 331 of the National Electrical Code (NFPA No. 70). See **Electrical Nonmetallic Tubing (FKHU)** category in the Electrical Construction Materials Directory for names of manufacturers.
 - Flexible Nonmetallic Conduit, Liquid-Tight (FNMC)+** – Nom 2 in. (51 mm) diam (or smaller) corrugated-wall flexible nonmetallic conduit, liquid-tight (FNMC) constructed of polyvinyl chloride (PVC) and installed in accordance with Article 351 of the National Electrical Code (NFPA No. 70).
See **Flexible Nonmetallic Conduit, Liquid-Tight (DXOQ)** category in the Electrical Construction Materials Directory for names of manufacturers.
 - Polyvinyl Chloride (PVC) Pipe** – Nom 2 in. (51 mm) diam (or smaller) Schedule 40 cellular core PVC pipe for use in closed (process or supply) or vented (drain, waste or vent) piping systems.
 - Acrylonitrile Butadiene Styrene (ABS) Pipe** – Nom 2 in. (51 mm) diam (or smaller) Schedule 40 solid core or cellular core ABS pipe for use in closed (process or supply) or vented (drain, waste or vent) piping systems.
- T Rating is 0 Hr when steel sleeve is used. When sleeve is not used, T Rating is 2 Hr for penetrants A, B, C, D, E and F. T Rating is 0 Hr for penetrants G and H.**

System No. C-AJ-2627 *continued*

3. **Firestop System** – The details of the firestop system shall be as follows:

- A. **Packing Material** – (Optional) Nom 3/8 in. (10 mm) diam polyethylene backer rod or min 3/8 in. (10 mm) thickness of mineral wool batt insulation firmly packed into opening as a permanent form and recessed from both surfaces of floor or wall as required to accommodate the required thickness of fill material.
- B. **Fill, Void or Cavity Material* – Sealant** – Min 2 in. (51 mm) thickness of fill material applied within the annulus, flush with top surface of floor or with both surfaces of wall. An additional 1/4 in. (6 mm) bead of sealant applied at the penetrant/concrete interface at point contact location.

3M COMPANY

3M FIRE PROTECTION PRODUCTS – FB-3000 WT sealant

*Bearing the UL Classification Mark

+Bearing the UL Listing Mark

Reprinted from the Online Certifications Directory with permission from Underwriters Laboratories Inc.
Copyright © 2011 Underwriters Laboratories Inc.®

Through Penetrations

Non-Metallic Pipes

2000 Series

Concrete

CAJ



UL System No. C-AJ-2637
XHEZ - Through-penetration Firestop Systems

September 12, 2018

F Rating — 2 & 3 Hr (See Item 2)

T Rating — 1-1/2 Hr

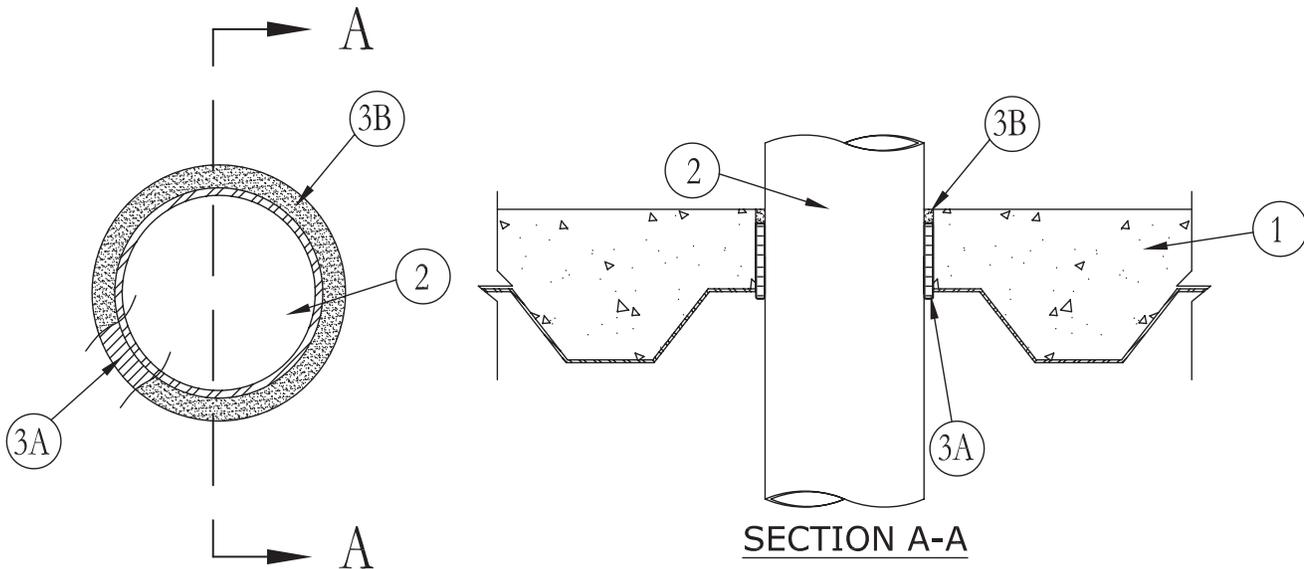

1. **Wall Assembly** – Min 4-1/2 in. (114 mm) thick reinforced lightweight or normal weight (100-150 pcf) concrete. Wall may also be constructed of any UL Classified **Concrete Blocks***. Wall may also be constructed of any UL Classified **Concrete Blocks***. Floor assembly may also be constructed of any min 6 in. (152 mm) thick UL Classified hollow-core **Precast Concrete Units***. Max diam of opening is 5 in. (127 mm).

See **Concrete Blocks (CAZT)** and **Precast Concrete Units (CFTV)** category in the Fire Resistance Directory for names of manufacturers.

- 1A. **Floor Assembly (As an alternate to Item 1)** – The fire-rated unprotected concrete and steel floor assembly shall be constructed of the materials and in the manner specified in the individual D900 Series designs in the UL Fire Resistance Directory and as summarized below:

- A. **Concrete** – Min 2 1/2 in. (64 mm) thick reinforced lightweight or normal weight (100-150 pcf or 1600-2400 kg/m³) concrete topping, as measured from the top of the steel floor units.
- B. **Steel Floor and Form Units*** – Composite or noncomposite 1-1/2, 2 or 3 in. (38, 51 or 76 mm) deep fluted galv units as specified in the individual Floor-Ceiling design. Diam of opening through floor to be 1/2 to 5/8 in. (13 to 16 mm) larger than the outside diam of through-penetrant (Item 2). Max diam of opening is 5 in. (127 mm).

2. **Through Penetrants** – One nonmetallic pipe or conduit to be installed concentrically within the firestop system. The annular space between the pipe or conduit and the periphery of the opening shall be 1/4 in. (6 mm). Circular opening size must be 1 in. (25 mm) larger than the nominal pipe size. Pipe or conduit to be rigidly supported on both sides of the floor or wall assembly. The following types and sizes of nonmetallic pipes or conduits may be used:

- A. **Polyvinyl Chloride (PVC) Pipe** – Nom 4 in. (102 mm) diam (or smaller) SDR13.5 CPVC pipe for use in closed (process or supply) or vented (drain, waste or vent) piping systems. (See Item 3C below.)
- B. **Chlorinated Polyvinyl Chloride (CPVC) Pipe** – Nom 4 in. (102 mm) diam (or smaller) SDR13.5 CPVC pipe for use in closed (process or supply) piping systems. (See Item 3C below.)
- C. **Fire Retardant Polypropylene (FRPP) Pipe** – Nom 4 in. (102 mm) diam (or smaller) Schedule 40 FRPP pipe for use in closed (process or supply) or vented (drain, waste or vent) piping systems.
- D. **Rigid Nonmetallic Conduit+** – Nom 4 in.(102 mm) diam (or smaller) Schedule 40 PVC conduit installed in accordance with Article 347 of the National Electrical Code (NFPA No. 70).

Cellular core PVC pipe (Item 2A) limited to a maximum 2 Hr F Rating.

Through Penetrations

Non-Metallic Pipes

2000 Series

Concrete

CAJ

3. Firestop System – The firestop system shall consist of the following:

A. Fill, Void or Cavity Materials* – Wrap Strip – Min 3/16 in. (5 mm) thick intumescent material supplied in 2-1/2 in. (64 mm) wide strips. Single layer of pre-cut wrap strip tightly wrapped around nonmetallic pipe and secured with the adhesive closure tab. When installed in floors, wrap strip is to be recessed within the opening such that the bottom of the wrap strip layer is min 1/4 in. (6 mm) below the bottom surface of floor. For wall assemblies, wrap strip is to be installed on both sides of wall and installed in the wall such that the wrap strip is extending 5/8 in. (16 mm) from both surfaces of wall.

3M COMPANY 3M FIRE PROTECTION PRODUCTS – Tuck-In Wrap Strip WS 200, WS 300 or WS 400

B. Fill, Void or Cavity Materials* – Caulk or Sealant – Min 1/4 in. (6 mm) thickness of sealant applied within annular space, flush with top surface of floor. When hollow-core Precast concrete units are used, min 1/2 in. (13 mm) thickness of sealant applied within annular space, flush with top and bottom surfaces of floor. Wall assemblies are to have a min 1/4 in. (6 mm) diam bead of sealant applied to concrete or concrete block/wrap strip interface on both sides of wall.

3M COMPANY 3M FIRE PROTECTION PRODUCTS – IC 15WB+ Caulk, CP 25WB+ Caulk, or 3000 WT Sealant (CP 25WB+ not suitable for use with CPVC pipes)

C. Foil Tape – (Not Shown) — Required only when CPVC penetrant (Item 2B) is used. Nom 4 in. (102 mm) wide, 3 mil thick aluminum tape installed around pipe prior to installation of wrap strip. Foil tape is to be positioned such that it will be centered under the wrap strip material with adhesive side out.

Through Penetrations

Non-Metallic Pipes

2000 Series

Concrete

CAJ



*Indicates such products shall bear the UL or cUL Certification Mark for jurisdictions employing the UL or cUL Certification (such as Canada), respectively.

System No. C-AJ-2640

June 04, 2010
F Rating – 2 Hr
T Ratings – 1-1/4 Hr

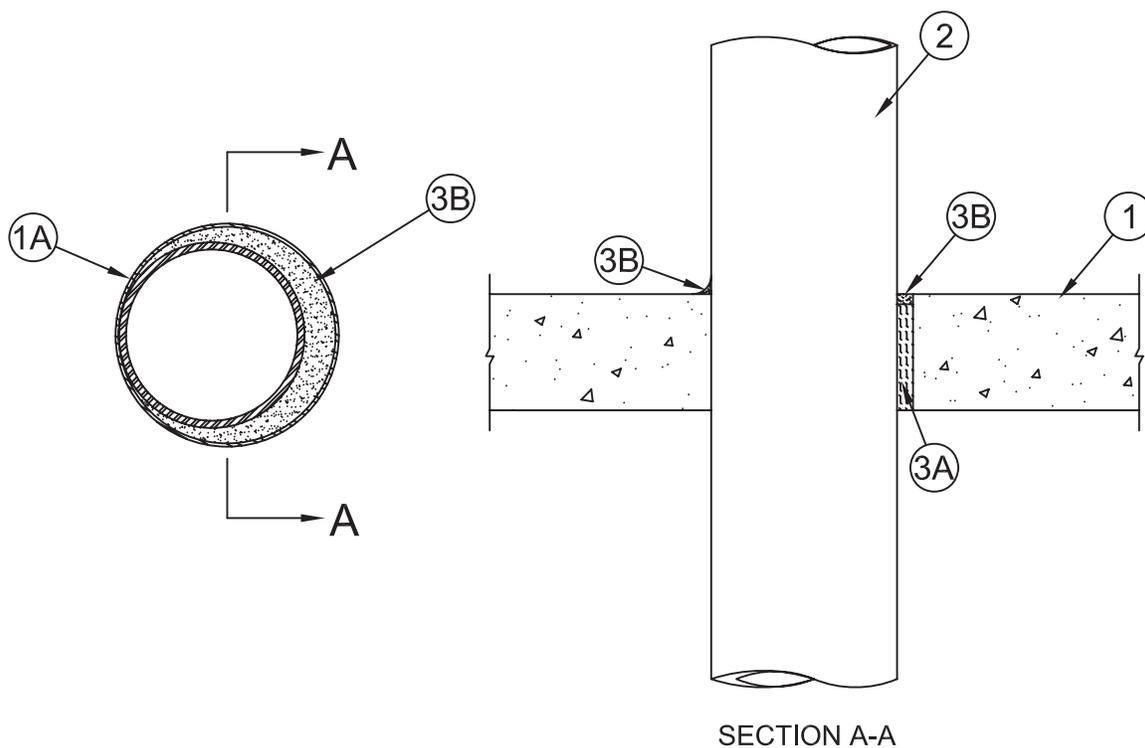

1. **Floor or Wall Assembly** – Min 2-1/2 in. (64 mm) thick reinforced lightweight or normal weight (100-150 pcf or 1600-2400kg/m³) concrete floor or min 3 in. (76 mm) thick reinforced lightweight or normal weight (100-150 pcf or 1600-2400kg/m³) concrete wall. Wall may also be constructed of any UL Classified Concrete Blocks*. Diam of opening shall be 2 in. (51 mm) larger than the nom diam of penetrant (Item 2). See **Concrete Block** (CAZT) category in the Fire Resistance Directory for names of manufacturers.
- 1A. **Steel Deck/Floor Assembly** – (Not Shown) – As an alternate to Item 1, the floor assembly may consist of a fluted steel deck/concrete floor assembly. The floor assembly shall be constructed of the materials and in the manner described in the individual Floor-Ceiling Design in the UL Fire Resistance Directory and shall include the following construction features:
 - A. **Steel Floor and Form Units*** – 1-1/2 to 3 in. (38 to 76 mm) deep galv fluted units.
 - B. **Concrete** – Min 2-1/2 in. (64 mm) thick reinforced concrete, as measured from the top plane of the floor units.
2. **Through Penetrants – Polyvinyl Chloride (PVC) Pipe** – One nom 2 in. (51 mm) diam (or smaller) Schedule 80 solid core PVC pipe for use in closed (process or supply) piping systems. Pipe to be installed either concentrically or eccentrically within the firestop system. The annular space between the pipe and the periphery of the opening shall be a min of 0 in. (point contact) to a max 1-5/8 in. (41 mm). The pipe to be rigidly supported on both sides of floor or wall.
3. **Firestop System** – The firestop system shall consist of the following:
 - A. **Packing Material** – Min 2 in. (51 mm) thickness of min 4 pcf (64 kg/m³) mineral wool batt insulation firmly packed into opening as a permanent form. Packing material to be recessed from top surface of floor or from both surfaces of wall to accommodate the required thickness of fill material.
 - B. **Fill, Void or Cavity Material* – Caulk or Sealant** – Min 1/2 in. (13 mm) thickness of fill material applied within the annulus, flush with top surface of floor or with both surfaces of wall. A min 1/2 in. (13 mm) thick bead of the fill material shall be applied at the point of contact of the pipe and the edge of the opening at the top floor surface or both wall surfaces.

3M COMPANY

3M FIRE PROTECTION PRODUCTS — IC 15WB+ caulk, CP 25WB+ caulk or FB-3000 WT sealant

*Bearing the UL Classification Mark

Reprinted from the Online Certifications Directory with permission from Underwriters Laboratories Inc.
Copyright © 2010 Underwriters Laboratories Inc.®

Through Penetrations

Non-Metallic Pipes

2000 Series

Concrete

CAJ

System No. C-AJ-2643

February 03, 2016

F Ratings — 2 and 3 Hr (See Item 2)

T Rating — 1 Hr

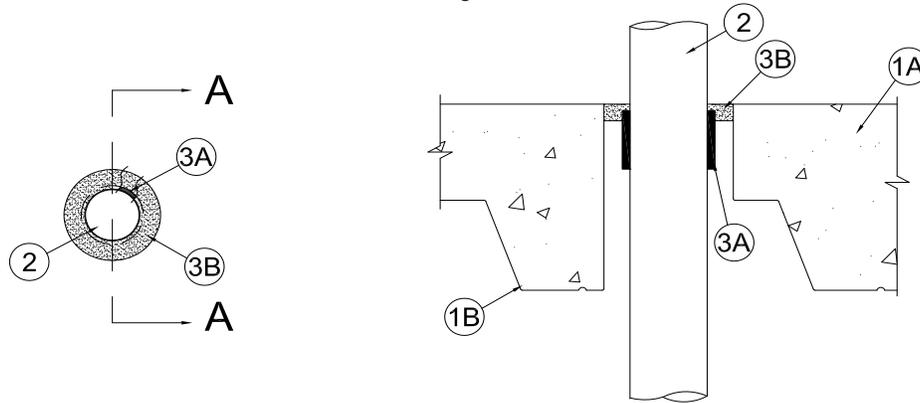
**SECTION A-A**

1. **Floor Assembly** — The fire rated concrete and steel deck floor assembly shall be constructed of the materials and in the manner specified in the individual D900 Series Floor-Ceiling designs in the UL Fire Resistance Directory and as summarized below:
 - A. **Concrete** — Min 2 1/2 in. (64 mm) thick reinforced lightweight or normal weight (100-150 pcf or 1600-2400 kg/m³) concrete topping, as measured from the top of the steel floor units.
 - B. **Steel Floor and Form Units*** — Composite or noncomposite 1-1/2, 2 or 3 in. (38, 51 or 76 mm) deep fluted galv units as specified in the individual Floor-Ceiling design. Diam of opening through floor to be 1/2 to 1-1/2 in. (13 to 38 mm) larger than the outside diam of through-penetrant (Item 2). Max diam of opening is 6 in. (152 mm).
- 1A. **Floor or Wall Assembly** — As an alternate to Item 1, min 4-1/2 in. (114 mm) thick reinforced lightweight or normal weight (100-150 pcf) concrete. Wall may also be constructed of any UL Classified **Concrete Blocks***. Floor assembly may also be constructed of any min 6 in. (152 mm) thick UL Classified hollow-core **Precast Concrete Units***. Diam of opening through floor or wall to be 1/2 to 1-1/2 in. (13 to 38 mm) larger than the outside diam of through-penetrant (Item 2). Max diam of opening is 6 in. (152 mm).
See **Concrete Blocks (CAZT)** and **Precast Concrete Units (CFTV)** category in the Fire Resistance Directory for names of manufacturers.
2. **Through Penetrant** — One nonmetallic pipe or conduit to be installed concentrically within the firestop system. The annular space between the pipe or conduit and the periphery of the opening shall be min 1/4 in. (6 mm) to max 3/4 in. (19 mm). Pipe or conduit to be rigidly supported on both sides of the floor or wall assembly. The following types and sizes of nonmetallic pipes or conduits may be used:
 - A. **Polyvinyl Chloride (PVC) Pipe** — Nom 4 in. (102 mm) diam (or smaller) Schedule 40 solid core or cellular core PVC pipe for use in closed (process or supply) or vented (drain, waste or vent) piping systems.
 - B. **Chlorinated Polyvinyl Chloride (CPVC) Pipe** — Nom 4 in. (102 mm) diam (or smaller) SDR13.5 CPVC pipe for use in closed (process or supply) piping systems. (See Item 3C below.)
 - C. **Fire Retardant Polypropylene (FRPP) Pipe** — Nom 4 in. (102 mm) diam (or smaller) Schedule 40 FRPP pipe for use in closed (process or supply) or vented (drain, waste or vent) piping systems.
 - D. **Rigid Nonmetallic Conduit+** — Nom 4 in. (102 mm) diam (or smaller) Schedule 40 PVC conduit installed in accordance with the National Electrical Code (NFPA No. 70).

Solid core PVC pipe (Item 2A) and CPVC pipe (Item 2B) limited to a maximum 2 Hr F Rating.

3. **Firestop System** — The firestop system shall consist of the following:
 - A. **Fill, Void or Cavity Materials* — Wrap Strip** — Nom 3/16 in. (5 mm) thick intumescent material supplied in 2-1/2 in. (64 mm) wide strips. Single layer of pre-cut wrap strip tightly wrapped around nonmetallic pipe, secured with the adhesive closure tab, and slid into annular space. When installed in floors, wrap strip is to be recessed within the opening such that the bottom of the wrap strip layer protrudes 1/4 in. (6 mm) below the bottom surface of the floor. For steel deck/concrete floor assemblies, wrap strip is to be recessed within the opening such that the bottom of the wrap strip layer protrudes 1/4 in. (6 mm) below the crest of the fluted steel deck. For wall assemblies, wrap strip is to be installed on both sides of wall and is to protrude 1/4 in. (6 mm) from each surface of wall.
3M COMPANY 3M FIRE PROTECTION PRODUCTS — Tuck-In Wrap Strip WS 200, WS 300 or WS 400
 - B. **Fill, Void or Cavity Materials* — Sealant** — Min 1/2 in. (13 mm) thickness of sealant applied within annular space between wrap strip and edge of opening with a min 1/4 in. (6mm) depth of sealant above top edge of wrap strip in floor assemblies. When hollow-core precast concrete units are used, min 1/2 (13 mm) thickness of sealant applied within annular space, flush with top and bottom surfaces of floor. Wall assemblies are to have a min 1/2 in. (13 mm) depth of sealant applied to fill annular space on each side of wall.
3M COMPANY 3M FIRE PROTECTION PRODUCTS — IC-15WB+, CP 25WB+, or 3000 WT Sealant (CP 25WB+ not suitable for use with CPVC pipes)
 - C. **Foil Tape — (Not Shown)** — Required only when CPVC penetrant (Item 2B) is used. Nom 4 in. (102 mm) wide, 3 mil thick aluminum tape installed around pipe prior to installation of wrap strip. Foil tape is to be positioned such that it will be centered under the wrap strip material with adhesive side out.

* Indicates such products shall bear the UL or cUL Certification Mark for jurisdictions employing the UL or cUL Certification (such as Canada), respectively.

++Bearing the UL Listing Mark



UL System No. C-AJ-2648
XHEZ - Through-penetration Firestop Systems

July 12, 2016

F Rating — 2 Hr

T Rating — 0 Hr

W Rating — Class I (See Item 3)

L Rating at Ambient — Less than 1 CFM/sq ft (See Item 3C)

L Rating at 400 F — Less than 1 CFM/sq ft (See Item 3C)

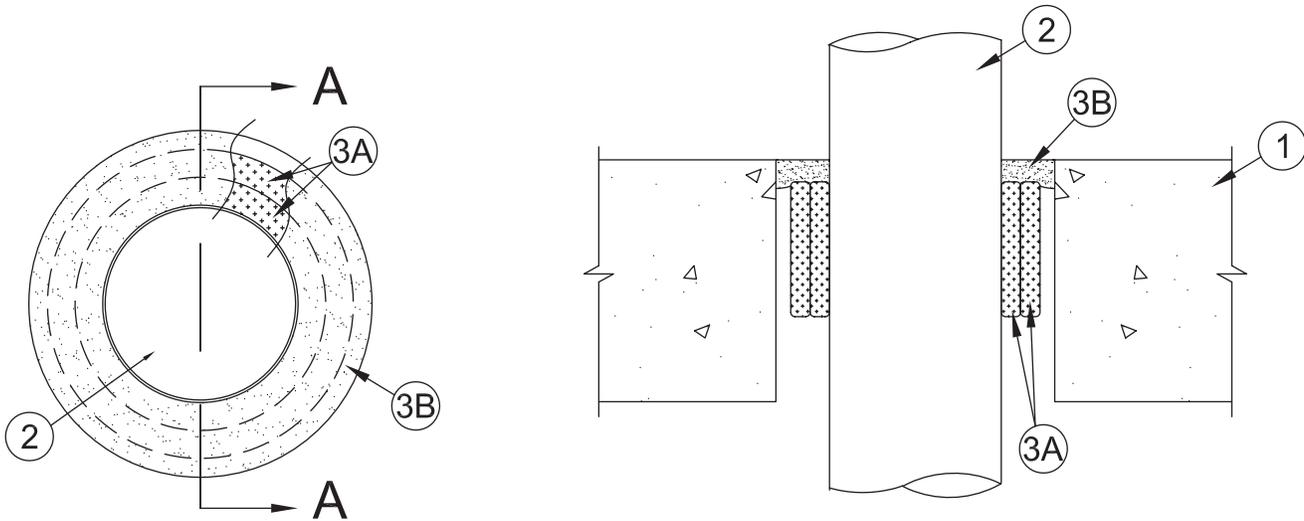

- 1. Floor or Wall Assembly** – Min 4-1/2 in. (114 mm) thick reinforced lightweight or normal weight (100-150 pcf) concrete. Wall may also be constructed of any UL Classified **Concrete Blocks***. Floor assembly may also be constructed of any min 6 in. (152 mm) thick UL Classified hollow-core **Precast Concrete Units***. Max diam of opening is 8 in. (203 mm). Max diam of opening in floors constructed with hollow-core concrete is 7 in. (178mm).

See **Concrete Blocks** (CAZT) and **Precast Concrete Units** (CFTV) category in the Fire Resistance Directory for names of manufacturers.

- 2. Through Penetrant** – One nonmetallic pipe or conduit to be installed concentrically within the firestop system. The annular space between the pipe or conduit and the periphery of the opening shall be 11/16 in. (17.5 mm). Pipe or conduit to be rigidly supported on both sides of the floor or wall assembly. The following types and sizes of nonmetallic pipes or conduits may be used:
 - A. Polyvinyl Chloride (PVC) Pipe** – Nom 6 in. (152 mm) diam (or smaller) Schedule 40 solid core PVC pipe for use in closed (process or supply) or vented (drain, waste or vent) piping systems.
 - B. Chlorinated Polyvinyl Chloride (CPVC) Pipe** – Nom 6 in. (152 mm) diam (or smaller) SDR13.5 CPVC pipe for use in closed (process or supply) piping systems. (See Item 3C.)
 - C. Fire Retardant Polypropylene (FRPP) Pipe** – Nom 4 in. (102 mm) diam (or smaller) Schedule 40 FRPP pipe for use in closed (process or supply) or vented (drain, waste or vent) piping systems.
 - D. Rigid Nonmetallic Conduit+** – Nom 6 in. (152 mm) diam (or smaller) Schedule 40 PVC conduit installed in accordance with the National Electrical Code (NFPA No. 70).
- 3. Firestop System** – The firestop system shall consist of the following:
 - A. Fill, Void or Cavity Materials* – Wrap Strip** – Two layers of min 3/16 in. (5 mm) thick intumescent material supplied in 2-1/2 in. (64 mm) wide strips. Two layers of wrap strip tightly wrapped around nonmetallic pipe and secured with either aluminum foil tape or filament tape. When installed in floors, wrap strip is to be installed within the opening such that the top of the wrap strip is min 1/4 in. (6 mm) below the top surface of floor. For Hollow Core floor assemblies, wrap strip is to be recessed such that the bottom edge of the wrap strip extends 1/4 in. (6 mm) from the bottom surface of the floor. For wall assemblies, wrap strip is to be installed on both sides of wall and installed in the wall such that the wrap strip is recessed a min. of 1/4 in. (6 mm) from both surfaces of wall.

3M COMPANY 3M FIRE PROTECTION PRODUCTS – Tuck-In Wrap Strip WS Roll

B. Fill, Void or Cavity Materials* – Caulk or Sealant – Min 1/4 in. (6 mm) thickness of sealant applied within annular space, flush with top surface of floor. When hollow-core precast concrete units are used min 1/2 (13 mm) thickness of sealant applied within annular space, flush with top and bottom surfaces of floor. Wall assemblies are to have a min 1/4 in. (6 mm) diam depth of sealant applied to concrete or concrete block/wrap strip interface on both sides of wall.

3M COMPANY 3M FIRE PROTECTION PRODUCTS – IC 15WB+ Caulk, CP 25WB+ Caulk, or 3000 WT Sealant (CP 25WB+ not suitable for use with CPVC pipes)

C. Foil Tape – (Not Shown) — Required only when CPVC penetrant (Item 2B) is used. Nom 4 in. (102 mm) wide, 3 mil thick aluminum tape installed around pipe prior to installation of wrap strip. Foil tape is to be positioned such that it will be centered under the wrap strip material with adhesive side out. **L Rating does not apply when Foil Tape and CPVC penetrant is used.**

(**Note:** W Rating only applies when FB 3000 WT Sealant is used in floor assembly. W Rating does not apply when CPVC penetrant is used.)

Through Penetrations

Non-Metallic Pipes

2000 Series

Concrete

CAJ



*Indicates such products shall bear the UL or cUL Certification Mark for jurisdictions employing the UL or cUL Certification (such as Canada), respectively.

System No. C-AJ-2668

February 03, 2016

| ANSI/UL1479 (ASTM E814) | CAN/ULC S115 |
|-------------------------|---------------------|
| F Rating — 2 Hr | F Rating — 2 Hr |
| T Rating — 1/4 Hr | FT Rating — 1/4 Hr |
| | FH Rating — 2 Hr |
| | FTH Rating — 1/4 Hr |

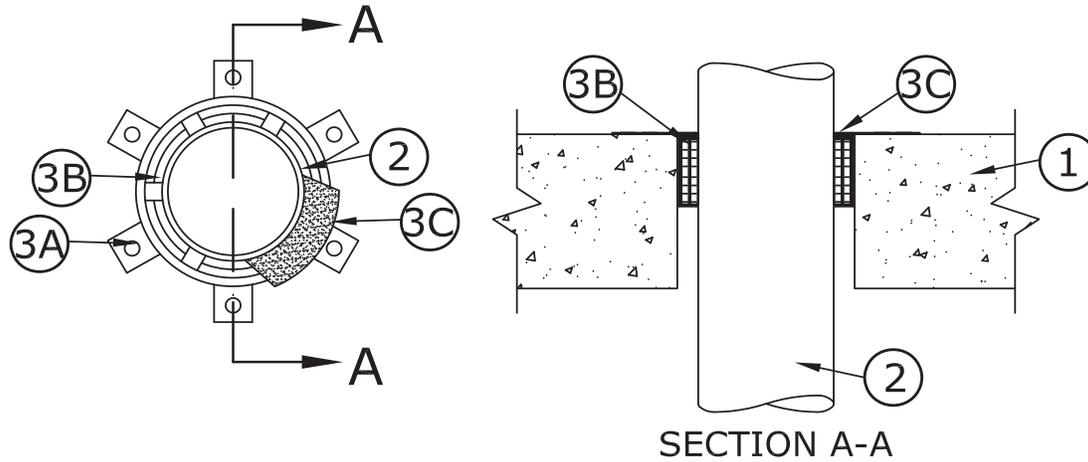

System tested with a pressure differential of 2.5 Pa between the exposed and the unexposed surfaces with the higher pressure on the exposed side.

1. **Floor or Wall Assembly** – Min 4-1/2 in. (114 mm) thick reinforced lightweight or normal weight (100-150 pcf or 1600-2400 kg/m³) concrete. Max diam of opening 10 in. (254 mm).
2. **Through-Penetrant** – One nonmetallic pipe installed concentrically or eccentrically within opening. Annular space between penetrant and periphery of opening shall be min 5/8 in. (mm) to max 1 in. (25 mm). Penetrant to be rigidly supported on both sides of floor or wall assembly. The following types and sizes of penetrants may be used:
 - A. **Polyvinyl Chloride (PVC) Pipe** – Nom 8 in. (203 mm) diam (or smaller) Schedule 40 solid core PVC pipe for use in closed (process or supply) or vented (drain, waste or vent) piping systems.
 - B. **Chlorinated Polyvinyl Chloride (CPVC) Pipe** – Nom 8 in. (203 mm) diam (or smaller) SDR13.5 CPVC pipe for use in closed (process or supply) piping systems. (See Item 3C.)
 - C. **Rigid Nonmetallic Conduit+** – Nom 6 in. (152 mm) diam (or smaller) Schedule 40 PVC conduit installed in accordance with the National Electrical Code (NFPA No. 70).
3. **Firestop System** – The firestop system shall consist of the following:
 - A. **Steel Collar** – Nom 2 in. (51 mm) deep collar with 1-1/4 in. (32 mm) wide by 2 in. (51 mm) long anchor tabs and min 1/2 in. (13 mm) long tabs to retain wrap strip. Collar inverted nom 2-1/4 in. (57 mm) into annular space between penetrant and opening to retain wrap strip layers. In floors, one collar is installed from top side of floor. In walls, two collars are installed, one from each side of wall. Every other steel collar anchor tab extending up above floor or beyond surface of wall is bent 90 degree to rest flush against floor or wall surface with min 1/2 in. overlap (13 mm); and remaining anchor tabs are trimmed and bent nom 90 degrees toward penetrant. Coils of precut 0.016 in. (0.41 mm) thick (28 gauge) galv sheet steel available from wrap strip manufacturer. As an alternate, collar may be field-fabricated from min 0.016 in. (0.41 mm) thick (28 gauge) galv sheet steel.
 - B. **Fill, Void or Cavity Materials* – Wrap Strip** – Min 3/16 in. (5 mm) thick intumescent material supplied in 2-1/2 in. (64 mm) wide strips. Wrap strip is trimmed to a width of 2 in. (51 mm) and tightly wrapped around pipe in continuous layers and secured with either aluminum foil tape or filament tape. Two layers of 3/16 in. (5 mm) thick by 2 in. (51 mm) wide wrap strip are required. When installed in floors, wrap strip is to be installed within the opening such that the top of the wrap strip is recessed 1/4 in. (6 mm) below the top surface of floor. For wall assemblies, wrap strip is to be installed on both sides of wall such that the wrap strip is recessed 1/4 in. (6 mm) from both surfaces of wall.

3M COMPANY

3M FIRE PROTECTION PRODUCTS – Tuck-In Wrap Strip WS Roll

- C. **Fill, Void or Cavity Material* – Sealant** – Min 3/8 in. (9.5 mm) thickness of fill material applied within annulus at top surface of floor or both surfaces of wall and smoothed over to lap onto floor or wall surfaces around the periphery of opening.

3M COMPANY FIRE PROTECTION PRODUCTS – IC 15WB+, CP 25WB+, and FB 3000WT sealants (CP 25WB+ not suitable for use with CPVC pipes.)

- D. **Foil Tape** – (Not Shown) – Required only when CPVC penetrant (Item 2B) is used. Nom 4 in. (102 mm) wide, 3 mil thick aluminum tape installed around pipe prior to installation of wrap strip. Foil tape is to be positioned such that it will be centered under the wrap strip material with adhesive side out.

*Bearing the UL Classification Mark

+Bearing the UL Listing Mark

Reprinted from the Online Certifications Directory with permission from UL

© 2013 UL LLC



System No. C-AJ-2685

April 28, 2014

ANSI/UL1479 (ASTM E814)

F Rating — 2 Hr
T Rating — 1/4 Hr

CAN/ULC S115

F Rating — 2 Hr
FT Rating — 1/4 Hr
FH Ratings — 2 Hr
FTH Rating — 1/4 Hr

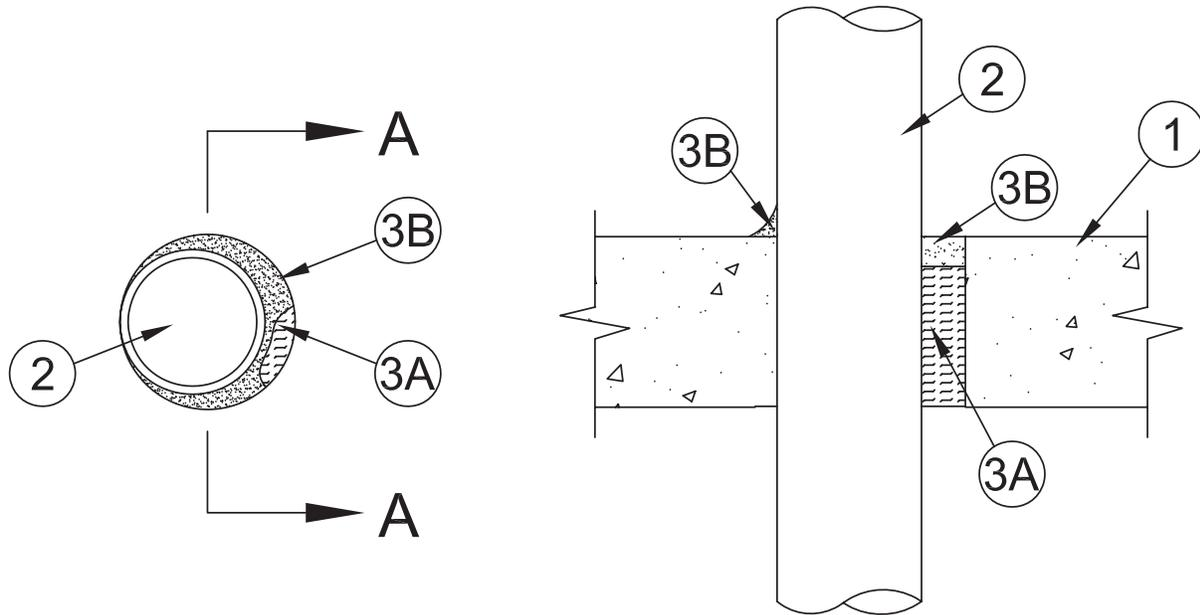

SECTION A-A

System tested with a pressure differential of 2.5 Pa between the exposed and the unexposed surfaces with the higher pressure on the exposed side.

- Floor Assembly** – Min 2-1/2 in. (64 mm) thick reinforced lightweight or normal weight (100-150 pcf or 1600 - 2400 kg/m³) concrete floors or min 3 in. (76 mm) thick reinforced lightweight or normal weight concrete walls. Floor assembly may also be constructed of any min 6 in. (152 mm) thick UL Classified hollow-core **Precast Concrete Units***. Wall may also be constructed of any UL Classified **Concrete Blocks***. Max diam of opening 6 in. (152 mm).

See **Concrete Blocks (CAZT)** and **Precast Concrete Units (CFTV)** categories in the Fire Resistance Directory for names of manufacturers.

- Through Penetrants** – Nom 4 in. (102 mm) diam Green Thread® fiberglass reinforced epoxy pipe with resin corrosion barrier for use in closed (process or supply) or vented (drain, waste or vent) piping system. One pipe installed within the firestop system with an annular space between the pipe and periphery of opening of min 0 in. (point contact) to max 1-1/2 in. (38 mm). Pipe to be rigidly supported on both sides of the floor or wall assembly.

- Firestop System** – The details of the firestop system shall be as follows:

A. **Packing Material** – Min 2 in. (51 mm) thickness of min 4 pcf (64 kg/m³) mineral wool batt insulation firmly packed into opening as a permanent form. Packing material to be recessed from top surface of floor or from both surfaces of wall to accommodate the required thickness of fill material. In floors constructed of hollow-core concrete, packing material to be recessed from top and bottom surfaces of floor as required to accommodate the required thickness of fill material.

B. **Fill, Void or Cavity Material* – Foam** – Min 1/2 in. (13 mm) thickness of caulk applied within the annulus, flush with top surface of floor or with both surfaces of wall. In floors constructed of hollow-core concrete, min 1/2 in. (13 mm) thickness of caulk applied within the annulus, flush with top and bottom surfaces of floor. Min 1/4 in. (6 mm) diam bead of caulk applied to the penetrant/concrete interface at the point contact location on the top surface of floor or both surfaces of wall or hollow-core floor.

3M COMPANY – IC 15WB+ Caulk

*Indicates such products shall bear the UL or cUL Certification Mark for jurisdictions employing the UL or cUL Certification (such as Canada), respectively.

Reprinted from the Online Certifications Directory with permission from UL
© 2014 UL LLC



System No. C-AJ-2686

February 04, 2015

ANSI/UL1479 (ASTM E814)

F Rating — 2 Hr
T Rating — 1/2 Hr

CAN/ULC S115

F Rating — 2 Hr
FT Rating — 1/2 Hr
FH Ratings — 2 Hr
FTH Rating — 1/2 Hr

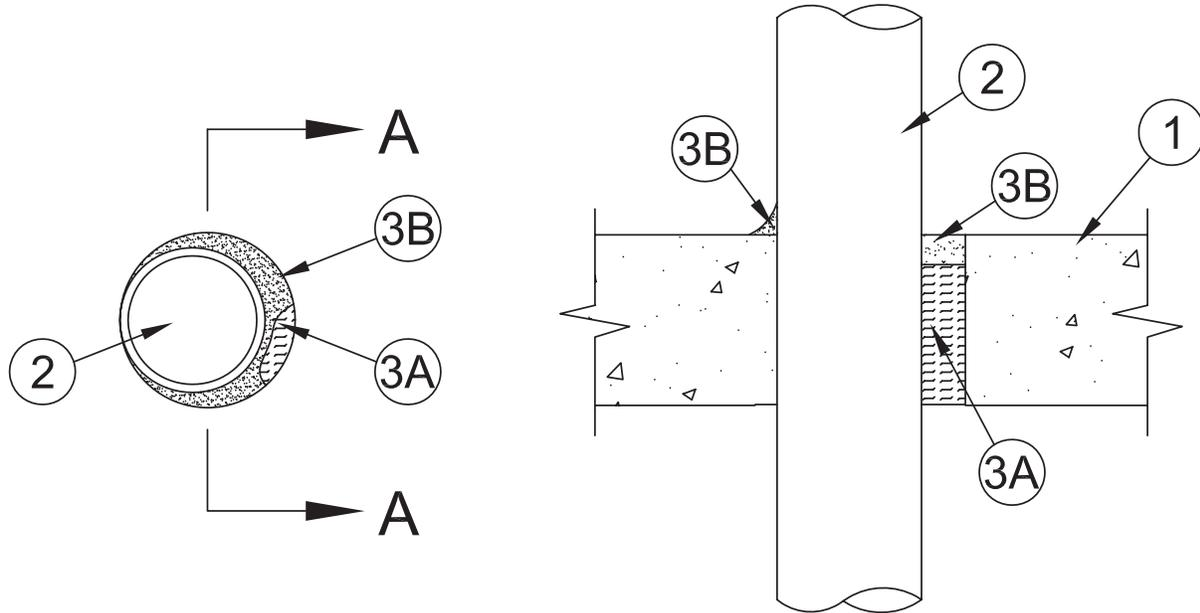

SECTION A-A

System tested with a pressure differential of 2.5 Pa between the exposed and the unexposed surfaces with the higher pressure on the exposed side.

1. **Floor Assembly** – Min 2-1/2 in. (64 mm) thick reinforced lightweight or normal weight (100-150 pcf or 1600 - 2400 kg/m³) concrete floors or min 3 in. (76 mm) thick reinforced lightweight or normal weight concrete walls. Floor assembly may also be constructed of any min 6 in. (152 mm) thick UL Classified hollow-core **Precast Concrete Units***. Wall may also be constructed of any UL Classified **Concrete Units***. Max diam of opening 6 in. (152 mm).

See **Concrete Blocks (CAZT)** and **Precast Concrete Units (CFTV)** categories in the Fire Resistance Directory for names of manufacturers.

2. **Through Penetrants** – Nom 4 in. (102 mm) diam Z-Core® fiberglass reinforced epoxy pipe with resin corrosion barrier for use in closed (process or supply) or vented (drain, waste or vent) piping system. One pipe installed within the firestop system with an annular space between the pipe and periphery of opening of min 0 in. (point contact) to max 1-1/2 in. (38 mm). Pipe to be rigidly supported on both sides of the floor or wall assembly.

3. **Firestop System** – The details of the firestop system shall be as follows:

- A. **Packing Material** – Min 2 in. (51 mm) thickness of min 4 pcf (64 kg/m³) mineral wool batt insulation firmly packed into opening as a permanent form. Packing material to be recessed from top surface of floor or from both surfaces of wall to accommodate the required thickness of fill material. In floors constructed of hollow-core concrete, packing material to be recessed from top and bottom surfaces of floor as required to accommodate the required thickness of fill material.
- B. **Fill, Void or Cavity Material*** – Min 1/2 in. (13 mm) thickness of caulk applied within the annulus, flush with top surface of floor or with both surfaces of wall. In floors constructed of hollow-core concrete, min 1/2 in. (13 mm) thickness of caulk applied within the annulus, flush with top and bottom surfaces of floor. Min 1/4 in. (6 mm) diam bead of caulk applied to the penetrant/concrete interface at the point contact location on the top surface of floor or both surfaces of wall or hollow-core floor.

3M COMPANY – IC 15WB+ Caulk, CP 25WB+ and FB-3000 WT Sealants

* Indicates such products shall bear the UL or cUL Certification Mark for jurisdictions employing the UL or cUL Certification (such as Canada), respectively.

Reprinted from the Online Certifications Directory with permission from UL
© 2015 UL LLC



System No. C-AJ-2698

June 11, 2014

ANSI/UL1479 (ASTM E814)

F Rating — 2 Hr

T Rating — 2 Hr

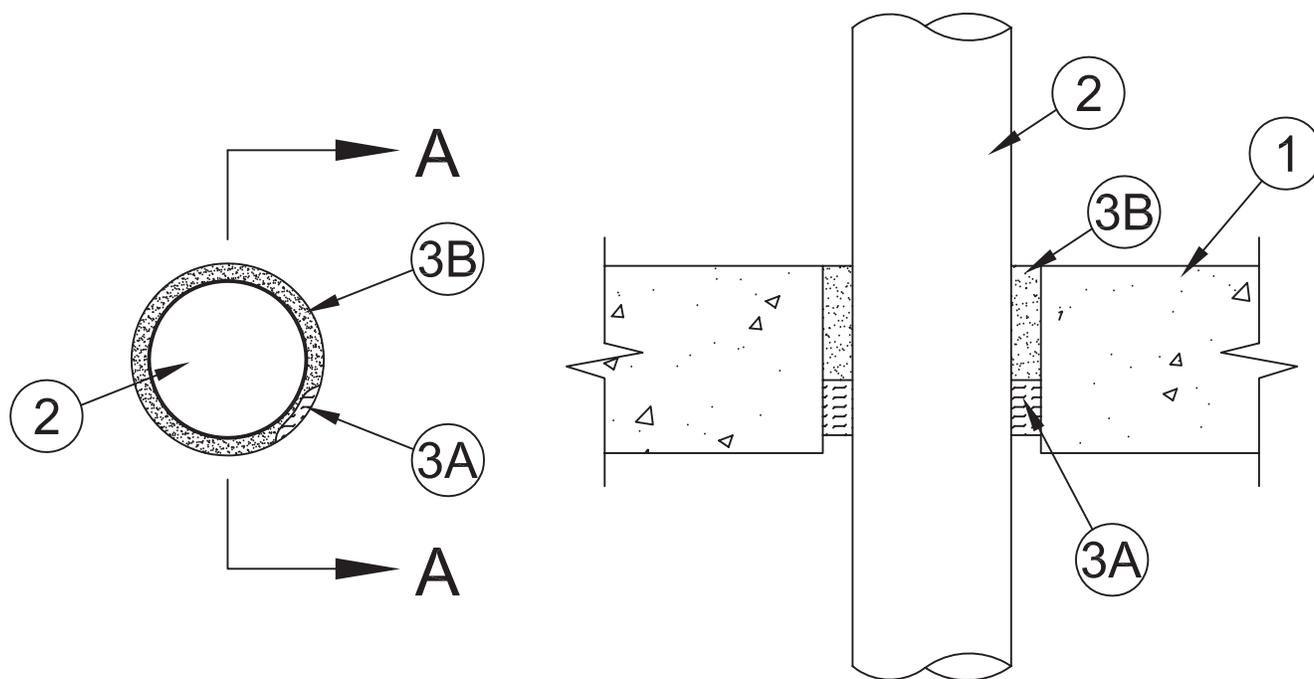

SECTION A-A

1. **Floor or Wall Assembly** — Min 4-1/2 in. (114 mm) thick floor or min 5 in. thick (152 mm) wall of lightweight or normal weight (100-150 pcf or 1600-2400 kg/m³) concrete. Wall may also be constructed of any UL Classified **Concrete Blocks***. Max diam of opening is 4-1/2 in. (152 mm).

See **Concrete Blocks*** (CAZT) in the Fire Resistance Directory for names of manufacturers.

2. **Through Penetrant** — One nonmetallic penetrant to be installed within the firestop system. A nom 1/2 in. (13 mm) annular space is required between the penetrant and the periphery of the opening. Penetrant to be rigidly supported on both sides of the floor or wall assembly. The following types and sizes of penetrants may be used.

A. **Crosslinked Polyethylene (PEX) Tubing** — Nom 3 in. (76 mm) diam (or smaller) SDR 9 Uponor AquaPEX tubing for use with closed (process and supply) piping systems.

3. **Firestop System** — The firestop system shall consist of the following:

A. **Packing Material** — Min 1 in. (25 mm) thickness of min 4 pcf (64kg/m³) mineral batt insulation firmly packed into opening as a permanent form. Packing material recessed from top surface of floor or both surfaces of wall to accommodate the required thickness of fill material. In wall assemblies, packing material installed flush with both surfaces of wall.

B. **Fill, Void or Cavity Materials* - Sealant** — Min 3 in. (76 mm) thickness of sealant applied within the annulus, flush with the top surface of the floor. In wall assemblies, fill material centered in opening and recessed from each surface to accommodate the required thickness of packing material.

3M COMPANY 3M FIRE PROTECTION PRODUCTS — FB-3000 WT Sealant

*Bearing the UL Classification Mark

Reprinted from the Online Certifications Directory with permission from UL

© 2014 UL LLC



Through Penetrations

Non-Metallic Pipes

2000 Series

Concrete

CAJ

System No. C-AJ-2699

June 18, 2014

ANSI/UL1479 (ASTM E814)

F Rating — 2 Hr

T Rating — 0

CAN/ULC S115

F Rating — 2 Hr

FT Rating — 0

FH Rating — 2 Hr

FTH Rating — 0

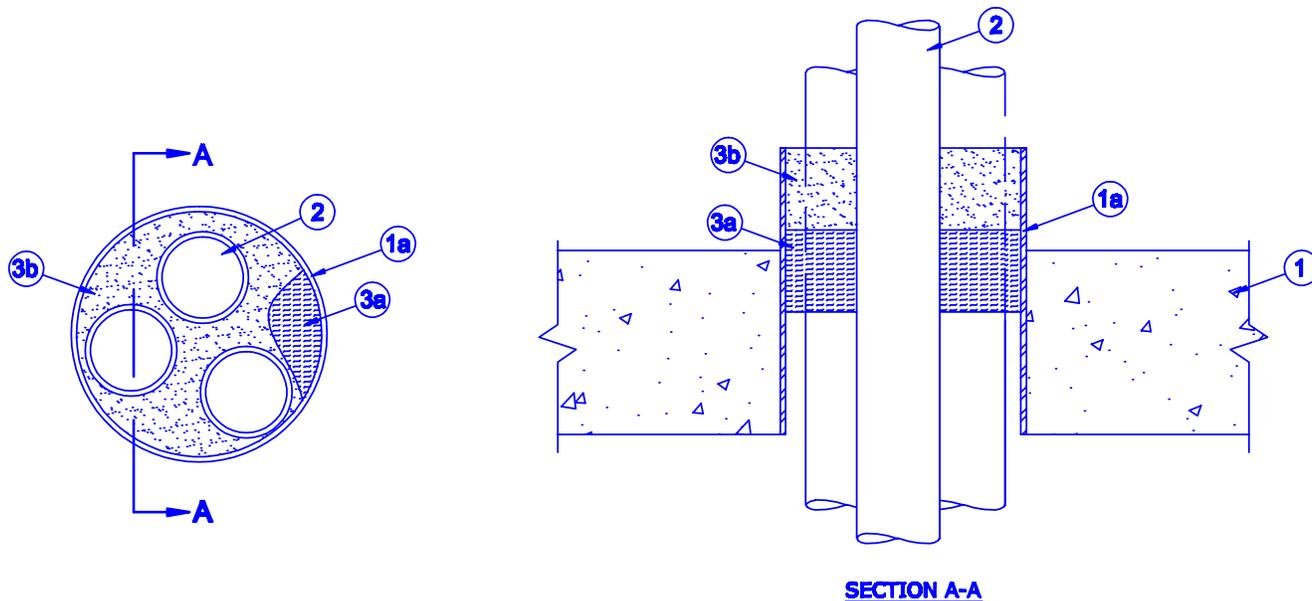

1. **Floor or Wall Assembly** — Min 4-1/2 in. (114 mm) thick floor or min 5 in. thick (152 mm) wall of lightweight or normal weight (100-150 pcf or 1600-2400 kg/m³) concrete. Wall may also be constructed of any UL Classified **Concrete Blocks***. Max diam of opening is 6-1/2 in. (165 mm).

See **Concrete Blocks** (CAZT) in the Fire Resistance Directory for names of manufacturers.

1A. **Steel Sleeve** — Nom 6 in. (152 mm) diam (or smaller) Schedule 10 steel sleeve. Steel to extend a min 2-1/2 in. (64 mm) beyond top surface of floor and both surfaces of wall.

2. **Electrical Nonmetallic Tubing+** — Three, nominal 2 in. (51 mm) diameter (or smaller) electrical nonmetallic tubing (ENT) constructed of polyvinyl chloride (PVC) or polyethylene (PE). ENT to be installed in accordance with Article No. 331 of the National Electrical Code (NFPA 70). The space between ENT's shall be a min 1/4 in. (6.4 mm) to a max 1/2 in. (13 mm). The annular space between the ENT and the periphery of the opening shall be a min of point contact to a max 3/4 in. (76 mm). Penetrant to be rigidly supported on both sides of the floor or wall assembly.

See Electrical Nonmetallic Tubing (FKHU) category in the Electrical Construction Materials Directory for names of manufacturers

3. **Firestop System** — The firestop system shall consist of the following:

- A. **Packing Material** — Min 2 in. (51 mm) thickness of min 4 pcf (64kg/m³) mineral batt insulation firmly packed into opening as a permanent form. Packing material recessed from surface of floor or both surfaces of wall to accommodate the required thickness of fill material.
- B. **Fill, Void or Cavity Materials*** — Sealant — In floors, min 2 in. (51 mm) thickness of sealant applied within the annulus, flush with the top surface of the steel sleeve. In walls, min 2 in. (51 mm) thickness of sealant applied within the annulus, flush with both ends of steel sleeve.

3M COMPANY — FB-3000 WT Sealant

System tested with a pressure differential of 2.5 Pa between the exposed and the unexposed surfaces with the higher pressure on the exposed side.

*Bearing the UL Classification Mark

Reprinted from the Online Certifications Directory with permission from UL
© 2014 UL LLC



System No. C-AJ-2731

June 30, 2015

F Rating 3 Hr

T Rating 2 Hr

L Rating at Ambient - Less Than 1 CFM/sq ft

L Rating at 400°F - Less Than 1 CFM/sq ft

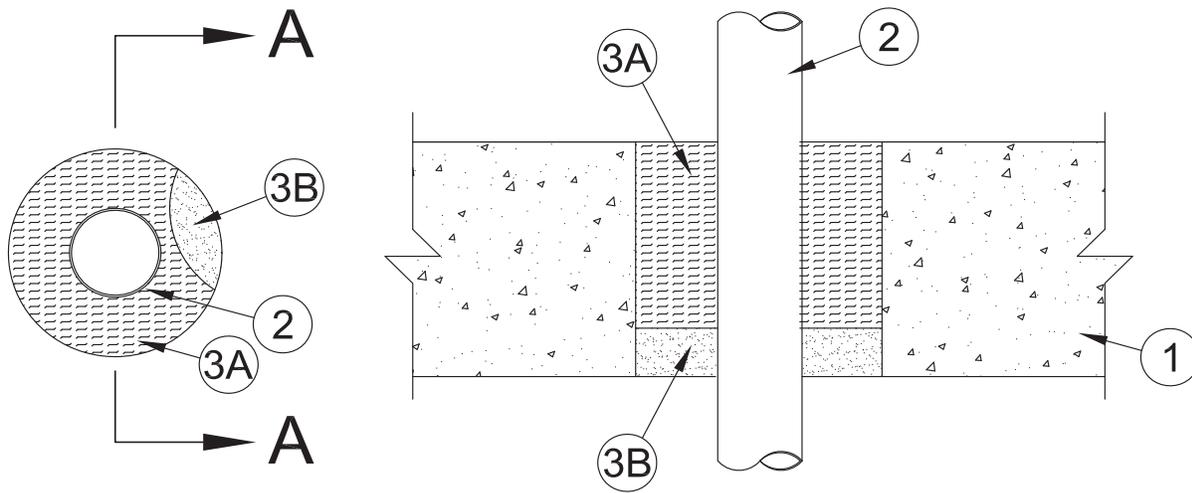

SECTION A-A

- 1. Floor or Wall Assembly** — Min 4-1/2 in. (114 mm) thick reinforced lightweight normal weight concrete (100-150 pcf or 1600-2400 kg/m³) floor or min 5-1/2 in. (140 mm) thick reinforced lightweight normal weight concrete (100-150 pcf or 1600-2400 kg/m³) wall. Wall may also be constructed of any UL Classified **Concrete Block**. Max diam of opening is 4 in. (102 mm).
See **Concrete Blocks** category in the Fire Resistance Directory for names of manufacturers
- 2. Nonmetallic Pipe** — One nonmetallic pipe to be installed concentrically or eccentrically within the firestop system. The annular space shall be min 1/4 in. (6 mm) to max 1 3/8 in (35 mm). Pipe to be rigidly supported on both sides of floor and wall assembly.
 - A. Chlorinated Polyvinyl Chloride (CPVC) Pipe** — Nom 2 in. (51 mm) diam (or smaller) SDR 11 chlorinated polyvinyl chloride (CPVC) pipe for use in closed (process or supply) piping systems.
 - B. Polyvinyl Chloride (PVC) Pipe** — Nom 2 in. (51 mm) diam (or smaller) cellular or solid core Schedule 40 PVC pipe for use in closed (process or supply) piping systems.
- 3. Firestop System** — The firestop system shall consist of the following:
 - A. Packing Material** — Min 3-1/2 in. (89 mm) of min 4 pcf (64 kg/m³) mineral wool insulation firmly packed into opening as a permanent form. Packing material to be recessed from bottom surface of floor or both surfaces of wall to accommodate the required thickness of fill material.
 - B. Fill, Void or Cavity Material*— Caulk** — Min 1 in. (25 mm) thickness of caulk applied within annulus, flush with bottom surface of floor or both surfaces of wall.
3M COMPANY 3M FIRE PROTECTION PRODUCTS — IC-15WB+ Caulk, CP25WB+ Caulk or FB 3000WT Sealant
(**Note:** CP 25WB+ Caulk not suitable for use with CPVC pipes.)

* Indicates such products shall bear the UL or cUL Certification Mark for jurisdictions employing the UL or cUL Certification (such as Canada), respectively.

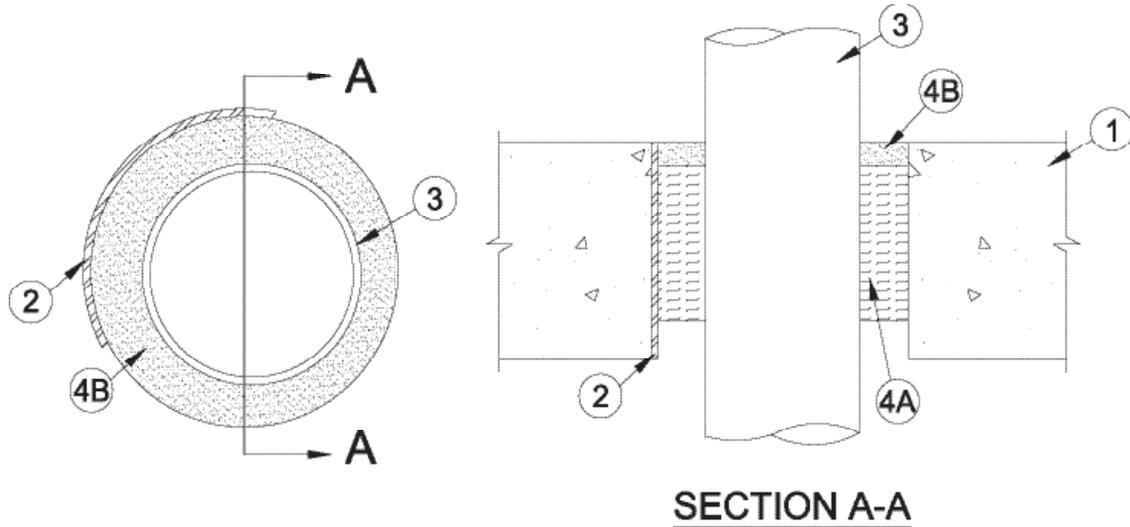

System No. C-AJ-2738XHEZ - Through-penetration Firestop Systems
July 30, 2015**F Rating — 2 Hr****T Rating — 0 Hr****W Rating — Class 1 (See Item 4)****SECTION A-A**

1. **Floor or Wall Assembly** — Min 4-1/2 in. (114 mm) thick reinforced lightweight or normal weight (100-150 pcf or 1778 - 2400 kg/m³) concrete. Floor assembly may also be constructed of any min 6 in. (152 mm) thick UL Classified hollow-core Precast Concrete Units*. Wall may also be constructed of any UL Classified **Concrete Blocks***. Max diam of opening 5 in. (127 mm).
See **Concrete Blocks (CAZT)** and **Precast Concrete Units (CFTV)** categories in Fire Resistance Directory for names of manufacturers.
2. **Steel Sleeve — (Optional)** - Nom 5 in. (127 mm) diam (or smaller) Schedule 10 (or heavier) steel sleeve cast or grouted into floor or wall assembly. Steel sleeve may be installed flush or may project max 2 in. (51 mm) beyond the floor or wall surfaces.
3. **Through-Penetrants** — One nonmetallic pipe, conduit or tube installed concentrically or eccentrically within opening. Annular space between penetrant and periphery of opening or sleeve shall be min of 1/4 in. (6 mm) to max 2 in. (51 mm). The space between penetrant shall be min of 1/4 in. (6 mm) to max 2 in. (51 mm). Penetrant to be rigidly supported on both sides of floor or wall assembly. The following types and sizes of penetrants may be used:
 - A. **Polyvinyl Chloride (PVC) Pipe** — Nom 2 in. (51 mm) diam (or smaller) Schedule 40 solid core PVC pipe for use in closed (process or supply) or vented (drain, waste or vent) piping systems.
 - B. **Rigid Nonmetallic Conduit+** — Nom 2 in. (51 mm) diam (or smaller) Schedule 40 PVC conduit installed in accordance with Article 347 of the National Electrical Code (NFPA No. 70).
 - C. **Chlorinated Polyvinyl Chloride (CPVC) Pipe** — Nom 2 in. (51 mm) diam (or smaller) SDR13.5 CPVC pipe for use in closed (process or supply) piping systems.
 - D. **Crosslinked Polyethylene (PEX) Tubing** — Nom 1 in. (25 mm) diam (or smaller) SDR 9 PEX tubing for use in closed (process or supply) or vented (drain, waste or vent) piping systems.
4. **Firestop System** — The details of the firestop system shall be as follows:
 - A. **Packing Material** — Min 3 in. (76 mm) thickness of min 4 pcf (64 kg/m³) mineral wool batt insulation firmly packed into opening as a permanent form. Packing material to be recessed from top surface of floor or top edge of sleeve or from both surfaces of wall or both ends of sleeve as required to accommodate the required thickness of fill material. In floors constructed of hollow-core concrete, packing material to be recessed from top and bottom surfaces of floor or sleeve as required to accommodate the required thickness of fill material.
 - B. **Fill, Void or Cavity Materials* - Caulk or Sealant** — Min 1/2 in. (13 mm) thickness of caulk applied within the annulus, flush with top surface of floor or top edge of sleeve or with both surfaces of wall or both ends of sleeves. In floors constructed of hollow-core concrete, min 1/2 in. (13 mm) thickness of caulk applied within the annulus, flush with top and bottom surfaces of floor or sleeve. Min 1/4 in. (6 mm) diam bead of caulk applied to the penetrant/concrete or penetrant/sleeve interface at the point contact location on the top surface of floor or both surfaces of wall or hollow-core concrete.
3M COMPANY 3M FIRE PROTECTION PRODUCTS — IC 15WB+, CP 25WB+ caulk or FB-3000 WT sealant
(Note - W Rating applies only when FB-3000 WT is used. CP 25WB+ not suitable for use with CPVC pipes.)

* Indicates such products shall bear the UL or cUL Certification Mark for jurisdictions employing the UL or cUL Certification (such as Canada), respectively.



System No. C-AJ-2746

October 21, 2015

F Rating — 3 Hr
T Rating — 1-1/2 Hr
L Rating at Ambient — Less than 1 CFM/sq ft
L Rating at 400 F — Less than 1 CFM/sq ft

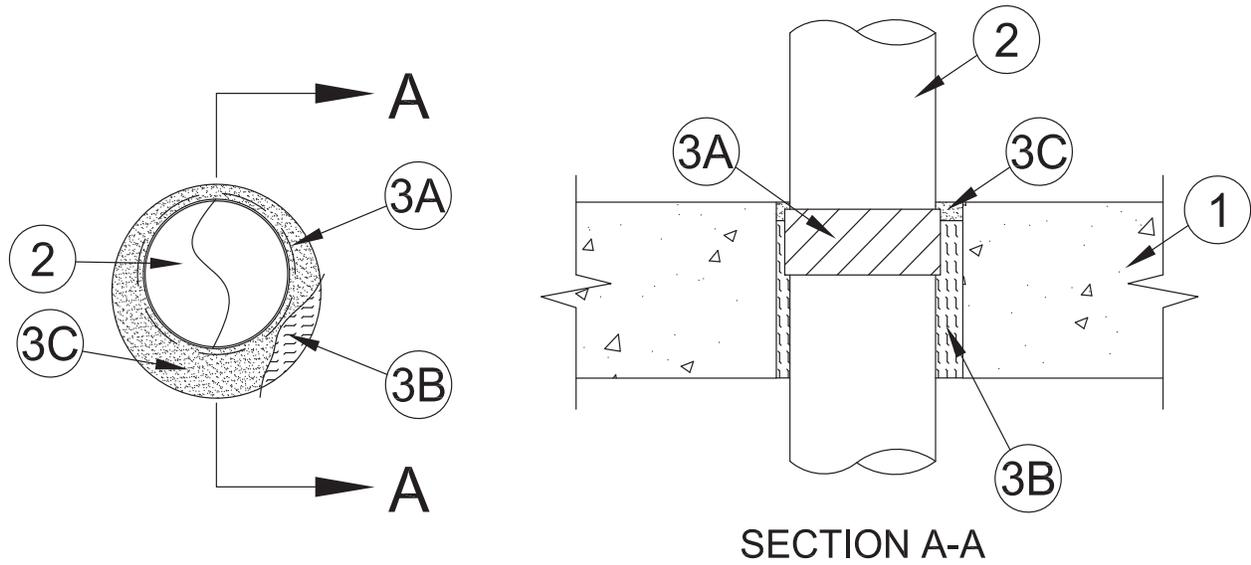

- 1. Floor or Wall Assembly** — Min 4-1/2 in. (114 mm) thick reinforced lightweight or normal weight (100-150 pcf or 1600-2400 kg/m³) concrete floor or min 5 in. (127 mm) thick reinforced lightweight or normal weight concrete wall. Floor may also be constructed of any min 6 in. (152 mm) thick UL Classified hollow core **Precast Concrete Units***. Wall may also be constructed of any UL Classified **Concrete Blocks***. Max diam of opening is 6 in. (152 mm).

See **Concrete Blocks (CAZT)** and **Precast Concrete Units (CFTV)** categories in the Fire Resistance Directory for names of manufacturers.

- 2. Through Penetrants** — One nonmetallic pipe to be installed either concentrically or eccentrically within the firestop system. The annular space between pipe or conduit and periphery of the opening shall be min 1/4 in. (6 mm) to max 3/4 in. (19 mm). Pipe to be rigidly supported on both sides of the floor or wall assembly. The following types and sizes of nonmetallic pipes may be used:

A. Polypropylene (PP-RCT) Pipe — Nom 4 in. (125 mm OD) diam Polystar™ CT-White SDR 11 PP pipe for use in closed (process or supply) piping systems.

- 3. Firestop System** — The firestop system shall consist of the following:

A. Fill, Void or Cavity Materials* — Wrap Strip — Min 3/16 in. (5 mm) thick intumescent material supplied in 2-1/2 in. (64 mm) wide strip. Wrap strip is tightly wrapped around pipe in one continuous layer and secured with filament tape. When installed in floors, wrap strip is to be installed within the opening such that the top of the wrap strip is recessed 1/4 in. (6 mm) below the top surface of floor. For wall assemblies, wrap strip is to be installed on both sides of wall such that the wrap strip is recessed 1/4 in. (6 mm) from both surfaces of wall.

3M COMPANY 3M FIRE PROTECTION PRODUCTS — Tuck-In Wrap Strip WS Roll

B. Packing Material — Min 4 in. (102 mm) thickness of min 4 pcf (64 kg/m³) mineral wool batt insulation firmly packed into opening as a permanent form. Packing material to be recessed from top surface of floor or both surfaces of wall assembly to accommodate the required thickness of fill material.

B1. Forming Material* — As an alternate to the packing material in Item 3B, nom 4 in. (102 mm) wide strips of min 1/2 in. (13 mm) thick compressible mat to be stacked to a thickness greater than the width of the annular space and compression-fitted, edge-first, to fill the annular space to a min 4 in. (102 mm) depth. Top of forming material to be recessed from top surface of floor or from both surfaces of wall as necessary to accommodate the required thickness of fill material.

3M COMPANY — Fire Barrier Packing Material

C. Fill, Void or Cavity Materials* - Sealant — Min 1/2 in. (13 mm) thickness of fill material applied within the annulus at top surface of floor or both surfaces of wall and smoothed over to lap onto floor or wall surfaces around the periphery of opening. In hollow-core floors, sealant to be applied at top and bottom surface of floor.

3M COMPANY 3M FIRE PROTECTION PRODUCTS — IC 15WB+, CP 25WB+ and FB 3000WT sealants

* Indicates such products shall bear the UL or cUL Certification Mark for jurisdictions employing the UL or cUL Certification (such as Canada), respectively.



Through Penetrations

Non-Metallic Pipes

2000 Series

Concrete

CAJ

System No. C-AJ-2758

March 28, 2016

F Rating — 2 Hr

T Rating — 0 Hr

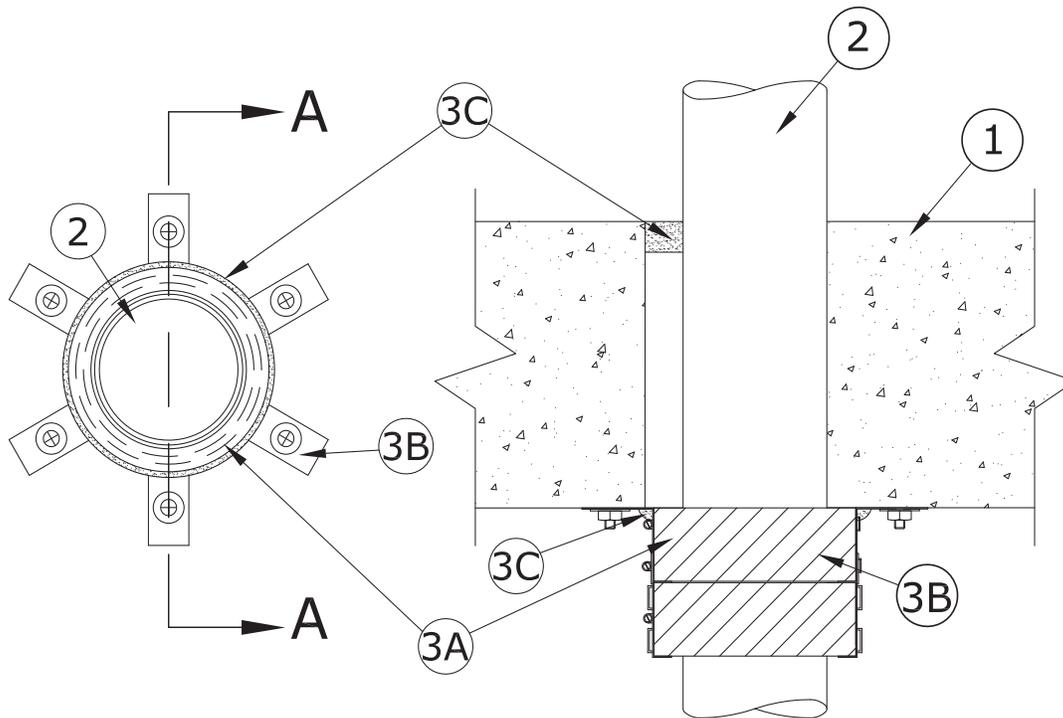

SECTION A-A

- 1. Floor or Wall Assembly** — Min 2-1/2 in. (64 mm) thick reinforced lightweight or normal weight (100-150 pcf or 1600-2400 kg/m³) concrete. Wall may also be constructed of any UL Classified **Concrete Blocks***. Floor may also be constructed of any min 6 in. (152 mm) thick UL Classified hollow-core **Precast Concrete Units**. Max diam of opening is 7 in. (178 mm).

See Concrete Blocks and Precast Concrete Units (CAZT) category in the Fire Resistance Directory for names of manufacturers.

- 2. Through Penetrant** — One nonmetallic pipe to be installed either concentrically or eccentrically within the firestop system. The annular space between the penetrant and the periphery of the opening shall be a min of 0 in. (point contact) to a max 1/4 in. (6 mm). Penetrant to be rigidly supported on both sides of the floor or wall assembly. The following types and sizes of nonmetallic penetrants may be used:

A. **High Density Polyethylene (HDPE) Pipe** — Nom 6 in. (152 mm) diam (or smaller) SDR11 HDPE pipe for use in closed (process or supply) or vented (drain, waste or vent) piping systems piping systems.

- 3. Firestop System** — The firestop system shall consist of the following:

A. **Fill, Void or Cavity Material* — Wrap Strip** — Nom 1/8 in. (3.2 mm) thick intumescent material supplied in 2 in. (51 mm) wide strips. Wrap strip tightly wrapped around the outer circumference of the nonmetallic pipe and butted tightly against the bottom surface of the floor or both surfaces of the wall. Two stacks of four layers of wrap strip shall be used. Wrap strip layers temporarily held in position using aluminum foil tape, steel wire tie, or equivalent.

3M COMPANY 3M FIRE PROTECTION PRODUCTS — Ultra GS

B. **Steel Collars** — Nom 2 in. (51 mm) deep collar with 1-1/4 in. (32 mm) wide by 2 in. (51 mm) long anchor tabs and min 1/2 in. (13 mm) long tabs to retain wrap strip layers. Coils of precut 0.016 in. (0.41 mm) thick (28 gauge) galv sheet steel available from wrap strip manufacturer. As an alternate, collar may be field-fabricated from min 0.016 in. (0.41 mm) thick (28 gauge) galv sheet steel in accordance with instruction sheet supplied by wrap strip manufacturer. One steel collar is wrapped tightly around each stack of wrap strip layers with min 1 in. (25 mm) collar overlap at seam. Collar nearest floor or wall is secured to bottom surface of the floor, or both surfaces of wall, with collar anchor tabs bent outward 90 deg and secured at each anchor tab by means of min 1/4 in. (6 mm) diam by 1-1/4 in. (32 mm) long steel expansion bolts or steel Tapcon® concrete anchors in conjunction with 1-1/4 in. (32 mm) diam steel fender washers. Anchor tabs of remaining collar is lapped onto and secured to adjacent collar with 1/2 in. (13 mm) wide stainless or steel band clamp. In addition, collar nearest floor or wall surfaces shall be secured with one 1/2 in. (13 mm) wide stainless or steel band clamp, and the remaining collar shall be secured with two 1/2 in. (13 mm) wide stainless or steel band clamps.

C. **Fill, Void or Cavity Material* — Sealant** — A min 1/2 in. (13 mm) bead of sealant shall applied to the collar/concrete interface at bottom surface of floor or both surfaces of wall. In addition, in floors, min 1/2 in. (13 mm) thickness of sealant applied within the annulus flush with top surface of floor.

3M COMPANY 3M FIRE PROTECTION PRODUCTS — IC 15WB+ Sealant, CP 25WB+ Sealant or FB-3000 WT Sealant

* Indicates such products shall bear the UL or cUL Certification Mark for jurisdictions employing the UL or cUL Certification (such as Canada), respectively.



System No. C-AJ-2759

April 04, 2016

F Rating — 2 Hr

T Rating — 0 and 2 Hr (See Item 3)

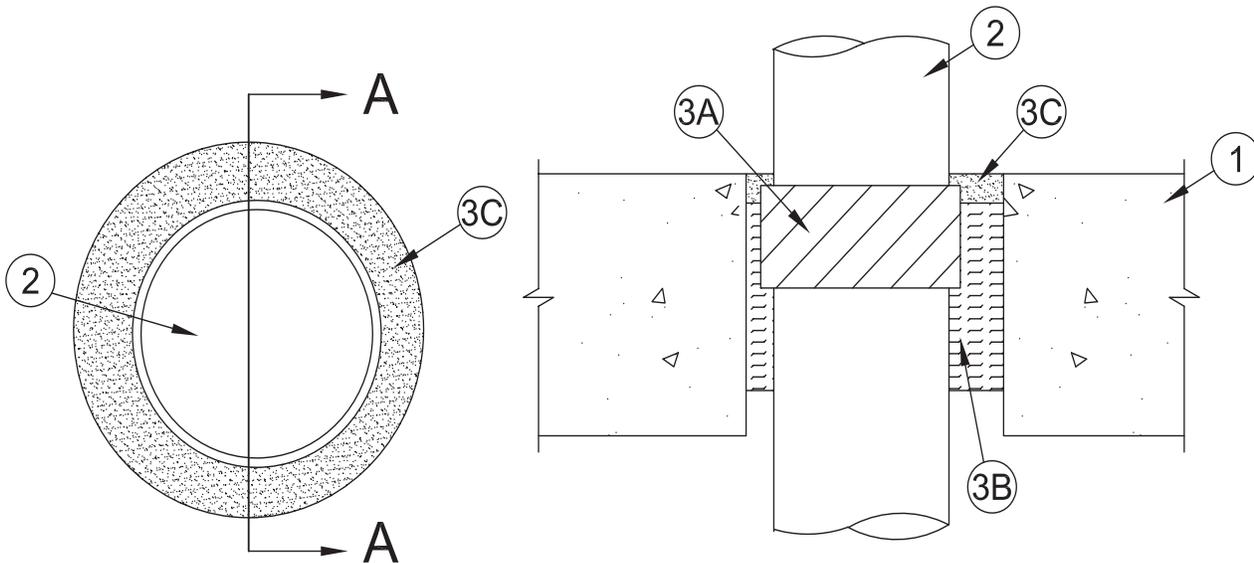

SECTION A-A

1. **Floor or Wall Assembly** — Min 4-1/2 in. (64 mm) thick floor, or min 5 in. (127 mm) thick wall, constructed of reinforced lightweight or normal weight (100-150 pcf or 1600-2400 kg/m³) concrete. Wall may also be constructed of any UL Classified **Concrete Blocks***. Max diam of opening is 6-1/2 in. (165 mm).

See **Concrete Blocks (CAZT)** category in the Fire Resistance Directory for names of manufacturers.

2. **Through Penetrant** — One nonmetallic pipe to be installed either concentrically or eccentrically within the firestop system. The annular space between the penetrant and the periphery of the opening shall be a min of 1/2 in. (13 mm) to a max 1-1/2 in. (38 mm). Penetrant to be rigidly supported on both sides of the floor or wall assembly. The following types and sizes of nonmetallic penetrants may be used:

A. **High Density Polyethylene (HDPE) Pipe** — Nom 4 in. (102 mm) diam (or smaller) SDR11 HDPE pipe for use in closed (process or supply) or vented (drain, waste or vent) piping systems piping systems.

3. **Firestop System** — The firestop system shall consist of the following:

A. **Fill, Void or Cavity Materials*** — **Wrap Strip** — Nom 1/8 in. (3.2 mm) thick intumescent material supplied in 2 in. (51 mm) wide strips. Wrap strip tightly wrapped around the outer circumference of the nonmetallic pipe with top edge recessed 1/4 in. from top surface of floor or both surfaces of wall. The number of layers of wrap strip required is dependent on pipe diam and type of piping system (open or closed) as shown in Table below. Wrap strip layers temporarily held in position using aluminum foil tape, steel wire tie, or equivalent.

3M COMPANY 3M FIRE PROTECTION PRODUCTS — Ultra GS

| Nom Pipe Diam (or smaller) | Piping System | No. of Wrap Strip Layer(s) | T Rating |
|----------------------------|----------------------------|----------------------------|----------|
| 1 in. (25 mm) | Closed (process or supply) | None | 2 Hr |
| 2 in. (51 mm) | Open (drain waste or vent) | One | 0 Hr |
| 2 in. (51 mm) | Closed (process or supply) | One | 2 Hr |
| 3 in. (76 mm) | Open (drain waste or vent) | Two | 0 Hr |
| 3 in. (76 mm) | Closed (process or supply) | Two | 2 Hr |
| 4 in. (102 mm) | Open (drain waste or vent) | Four | 2 Hr |
| 4 in. (102 mm) | Closed (process or supply) | Four | 2 Hr |

B. **Packing Material** — Min 4 in. (102 mm) thickness of min 4 pcf (64 kg/m³) mineral wool batt insulation firmly packed into opening as a permanent form. Packing material to be recessed from top surface of floor or from both surfaces of wall to accommodate the required thickness of fill material.

C. **Fill, Void or Cavity Material*** — **Sealant** — Min 1/2 in. (13 mm) thickness of sealant shall be applied within the annulus, flush with top surface of floor or both surfaces of wall.

3M COMPANY 3M FIRE PROTECTION PRODUCTS — CP 25WB+ Sealant or FB-3000 WT Sealant

* Indicates such products shall bear the UL or cUL Certification Mark for jurisdictions employing the UL or cUL Certification (such as Canada), respectively.



System No. C-BJ-2002

May 18, 2005
F Rating – 4 Hr
T Rating – 4 Hr

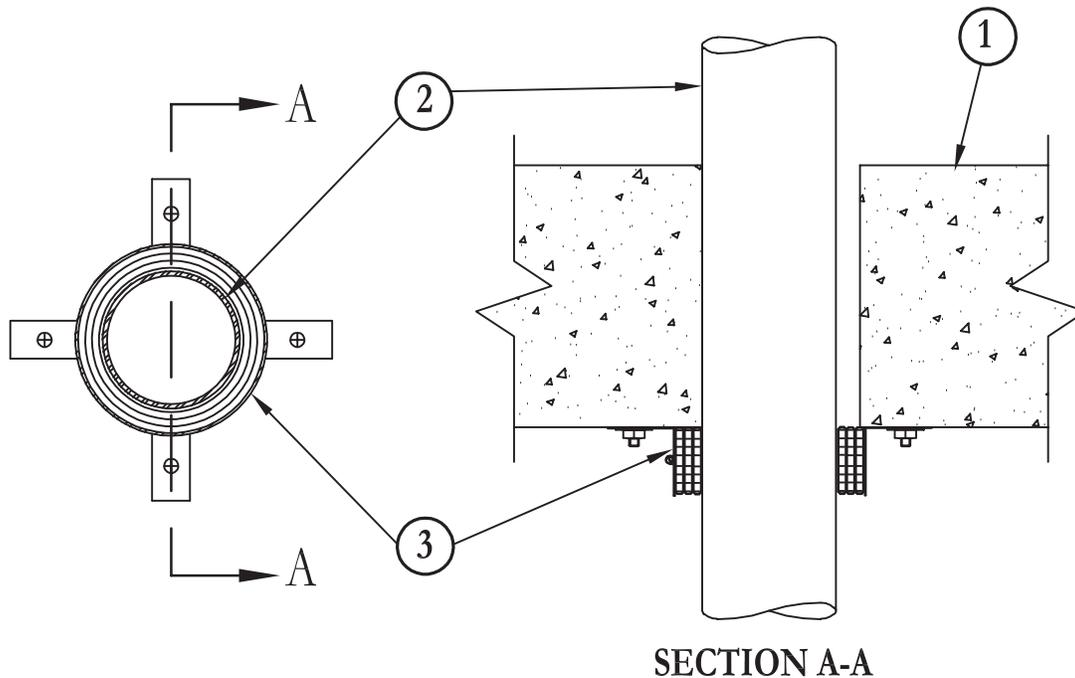

- Floor or Wall Assembly** – Min 5-1/2 in. (140 mm) thick reinforced lightweight or normal weight (100-150 pcf or 1600-2400 kg/m³) concrete. Wall may also be constructed of any UL Classified **Concrete Blocks***. Floor may also be constructed of any min 6 in. (152 mm) thick UL Classified hollow-core Precast Concrete Units*. Max diam of opening is 5 in. (127 mm).
See **Concrete Blocks** (CAZT) and Precast Concrete units (CFTV) categories in the Fire Resistance Directory for names of manufacturers.
- Through Penetrants** – One nonmetallic pipe or conduit to be installed either concentrically or eccentrically within the firestop system. The annular space between the pipe or conduit and the periphery of the opening shall be a min 0 in. (point contact) to a max 1/2 in. (0 mm to max 13 mm) Pipe to be rigidly supported on both sides of the floor or wall assembly. The following types and sizes of nonmetallic pipes or conduits may be used:
 - Polyvinyl Chloride (PVC) Pipe** – Nom 4 in. (102 mm) diam (or smaller). Schedule 40 solid core or cellular core PVC pipe for use in closed (process or supply) or vented (drain, waste or vent) piping systems.
 - Rigid Nonmetallic Conduit++** – Nom 4 in. (102 mm) diam (or smaller). Schedule 40 PVC conduit installed in accordance with Article 347 of the National Electrical Code (NFPA No. 70).
 - Chlorinated Polyvinyl Chloride (CPVC) Pipe** – Nom 4 in. (102 mm) diam (or smaller) SDR13.5 CPVC pipe for use in closed (process or supply) piping systems.
 - Acrylonitrile Butadiene Styrene (ABS) Pipe** – Nom 4 in. (102 mm) diam (or smaller). Schedule 40 solid core or cellular core ABS pipe for use in closed (process or supply) or vented (drain, waste or vent) piping systems.
 - Fire Retardant Polypropylene (FRPP) Pipe** – Nom 4 in. (102 mm) diam (or smaller). Schedule 40 FRPP pipe for use in closed (process or supply) or vented (drain, waste or vent) piping systems.
 - Polyvinylidene Fluoride (PVDF) Pipe** – Nom 4 in. (102 mm) diam (or smaller) Schedule 40 PVDF pipe for use in closed (process or supply) or vented (drain, waste or vent) piping systems.
- Firestop Device – Collar** – Collar to be installed in accordance with the accompanying installation instructions. Collar to be installed and latched around pipe and secured to bottom of floor or both sides of wall with min 3/16 in. (5 mm) diam by min 1-1/4 in. (32 mm) long steel masonry fasteners in conjunction with min 1-1/4 in. (32 mm) diam steel fender washers. Min of two, three or four fasteners, symmetrically located, for nom 2 in. (51 mm) diam (and smaller), nom 3 in. (76 mm) diam and nom 4 in. (102 mm) diam pipes, respectively.
3M COMPANY – Ultra PPD 1.5, 2.0, 3.0 and 4.0
- Fill, Void or Cavity Materials* – Caulk, Sealant or Putty** (Optional, Not Shown) – Min 1/4 in. (6 mm) thickness of caulk or putty applied within annular space, flush with top or bottom of floor or both sides of wall.
3M COMPANY – CP 25WB+, IC 15WB+ caulk, FB-3000 WT sealant or MP+ Stix putty.
(Note: CP 25WB+ not suitable for use with CPVC pipes.)

*Bearing the UL Classification Mark

++Bearing the UL Listing Mark

Reprinted from the Online Certifications Directory with permission from Underwriters Laboratories Inc.

Copyright © 2010 Underwriters Laboratories Inc.®



Note: Systems with Nonmetallic Through Penetrant(s) have not been evaluated with a pressure differential of 50 Pa between the exposed and unexposed surfaces as required by the National Building Code of Canada.

System No. C-BJ-2007

March 27, 2009

F Rating – 2 Hr

T Rating – 2 Hr

W Rating – Class 1 (See Item 3)

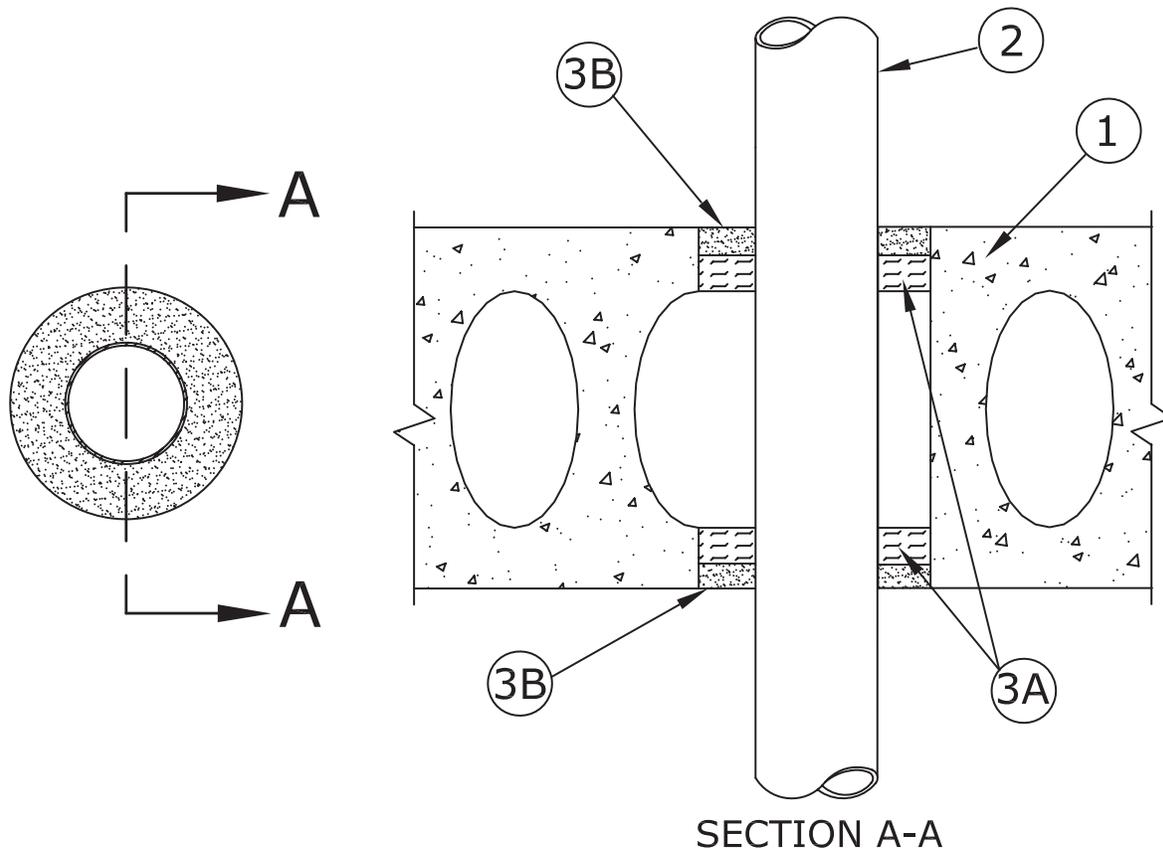

SECTION A-A

- 1. Floor or Wall Assembly** – Min 6 in. (152 mm) thick reinforced lightweight or normal weight (100-150 pcf or 1600 - 2400 kg/m³) concrete. Floor assembly may also be constructed of any min 6 in. (152 mm) thick UL Classified hollow-core **Precast Concrete Units***. Wall may also be constructed of any UL Classified **Concrete Blocks***. Diam of opening through floor or wall to be 1/2 to 5/8 in. (13 to 16 mm) larger than the outside diam of through-penetrant (Item 2). Max diam of opening is 3 in. (76 mm).
See **Concrete Block (CAZI)** and **Precast Concrete Units (CFTV)** categories in the Fire Resistance Directory for names of manufacturers.
- 2. Through Penetrants** – One nonmetallic pipe or conduit to be centered within the firestop system. Pipe or conduit to be rigidly supported on both sides of floor or wall assembly. The following types and sizes of nonmetallic pipes or conduits may be used:
 - A. Polyvinyl Chloride (PVC) Pipe** – Nom 2 in. (51 mm) diam (or smaller) Schedule 40 solid core PVC pipe for use in closed (process or supply) piping system.
 - B. Rigid Nonmetallic Conduit+** – Nom 2 in. (51 mm) diam (or smaller) Schedule 40 PVC conduit installed in accordance with Article 347 of the National Electrical Code (NFPA No. 70).
 - C. Chlorinated Polyvinyl Chloride (CPVC) Pipe** – Nom 2 in. (51 mm) diam (or smaller) SDR13.5 CPVC pipe for use in closed (process or supply) piping systems.
- 3. Firestop System** – The details of the firestop system shall be as follows:
 - A. Packing Material** – Nom 1 in. (25 mm) thickness of min 4 pcf (64 kg/m³) mineral wool batt insulation or ceramic (alumina silica) fiber blanket firmly packed into opening as a permanent form on both sides of floor and wall. Packing material to be recessed from both surfaces of floor or wall as required to accommodate the required thickness fill material.
 - B. Fill, Void or Cavity Material* – Caulk or Sealant** – Min 1/2 in. (13 mm) thickness of fill material applied within the annulus, flush with both surfaces of floor or wall.
3M COMPANY – CP 25WB+, IC 15WB+ or FB-3000 WT sealant
(Note: W Rating applies only when FB-3000 WT is used. CP 25WB+ not suitable for use with CPVC pipes.)

*Bearing the UL Classification Mark

Reprinted from the Online Certifications Directory with permission from UL
© 2013 UL LLC



System No. F-A-2002

May 20, 2005

F Ratings – 1, 1-1/2 and 2 Hr (See Item 3)

T Ratings – 1, 1-1/2 and 2 Hr (See Item 3)

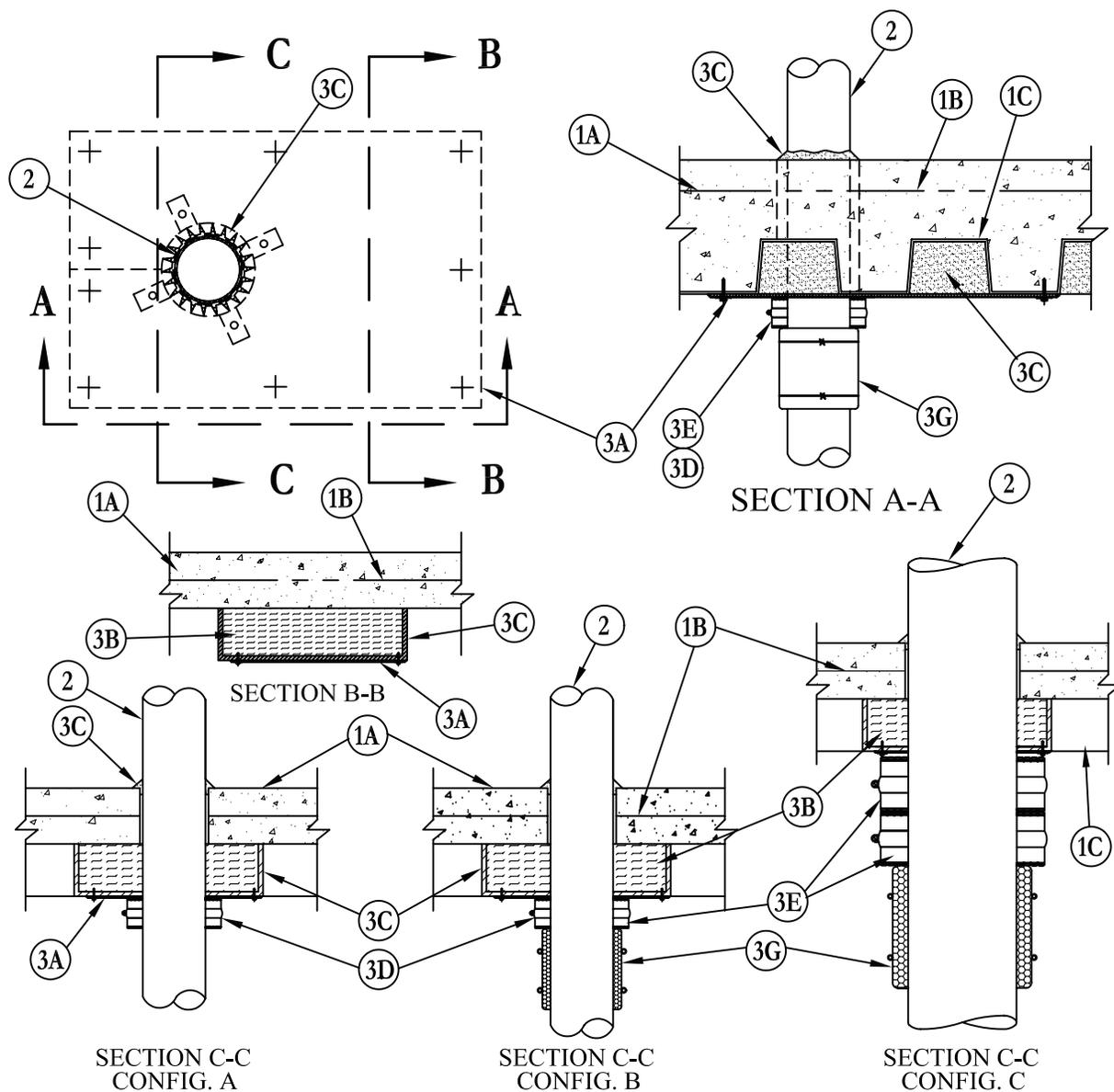

1. **Floor-Ceiling Assembly** – The fire-rated unprotected steel deck Floor-Ceiling assembly shall be constructed of the materials and in the manner specified in the individual D900 Series Designs in the UL Fire Resistance Directory and as summarized below:
 - A. **Normal Weight or Lightweight Concrete** – Normal weight concrete with carbonate or siliceous aggregate, 145 to 155 pcf or 2300-2500 kg/m³ unit weight, min 3000 psi (210 kg/m²) compressive strength. Lightweight concrete with expanded shale, clay or slate aggregate, 105 to 115 pcf or 1700-1850 kg/m³ unit weight, min 3000 psi compressive strength.
 - B. **Welded Wire Fabric** – 6x6-W1.4xW1.4.
 - C. **Steel Floor and Form Units*** – Composite or noncomposite 1-1/2, 2 or 3 in. (38, 51, or 76 mm) deep fluted galv units as specified in the individual Floor-Ceiling design.
Max diam of opening core-drilled through floor assembly is 9 in. (229 mm).
2. **Nonmetallic Pipe** – Nom 4 in. (102 mm) diam (or smaller) Schedule 40 flame retardant polypropylene (FRPP) pipe or nom 8 in. (203 mm) diam (or smaller) Schedule 40 solid core polyvinyl chloride (PVC) pipe or nom 8 in. (203 mm) diam (or smaller) Schedule 40 chlorinated polyvinyl chloride (CPVC) pipe for use in closed (process or supply) or vented (drain, waste or vent) piping systems. Diam of circular opening core-drilled through Floor-Ceiling assembly to be no greater than 1/2 in. (13 mm) larger than outside diam of pipe. Pipe to be centered in through opening and rigidly supported on both sides of floor assembly.

System No. F-A-2002 continued

3. **Firestop System** – The hourly F and T Ratings for the firestop system are dependent upon the type and thickness of the concrete topping over the fluted steel floor units, the type and size of the nonmetallic pipe and the firestop configuration, as tabulated below:

| Concrete Type (a) | Min Concrete Topping Thkns In. (mm) | Pipe Type | Nom Pipe Diam In. (mm) | Firestop Config (b) | F Rating Hr | T Rating Hr |
|-------------------|-------------------------------------|-----------------|------------------------|---------------------|-------------|-------------|
| NW | 3-1/2 (89) | CPVC, PVC | 1/2-4 (13-102) | A | 1 | 0 |
| NW | 3-1/2 (89) | CPVC, FRPP, PVC | 1/2-4 (13-102) | B | 1 | 1 |
| NW | 3-1/2 (89) | CPVC, PVC | 6, 8 (152, 203) | C | 1 | 1 |
| NW | 4 (102) | CPVC, PVC | 1/2-4 (13-102) | A | 1-1/2 | 0 |
| NW | 4 (102) | CPVC, FRPP, PVC | 1/2-4 (13-102) | B | 1-1/2 | 1-1/2 |
| NW | 4 (102) | CPVC, PVC | 6, 8 (152, 203) | C | 1-1/2 | 1-1/2 |
| NW | 4-1/2 (114) | CPVC, PVC | 1/2-4 (13-102) | A | 2 | 0 |
| NW | 4-1/2 (114) | CPVC, FRPP, PVC | 1/2-4 (13-102) | B | 2 | 2 |
| NW | 4-1/2 (114) | CPVC, PVC | 6, 8 (152, 203) | C | 2 | 2 |
| LW | 3-1/4 (82.6) | CPVC, PVC | 1/2-4 (13-102) | A | 2 | 0 |
| LW | 3-1/4 (82.6) | CPVC, FRPP, PVC | 1/2-4 (13-102) | B | 2 | 2 |
| LW | 3-1/4 (82.6) | CPVC, PVC | 6, 8 (152, 203) | C | 2 | 2 |

- (a) NW denotes normal weight concrete, LW denotes lightweight concrete.
 (b) A, B and C indicate firestop configuration, as described in the following:

Firestop Configuration A

- A. **Fill, Void or Cavity Materials* – Intumescent Sheet** – Rigid aluminum foil-faced sheet with galv steel sheet backer. Width of sheet to be min 6 in. (152 mm) greater than outside diam of nonmetallic pipe. Length of sheet (transverse to steel floor unit direction) to extend to steel floor unit valley beyond each side of core-drilled hole with a min lap of 1-1/2 in. (38 mm) on the steel floor unit valley at each end. Circular cutout in sheet to tightly follow circumference of nonmetallic pipe with side edges of sheet at least 3 in. (76 mm) from circular cutout on all sides. Slit made in sheet to permit installation around the nonmetallic pipe to be located at end of sheet beneath steel floor unit valley nearest to the circular cutout. Sheet to be installed with the galv steel sheet backer exposed (aluminum foil face against steel floor unit). Sheet secured to valleys of steel floor unit using min 3/16 in. diam by 1-1/2 in. (5 mm by 38 mm) long steel expansion bolts, or equivalent, in conjunction with min 1-1/4 in. (32 mm) diam steel fender washers. Fasteners to be located approx 1 in. (25 mm) from edges of sheet at each corner, at each sheet/valley intersection and at both sides of slit made to permit installation around nonmetallic pipe. Spacing of fasteners at ends of sheet not to exceed 6 in. (152 mm) OC.

3M COMPANY – CS-195+

- B. **Packing Material** – Mineral wool batt insulation having a min density of 6 pcf (96 kg/m³), firmly packed into flutes of steel floor units above intumescent sheet (Item 3A) to completely fill cavities.

- C. **Fill, Void or Cavity Materials* – Putty** – Moldable putty material supplied in nom 1/8 in. (3.2 mm) thick sheets. Min 1/8 in. (3.2 mm) thick sheet of putty material applied over packing material (Item B) at edges of intumescent sheet to completely cover packing material in steel floor unit flutes. Additional putty material kneaded by hand and packed into annular space between nonmetallic pipe and edge of core-drilled hole at top surface of concrete floor.

3M COMPANY – MP+ Stix

- D. **Fill, Void or Cavity Materials* – Wrap Strip** – Nom 1/4 in. (6 mm) thick intumescent elastomeric material faced on one side with aluminum foil, supplied in 2 in. (51 mm) wide by 24 in. (610 mm) long strips. Nom 2 in. (51 mm) wide strips tightly-wrapped around nonmetallic pipe (foil side exposed) with the top edges butted against the underside of the intumescent sheet. Sufficient layers of wrap strip shall be installed to lap a min of 3/16 in. (5 mm) on the intumescent sheet surface around the entire circumference of the nonmetallic pipe. For nom 1/2 in. to nom 2 in. (13 mm to nom 51 mm) diam pipes, a min of one layer of wrap strip is required. For nom 2-1/2 in. and nom 3 in. (64 mm to nom 76 mm) diam pipes, a min of two layers of wrap strip are required. For nom 3-1/2 in. and nom 4 in. (89 mm to nom 102 mm) diam pipes, a min of three layers of wrap strip are required. Each layer of wrap strip to be installed with butted seam, with butted seams in successive layers staggered. Wrap strip layers temporarily held in position using aluminum foil tape, filament tape, steel wire tie, or equivalent.

3M COMPANY – FS-195+

- E. **Steel Collar** – Nom 2 in. (51 mm) deep collar with 1-1/4 in. (32 mm) wide by 2 in. (51 mm) long anchor tabs and min 3/4 in. (19 mm) long tabs to retain wrap strip layers. Coils of precut 0.016 in. (0.41 mm) thick (30 gauge) galv sheet steel available from wrap strip manufacturer. As an alternate, collar may be field-fabricated from min 0.016 in. (0.41 mm) thick (30 gauge) galv sheet in accordance with instruction sheet supplied by wrap strip manufacturer. Steel collar, with anchor tabs bent outward 90 deg, wrapped tightly around wrap strip layers with min 1 in. (25 mm) overlap at seam. With steel collar anchor tabs pressed tightly against underside of intumescent sheet, compress collar around wrap strip layers using a min 1/2 in. (13 mm) wide by 0.028 in. (0.71 mm) thick stainless steel band clamp with worm drive tightening mechanism at the collar midheight. Beneath valleys of steel floor units, anchor tabs of collar secured to intumescent sheet with min 3/16 in. (5 mm) diam by 1-1/2 in. (38 mm) long steel anchor bolts, or equivalent, in conjunction with min 1-1/4 in. (32 mm) diam steel fender washers. Away from valleys, anchor tabs of collar secured to intumescent sheet with No. 10 steel sheet metal screws in conjunction with min 1-1/4 in. (32 mm) diam steel fender washers. Three anchor bolts, symmetrically located, required for nom 2 and 3 in. (51 mm and 76 mm) diam pipes. Four anchor bolts, symmetrically located, required for nom 4 in. (102 mm) diam pipes. As a final step, bend retainer tabs 90 deg toward pipe to lock wrap strip layers in position.

- F. **Fill, Void or Cavity Materials* – Caulk or Sealant (Not Shown)** – Generous bead of caulk to be applied to outer perimeter of wrap strip at its interface with intumescent sheet, to perimeter of pipe at its egress from the wrap strip layers and to perimeter of sheet at its interface with valleys of steel floor unit.

3M COMPANY – CP 25WB+ caulk or FB-3000 WT sealant. (Note: CP 25WB+ not suitable for use with CPVC pipes.)

Through Penetrations

Non-Metallic Pipes

2000 Series

Concrete

FA

System No. F-A-2002 *continued*

- G. **Firestop Device*** (Not Shown) – As an alternate to Items D, E and F for nom 1-1/2, 2, 3 or 4 in. (38, 51, 76 or 102 mm) diam nonmetallic pipes, a firestop device consisting of a sheet-steel split collar lined with intumescent material and provided with steel clips for attachment may be used. Firestop device to be installed on underside of intumescent sheet (Item A) in accordance with the accompanying installation instructions.

3M COMPANY – PPD 150, PPD 200, PPD 300, PPD 400

Firestop Configuration B

- A. **Fill, Void or Cavity Materials* – Intumescent Sheet** – Same as Firestop Configuration A.

3M COMPANY – CS-195+

- B. **Packing Material** – Same as Firestop Configuration A.

- C. **Fill, Void or Cavity Materials* – Putty** – Same as Firestop Configuration A.

3M COMPANY – MP+ Stix

- D. **Fill, Void or Cavity Materials* – Wrap Strip** – Same as Firestop Configuration A.

3M COMPANY – FS-195+

- E. **Steel Collar** – Same as Firestop Configuration A.

- F. **Fill, Void or Cavity Materials* – Caulk or Sealant** – Same as Firestop Configuration A.

3M COMPANY – CP 25WB+ caulk or FB-3000 WT sealant.

(Note: CP 25WB+ not suitable for use with CPVC pipes.)

- G. **Pipe Covering*** – Nom 1 in. (25 mm) thick hollow cylindrical heavy (min 3.5 pcf or 56 kg/m³) density glass fiber units jacketed on the outside with an all service jacket. Nom 6 in. (152 mm) length of pipe covering installed around nonmetallic pipe, with top edge abutting steel collar, and secured to pipe with No. 16 gauge steel tie wires located 1 in. (25 mm) from each edge.

See **Pipe and Equipment Covering – Materials*** (BRGU) category in Building Materials Directory for names of manufacturers. Any pipe covering material meeting the above specifications and bearing the UL Classification Marking with a Flame Spread Index of 25 or less and a Smoke Developed Index of 50 or less may be used.

- H. **Firestop Device*** (Not Shown) – As an alternate to Items D, E and F for nom 1-1/2, 2, 3 or 4 in. (38, 51, 76 or 102 mm) diam nonmetallic pipes, a firestop device consisting of a sheet-steel split collar lined with intumescent material and provided with steel clips for attachment may be used. Firestop device to be installed on underside of intumescent sheet (Item A) in accordance with the accompanying installation instructions.

3M COMPANY – PPD 150, PPD 200, PPD 300, PPD 400

Firestop Configuration C

- A. **Fill, Void or Cavity Materials* – Intumescent Sheet** – Same as Firestop Configuration A.

3M COMPANY – CS-195+

- B. **Packing Material** – Same as Firestop Configuration A.

- C. **Fill, Void or Cavity Materials* – Putty** – Same as Firestop Configuration A.

3M COMPANY – MP+ Stix

- D. **Fill, Void or Cavity Materials* – Wrap Strip** – Nom 1/4 in. (6 mm) thick intumescent elastomeric material faced on one side with aluminum foil, supplied in 4 in. (102 mm) wide by 24 in. (610 mm) long strips. Nom 4 in. (102 mm) wide strips tightly-wrapped around nonmetallic pipe with the top edges butted against the intumescent sheet. For nom 6 in. (152 mm) diam pipes, three layers of wrap strip are required. For nom 8 in. (203 mm) diam pipes, four layers of wrap strip are required. Each layer of wrap strip to be installed with butted seam with butted seams in successive layers staggered. Wrap strips temporarily held in position using aluminum foil tape, filament tape, steel wire tie, or equivalent.

3M COMPANY – FS-195+

- E. **Steel Collar** – Nom 4 in. (114 mm) deep collar with 1-1/4 in. (32 mm) wide by 2 in. (51 mm) long anchor tabs to retain wrap strip layers. Coils of precut 0.016 in. (0.41 mm) thick (No. 30 gauge) galv sheet steel available from wrap strip manufacturer. As an alternate, collar may be field-fabricated from min 0.016 in. (0.41 mm) thick (No. 30 gauge) galv sheet steel in accordance with instruction sheet supplied by wrap strip manufacturer. Steel collar, with anchor tabs bent outward 90 deg, wrapped tightly around wrap strip layers using two min 1/2 in. (13 mm) wide by 0.028 in. (0.71 mm) thick stainless steel band clamps with worm gear tightening mechanisms, with the clamps located near the quarter points of the wrap strips. Beneath valleys of steel floor units, anchor tabs of collar secured to intumescent sheet with min 3/16 in. (5 mm) diam by 1-1/2 in. (38 mm) long steel anchor bolts, or equivalent, in conjunction with min 1-1/4 in. (32 mm) diam steel fender washers. Away from valleys, anchor tabs of collar secured to intumescent sheet with No. 10 steel sheet metal screws in conjunction with min 1-1/4 in. (32 mm) diam steel fender washers. Seven anchor bolts, symmetrically located, required for nom 6 in. (152 mm) diam pipes. Nine anchor bolts, symmetrically located, required for nom 8 in. (203 mm) diam pipes. As a final step, bend retainer tabs 90 deg toward pipe to lock wrap strip layers in position.

- F. **Fill, Void or Cavity Materials* – Caulk or Sealant** – Same as Firestop Configuration A.

3M COMPANY – CP 25WB+ caulk or FB-3000 WT sealant. (Note: CP 25WB+ not suitable for use with CPVC pipes.)

- G. **Pipe Covering*** – Same as Firestop Configuration B.

*Bearing the UL Classification Marking

Reprinted from the Online Certifications Directory with permission from Underwriters Laboratories Inc.

Copyright © 2010 Underwriters Laboratories Inc.®



Note: Systems with Nonmetallic Through Penetrant(s) have not been evaluated with a pressure differential of 50 Pa between the exposed and unexposed surfaces as required by the National Building Code of Canada.

System No. F-A-2021

December 10, 1996

F Ratings – 1, 1-1/2 and 2 Hr (See Item 1A)

T Ratings – 1, 1-1/2 and 2 Hr (See Item 1A)

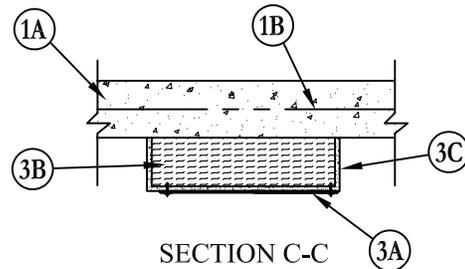
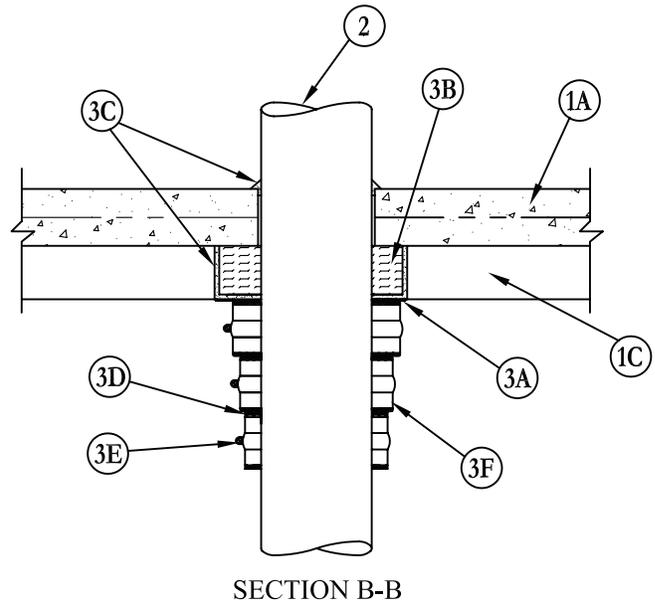
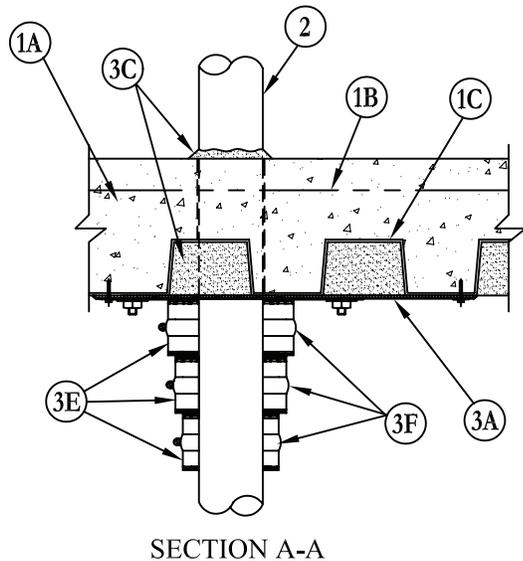
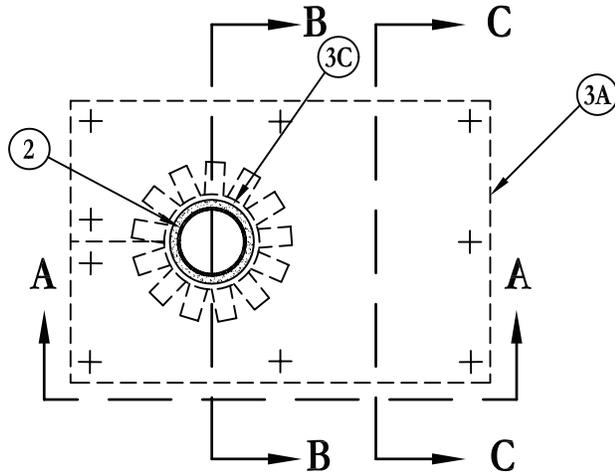

1. **Floor-Ceiling Assembly** – The fire-rated unprotected steel deck Floor-Ceiling assembly shall be constructed of the materials and in the manner specified in the individual D900 Series Designs in the UL Fire Resistance Directory and as summarized below:
 - A. **Normal Weight or Lightweight Concrete** – Normal weight concrete with carbonate or siliceous aggregate, 145 to 155 pcf unit weight, min 3000 psi compressive strength. Lightweight concrete with expanded shale, clay or slate aggregate, 105 to 115 pcf unit weight, min 3000 psi compressive strength. The hourly F and T Ratings for the firestop system are dependent upon the type and thickness of the concrete topping over the top plane of the fluted steel floor units (Item 1C), as shown in the following table:

| Concrete Type | Min Concrete Topping Thkns In. | F Rating Hr | T Rating Hr |
|---------------|--------------------------------|-------------|-------------|
| NW | 3-1/2 | 1 | 1 |
| NW | 4 | 1-1/2 | 1-1/2 |
| NW | 4-1/2 | 2 | 2 |
| LW | 3-1/4 | 2 | 2 |

- B. **Welded Wire Fabric** – 6x6-W1.4xW1.4
 - C. **Steel Floor and Form Units*** – Composite or noncomposite 1-1/2, 2 or 3 in. deep fluted galv units as specified in the individual Floor-Ceiling design.
2. **Nonmetallic Pipe** – Nom 6 in. diam Schedule 40 flame retardant polypropylene (FRPP) pipe for use in closed (process or supply) or vented (drain, waste or vent) piping systems. Pipe to be centered in nom 7 in. diam core-drilled through opening and rigidly supported on both sides of floor assembly.
3. **Firestop System** – The details of the firestop system shall be as follows:
 - A. **Fill, Void or Cavity Materials*** – **Intumescent Sheet** – Rigid aluminum foil-faced sheet with galv steel sheet backer. Width of sheet to be min 13 in. Length of sheet (transverse to steel floor unit direction) to extend to steel floor unit valley beyond each side of core-drilled

System No. F-A-2021 *continued*

hole with a min lap of 1-1/2 in. on the steel floor unit valley at each end. Circular cutout in sheet to tightly follow circumference of nonmetallic pipe with side edges of sheet at least 3 in. from circular cutout on all sides. Slit made in sheet to permit installation around the nonmetallic pipe to be located at end of sheet beneath steel floor unit valley nearest to the circular cutout. Sheet to be installed with the galv steel sheet backer exposed (aluminum foil face against steel floor unit). Sheet secured to valleys of steel floor unit using min 3/16 in. diam by 1-1/2 in. long steel expansion bolts, or equivalent, in conjunction with min 1-1/4 in. diam steel fender washers. Fasteners to be located approx 1 in. from edges of sheet at each corner, at each sheet/valley intersection and at both sides of slit made to permit installation around nonmetallic pipe. Spacing of fasteners at ends of sheet not exceed 6 in. OC.

3M COMPANY – CS-195+

- B. **Packing Material** – Mineral wool batt insulation having a min density of 6 pcf, firmly packed into flutes of steel floor units above intumescent sheet (Item 3A) to completely fill cavities.
- C. **Fill, Void or Cavity Materials* – Putty** – Moldable putty material supplied in nom 1/8 in. thick sheets. Min 1/8 in. thick sheet of putty material applied over packing material (Item 3B) at edges of intumescent sheet to completely cover packing material in steel floor unit flutes. Additional putty material kneaded by hand and packed into annular space between nonmetallic pipe and edge of core-drilled hole at top surface of concrete floor.

3M COMPANY – MPP, MP+ Stix

- D. **Fill, Void or Cavity Material* – Wrap Strip** – Nom 1/4 in. thick intumescent elastomeric material faced on one side with aluminum foil, supplied in 2 in. wide by 24 in. long strips. Three stacks of nom 2 in. wide wrap strips tightly-wrapped around nonmetallic pipe in a “telescope” fashion with four, three and two layers of wrap strip installed in the top, middle and bottom stacks, respectively. Each layer of wrap strip is to be installed with butted seams in successive layers staggered. Wrap strip stacks to be tightly-butted against each other and against intumescent sheet (Item 3A). Wrap strips temporarily held in position using aluminum foil tape, filament tape, steel wire tie, or equivalent. Wrap strips secured in position with steel collars (Item 3E).

3M COMPANY – FS-195+

- E. **Steel Collar** – Nom 2 in. deep collar with 1/4 in. wide by 2 in. long anchor tabs and 3/4 in. long tabs to retain wrap strip layers. Coils of precut min 0.016 in. thick (No. 30 gauge) galv sheet steel available from wrap strip manufacturer. After installing three two-layer stacks of wrap strip (Item 3D), a steel collar with two out of every three anchor tabs cut off is to be installed around the bottom stack of wrap strip with the remaining anchor tabs extending onto the middle stack of wrap strip. After securing the steel collar around the bottom stack of wrap strip with a stainless steel band clamp (Item 3C) and bending the retainer tabs 90 degrees, the third layer of wrap strip is to be installed around the middle and top stacks of wrap strip such that the remaining anchor tabs of the steel collar on the bottom stack of wrap strip are covered. A second steel collar with two out of three anchor tabs cut off is to be installed around the middle stack of wrap strip with the remaining anchor tabs extending onto the top stack of wrap strip. After securing the steel collar around the middle stack of wrap strip with a stainless steel band clamp and bending the retainer tabs 90 degrees, the fourth layer of wrap strip is to be installed around the top stack of wrap strip such that the remaining anchor tabs of the steel collar on the middle stack are covered. A third steel collar with the anchor tabs bent outward 90 degrees is to be installed around the top stack of wrap strip. After securing the steel collar around the top stack of wrap strip with a stainless steel band clamp and bending the retainer tabs 90 degrees, the top steel collar is to be secured to the intumescent sheet. Where the anchor tabs of the top steel collar are beneath the valley of the steel deck, the anchor tabs are to be secured with 1/4 in. diam by min 1-1/2. long steel expansion bolts, or equivalent, in conjunction with steel nuts and min 1-1/4 in. diam steel fender washers with one anchor bolt in each anchor tab. Where the anchor tabs of the top steel collar are beneath the crest of the steel deck, the anchor tabs are to be secured with No. 10 by min 1/2 in. long self-drilling, self-tapping steel screws. The three steel collars are to be mechanically interlocked using steel screws (Item 3G).
- F. **Band Clamp** – Min 1/2 in. wide by 0.028 in. thick stainless steel band clamp with worm gear tightening mechanism. One band clamp to be tightly-secured around each steel collar at the approximate midheight of each stack of wrap strips.
- G. **Steel Screws (Not Shown)** – No. 10 by 1/2 in. long self-drilling, self-tapping hex-head steel screws. Screws to be driven through steel collars on middle and top stacks of wrap strip layers to interlock with anchor tabs of steel collars on bottom and middle stacks of wrap strip layers, respectively.

*Bearing the UL Classification Marking

Reprinted from the Online Certifications Directory with permission from Underwriters Laboratories Inc.
Copyright © 2011 Underwriters Laboratories Inc.®

System No. F-A-2027

May 18, 2005
 F Rating – 2 Hr
 T Rating – 3/4 Hr

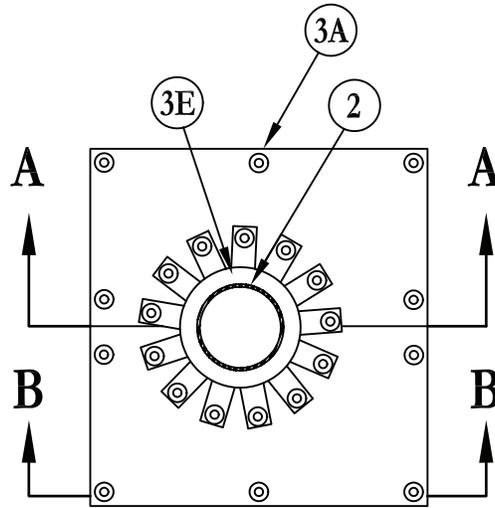

BOTTOM VIEW

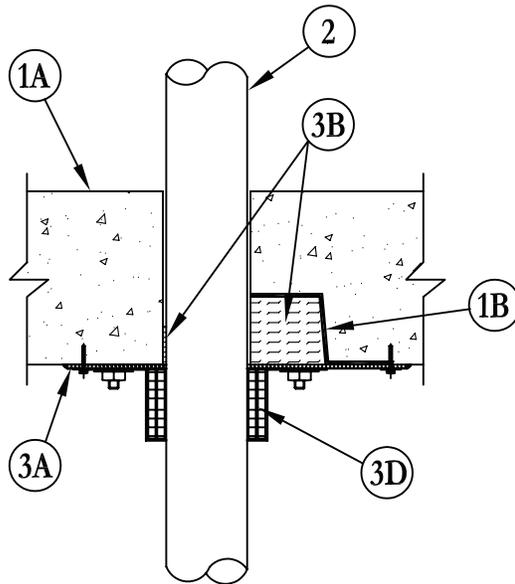

SECTION A-A

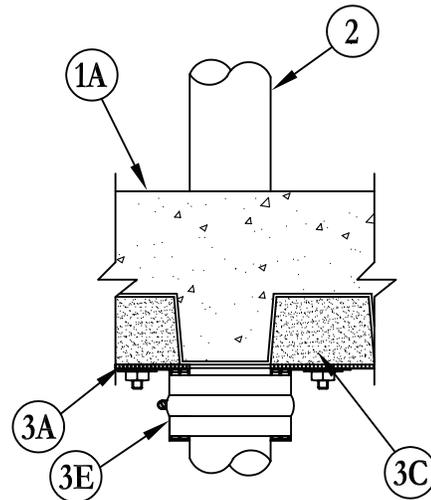

SECTION B-B

- Floor Assembly** – The fire-rated unprotected concrete and steel floor assembly shall be constructed of the materials and in the manner specified in the individual D900 Series designs in the UL Fire Resistance Directory and as summarized below:
 - Concrete** – Min 3 in. (76 mm) thick reinforced lightweight or normal weight (100-150 pcf or 1600-2400 kg/m³) concrete.
 - Welded Wire Fabric** – 6x6-W1.4xW1.4.
 - Steel Floor and Form Units*** – Composite or noncomposite 1-1/2 in. (38 mm) deep fluted galv units as specified in the individual Floor-Ceiling design. Diam of opening through floor to be 1/2 in. to 5/8 in. (13 mm to 16 mm) larger than the outside diam of through-penetrant (Item 2). Max diam of opening is 5 in. (127 mm).
- Through Penetrants** – One nonmetallic pipe or conduit to be centered within the opening. Pipe to be rigidly supported on both sides of floor assembly. The following types and sizes of nonmetallic pipes may be used:
 - Polyvinyl Chloride (PVC) Pipe** – Nom 4 in. (102 mm) diam (or smaller) Schedule 40 solid core PVC pipe for use in closed (process or supply) or vented (drain, waste or vent) piping system.
 - Rigid Nonmetallic Conduit+** – Nom 4 in. (102 mm) diam (or smaller) Schedule 40 PVC conduit installed in accordance with Article 347 of the National Electrical Code (NFPA No. 70).
 - Chlorinated Polyvinyl Chloride (CPVC) Pipe** – Nom 4 in. (102 mm) diam (or smaller) SDR13.5 CPVC pipe for use in closed (process or supply) piping systems.
- Firestop System** – The details of the firestop system shall be as follows:
 - Metal Plate Enclosure** – Min 16 galv steel. Width of plate to extend a min of 3 in. (76 mm) beyond both sides of opening. Length of plate (transverse to steel floor unit direction) to extend to steel floor unit valley beyond each side of core-drilled hole with a min lap

System No. F-A-2027 *continued*

of 1-1/2 in. (38 mm) on the floor unit valley at each end. Circular cutout in plate to be 1/2 in. (13 mm) larger than the outside diam of through-penetrant. Max diam of opening is 5 in. (127 mm). Plate to be cut in half along the length of plate to permit installation around the nonmetallic pipe. Plate secured to valleys of floor unit using min 1/4 in. (6 mm) diam by 1-3/4 in. (44 mm) long steel expansion bolts or equivalent. Fasteners to be located approx 1 in. (25 mm) from edges of plate at each corner, at each plate/valley intersection and at both sides of cut made to permit installation around nonmetallic pipe.

- B. **Packing Material** – Mineral wool batt insulation having min density of 4 pcf (64 kg/m³), firmly packed into flutes of steel floor units above metal plate enclosure to completely fill cavities. Packing material to be recessed within flutes from both edges of metal plate enclosure to accommodate the required thickness of fill material.
- C. **Fill, Void or Cavity Material* – Caulk or Sealant** – Min 1/2 in. (13 mm) thickness of fill material applied into flutes of steel floor units above metal plate enclosure to completely fill cavities. Caulk may also be used as an option within the annular space on the top side of the floor.

3M COMPANY – CP 25WB+, IC 15WB+ caulk or FB-3000 WT sealant.
(Note: CP 25WB+ not suitable for use with CPVC pipes.)

- D. **Fill, Void or Cavity Materials* – Wrap Strip** – Nom 1/4 in. (6 mm) thick intumescent elastomeric material faced on one side with aluminum foil, supplied in 2 in. (51 mm) wide strips. Wrap strip(s) tightly wrapped around nonmetallic pipe or conduit (foil side exposed) with the top edges butted against metal plate enclosure. For nom 1/2 in. (13 mm) to nom 2 in. (51 mm) diam pipes or conduits, a min of one layer of wrap strip is required. For nom 2-1/2 in. and 3 in. (64 mm and 76 mm) diam pipes or conduits, a min of two layers of wrap strip is required. For nom 3-1/2 in. and 4 in. (89 mm and 102 mm) diam pipes or conduits, a min of three layers of wrap strip is required. Each layer of wrap strip to be installed with butted seam, with butted seams in successive layers staggered. Wrap strip layers temporarily held in position using aluminum foil tape, steel wire tie or equivalent.

3M COMPANY – FS-195+

- E. **Steel Collar** – Nom 2 in. (51 mm) deep collar with 1-1/4 in. (32 mm) wide by 2 in. (51 mm) long anchor tabs and min 1/2 in. (13 mm) long tabs to retain wrap strip. Coils of precut min 0.016 in. (0.41 mm) thick (28 gauge) galv sheet steel available from wrap strip manufacturer. As an alternate, collar may be field-fabricated from min 0.016 in. (0.41 mm) thick (28 gauge) galv sheet steel in accordance with instruction sheet supplied by wrap strip manufacturer. Collar, with anchor tabs bent outward 90 degrees, wrapped tightly around wrap strip with min 1 in. (25 mm) overlap at seam and compressed around wrap strip(s) using a min 1/2 in. (13 mm) wide by min 0.028 in. (0.71 mm) thick stainless steel band at the collar midheight. Collar anchor tabs pressed tightly against metal plate enclosure. Where the anchor tabs are beneath the valley of the steel floor unit, the anchor tabs are to be secured with 1/4 in. (6 mm) diam by min 1-1/2 in. (38 mm) long steel expansion bolts or equivalent, in conjunction with min 1-1/4 in. (32 mm) diam steel fender washers with one anchor bolt in each anchor tab. Where the anchor tabs are beneath the crest of the steel deck, the anchor tabs are to be secured to the metal enclosure with No. 10 by min 1/2 in. (13 mm) long self-drilling, self-tapping steel screws and min 1-1/4 in. (32 mm) diam steel fender washers. Retainer tabs bent 90 degrees toward pipe to lock wrap strip(s) in position.

*Bearing the UL Classification Marking

Reprinted from the Online Certifications Directory with permission from Underwriters Laboratories Inc.
Copyright © 2010 Underwriters Laboratories Inc.®



Note: Systems with Nonmetallic Through Penetrant(s) have not been evaluated with a pressure differential of 50 Pa between the exposed and unexposed surfaces as required by the National Building Code of Canada.

System No. F-A-2033

May 18, 2005
 F Rating – 2 Hr
 T Rating – 1-1/2 Hr

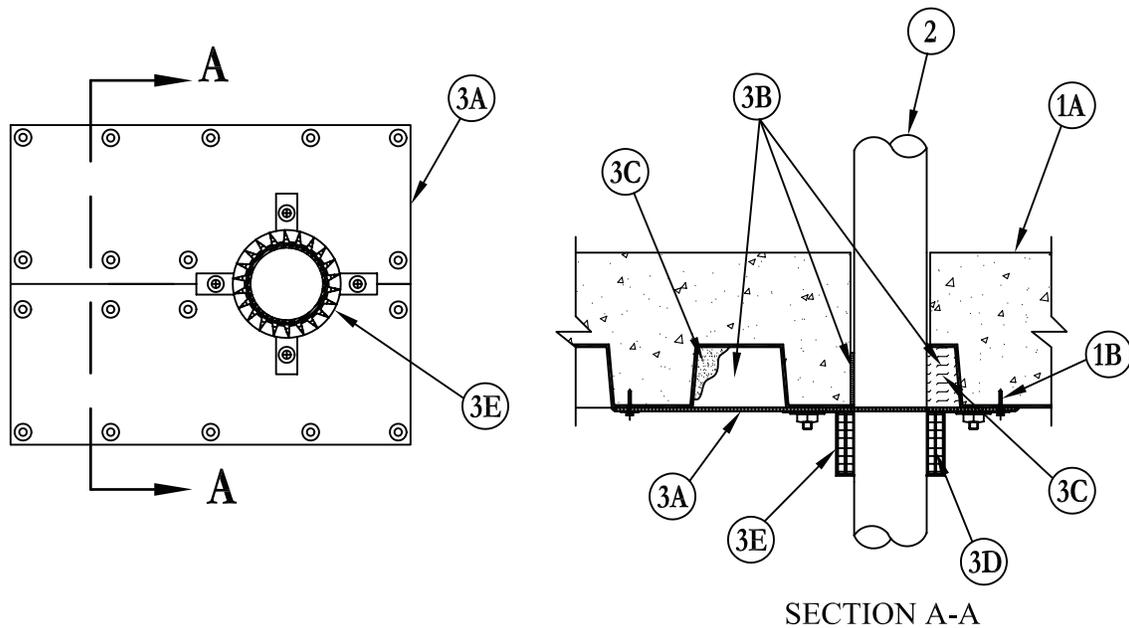

1. **Floor Assembly** – The fire-rated unprotected concrete and steel floor assembly shall be constructed of the materials and in the manner specified in the individual D900 Series designs in the UL Fire Resistance Directory and as summarized below:
 - A. **Concrete** – Min 3 in. (76 mm) thick reinforced lightweight or normal weight (100-150 pcf or 1600-2400 kg/m³) concrete.
 - B. **Welded Wire Fabric** – 6x6-W1.4xW1.4.
 - C. **Steel Floor and Form Units*** – Composite or noncomposite 1-1/2 in. (38 mm) deep fluted galv units as specified in the individual Floor-Ceiling design. Diam of opening through floor to be 1/2 in. to 5/8 in. (13 mm to 16 mm) larger than the outside diam of through-penetrant (Item 2). Max diam of opening is 5 in. (127 mm).
2. **Through Penetrants** – One nonmetallic pipe or conduit to be centered within the opening. Pipe to be rigidly supported on both sides of floor assembly. The following types and sizes of nonmetallic pipes may be used:
 - A. **Polyvinyl Chloride (PVC) Pipe** – Nom 4 in. (102 mm) diam (or smaller) Schedule 40 solid core or cellular core PVC pipe for use in closed (process or supply) or vented (drain, waste or vent) piping system.
 - B. **Rigid Nonmetallic Conduit++** – Nom 4 in. (102 mm) diam (or smaller) Schedule 40 PVC conduit installed in accordance with Article 347 of the National Electrical Code (NFPA No. 70).
 - C. **Chlorinated Polyvinyl Chloride (CPVC) Pipe** – Nom 4 in. (102 mm) diam (or smaller) SDR13.5 CPVC pipe for use in closed (process or supply) piping systems.
 - D. **Acrylonitrile Butadiene Styrene (ABS) Pipe** – Nom 4 in. (102 mm) diam (or smaller) Schedule 40 solid core or cellular core ABS pipe for use in closed (process or supply) or vented (drain, waste or vent) piping systems.
 - E. **Fire Retardant Polypropylene (FRPP) Pipe** – Nom 4 in. (102 mm) diam (or smaller) Schedule 40 FRPP pipe for use in closed (process or supply) or vented (drain, waste or vent) piping system.
3. **Firestop System** – The details of the firestop system shall be as follows:
 - A. **Metal Plate Enclosure** – Min 16 ga. galv steel. Width of plate to extend a min of 3 in. (76 mm) beyond both sides of opening. Length of plate (transverse to steel floor unit direction) to extend to steel floor unit valley beyond each side of core-drilled hole with a min lap of 1-1/2 in. (38 mm) on the floor unit valley at each end. Circular cutout in plate to be 1/2 in. (13 mm) larger than the outside diam of through-penetrant. Max diam of opening is 5 in. (127 mm). Plate to be cut in half along the length of plate to permit installation around the nonmetallic pipe. Plate secured to valleys of floor unit using min 1/4 in. (6 mm) diam by 1-3/4 in. (44 mm) long steel expansion bolts, or equivalent. Fasteners to be located approx 1 in. (25 mm) from edges of plate at each corner, at each plate/valley intersection and at both sides of cut made to permit installation around nonmetallic pipe. When plate seam is located beneath the crest of the steel deck, a 2 in. (51 mm) wide 16 ga. galv steel plate to be centered over seam and attached to plate with min No. 10 sheet metal screws, max 3 in. (76 mm) O.C. on both sides of seam.
 - B. **Fill, Void or Cavity Material* – Caulk or Sealant** – Min 1/2 in. (13 mm) thickness of caulk applied within annular space, flush with the bottom of the upper portion of the flute. Min 1/2 in. (13 mm) thickness of caulk applied into flutes of steel floor units above metal plate enclosure to completely cover packing material (Item 3C).
3M COMPANY – CP 25WB+, IC 15WB+ caulk or FB-3000 WT sealant.
 - B.1. **Fill, Void or Cavity Materials* – Caulk or Sealant** (Optional, Not Shown) – Min 1/4 in. (6 mm) thickness of caulk or sealant applied within annular space, flush with top of floor.
3M COMPANY – CP 25WB+, IC 15WB+ caulk, FB-1000 NS, FB-1003 SL or FB-3000 WT sealant.
 (Note: CP 25WB+ not suitable for use with CPVC pipes.)

System No. F-A-2033 *continued*

- C. **Packing Material** – Min 4 pcf (64 kg/m³) mineral wool batt insulation firmly packed into flutes of steel floor units above metal plate enclosure to completely fill cavities. Packing material to be recessed within flutes from both edges of metal plate enclosure to accommodate the required thickness of fill material. Min 1-1/2 in. (38 mm) thickness of min 4 pcf (64 kg/m³) mineral wool batt insulation firmly packed into annular space, flush with bottom of floor.
- D. **Fill, Void or Cavity Materials* – Wrap Strip** – Nom 1/8 in. (3.2 mm) thick intumescent material supplied in 2 in. (51 mm) wide strips. Wrap strip tightly wrapped around nonmetallic pipe with continuous layers and butted tightly against bottom of metal plate enclosure. The min number of layers required is dependent upon the nom diam of the pipe. For nom 2 in. (51 mm) diam (and smaller) pipes, one layer is required. For nom 2-1/2 in. and 3 in. (64 mm and 76 mm) diam pipes, two layers are required. For nom 3-1/2 in. and 4 in. (89 mm and 102 mm) diam pipes, three layers are required. Wrap strip layers temporarily held in position using aluminum foil tape, steel wire tie, or equivalent.

3M COMPANY – Ultra GS

- E. **Steel Collar** – Nom 2 in. (51 mm) deep collar with 1-1/4 in. (32 mm) wide by 2 in. (51 mm) long anchor tabs and min 1/2 in. (13 mm) long tabs to retain wrap strip. Coils of precut min 0.016 in. (0.41 mm) thick (28 gauge) galv sheet steel available from wrap strip manufacturer. As an alternate, collar may be field-fabricated from min 0.016 in. (0.41 mm) thick (28 gauge) galv sheet steel in accordance with instruction sheet supplied by wrap strip manufacturer. Collar, with anchor tabs bent outward 90 deg, wrapped tightly around wrap strip with min 1 in. (25 mm) overlap at seam and compressed around wrap strip(s) using a min 1/2 in. (13 mm) wide by min 0.028 in. (0.71 mm) thick stainless steel band at the collar midheight. Collar anchor tabs pressed tightly against metal plate enclosure. Where the anchor tabs are beneath the valley of the steel floor unit, the anchor tabs are to be secured with 1/4 in. (6 mm) diam by min 1-1/2 in. (38 mm) long steel expansion bolts, or equivalent, in conjunction with min 1-1/4 in. (32 mm) diam steel fender washers with one anchor bolt in each anchor tab. Where the anchor tabs are beneath the crest of the steel deck, the anchor tabs are to be secured to the metal enclosure with No. 10 by min 1/2 in. (13 mm) long self-drilling, self-tapping steel screws and min 1-1/4 in. (32 mm) diam steel fender washers. Retainer tabs bent 90 deg toward pipe to lock wrap strip(s) in position.
- F. **Firestop Device*** (Not Shown) – As an alternate to Items D and E, a Firestop device consisting of a sheet-steel split collar lined with intumescent material may be used. Firestop device to be installed on underside of floor or on both sides of wall in accordance with the accompanying installation instructions.

3M COMPANY – Ultra PPD 1.5, 2.0, 3.0, 4.0.

- G. **Firestop Device*** (Not Shown) – As an alternate to Items 3D and 3E, firestop device to be installed in accordance with the accompanying installation instructions. Firestop device to be installed and latched around pipe and secured to the underside of the floor. Collar anchor tabs pressed tightly against metal plate enclosure. Where the anchor tabs are beneath the valley of the steel floor unit, the anchor tabs are to be secured with 1/4 in. (6 mm) diam by min 1-1/4 in. (32 mm) long steel anchor bolts or equivalent in conjunction with 1-1/4 in. (32 mm) diam steel fender washers with one anchor bolt in each anchor tab. Where the anchor tabs are beneath the crest of the metal enclosure with No. 10 by min 1/2 in. (13 mm) long self-drilling, self-tapping steel screws and min 1-1/4 in. (32 mm) diam steel fender washers.

3M COMPANY – Ultra RC Pack 2.0, 3.0, 4.0

*Bearing the UL Classification Marking

++Bearing the UL Listing Mark

Reprinted from the Online Certifications Directory with permission from Underwriters Laboratories Inc.

Copyright © 2010 Underwriters Laboratories Inc.®



Note: Systems with Nonmetallic Through Penetrant(s) have not been evaluated with a pressure differential of 50 Pa between the exposed and unexposed surfaces as required by the National Building Code of Canada.

System No. F-A-2041

May 18, 2005
 F Rating – 2 Hr
 T Rating – 1 Hr

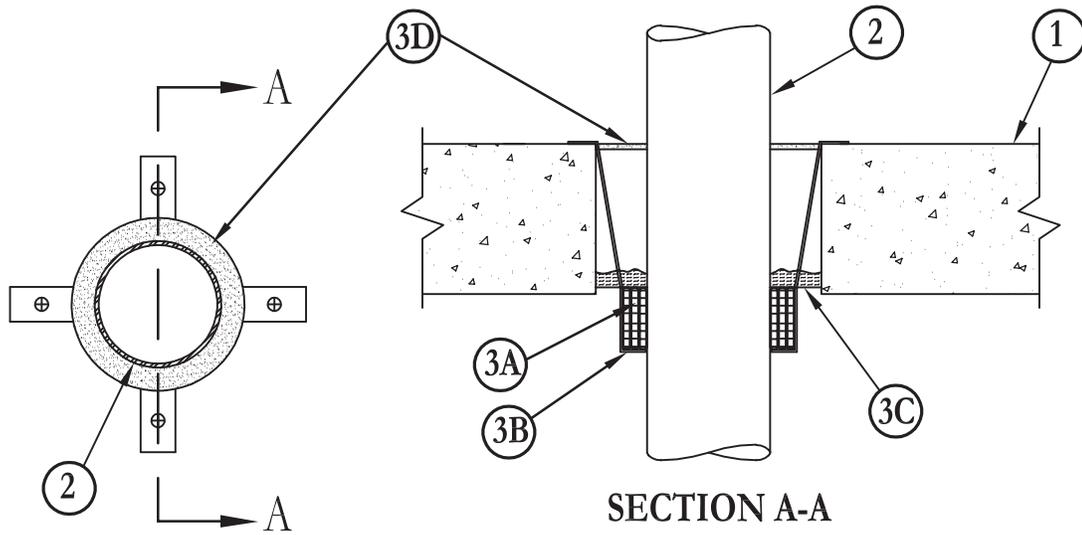

- Floor or Wall Assembly** – Min 2-1/2 in. (64 mm) thick reinforced lightweight or normal weight (100-150 pcf or 1600-2400 kg/m³) concrete. Wall may also be constructed of any UL Classified **Concrete Blocks***. For nom 2 in. (51 mm) diam and smaller pipes and conduits, diam of opening shall be 1 in. (25 mm) larger than nom pipe diam. For pipes and conduits greater than nom 2 in. (51 mm) diam of opening shall be 2 in. (51 mm) larger than nom pipe diam.

See **Concrete Blocks (CAZT)** category in the Fire Resistance Directory for names of manufacturers.

- Through Penetrants** – One nonmetallic pipe or conduit to be centered within opening. The annular space between pipe or conduit and periphery of opening shall be 1/2 in. (13 mm) for nom 2 in. (51 mm) diam pipes and smaller, and shall be 3/4 in. (19 mm) for pipes greater than nom 2 in. (51 mm) Pipe or conduit to be rigidly supported on both sides of the floor or wall assembly. The following types and sizes of nonmetallic pipes or conduits may be used:
 - Polyvinyl Chloride (PVC) Pipe** – Nom 4 in. (102 mm) diam (or smaller) Schedule 40 solid core or cellular core PVC pipe for use in closed (process or supply) or vented (drain, waste or vent) piping systems.
 - Rigid Nonmetallic Conduit**++ – Nom 4 in. (102 mm) diam (or smaller) Schedule 40 PVC conduit installed in accordance with Article 347 of the National Electrical Code (NFPA No. 70).
 - Chlorinated Polyvinyl Chloride (CPVC) Pipe** – Nom 4 in. (102 mm) diam (or smaller) SDR 13.5 CPVC pipe for use in closed (process or supply) piping systems.
 - Acrylonitrile Butadiene Styrene (ABS) Pipe** – Nom 4 in. (102 mm) diam (or smaller) Schedule 40 solid core or cellular core ABS pipe for use in closed (process or supply) or vented (drain, waste or vent) piping systems.
 - Fire Retardant Polypropylene (FRPP) Pipe** – Nom 4 in. (102 mm) diam (or smaller) Schedule 40 FRPP pipe for use in closed (process or supply) or vented (drain, waste or vent) piping systems.

- Firestop System** – The details of the firestop system shall be as follows:

- Fill, Void or Cavity Materials* – Wrap Strip** – Nom 1/8 in. (3.2 mm) thick flexible intumescent material supplied in 2 in. (51 mm) wide rolls. Nom 2 in. (51 mm) wide strips tightly wrapped around nonmetallic pipe prior to recessing into opening. For nom 1/2 in. (13 mm) to nom 1-1/2 in. (38 mm) diam pipes a minimum of one layer of wrap is required. For nom 2 in. (51 mm) diam pipes a minimum of 2 layers of wrap are required. For nom 2-1/2 in. and 3 in. (64 mm and 76 mm) diam pipes a minimum of 3 layers of wrap are required. For nom 3-1/2 in. and 4 in. (89 mm and 102 mm) diam pipes a minimum of 4 layers of wrap are required. Wrap to be continuously wrapped around pipe in one piece and temporarily held in place with tape.

3M COMPANY – Ultra GS

- Steel Collar** – Nom 2 in. (51 mm) deep collar with 1-1/4 in. (32 mm) wide by 2 in. (51 mm) long anchor tabs and min 1/2 in. (13 mm) long tabs to retain wrap layers. Coils of precut 0.016 in. (0.41 mm) thick (28 gauge) galv sheet steel available from wrap manufacturer. Collar may also be field-fabricated. Steel collar wrapped tightly around applied wrap with min 1 in. (25 mm) overlap at seam. Collar for nom 3 in. to 4 in. (76 mm to 102 mm) penetrants shall be secured around applied wrap with three No. 6 by 1/4 in. (6 mm) long steel sheet metal screws installed in the vertical axis at the center of the 1 in. (25 mm) overlap along the perimeter joint of the collar. Collars for nom 2-1/2 in. (64 mm) diam (and smaller) penetrants shall be secured with at least two 18 ga. (or heavier) wire ties. Collar retainer tabs shall be bent 90 degrees toward pipe to hold applied wrap. Prior to recessing collar assembly into opening, hanger straps to be fabricated out of minimum 0.016 in. (0.41 mm) thick (28 gauge) sheet steel. Hanger straps to be tapered from 1/4 in. (6 mm) wide to 1-1/4 in. (32 mm) wide and be of sufficient length so when attached to anchor tabs they lap onto floor a minimum of 1 in. (25 mm). For nom max 2 in. (51 mm) (and smaller) penetrants, two hangers are required. For nom 2-1/2 in. and 3 in. (64 mm and 76 mm) penetrants, three hangers are required. For nom 3-1/2 in. and 4 in. (89 mm and 102 mm) penetrants, four hangers are required. Hangers to be secured to collar assembly by inserting 1/4 in. (6 mm) end into slot opening in collar anchor tab and bending 180 degrees. Hangers may also be constructed from RC-1 Restricting Collar by cutting the width of the collar from the anchor tab (large tab) through the collar body to the

System No. F-A-2041 *continued*

retaining tab (smaller tapered tab). For thicker concrete, additional hangers may be hooked together as described. Assembly to be slid through the opening so that approximately 1-3/4 in. (44 mm) of collar assembly projects below the bottom surface of the floor. Hangers to be bent 90 degrees onto floor surface. A minimum 1 in. (25 mm) overlap onto floor surface is required. Collars may or may not be secured to top of floor with masonry anchors.

- C. **Packing Material** – Min 1/2 in. (13 mm) thickness of 4 pcf (64 kg/m³) mineral wool batt insulation firmly packed into the annular space on top of collar between the pipe and side of opening.
- D. **Fill, Void or Cavity Material – Caulk or Sealant** – Minimum 1/4 in. (6 mm) thickness of fill material applied within the annular space, flush with top surface of floor.

3M COMPANY – CP 25WB+, IC 15WB+ caulk, FB-1000 NS, FB-1003 SL or FB-3000 WT sealant.
(Note: CP 25WB+ not suitable for use with CPVC pipes.)

*Bearing the UL Classification Marking

++Bearing the UL Listing Mark

Reprinted from the Online Certifications Directory with permission from Underwriters Laboratories Inc.
Copyright © 2010 Underwriters Laboratories Inc.®



Note: Systems with Nonmetallic Through Penetrant(s) have not been evaluated with a pressure differential of 50 Pa between the exposed and unexposed surfaces as required by the National Building Code of Canada.

Through Penetrations

Non-Metallic Pipes

2000 Series

Concrete

FA

System No. F-A-2045

January 26, 2010

F Rating – 2 Hr

T Rating – 3/4 Hr

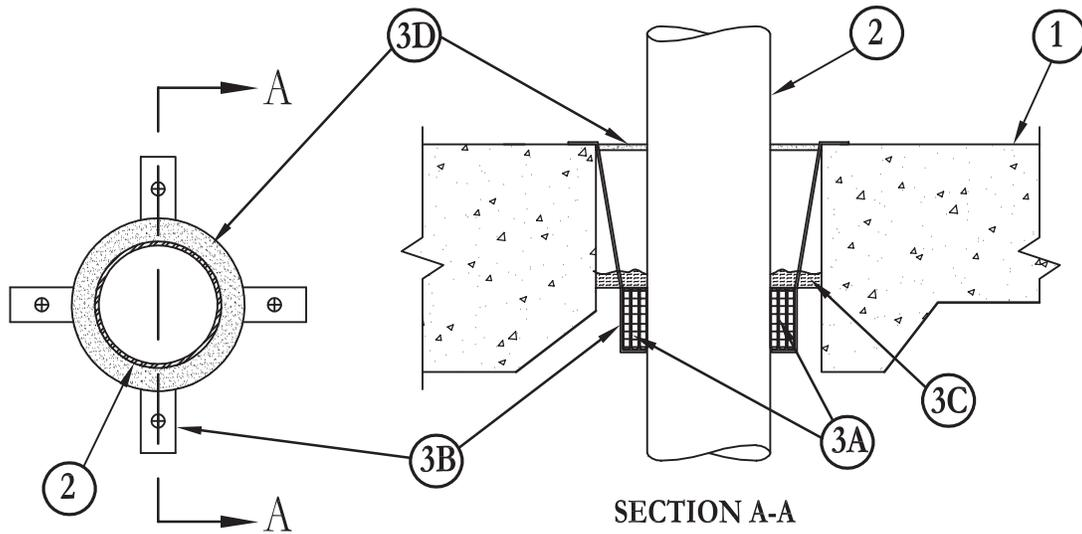

1. **Floor Assembly** – The fire-rated unprotected concrete and steel floor assembly shall be constructed of the materials and in the manner specified in the individual D900 Series designs in the Underwriters Laboratories Inc. Fire Resistance Directory and as summarized below:
 - A. **Concrete** – Min 2-1/2 in. (64 mm) thick reinforced lightweight or normal weight (100-150 pcf or 1600 - 2400 kg/m³) concrete.
 - B. **Welded Wire Fabric** – 6x6 W1.4xW1.4.
 - C. **Steel Floor and Form Units*** – Composite or noncomposite 1-1/2 in. (38 mm) deep fluted galv units as specified in the individual Floor-Ceiling design. Max diam of opening is 6 in. (152 mm).
 - D. **Steel sleeve** – (Optional- Not Shown) Max 6 in. (152 mm) ID (or smaller) 28 Ga (or heavier) fabricated steel sheet sleeve cast, grouted or inserted into floor assembly, may be installed with a max of 1 in. (25 mm) extension above floor and max extension of 2 in. (51 mm) below floor.
2. **Through Penetrants** – One nonmetallic pipe or conduit to be centered within opening. The annular space between pipe or conduit and periphery of opening shall be 1/2 in. (13 mm) for nom 2 in. (51 mm) diam pipes and smaller, and shall be 3/4 in. (19 mm) for pipes greater than nom 2 in. (51 mm). Pipe or conduit to be rigidly supported on both sides of the floor or wall assembly. The following types and sizes of nonmetallic pipes or conduits may be used:
 - A. **Polyvinyl Chloride (PVC) Pipe** – Nom 4 in. (102 mm) diam (or smaller) Schedule 40 solid core or cellular core PVC pipe for use in closed (process or supply) or vented (drain, waste or vent) piping systems.
 - B. **Rigid Nonmetallic Conduit++** – Nom 4 in. (102 mm) diam (or smaller) Schedule 40 PVC conduit installed in accordance with Article 347 of the National Electrical Code (NFPA No. 70).
 - C. **Chlorinated Polyvinyl Chloride (CPVC) Pipe** – Nom 4 in. (102 mm) diam (or smaller) SDR13.5 CPVC pipe for use in closed (process or supply) piping systems.
 - D. **Acrylonitrile Butadiene Styrene (ABS) Pipe** – Nom 4 in. (102 mm) diam (or smaller) Schedule 40 solid core or cellular core ABS pipe for use in closed (process or supply) or vented (drain, waste or vent) piping systems.
 - E. **Fire Retardant Polypropylene (FRPP) Pipe** – Nom 4 in. (102 mm) diam (or smaller) Schedule 40 FRPP pipe for use in closed (process or supply) or vented (drain, waste or vent) piping systems.
3. **Firestop System** – The details of the firestop system shall be as follows:
 - A. **Fill, Void or Cavity Materials* – Wrap Strip** – Nom 1/8 in. (3.2 mm) thick flexible intumescent material supplied in 2 in. (51 mm) wide rolls. Nom 2 in. (51 mm) wide strips tightly wrapped around nonmetallic pipe prior to recessing into opening. For nom 1/2 in. (13 mm) to nom 1-1/2 in. (38 mm) diam pipes a min of one layer of wrap is required. For nom 2 in. (51 mm) diam pipes a min of 2 layers of wrap are required. For nom 2-1/2 and 3 in. (64 and 76 mm) diam pipes a min of 3 layers of wrap are required. For nom 3-1/2 and 4 in. (89 and 102 mm) diam pipes a min of 4 layers of wrap are required. Wrap to be continuously wrapped around pipe in one piece and temporarily held in place with tape.
3M COMPANY – Ultra GS
 - B. **Steel Collar** – Nom 2 in. (51 mm) deep collar with 1-1/4 in. (32 mm) wide by 2 in. (51 mm) long anchor tabs and min 1/2 in. (13 mm) long tabs to retain wrap layers. Coils of precut 0.016 in. thick (0.41 mm) (28 gauge) galv sheet steel available from wrap manufacturer. Collar may also be field-fabricated. Steel collar wrapped tightly around applied wrap with min 1 in. (25 mm) overlap at seam. Collar for nom 3 to 4 in. (76 to 102 mm) penetrants shall be secured around applied wrap with three No. 6 by 1/4 in. (6 mm) long steel sheet metal screws installed in the vertical axis at the center of the 1 in. (25 mm) overlap along the perimeter joint of the collar. Collars for nom 2-1/2 in. (64 mm) diam (and smaller) penetrants shall be secured with at least two 18 ga. (or heavier) wire ties. Collar retainer tabs shall be bent 90° toward pipe to hold applied wrap. Prior to recessing collar assembly into opening, hanger straps to be fabricated out of min 0.016 in. (0.41 mm) thick (28 gauge) sheet steel. Hanger straps to be tapered from 1/4 in. (6 mm) wide to 1-1/4 in. (32 mm) wide and be

System No. F-A-2045 *continued*

of sufficient length so when attached to anchor tabs they lap onto floor a min of 1 in. (25 mm). For nom max 2 in. (51 mm) (and smaller) penetrants, two hangers are required. For nom 2-1/2 and 3 in. (64 and 76 mm) penetrants, three hangers are required. For nom 3-1/2 and 4 in. (89 and 102 mm) penetrants, four hangers are required. Hangers to be secured to collar assembly by inserting 1/4 in. (6 mm) end into slot opening in collar anchor tab and bending 180°. Hangers may also be constructed from RC-1 Restricting Collar by cutting the width of the collar from the anchor tab (larger tab) through the collar body to the retaining tab (smaller tapered tab). For thicker concrete, additional hangers may be hooked together as described. Assembly to be slid into the opening and recessed approximately 1-3/4 in. (44 mm) below the top surface of the floor. Hangers to be bent 90° onto floor surface. A min 1 in. (25 mm) overlap onto floor surface is required. Collars may or may not be secured to top of floor with masonry anchors. When steel sleeve (Item 1D) is used and extends above floor surface hangers are to be bent 180 degrees on to steel sleeve and overlap on to floor a min of 1 in. (25 mm).

- C. **Packing Material** – Min 1/2 in. (13 mm) thickness of 4 pcf (64 kg/m³) mineral wool batt insulation firmly packed into the annular space on top of collar between the pipe and side of opening.
- D. **Fill, Void or Cavity Material – Caulk or Sealant** – Min 1/4 in. (6 mm) thickness of fill material applied within the annular space, flush with top surface of floor.

3M COMPANY – CP 25WB+ caulk, FB-3000 WT sealant, FB-1000 NS sealant, FB-1003 SL sealant or IC 15WB+ caulk. (Note: CP 25WB+ not suitable for use with CPVC pipes.)

*Bearing the UL Classification Mark

++Bearing the UL Listing Mark

Reprinted from the Online Certifications Directory with permission from Underwriters Laboratories Inc.
Copyright © 2010 Underwriters Laboratories Inc.®



Note: Systems with Nonmetallic Through Penetrant(s) have not been evaluated with a pressure differential of 50 Pa between the exposed and unexposed surfaces as required by the National Building Code of Canada.

System No. F-A-2055

January 26, 2010

F Rating – 2 Hr

T Rating – 1 Hr

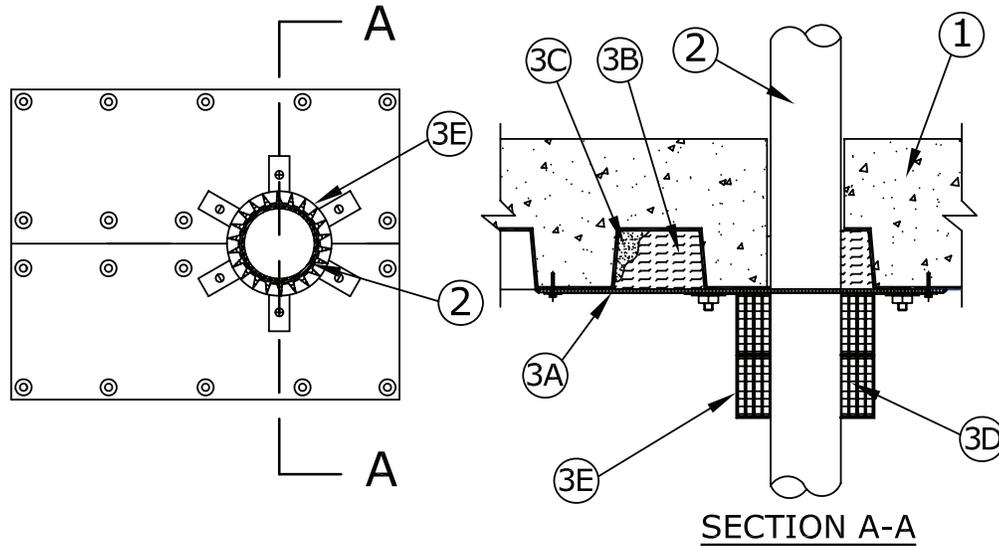

1. **Floor Assembly** – The fire rated unprotected concrete and steel floor assembly shall be constructed of the materials and in the manner specified in the individual D900 series design in the UL Fire Resistance Directory and as summarized below:
 - A. **Concrete** – Min 2-1/2 in. (64 mm) thick reinforced lightweight or normal weight (100-150 pcf pr 1600 - 2400 kg/m³) concrete.
 - B. **Welded Wire Fabric** – 6x6-W1.4xW1.4
 - C. **Steel Floor and Form Units*** – Composite or noncomposite 1-1/2 in. (38 mm) deep fluted galv units as specified in the individual Floor-Ceiling design. Diam of opening through floor to be 3/8 in. to 1/2 in. (10 to 13 mm) larger than outside diam of through penetrant. Max size of opening is 7-1/4 in. (184 mm).
 - D. **Steel sleeve** – (Optional-Not Shown) Max 7-1/4 in. (184 mm) ID (or smaller) 28 Ga (or heavier) fabricated steel sheet sleeve cast, grouted or inserted into floor assembly, may be installed with a max of 1 in. (25 mm) extension above floor and flush with top surface of metal plate (Item 3A).
2. **Through Penetrants** – One nonmetallic pipe or conduit to be centered within the opening. The pipe or conduit to be rigidly supported on both sides of floor assembly. The following types and sizes of nonmetallic pipe or conduit may be used:
 - A. **Polyvinyl Chloride (PVC) Pipe** – Nom 6 in. (152 mm) diam (or smaller) Schedule 40 solid core or cellulare core PVC pipe for use in closed (process or supply) or vented (drain, waste or vent) piping systems.
 - B. **Rigid Nonmetallic Conduit++** – Nom 6 in. (152 mm) diam (or smaller) Schedule 40 PVC conduit installed in accordance with Article 347 of the National Electrical Code (NFPA No. 70).
 - C. **Chlorinated Polyvinyl Chloride (CPVC) Pipe** – Nom 6 in. (152 mm) diam (or smaller) SDR13.5 CPVC pipe for use in closed (process or supply) piping systems.
 - D. **Acrylonitrile Butadiene Styrene (ABS) Pipe** – Nom 6 in. (152 mm) diam (or smaller) Schedule 40 solid core or cellular core ABS pipe for use in closed (process or supply) or vented (drain, waste or vent) piping systems.
 - E. **Fire Retardant Polypropylene (FRPP) Pipe** – Nom 6 in. (152 mm) diam (or smaller) Schedule 40 FRPP pipe for use in closed (process or supply) or vented (drain, waste or vent) piping systems.
3. **Firestop System** – The details of the firestop system shall be as follows:
 - A. **Metal Plate Enclosure** – Min 16 gauge galv steel plate. Width of plate to extend a min of 3 in. (76 mm) beyond both sides of the opening. Length of plate (transverse to steel floor unit direction) to extend to steel floor unit valley beyond each side of core-drilled hole with a min lap of 1-1/2 in. (38 mm) on the floor unit valley at each end. Circular cutout in plate to be 3/8 to 1/2 in. (10 to 13 mm) larger than the outside diam of through-penetrant. Max diam of opening is 7-1/4 in. (184 mm). Plate to be cut along the length of plate to permit installation around the nonmetallic pipe. Plate to be secured to valleys of floor unit using min 1/4 in. (6 mm) diam by 1-3/4 in. (44 mm) long steel expansion bolts. Fasteners to be located approx 1 in. (25 mm) from edges of plate at each corner, at each plate/valley intersection and at both sides of cut made to permit installation around nonmetallic pipe. When plate seam is located beneath the crest of the steel deck, a 2 in. (51 mm) wide 16 gauge galv steel plate to be centered over seam and attached to plate with min No. 10 sheet metal screws, max 3 in. (76 mm) OC on both sides of seam.
 - B. **Packing Material** – Min 4 pcf (64 kg/m³) mineral wool batt insulation firmly packed into flutes of steel floor units above metal plate enclosure to completely fill cavities. Packing material to be recessed within flutes from both edges of metal plate enclosure to accommodate the required thickness of fill material. Min 1/2 in. (13 mm) thickness of min 4 pcf (64 kg/m³) mineral wool batt insulation firmly packed into annular space, flush with bottom of floor.
 - C. **Fill, Void or Cavity Material* – Caulk or Sealant** – Min 1/4 in. (6 mm) thickness of caulk applied into flutes of steel floor units above metal plate enclosure to completely cover packing material (Item 3C). Caulk may also be used as an option within the annular space on the top side of the floor.
3M COMPANY – CP 25WB+ caulk, FB-3000 WT sealant or IC 15WB + caulk. (Note: CP 25WB+ not suitable for use with CPVC pipes.)

System No. F-A-2055 continued

- D. **Fill, Void or Cavity Materials* – Wrap Strip** – Nom 1/8 in. (3.2 mm) thick flexible intumescent material supplied in 2 in. (51 mm) wide strips. Min four continuous layers of wrap strip tightly wrapped around nonmetallic pipe and butted tightly against bottom of metal plate enclosure. An additional stack of four continuous layers of wrap strip tightly wrapped around nonmetallic pipe and butted tightly against the first stack of wrap strips.

3M COMPANY – Ultra GS

- E. **Steel Collar** – Two nom 2 in. (51 mm) deep collars with 1-1/4 in. (32 mm) wide by 2 in. (51 mm) long anchor tabs and min 1/2 in. (13 mm) long tabs to retain wrap strip layers. Coils of precut 0.016 in. (0.41 mm) thick (0.41 mm) (28 gauge) galv sheet steel available from wrap strip manufacturer. Collars may also be field-fabricated from min 0.016 in. thick (0.41 mm) (28 gauge) galv sheet steel in accordance with instruction sheet supplied by wrap strip manufacturer. Steel collars wrapped tightly around wrap strip layers with min 1 in. (25 mm) overlap at seams, with anchor tabs bent outward 90 degrees for upper or inner collars for securing to metal plate. Anchor tabs for lower collars to overlap onto upper collars. Collars to be compressed around wrap strip layers using a min 1/2 in. (13 mm) wide by 0.028 in. (0.71 mm) thick stainless steel band clamp at each collar's midheight. Upper or inner collars to be secured to floor surface with 1/4 in. (6 mm) diam by min 1-1/2 in. (38 mm) long steel expansion bolts in conjunction with steel nuts and min 1-1/4 in. (32 mm) diam steel fender washers. At location that the anchor tabs are beneath the crest of the steel deck, the anchor tabs are to be secured to the metal enclosure with No. 10 by min 1/2 in. (13 mm) long self-drilling, self-tapping steel screws and min 1-1/4 in. (32 mm) diam steel fender washers. min of six anchor bolts, symmetrically located, are required.

*Bearing the UL Classification Mark

++Bearing the UL Listing Mark

Reprinted from the Online Certifications Directory with permission from Underwriters Laboratories Inc.
Copyright © 2011 Underwriters Laboratories Inc.®

Through Penetrations

Non-Metallic Pipes

2000 Series

Concrete

FA

System No. F-A-2097

January 09, 2007

F Rating – 2 Hr

T Ratings – 0, 1/4, 3/4, 1, 1-1/4, 1-1/2 and 1-3/4 Hr (See Item 3)

L Rating at Ambient – Less Than 1 CFM/sq ft (See Item 4)

L Rating at 400° F – Less Than 1 CFM/sq ft (See Item 4)

W Rating – Class 1 (See Item 4)

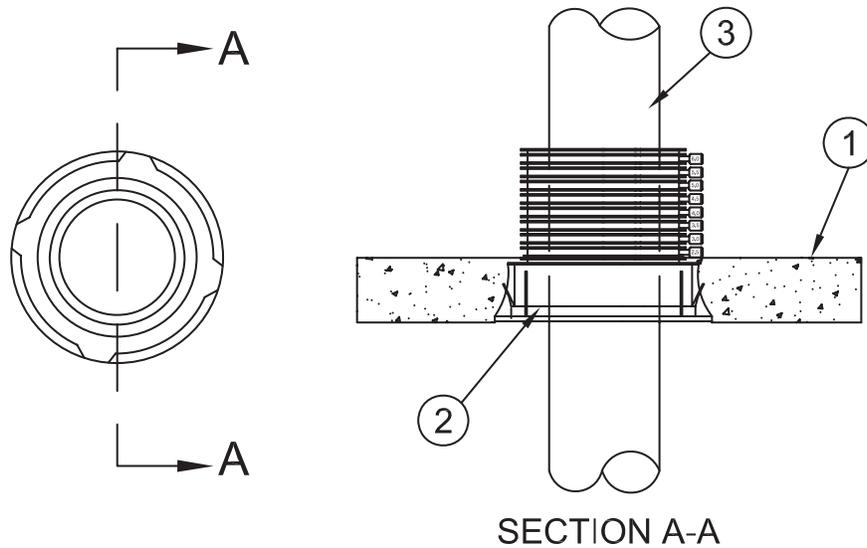

1. **Floor Assembly** – Min 2-1/2 in. (64 mm) thick reinforced lightweight or normal weight (100-150 pcf or 1600-2400 kg/m³) concrete.
2. **Firestop Device*** – Cast in place firestop device permanently embedded during concrete placement or grouted in concrete assembly in accordance with accompanying installation instructions. The device may be trimmed flush with top surface of floor or may project up to a max 5-1/2 in. (140 mm) above top surface of floor.
3M COMPANY – 3M Fire Barrier Cast-In Device 2PCID, 3PCID, 4PCID.
3. **Through Penetrants** – One nonmetallic pipe or conduit installed within the firestop system. Pipe or conduit to be rigidly supported on both sides of floor assembly. The nom pipe or conduit size shall match the nom size of the firestop device with the exception that both nom 1-1/2 in. (38 mm) and 2 in. (51 mm) diam pipes or conduits are suitable for use with the nom 2 in. (51 mm) diam device. The following types of nonmetallic pipes or conduits may be used:
 - A. **Polyvinyl Chloride (PVC) Pipe** – Schedule 40 solid core PVC or cellular core PVC (ccPVC) pipe for use in closed (process or supply) or vented (drain, waste or vent) piping systems.
 - B. **Rigid Nonmetallic Conduit (RNC)+** – Schedule 40 PVC conduit installed in accordance with the National Electrical Code (NFPA No. 70).
 - C. **Chlorinated Polyvinyl Chloride (CPVC) Pipe** – SDR13.5 CPVC pipe for use in closed (process or supply) piping systems.
 - D. **Acrylonitrile Butadiene Styrene (ABS) Pipe** – Schedule 40 solid core ABS or cellular core ABS (ccABS) pipe for use in closed (process or supply) or vented (drain, waste or vent) piping systems.
 - E. **Fire Retardant Polypropylene (FRPP) Pipe** – Schedule 40 FRPP pipe for use in closed (process or supply) or vented (drain, waste or vent) piping systems.

The hourly T rating is dependent on the size and type of penetrant as well as the direction in which the penetrant is installed through the firestop device as shown in the following table:

| Type Note: Penetrant | Size, in. (mm) | Installation Direction** | T Rating, Hr |
|-------------------------|-------------------|-----------------------------|--------------|
| PVC, RNC, CPVC, FRPP | 1-1/2 (38 mm) | B | 1-1/4 |
| PVC, RNC, CPVC, FRPP | 1-1/2 (38 mm) | T | 1 |
| ccPVC, ABS, ccABS | 1-1/2 (38 mm) | T & B | 3/4 |
| PVC, RNC, CPVC, FRPP | 2 (51 mm) | T & B | 1-3/4 |
| ccPvc, ABS, CCabs | 2 (51 mm) | T | 1 |
| ccPVC, ABS, ccABS | 2, 3 (51, 76 mm) | B | 1-1/4 |
| PVC, RNC, CPVC, FRPP | 3 (76 mm) | B | 1 |
| All | 3 (76 mm) | T | 1-1/2 |
| All | 4 (102 mm) | B | 0 |
| All | 4 (102 mm) | T | 1/4 |

** - B indicates installed from the bottom of floor, T indicates installed from the top of floor.

System No. F-A-2097 *continued*

4. **Fill, Void or Cavity Materials – Sealant** – (Optional, Not Shown) – For W Rating, a min 1/4 in. (6 mm) bead of sealant is required at the device/concrete interface on the top surface of the floor. When nom 1-1/2 in. (38 mm) diam pipe is installed in nom 2 in. (51 mm) diam device, a min 1/2 in. (13 mm) depth of sealant is required in the annular space between the pipe and the inside of the device to attain the W and L Ratings.

3M COMPANY – FB-1000 NS Sealant, FB-1003 SL Sealant or FB-3000 WT Sealant

*Bearing the UL Classification Mark

+ - Bearing the UL Listing Mark

Reprinted from the Online Certifications Directory with permission from Underwriters Laboratories Inc.
Copyright © 2011 Underwriters Laboratories Inc.®

Through Penetrations

Non-Metallic Pipes

2000 Series

Concrete

FA

System No. F-A-2098

January 09, 2007

F Rating – 3 Hr

T Rating – 0, 1/4, and 3 Hr (See Item 3)

L Rating at Ambient – Less Than 1 CFM/sq ft (See Item 4)

L Rating at 400° F – Less Than 1 CFM/sq ft (See Item 4)

W Rating – Class 1 (See Item 4)

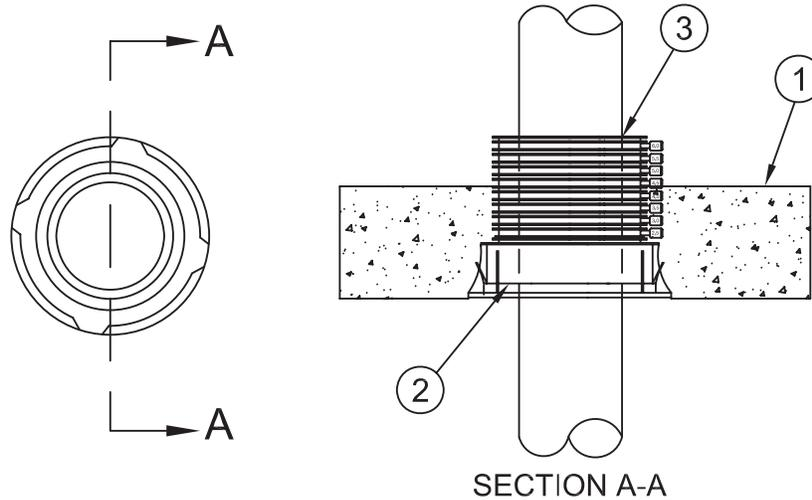

1. **Floor Assembly** – Min 4-1/2 in. (114 mm) thick reinforced lightweight or normal weight (100-150 pcf or 1600-2400 kg/m³) concrete.
2. **Firestop Device*** – Cast in place firestop device permanently embedded during concrete placement or grouted in concrete assembly in accordance with accompanying installation instructions. The device may be trimmed flush with top surface of floor or may project up to a max 3-1/2 in. (89 mm) above top surface of floor.
 - 3M COMPANY** – 3M Fire Barrier Cast-In Device 2PCID, 3PCID, 4PCID.
- 2A. **Firestop Device – Height Adapter*** – (Not Shown) – For use in floors greater than 8 in. (203 mm) thick. Adapter snaps onto top of firestop device (Item 2).
 - 3M COMPANY** – 3M Fire Barrier Cast-In Device Height Adapter, 2HA, 3HA, 4HA.
3. **Through Penetrants** – One nonmetallic pipe or conduit installed within the firestop system. Pipe or conduit to be rigidly supported on both sides of floor assembly. The nom pipe or conduit size shall match the nom size of the firestop device with the exception that both nom 1-1/2 in. (38 mm) and 2 in. (51 mm) pipes or conduits are suitable for use with the nom 2 in. (51 mm) diam device. The following types of nonmetallic pipes or conduits may be used:
 - A. **Polyvinyl Chloride (PVC) Pipe** – Schedule 40 solid core PVC or cellular core PVC (ccPVC) pipe for use in closed (process or supply) or vented (drain, waste or vent) piping systems.
 - B. **Rigid Nonmetallic Conduit (RNC)+** – Schedule 40 PVC conduit installed in accordance with the National Electrical Code (NFPA) No. 70).
 - C. **Chlorinated Polyvinyl Chloride (CPVC) Pipe** – SDR13.5 CPVC pipe for use in closed (process or supply) piping systems.
 - D. **Acrylonitrile Butadiene Styrene (ABS) Pipe** – Schedule 40 solid core ABS or cellular core ABS (ccABS) pipe for use in closed (process or supply) or vented (drain, waste or vent) piping systems.
 - E. **Fire Retardant Polypropylene (FRPP) Pipe** – Schedule 40 FRPP pipe for use in closed (process or supply) or vented (drain, waste or vent) piping systems.

The hourly T Rating is dependent on the size and type of penetrant as well as the direction in which the penetrant is installed through the firestop device as shown in the following table:

| Type | Size, in. (mm) | Installation Direction** | T Rating, Hr |
|----------------------|------------------|--------------------------|--------------|
| Note: Penetrant | | | |
| All | 1-1/2 (38 mm) | T & B | 3 |
| PVC, RNC, CPVC, FRPP | 2 (51 mm) | T & B | 3 |
| ccPVC, ABS, ccABS | 2, 3 (51, 76 mm) | T & B | 0 |
| All | 4 (102 mm) | T & B | 3 |

4. **Fill, Void or Cavity Materials – Sealant** – (Optional, Not Shown) – For W Rating, a min 1/4 in. (6 mm) bead of sealant is required at the device/concrete interface on the top surface of the floor. When nom 1-1/2 in. (38 mm) diam pipe is installed in nom 2 in. (51 mm) diam device, a min 1/4 in. (6 mm) depth of sealant atop a nom 2 in. (51 mm) depth of packing material is required in the annular space between the pipe and the inside of the device to attain the W and L Ratings.

3M COMPANY – FB-1000 NS Sealant, FB-1003 SL Sealant or FB-3000 WT Sealant

*Bearing the UL Classification Mark

+ -Bearing the UL Listing Marking.

Reprinted from the Online Certifications Directory with permission from Underwriters Laboratories Inc.

Copyright © 2011 Underwriters Laboratories Inc.®

System No. F-A-2109

January 09, 2007

F Rating – 2 Hr

T Rating – 1 Hr

L Rating at Ambient – Less Than 1 CFM/sq ft (See Item 5)

L Rating at 400° F – Less Than 1 CFM/sq ft (See Item 5)

W Rating – Class 1 (See Item 5)

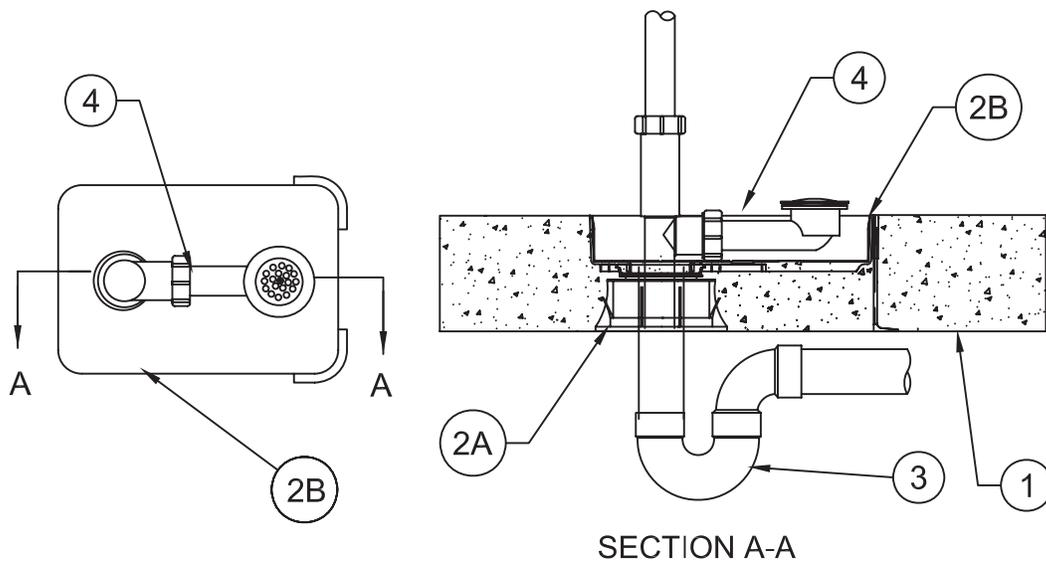

- Floor Assembly** – Min 4-1/2 in. (114 mm) thick reinforced lightweight or normal weight (100-150 pcf or 1600-2400 kg/m³) concrete.
- Firestop Devices*** – The firestop devices are cast in place and permanently embedded during concrete placement or grouted in concrete assembly in accordance with accompanying installation instructions.
 - Firestop Device*** – Cast in place firestop device installed flush with bottom surface of floor and trimmed to be 2 in. (51 mm) below top surface of floor.
3M COMPANY – 3M Fire Barrier Cast-In Device, 2MCID
 - Firestop Device – Tub Box*** – Nom 8 by 12 by 2 in. (203 by 305 by 51 mm) deep polyethylene tub box, with adjustable legs, snapped into top of Cast-In Device, 2MCID (Item 2A) and cast in concrete slab, flush with top surface of floor.
3M COMPANY – 3M Fire Barrier Cast-In Device Tub Box, 2TB
- Drain Piping** – Nom 1-1/2 in. or 2 in. (38 or 51 mm) diam nonmetallic pipe and drain fittings cemented together. Drain piping rigidly supported away from tub box with suitable hangers. The following types of nonmetallic pipes may be used:
 - Polyvinyl Chloride (PVC) Pipe** – Schedule 40 solid core PVC or cellular core PVC (ccPVC) pipe.
 - Acrylonitrile Butadiene Styrene (ABS) Pipe** – Schedule 40 solid core ABS or cellular core ABS (ccABS) pipe.
- Waste/Overflow Fitting** – Nom 1-1/2 in. (38 mm) diam waste/overflow fitting, formed of polyvinyl chloride (PVC).
- Fill, Void or Cavity Materials – Sealant** – (Optional, Not Shown) – For W Rating, a min 1/4 in. (6 mm) bead of sealant is required at the tub box/concrete interface on the top surface of the floor. For W and L Ratings, a min 1/2 in. (13 mm) depth of sealant is required in the annular space between the drain piping and the tub box throat flush with the bottom inside surface of the tub box.
3M COMPANY – FB-1000 NS Sealant, FB-1003 SL Sealant or FB-3000 WT Sealant

*Bearing the UL Classification Mark

Reprinted from the Online Certifications Directory with permission from Underwriters Laboratories Inc.

Copyright © 2011 Underwriters Laboratories Inc.®

System No. F-A-2110

January 09, 2007

F Rating – 2 Hr

T Rating – 0 Hr

L Rating at Ambient – Less Than 1 CFM/sq ft (See Item 4)

L Rating at 400° F – Less Than 1 CFM/sq ft (See Item 4)

W Rating – Class 1 (See Item 4)

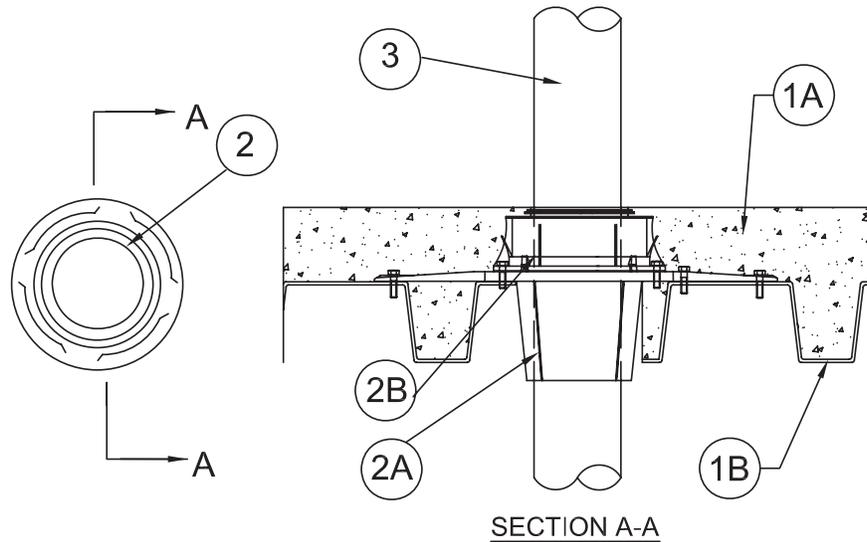

1. **Floor Assembly** – The fire-rated unprotected concrete and steel floor assembly shall be constructed of the materials and in the manner specified in the individual D900 Series designs in the UL Fire Resistance Directory and as summarized below:
 - A. **Concrete** – Min 2-1/2 in. (64 mm) thick reinforced lightweight or normal weight (100-150 pcf or 1600-2400 kg/m³) concrete.
 - B. **Steel Floor and Form Units*** – Composite or noncomposite max 3 in. (76 mm) deep fluted galv units as specified in the individual Floor-Ceiling design.
2. **Firestop Devices*** – The firestop devices are cast in place and permanently embedded during concrete placement or grouted in concrete assembly in accordance with accompanying installation instructions.
 - A. **Firestop Device – Metal Deck Adapter*** – Nom adapter size to match the nom penetrant size (Item 3), except that 2 in. (51 mm) adapter is suitable for both nom 1-1/2 in. and 2 in. (38 and 51 mm) diam penetrants. Adapter to be installed through opening in deck and secured with four sheet metal screws to deck in accordance with installation instructions.
3M COMPANY – 3M Fire Barrier Cast-In Device Metal Deck Adapter, 2MDA, 3MDA, 4MDA
 - B. **Firestop Device** – Snapped into top of metal deck adapter in accordance with accompanying installation instructions. The device may be trimmed flush with top surface of floor or may project up to a max 5-1/2 in. (140 mm) above top surface of floor.
3M COMPANY – 3M Fire Barrier Cast-In Device, 2PCID, 3PCID, 4PCID
3. **Through Penetrants** – One nonmetallic pipe or conduit installed within the firestop system. Pipe or conduit to be rigidly supported on both sides of floor assembly. The nom pipe or conduit size shall match the nom size of the firestop device with the exception that both nom 1-1/2 in. and 2 in. (38 and 51 mm) diam pipes or conduits are suitable for use with the nom 2 in. (51 mm) diam device. The following types of nonmetallic pipes or conduits may be used:
 - A. **Polyvinyl Chloride (PVC) Pipe** – Schedule 40 solid core PVC or cellular core PVC (ccPVC) pipe for use in closed (process or supply) or vented (drain, waste or vent) piping systems.
 - B. **Rigid Nonmetallic Conduit (RNC)+** – Schedule 40 PVC conduit installed in accordance with Article 347 of the National Electrical Code (NFPA No. 70).
 - C. **Chlorinated Polyvinyl Chloride (CPVC) Pipe** – SDR13.5 CPVC pipe for use in closed (process or supply) piping systems.
 - D. **Acrylonitrile Butadiene Styrene (ABS) Pipe** – Schedule 40 solid core ABS or cellular core ABS (ccABS) pipe for use in closed (process or supply) or vented (drain, waste or vent) piping systems.
 - E. **Fire Retardant Polypropylene (FRPP) Pipe** – Schedule 40 FRPP pipe for use in closed (process or supply) or vented (drain, waste or vent) piping systems.
4. **Fill, Void or Cavity Materials – Sealant** – (Optional, Not Shown) – For W Rating, a min 1/4 in. (6 mm) bead of sealant is required at the device/concrete interface on the top surface of the floor. When nom 1-1/2 in. (38 mm) diam pipe is installed in nom 2 in. (51 mm) diam device, a min 1/2 in. (13 mm) depth of sealant is required in the annular space between the pipe and the inside of the device to attain the W and L Ratings.

3M COMPANY – FB-1000 NS Sealant, FB-1003 SL Sealant or FB-3000 WT Sealant

*Bearing the UL Classification Mark

+ - Bearing the UL Listing Mark

Reprinted from the Online Certifications Directory with permission from Underwriters Laboratories Inc.

Copyright © 2011 Underwriters Laboratories Inc.®

System No. F-A-2115

January 09, 2007

F Rating – 2 Hr

T Rating – 1/4 Hr

L Rating at Ambient – Less Than 1 CFM/sq ft (See Item 5)

L Rating at 400° F – Less Than 1 CFM/sq ft (See Item 5)

W Rating – Class 1 (See Item 5)

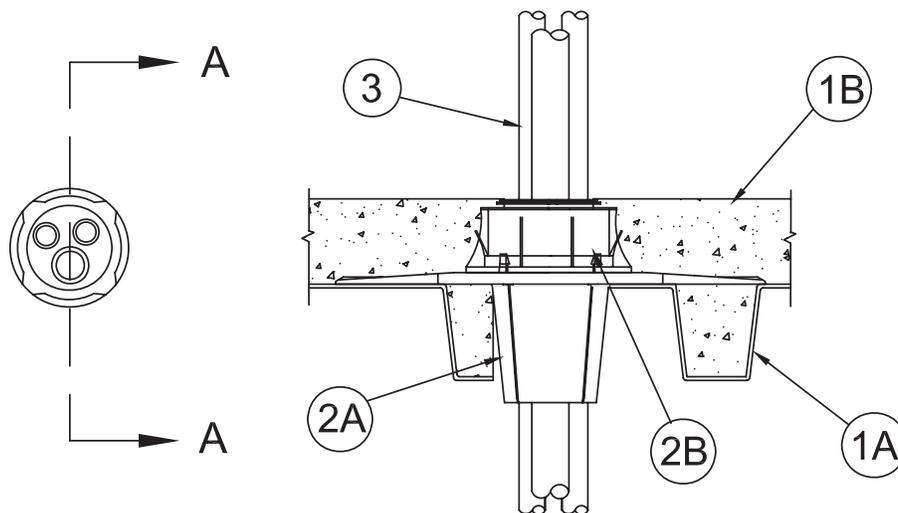

Section A-A

- Floor Assembly** – The fire-rated unprotected concrete and steel floor assembly shall be constructed of the materials and in the manner specified in the individual D900 Series designs in the UL Fire Resistance Directory and as summarized below:
 - Concrete** – Min 2-1/2 in. (64 mm) thick reinforced lightweight or normal weight (100-150 pcf or 1600-2400 kg/m³) concrete.
 - Steel Floor and Form Units*** – Composite or noncomposite max 3 in. (76 mm) deep fluted galv units as specified in the individual Floor-Ceiling design.
- Firestop Devices*** – The firestop devices are cast in place and permanently embedded during concrete placement or grouted in concrete assembly in accordance with accompanying installation instructions.
 - Firestop Device* – Metal Deck Adapter** – Nom 2 in. (51 mm) adapter, installed through opening in deck and secured with four sheet metal screws to deck in accordance with installation instructions.
3M COMPANY – 3M Fire Barrier Cast-In Device Metal Deck Adapter, 2MDA
 - Firestop Device*** – Snapped into top of metal deck adapter in accordance with accompanying installation instructions. The device may be trimmed flush with top surface of floor or may project up to a max 5-1/2 in. (140 mm) above top surface of floor.
3M COMPANY – 3M Fire Barrier Cast-In Device, 2MCID or 2PCID
- Through Penetrants** – A max of three nonmetallic pipes, conduit or tube installed eccentrically or concentrically within the firestop system. Annular space between the penetrants and the periphery of the opening shall be min 0 in. (0 mm) (point contact) to max 1 in. (25 mm). Annular space between penetrants is min 1/4 in. (25 mm) to max 1 in. (25 mm). Pipe or conduit to be rigidly supported on both sides of floor assembly. The following types of nonmetallic pipes or conduits may be used:
 - Polyvinyl Chloride (PVC) Pipe** – Nom 1 in. (25 mm) diam (or smaller) Schedule 40 solid core PVC pipe for use in closed (process or supply) or vented (drain, waste or vent) piping systems.
 - Rigid Nonmetallic Conduit (RNC)+** – Nom 1 in. (25 mm) diam (or smaller) Schedule 40 PVC conduit installed in accordance with the National Electrical Code (NFPA No. 70).
 - Chlorinated Polyvinyl Chloride (CPVC) Pipe** – Nom 1 in. (25 mm) diam (or smaller) SDR13.5 CPVC pipe for use in closed (process or supply) piping systems.
 - Crosslinked Polyethylene (PEX) Tubing** – Nom 3/4 in. (19 mm) diam (or smaller) SDR 9 PEX tubing for use in closed (process or supply) or vented (drain, waste or vent) piping systems.
- Packing Material** – (Not Shown) – Min 1/2 in. (13 mm) thickness of min 4 pcf (64 kg/m³) mineral wool batt insulation firmly packed into the top of the firestop device (Item 2B) as a permanent form, flush with the top surface of the floor.
- Fill, Void or Cavity Materials – Sealant** – (Optional, Not Shown) – For W Rating, a min 1/4 in. (6 mm) bead of sealant is required at the device/concrete interface on the top surface of the floor. When nom 1-1/2 in. (38 mm) diam pipe is installed in nom 2 in. (51 mm) diam device, a min 1/4 in. (6 mm) depth of sealant atop a min 1/2 in. (13 mm) thickness of mineral wool packing material is required in the annular space between the pipe and the inside of the device to attain the W and L Ratings.

3M COMPANY – FB-1000 NS Sealant, FB-1003 SL Sealant or FB-3000 WT Sealant

*Bearing the UL Classification Mark

+ - Bearing the UL Listing Mark

Reprinted from the Online Certifications Directory with permission from Underwriters Laboratories Inc.

Copyright © 2011 Underwriters Laboratories Inc.®



UL System No. F-A-2129
XHEZ - Through-penetration Firestop Systems

June 09, 2004

F Rating — 2 Hr
T Rating — 1-1/2 Hr

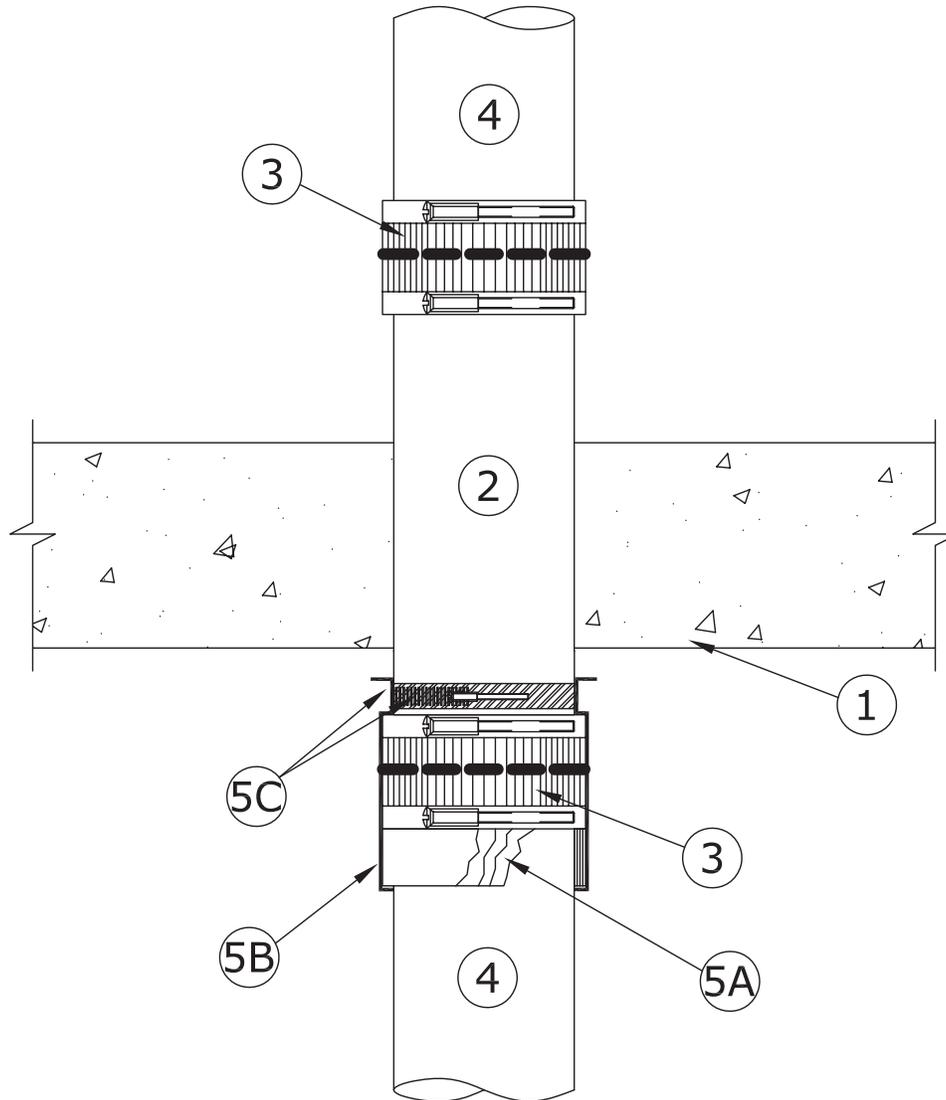

- 1. Floor Assembly** – Min 4-1/2 in. (114 mm) thick reinforced lightweight or normal weight (100-150 pcf or 1600-2400 kg/m³) concrete.
- 2. Metallic Pipes** – Nom 4 in. (102 mm) diam (or smaller) Schedule 10 (or heavier) steel pipe or cast/ductile iron pipe cast or grouted into concrete. Pipe to terminate 2-1/2 to 3-1/2 in. (64 to 89 mm) below bottom surface of floor and a min 2 in. above top surface of floor.
- 3. Compression Coupling** – Nonmetallic pipe (Item 4) to be secured to metallic pipe with compression type high pressure pipe coupling with elastomeric gasket and a stainless steel jacket with stainless steel band clamps.
- 4. Nonmetallic Pipe** – Nom 4 in. (102 mm) diam (or smaller) pipe for use in closed (process or supply) or vented (drain, waste or vent) piping systems. The following types and sizes of nonmetallic pipes may be used:
 - A. Polyvinyl Chloride (PVC) Pipe** – Nom 4 in. (102 mm) diam (or smaller) Schedule 40 solid core or cellular core PVC pipe.
 - B. Acrylonitrile Butadiene Styrene (ABS) Pipe** – Nom 4 in. (102 mm) diam (or smaller) Schedule 40 solid core or cellular core ABS pipe.
 - C. Fire Retardant Polypropylene (FRPP) Pipe** – Nom 4 in. (102 mm) diam (or smaller) Schedule 40 FRPP pipe.

5. Firestop System – The firestop system shall consist of the following:

A. Fill, Void or Cavity Material* – Wrap Strip – Nom 1/8 in. (3.2 mm) thick intumescent material supplied in 2 in. (51 mm) wide strips. Wrap strip tightly wrapped around nonmetallic drain pipe (Item 4) located below floor. The top edge of the wrap strips shall abut the bottom edge of the compression coupling (Item 3). For nom 2 in. (51 mm) diam (and smaller) pipes, two layers are required. For nom 2-1/2 in. (64 mm) to 3 in. (76 mm) diam pipes, three layers are required. For nom 3-1/2 in. (89 mm) and 4 in. (102 mm) diam pipes, four layers are required. Wrap strip layers temporarily held in position using aluminum foil tape, steel wire tie, or equivalent.

3M COMPANY – Ultra GS

B. Steel Collar – Nom 2 in. (51 mm) deep collar with 1-1/4 in. (32 mm) wide by 2 in. (51 mm) long anchor tabs and min 1/2 in. (13 mm) long tabs to retain wrap strip layers. Coils of precut 0.016 in. (0.41 mm) thick (28 gauge) galv sheet steel available from wrap strip manufacturer. As an alternate, collar may be field-fabricated from min 0.016 in. (0.41 mm) thick (28 gauge) galv sheet steel in accordance with instruction sheet supplied by wrap strip manufacturer. Steel collar, with anchor tabs upward (unbent), wrapped tightly around wrap strip layers with min 1 in. (25 mm) overlap at seam and compressed around wrap strip layers using a min 1/2 in. (13 mm) wide stainless steel clamp at the collar midheight.

C. Hanger Straps – Hanger straps to be fabricated out of min 0.016 in. (0.41 mm) thick (28 gauge) sheet steel. Hanger straps to be tapered from 1/4 in. (6 mm) wide to 1-1/4 in. (32 mm) wide and be of sufficient length so when attached to anchor tabs they lap onto metallic pipe above the compression coupling a min of 1 in. (25 mm) For nom max 2 in. (51 mm) (and smaller) penetrants, two hangers are required. For nom 2-1/2 and 3 in. (64 and 76 mm) penetrants, three hangers are required. For nom 3-1/2 and 4 in. (89 and 102 mm) penetrants, four hangers are required. Hangers to be secured to collar assembly by inserting 1/4 in. (6 mm) end into slot opening in collar anchor tab and bending 180°. The hangers shall be tightly compressed around the metallic pipe below the floor, directly above the compression coupling with a min 1/2 in. (13 mm) stainless steel hose clamp.



*Indicates such products shall bear the UL or cUL Certification Mark for jurisdictions employing the UL or cUL Certification (such as Canada), respectively.

System No. F-A-2130

October 07, 2010

F Rating – 2 Hr

T Rating – 2 Hr

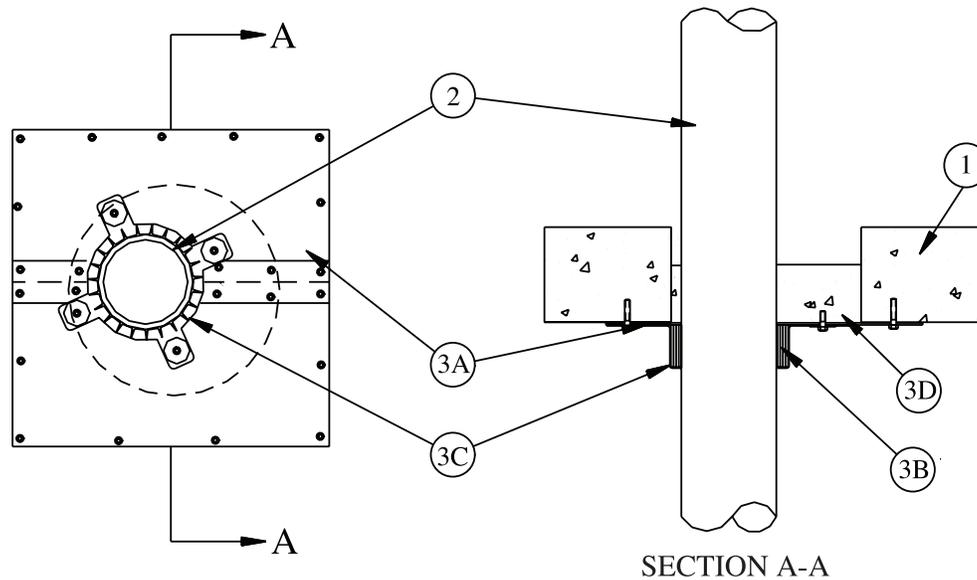

1. **Floor Assembly** – Min 4-1/2 in. (114 mm) thick reinforced lightweight or normal weight (100-150 pcf or 1600-2400 kg/m³) concrete. Max diam of opening is 9 in. (229 mm).
2. **Through Penetrants** – One nonmetallic pipe or conduit to be installed either concentrically or eccentrically within the firestop system. The annular space between penetrant and periphery of opening shall be min 1/4 in. (6 mm) to max 4-1/4 in. (108 mm). Penetrant to be rigidly supported on both sides of floor assembly. The following types and sizes of pipes or conduit may be used:
 - A. **Polyvinyl Chloride (PVC) Pipe** – Nom 4 in. (102 mm) diam (or smaller) Schedule 40 solid core or cellular core PVC pipe for use in closed (process or supply) or vented (drain, waste or vent) piping systems.
 - B. **Chlorinated Polyvinyl Chloride (CPVC) Pipe** – Nom 4 in. (102 mm) diam (or smaller) SDR13.5 CPVC pipe for use in closed (process or supply) piping systems.
 - C. **Rigid Nonmetallic Conduit⁺⁺** – Nom 4 in. (102 mm) diam (or smaller) Schedule 40 PVC conduit installed in accordance with Article 347 of the National Electric Code (NFPA No. 70).
3. **Firestop System** – The firestop system shall consist of the following:
 - A. **Steel Cover Plate** – Min 24 gauge galv steel cover plate, sized to overlap opening a min of 3 in. (76 mm) on all sides. Opening in plate for penetrant to be sized to the outside diam of penetrant. Plate attached to bottom of floor with min 3/16 in. (4.8 mm) diam by 1-1/4 in. (32 mm) long steel masonry anchors spaced a max of 6 in. (152 mm) OC. Seams in plate covered with min 2 in. (51 mm) wide 28 gauge (or heavier) galv steel strip attached to cover plate with No. 10 (or larger) steel screws on each side of seam spaced a max of 3 in. (76 mm) OC.
 - B. **Fill, Void or Cavity Material* – Wrap Strip** – Nom 1/8 in. (3.2 mm) thick intumescent material supplied in 2 in. (51 mm) wide strips. Wrap strip tightly wrapped around nonmetallic drain pipe (Item 4) located below floor. The top edge of the wrap strips shall abut the bottom edge of the compression coupling (Item 3). For nom 2 in. (51 mm) diam (and smaller) pipes, two layers are required. For nom 2-1/2 in. (64 mm) to 3 in. (76 mm) diam pipes, three layers are required. For nom 3-1/2 in. (89 mm) and 4 in. (102 mm) diam pipes, four layers are required. Wrap strip layers temporarily held in position using aluminum foil tape, steel wire tie, or equivalent.
3M COMPANY – Ultra GS
 - C. **Steel Collar** – Nom 2 in. (51 mm) deep collar with 1-1/4 in. (32 mm) wide by 2 in. (51 mm) long anchor tabs and min 1/2 in. (13 mm) long tabs to retain wrap strip layers. Coils of precut 0.016 in. (0.41 mm) thick (28 gauge) galv sheet steel available from wrap strip manufacturer. As an alternate, collar may be field-fabricated from min 0.016 in. (0.41 mm) thick (28 gauge) galv sheet steel in accordance with instruction sheet supplied by wrap strip manufacturer. Steel collar, with anchor tabs bent outward 90 deg, wrapped tightly around wrap strip layers with min 1 in. (25 mm) overlap at seam. Anchor tabs to be pressed tightly against cover plate, and collar to be compressed around wrap strip layers using a min 1/2 in. (13 mm) wide stainless steel clamp at the collar midheight. As an alternate to the band clamp, collar for systems with three or more layers of wrap strip may be fastened together along with three No. 6 by 3/8 in. (10 mm) long self-tapping steel screws. Collar to be secured to cover plate with No. 10 (or larger) by min 3/4 in. (19 mm) long steel screws in conjunction with min 1-1/4 in. (32 mm) diam steel washers. Min of two, three or four anchor bolts, symmetrically located, for nom 2 in. (51 mm) diam (and smaller), nom 2-1/2 to 3 in. (64 to 76 mm) diam and nom 3-1/2 to 4 in. (89 to 102 mm) diam pipes, respectively.
 - D. **Fill, Void or Cavity Material* – Mortar** – Min 3 in. (76 mm) thickness of mortar applied within the annulus on top surface of cover plate, flush with bottom surface of floor.
3M COMPANY – 3M Fire Barrier Mortar

⁺⁺Bearing the UL Listing Mark

*Bearing the UL Classification Mark

Reprinted from the Online Certifications Directory with permission from Underwriters Laboratories Inc.

Copyright © 2011 Underwriters Laboratories Inc.®

System No. F-A-2137

November 22, 2004

F Ratings – 2 and 3 Hr (See Item 3)

T Ratings – 2 and 3 Hr (See Item 3)

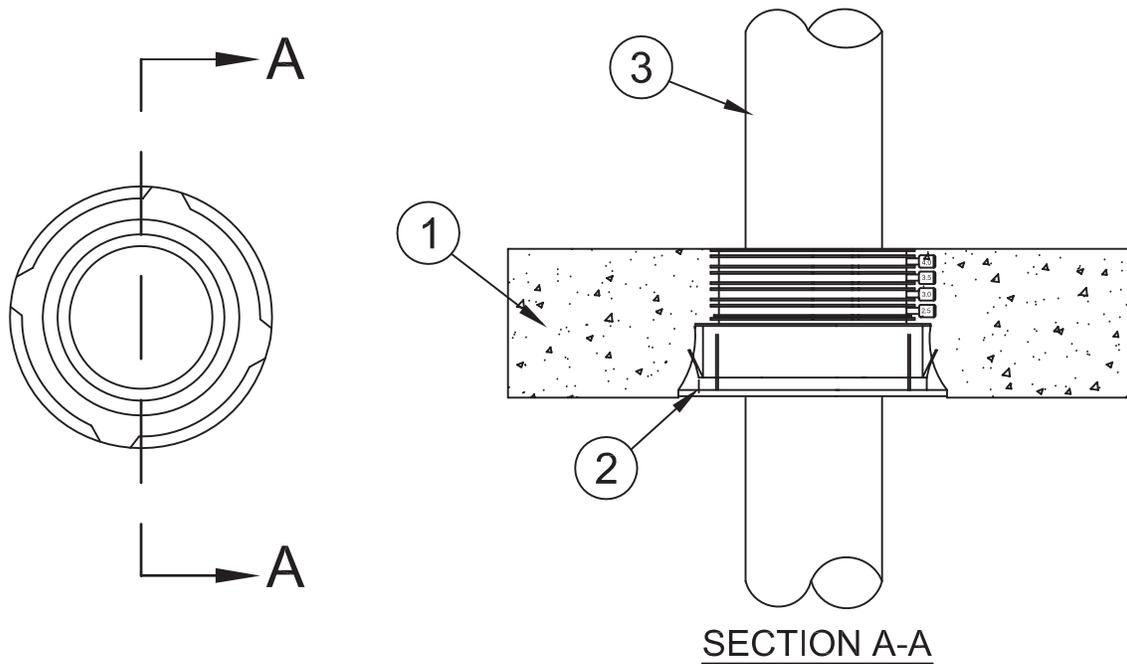

1. **Floor Assembly** – Min 4-1/2 in. (114 mm) thick reinforced lightweight or normal weight (100-150 pcf or 1600-2400 kg/m³) concrete.
2. **Firestop Device*** – Cast in place firestop device permanently embedded during concrete placement or grouted in concrete assembly in accordance with accompanying installation instructions. The device must be trimmed flush with top surface of floor.
 - 3M COMPANY** – 3M Fire Barrier Cast-In Device 6PCID
- 2A. **Firestop Device – Height Adapter*** (not shown) – For use in floors greater than 8 in. (203 mm) thick. Adapter snaps onto top of firestop device (Item 2).
 - 3M COMPANY** – 3M Fire Barrier Cast-In Device Height Adapter, 6HA
3. **Through Penetrant** – One nonmetallic pipe or conduit installed within the firestop system. Pipe or conduit to be rigidly supported on both sides of floor assembly. The following types and sizes of nonmetallic pipes or conduit may be used:
 - A. **Polyvinyl Chloride (PVC) Pipe** – Nom 6 in. (152 mm) diam Schedule 40 solid core PVC pipe for use in closed (process or supply) or vented (drain, waste or vent) piping systems.
 - B. **Polyvinyl Chloride (PVC) Pipe** – Nom 6 in. (152 mm) diam Schedule 40 cellular core PVC (ccPVC) pipe for use in closed (process or supply) or vented (drain, waste or vent) piping systems.
 - C. **Rigid Nonmetallic Conduit (RNC)+** – Nom 6 in. (152 mm) diam Schedule 40 PVC conduit installed in accordance with Article 347 of the National Electrical Code (NFPA No. 70).

The hourly F and T Rating of the firestop system is 3 Hr for penetrants A and C. The hourly F and T Rating is 2 Hr for penetrant B.

* Bearing the UL Classification Mark

+ Bearing the UL Listing Mark

Reprinted from the Online Certifications Directory with permission from Underwriters Laboratories Inc.
Copyright © 2010 Underwriters Laboratories Inc.®

System No. F-A-2167

October 30, 2006

F Ratings – 2 and 3 Hr (See Item 3)

T Ratings – 2 and 3 Hr (See Item 3)

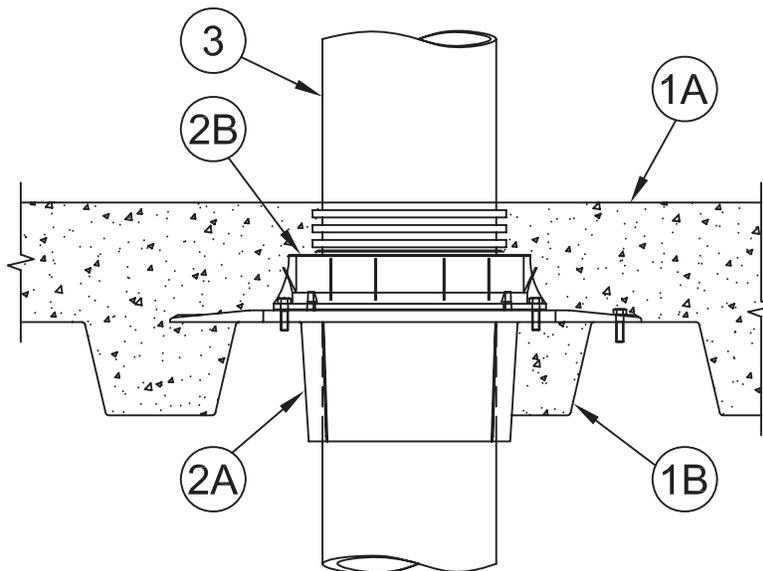

- 1. Floor Assembly** – The fire-rated unprotected concrete and steel floor assembly shall be constructed of the materials and in the manner specified in the individual D900 Series designs in the UL Fire Resistance Directory and as summarized below:
 - A. Concrete** – Min 4-1/2 in. (114 mm) thick reinforced lightweight or normal weight (100-150 pcf or 1600-2400 kg/m³) concrete topping.
 - B. Steel Floor and Form Units*** – Composite or noncomposite max 3 in. (76 mm) deep fluted galv units as specified in the individual Floor-Ceiling design.
- 2. Firestop Devices*** – The firestop devices are cast in place and permanently embedded during concrete placement or grouted in concrete assembly in accordance with accompanying installation instructions.
 - A. Firestop Device – Metal Deck Adapter*** – Adapter installed through opening in deck and secured with four sheet metal screws to deck in accordance with installation instructions.
3M COMPANY – 3M Fire Barrier Cast-In Device Metal Deck Adapter, 6MDA
 - B. Firestop Device*** – Snapped into top of metal deck adapter in accordance with accompanying installation instructions. The device shall be trimmed flush with top surface of floor.
3M COMPANY – 3M Fire Barrier Cast-In Device, 6PCID
- 3. Through Penetrant** – One nonmetallic pipe or conduit installed within the firestop system. Pipe or conduit to be rigidly supported on both sides of floor assembly. The following types and sizes of nonmetallic pipes or conduit may be used:
 - A. Polyvinyl Chloride (PVC) Pipe** – Nom 6 in. (152 mm) diam Schedule 40 solid core PVC pipe for use in closed (process or supply) or vented (drain, waste or vent) piping systems.
 - B. Polyvinyl Chloride (PVC) Pipe** – Nom 6 in. (152 mm) diam Schedule 40 cellular core PVC (ccPVC) pipe for use in closed (process or supply) or vented (drain, waste or vent) piping systems.
 - C. Rigid Nonmetallic Conduit (RNC)+** – Nom 6 in. (152 mm) diam Schedule 40 PVC conduit installed in accordance with the National Electrical Code (NFPA No. 70).

The hourly F and T Ratings of the firestop system are 3 Hr when Item 3A or 3C is used. The hourly F and T Ratings of the firestop system are 2 Hr when Item 3B is used.

*Bearing the UL Classification Mark

+ Bearing the UL Listing Mark

Reprinted from the Online Certifications Directory with permission from Underwriters Laboratories Inc.
Copyright © 2010 Underwriters Laboratories Inc.®

System No. F-A-2175

January 12, 2009

F Rating – 2 Hr

T Rating – 2 Hr

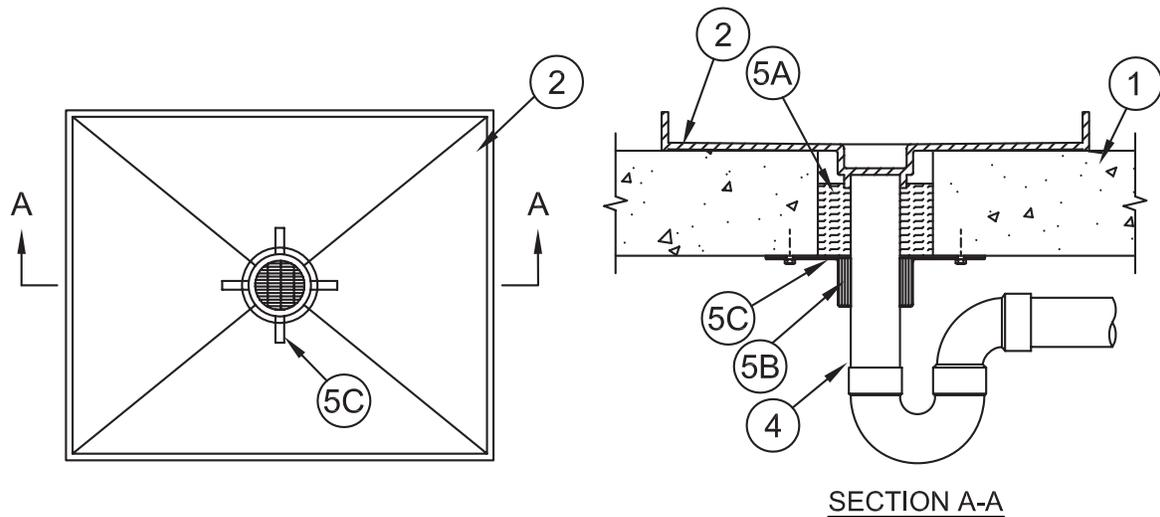

1. **Floor Assembly** – Min 4-1/2 in. (114 mm) thick lightweight or normal weight (100-150 pcf or 1600-2400 kg/m³) concrete. Max diam of opening is 6 in. (152 mm).
2. **Plastic Plumbing Fixtures+ – Shower Base Receptor** – One-piece molded nonmetallic shower base receptor with stainless steel drain plate. Shower base receptor to be installed in accordance with the manufacturer's instructions.
TILE-REDI USA L L C – Model 3360L, 3360R, 37NEO, 3737, 4837, 4837ADA, 4837MB or 4848
3. **Tile** – (Not Shown) – Ceramic or stone tile applied to shower pan floor with epoxy adhesive in accordance with shower base receptor installation instructions.
4. **Nonmetallic Pipe** – Nom 2 in. (51 mm) diam Schedule 40 solid or cellular core PVC pipe solvent welded into drain in the bottom of the shower base receptor and centered in the floor opening.
5. **Firestop System** – The details of the firestop system shall be as follows:
 - A. **Packing Material** – Min 3 in. (76 mm) thickness of min 4 pcf (64 kg/m³) mineral wool batt insulation firmly-packed into annular space as a permanent form, flush with bottom surface of concrete floor.
 - B. **Fill, Void or Cavity Materials* – Wrap Strip** – Nom 1/8 in. (3.2 mm) thick intumescent material supplied in 2 in. (51 mm) wide strips. Single layer of wrap strip tightly wrapped around nonmetallic drain pipe (Item 4) with a butted seam and with the top edge of the wrap strip abutting the packing material. Wrap strip layer temporarily held in position using tape.
3M COMPANY
3M FIRE PROTECTION PRODUCTS – Ultra GS
 - C. **Steel Collar** – Nom 2 in. (51 mm) deep collar with 1-1/4 in. (32 mm) wide by 2 in. (51 mm) long anchor tabs and tabs to retain wrap strip layer. Coils of precut 0.016 in. (0.41 mm) thick (28 gauge) galv sheet steel available from wrap strip manufacturer. Steel collar, with anchor tabs bent outward 90 deg, wrapped tightly around wrap strip with min 1 in. (25 mm) overlap at seam. Anchor tabs to be pressed tightly against bottom of packing material, and collar to be compressed around wrap strip using a min 1/2 in. (13 mm) wide stainless steel clamp at the collar midheight. Collar to be secured to underside of concrete floor with steel concrete screws with min 1-1/4 in. (32 mm) diam steel washers in conjunction with steel extension straps. Hanger tab extension straps to be fabricated from min 0.022 in. (0.6 mm) thick galv sheet steel. Taper straps from 1/4 in. (6 mm) wide to 1 in. (25 mm) wide with sufficient length to allow 1-1/2 to 2 in. (38 to 51 mm) lap onto floor. Straps secured to collar by inserting min 1 in. (25 mm) length of 1/4 in. (6 mm) wide end into hole on mounting tab and bending 180 degrees. Min of four anchor screws, symmetrically located, are required.

*Bearing the UL Classification Mark

Reprinted from the Online Certifications Directory with permission from Underwriters Laboratories Inc.

Copyright © 2010 Underwriters Laboratories Inc.®

System No. F-A-2268

July 25, 2016

F Rating — 2 Hr
T Rating — 1-1/2 Hr
W Rating — Class I (See Item 3)
L Rating at Ambient — Less than 1 CFM/ft²
L Rating at 400 F — Less than 1 CFM/ft²

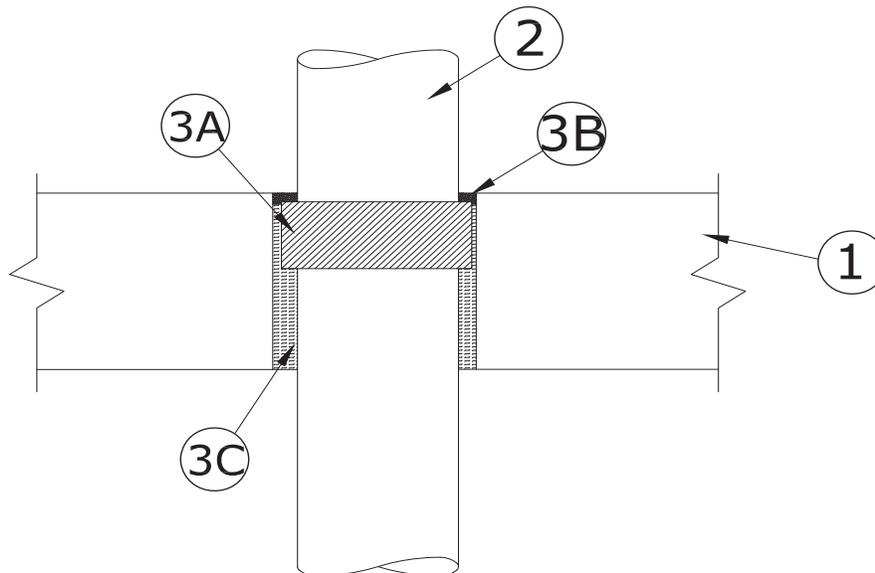

SECTION A-A

1. **Floor Assembly** — Min 4-1/2 in. (114 mm) thick reinforced lightweight or normal weight (100-150 pcf or 1600-2400 kg/m³) concrete. Max diam of opening is 9 in. (229 mm).
2. **Through Penetrant** — One nonmetallic pipe to be installed concentrically within the firestop system. The annular space between the pipe and the periphery of the opening shall be 1/2 in. (13 mm). Pipe to be rigidly supported on both sides of the floor assembly. The following types and sizes of nonmetallic pipes or conduits may be used:
 - A. **Polypropylene Pipe** — Nom 8 in. (203 mm) diam (or smaller) Polystar PP-RCT (CT-White) pipe for use in closed (process or supply) piping systems.
3. **Firestop System** — The firestop system shall consist of the following:
 - A. **Fill, Void or Cavity Material*** — **Wrap Strip** — Two layers of min 3/16 in. (5 mm) thick intumescent material supplied in 2-1/2 in. (64 mm) wide strips. Two layers of wrap strip tightly wrapped around nonmetallic pipe and secured with either aluminum foil tape or filament tape. Wrap strip is to be installed within the opening such that the top of the wrap strip is min 1/2 in. (13 mm) below the top surface of floor.
3M COMPANY 3M FIRE PROTECTION PRODUCTS — Tuck-In Wrap Strip WS Roll
 - B. **Fill, Void or Cavity Material*** — **Caulk or Sealant** — Min 1/2 in. (13 mm) thickness of sealant applied within annular space, flush with top surface of floor.
3M COMPANY 3M FIRE PROTECTION PRODUCTS — IC 15WB+ Caulk, CP 25WB+ Caulk, or 3000 WT Sealant (CP 25WB+ not suitable for use with CPVC pipes)
 - C. **Packing Material** — Min 1-1/2 in. (38 mm) thickness of min 4 pcf (64 kg/m³) mineral wool batt insulation firmly packed into opening as a permanent form, flush with the bottom surface of the floor.

(Note: W Rating only applies when FB 3000 WT Sealant is used.)

* Indicates such products shall bear the UL or cUL Certification Mark for jurisdictions employing the UL or cUL Certification (such as Canada), respectively.



System No. F-B-2005

November 20, 2009

F Rating – 2 Hr

T Ratings – 0 & 2 Hr (See Item 2)

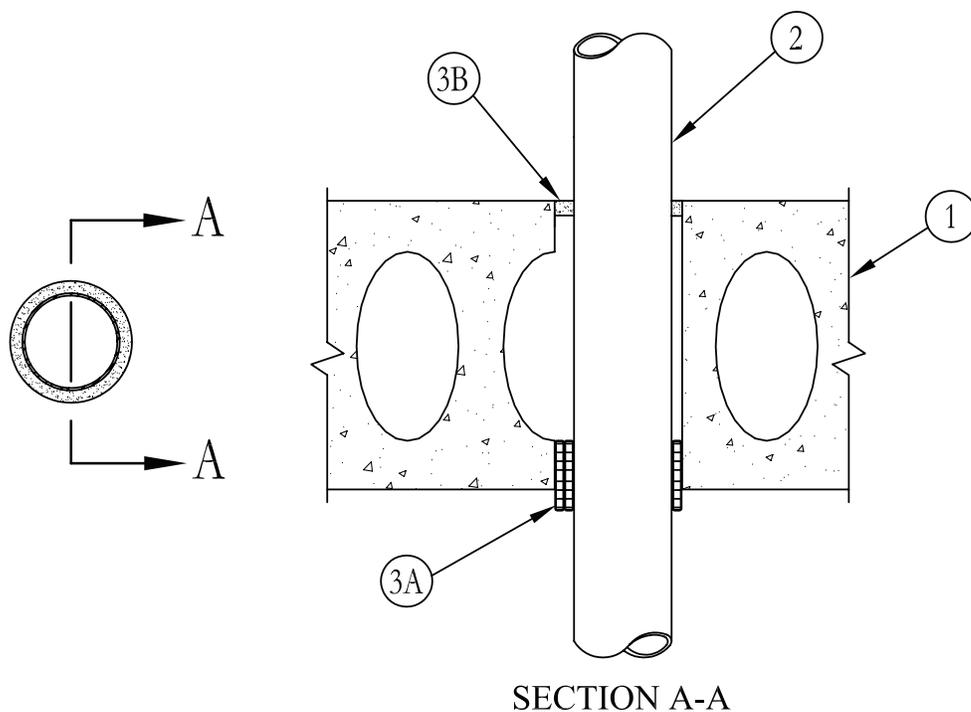

- 1. Floor Assembly** – Min 6 in. (152 mm) thick UL Classified hollow-core **Precast Concrete Units***. Floor may also be constructed of any min 6 in. (152 mm) thick reinforced lightweight or normal weight (100-150 pcf or 1600 - 2400 kg/m³) concrete. Diam of opening shall be 1 in. (25 mm) to 1-1/4 in. (32 mm) larger than nom pipe diam.
See **Precast Concrete Units** (CFTV) category in the Fire Resistance Directory for names of manufacturers.
- 2. Through Penetrants** – One nonmetallic pipe or conduit to be centered within opening with a nom 1/4 in. (6 mm) to 5/16 in. (8 mm) annular space between pipe or conduit and periphery of opening. Pipe or conduit to be rigidly supported on both sides of the floor or wall assembly. The following types and sizes of nonmetallic pipes or conduits may be used:
 - A. Polyvinyl Chloride (PVC) Pipe** – Nom 3 in. (76 mm) diam (or smaller) Schedule 40 solid core PVC pipe for use in closed (process or supply) or vented (drain, waste or vent) piping systems.
 - B. Cellular Core Polyvinyl Chloride (ccPVC) Pipe** – Nom 3 in. (76 mm) diam (or smaller) Schedule 40 solid core PVC pipe for use in closed (process or supply) or vented (drain, waste or vent) piping systems.
 - C. Rigid Nonmetallic Conduit⁺⁺** – Nom 3 in. (76 mm) diam (or smaller) Schedule 40 PVC conduit installed in accordance with Article 347 of the National Electrical Code (NFPA No. 70).
 - D. Chlorinated Polyvinyl Chloride (CPVC) Pipe** – Nom 3 in. (76 mm) diam (or smaller) SDR13.5 CPVC pipe for use in closed (process or supply) piping systems.
 - E. Acrylonitrile Butadiene Styrene (ABS) Pipe** – Nom 2 in. (51 mm) diam (or smaller) Schedule 40 solid core or cellular core ABS pipe for use in closed (process or supply) or vented (drain, waste or vent) piping systems.**The T Rating is 2 Hr for penetrants A, C and D. The T Rating is 0 Hr for penetrant B and D.**
- 3. Firestop System** – The details of the firestop system shall be as follows:
 - A. Fill, Void or Cavity Materials* – Wrap Strip** – Nom 1/8 in. (3.2 mm) thick intumescent material supplied in 2 in. (51 mm) wide strips. Min two continuous layers of wrap strip inserted into opening such that 1/2 in. (13 mm) of the wrap strip extended below the bottom surface of the floor and secured in position with two 1/4 in. (6 mm) bands of filament tape placed 1/2 in. (13 mm) from the bottom and top of wrap strip. Wrap strip applied at the bottom web of precast concrete unit.
3M COMPANY – Ultra GS
 - B. Fill, Void or Cavity Materials* – Caulk, Putty or Sealant** – Min 1/4 in. (6 mm) thickness of caulk, putty or sealant applied within annular space, flush with top of floor.
3M COMPANY – CP 25 WB+ caulk, FB-3000 WT sealant, MP+ Stix putty or FB-1000 NS sealant, IC 15WB+ caulk or FireDam 150+ caulk. (Note: CP 25WB+ and FireDam 150+ not suitable for use with CPVC pipes.)

*Bearing the UL Classification Marking

++Bearing the UL Listing Mark

Reprinted from the Online Certifications Directory with permission from Underwriters Laboratories Inc.

Copyright © 2010 Underwriters Laboratories Inc.®



Note: Systems with Nonmetallic Through Penetrant(s) have not been evaluated with a pressure differential of 50 Pa between the exposed and unexposed surfaces as required by the National Building Code of Canada.

System No. F-B-2006

November 20, 2009

F Rating – 2 Hr

T Rating – 0 Hr

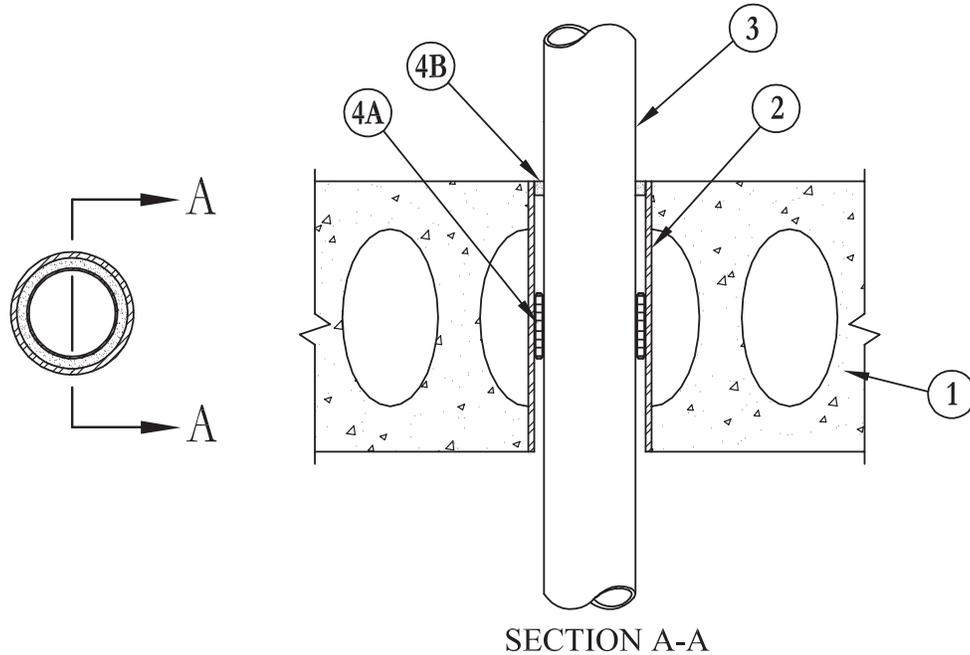

SECTION A-A

- Floor Assembly** – Min 6 in. (152 mm) thick UL Classified hollow-core **Precast Concrete Units***. Floor may also be constructed of any min 6 in. (152 mm) thick reinforced lightweight or normal weight (100-150 pcf or 1600 -2400 kg/m³) concrete. Diam of opening shall be 1 in. (25 mm) to 1-1/4 in. (32 mm) larger than nom pipe diam.

See **Precast Concrete Units (CFTV)** category in the Fire Resistance Directory for names of manufacturers.

- Steel Sleeve** – Min 28 gauge galv steel sleeve fabricated with a min 1 in. (25 mm) overlap at the seam. Length of sleeve to be the same as floor thickness. Sleeve to be friction-fitted into opening, flush with both surfaces of floor.
- Through Penetrants** – One nonmetallic pipe or conduit to be centered within opening with a nom 1/4 in. (6 mm) to 5/16 in. (8 mm) annular space between pipe or conduit and sleeve. Pipe or conduit to be rigidly supported on both sides of the floor or wall assembly. The following types and sizes of nonmetallic pipes or conduits may be used:
 - Polyvinyl Chloride (PVC) Pipe** – Nom 3 in. (76 mm) diam (or smaller) Schedule 40 solid core or cellular core PVC pipe for use in closed (process or supply) or vented (drain, waste or vent) piping system.
 - Rigid Nonmetallic Conduit++** – Nom 3 in. (76 mm) diam (or smaller) Schedule 40 PVC conduit installed in accordance with Article 347 of the National Electrical Code (NFPA No. 70).
 - Chlorinated Polyvinyl Chloride (CPVC) Pipe** – Nom 3 in. (76 mm) diam (or smaller) SDR13.5 CPVC pipe for use in closed (process or supply) piping systems.
 - Acrylonitrile Butadiene Styrene (ABS) Pipe** – Nom 3 in. (76 mm) diam (or smaller) Schedule 40 solid core or cellular core ABS pipe for use in closed (process or supply) or vented (drain, waste or vent) piping systems.
 - Fire Retardant Polypropylene (FRPP) Pipe** – Nom 3 in. (76 mm) diam (or smaller) Schedule 40 FRPP pipe for use in closed (process or supply) or vented (drain, waste or vent) piping systems.
- Firestop System** – The details of the firestop system shall be as follows:
 - Fill, Void or Cavity Materials* – Wrap Strip** – Nom 1/8 in. (3.2 mm) thick intumescent material supplied in 2 in. (51 mm) wide strips. Wrap strip tightly wrapped around nonmetallic pipe with continuous layers and secured with two 1/4 in. (6 mm) wide bands of filament tape placed 1/2 in. (13 mm) from bottom and top of wrap strip. The layers of wrap strip and its position within the opening are dependent on the pipe size. For nom 2 in. (51 mm) diam (and smaller) pipes, one layer is required, recessed within the opening 2-1/4 in. (57 mm) from the bottom surface of the floor or both surfaces of the wall. For nom 2-1/2 and 3 in. (64 and 76 mm) diam pipes, two layers are required, recessed within the opening 2 in. (51 mm) from the bottom surface of the floor or both surfaces of the wall.
3M COMPANY – Ultra GS
 - Fill, Void or Cavity Materials* – Caulk Putty or Sealant** – Min 1/4 in. (6 mm) thickness of caulk putty or sealant applied within annular space, flush with top of floor.
3M COMPANY – CP25WB+ caulk, FB-3000 WT sealant, MP+ Stix caulk, FB-1000 NS sealant, IC 15WB+ caulk or FireDam 150+ caulk. (Note: CP 25WB+ and FireDam 150+ not suitable for use with CPVC pipes.)

*Bearing the UL Classification Marking

++Bearing the UL Listing Mark

Reprinted from the Online Certifications Directory with permission from Underwriters Laboratories Inc.

Copyright © 2010 Underwriters Laboratories Inc.®



Note: Systems with Nonmetallic Through Penetrant(s) have not been evaluated with a pressure differential of 50 Pa between the exposed and unexposed surfaces as required by the National Building Code of Canada.

System No. F-B-2015

February 06, 2003

F Rating – 3 Hr

T Rating – 2 Hr

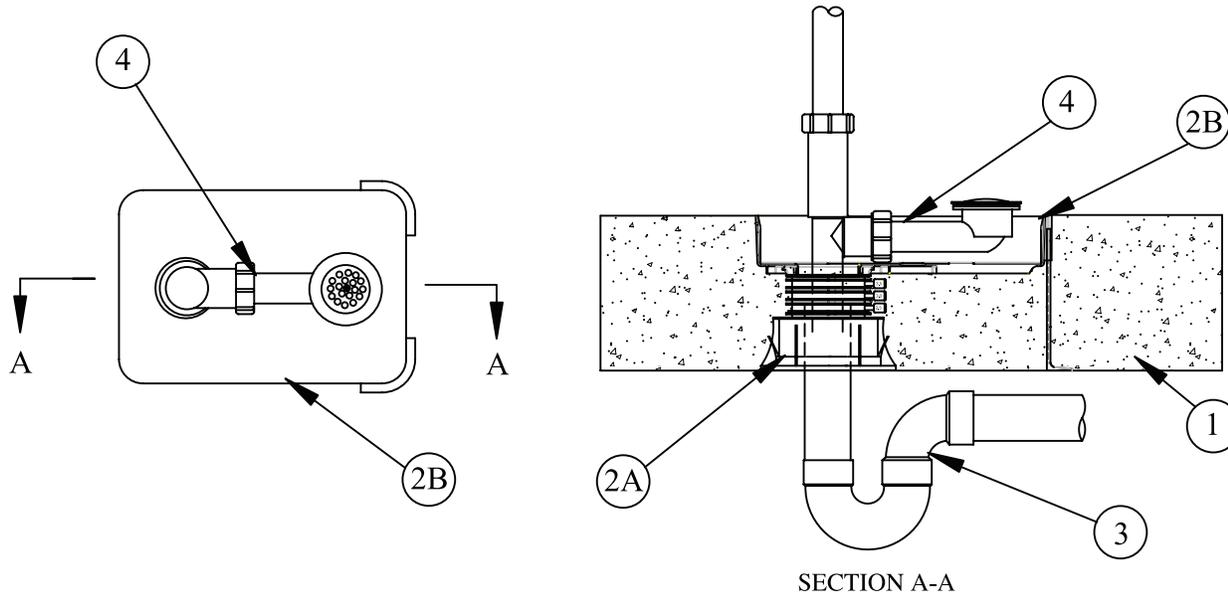

1. **Floor Assembly** – Min 6 in. thick reinforced lightweight or normal weight (100-150 pcf) concrete.
2. **Firestop Devices*** – The firestop devices are cast in place and permanently embedded during concrete placement or grouted in concrete assembly in accordance with accompanying installation instructions.
 - A. **Firestop Device*** – Cast in place firestop device installed flush with bottom surface of floor and trimmed to be 2 in. below top surface of floor.
3M COMPANY – 3M Fire Barrier Cast-In Device, 2MCID
 - B. **Firestop Device – Tub Box*** – Nom 8 by 12 by 2 in. deep polyethylene tub box, with adjustable legs, snapped into top of Cast-In Device, 2MCID (Item 2A) and cast in concrete slab, flush with top surface of floor.
3M COMPANY – 3M Fire Barrier Cast-In Device Tub Box, 2TB
3. **Drain Piping** – Nom 1-1/2 in. or 2 in. diam nonmetallic pipe and drain fittings cemented together. Drain piping rigidly supported away from tub box with suitable hangers. The following types of nonmetallic pipes may be used:
 - A. **Polyvinyl Chloride (PVC) Pipe** – Schedule 40 solid core PVC or cellular core PVC (ccPVC) pipe.
 - B. **Acrylonitrile Butadiene Styrene (ABS) Pipe** – Schedule 40 solid core ABS or cellular core ABS (ccABS) pipe.
4. **Waste/Overflow Fitting** – Nom 1-1/2 in. diam waste/overflow fitting, formed of polyvinyl chloride (PVC).

*Bearing the UL Classification Mark

Reprinted from the Online Certifications Directory with permission from Underwriters Laboratories Inc.

Copyright © 2010 Underwriters Laboratories Inc.®

System No. F-B-2018

November 22, 2004

F Rating – 3 Hr

T Rating – 1 Hr

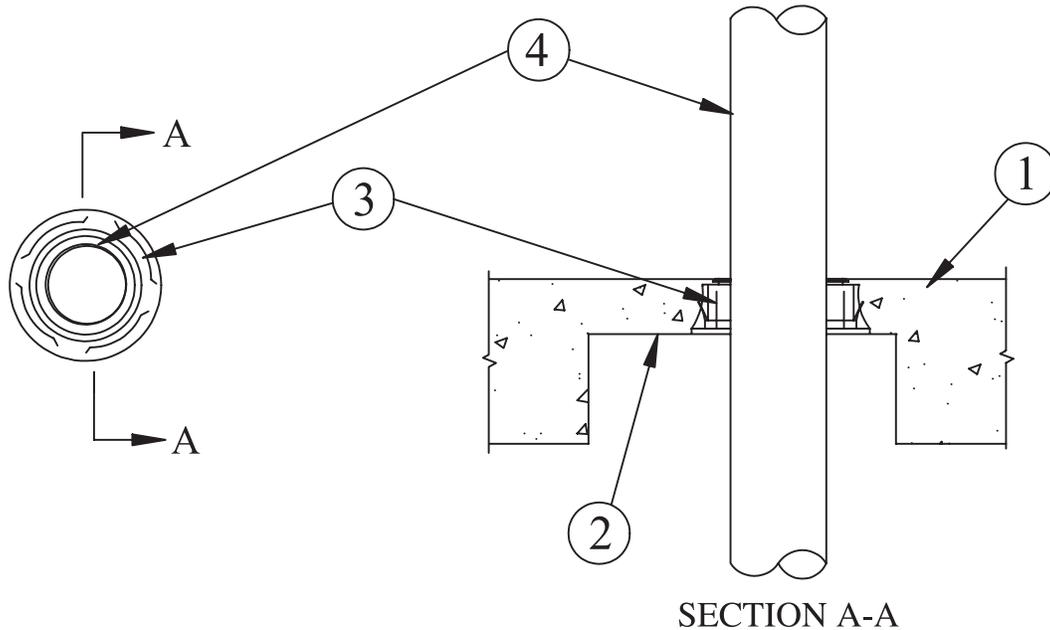

SECTION A-A

1. **Floor Assembly** – Min 6-1/2 in. thick reinforced lightweight or normal weight (100-150 pcf) concrete.
2. **Aerator Adapter** – Nom 14 in. by 9 in., min 4 in. deep cast-in-place galv steel adapter box provided with max 5 in. diam opening on top side. Firestop device (Item 3) mechanically fastened to the top side of box prior to placement of the concrete. The concrete thickness on top of adapter box shall be a min 2-1/2 in.
- 2A. **Firestop Device – Aerator Adapter*** – As an alternate to Item 2, a nom 10 in. by 7 in. by 4 in. deep nonmetallic adapter box may be used. Firestop device (Item 3) latched to the top side of box with snaps provided as part of the adapter prior to placement of the concrete. The concrete thickness on top of adapter box shall be a min 2-1/2 in.
3M COMPANY – 3M Fire Barrier Cast-In Device Aerator Adapter
3. **Firestop Device*** – The firestop device is mechanically attached to top of adapter (Item 2) with a min of four No. 8 (or larger) steel sheet metal screws or latched to the top side of nonmetallic box and cast in place and permanently embedded during concrete placement in accordance with accompanying installation instructions.
3M COMPANY – 3M Fire Barrier Cast-In Device, 3PCID, 4PCID
4. **Drain Piping** – Nom 3 in. or 4 in. diam schedule 40 solid core or cellular core polyvinyl chloride (PVC) pipe. Drain piping rigidly supported on both sides of floor assembly.
5. **Aerator Fitting** – (Not Shown) – Nom 3 in. or 4 in. diam cast iron aerator fitting attached to drain piping below floor assembly. Fitting shall not penetrate the firestop device.

*Bearing the UL Classification Mark

Reprinted from the Online Certifications Directory with permission from Underwriters Laboratories Inc.
 Copyright © 2010 Underwriters Laboratories Inc.®

System No. W-J-2012

November 20, 2009

F Rating – 2 Hr

T Ratings – 0 and 2 Hr (See Item 2)

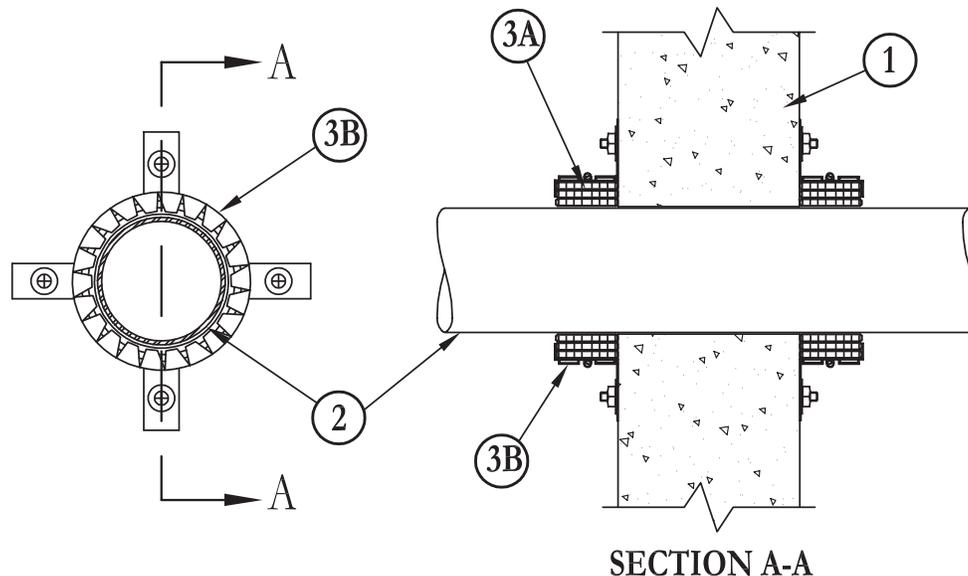

- Wall Assembly** – Min 4-1/2 in. (114 mm) thick reinforced lightweight or normal weight (100-150 pcf or 1600 - 2400 kg/m³) concrete. Wall may also be constructed of any UL Classified **Concrete Blocks***. Max diam of opening is 5 in. (127 mm).

See **Concrete Blocks** (CAZT) category in the Fire Resistance Directory for names of manufacturers.

- Nonmetallic Pipe** – Nom 4 in. (102 mm) diam (or smaller) Schedule 40 solid-core polyvinyl chloride (PVC) pipe for use in closed (process or supply) or vented (drain, waste or vent) piping systems or SDR13.5 chlorinated polyvinyl chloride (CPVC) pipe for use in closed (process or supply) piping systems. One pipe is centered within the firestop system. The annular space between the pipe and the edge of the through opening on each side of the wall shall be min 0 in. (0 mm, point contact) to max 1/4 in. (6 mm). When nom 3-1/2 or 4 in. (89 or 102 mm) diam pipe is used, T Rating is 0 hr. When nom 3 in. (76 mm) diam (or smaller) pipe is used, the T Rating is 2 hr.
- Firestop System** – Installed symmetrically on both sides of wall assembly. The details of the firestop system shall be as follows.
 - Fill, Void or Cavity Materials* – Wrap Strip** – Nom 1/4 in. (6 mm) thick intumescent elastomeric material faced on one side with aluminum foil, supplied in 1 in. (25 mm) wide strips. Nom 1 in. (25 mm) wide strips tightly wrapped around nonmetallic pipe (foil side exposed) with the edges butted against the surface of the wall. Sufficient layers of wrap strip shall be installed to lap a min of 3/16 in. (5 mm) on the wall surface around the entire perimeter of the circular through opening. For nom 1/2 in. (13 mm) to nom 2 in. (51 mm) diam pipes, a min of one layer of wrap strip is required. For nom 2-1/2 in. (64 mm) and nom 3 in. (76 mm) diam pipes, a min of two layers of wrap strip is required. For nom 3-1/2 in. (89 mm) and nom 4 in. (102 mm) diam pipes, a min of three layers of wrap strip is required. Each layer of wrap strip to be installed with a butted seam, with butted seams in successive layers staggered. Wrap strip layers temporarily held in position using aluminum foil tape, steel wire tie or equivalent.
3M COMPANY – FS-195+
 - Steel Collar** – Nom 1 in. (25 mm) deep collar with 1-1/4 in. (32 mm) wide by 2 in. (51 mm) long anchor tabs and min 3/4 in. (19 mm) long tabs to retain wrap strip layers. Coils of precut 0.016 in. (0.41 mm) thick (No. 30 28 gauge) galv sheet steel available from wrap strip manufacturer. Steel collar, with anchor tabs bent outward 90 degree, wrapped tightly around wrap strip layers with min 1 in. (25 mm) overlap at the seam. With steel collar anchor tabs pressed tightly against wall surface, compress collar around wrap strip layers using a min 1/2 in. (13 mm) wide by 0.028 in. (0.71 mm) thick stainless steel band clamp with worm drive tightening mechanism at the collar midheight. Secure collar to wall surface with min 3/16 in. (5 mm) diam by min 1-1/4 in. (32 mm) long steel anchor bolts in conjunction with min 1-1/4 in. (32 mm) diam steel washers. Three bolts, symmetrically located, required for nom 1/2 in. (13 mm) to nom 3 in. (76 mm) diam pipes. Four bolts, symmetrically located, required for nom 3-1/2 and 4 in. (76 and 102 mm) diam pipes. As a final step, bend retainer tabs 90 degree toward pipe to lock wrap strip layers in position.
 - Fill, Void or Cavity Materials* – Caulk or Sealant** – (Not Shown) – Generous bead of caulk applied to outer perimeter of wrap strip at interface with wall surface and to perimeter of pipe or conduit at its egress from the wrap strip layers.
3M COMPANY – Type CP 25WB+, IC 15WB+, FireDam 150+ caulk or FB-3000 WT sealant.
(Note: CP 25WB+ and FireDam 150+ not suitable for use with CPVC pipes.)
 - Firestop Device*** – (Not Shown) – As an alternate to Item A and B when nom 1-1/2, 2, 3 or 4 in. (38, 51, 76 and 102 mm) diam nonmetallic pipes are used, a firestop device consisting of a sheet-steel split collar lined with intumescent material and provided with steel clips for attachment may be used. Firestop device to be installed on underside of top plate or on both sides of wall in accordance with the accompanying installation instructions.
3M COMPANY – PPD 150, PPD 200, PPD 300, PPD400, PPD 1.5, PPD 2, PPD 3, PPD 4.

*Bearing the UL Classification Mark

Reprinted from the Online Certifications Directory with permission from Underwriters Laboratories Inc.
Copyright © 2010 Underwriters Laboratories Inc.®



Note: Systems with Nonmetallic Through Penetrant(s) have not been evaluated with a pressure differential of 50 Pa between the exposed and unexposed surfaces as required by the National Building Code of Canada.

System No. W-J-2029

May 19, 2005

F Ratings – 1 and 2 Hr (See Item 2)

T Ratings – 0, 1 and 2 Hr (See Item 2)

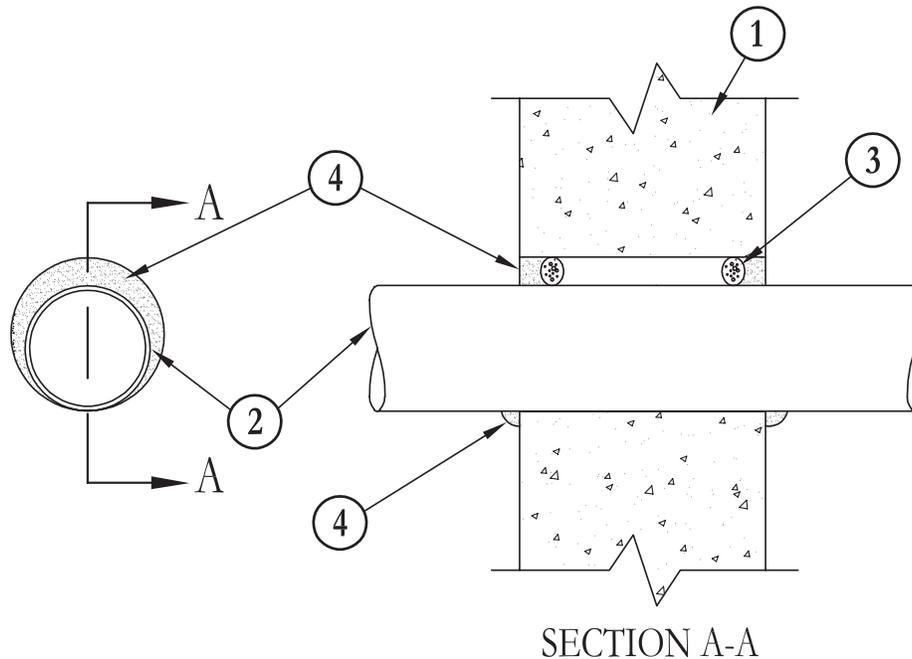

- Wall Assembly** – Min 4-1/2 in. (114 mm) thick lightweight or normal weight (100-150 pcf or 1600-2400 kg/m³) concrete. Wall may also be constructed of any UL Classified **Concrete Blocks***. Diam of opening shall be 7/8 in. to 1 in. (22 mm to 25 mm) larger than the outside diam of nonmetallic pipe or conduit (Item 2).

See **Concrete Blocks** (CAZT) category in the Fire Resistance Directory for names of manufacturers.

- Through Penetrants** – One nonmetallic pipe or conduit to be centered within the firestop system. The annular space for nom 1-1/4 in. (32 mm) diam and smaller between the pipe or conduit and periphery of opening shall be min 0 in. (point contact) to max 7/8 in. (0 mm to max 22 mm). The annular space for pipe or conduit greater than nom 1-1/4 in. (32 mm) diam between the pipe or conduit and periphery of opening shall be min 1/2 in. to max 1 in. (13 mm to 25 mm). Pipe or conduit to be rigidly supported on both sides of wall assembly. The following types and sizes of nonmetallic pipes or conduits may be used:
 - Polyvinyl Chloride (PVC) Pipe** – Nom 2 in. (51 mm) diam (or smaller) Schedule 40 solid core PVC pipe for use in closed (process or supply) or vented (drain, waste or vent) piping system.
 - Polyvinyl Chloride (PVC) Pipe** – Nom 3 in. (76 mm) diam (or smaller) Schedule 40 solid core PVC pipe for use in closed (process or supply) piping system.
 - Chlorinated Polyvinyl Chloride (CPVC) Pipe** – Nom 3 in. (76 mm) diam (or smaller) SDR11 CPVC pipe for use in closed (process or supply) piping systems.
 - Rigid Nonmetallic Conduit**++ – Nom 3 in. (76 mm) diam (or smaller) Schedule 40 PVC conduit installed in accordance with the National Electrical Code (NFPA No. 70).
 - Electrical Nonmetallic Tubing (ENT)**++ – Nom 1 in. (25 mm) diam (or smaller) ENT formed of PVC, installed in accordance with the National Electrical Code (NFPA No. 70).
 - Acrylonitrile Butadiene Styrene (ABS) Pipe** – Nom 2 in. (51 mm) diam (or smaller) Schedule 40 solid core or cellular core ABS pipe for use in closed (process or supply) or vented (drain, waste or vent) piping system.

See **Rigid Nonmetallic Conduit** (DZKT), **Electrical Nonmetallic Tubing** (FKHU) in UL Construction Materials Directory for names of manufacturers.

The hourly T Rating is dependent on the hourly rating of the wall assembly, the pipe or conduit size and whether the pipe is intended for use as a closed or vented system, as shown in the following table:

| Nom Pipe Diam In. (mm) | Wall Assembly Rating Hr | Closed (c) or Vented (v) | T Rating Hr |
|-------------------------|-------------------------|--------------------------|-------------|
| 1/2 to 3 (13 to 76) | 1 | c | 1 |
| 1/2 to 1-1/4 (13 to 32) | 1 | v | 1 |
| 1/2 to 1-1/4 (13 to 32) | 2 | c | 2 |
| 1/2 to 1-1/4 (13 to 32) | 2 | v | 1 |
| 2 (51) | 1 | v | 0 |
| 2 (51) | 2 | v | 0 |

System No. W-J-2029 continued

3. **Packing Material** (Optional) – Mineral wool or fiberglass insulation or polyethylene backer rod firmly packed into opening as a permanent form. Packing material to be recessed from both surfaces of wall as required to accommodate the required thickness of caulk fill material.
4. **Fill, Void or Cavity Materials* – Caulk, Sealant or Putty** – Min thickness of 5/8 in. and 1-1/4 in. (16 mm to max 32 mm) of caulk or putty for 1 and 2 hr rated wall assemblies, respectively, applied within annulus between pipe or conduit and periphery of the opening, flush with both surfaces of wall assembly. At the point contact location between pipe or conduit and wall, a min 1/2 in. (13 mm) diam bead of caulk or putty shall be applied at the pipe or conduit/wall interface on both surfaces of wall assembly.

3M COMPANY – CP 25WB+, IC 15WB+ caulk, FB-3000 WT sealant or MP+ Stix putty
(Note: CP 25WB+ not suitable for use with CPVC pipes.)

++Bearing the UL Listing Mark.

*Bearing the UL Classification Marking

Reprinted from the Online Certifications Directory with permission from Underwriters Laboratories Inc.
Copyright © 2010 Underwriters Laboratories Inc.®



Note: Systems with Nonmetallic Through Penetrant(s) have not been evaluated with a pressure differential of 50 Pa between the exposed and unexposed surfaces as required by the National Building Code of Canada.

Through Penetrations

Non-Metallic Pipes

2000 Series

Concrete

WJ

System No. W-J-2109

May 19, 2005
 F Rating – 2 Hr
 T Rating – 0 Hr

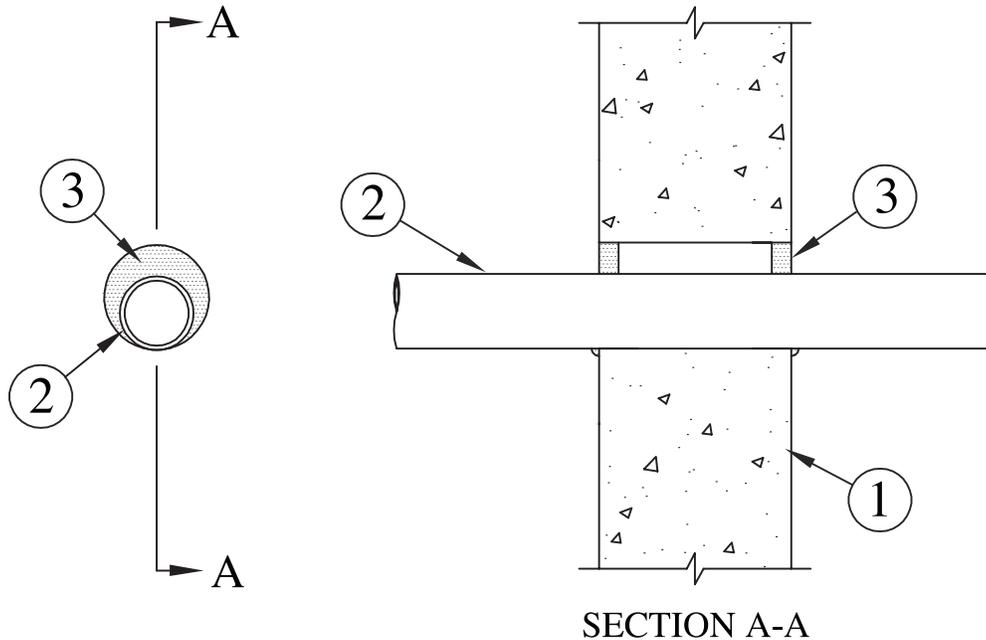

1. **Wall Assembly** – Min 6 in. (152 mm) thick reinforced lightweight or normal weight (100-150 pcf or 1600-2400 kg/m³) concrete wall. Wall may also be constructed of any UL Classified **Concrete Blocks***. Max diam of opening is 3-1/2 in. (89 mm).
 See **Concrete Blocks** (CAZT) category in the Fire Resistance Directory for names of manufacturers.
2. **Through Penetrants** – One nonmetallic pipe or conduit installed eccentrically or concentrically within opening. Annular space between penetrant and periphery of opening to be min 0 in. (point contact) to max 1-1/8 in. (0 mm to max 29 mm). Penetrant to be rigidly supported on both sides of wall. The following types and sizes of penetrants may be used:
 - A. **Polyvinyl Chloride (PVC) Pipe** – Nom 2 in. (51 mm) diam (or smaller) Schedule 40 solid core or cellular core PVC pipe for use in closed (process or supply) or vented (drain, waste or vent) piping system.
 - B. **Chlorinated Polyvinyl Chloride (CPVC) Pipe** – Nom 2 in. (51 mm) diam (or smaller) SDR13.5 CPVC pipe for use in closed (process or supply) piping systems.
 - C. **Rigid Nonmetallic Conduit+** – Nom 2 in. (51 mm) diam (or smaller) Schedule 40 PVC conduit installed in accordance with Article 347 of the National Electrical Code (NFPA No. 70).
 - D. **Acrylonitrile Butadiene Styrene (ABS) Pipe** – Nom 1-1/2 in. (38 mm) diam (or smaller) Schedule 40 solid core or cellular core ABS pipe for use in closed (process or supply) or vented (drain, waste or vent) piping systems.
 - E. **Electrical Nonmetallic Tubing (ENT)+** – Nom 1-1/4 in (32 mm) diam (or smaller) ENT installed in accordance with Article 331 of the National Electrical Code (NFPA No. 70).
 See **Electrical Nonmetallic Tubing** (FKHU) category in the Electrical Construction Materials Directory for names of manufacturers.
3. **Fill, Void or Cavity Material* – Caulk or Sealant** – Min 5/8 in. (16 mm) thickness of caulk applied within annulus, flush with both surfaces of wall. Min 1/4 in. (6 mm) diam bead of caulk applied to penetrant/wall interface at the point contact location on both sides of wall.
3M COMPANY – IC 15WB+, CP 25WB+ caulk or FB-3000 WT sealant
 (Note: CP 25WB+ not suitable for use with CPVC pipes.)

*Bearing the UL Classification Marking

Reprinted from the Online Certifications Directory with permission from Underwriters Laboratories Inc.
 Copyright © 2011 Underwriters Laboratories Inc.®

System No. W-J-2110

May 19, 2005
F Rating – 2 Hr
T Rating – 1/2 Hr

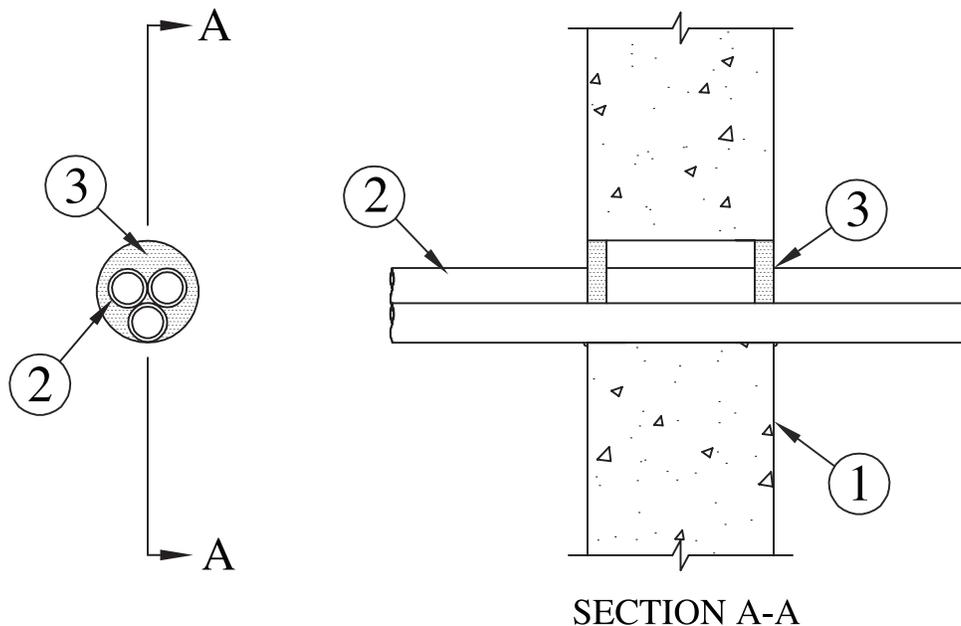

- Wall Assembly** – Min 6 in. (152 mm) thick reinforced lightweight or normal weight (100-150 pcf or 1600-2400 kg/m³) concrete wall. Wall may also be constructed of any UL Classified **Concrete Blocks***. Max diam of opening is 4 in. (102 mm).
See **Concrete Blocks (CAZT)** category in the Fire Resistance Directory for names of manufacturers.
- Through Penetrants** – One or more nonmetallic pipes, conduits or tubes installed concentrically or eccentrically within opening. Annular space between penetrants and periphery of opening to be min 0 in. (point contact) to max 1 in. (0 mm to max 25 mm). Space between penetrants shall be min 0 in. (point contact) to max 1 in. (0 mm to max 25 mm). Penetrants to be rigidly supported on both sides of wall. The following types and sizes of penetrants may be used:
 - Polyvinyl Chloride (PVC) Pipe** – Nom 1-1/2 in. (38 mm) diam (or smaller) Schedule 40 solid or cellular core PVC pipe for use in closed (process or supply) or vented (drain, waste or vent) piping systems.
 - Rigid Nonmetallic Conduit++** – Nom 1-1/2 in. (38 mm) diam (or smaller) Schedule 40 PVC conduit installed in accordance with Article 347 of the National Electrical Code (NFPA No. 70).
 - Chlorinated Polyvinyl Chloride (CPVC) Pipe** – Nom 1-1/2 in. (38 mm) diam (or smaller) SDR13.5 CPVC pipe for use in closed (process or supply) piping systems.
 - Crosslinked Polyethylene (PEX) Tubing** – Nom 1 in. (25 mm) diam (or smaller) SDR 9 PEX tubing for use in closed (process or supply) or vented (drain, waste or vent) piping systems.
- Fill, Void or Cavity Material* – Caulk or Sealant** – Min 5/8 in. (16 mm) thickness of caulk applied within annulus, flush with both surfaces of wall. Min 1/4 in. (6 mm) diam bead of caulk applied to penetrant/wall interface at point contact location on both sides of wall.
3M COMPANY – IC 15WB+, CP 25WB+ caulk or FB-3000 WT sealant
(Note: CP 25WB+ not suitable for use with CPVC pipes.)

*Bearing the UL Classification Marking

Reprinted from the Online Certifications Directory with permission from Underwriters Laboratories Inc.
Copyright © 2011 Underwriters Laboratories Inc.®

Through Penetrations

Non-Metallic Pipes

2000 Series

Concrete

WJ

System No. W-J-2152

May 19, 2005

F Rating – 2 Hr

T Rating – 2 Hr

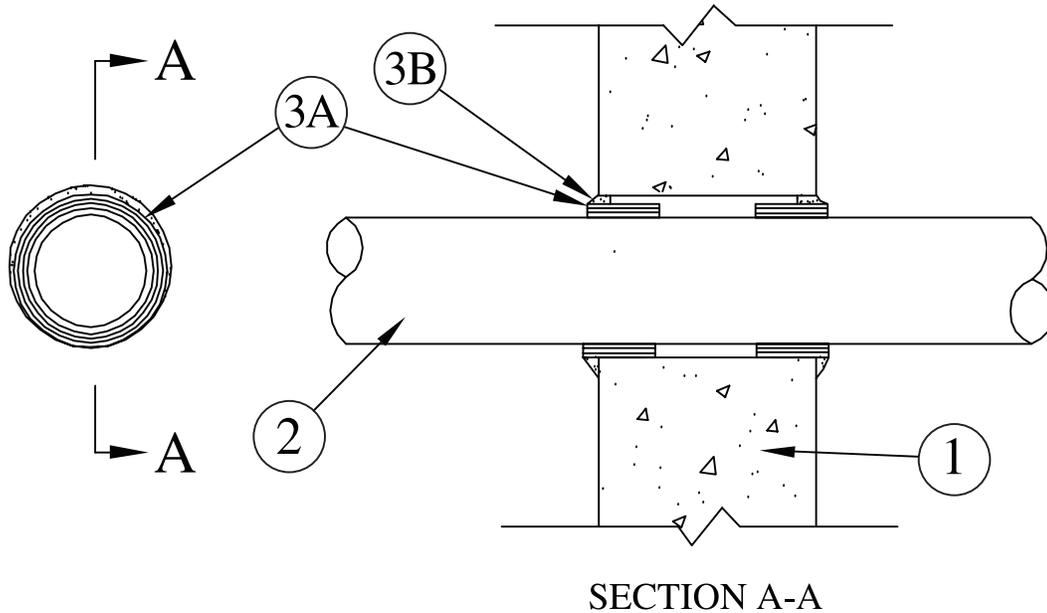

1. **Wall Assembly** – Min 6 in. (152 mm) thick reinforced lightweight or normal weight (100-150 pcf or 1600-2400 kg/m³) concrete wall. Wall may also be constructed of any UL Classified Concrete Blocks*. Max diam of opening is 4-1/2 in. (114 mm).
See **Concrete Blocks** (CAZT) category in the Fire Resistance Directory for names of manufacturers.
2. **Through Penetrants** – One nonmetallic pipe or conduit concentrically or eccentrically within the firestop system. The annular space between penetrant and sleeve shall be min 3/8 in. (10 mm) to max 5/8 in. (16 mm). Penetrant to be rigidly supported on both sides of wall assembly. The following types and sizes of nonmetallic pipes or conduits:
 - A. **Polyvinyl Chloride (PVC) Pipe** – Nom 3 in. (76 mm) diam (or smaller) Schedule 40 solid core or cellular core PVC pipe for use in closed (process or supply) or vented (drain, waste or vent) piping systems.
 - B. **Rigid Nonmetallic Conduit++** – Nom 3 in. (76 mm) diam (or smaller) Schedule 40 PVC conduit installed in accordance with Article 347 of the National Electrical Code (NFPA No. 70).
 - C. **Chlorinated Polyvinyl Chloride (CPVC) Pipe** – Nom 3 in. (76 mm) diam (or smaller) SDR13.5 CPVC pipe for use in closed (process or supply) piping systems.
 - D. **Acrylonitrile Butadiene Styrene (ABS) Pipe** – Nom 3 in. (76 mm) diam (or smaller) Schedule 40 solid core or cellular core ABS pipe for use in closed (process or supply) or vented (drain, waste or vent) piping systems.
3. **Firestop System** – The firestop system shall consist of the following:
 - A. **Fill, Void or Cavity Materials*** – Wrap Strip – Nom 1/8 in. (3.2 mm) thick intumescent material supplied in 2 in. (51 mm) wide strips. Min three layers of wrap strip tightly wrapped around nonmetallic pipe and completely wrapped with min 3 mil foil tape. Wrap strip to be slid into opening such that the outer edge of wrap strip extends approx 1/2 in. (13 mm) from both surfaces of wall.
3M COMPANY – Ultra GS
 - B. **Fill, Void or Cavity Material* – Caulk or Sealant** – Min 5/8 in. (16 mm) thickness of caulk applied within annulus, flush with both surfaces of wall. Min 1/2 in. (13 mm) diam bead of caulk applied to concrete/wrap strip interface at point contact location on both sides of wall.
3M COMPANY – IC 15WB+, CP 25WB+ caulk or FB-3000 WT sealant
(Note: CP 25WB+ not suitable for use with CPVC pipes.)

*Bearing the UL Classification Marking

Reprinted from the Online Certifications Directory with permission from Underwriters Laboratories Inc.

Copyright © 2011 Underwriters Laboratories Inc.®

System No. W-J-2231

August 04, 2009
F Rating – 2 Hr
T Rating – 1-3/4 Hr

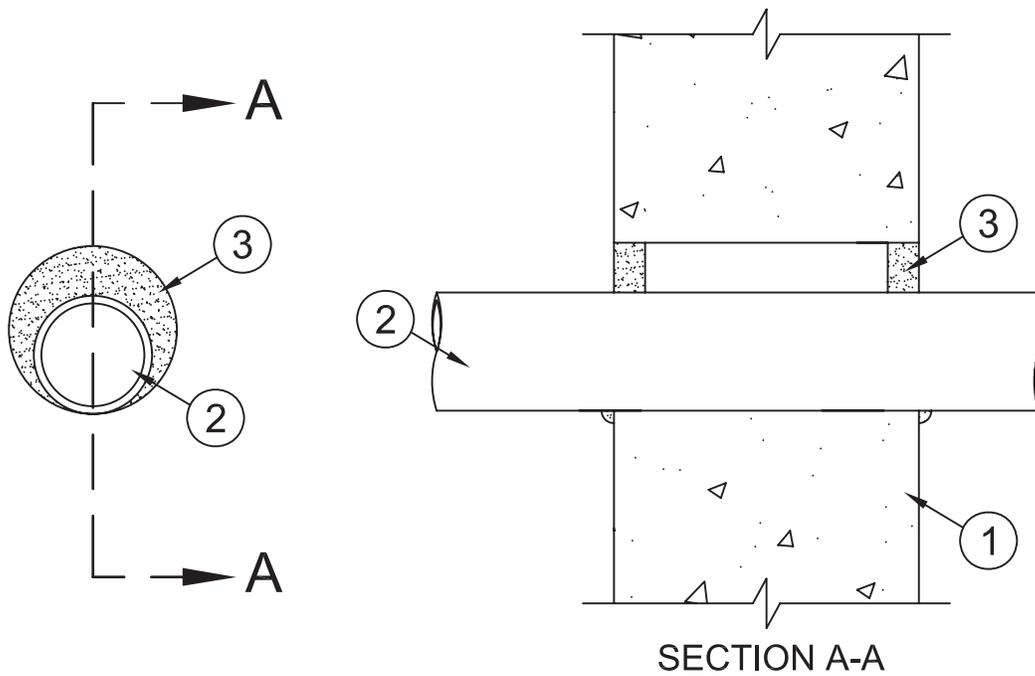

1. **Wall Assembly** – Min 6 in. (152 mm) thick lightweight or normal weight (100-150 pcf or 1600 - 2400 kg/m³) concrete. Wall may also be constructed of any UL Classified **Concrete Blocks***. Diam of opening shall be 1-1/2 in. (38 mm) larger than the outside diam of tubing (Item 2).
See **Concrete Blocks** (CAZT) category in the Fire Resistance Directory for names of manufacturers.
2. **Crosslink Polyethylene (PEX) Tubing** – Nom 2 in. (51 mm) diam (or smaller) SDR 9 PEX tubing for use in closed (process or supply) piping system. Tubing installed concentrically or eccentrically within opening. Annular space between tubing and edge of opening to be min 0 in. to max 1-1/2 in. (38 mm). Tubing to be rigidly supported on both sides of wall assembly.
3. **Fill, Void or Cavity Materials*** – **Caulk or Sealant** – Min 5/8 in. (16 mm) thickness of fill material applied within the annulus, flush with both surfaces of wall assembly. An additional min 1/2 in. (13 mm) bead of fill material applied at the tubing/gypsum board interface at point contact location on both surfaces of wall assembly.

3M COMPANY

3M FIRE PROTECTION PRODUCTS – CP 25WB+, IC 15WB+ or FB-3000 WT

*Bearing the UL Classification Mark

Reprinted from the Online Certifications Directory with permission from Underwriters Laboratories Inc.
Copyright © 2010 Underwriters Laboratories Inc.®

System No. W-J-2248

August 16, 2012

ANSI/UL1479 (ASTM E814)

F Rating – 2 Hr

T Rating – 2 Hr

CAN/ULC S115

F Rating – 2 Hr

FT Rating – 2 Hr

FH Rating – 2 Hr

FTH Rating – 2 Hr

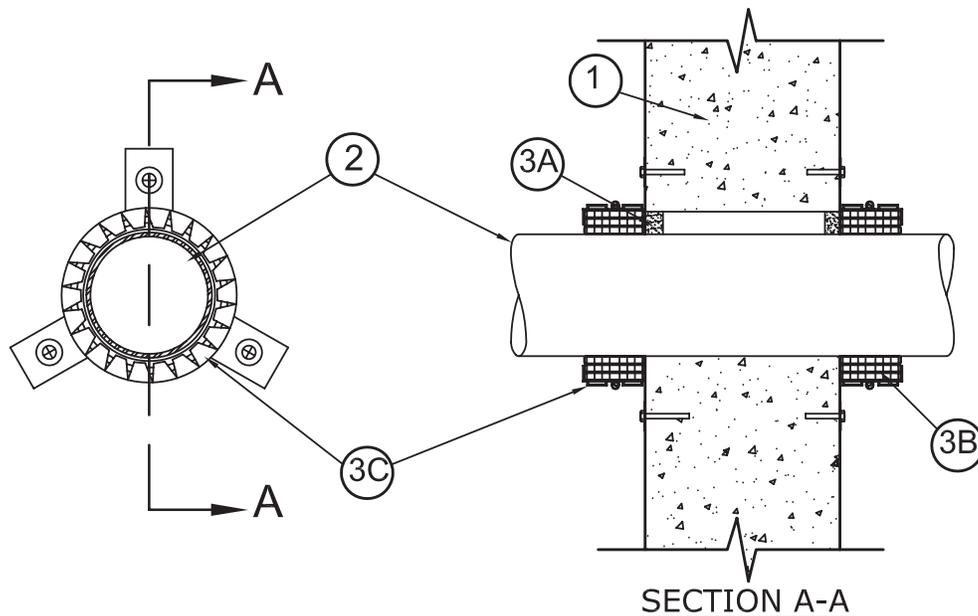

System tested with a pressure differential of 2.5 Pa between the exposed and the unexposed surfaces with the higher pressure on the exposed side.

1. **Wall Assembly** – Min 6 in. (152 mm) thick lightweight or normal weight (100-150 pcf or 1600 - 2400 kg/m³) concrete. Wall may also be constructed of any UL Classified **Concrete Blocks***. Diam of opening shall be 1-1/2 in. (38 mm) larger than the outside diam of tubing (Item 2).

See **Concrete Blocks (CAZT)** category in the Fire Resistance Directory for names of manufacturers.

2. **Through Penetrant** – One nonmetallic pipe to be installed concentrically or eccentrically within the firestop system. The annular space between the penetrant and the periphery of opening shall be min 1/4 in. (6 mm) to max 1 in. (25 mm). Penetrant to be rigidly supported on both sides of wall assembly. The following types and sizes of nonmetallic pipe may be used:

- A. **Polypropylene (PP) Pipe** – Nom 3 in. (76 mm) diam (or smaller) Aquatherm Fusiotherm SDR 7.4 PP pipe for use in closed (process or supply) or vented (drain, waste or vent) piping systems.
- B. **Polypropylene (PP) Pipe** – Nom 3 in. (76 mm) diam (or smaller) Aquatherm Climatherm SDR 11 PP pipe for use in closed (process or supply) or vented (drain, waste or vent) piping systems.

3. **Firestop System** – The firestop system shall consist of the following:

- A. **Fill, Void or Cavity Material* – Caulk or Sealant** – Min 1/4 in. (6 mm) thickness of fill material applied within the annular space, flush with both surfaces of wall.

3M COMPANY

3M FIRE PROTECTION PRODUCTS – IC 15WB+ caulk, CP 25WB+ caulk or FB-3000 WT sealant

- B. **Fill, Void or Cavity Materials* – Wrap Strip** – Nom 1/8 in. (3.2 mm) thick intumescent material supplied in 2 in. (51 mm) wide strips. Min three layers of wrap strip tightly wrapped around nonmetallic pipe with continuous layers and butted tightly against both surfaces of the wall. Wrap strip layers temporarily held in position using aluminum filament tape, foil tape, steel wire tie, or equivalent.

3M COMPANY

3M FIRE PROTECTION PRODUCTS – Ultra GS

- C. **Steel Collar** – Nom 2 in. (51 mm) deep collar with 1-1/4 in. (32 mm) wide by 2 in. (51 mm) long anchor tabs and min 1/2 in. (13 mm) long tabs to retain wrap strip layers. Coils of precut 0.016 in. (.41 mm) thick (28 gauge) galv sheet steel available from wrap strip manufacturer. Steel collar, with anchor tabs bent outward 90 degrees, wrapped tightly around wrap strip layers with min 1 in. (25 mm) overlap at seam. Anchor tabs to be pressed tightly against wall surfaces, and collar to be compressed around wrap strip layers using a min 1/2 in. (13 mm) wide by 0.028 in. (0.71 mm) thick stainless steel band clamp at the middle of collar. Collar to be secured to wall surfaces with min 1-1/4 in. (32 mm) long, min 3/16 in. (5 mm) diam steel masonry anchors in conjunction with steel nuts and min 1 in. (25 mm) diam steel washers. Min three anchors, symmetrically located.

*Bearing the UL Classification Mark

Reprinted from the Online Certifications Directory with permission from UL

© 2013 UL LLC





UL System No. W-J-2253
XHEZ – Through-penetration Firestop Systems
XHEZ7 – Through-penetration Firestop Systems Certified for Canada

January 24, 2017

| ANSI/UL1479 (ASTM E814) | CAN/ULC S115 |
|-------------------------|-------------------|
| F Rating – 2 Hr | F Rating – 2 Hr |
| T Rating – 2 Hr | FT Rating – 2 Hr |
| | FH Rating – 2 Hr |
| | FTH Rating – 2 Hr |

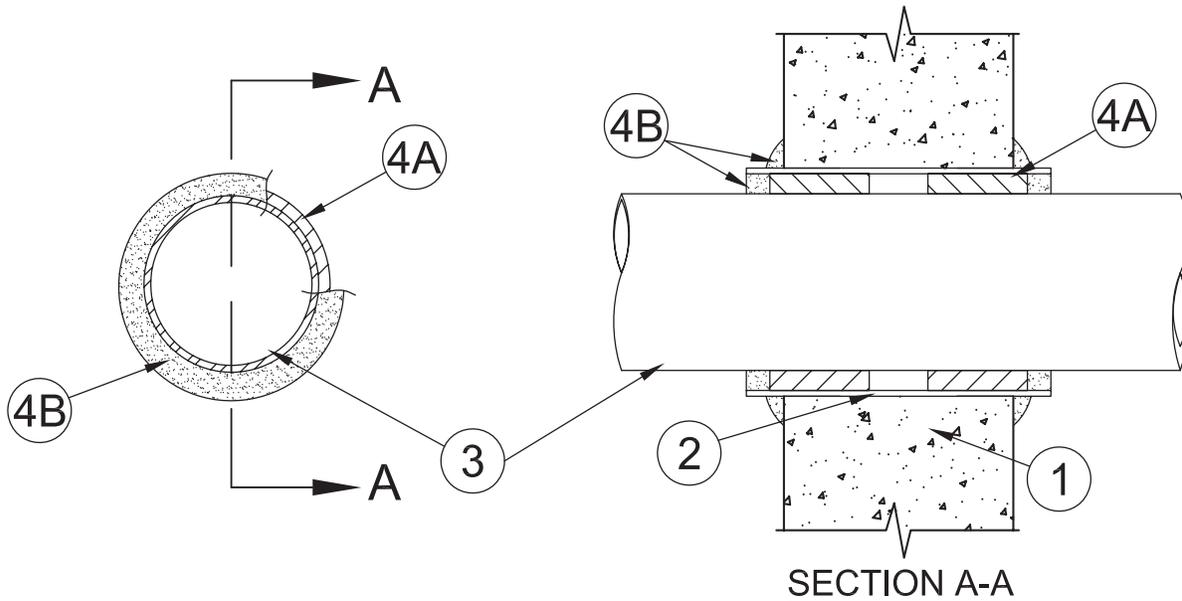

System tested with a pressure differential of 50 Pa between the exposed and the unexposed surfaces with the higher pressure on the exposed side.

- 1. Wall Assembly** – Min 6 in. (152 mm) thick reinforced lightweight or normal weight (100-150 pcf or 1600-2400 kg/m³) concrete. Wall may also be constructed of any UL Classified Concrete Blocks*. Max diam of opening is 5-1/2 in. (140 mm).
See **Concrete Blocks** (CAZT) in the Fire Resistance Directory for names of manufacturers.
 - 2. Sleeve** – Cylindrical sleeve fabricated from min 28 ga galv sheet steel and having a min 1 in. (25 mm) lap along the longitudinal seam friction fit into wall opening, extending nom 1 in. (25 mm) beyond both wall surfaces.
 - 3. Through Penetrants** – One nonmetallic pipe or conduit installed concentrically within the firestop system. The annular space between penetrant and periphery of opening shall be nom 1/2 in. (13 mm). Penetrant to be rigidly supported on both sides of wall assembly. The following types and sizes of nonmetallic pipes or conduits:
 - A. Polyvinyl Chloride (PVC) Pipe** – Nom 2 in. (51 mm) diam (or smaller) Schedule 40 solid core PVC pipe for use in closed (process or supply) or vented (drain, waste or vent) piping systems.
 - B. Chlorinated Polyvinyl Chloride (CPVC) Pipe** – Nom 2 in. (51 mm) diam (or smaller) SDR13.5 CPVC pipe for use in closed (process or supply) or vented (drain, waste or vent) piping systems.
 - C. Polyvinylidene Fluoride (PVDF) Pipe** – Nom 4 in. (102 mm) diam (or smaller) Schedule 40 PVDF pipe for use in closed (process or supply) or vented (drain, waste or vent) piping systems.
 - D. Rigid Nonmetallic Conduit+** – Nom 2 in. (51 mm) diam (or smaller) Schedule 40 PVC conduit installed in accordance with the National Electrical Code (NFPA No. 70).
 - 4. Firestop System** – The firestop system shall consist of the following:
 - A. Fill, Void or Cavity Materials* - Wrap Strip** – Min 3/16 in. (5 mm) thick intumescent material supplied in 2-1/2 in. (64 mm) wide strips. Single layer of pre-cut wrap strip tightly wrapped around nonmetallic pipe and secured with the adhesive closure tab. Wrap strip to be slid into sleeved opening at both sides of wall such that the outer edge of wrap strip is recessed 1/2 in. (13 mm) from both ends of sleeve.
- 3M COMPANY 3M FIRE PROTECTION PRODUCTS** – Tuck-In Wrap Strip

UL System No. W-J-2253 (cont.)

B. Fill, Void or Cavity Material* – Min 1/2 in. (13 mm) thickness of sealant applied within annulus flush with both ends of sleeve. Min 1/4 in. (6 mm) diam bead of sealant applied to wall/sleeve interface on both sides of wall.

3M COMPANY 3M FIRE PROTECTION PRODUCTS – IC 15WB+, Fire Barrier CP 25WB+ or 3000WT sealant

C. Foil Tape (Not Shown) – Required only when CPVC penetrant (Item 3B) is used. Nom 4 in. (102 mm) wide, 3 mil thick aluminum tape installed around pipe prior to installation of wrap strip. Foil tape is to be positioned such that it will be centered under the wrap strip material with adhesive side out.

Through Penetrations

Non-Metallic Pipes

2000 Series

WJ



*Indicates such products shall bear the UL or cUL Certification Mark for jurisdictions employing the UL or cUL Certification (such as Canada), respectively.

Reprinted from the Online Certifications Directory with permission from UL©

3M Industrial Adhesive and Tapes
Fire Protection Products
3M Center, Building 230-B-S-37
St. Paul, MN 55144-1000

System No. W-J-2256

January 30, 2014

F Rating — 2 Hr

T Rating — 1/2 Hr

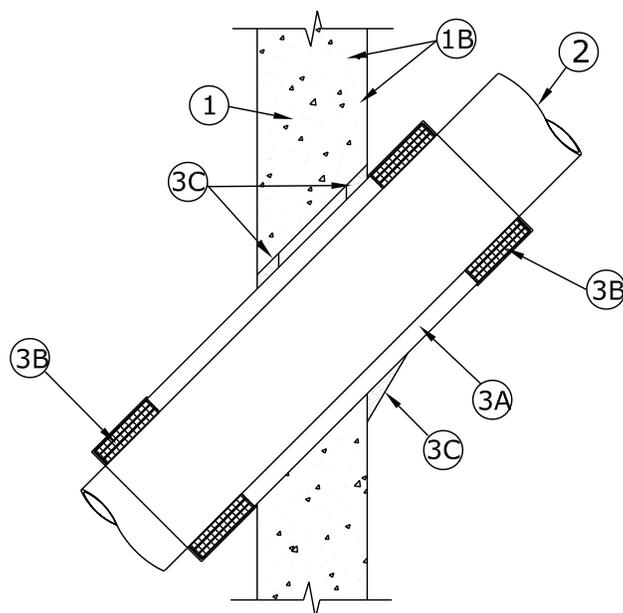

- Wall Assembly** – Min 4-1/2 in. (114 mm) thick reinforced lightweight or normal weight (100-150 pcf) (1600-2400 kg/m³) concrete. Wall may also be constructed of any UL Classified **Concrete Blocks***. Max diam of opening is 6-5/8 in. (168 mm).
See **Concrete Blocks (CAZT)** in the Fire Resistance Directory for names of manufacturers.
- Through Penetrants** – One nonmetallic pipe or conduit to be centered within the firestop system. Pipe or conduit to be rigidly supported on both sides of floor or wall assembly. The pipe or conduit may be installed at an angle not greater than 45 degrees from perpendicular. The following types and sizes of nonmetallic pipes or conduits may be used:
 - Polyvinyl Chloride (PVC) Pipe** – Nom 4 in. (102 mm) diam (or smaller) Schedule 40 solid core or cellular core polyvinyl chloride (PVC) pipe for use in closed (process or supply) or vented (drain, waste or vent) piping systems.
 - Chlorinated Polyvinyl Chloride (CPVC) Pipe** – Nom 4 in. (102 mm) diam (or smaller) SDR13.5 chlorinated polyvinyl chloride (CPVC) pipe for use in closed (process or supply) piping systems.
 - Acrylonitrile Butadiene Styrene (ABS) Pipe** – Nom 4 in. (102 mm) diam (or smaller) Schedule 40 (or heavier) solid core or cellular core acrylonitrile butadiene styrene (ABS) pipe for use in closed (process or supply) or vented (drain, waste or vent) piping systems.
- Firestop System** – The firestop system shall consist of the following:
 - Metallic Sleeve** – Cylindrical sleeve fabricated from min 0.019 in. (0.48 mm) thick (26 gauge) galv sheet steel and having a min 1 in. (25 mm) lap along the longitudinal seam. Sleeve to extend a min of 2 in. (51 mm) beyond both sides of the wall. Length of sleeve to be min 4 in. (102 mm) plus the thickness of the wall. The inside diam of the sleeve shall be larger than outside diam of nonmetallic pipe or conduit such that an annular space will be present between the steel sleeve and the pipe around the entire circumference of the pipe to accommodate the layer(s) of wrap strips (Item 3B). The annular space between the outside of the wrap strip layer(s) and the inside of the sleeve shall be min 0 in. (0 mm, point contact) to max 1/4 in. (6 mm). The annular space between the outside of the sleeve and the periphery of the opening shall be min 0 in. (0 mm, point contact) to max 1/2 in. (13 mm).
 - Fill, Void or Cavity Materials* – Wrap Strip** – Nom 1/4 in. (6 mm) thick intumescent elastomeric material faced on one side with aluminum foil, supplied in 2 in. (51 mm) wide strips. Nom 2 in. (51 mm) wide strips tightly wrapped around nonmetallic pipe (foil side exposed) and slid into sleeve on both sides of wall such that the outer edges of wrap strips are flush with the outer edges of the sleeve. For nom 1/2 in. (13 mm) to nom 1-1/2 in. (38 mm) diam pipes, a min of one layer of wrap strip is required. For nom 2 in., 2-1/2 in. and 3 in. (51 mm, 64 mm and 76 mm) diam pipes, a min of two layers of wrap strip is required. For nom 3-1/2 in. and 4 in. (89 and 102 mm) diam pipes, a min of three layers of wrap strip is required. Each layer of wrap strip to be installed with butted seam with butted seams in successive layers staggered. Wrap strip layers held in position using aluminum foil tape, steel wire tie, or equivalent. A min 1/2 in. (13 mm) wide stainless steel hose clamp shall be secured around the outside of the sleeve over the center of the wrap strips on both ends of the sleeve.
3M COMPANY – Type FS-195+.
 - Fill, Void or Cavity Materials* – Caulk or Sealant** – Min thickness of 1-1/4 in. (32 mm), applied within annulus between metallic sleeve and periphery of the opening, flush with both surfaces of wall assembly. At the point contact location between sleeve and wall surface, a min 1/2 in. (13 mm) diam bead of caulk shall be applied at the sleeve/wall interface on both surfaces of wall assembly. A min 1/4 in. (6 mm) bead of caulk shall also be applied over the outer edges of the wrap strips and within the annular space between the wrap strip and sleeve on both sides of wall.
3M COMPANY – Type CP 25WB+, IC 15WB+, FireDam 150+ caulk or FB-3000 WT sealant. (Note: CP 25WB+ and FireDam 150+ not suitable for use with CPVC pipes.)

*Bearing the UL Classification Mark

Reprinted from the Online Certifications Directory with permission from UL
© 2014 UL LLC



3M Fire Protection Products



UL System No. W-J-2305
XHEZ – Through-penetration Firestop Systems

January 24, 2017

F Rating – 2 Hr

T Rating – 2 Hr

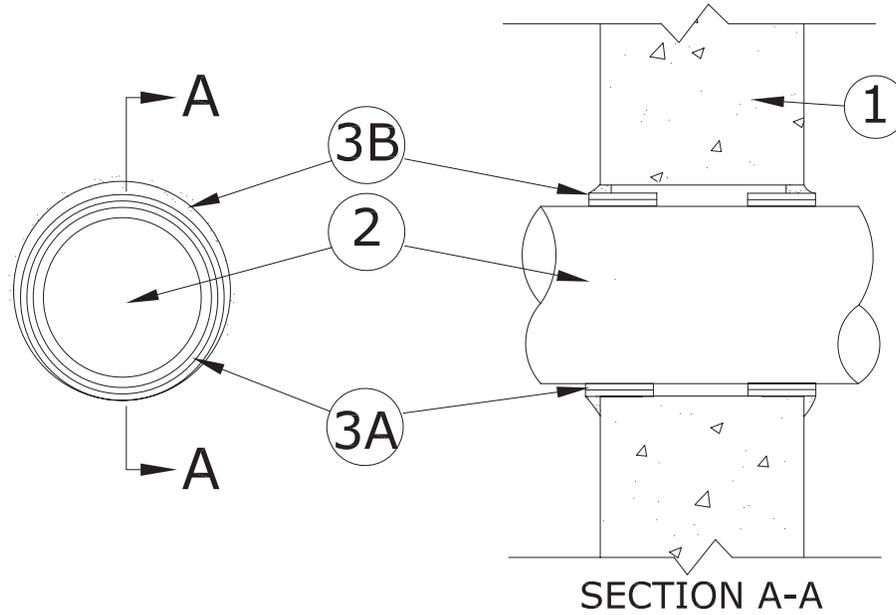

1. **Wall Assembly** – Min 6 in. (152 mm) thick lightweight or normal weight (100-150 pcf or 1600-2400 kg/m³) concrete. Wall may also be constructed of any UL Classified solid filled **Concrete Blocks***. Maximum diam of opening is 9 in. (229 mm).
See **Concrete Blocks** (CAZT) in the Fire Resistance Directory for names of manufacturers.
2. **Through Penetrants** – One nonmetallic pipe to be installed either concentrically or eccentrically within the firestop system. The annular space between pipe and the periphery of opening shall be min 3/8 in. (9.5 mm) to a max 3/4 in. (19 mm). The following types and sizes of nonmetallic pipes may be used:
 - A. **Polypropylene (PP) Pipe** – Nom 8 in. (200 mm OD) or nom 6 in. (160 mm OD) diam Orion Polystar™ PP-RCT (CT-White) SDR 17 PP pipe for use in closed (process or supply) piping systems.
3. **Firestop System** – The firestop system shall consist of the following:
 - A. **Fill, Void or Cavity Materials* – Wrap Strip** – Min 3/16 in. (5 mm) thick intumescent material supplied in 2-1/2 in. (64 mm) wide strips. Two layers of wrap strip are tightly wrapped around the nonmetallic pipe and secured with aluminum foil tape. Wrap strip is to be installed on both sides of wall and slid into the wall opening such that the outer edge of wrap strip is extending 5/8 in. (16 mm) from both surfaces of wall.
3M COMPANY 3M FIRE PROTECTION PRODUCTS – Tuck-In Wrap Strip WS Roll
 - B. **Fill, Void or Cavity Materials* – Caulk or Sealant** – Min 5/8 in. (16 mm) thickness of sealant applied within annular space, flush with both sides of wall.
3M COMPANY 3M FIRE PROTECTION PRODUCTS – IC 15WB+ Caulk, CP 25WB+ Caulk, or 3000 WT Sealant

*Indicates such products shall bear the UL Certification Mark for jurisdictions employing the UL Certification.

Reprinted from the Online Certifications Directory with permission from UL©



System No. W-K-2001

May 19, 2005

F Rating – 4 Hr

T Rating – 4 Hr

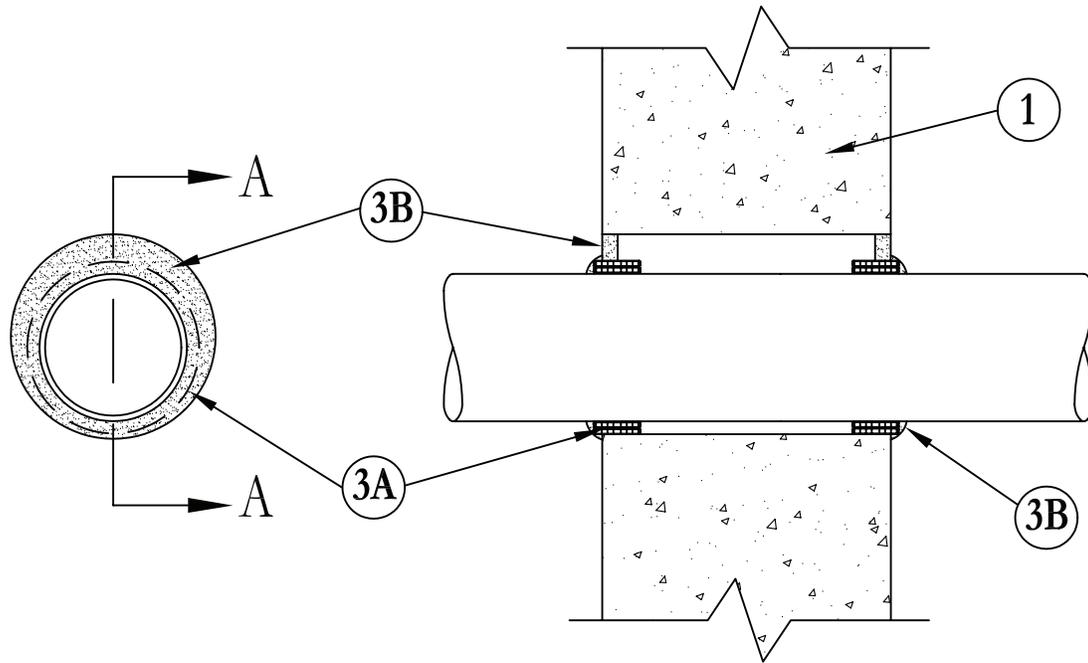

SECTION A-A

1. **Wall Assembly** – Min 8-5/8 in. (219 mm) thick wall assembly constructed of any UL Classified **Concrete Blocks*** or common bricks, laid up with mortar. Max diam of opening is 3 in. (76 mm).
See **Concrete Blocks** (CATZ) category in the Fire Resistance Directory for names of manufacturers.
2. **Through Penetrants** – One nonmetallic pipe or conduit to be installed either concentrically or eccentrically within the firestop system. The annular space between the pipe or conduit and periphery of opening shall be min of 1/4 in. to max 7/8 in. (6 mm to max 22 mm). Pipe or conduit to be rigidly supported on both sides of wall assembly. The following types and sizes of nonmetallic pipes or conduits may be used:
 - A. **Polyvinyl Chloride (PVC) Pipe** – Nom 1-1/2 in. (38 mm) diam (or smaller). Schedule 40 solid core or cellular core PVC pipe for use in closed (process or supply) or vented (drain, waste or vent) piping systems.
 - B. **Chlorinated Polyvinyl Chloride (CPVC) Pipe** – Nom 1-1/2 in. (38 mm) diam (or smaller) SDR13.5 CPVC pipe for use in closed (process or supply) piping systems.
 - C. **Rigid Nonmetallic Conduit++** – Nom 1-1/2 in. (38 mm) diam (or smaller). Schedule 40 PVC conduit installed in accordance with Article 347 of the National Electrical Code (NFPA No. 70).
 - D. **Acrylonitrile Butadiene Styrene (ABS) Pipe** – Nom 1-1/2 in. (38 mm) diam (or smaller). Schedule 40 solid core or cellular core ABS pipe for use in closed (process or supply) or vented (drain, waste or vent) piping systems.
 - E. **Fire Retardant Polypropylene (FRPP) Pipe** – Nom 1-1/2 in. (38 mm) diam (or smaller). Schedule 40 FRPP pipe for use in closed (process or supply) or vented (drain, waste or vent) piping systems.
3. **Firestop System** – The firestop system shall consist of the following:
 - A. **Fill, Void or Cavity Materials* – Wrap Strip** – Nom 1/8 in. (3.2 mm) thick intumescent material supplied in 2 in. (51 mm) wide strips. Two continuous layers of wrap strip tightly wrapped around nonmetallic pipe and held in place with 2 in. (51 mm) wide minimum 3 mil foil tape. Wrap strip to be slid into annular space on both sides of wall such that a 1/4 in. (6 mm) of wrap strip extends beyond both surfaces of the wall.
3M COMPANY – Ultra GS
 - B. **Fill, Void or Cavity Materials* – Caulk or Sealant** – Min thickness of 5/8 in. (16 mm) of caulk applied within annulus between wrap strip and periphery of the opening, flush with both surfaces of wall assembly. An additional 1/4 in. (6 mm) diam bead of caulk applied at the wrap strip/wall interface on both sides of wall.
3M COMPANY – CP 25BW+, IC 15WB+ caulk or FB-3000 WT sealant
(Note: CP 25WB+ not suitable for use with CPVC pipes.)

*Bearing the UL Classification Mark

++Bearing the UL Listing Mark

Reprinted from the Online Certifications Directory with permission from Underwriters Laboratories Inc.
Copyright © 2010 Underwriters Laboratories Inc.®



Note: Systems with Nonmetallic Through Penetrant(s) have not been evaluated with a pressure differential of 50 Pa between the exposed and unexposed surfaces as required by the National Building Code of Canada.

Non-Metallic Pipes • Gypsum

| 3M UL Systems | "F" Rating | 3M Product | Through Penetrant Details |
|---------------|------------|--|---|
| W-L-2002 | 1, 2 | 3M™ Fire Barrier Sealant CP 25WB+ 3M™ Fire Barrier Sealant IC 15WB+ 3M™ Fire Barrier Sealant FD 150+ 3M™ Fire Barrier Wrap Strips FS-195+ 3M™ Fire Barrier Ultra Plastic Pipe Device 3M™ Fire Barrier Moldable Putty Stix MP+ 3M™ Fire Barrier RC-1 Restricting Collar | 6" PVC, CPVC, 4" FRPP, ABS, 1" ENT, 1" fiberglass, steel collar. CP25WB+ not for CPVC. Also referred as WL2002. |
| W-L-2003 | 1, 2 | 3M™ Fire Barrier Sealant CP 25WB+ 3M™ Fire Barrier Sealant IC 15WB+ 3M™ Fire Barrier Sealant FD 150+ 3M™ Fire Barrier Wrap Strips FS-195+ 3M™ Fire Barrier Moldable Putty Stix MP+ | 2" PVC, CPVC. CP 25WB+ not for CPVC. Also referred as WL2003. |
| W-L-2004 | 2 | 3M™ Fire Barrier Sealant CP 25WB+ 3M™ Fire Barrier Sealant IC 15WB+ 3M™ Fire Barrier Sealant FD 150+ 3M™ Fire Barrier Wrap Strips FS-195+ 3M™ Fire Barrier Moldable Putty Stix MP+ 3M™ Fire Barrier RC-1 Restricting Collar | 4" PVC, ABS, FRPP, 3" CPVC, 2" PB, 1" ENT, 1" glass fiber: 30 gauge steel sleeve, steel collar. CP 25WB+ not for CPVC. Also referred as WL2004. |
| W-L-2005 | 1, 2 | 3M™ Fire Barrier Sealant CP 25WB+ 3M™ Fire Barrier Sealant IC 15WB+ 3M™ Fire Barrier Sealant FD 150+ 3M™ Fire Barrier Wrap Strips FS-195+ 3M™ Fire Barrier RC-1 Restricting Collar | 10"-6" PVC, 1" fiberglass: 30 gauge steel sleeve, steel collar. Also referred as WL2005. |
| W-L-2006 | 2 | 3M™ Fire Barrier Sealant CP 25WB+ 3M™ Fire Barrier Sealant IC 15WB+ 3M™ Fire Barrier Sealant FD 150+ 3M™ Fire Barrier Wrap Strips FS-195+ | 6" Schott glass. Also referred as WL2006. |
| W-L-2031 | 2 | 3M™ Fire Barrier Sealant CP 25WB+ 3M™ Fire Barrier Sealant IC 15WB+ 3M™ Fire Barrier Composite Sheet CS-195+ 3M™ Fire Barrier Wrap Strips FS-195+ 3M™ Fire Barrier Moldable Putty Stix MP+ | 2" PVC, CPVC. CP 25WB+ not for CPVC. Also referred as WL2031. |
| W-L-2032 | 2 | 3M™ Fire Barrier Sealant CP 25WB+ 3M™ Fire Barrier Sealant IC 15WB+ 3M™ Fire Barrier Composite Sheet CS-195+ 3M™ Fire Barrier Wrap Strips FS-195+ 3M™ Fire Barrier Moldable Putty Stix MP+ | 2" ENT, fiber optic cable: 22-1/2" x 8" maximum. Also referred as WL2032. |
| W-L-2033 | 2 | 3M™ Fire Barrier Sealant CP 25WB+ 3M™ Fire Barrier Sealant IC 15WB+ 3M™ Fire Barrier Sealant FD 150+ 3M™ Fire Barrier Wrap Strips FS-195+ | 2" ENT, fiber optic cable. Also referred as WL2033. |
| W-L-2058 | 1 | 3M™ Fire Barrier Water Tight Sealant 3000 WT | Nonmetallic clean-out system. Max. 2 in. nonmetallic pipe making a membrane penetration through one side of a 1 hour rated gypsum wallboard assembly. Also known as WL2058. |
| W-L-2073 | 1, 2 | 3M™ Fire Barrier Sealant CP 25WB+ 3M™ Fire Barrier Sealant IC 15WB+ 3M™ Fire Barrier Sealant FD 150+ 3M™ Fire Barrier Wrap Strips FS-195+ 3M™ Fire Barrier Ultra Plastic Pipe Device 3M™ Fire Barrier Moldable Putty Stix MP+ 3M™ Fire Barrier RC-1 Restricting Collar | 4" PVC, CPVC, ABS, 3" ccPVC, FRPP, steel collar. CP 25WB+ not for CPVC. Also referred as WL2073. |
| W-L-2087 | 1, 2 | 3M™ Fire Barrier Sealant CP 25WB+ 3M™ Fire Barrier Sealant IC 15WB+ 3M™ Fire Barrier Sealant FD 150+ 3M™ Fire Barrier Wrap Strips FS-195+ | 4" PVC, CPVC, ABS metallic sleeve (26 gauge). CP 25WB+ not for CPVC. Also referred as WL2087. |
| W-L-2088 | 1, 2 | 3M™ Fire Barrier Sealant CP 25WB+ 3M™ Fire Barrier Sealant IC 15WB+ 3M™ Fire Barrier Moldable Putty Stix MP+ | 3" PVC, CPVC, rigid NM conduit, 2" PVC, CPVC, ccPVC, 1" ENT. CP 25WB+ not for CPVC. Also referred as WL2088. |
| W-L-2090 | 2 | 3M™ Fire Barrier Sealant IC 15WB+ 3M™ Fire Barrier Sealant FD 150+ 3M™ Fire Barrier Wrap Strips FS-195+ 3M™ Fire Barrier Moldable Putty Stix MP+ | 1" PEX tubing. Also referred as WL2090. |
| W-L-2091 | 1, 2 | 3M™ Fire Barrier Sealant CP 25WB+ 3M™ Fire Barrier Moldable Putty Stix MP+ 3M™ Fire Barrier Sealant IC 15WB+ | 1" PEX tubing. Also referred as WL2091. |

Non-Metallic Pipes • Gypsum

| 3M UL Systems | "F" Rating | 3M Product | Through Penetrant Details |
|---------------|------------|--|--|
| W-L-2092 | 1, 2 | 3M™ Fire Barrier Sealant CP 25WB+ 3M™ Fire Barrier Sealant IC 15WB+ 3M™ Fire Barrier Sealant FD 150+ 3M™ Fire Barrier Wrap Strips FS-195+ 3M™ Fire Barrier Moldable Putty Stix MP+ 3M™ Fire Barrier RC-1 Restricting Collar | 4" PVDF, steel collar. Also referred as WL2092. |
| W-L-2097 | 1, 2 | 3M™ Fire Barrier Sealant CP 25WB+ 3M™ Fire Barrier Sealant IC 15WB+ 3M™ Fire Barrier Moldable Putty Stix MP+ | 3" PVC, CPVC, metallic sleeve (28 gauge). CP 25WB+ not for CPVC. Also referred as WL2097. |
| W-L-2099 | 1, 2 | 3M™ Fire Barrier Sealant CP 25WB+ 3M™ Fire Barrier Sealant IC 15WB+ 3M™ Fire Barrier Sealant FD 150+ 3M™ Fire Barrier Wrap Strips FS-195+ 3M™ Fire Barrier Moldable Putty Stix MP+ 3M™ Fire Barrier RC-1 Restricting Collar | 6" PP, metal sleeve, steel collar. Also referred as WL2099. |
| W-L-2112 | 1, 2 | 3M™ Fire Barrier Sealant CP 25WB+ 3M™ Fire Barrier Sealant IC 15WB+ | 3" glass pipe. Also referred as WL2112. |
| W-L-2146 | 1, 2 | 3M™ Fire Barrier Sealant CP 25WB+ 3M™ Fire Barrier Sealant IC 15WB+ | Multiple 1" diameter, maximum 3 tubes, PEX tubing. Also referred as WL2146. |
| W-L-2147 | 1, 2 | 3M™ Fire Barrier Sealant IC 15WB+ 3M™ Fire Barrier Sealant CP 25WB+ 3M™ Fire Barrier Water Tight Sealant 3000 WT 3M™ Fire Barrier Sealant FD 150+ 3M™ Fire Barrier Wrap Ultra GS 3M™ Fire Barrier RC-1 Restricting Collar | Single max. 4 in. PVC, RNC, CPVC, ABS, or FRPP penetrating a 1 or 2 hour rated gypsum wallboard assembly. Utilizing Ultra GS Wrap Strips and RC-1 Restricting Collar or Ultra PPD. |
| W-L-2148 | 1 | 3M™ Fire Barrier Wrap Ultra GS 3M™ Fire Barrier Sealant CP 25WB+ 3M™ Fire Barrier Sealant IC 15WB+ 3M™ Fire Barrier Sealant FD 150+ | 2" PVC, CPVC, ABS, FRPP pipe, 2" PVC conduit. CP 25WB+ not for CPVC. Also referred as WL2148. |
| W-L-2149 | 2 | 3M™ Fire Barrier Wrap Ultra GS 3M™ Fire Barrier Sealant CP 25WB+ 3M™ Fire Barrier Sealant IC 15WB+ 3M™ Fire Barrier Sealant FD 150+ | 2" PVC, CPVC, ABS, FRPP pipe, 2" PVC conduit. CP 25WB+ not for CPVC. Also referred as WL2149. |
| W-L-2150 | 2 | 3M™ Fire Barrier Wrap Ultra GS 3M™ Fire Barrier Sealant CP 25WB+ 3M™ Fire Barrier Sealant IC 15WB+ 3M™ Fire Barrier Sealant FD 150+ 3M™ Fire Barrier Moldable Putty Stix MP+ 3M™ Fire Barrier RC-1 Restricting Collar | 6" PVC, CPVC, ABS, FRPP pipe, 6" PVC conduit, steel collar. CP 25WB+ not for CPVC. Also referred as WL2150. |
| W-L-2154 | 1, 2 | 3M™ Fire Barrier Wrap Ultra GS 3M™ Fire Barrier Sealant CP 25WB+ 3M™ Fire Barrier Sealant IC 15WB+ 3M™ Fire Barrier Sealant FD 150+ 3M™ Fire Barrier RC-1 Restricting Collar | Steel sleeve, 6" PVC, CPVC pipe, 6" rigid NM conduit, steel collar. CP 25WB+ not for CPVC. Also referred as WL2154. |
| W-L-2162 | 1, 2, 3 | 3M™ Fire Barrier Sealant CP 25WB+ 3M™ Fire Barrier Sealant IC 15WB+ 3M™ Fire Barrier Sealant FD 150+ 3M™ Fire Barrier Ultra Plastic Pipe Device 3M™ Fire Barrier Moldable Putty Stix MP+ | 4" PVC, CPVC, ABS, FRPP pipe, 4" rigid NM conduit. CP 25WB+ not for CPVC. Also referred as WL2162. |
| W-L-2172 | 1 | 3M™ Fire Barrier Water Tight Sealant 1000 NS | 3/4" PVC, CPVC, 2-1/4" diameter. Also referred as WL2172. |
| W-L-2173 | 1 | 3M™ Fire Barrier Water Tight Sealant 1000 NS | 3/4" PEX tubing, 2-1/4" diameter. Also referred as WL2173. |
| W-L-2174 | 1, 2 | 3M™ Fire Barrier Water Tight Sealant 1000 NS | 1 1/2" PVC, CPVC, rigid NM conduit, 2 1/4" diameter. Also referred as WL2174. |
| W-L-2180 | 1, 2 | 3M™ Fire Barrier Wrap Ultra GS 3M™ Fire Barrier Sealant CP 25WB+ 3M™ Fire Barrier Sealant IC 15WB+ 3M™ Fire Barrier Sealant FD 150+ 3M™ Fire Barrier Moldable Putty Stix MP+ 3M™ Fire Barrier RC-1 Restricting Collar | 2" SDR 11, 4" SDR 32.5 PVDF, closed or vented systems, steel collar. Also referred as WL2180. |
| W-L-2264 | 1, 2 | 3M™ Fire Barrier Sealant CP 25WB+ 3M™ Fire Barrier Sealant IC 15WB+ 3M™ Fire Barrier Sealant FD 150+ | 2" PVC, CPVC, rigid NM conduit, ABS. CP 25WB+ not for CPVC. Also referred as WL2264. |

Non-Metallic Pipes • Gypsum

| 3M UL Systems | "F" Rating | 3M Product | Through Penetrant Details |
|---------------|------------|--|---|
| W-L-2265 | 4 | 3M™ Fire Barrier Wrap Ultra GS 3M™ Fire Barrier Sealant CP 25WB+ 3M™ Fire Barrier Sealant IC 15WB+ 3M™ Fire Barrier Water Tight Sealant 3000 WT | 1-1/2" PVC, CPVC, rigid NM conduit, ABS, FRPP. CP 25WB+ not for CPVC. Also referred as WL2265. |
| W-L-2266 | 4 | 3M™ Fire Barrier Ultra Plastic Pipe Device 3M™ Fire Barrier Sealant CP 25WB+ 3M™ Fire Barrier Sealant IC 15WB+ 3M™ Fire Barrier Water Tight Sealant 3000 WT | 4" PVC, CPVC, rigid NM conduit, ABS, FRPP. CP 25WB+ not for CPVC. Also referred as WL2266. |
| W-L-2299 | 1, 2 | 3M™ Fire Barrier Sealant CP 25WB+ 3M™ Fire Barrier Sealant IC 15WB+ | 2" PVC, ccPVC, CPVC, rigid NM conduit, 1-1/2" ABS, ccABS, 1-1/4" ENT. CP 25WB+ not for CPVC. Also referred as WL2299. |
| W-L-2300 | 1, 2 | 3M™ Fire Barrier Sealant CP 25WB+ 3M™ Fire Barrier Sealant IC 15WB+ | Multiple 1-1/2" PVC, ccPVC, CPVC, rigid NM conduit, 1" PEX tubing. CP 25WB+ not for CPVC. Also referred as WL2300. |
| W-L-2355 | 1 | 3M™ Fire Barrier Sealant CP 25WB+ 3M™ Fire Barrier Sealant IC 15WB+ | Max. 3" PVC clean-out pipe. Also referred as WL2355. |
| W-L-2356 | 2 | 3M™ Fire Barrier Sealant CP 25WB+ 3M™ Fire Barrier Sealant IC 15WB+ 3M™ Fire Barrier Wrap Ultra GS 3M™ Fire Barrier Water Tight Sealant 3000 WT | Max. 2" PVC, CPVC, RNC, ABS pipes. One side application in a 2 hour rated shaft wall. CP 25WB+ not for CPVC. Also referred as WL2356. |
| W-L-2385 | 1, 2 | 3M™ Fire Barrier Wrap Ultra GS 3M™ Fire Barrier Sealant CP 25WB+ 3M™ Fire Barrier Sealant IC 15WB+ | 3" PVC (closed or vented), 3" rigid nonmetallic conduit, 3" SDR 13.5 CPVC (closed only), 3" ABS solid or cellular core (vented or closed). Concentric or eccentric installation. Max opening 4-1/2". Annular 3/8" to 5/8". 1 & 2 hr. F. CP 25WB+ not for CPVC. Also known as WL2385. |
| W-L-2397 | 1, 2 | 3M™ Fire Barrier Sealant CP 25WB+ 3M™ Fire Barrier Water Tight Sealant 3000 WT 3M™ Fire Barrier Moldable Putty Stix MP+ 3M™ Fire Barrier Wrap Ultra GS | 4" PVC, 4" ccPVC (closed or vented), 4" SDR13.5 CPVC (closed), 4" ABS, 4" ccABS (closed or vented), 4" conduit (RNC), 4" FRPP (closed or vented). Nonmetallic pipe coupling flush w/ either side of wall and extending outward. Max diam of opening 5". Concentric/eccentric installation. 1 & 2 hour F & T Rating. Wrap strip, collar, &caulk system. CP 25WB+ not for CPVC. Also known as WL2397. |
| W-L-2448 | 1, 2 | 3M™ Fire Barrier Pass-Through Products 3M™ Fire Barrier Water Tight Sealant 3000 WT 3M™ Fire Barrier Sealant CP 25WB+ 3M™ Fire Barrier Sealant IC 15WB+ 3M™ Fire Barrier Moldable Putty Stix MP+ | Square device: max area 98-1/2 sq.in w/max dimension of 12-1/2 in. Round device: max diam of opening 4-1/2 in. 2 in. PVC (closed or vented), 2 in. RNC, 2 in. CPVC (closed), 2 in. PEX (closed), max 4 2 in. ENT, 2 in. optical/coaxial raceway, max 2 in. ABS or ccABS (closed). Multiple penetrants of same type allowed and may be banded. Max 6 square ganged or 1 round. 1 and 2 hour F. Also known as WL2448. |
| W-L-2483 | 1, 2 | 3M™ Fire Barrier Sealant CP 25WB+ 3M™ Fire Barrier Water Tight Sealant 3000 WT | Max 1 in. closed or vented PVC or ccPVC, max 1 in. RNC, max 1 in. SDR 13.5 closed CPVC, max 1 in. closed PEX. Max diameter of opening 4-1/2 in. U400 or V400 series gypsum shaft wall assembly. Multiple penetrants. Concentric or eccentric installation. Min 1/4 in. to max 1 in. annular. 1/4 in. to 1 in. space between penetrants. 1 & 2 hour F rating. Also known as WL2483. |
| W-L-2543 | 1, 2 | 3M™ Fire Barrier Water Tight Sealant 3000 WT | Max 2 in. PVC (closed or vented), 2 in. CPVC (closed), 2 in. RNC, 2 in. PEX, 2 in. ABS or ccABS (closed or vented), 2 in. ENT, 2 in. FNMC. U300, U400, or V400 gypsum wallboard assembly. Max diam of opening 3 in. Concentric installation. 5/16 in. annular space. 1 & 2 hour F rating. Sealant only-no mineral wool required. Also known as WL2543. |
| W-L-2547 | 1, 2 | 3M™ Fire Barrier Sealant IC 15WB+ 3M™ Fire Barrier Sealant CP 25WB+ 3M™ Fire Barrier Water Tight Sealant 3000 WT | Max 2 in. SDR 9 PEX (closed only). U300, U400, or V400 series gypsum wallboard assemblies. Max diam of opening 1-1/2 in. larger than OD of penetrant. Point contact to max 1-1/2 in. annular space. Concentric or eccentric installation. 1 & 2 hour F rating. No mineral wool required. Also known as WL2547. |
| W-L-2551 | 1, 2 | 3M™ Fire Barrier Sealant IC 15WB+ 3M™ Fire Barrier Sealant CP 25WB+ 3M™ Fire Barrier Water Tight Sealant 3000 WT 3M™ Fire Barrier Tuck-In Wrap Strips 3M™ Aluminum Foil Tape 425 | 4" PVC closed or vented, 4 CPVC closed or vented, 4" FRPP closed or vented, 4" RNC through a gypsum wallboard assembly. Max opening size 5" |
| W-L-2553 | 1, 2 | 3M™ Fire Barrier Tuck-In Wrap Strips 3M™ Fire Barrier Sealant CP 25WB+ 3M™ Fire Barrier Sealant IC 15WB+ 3M™ Fire Barrier Water Tight Sealant 3000 WT | Nominal 6 in. PVC (closed or vented), nominal 6 in. ccPVC (closed or vented). U300, U400 or V400 wall assemblies. Max opening 8 in. Min 3/8 in. to max 5/8 in. annular space. Concentric installation. No mineral wool or collar required. In hole installation of products. 1 and 2 hour F. Also known as WL2553. |

Non-Metallic Pipes • Gypsum

| 3M UL Systems | "F" Rating | 3M Product | Through Penetrant Details |
|-----------------|------------|--|---|
| W-L-2572 | 1, 2 | 3M™ Fire Barrier Sealant IC 15WB+ 3M™ Fire Barrier Sealant CP 25WB+ 3M™ Fire Barrier Water Tight Sealant 3000 WT 3M™ Fire Barrier Wrap Ultra GS | U300, U400, V400 or W400 series gypsum wall. Max 3 in. SDR 7.4 PP (closed or vented). Max 3 in. SDR 11 PP (closed or vented). Max 5 in. opening. Min 1/4 in. to max 1 in. annular space. Concentric/eccentric installation. 1 & 2 hour F & T. Tested to 2.5 Pa. Also known as WL2572. |
| W-L-2580 | 1, 2 | 3M™ Fire Barrier Tuck-In Wrap Strips 3M™ Fire Barrier Sealant IC 15WB+ 3M™ Fire Barrier Sealant CP 25WB+ 3M™ Fire Barrier Water Tight Sealant 3000 WT | 2" PVC closed or vented, 2" CPVC closed or vented, 4" PVDF closed or vented, 2" RNC through a gypsum wallboard assembly. Max opening 5-1/2 in. |
| W-L-2648 | 1, 2 | 3M™ Fire Barrier Tuck-In Wrap Strips 3M™ Fire Barrier Sealant IC 15WB+ 3M™ Fire Barrier Sealant CP 25WB+ 3M™ Fire Barrier Water Tight Sealant 3000 WT | 6 in. or 8 in. polypropylene pipe penetrating a 1 or 2 hour rated gypsum wallboard assembly. |

System No. W-L-2002

November 20, 2009

F Ratings – 1, 1-1/2 and 2 Hr (See Item 3)
 T Ratings – 3/4, 1, 1-1/2 and 2 Hr (See Item 3)
 L Rating At Ambient – 7 CFM/sq ft (See Item 3C)
 L Rating At 400 F – 1 CFM/sq ft (See Item 3C)

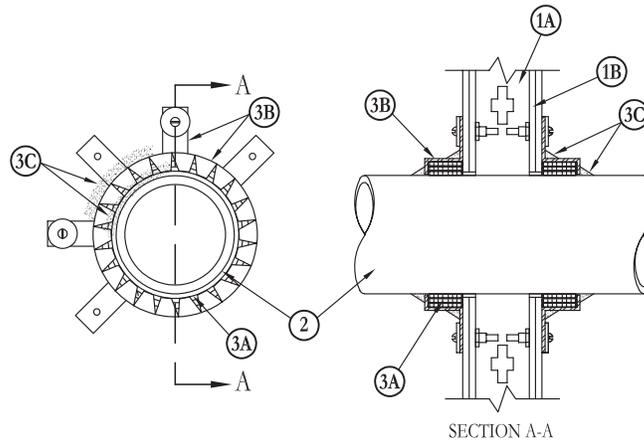

1. **Wall Assembly** – The 1 or 2 hr fire-rated gypsum board/stud wall assembly shall be constructed of the materials and in the manner described in the individual U300, U400 or V400 Series Wall and Partition Design in the UL Fire Resistance Directory and shall include the following construction features:
 - A. **Studs** – Wall framing may consist of either wood studs or steel channel studs. Wood studs to consist of nom 2 by 4 in. (51 by 102 mm) lumber spaced 16 in. (406 mm) OC. Steel studs to be min 3-5/8 in. (92 mm) wide by 1-3/8 in. (35 mm) deep channels spaced max 24 in. (610 mm) OC.
 - B. **Gypsum Board*** – 5/8 in. (16 mm) thick, 4 ft (122 cm) wide with square or tapered edges. The gypsum board type, thickness, number of layers, fastener type and sheet orientation shall be as specified in the individual U300, U400 or V400 Series Design in the UL Fire Resistance Directory. Max diam of opening is 7 in. (178 mm).
2. **Nonmetallic Pipe or Conduit** – One nonmetallic pipe or conduit is centered within the firestop system. Pipe or conduit to be installed near center of stud cavity width and to be rigidly supported on both sides of wall. The following types and sizes of nonmetallic pipes or conduit may be used:
 - A. Nom 6 in. (152 mm) diam (or smaller) Schedule 40 solid-core polyvinyl chloride (PVC) pipe for use in closed (process or supply) or vented (drain, waste or vent) piping systems.
 - B. Nom 4 in. (102 mm) diam (or smaller) Schedule 40 cellular core polyvinyl chloride (PVC) pipe for use in closed (process or supply) or vented (drain, waste or vent) piping systems.
 - C. Nom 4 in. (102 mm) diam (or smaller) Schedule 40 solid-core acrylonitrile-butadiene-styrene (ABS) pipe for use in closed (process or supply) or vented (drain, waste or vent) piping systems.
 - D. Nom 4 in. (102 mm) diam (or smaller) Schedule 40 fire retardant polypropylene (FRPP) pipe for use in closed (process or supply) or vented (drain, waste or vent) piping systems.
 - E. Nom 4 in. (102 mm) diam (or smaller) **Rigid Nonmetallic Conduit** formed of PVC.
 - F. Nom 1 in. (25 mm) diam (smaller) **Electrical Nonmetallic Tubing** formed of PVC.
 - G. Nom 6 in. (152 mm) diam (or smaller) SDR13.5 chlorinated polyvinyl chloride (CPVC) pipe for use in closed (process or supply) piping systems.

See **Rigid Nonmetallic Conduit** (DZKT) and **Electrical Nonmetallic Tubing** (FKHU) categories in UL Electrical Construction Materials Directory for names of manufacturers.
3. **Firestop System** – Installed symmetrically on both sides of wall assembly. The hourly F and T Ratings for the firestop system are dependent upon the type and size of nonmetallic pipe or conduit, the piping system type (closed systems such as process or supply piping or vented systems such as drain, waste or vent piping) and the hourly fire rating of the wall assembly in which it is installed, as shown in the following table.

| Pipe or Conduit Type | Nom Pipe Diam In. (mm) | Annular Space In. (mm) | Piping System (a) | Wall Fire Rating Hr | F Rating Hr | T Rating Hr |
|----------------------|------------------------|------------------------|-------------------|---------------------|-------------|-------------|
| FRPP | 1/2 to 2 (13 to 51) | 0-3/16 (0-5) | V | 2 | 1-1/2 | 1-1/2 |
| FRPP, PB | 1/2 to 2 (13 to 51) | 0-3/16 (0-5) | C | 2 | 2 | 2 |
| ABS | 1/2 to 4 (13 to 102) | 0-3/16 (0-5) | C,V | 1 | 1 | 3/4 |
| ABS | 1/2 to 4 (13 to 102) | 0-3/16 (0-5) | C,V | 2 | 1-1/2 | 1-1/2 |
| PVC | 1/2 to 4 (13 to 102) | 0-3/16 (0-5) | C,V | 1 | 1 | 1 |
| PVC | 1/2 to 4 (13 to 102) | 0-3/16 (0-5) | C,V | 2 | 2 | 2 |
| FRPP+ | 2-1/2 to 4 (64 to 102) | 0-3/16 (0-5) | C,V | 2 | 1-1/2 | 1-1/2 |
| PVC+ | 5, 6 (127 to 152) | 0-3/16 (0-5) | C,V | 2 | 1-1/2 | 1-1/2 |

+Pipe covering material wrap required on pipe on both sides of wall.

(a) C = closed systems, V = vented systems.

The details of the firestop system shall be as follows.

System No. W-L-2002 *continued*

- A. **Fill, Void or Cavity Materials* – Wrap Strip** – Nom 1/4 in. (6 mm) thick intumescent elastomeric material faced on one side with aluminum foil, supplied in 2 in. (51 mm) wide strips. Nom 2 in. (51 mm) wide strips tightly wrapped around nonmetallic pipe or conduit (foil side exposed) with the edges butted against the surface of the wall. Sufficient layers of wrap strip shall be installed to lap a min of 3/16 in. (5 mm) on the wall surface around the entire perimeter of the circular through opening. For nom 1/2 in. (13 mm) to nom 2 in. (51 mm) diam pipes or conduits, a min of one layer of wrap strip is required. For nom 2-1/2 in. (64 mm) and nom 3 in. (76 mm) diam pipes, a min of two layers of wrap strip is required. For nom 3-1/2 in. (89 mm) and nom 4 in. (102 mm) diam pipes, a min of three layers of wrap strip is required. For nom 5 and 6 in. (127 and 152 mm) diam, two tiers (4 in. (102 mm) overall length) of three layers of wrap strip is required, with adjoining wrap strip layer edges between tiers tightly butted. Each layer of wrap strip to be installed with butted seam, with butted seams in successive layers staggered. Wrap strip layers temporarily held in position using aluminum foil tape, steel wire tie or equivalent.

3M COMPANY – Type FS-195+

- B. **Steel Collar** – Nom 2 or 4 in. (51 or 102 mm) deep collar with 1-1/4 in. (32 mm) wide by 2 in. (51 mm) long anchor tabs and min 3/4 in. (19 mm) long tabs to retain wrap strip layers. Coils of precut 0.016 in. (0.41 mm) thick (No. 30 28 gauge) galv sheet steel available from wrap strip manufacturer. As an alternate, collar may be field-fabricated from min 0.016 in. (0.41 mm) thick (No. 30 28 gauge) galv sheet steel in accordance with instruction sheet supplied by wrap strip manufacturer.

Steel collar, with anchor tabs bent outward 90 deg, wrapped tightly around wrap strip layers with min 1 in. (25 mm) overlap at the seam. With steel collar anchor tabs pressed tightly against wall surface, compress collar around wrap strip layers using a min 1/2 in. (13 mm) wide by 0.028 in. (0.71 mm) thick stainless steel band clamp with worm drive tightening mechanism at the collar midheight. As an alternate to the stainless steel band clamp, the steel collar may be compressed around nom 4 in. diam (or smaller nonmetallic pipes using two min 16 SWG (0.0625 in. (0.016 mm) diam) steel wires secured with multiple twists. As an alternate to the band clamps or steel wires, collars may be secured by a means No. 10 by 1/2 in. (13 mm) long sheet metal screws installed in the vertical axis at the center of the 1 in. (25 mm) overlap along the perimeter joint of the collar. A min of three screws is required. Secure collar to wall surface with 3/16 in. (5 mm) diam steel toggle bolts in conjunction with min 1-1/2 in. (38 mm) diam steel washers.

Three bolts, symmetrically located, required for 2 in. (51 mm) deep steel collar for nom 1/2 in. (13 mm) to nom 3 in. (76 mm) diam pipes. Four bolts, symmetrically located, required for 2 in. (51 mm) deep steel collar for nom 3-1/2 and 4 in. (89 and 102 mm) diam pipes. Five to seven bolts (every other anchor tab) required for 4 in. (102 mm) deep steel collar for nom 5 and 6 in. (127 and 152 mm) diam pipes. As a final step, bend retainer tabs 90 deg toward pipe to lock wrap strip layers in position.

- C. **Fill, Void or Cavity Materials* – Caulk, Sealant or Putty** – Generous bead of caulk applied to outer perimeter of wrap strip at interface with wall surface and to perimeter of pipe or conduit at its egress from the wrap strip layers.

3M COMPANY – CP 25WB+ caulk and MP+ Stix putty, IC 15WB+ caulk, FireDam 150+ caulk, or FB-3000 WT sealant (Note: L Ratings apply only when CP 25WB+ caulk or FB-3000 WT sealant is used. CP 25WB+ and FireDam 150+ not suitable for use with CPVC pipes.)

- D. **Pipe Covering*** – (Not Shown) – Nom 1 in. (25 mm) thick hollow cylindrical heavy density (min 3.5 pcf or 56 kg/m³) glass fiber units jacketed on the outside with an all service jacket. When required (see table), min 6 in. (152 mm) length of pipe covering installed around PVC pipe at its egress from steel collar on both sides of wall. Pipe covering secured to pipe with steel wire ties spaced max 4 in. (102 mm) OC. Edge of pipe covering abutting steel collar to be sealed with a min 1/4 in (6 mm). diam bead of caulk (Item C).

See **Pipe and Equipment Covering – Materials (BRGU)** category in Building Materials Directory for names of manufacturers. Any pipe covering material meeting the above specifications and bearing the UL Classification Marking with a Flame Spread Index of 25 or less and a Smoke Developed Index of 50 or less may be used.

- E. **Firestop Device*** – (Not shown) – As an alternate to Items A, B and C for nom 1-1/2, 2, 3 or 4 in. (38, 51, 76 or 102 mm) diam nonmetallic pipes, a firestop device consisting of a sheet-steel split collar lined with intumescent material and provided with steel clips for attachment may be used. Firestop device to be installed on both sides of wall in accordance with the accompanying installation instructions.

3M COMPANY – Types PPD 150, PPD 200, PPD 300, PPD 400

*Bearing the UL Classification Mark

Reprinted from the Online Certifications Directory with permission from Underwriters Laboratories Inc.

Copyright © 2010 Underwriters Laboratories Inc.®



Note: Systems with Nonmetallic Through Penetrant(s) have not been evaluated with a pressure differential of 50 Pa between the exposed and unexposed surfaces as required by the National Building Code of Canada.

Through Penetrations

Non-Metallic Pipes

2000 Series

Gypsum

W/L

System No. W-L-2003

November 20, 2009

F Ratings – 1 and 2 Hr (See Item 3)

T Ratings – 1 and 2 Hr (See Item 3)

L Rating At Ambient – 7 CFM/sq ft (See Item 3B)

L Rating At 400 F – less than 1 CFM/sq ft (See Item 3B)

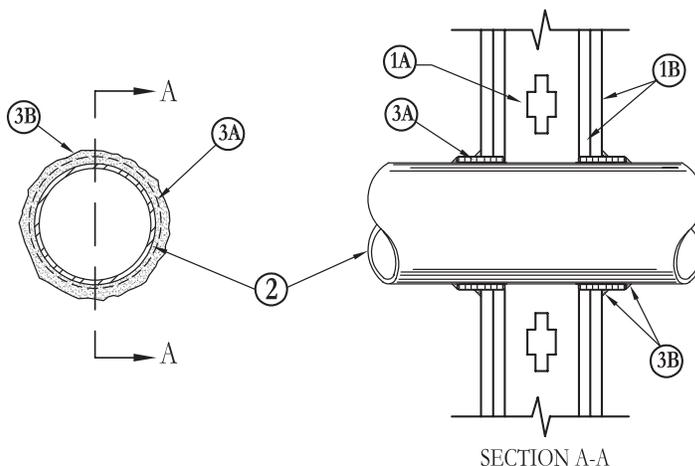

- Wall Assembly** – The 1 or 2 hr fire-rated gypsum board/stud wall assembly shall be constructed of the materials and in the manner described in the individual U300, U400 or V400 Series Wall or Partition Design in the UL Fire Resistance Directory and shall include the following construction features:
 - Studs** – Wall framing may consist of either wood studs or steel channel studs. Wood studs to consist of nom 2 by 4 in. (51 by 102 mm) lumber spaced 16 in. (406 mm) OC with nom 2 by 4 in. (51 by 102 mm) lumber end plates and cross braces. Steel studs to be min 3-5/8 in. (92 mm) wide by 1-3/8 in. (35 mm) deep channels spaced max 24 in. (610 mm) OC.
 - Gypsum Board*** – 5/8 in. (16 mm) thick, 4 ft (122 cm) wide with square or tapered edges. The gypsum board type, thickness, number of layers, fastener type and sheet orientation shall be as specified in the individual U300, U400 or V400 Series Design in the UL Fire Resistance Directory. Max diam of opening is 3-1/8 in. (79 mm).
- Through Penetrants** – One nonmetallic pipe or conduit to be centered in the through opening. The annular space between pipe or conduit and periphery of opening shall be min 1/4 in. (6 mm) and max 3/8 in. (10 mm). Pipe or conduit to be rigidly supported on both sides of the floor-ceiling assembly. The following types and sizes of nonmetallic pipes or conduits may be used:
 - Polyvinyl Chloride (PVC) Pipe** – Nom 2 in. (51 mm) diam (or smaller) Schedule 40 solid core PVC pipe for use in closed (process or supply) or vented (drain, waste or vent) piping system.
 - Rigid Nonmetallic Conduit++** – Nom 2 in. (51 mm) diam (or smaller)(Schedule 40 or 80) PVC conduit installed in accordance with the National electric Code (NFPA No. 70).
 - Chlorinated Polyvinyl Chloride (CPVC) Pipe** – Nom 2 in. (51 mm) diam (or smaller) SDR13.5 CPVC pipe for use in closed (process or supply) piping systems.
 - Cellular Core Polyvinyl Chloride (ccPVC) Pipe** – Nom 2 in. (51 mm) diam (or smaller) Schedule 40 cellular core PVC pipe for use in closed (process or supply) or vented (drain, waste or vent) piping system.
 - Acrylonitrile Butadiene Styrene (ABS) Pipe** – Nom 2 in. (51 mm) diam (or smaller) Schedule 40 solid core ABS pipe for use in closed (process or supply) or vented (drain, waste or vent) piping systems.
 - Cellular Core Acrylonitrile Butadiene Styrene (ccABS) Pipe** – Nom 2 in. (51 mm) diam (or smaller) Schedule 40 cellular core ABS pipe for use in closed (process or supply) or vented (drain, waste or vent) piping systems.
- Firestop System** – Installed symmetrically on both sides of wall assembly. The hourly F and T Ratings for the firestop system are equal to the hourly fire rating of the wall assembly in which it is installed. The details of the firestop system shall be as follows.
 - Fill, Void or Cavity Materials* – Wrap Strip** – Nom 1/4 in. (6 mm) thick intumescent elastomeric material faced on one side with aluminum foil, supplied in 2 in. (51 mm) wide strips. Nom 2 in. (51 mm) wide strip tightly wrapped around nonmetallic pipe (foil side out) with seam butted. Wrap strip layer securely bound with steel wire or aluminum foil tape and slid into annular space approx 1-1/4 in. (32 mm) such that approx 3/4 in. (19 mm) of the wrap strip protrudes from the wall surface.
3M COMPANY – FS-195+
 - Fill, Void or Cavity Materials* – Caulk, Sealant or Putty** – Min 5/8 in. (16 mm) thickness of caulk or putty applied into annular space between wrap strip and periphery of opening. A nom 1/4 in. (6 mm) diam bead of caulk or putty to be applied to the wrap strip/wall interface and to the exposed edge of the wrap strip layers approx 3/4 in. (19 mm) from the wall surface.
3M COMPANY – CP 25WB+ caulk or MP+ Stix putty, IC 15WB+ caulk, FireDam 150+ caulk or FB-3000 WT sealant.
(Note: L Ratings apply only when Type CP 25WB+ caulk or FB-3000 WT sealant is used. CP 25WB+ and FireDam 150+ not suitable for use with CPVC pipes.)
 - Foil Tape** – (not shown) – Nom 4 in. (102 mm) wide, 3 mil thick aluminum tape wrapped around pipe prior to the installation of the wrap strip (Item 3A). Min of one wrap, flush with both sides of wall and proceeding outward. Tape is not required for pipes shown in Items 2A, 2B and 2C.

*Bearing the UL Classification Mark

Reprinted from the Online Certifications Directory with permission from Underwriters Laboratories Inc.

Copyright © 2010 Underwriters Laboratories Inc.®



Note: Systems with Nonmetallic Through Penetrant(s) have not been evaluated with a pressure differential of 50 Pa between the exposed and unexposed surfaces as required by the National Building Code of Canada.

System No. W-L-2004

November 20, 2009

F Rating – 2 Hr

T Ratings – 3/4, 1-1/2 and 2 Hr (See Item 3)

L Rating At Ambient – 7 CFM/sq ft (See Item 3C)

L Rating At 400 F – less than 1 CFM/sq ft (See Item 3C)

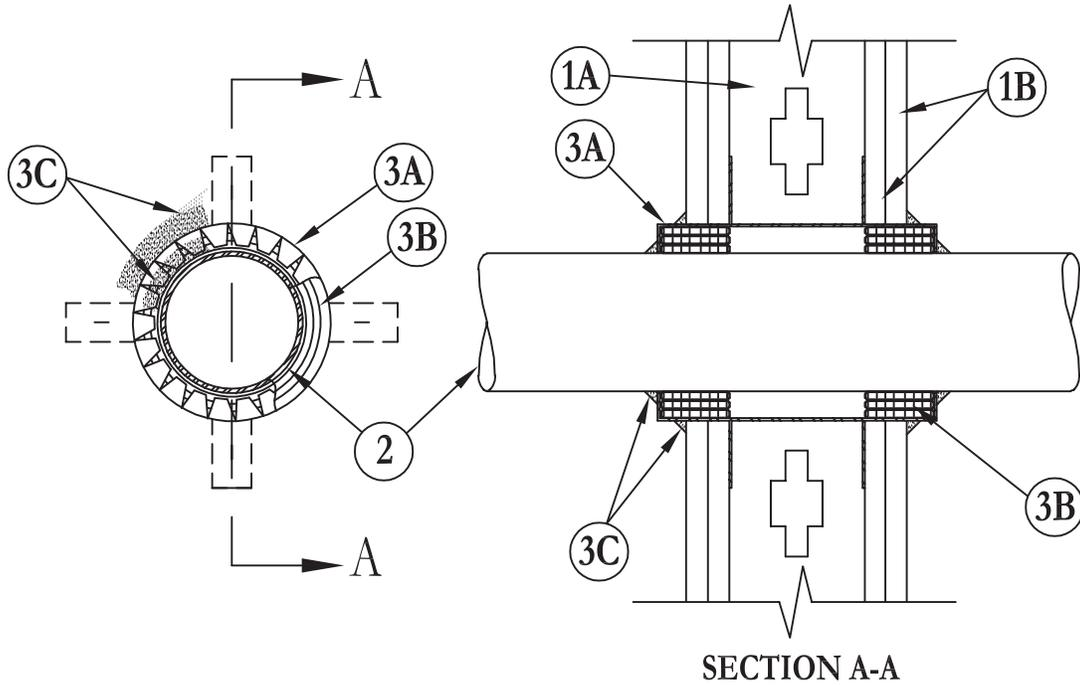

- Wall Assembly** – The 2 hr fire-rated gypsum board/stud wall assembly shall be constructed of the materials and in the manner described in the individual U300, U400 or V400 Series Wall and Partition Design in the UL Fire Resistance Directory and shall include the following construction features:
 - Studs** – Wall framing may consist of either wood studs or steel channel studs. Wood studs to consist of nom 2 by 4 in. (51 by 102 mm) lumber spaced 16 in. (406 mm) OC with nom 2 by 4 in. (51 by 102 mm) lumber end plates and cross braces. Steel studs to be min 3-5/8 in. (92 mm) wide by 1-3/8 in. (35 mm) deep channels spaced max 24 in. (610 mm) OC.
 - Gypsum Board*** – Two layers of nom 5/8 in. (16 mm) thick gypsum wallboard, as specified in the individual Wall and Partition Design. Max diam of opening is 6-1/4 in. (159 mm).
- Nonmetallic Pipe or Conduit** – One nonmetallic pipe or conduit centered in firestop system. Pipe or conduit to be rigidly supported on both sides of wall. The following types and sizes of nonmetallic pipes or conduit may be used in closed (process or supply) or vented (drain, waste or vent) piping systems:
 - Nom 4 in. (102 mm) diam (or smaller) Schedule 40 polyvinyl chloride (PVC) pipe.
 - Nom 4 in. (102 mm) diam (or smaller) Schedule 40 solid-core acrylonitrile butadiene-styrene (ABS) pipe.
 - Nom 4 in. (102 mm) diam (or smaller) Schedule 40 (or heavier) fire retardant polypropylene (FRPP) pipe.
 - Nom 4 in. (102 mm) diam (or smaller) **Rigid Nonmetallic Conduit** formed of PVC.
 - Nom 1 in. (25 mm) diam (or smaller) **Electrical Nonmetallic Tubing** formed of PVC.
 - Nom 2 in. (51 mm) diam (or smaller) SDR11 (or heavier) polybutylene (PB) pipe.
 - Nom 3 in. (76 mm) diam (or smaller) SDR13.5 (or heavier) chlorinated polyvinyl chloride (CPVC) pipe (closed piping systems only).
 See **Rigid Nonmetallic Conduit (DZKT)** and **Electrical Nonmetallic Tubing (FKHU)** categories in Electrical Construction Materials Directory for names of manufacturers.
- Firestop System** – Installed symmetrically on both sides of wall assembly. The hourly T Ratings for the firestop system are dependent upon the type and size of nonmetallic pipe or conduit, as tabulated below:

| Pipe or Conduit Type | Nom Pipe Diam In. (mm) | Annular Space In. (mm) | F Rating Hr | T Rating Hr |
|----------------------|------------------------|------------------------|-------------|-------------|
| PB | 1/2 to 2 (13 to 51) | 1/4-3/8 (6 to 10) | 2 | 2 |
| PP+ | 2-1/2, 3 (64 to 76) | 1/2-5/8 (13 to 16) | 2 | 3/4 |
| PP+ | 3-1/2, 4 (89 to 102) | 3/4-7/8 (19 to 22) | 2 | 3/4 |
| PVC, CPVC, ABS | 2-1/2, 3 (64 to 76) | 1/2-5/8 (13 to 16) | 2 | 2 |
| PVC, ABS | 3-1/2, 4 (89 to 102) | 3/4-7/8 (19 to 22) | 2 | 1-1/2 |

+Pipe covering material wrap required on pipe on both sides of wall.
The details of the firestop system shall be as follows.

System No. W-L-2004 *continued*

- A. **Steel Sleeve** – Nom 8 in. (203 mm) long cylindrical sleeve with nom 7/8 in. (22 mm) wide by 1-3/4 in. (44 mm) long anchor tabs and nom 3/4 in. (19 mm) long tabs to retain wrap strip layers (Item B). Sheets of precut 0.016 in. (0.41 mm) thick (30 28 gauge) galv sheet steel available from wrap strip manufacturer. As an alternate, cylindrical sleeve may be fabricated from min 0.016 in. (0.41 mm) thick (28 gauge) galv sheet steel in accordance with instruction sheet supplied by wrap strip manufacturer. Sheet steel formed into cylindrical sleeve with inside diam of steel sleeve and diam of through opening in the gypsum board layers to be equal to outside diam of wrap strip (Item B) layers on pipe (0, +1/8 in. (or -0, + 3.2 mm). Cylindrical sleeve inserted in annular space around nonmetallic pipe, centered in wall and locked in position by bending the anchor tabs outward 90 deg against the inner layer of gypsum board within the stud cavity. After installation of wrap strip layers (Item B), retainer tabs of cylindrical sleeve bent 90 deg toward pipe on both sides of wall assembly to lock wrap strip layers in position.
- B. **Fill, Void or Cavity Materials* – Wrap Strip** – Nom 1/4 in. (6 mm) thick intumescent elastomeric material faced on one side with aluminum foil, supplied in 2 in. (51 mm) wide strips. Nom 2 in. (51 mm) wide strips tightly wrapped around nonmetallic pipe (foil side exposed) and slid into steel sleeve on both sides of wall assembly. For nom 1/2 in. (13 mm) to nom 2 in. (51 mm) diam nonmetallic pipes, one layer of wrap strip is required. For nom 2-1/2 in. (64 mm) and nom 3 in. (76 mm) diam nonmetallic pipes, two layers of wrap strip are required. For nom 3-1/2 in. (89 mm) and nom 4 in. (102 mm) diam nonmetallic pipes, three layers of wrap strip are required. Each layer of wrap strip to be installed with butted seam, with butted seams in successive layers staggered. Wrap strip layers on each side of wall to protrude approx 3/4 in. (19 mm) from wall surface with the exposed edges abutting the retainer tabs of the steel sleeve.
3M COMPANY – FS-195+
- C. **Fill, Void or Cavity Materials* – Caulk, Sealant or Putty** – Generous bead applied to outer perimeter of steel sleeve at interface with wall surface and to perimeter of nonmetallic pipe at its egress from the wrap strip layers approx 3/4 in. from the wall surface.
3M COMPANY – CP 25WB+ caulk or MP+ Stix putty, IC 15WB caulk, FireDam 150+ caulk or FB-3000 WT sealant.
(Note: CP 25WB+ and FireDam 150+ not suitable for use with CPVC pipes.)
- D. **Pipe Covering*** – (Not shown) – Nom 1 in. (25 mm) thick hollow cylindrical heavy density (min 3.5 pcf or 56 kg/m³) glass fiber units jacketed on the outside with an all service jacket. When required (see table), min 6 in. (152 mm) length of pipe covering installed around PVC pipe at its egress from steel collar on both sides of the wall. Pipe covering secured to pipe with steel wire ties spaced max 4 in. (102 mm) OC. Edge of pipe covering abutting wrap strip to be sealed with a min 1/4 in. (6 mm) diam bead of caulk (Item C).
See **Pipe And Equipment Covering** – Materials (BRGU) category in the Building Materials Directory for names of manufacturers. Any pipe covering material meeting the above specifications and bearing the UL Classification Marking with a Flame Spread Index of 25 less and a Smoke Developed Index of 50 or less may be used.

*Bearing the UL Classification Mark

Reprinted from the Online Certifications Directory with permission from Underwriters Laboratories Inc.
Copyright © 2010 Underwriters Laboratories Inc.®



Note: Systems with Nonmetallic Through Penetrant(s) have not been evaluated with a pressure differential of 50 Pa between the exposed and unexposed surfaces as required by the National Building Code of Canada.

System No. W-L-2005

April 11, 2006

F Ratings – 1 and 2 Hr

T Ratings – 0, 3/4, 1, 1-1/2 and 2 Hr

L Rating At Ambient – 7 CFM/sq ft

L Rating At 400 F – less than 1 CFM/sq ft

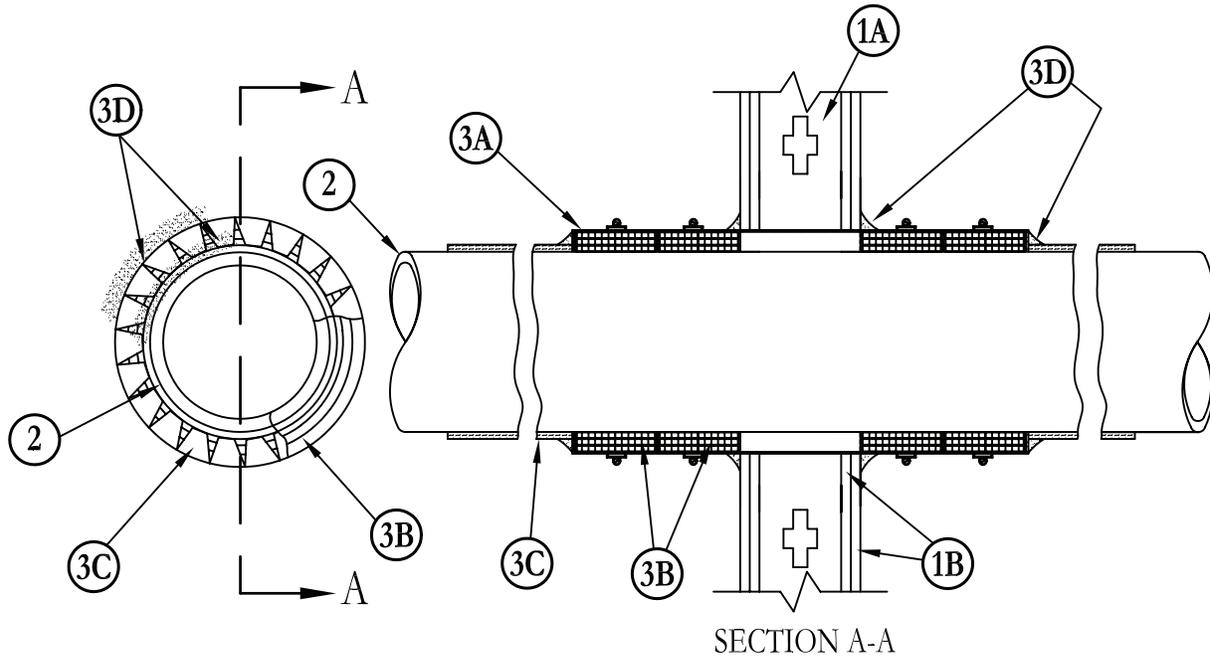

SECTION A-A

- Wall Assembly** – The 1 or 2 hr fire-rated gypsum board/stud wall assembly shall be constructed of the materials and in the manner described in the individual U300, U400 or V400 Series Wall and Partition Design in the UL Fire Resistance Directory and shall include the following construction features:
 - Studs** – Wall framing may consist of either wood studs or steel channel studs. Wood studs to consist of nom 2 by 4 in. 51 by 102 mm lumber spaced 16 in. (406 mm) OC with nom 2 by 4 in. (51 by 102 mm) lumber end plates and cross braces. Steel studs to be min 3-5/8 in. (92 mm) wide by 1-3/8 in. (35 mm) deep channels spaced max 24 in. (610 mm) OC.
 - Gypsum Board*** – 5/8 in. (16 mm) thick, 4 ft (122 cm) wide with square or tapered edges. The gypsum board type, thickness, number of layers, fastener type and sheet orientation shall be as specified in the individual U300, U400 or V400 Series Design in the UL Fire Resistance Directory. Max diam of opening is 13-3/4 in. (349 mm).
- Nonmetallic Pipe** – Nom 6, 8 or 10 in. (152, 203 or 254 mm) diam Schedule 40 polyvinyl chloride (PVC) pipe for use in closed (process or supply) or vented (drain, waste or vent) piping systems. One pipe to be centered in the firestop system. Pipe to be installed near center of stud cavity width and to be rigidly supported on both sides of wall.
- Firestop System** – Installed symmetrically on both sides of wall assembly. The hourly F and T Ratings for the firestop system are dependent upon the size of nonmetallic pipe and the hourly fire rating of the wall assembly in which it is installed, as tabulated below:

| Nom Pipe Diam In. (mm) | Annular Space In. (mm) | Wall Fire Rating Hr | F Rating Hr | T Rating Hr |
|------------------------|------------------------|---------------------|-------------|-------------|
| 6 (152) | 3/4 (19) | 1 | 1 | 1 |
| 6 (152) | 3/4 (19) | 2 | 2 | 2 |
| 8 (203) | 1 (25) | 1 | 1 | 3/4 |
| 8 (203) | 1 (25) | 2 | 2 | 1-1/2 |
| 10 (254) | 1-1/2 (38) | 1 | 1 | 3/4 |
| 10 (254) | 1-1/2 (38) | 2 | 1 | 3/4 |

The details of the firestop system shall be as follows.

- Steel Sleeve** – Cylindrical sleeve fabricated from min 0.016 in. (0.41 mm) thick (28 gauge) galv sheet steel and having a min 1 in. (25 mm) lap along the longitudinal seam. Length of steel sleeve shall be equal to thickness of wall plus 9-1/2 in. (241 mm), 10 in. (254 mm) or 11 in. (279 mm) for the 6, 8 and 10 in. (152, 203 and 254 mm) diam pipe sizes, respectively. Inside diam of steel sleeve and diam of through opening in the gypsum wallboard layers to be equal to outside diam of wrap strip (Item B) layers on pipe. Cylindrical sleeve inserted in annular space around nonmetallic pipe and centered in wall. After installation of wrap strip (Item B) layers, min 1/2 in. (13 mm) wide by min 0.028 in. (0.71 mm) thick stainless steel band clamps installed around steel collar on both sides of wall assembly with one band clamp located near the wall surface and another located approx 1 in. (25 mm) from the outer edge of the wrap strip layers. Edges of steel sleeve to be slit approx 1 in. (25 mm) OC around circumference of sleeve on both sides of wall, with length of slits approximately equal to thickness of mat wrap layers, to form retainer tabs. Retainer tabs bent 90 deg toward pipe to lock wrap strip layer(s) in position.

System No. W-L-2005 continued

- B. **Fill, Void or Cavity Materials* – Wrap Strip** – Nom 1/4 in. (6 mm) thick intumescent elastomeric material faced on one side with aluminum foil, supplied in 2 in. (51 mm) wide by 24 in. (610 mm) long strips. Two stacks of wrap strip (nom 4 in. or 102 mm high stack) tightly-wrapped around nonmetallic pipe on each side of wall and slid into steel sleeve (Item A) such that inner edges are flush with or recessed max 1/4 in. (6 mm) into surface of wall. For nom 6 in. (152 mm) diam pipes, three layers of wrap strip are required in each stack. For nom 8 in. (203 mm) diam pipes, four layers of wrap strip are required in each stack. For nom 10 in. (254 mm) diam pipes, six layers of wrap strip are required in each stack. Each layer of wrap strip to be installed with butted seams, with the butted seams in successive layers staggered. Wrap strips temporarily held in position using aluminum foil tape, filament tape, steel wire tie, or equivalent.

3M COMPANY – Type FS-195+

- C. **Pipe Covering*** – Nom 1 in. (25 mm) thick hollow cylindrical heavy density (min 3.5 pcf or 56 kg/m³) glass fiber units jacketed on the outside with an all service jacket. Min 6 in. (152 mm) length of pipe covering installed around PVC pipe at its egress from the wrap strip layers (Item B) on both sides of the wall. Pipe covering secured to pipe with steel wire ties spaced max 4 in. (102 mm) OC. Edge of pipe covering abutting wrap strip to be sealed with a min 1/4 in. (6 mm) diam bead of caulk (Item D).

See **Pipe And Equipment Covering – Materials** (BRGU) category in the Building Materials Directory for names of manufacturers. Any pipe covering material meeting the above specifications and bearing the UL Classification Marking with a Flame Spread Index of 25 or less and a Smoke Developed Index of 50 or less may be used.

- D. **Fill, Void or Cavity Materials* – Caulk or Sealant** – Generous bead of caulk to be applied to outer perimeter of steel sleeve at interface with wall surfaces and to perimeter of pipe covering material wrap at its interface with the wrap strip layers.

3M COMPANY – CP 25WB+, IC 15WB+, FireDam 150+ caulk or FB-3000 WT sealant

*Bearing the UL Classification Mark

Reprinted from the Online Certifications Directory with permission from Underwriters Laboratories Inc.
Copyright © 2011 Underwriters Laboratories Inc.®

Through Penetrations

Non-Metallic Pipes

2000 Series

Gypsum

WL

System No. W-L-2006

May 23, 2005

F Rating – 2 Hr

T Rating – 0 Hr

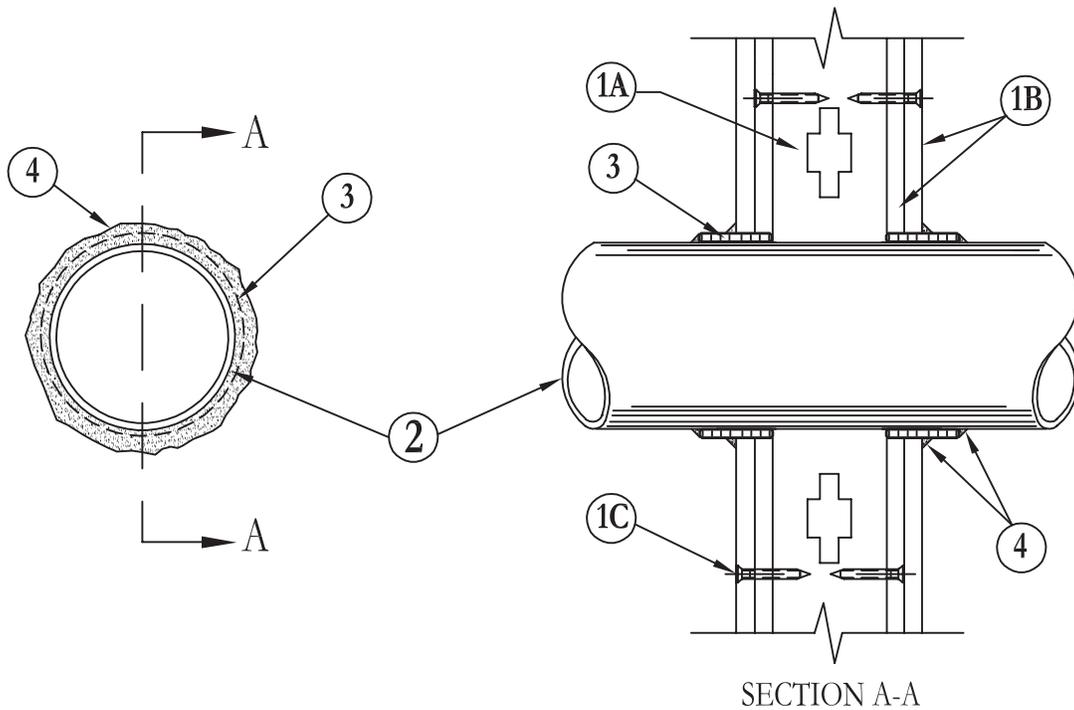

- Wall Assembly** – The fire-rated gypsum board/stud wall assembly shall be constructed of the materials and in the manner described in the individual U300, U400 or V400 Series Wall or Partition Design in the UL Fire Resistance Directory and shall include the following construction features:
 - Studs** – Wall framing may consist of either wood studs or steel channel studs. Wood studs to consist of nom 2 in. by 4 in. (51 mm by 102 mm) lumber spaced 16 in. (406 mm) OC with nom 2 in. by 4 in. (51 mm by 102 mm) lumber end plates and cross braces. Steel studs to be min 3-5/8 in. (92 mm) wide by 1-3/8 in. (35 mm) deep channels spaced max 24 in. (610 mm) OC.
 - Gypsum Board*** – Two layers of nom 5/8 in. (16 mm) thick gypsum board, as specified in the individual Wall or Partition Design in the UL Fire Resistance Directory. Max diam of opening is 7 in. (178 mm).
- Through Penetrants* – Glass Pipe** – 1/2 in., 3/4 in., 1 in., 1-1/2 in., 2 in., 3 in., 4 in. or 6 in. diam (13 mm, 19 mm, 25 mm, 51 mm, 76 mm, 102 mm or 152 mm) glass pipe for use in closed (process or supply) or vented (drain, waste or vent) piping systems. Max one glass pipe per opening. Pipe to be rigidly supported on both sides of wall assembly. Pipe couplings to be located min 12 in. (305 mm) from wall surfaces. A clearance of 1/4 in. to 3/8 in. (6 mm to 10 mm) is required between the glass pipe and the sides of the cutouts made in the gypsum board wall.

SCHOTT SCIENTIFIC GLASS

- Fill, Void or Cavity Materials* – Wrap Strip** – Nom 1/4 in. (6 mm) thick intumescent elastomeric material faced on one side with aluminum foil, supplied in 2 in. (51 mm) wide strips. Nom 2 in. (51 mm) wide strip tightly wrapped around pipe (foil side out) with seam butted. Wrap strip layer securely bound with steel wire or aluminum foil tape and slid into annular space approx 1-1/4 in. (32 mm) such that approx 3/4 in. (19 mm) of the wrap strip width protrudes from the wall surface. Wrap strip installed symmetrically on both sides of the wall assembly.

3M COMPANY – FS-195+
- Fill, Void or Cavity Materials* – Caulk or Sealant** – Min 1/4 in. (6 mm) diam continuous bead applied to leading edge of wrap strip layer (Item 3) prior to insertion of wrap strip layer into annular space. After insertion of wrap strip layer in annular space, a nom 1/4 in. (6 mm) diam continuous bead is to be applied to the wrap strip/wall interface and to the exposed edge of the wrap strip layer located approx 3/4 in. (19 mm) from the wall surface. When armored glass process pipe is used, the pipe should be wrapped with a 2 to 3 mil thick pressure-sensitive aluminum foil tape to prevent contact between the caulk fill material and the armored pipe.

3M COMPANY – CP 25WB+, IC 15WB+, FireDam 150+ caulk or FB-3000 WT sealant

*Bearing the UL Classification Marking

Reprinted from the Online Certifications Directory with permission from Underwriters Laboratories Inc.

Copyright © 2011 Underwriters Laboratories Inc.®

System No. W-L-2031

May 23, 2005

F Rating – 2 Hr

T Rating – 1-1/2 Hr

L Rating At Ambient – 7 CFM/sq ft

L Rating At 400 F – less than 1 CFM/sq ft

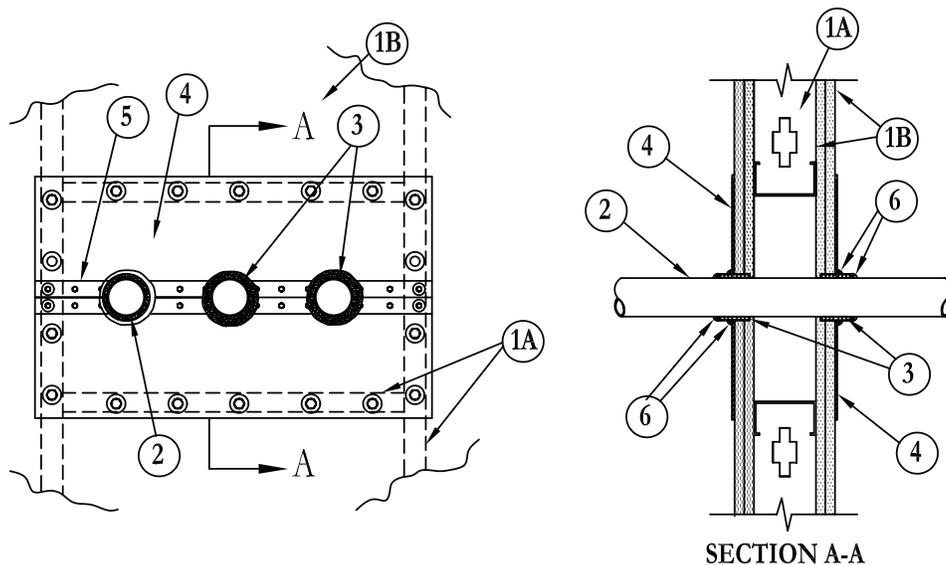

- Wall Assembly** – The fire-rated gypsum board/steel stud wall assembly shall be constructed of the materials and in the manner described in the individual U400 or V400 Series Wall and Partition Design in the UL Fire Resistance Directory and shall include the following construction features:

- Steel Studs** – Steel studs to be min 3-5/8 in. (92 mm) deep and spaced max 24 in. (610 mm) OC. The opening in the wall to accommodate the pipes (Item 2) shall be framed on all sides using lengths of steel stud installed between the vertical studs and screw-attached to the steel studs at each end. The framed opening in the wall shall be max 22-1/2 in. (572 mm) wide and 8 in. (203 mm) high.
- Gypsum Board*** – Two layers of nom 5/8 in. (16 mm) thick gypsum board, as specified in the individual Wall and Partition Design.

- Nonmetallic Pipe** – Nom 2 in. (51 mm) diam (or smaller) Schedule 40 solid core polyvinyl chloride (PVC) pipe for use in closed (process or supply) or vented (drain, waste or vent) piping systems or SDR13.5 chlorinated polyvinyl chloride (CPVC) pipe for use in closed (process or supply) piping systems. A min separation of 2 in. (51 mm) shall be maintained between pipes and between pipes and periphery of opening. Pipes to be rigidly supported on both sides of wall assembly.

- Fill, Void or Cavity Materials* – Wrap Strip** – Nom 1/4 in. (6 mm) thick intumescent elastomeric material faced on one side with aluminum foil, supplied in nom 2 in. (51 mm) wide strips. Nom 2 in. (51 mm) wide wrap strip tightly-wrapped around each PVC pipe (foil side exposed) and secured in place with steel wire ties. Wrap strips to project approx 7/8 in. (22 mm) beyond each face of the intumescent sheet (Item 4) on each side of wall.

3M COMPANY – FS-195+

- Fill, Void or Cavity Materials* – Intumescent Sheet** – Rigid aluminum foil-faced sheet with galv sheet steel backer. Sheets cut to tightly-follow the contours of the wrap strip (Item 3) on each PVC pipe. Sheets cut to lap a min of 2 in. (51 mm) on the wall on all sides of the opening on both sides of the wall. Prior to installation, a min 1/4 in. (6 mm) diam bead of caulk (Item 6) shall be applied as a gasket approx 1 in. (25 mm) from and on all sides of the through opening. Sheet to be installed with the galv sheet steel backer exposed (aluminum foil facing against wall surface) and secured to steel framing, through gypsum board layers, with min 1/4 in. (6 mm) diam by 2-1/4 in. (57 mm) long steel screws in conjunction with min 1-1/4 in. (32 mm) diam steel fender washers. Max spacing of fasteners not to exceed 6 in. (152 mm) with additional fasteners located on each side of butted seams or slits made to permit installation of the sheet around the individual pipes.

3M COMPANY – CS-195+

- Steel Cover Strip** – Min 2 in. (51 mm) wide strip of min 0.020 in. (0.51 mm) thick (26 gauge) galv steel centered over entire length of each butted seam or slit made in the intumescent sheet (Item 4). Prior to installation of the steel strip, the seam or slit in the intumescent sheet shall be covered with a nom 1/4 in. (6 mm) diam bead of caulk (Item 6). Steel cover strip secured to galv steel sheet backer of intumescent sheet with steel sheet metal screws or steel rivets spaced max 3 in. (76 mm) OC on each side of seam or slit.

- Fill, Void or Cavity Materials* – Graphite Seal, Caulk, Sealant or Putty** – One layer of 1/2 in. x 1/16 in. (13 mm x 1.6 mm) adhesive backed graphite intumescent seal positioned under intumescent sheet around entire perimeter of through opening or min 1/4 in. (6 mm) diam continuous bead of caulk or putty applied to edge of intumescent sheet at its interface with surface of floor or wall around entire perimeter of through opening. Generous application of caulk to be applied around base of wrap strip at its egress from the intumescent sheet on each side of wall assembly. An additional bead of caulk shall be applied to the exposed edge of each wrap strip layer.

3M COMPANY – E-FIS, Ultra GS seals, CP 25WB+, IC 15WB+ caulk, FB-3000 WT sealant or MP+ Stix Putty

(Note: CP 25WB+ not suitable for use with CPVC pipes.)

*Bearing the UL Classification Marking

Reprinted from the Online Certifications Directory with permission from Underwriters Laboratories Inc.

Copyright © 2010 Underwriters Laboratories Inc.®



Note: Systems with Nonmetallic Through Penetrant(s) have not been evaluated with a pressure differential of 50 Pa between the exposed and unexposed surfaces as required by the National Building Code of Canada.

System No. W-L-2032

May 23, 2005

F Rating – 2 Hr

T Rating – 1-1/2 Hr

L Rating At Ambient – 15 CFM/sq ft

L Rating At 400 F – less than 1 CFM/sq ft

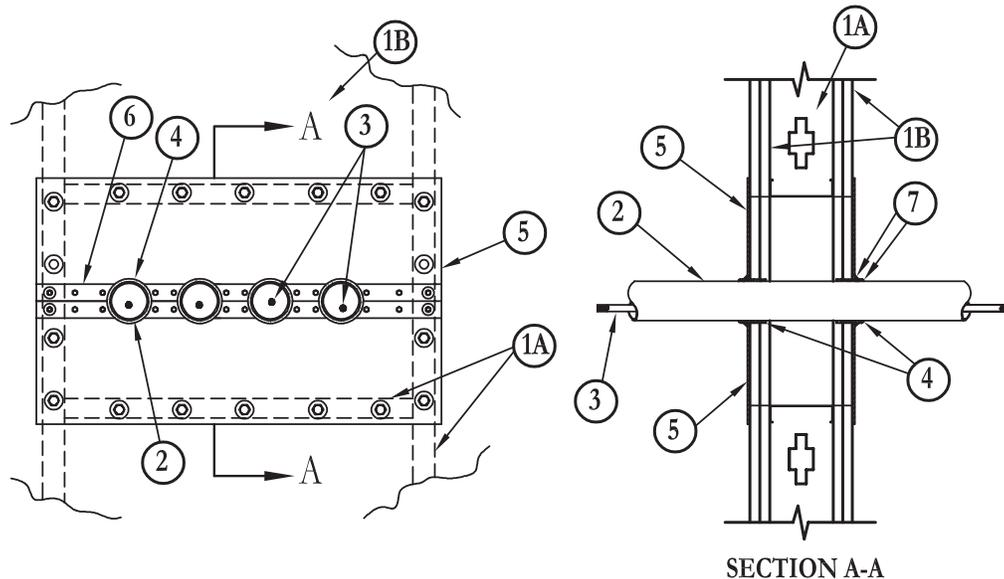

SECTION A-A

- Wall Assembly** – The fire-rated gypsum board/steel stud wall assembly shall be constructed of materials and in the manner described in the individual U400 or V400 Series Wall and Partition Design in the UL Fire Resistance Directory and shall include the following construction features:
 - Steel Studs** – Steel studs to be min 3-5/8 in. (92 mm) deep and spaced max 24 in. (610 mm) OC. The opening in the wall to accommodate the ENT (Item 2) shall be framed on all sides using lengths of steel stud installed between the vertical studs and screw-attached to the steel studs at each end. The framed opening in the wall shall be max 22-1/2 in. (57 mm) wide and 8 in. (203 mm) high.
 - Gypsum Board*** – Two layers of nom 5/8 in. (16 mm) thick gypsum board, as specified in the individual Wall and Partition Design.
- Electrical Nonmetallic Tubing#** – Nom 2 in. (51 mm) diam (or smaller) ENT constructed of polyvinyl chloride (PVC). Min separation between ENT is 2 in. (51 mm) Min clearance between ENT and perimeter of framed opening in wall is 2 in. (51 mm) ENT to be rigidly supported on both sides of wall assembly. Ends of ENT to terminate in air tight junction boxes.
See **Electrical Nonmetallic Tubing (FKHU)** category in Electrical Construction Materials Directory for names of manufacturers.
- Fiber Optic Cable** – Multiple fiber optical communication cable jacketed with PVC and having a max outside diam of 5/8 in. (16 mm).
- Fill, Void or Cavity Materials* – Wrap Strip** – Nom 1/4 in. (6 mm) thick intumescent elastomeric material faced on one side with aluminum foil, supplied in nom 2 in. (51 mm) wide strips. Nom 2 in. (51 mm) wide strip tightly-wrapped around each ENT (foil side exposed) and secured in place with steel wire ties. Wrap strip to extend approx 7/8 in. (22 mm) beyond each face of the intumescent sheet (Item 5) on both sides of the wall assembly.
3M COMPANY – FS-195+
- Fill, Void or Cavity Materials* – Intumescent Sheet** – Rigid aluminum foil-faced sheet with galv steel sheet backer. Sheets cut to tightly-follow the contours of the wrap strip (Item 4) around each ENT. Sheets cut to lap a min of 2 in. (51 mm) on the wall on all sides of the opening on both sides of the wall. Prior to installation, a min 1/4 in. (6 mm) diam bead of caulk (Item 7) shall be applied as a gasket approx 1 in. (25 mm) from and on all sides of the through opening. Sheet to be installed with the galv steel sheet backer exposed (aluminum foil facing against wall surface) and secured to steel framing, through gypsum board layers, with min 1/4 in. (6 mm) diam by 2-1/4 in. (57 mm) long steel screws in conjunction with min 1-1/4 in. (32 mm) diam steel fender washers. Max spacing of fasteners not to exceed 6 in. (152 mm) with additional fasteners located on each side of batted seams or slits made to permit installation of the sheet around the ENT.
3M COMPANY – CS-195+
- Steel Cover Strip** – Min 2 in. (51 mm) wide strip of min 0.020 in. (0.51 mm) thick (26 gauge) galv steel centered over entire length of each butted seam or slit made in the intumescent sheet (Item 5). Prior to installation of the steel strip, the seam or slit in the intumescent sheet shall be covered with a nom 1/4 in. (6 mm) diam bead of caulk (Item 7). Steel cover strip secured to galv steel sheet backer of intumescent sheet with steel sheet metal screws or steel rivets spaced max 3 in. (76 mm) OC on each side of seam or slit.
- Fill, Void or Cavity Materials* – Graphite Seal, Caulk, Sealant or Putty** – One layer of 1/2 in. x 1/16 in. (13 mm x 1.6 mm) adhesive backed graphite intumescent seal positioned under intumescent sheet around entire perimeter of through opening or min 1/4 in. (6 mm) diam continuous bead of caulk or putty applied to edge of intumescent sheet at its interface with surface of floor or wall around entire perimeter of through opening. Generous application of caulk to be applied around the base of each contour applied wrap strip at its egress from the intumescent sheet on both sides of the wall assembly. An additional bead of caulk shall be applied to the exposed edge of each wrap strip.
3M COMPANY – E-FIS, Ultra GS seals, CP 25WB+, IC 15WB+ caulk, FB-3000 WT sealant or MP+ Stix putty

#Bearing the UL Listing Mark

*Bearing the UL Classification Marking

Reprinted from the Online Certifications Directory with permission from Underwriters Laboratories Inc.

Copyright © 2010 Underwriters Laboratories Inc.®



Note: Systems with Nonmetallic Through Penetrant(s) have not been evaluated with a pressure differential of 50 Pa between the exposed and unexposed surfaces as required by the National Building Code of Canada.

System No. W-L-2033

May 23, 2005

F Rating – 2 Hr

T Rating – 1-1/2 Hr

L Rating At Ambient – 15 CFM/sq ft

L Rating At 400 F – less than 1 CFM/sq ft

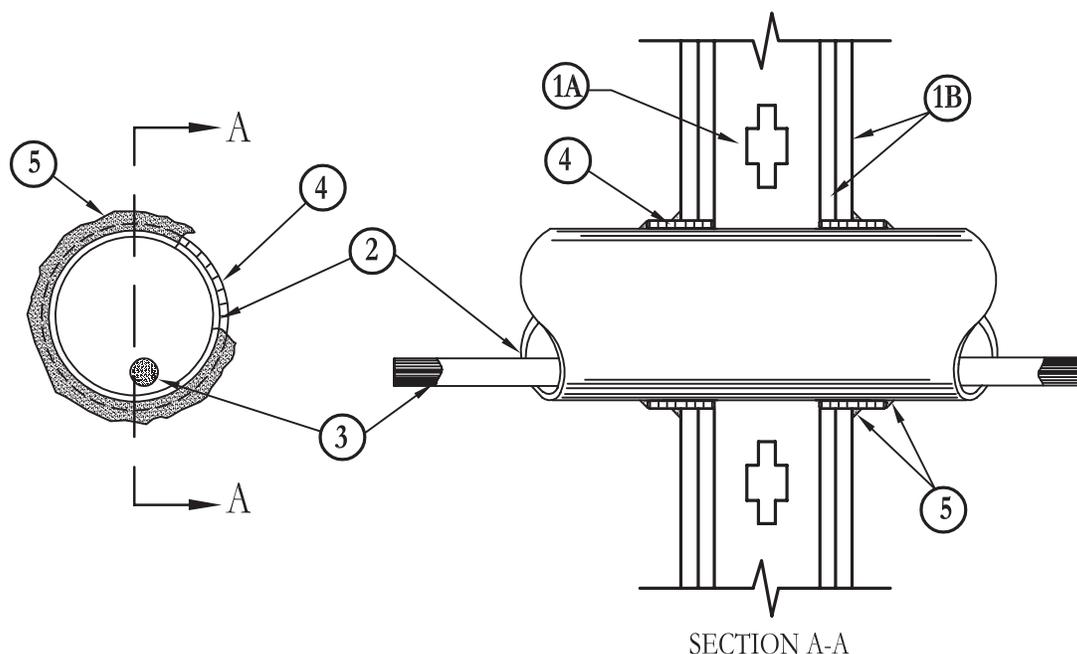

1. **Wall Assembly** – The fire-rated gypsum board/stud wall assembly shall be constructed of the materials and in the manner described in the individual U300, U400 or V400 Series Wall and Partition Design in the UL Fire Resistance Directory and shall include the following construction features:
 - A. **Studs** – Wall framing may consist of either wood studs or steel channel studs. Wood studs to consist of nom 2 in. by 4 in. (51 mm by 102 mm) lumber spaced 16 in. (406 mm) OC. Steel studs to be min 3-5/8 in. (92 mm) wide and spaced max 24 in. (610 mm) OC.
 - B. **Gypsum Board*** – Two layers of nom 5/8 in. (16 mm) thick gypsum board, as specified in the individual Wall and Partition Design. Diam of opening cut in gypsum board layers on each side of wall assembly to be 1/2 in. to 3/4 in. (13 mm to 19 mm) larger than outside diam of ENT (Item 2) such that, when installed, a 1/4 in. to 3/8 in. (6 mm to 10 mm) annular space will be present between the ENT and the gypsum board around the entire circumference of the opening. Max diam of opening is 3 in. (76 mm).
2. **Electrical Nonmetallic Tubing#** – Nom 2 in. (51 mm) diam (or smaller) ENT constructed of polyvinyl chloride (PVC). One ENT centered in circular openings in gypsum board layers and rigidly supported on both sides of the wall assembly.
See **Electrical Nonmetallic Tubing** (FKHU) category in Electrical Construction Materials Directory for names of manufacturers.
3. **Fiber Optic Cable** – Multiple fiber optical communication cable jacketed with PVC and having a max outside diam of 5/8 in. (16 mm).
4. **Fill, Void or Cavity Materials* – Wrap Strip** – Nom 1/4 in. (6 mm) thick intumescent elastomeric material faced on one side with aluminum foil, supplied in 2 in. (51 mm) wide strips. Nom 2 in. (51 mm) wide strip tightly wrapped around (foil side out) with seam butted. Wrap strip layer securely bound with steel wire or aluminum foil tape and slid into annular space approx 1-1/4 in. (32 mm) such that approx 3/4 in. (19 mm) of the wrap strip width protrudes from the wall surface on each side of wall assembly.
3M COMPANY – FS-195+
5. **Fill, Void or Cavity Materials* – Caulk or Sealant** – Min 1/4 in. (6 mm) diam continuous bead applied to leading edge of wrap strip layer (Item 4) prior to insertion of wrap strip layer into annular space. After insertion of wrap strip layer in annular space, a nom 1/4 in. (6 mm) diam continuous bead is to be applied to the wrap strip/wall interface and to the exposed edge of the wrap strip approx 3/4 in. (19 mm) from the wall surface on each side of the wall assembly.
3M COMPANY – CP 25WB+, IC 15WB+, FireDam 150+ caulk or FB-3000 WT sealant

#Bearing the UL Listing Mark

*Bearing the UL Classification Marking

Reprinted from the Online Certifications Directory with permission from Underwriters Laboratories Inc.

Copyright © 2010 Underwriters Laboratories Inc.®



Note: Systems with Nonmetallic Through Penetrant(s) have not been evaluated with a pressure differential of 50 Pa between the exposed and unexposed surfaces as required by the National Building Code of Canada.

System No. W-L-2058

March 27, 2009

F Rating – 1 Hr

FT Rating – 1 Hr

FH Rating – 1 Hr

FTH Rating – 1 Hr

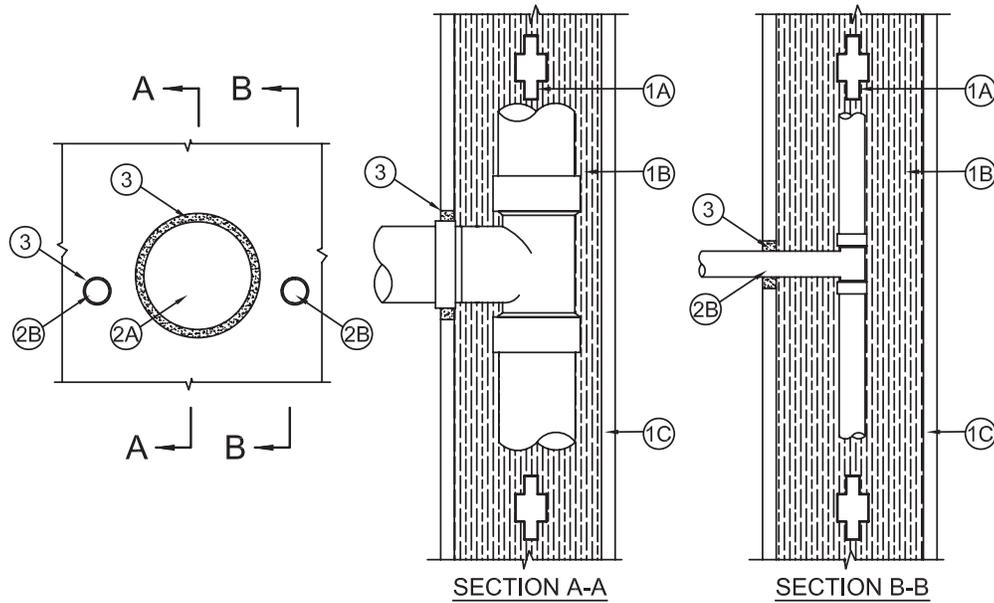
L Rating at Ambient – Less than 5.1 L/s/m²L Rating at 250° C – 15.2 L/s/m²

System tested with a pressure difference of 50 Pa between the exposed and unexposed surfaces with the higher pressure on the exposed surface.

- Wall Assembly** – The fire-rated gypsum board/stud wall assembly shall be constructed of the materials and in the manner specified in the individual U300 or U400 Series Wall and Partition Designs in the UL Fire Resistance Directory and shall include the following construction features:
 - Studs** – Wall framing may consist of either wood studs or steel channel studs. Wood studs to consist of nom 51 by 102 mm (2 by 4 in.) lumber spaced 406 mm (16 in.) OC. Steel studs to be min 92 mm (3-5/8 in) wide and spaced max 610 mm (24 in.) OC.
 - Insulation*** – R13 (or higher) glass fiber or mineral fiber batt insulation friction fitted into stud cavity.
 - Gypsum Board*** – One layer of nom 16 mm (5/8 in.) thick gypsum board, as specified in the individual Wall and Partition Design. Max diam of openings shall be 76 mm (3 in.).
- Penetrants** – One nonmetallic pipe or tube per opening, for use in closed (process or supply) or vented (drain, waste or vent) piping systems, installed within stud cavity and connected to tee. Pipe, tee or tube penetrating wall on one side to be installed either concentrically or eccentrically within the firestop system. The annular space between the pipe, tee or tube and the edge of the opening shall be min 6 mm (1/4 in.) to max 10 mm (3/8 in.). The following types and sizes of nonmetallic pipes or tubes may be used:
 - Polyvinyl Chloride (PVC) Pipe** – Nom 51 mm (2 in.) diam (or smaller) Schedule 40 solid core PVC pipe with PVC tee.
 - Acrylonitrile Butadiene Styrene (ABS) Pipe** – Nom 38 mm (1-1/2 in.) diam (or smaller) Schedule 40 solid core ABS pipe with ABS tee.
 - Polyvinyl Chloride-XFR (PVC-XFR) Pipe** – Nom 51 mm (2 in) diam (or smaller) Schedule 40 solid core PVC-XFR pipe with PVC-XFR tee.
 - Crosslinked Polyethylene (PEX) Tubing** – Nom 19 mm (3/4 in.) diam (or smaller) SDR 9 PEX tubing with brass, copper or polysulfone tees.
 - Polyethylene/Aluminum/Polyethylene (PE/AL/PE) Tubing** – Nom 19 mm (3/4 in.) diam (or smaller) PE/AL/PE tubing with brass or copper tees.
 - Crosslinked Polyethylene/Aluminum/Crosslinked Polyethylene (PEX/AL/PEX) Tubing** – Nom 19 mm (3/4 in.) diam (or smaller) SDR 9 PEX tubing with brass or copper tees.
- Fill, Void or Cavity Material* – Sealant** – Min 16 mm (5/8 in.) thickness of fill material applied within the annulus, flush with surface of wall.

3M COMPANY**3M FIRE PROTECTION PRODUCTS** – FB-3000 WT sealant

*Bearing the UL Classification Mark

Reprinted from the Online Certifications Directory with permission from Underwriters Laboratories Inc.

Copyright © 2010 Underwriters Laboratories Inc.®



Note: Systems with Nonmetallic Through Penetrant(s) have not been evaluated with a pressure differential of 50 Pa between the exposed and unexposed surfaces as required by the National Building Code of Canada.

System No. W-L-2073

November 20, 2009

F Ratings – 1 and 2 Hr (See Item 3)

T Ratings – 0, 1 and 2 Hr (See Item 2)

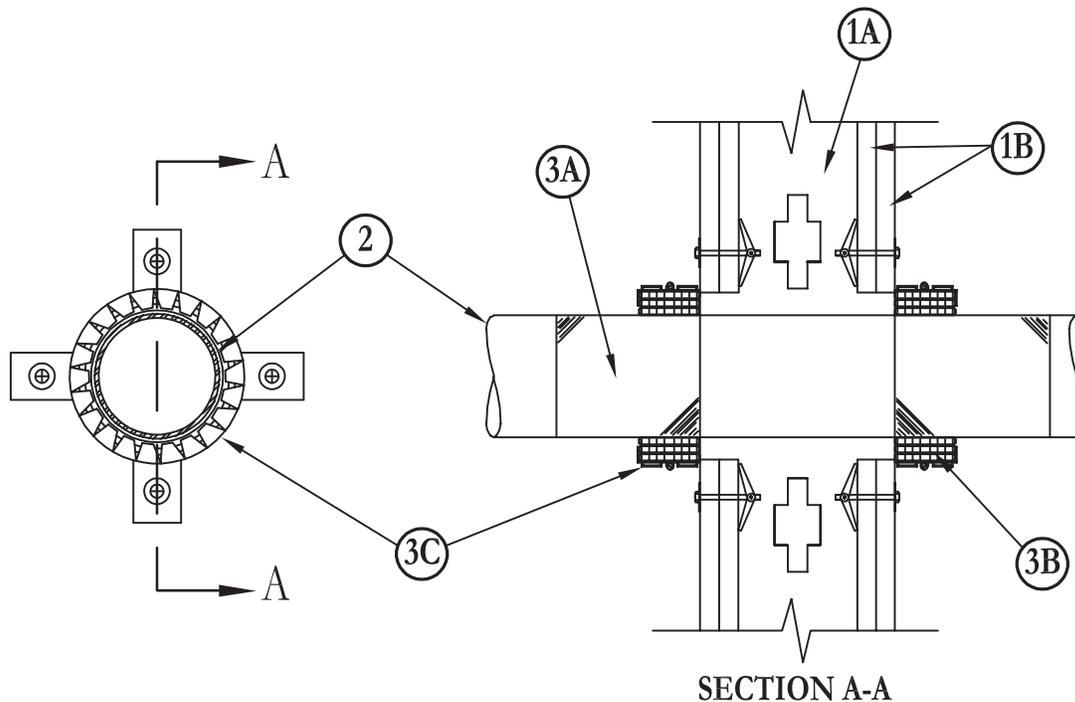

1. **Wall Assembly** – The 1 or 2 hr fire-rated gypsum board/stud wall assembly shall be constructed of the materials and in the manner described in the individual U300, U400 or V400 Series Wall and Partition Design in the UL Fire Resistance Directory and shall include the following construction features:

- A. **Studs** – Wall framing may consist of either wood studs or steel channel studs. Wood studs to consist of nom 2 by 4 in. (51 by 102 mm) lumber spaced 16 in. (406 mm) OC with nom 2 by 4 in. (51 by 102 mm) lumber end plates and cross braces. Steel studs to be min 3-5/8 in. (92 mm) wide by 1-3/8 in. (35 mm) deep channels spaced max 24 in. (610 mm) OC.
- B. **Gypsum Board*** – Thickness, type, number of layers and fasteners as required in the individual Wall and Partition Design. Diam of opening shall be a max of 1/8 in. (3.2 mm) larger than the outside diam of nom 2 in. (51 mm) diam (and smaller) nonmetallic pipes or conduits (Item 2) and a max of 1/2 in. (13 mm) larger than the outside diam of nom 2-1/2 in. (64 mm) diam (and larger) nonmetallic pipes or conduits.

The hourly F Rating of the firestop system is equal to the hourly fire rating of the wall assembly in which it is installed.

2. **Through Penetrants** – One nonmetallic pipe or conduit to be centered within the firestop system. Pipe or conduit to be rigidly supported on both sides of floor or wall assembly. The following types and sizes of nonmetallic pipes or conduits may be used:
 - A. **Polyvinyl Chloride (PVC) Pipe** – Nom 4 in. (102 mm) diam (or smaller) Schedule 40 solid core PVC pipe for use in closed (process or supply) or vented (drain, waste or vent) piping systems.
 - B. **Rigid Nonmetallic Conduit**** – Nom 4 in. (102 mm) diam (or smaller) Schedule 40 solid core PVC conduit.
 - C. **Chlorinated Polyvinyl Chloride (CPVC) Pipe** – Nom 4 in. (102 mm) diam (or smaller) SDR13.5 CPVC pipe for use in closed (process or supply) piping systems.
 - D. **Polyvinyl Chloride (PVC) Pipe** – Nom 3 in. (76 mm) diam (or smaller) Schedule 40 cellular core PVC pipe for use in closed (process or supply) or vented (drain, waste or vent) piping systems.
 - E. **Acrylonitrile Butadiene Styrene (ABS) Pipe** – Nom 4 in. (102 mm) diam (or smaller) Schedule 40 solid core or cellular core ABS pipe for use in closed (process or supply) or vented (drain, waste or vent) piping systems.
 - F. **Flame Retardant Polypropylene (FRPP) Pipe** – Nom 3 in. (76 mm) diam Schedule 40 FRPP pipe for use in closed (process or supply) or vented (drain, waste or vent) piping systems.

When nom 3-1/2 or 4 in. (89 or 102 mm) diam pipe is used, T Rating is 0 hr. When nom 3 in. (76 mm) diam (or smaller) pipe is used, the T Rating is equal to the hourly fire rating of the wall assembly in which it is installed.

3. **Firestop System** – The details of the firestop system shall be as follows:
 - A. **Foil Tape** – Nom 4 in. (102 mm) wide, 3 mil thick aluminum tape wrapped around pipe or conduit prior to the installation of the wrap strip (Item 3B). Min of one wrap, flush with the wall surfaces on both sides of the wall assembly. Foil tape is not required for solid core PVC and CPVC pipes and conduits.
 - B. **Fill, Void or Cavity Materials* – Wrap Strip** – 1 in. (25 mm) wide, nom 1/4 in. (6 mm) thick intumescent elastomeric material faced on one side with aluminum foil. Wrap strip(s) tightly wrapped around pipe or conduit (foil side exposed) and butted against the wall surfaces on both sides of the wall assembly. Each layer of wrap strip to be installed with butted seam, with butted seams in successive

System No. W-L-2073 continued

layers staggered. Wrap strip(s) temporarily held in position using aluminum foil tape, steel wire tie, or equivalent. The min number of wrap strip layers is dependent on the size of the pipe or conduit as shown below:

| Nom Pipe/Conduit Diam (mm) | No. of Wrap Strip Layers |
|----------------------------|--------------------------|
| 1-1/2 to 2 in. (38 to 51) | 1 |
| 2-1/2 to 3 in. (64 to 76) | 3 |
| 3-1/2 to 4 in. (89 to 102) | 4 |

3M COMPANY – FS-195+

- C. **Steel Collar** – Nom 1 in. (25 mm) deep collar with 1-1/4 in. (32 mm) wide by 2 in. (51 mm) long anchor tabs and min 1/2 in. (13 mm) long tabs to retain wrap strip.

Coils of precut min 0.016 in. (0.41 mm) thick (No. 28 gauge) galv sheet steel available from wrap strip manufacturer. As an alternate, collar may be field-fabricated from min 0.016 in. (0.41 mm) thick (28 gauge) galv sheet steel in accordance with instruction sheet supplied by wrap strip manufacturer. Collar, with anchor tabs bent outward 90 degree, wrapped tightly around wrap strip with min 1 in. (25 mm) overlap at seam and compressed around wrap strip(s) using a min 1/2 in. (13 mm) wide by min 0.028 in. (0.71 mm) thick stainless steel band clamp at the collar midheight. As an alternate to the band clamps, collars may be secured by a means No. 10 by 1/2 in. (13 mm) long sheet metal screws installed in the vertical axis at the center of the 1 in. (25 mm) overlap along the perimeter joint of the collar. A min of three screws is required. Collar anchor tabs pressed tightly against wall surfaces, and secured to wall surfaces with 3/16 in. (5 mm) diam steel toggle bolts, or equivalent, in conjunction with min 1-1/4 in. (32 mm) diam steel fender washers. Min three anchor bolts for nom 1/2 to 2 in. (13 to 51 mm) pipes or conduits, min 4 anchor bolts for nom 2-1/2 and 3 in. (64 and 76 mm) pipes or conduits and min 5 anchor bolts for nom 3-1/2 and 4 in. (89 and 102 mm) pipes or conduits, symmetrically located. Retainer tabs bent 90 deg toward pipe to lock wrap strip(s) in position.

- D. **Fill, Void or Cavity Materials* – Caulk, Sealant or Putty** – (Optional – Not Shown) – Generous bead of caulk or putty applied to outer perimeter of wrap strip at interface with wall surfaces and to perimeter of pipe or conduit at its egress from the wrap strip layers.

3M COMPANY – CP 25WB+, MP+ Stix, IC 15WB+, FireDam 150+ caulk or FB-3000 WT sealant.
(Note: CP 25WB+ and FireDam 150+ not suitable for use with CPVC pipes.)

- E. **Firestop Device*** – (Not Shown) – As an alternate to Item A and B when nom 1-1/2, 2, 3 or 4 in. (38, 51, 76 or 102 mm) diam nonmetallic pipes are used, a firestop device consisting of a sheet-steel split collar lined with intumescent material and provided with steel clips for attachment may be used. Firestop device to be installed on underside of top plate or on both sides of wall in accordance with the accompanying installation instructions.

3M COMPANY – PPD 150, PPD 200, PPD 300, PPD 400, PPD 1.5, PPD 2, PPD 3

**Bearing the UL Listing Mark

*Bearing the UL Classification Mark

Reprinted from the Online Certifications Directory with permission from Underwriters Laboratories Inc.
Copyright © 2011 Underwriters Laboratories Inc.®

Through Penetrations

Non-Metallic Pipes

2000 Series

Gypsum

W/L

System No. W-L-2087

November 20, 2009

F Ratings – 1 and 2 Hr (See Item 1)

T Ratings – 0 and 3/4 Hr (See Item 1)

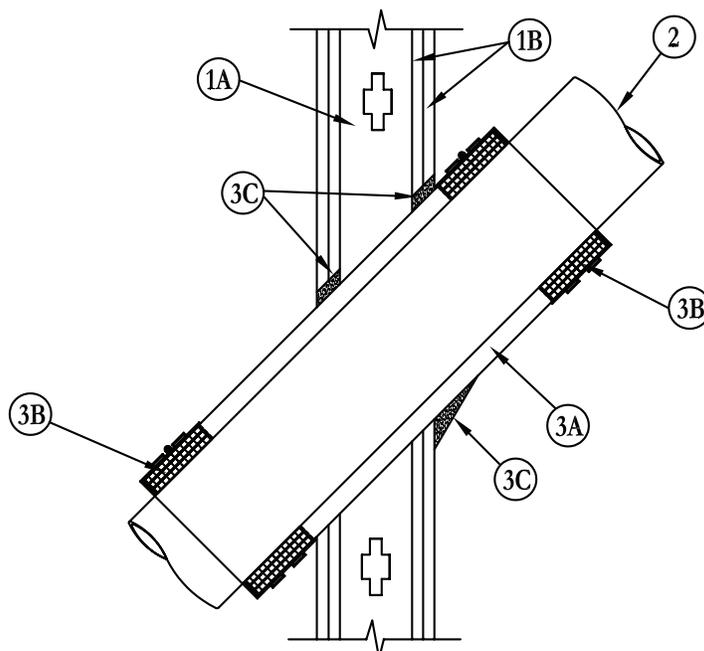

- Wall Assembly** – The fire rated gypsum board/stud wall assembly shall be constructed of the materials and in the manner specified in the individual U300, U400 or V400 Series Wall and Partition Designs in the UL Fire Resistance Directory and shall include the following construction features:
 - Studs** – Wall framing may consist of either wood studs or steel channel studs. Wood studs to consist of nom 2 by 4 in. (51 by 102 mm) lumber spaced 16 in. (406 mm) OC. Steel studs to be min 3-1/2 in. (89 mm) wide and spaced max 24 in. (610 mm) OC.
 - Gypsum Board*** – Thickness, type, number of layers and fasteners as required in the individual Wall and Partition Design. Diam of opening to be max 1/2 in. (13 mm) larger than the outside diam of steel sleeve (Item 3A).

The hourly F Rating of the firestop system is equal to the hourly fire rating of the wall assembly in which it is installed. The T Ratings are 0 and 1/2 hr when installed in 1 hr and 2 hr rated walls, respectively.
- Through Penetrants** – One nonmetallic pipe or conduit to be centered within the firestop system. Pipe or conduit to be rigidly supported on both sides of floor or wall assembly. The pipe or conduit may be installed at an angle not greater than 45 degrees from perpendicular. The following types and sizes of nonmetallic pipes or conduits may be used:
 - Polyvinyl Chloride (PVC) Pipe** – Nom 4 in. (102 mm) diam (or smaller) Schedule 40 solid core or cellular core polyvinyl chloride (PVC) pipe for use in closed (process or supply) or vented (drain, waste or vent) piping systems.
 - Chlorinated Polyvinyl Chloride (CPVC) Pipe** – Nom 4 in. (102 mm) diam (or smaller) SDR13.5 chlorinated polyvinyl chloride (CPVC) pipe for use in closed (process or supply) piping systems.
 - Acrylonitrile Butadiene Styrene (ABS) Pipe** – Nom 4 in. (102 mm) diam (or smaller) Schedule 40 (or heavier) solid core or cellular core acrylonitrile butadiene styrene (ABS) pipe for use in closed (process or supply) or vented (drain, waste or vent) piping systems.
- Firestop System** – The firestop system shall consist of the following:
 - Metallic Sleeve** – Cylindrical sleeve fabricated from min 0.019 in. (0.48 mm) thick (26 gauge) galv sheet steel and having a min 1 in. (25 mm) lap along the longitudinal seam. Sleeve to extend a min of 2 in. (51 mm) beyond both sides of the wall. The inside diam of the sleeve shall be larger than outside diam of nonmetallic pipe or conduit such that an annular space will be present between the steel sleeve and the pipe around the entire circumference of the pipe to accommodate the layer(s) of wrap strips (Item 3B). The annular space between the outside of the wrap strip layer(s) and the inside of the sleeve shall be min 0 in. (0 mm, point contact) to max 1/4 in. (6 mm). The annular space between the outside of the sleeve and the periphery of the opening shall be min 0 in. (0 mm, point contact) to max 1/2 in. (13 mm).
 - Fill, Void or Cavity Materials* – Wrap Strip** – Nom 1/4 in. (6 mm) thick intumescent elastomeric material faced on one side with aluminum foil, supplied in 2 in. (51 mm) wide strips. Nom 2 in. (51 mm) wide strips tightly wrapped around nonmetallic pipe (foil side exposed) and slid into sleeve on both sides of wall such that the outer edges of wrap strips are flush with the outer edges of the sleeve. For nom 1/2 in. (13 mm) to nom 1-1/2 in. (38 mm) diam pipes, a min of one layer of wrap strip is required. For nom 2 in., 2-1/2 in. and 3 in. (51 mm, 64 mm and 76 mm) diam pipes, a min of two layers of wrap strip is required. For nom 3-1/2 in. and 4 in. (89 and 102 mm) diam pipes, a min of three layers of wrap strip is required. Each layer of wrap strip to be installed with butted seam with butted seams in successive layers staggered. Wrap strip layers held in position using aluminum foil tape, steel wire tie, or equivalent. A min 1/2 in. (13 mm) wide stainless steel hose clamp shall be secured around the outside of the sleeve over the center of the wrap strips on both ends of the sleeve.

3M COMPANY – Type FS-195+

Through Penetrations

Non-Metallic Pipes

2000 Series

Gypsum

WL

System No. W-L-2087 continued

- C. **Fill, Void or Cavity Materials* – Caulk or Sealant** – Min thickness of 5/8 in. (16 mm) and 1-1/4 in. (32 mm) for 1 and 2 hr rated wall assemblies, respectively, applied within annulus between metallic sleeve and periphery of the opening, flush with both surfaces of wall assembly. At the point contact location between sleeve and gypsum board, a min 1/2 in. (13 mm) diam bead of caulk shall be applied at the sleeve/wallboard interface on both surfaces of wall assembly. A min 1/4 in. (6 mm) bead of caulk shall also be applied over the outer edges of the wrap strips and within the annular space between the wrap strip and sleeve on both sides of wall.

3M COMPANY – Type CP 25WB+, IC 15WB+, FireDam 150+ caulk or FB-3000 WT sealant.
(Note: CP 25WB+ and FireDam 150+ not suitable for use with CPVC pipes.)

*Bearing the UL Classification Mark

Reprinted from the Online Certifications Directory with permission from Underwriters Laboratories Inc.
Copyright © 2011 Underwriters Laboratories Inc.®

Through Penetrations

Non-Metallic Pipes

2000 Series

Gypsum

W/L

System No. W-L-2088

May 23, 2005

F Ratings – 1 and 2 Hr (See Item 1)

T Ratings – 0, 1 and 2 Hr (See Item 2)

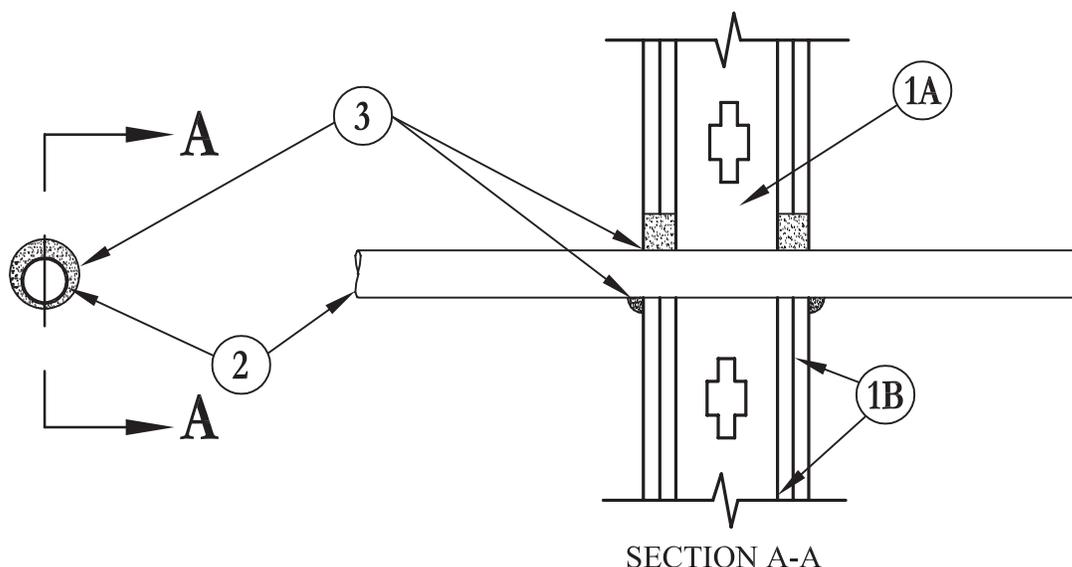

1. **Wall Assembly** – The 1 or 2 hr fire rated gypsum board/stud wall assembly shall be constructed of the materials and in the manner specified in the individual U300, U400 or V400 Series Wall and Partition Designs in the UL Fire Resistance Directory and shall include the following construction features:

- A. **Studs** – Wall framing may consist of either wood studs or steel channel studs. Wood studs to consist of nom 2 in. by 4 in. (51 mm by 102 mm) lumber spaced 16 in. (406 mm) OC. Steel studs to be min 3-1/2 in. (89 mm) wide and spaced max 24 in. (610 mm) OC.
- B. **Gypsum Board*** – Thickness, type, number of layers and fasteners as required in the individual Wall and Partition Design. Diam of opening shall be 7/8 in. (22 mm) larger than the outside diam of nonmetallic pipe or conduit (Item 2).

The hourly F Rating of the firestop system is equal to the hourly fire rating of the wall assembly in which it is installed.

2. **Through Penetrants** – One nonmetallic pipe or conduit to be installed either concentrically or eccentrically within the firestop system. The annular space for max 1-1/4 in. (32 mm) diam pipe or conduit shall be min 0 in. (point contact) to max 7/8 in. (0 mm to max 22 mm). The annular space for pipe or conduit larger than nom 1-1/4 in. (32 mm), diam shall be min 1/2 in. to max 1 in. (13 mm to max 25 mm). Pipe or conduit to be rigidly supported on both sides of wall assembly. The following types and sizes of nonmetallic pipes or conduits may be used:

- A. **Polyvinyl Chloride (PVC) Pipe** – Nom 2 in. (51 mm) diam (or smaller) Schedule 40 solid core or cellular core PVC pipe for use in closed (process or supply) or vented (drain, waste or vent) piping system.
- B. **Polyvinyl Chloride (PVC) Pipe** – Nom 3 in. (76 mm) diam (or smaller) Schedule 40 solid core PVC pipe for use in closed (process or supply) piping system.
- C. **Chlorinated Polyvinyl Chloride (CPVC) Pipe** – Nom 3 in. (76 mm) diam (or smaller) SDR 11 CPVC pipe for use in closed (process or supply) piping systems.
- D. **Rigid Nonmetallic Conduit++** – Nom 3 in. (76 mm) diam (or smaller) Schedule 40 PVC conduit installed in accordance with Article 347 of the National Electrical Code (NFPA No 70).
- E. **Electrical Nonmetallic Tubing (ENT)++** – Nom 1 in. (25 mm) diam (or smaller) ENT formed of PVC, installed in accordance with Article 331 of the National Electrical Code (NFPA No. 70).
See **Rigid Nonmetallic Conduit (DZKT)** and **Electrical Nonmetallic Tubing (FKHU)** categories in the UL Electrical Construction Equipment Directory for names of manufacturers.
- F. **Acrylonitrile Butadiene Styrene (ABS) Pipe** – Nom. 2 in. (51 mm) diam (or smaller) Schedule 40 solid core or cellular core ABS pipe for use in closed (process or supply) or vented (drain, waste or vent) piping systems.

The hourly T Rating is dependent on the hourly rating of the wall assembly, the pipe or conduit size and whether the pipe is intended for use as a closed or vented system, as shown in the following table.

| Nom Pipe Diam In. (mm) | Wall Assembly Rating Hr | Closed (c) or Vented (v) | T Rating Hr |
|-------------------------|-------------------------|--------------------------|-------------|
| 1/2 to 3 (13 to 76) | 1 | c | 1 |
| 1/2 to 1-1/4 (13 to 32) | 1 | v | 1 |
| 1/2 to 1-1/4 (13 to 32) | 2 | c | 2 |
| 1/2 to 1-1/4 (13 to 32) | 2 | v | 1 |
| 2 (51) | 1 | v | 0 |
| 2 (51) | 2 | v | 0 |

System No. W-L-2088 continued

3. **Fill, Void or Cavity Materials* – Caulk, Sealant or Putty** – Min thickness of 5/8 in. and 1-1/4 in. (16 mm and 32 mm) of caulk or putty for 1 and 2 hr rated wall assemblies, respectively, applied within annulus between pipe or conduit and periphery of the opening, flush with both surfaces of wall assembly. At the point contact location between pipe or conduit and gypsum board, a min 1/2 in. (13 mm) diam bead of caulk or putty shall be applied at the pipe or conduit/wallboard interface on both surfaces of wall assembly.

3M COMPANY – CP 25WB+, IC 15WB+ caulk, FB-3000 WT sealant or MP+ Stix putty
(Note: CP 25WB+ not suitable for use with CPVC pipes.)

+++Bearing the UL Listing Mark.

*Bearing the UL Classification Marking

Reprinted from the Online Certifications Directory with permission from Underwriters Laboratories Inc.
Copyright © 2011 Underwriters Laboratories Inc.®

Through Penetrations

Non-Metallic Pipes

2000 Series

Gypsum

W-L

System No. W-L-2090

May 23, 2005

F Rating – 2 Hr

T Rating – 2 Hr

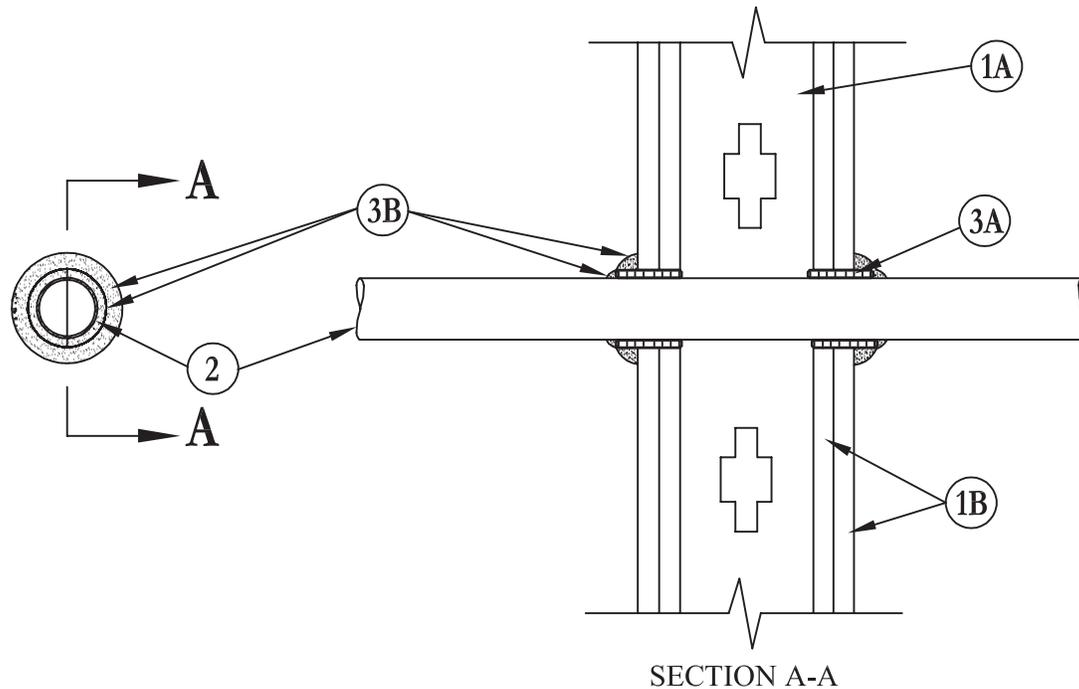

- Wall Assembly** – The fire-rated gypsum board/stud wall assembly shall be constructed of the materials and in the manner specified in the individual U300, U400 or V400 Series Wall and Partition Designs in the UL Fire Resistance Directory and shall include the following construction features:
 - Studs** – Wall framing may consist of either wood studs or steel channel studs. Wood studs to consist of nom 2 in. by 4 in. (51 mm by 102 mm) lumber spaced 16 in. (406 mm) OC. Steel studs to be min 3-5/8 in. (92 mm) wide and spaced max 24 in. (610 mm) OC.
 - Gypsum Board*** – Two layers of nom 5/8 in. (16 mm) thick gypsum board, as specified in the individual Wall and Partition Design. Max diam of opening is 1-5/8 in. (41 mm).
- Nonmetallic Pipe** – Nom 1 in. (25 mm) diam (or smaller) cross-linked polyethylene (PEX) SDR 9 tubing for use in closed (process or supply) piping systems. One pipe to be centered within the firestop system. A nom annular space of 1/4 in. (6 mm) is required within the firestop system. Pipe to be rigidly supported on both sides of wall assembly.
- Firestop System** – The firestop system shall consist of the following:
 - Fill, Void or Cavity Materials* – Wrap Strip** – Nom 1/4 in. (6 mm) thick intumescent elastomeric material faced on one side with aluminum foil, supplied in 2 in. (51 mm) wide strips. Nom 2 in. (51 mm) wide strip tightly wrapped around pipe (foil side out) with seam butted. Wrap strip layer securely bound with steel wire or aluminum foil tape and slid into annular space approx 1-1/4 in. (32 mm) such that approx 3/4 in. (19 mm) of the wrap strip width protrudes from the wall surface on each side of wall assembly.
3M COMPANY – FS-195+
 - Fill, Void or Cavity Material* – Caulk, Sealant or Putty** – A nom 1/4 in. (6 mm) diam continuous bead is to be applied to the wrap strip/wall interface and to the exposed edge of the wrap strip approx 3/4 in. (19 mm) from the wall surface on each side of the wall assembly.
3M COMPANY – IC 15WB+, FireDam 150+ caulk, FB-3000 WT sealant or MP+ Stix putty

*Bearing the UL Classification Marking

Reprinted from the Online Certifications Directory with permission from Underwriters Laboratories Inc.
Copyright © 2011 Underwriters Laboratories Inc.®

Through Penetrations

Non-Metallic Pipes

2000 Series

Gypsum

WL

System No. W-L-2091

May 23, 2005

F Ratings – 1 and 2 Hr (See Item 1)

T Ratings – 1 and 2 Hr (See Item 1)

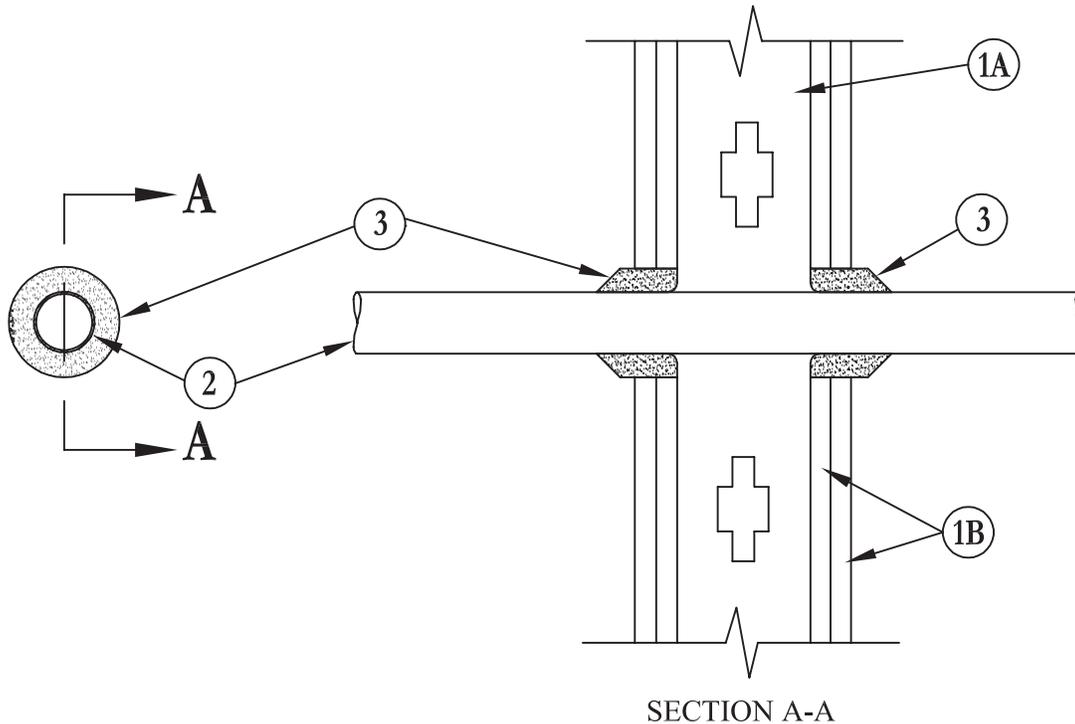

1. **Wall Assembly** – The 1 or 2 h fire-rated gypsum board/stud wall assembly shall be constructed of the materials and in the manner specified in the individual U300, U400 or V400 Series Wall and Partition Designs in the UL Fire Resistance Directory and shall include the following construction features:
 - A. **Studs** – Wall framing may consist of either wood studs or steel channel studs. Wood studs to consist of nom 2 in. by 4 in. (51 mm by 102 mm) lumber spaced 16 in. (406 mm) OC. Steel studs to be min 3-5/8 in. (92 mm) wide and spaced max 24 in. (610 mm) OC.
 - B. **Gypsum Board*** – Nom 5/8 in. (16 mm) thick gypsum board type, number of layers and sheet orientation shall be as specified in the individual Wall and Partition Design. Max diam of opening is 1-5/8 in. (41 mm).
2. **Nonmetallic Pipe** – For 2 hr walls, nom 1 in. (25 mm) diam (or smaller) cross-linked polyethylene (PEX) SDR 9 tubing for use in closed (process or supply) piping systems. For 1 hr walls, nom 3/8 in. (10 mm) diam cross-linked polyethylene (PEX) SDR 9 tubing for use in closed (process or supply) piping systems. One pipe to be centered within the firestop system. A nom annular space of 1/4 in. (6 mm) is required within the firestop system. Pipe to be rigidly supported on both sides of wall assembly.
3. **Fill, Void or Cavity Material* – Caulk, Sealant or Putty** – Fill material installed within annular space between pipe and gypsum board on both sides of wall. For 1 or 2 hr walls with a nom 3/8 in. (10 mm) diam PEX tube, the min depth of caulk or putty within the annular space is 5/8 in. (16 mm). For 2 hr walls with a nom 1 in. (25 mm) diam (or smaller) PEX tube, the min depth of caulk or putty within the annular space is 1-1/4 in. (32 mm). In all cases, a min 1/4 in. (6 mm) diam bead of caulk or putty shall be applied to perimeter of pipe at its egress from each side of wall.

3M COMPANY – CP 25WB+, IC 15WB+, FireDam 150+ caulk, FB-3000 WT sealant or MP+ Stix putty

*Bearing the UL Classification Marking

Reprinted from the Online Certifications Directory with permission from Underwriters Laboratories Inc.

Copyright © 2011 Underwriters Laboratories Inc.®

System No. W-L-2092

May 23, 2005

F Ratings – 1 and 2 Hr (See Item 1)

T Ratings – 1 and 2 Hr (See Item 1)

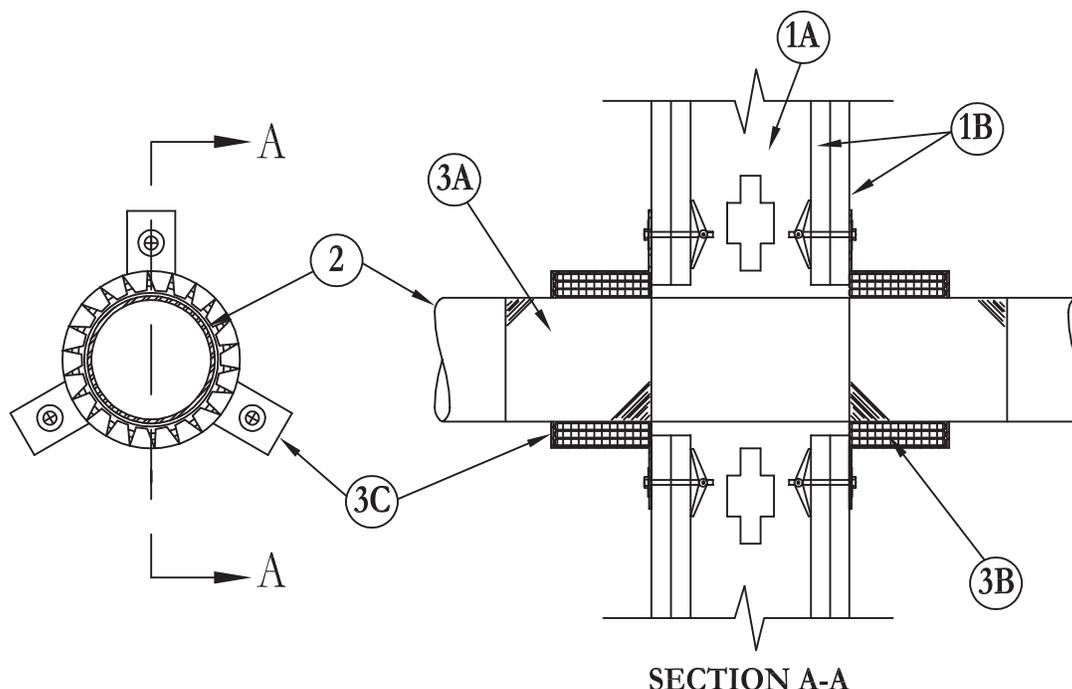

1. **Wall Assembly** – The fire rated gypsum board/stud wall assembly shall be constructed of the materials and in the manner specified in the individual U300, U400 or V400 Series Wall and Partition Designs in the UL Fire Resistance Directory and shall include the following construction features:

- A. **Studs** – Wall framing may consist of either wood studs or steel channel studs. Wood studs to consist of nom 2 in. by 4 in. (51 mm by 102 mm) lumber spaced 16 in. (406 mm) OC. Steel studs to be min 3-5/8 in. (92 mm) wide and spaced max 24 in. (610 mm) OC.
- B. **Gypsum Board*** – Thickness, type, number of layers and fasteners as required in the individual Wall and Partition Design. Diam of opening shall be a max of 1/8 in. (3.2 mm) larger than the outside diam of nom 2 in. (51 mm) diam (and smaller) nonmetallic pipes or conduits (Item 2) and a max of 1/2 in. (13 mm) larger than the outside diam of nom 2-1/2 in. (64 mm) diam (and larger) nonmetallic pipes or conduits.

The hourly F and T Ratings of the firestop system is equal to the hourly fire rating of the wall assembly in which it is installed.

2. **Nonmetallic Pipe or Conduit** – Nom 4 in. (102 mm) diam (or smaller) Schedule 40 solid core polyvinylidene fluoride (PVDF) pipe or conduit for use in closed (process or supply) or vented (drain, waste or vent) piping systems. The pipe or conduit shall be centered in the through opening and rigidly supported on both sides of wall assembly.
3. **Firestop System** – The details of the firestop system shall be as follows:
 - A. **Foil Tape** – Nom 4 in. (102 mm) wide, 3 mil thick aluminum tape wrapped around pipe or conduit prior to the installation of the wrap strip (Item 3B). Min of one wrap, installed flush with the wall surfaces on both sides of the wall assembly.
 - B. **Fill, Void or Cavity Materials* – Wrap Strip** – 2 in. (51 mm) wide, nom 1/4 in. (6 mm) thick intumescent elastomeric material faced on one side with aluminum foil. Wrap strip(s) tightly wrapped around pipe or conduit (foil side exposed) and butted against the wall surfaces on both sides of the wall assembly. Each layer of wrap strip to be installed with butted seam with butted seams in successive layers staggered. Wrap strip(s) temporarily held in position using aluminum foil tape, steel wire tie, or equivalent. The min number of wrap strip layers is dependent on the size of the pipe or conduit as shown below:

| Nom Pipe/Conduit Diam | No. of Wrap Strip Layers |
|--------------------------------------|--------------------------|
| 1/2 in. to 2 in. (13 mm to 51 mm) | 1 |
| 2-1/2 in. to 3 in. (64 mm to 76 mm) | 3 |
| 3-1/2 in. to 4 in. (89 mm to 102 mm) | 4 |

3M COMPANY – FS-195+

- C. **Steel Collar** – Nom 2 in. (51 mm) deep collar with 1-1/4 in. (32 mm) wide by 2 in. (51 mm) long anchor tabs and min 1/2 in. (13 mm) long tabs to retain wrap strip. Coils of precut min 0.016 in (0.41 mm) thick (28 gauge) galv sheet steel available from wrap strip manufacturer. As an alternate, collar may be field-fabricated from min 0.016 in. (0.41 mm) thick (28 gauge) galv sheet steel in accordance with instruction sheet supplied by wrap strip manufacturer. Collar, with anchor tabs bent outward 90 degrees, wrapped tightly around wrap strip with min 1 in. (25 mm) overlap at seam and compressed around wrap strip(s) using a min 1/2 in. (13 mm) wide by min 0.028 in. (0.71 mm) thick stainless steel band at the collar midheight. As an alternate to the band clamps, collars may be secured by a means No 10 by 1/2 in. (13 mm) long sheet metal screws installed in the vertical axis at the center of the 1 in. (25 mm) overlap along

System No. W-L-2092 *continued*

the perimeter joint of the collar. A min of three screws is required. Collar anchor tabs pressed tightly against wall surfaces and secured to wall surfaces with 3/16 in. (5 mm) diam steel toggle bolts, or equivalent, in conjunction with min 1-1/4 in. (32 mm) diam steel fender washers. Min three anchor bolts for nom 1/2 in. to 2 in. (13 mm to 51 mm) pipes or conduits, min 4 anchor bolts for nom 2-1/2 and 3 in. (64 mm and 76 mm) pipes or conduits and min 6 anchor bolts for nom 3-1/2 in. and 4 in. (89 mm and 102 mm) pipes or conduits, symmetrically located. Retainer tabs bent 90 degree toward pipe to lock wrap strip(s) in position.

- D. **Fill, Void or Cavity Materials*** – **Caulk, Sealant or Putty** (Optional, Not Shown) – Generous crown of caulk or putty applied to outer perimeter of collar at interface with wall surfaces and to perimeter of pipe or conduit at its egress from wrap strip layers.

3M COMPANY – CP 25WB+, IC 15WB+, FireDam 150+ caulk, FB-3000 WT sealant or MP+ Stix putty

*Bearing the UL Classification Marking

Reprinted from the Online Certifications Directory with permission from Underwriters Laboratories Inc.
Copyright © 2011 Underwriters Laboratories Inc.®

Through Penetrations

Non-Metallic Pipes

2000 Series

Gypsum

W-L

System No. W-L-2097

May 23, 2005

F Ratings – 1 and 2 Hr (See Item 1)

T Ratings – 0, 3/4, 1 and 2 Hr (See Item 3)

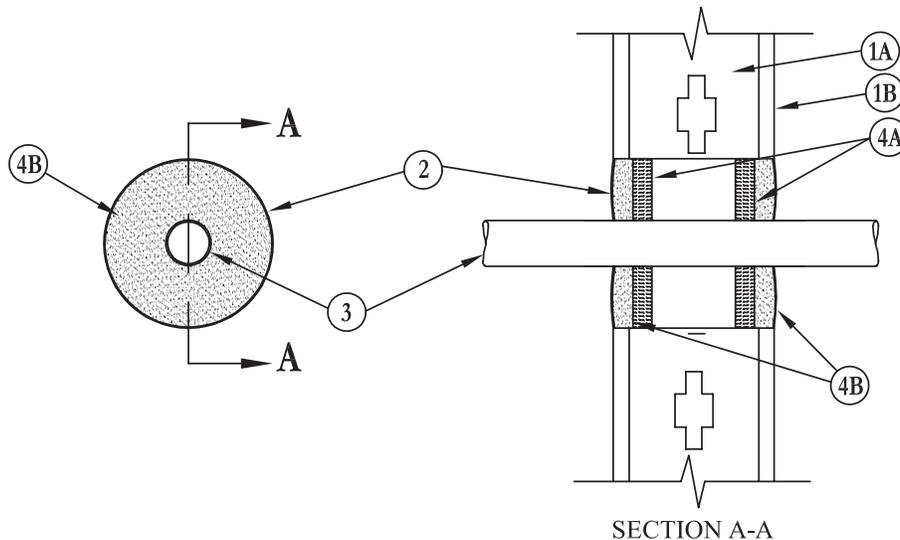

1. **Wall Assembly** – The 1 or 2 hr fire rated gypsum board/stud wall assembly shall be constructed of the materials and in the manner specified in the individual U300, U400 or V400 Series Wall and Partition Designs in the UL Fire Resistance Directory and shall include the following construction features:

- A. **Studs** – Wall framing may consist of either wood studs or steel channel studs. Wood studs to consist of nom 2 in. by 4 in. (51 mm by 102 mm) lumber spaced 16 in. (406 mm) OC. Steel studs to be min 3-1/2 in. (89 mm) wide and spaced max 24 in. (610 mm) OC.
- B. **Gypsum Board*** – Thickness, type, number of layers and fasteners as required in the individual Wall and Partition Design. Max diam of opening is 7-1/2 in. (191 mm).

The hourly F Rating of the firestop system is equal to the hourly fire rating of the wall assembly in which it is installed.

2. **Metallic Sleeve** – Cylindrical sleeve fabricated from min 0.016 in. (0.41 mm) thick (28 gauge) galv sheet steel and having a min 2 in. (51 mm) lap along the longitudinal seam. Length of steel sleeve to be equal to thickness of wall plus 1 in. (25 mm) such that, when installed, the ends of the sleeve will project approx 1/2 in. (13 mm) beyond each side of the wall. The diam of the openings cut in the gypsum board layers on each side of the wall assembly to be 1-1/4 in. to 4 in. (32 mm to 102 mm) larger than outside diam of pipe such that, when the sleeve is installed, a min 5/8 in. to max 2 in. (16 mm to 51 mm) annular space will be present between the steel sleeve and the pipe around the entire circumference of the pipe.
3. **Through Penetrants** – One nonmetallic pipe or conduit to be centered within the firestop system. Pipe or conduit to be rigidly supported on both sides of wall assembly. The following types and sizes of nonmetallic pipes or conduits may be used:
 - A. **Polyvinyl Chloride (PVC) Pipe** – Nom 2 in. (51 mm) diam (or smaller) Schedule 40 solid core PVC pipe for use in closed (process or supply) or vented (drain, waste or vent) piping system.
 - B. **Chlorinated Polyvinyl Chloride (CPVC) Pipe** – Nom 2 in. (51 mm) diam (or smaller) SDR 13.5 CPVC pipe for use in closed (process or supply) piping systems.
 - C. **Polyvinyl Chloride (PVC) Pipe** – Nom 3 in. (76 mm) diam (or smaller) Schedule 40 solid core PVC pipe for use in closed (process or supply) piping system.
 - D. **Chlorinated Polyvinyl Chloride (CPVC) Pipe** – Nom 3 in. (76 mm) diam (or smaller) SDR 13.5 CPVC pipe for use in closed (process or supply) piping systems.
 - E. **Rigid Nonmetallic Conduit+** – Nom 3 in. (76 mm) diam (or smaller) Schedule 40 solid core PVC conduit installed in accordance with Article 347 of the National Electrical Code (NFPA No. 70).

The hourly T Rating is 0 and 3/4 Hr for vented systems in 2 and 1 Hr rated wall assemblies, respectively. The hourly T Rating is equal to the hourly fire rating of the wall assembly for closed systems.

4. **Firestop System** – The firestop system shall consist of the following:
 - A. **Packing Material** – Min 1 in. (25 mm) thickness of min 4 pcf (64 kg/m³) mineral wool batt insulation firmly packed into opening as a permanent form. Packing material to be recessed from both surfaces of wall as required to accommodate the required thickness of fill material.
 - B. **Fill, Void or Cavity Materials* – Caulk, Sealant or Putty** – Min thickness of 5/8 in. (16 mm) of caulk or putty applied within annulus between pipe or conduit and periphery of the opening, recessed from end of sleeve, flush with both surfaces of wall assembly. A nom 1/2 in. (13 mm) diam bead of caulk or putty shall be applied to the sleeve/wallboard interface around the entire perimeter of the sleeve on both sides of the wall assembly.
3M COMPANY – CP 25WB+, IC 15WB+ caulk, FB-3000 WT sealant or MP+ Stix putty
(Note: CP 25WB+ not suitable for use with CPVC pipes.)

*Bearing the UL Classification Marking

Reprinted from the Online Certifications Directory with permission from Underwriters Laboratories Inc.

Copyright © 2011 Underwriters Laboratories Inc.®

Through Penetrations

Non-Metallic Pipes

2000 Series

Gypsum

WL

System No. W-L-2099

May 23, 2005

F Ratings – 1 & 2 Hr (See Item 1)

T Ratings – 1 & 2 Hr (See Item 1)

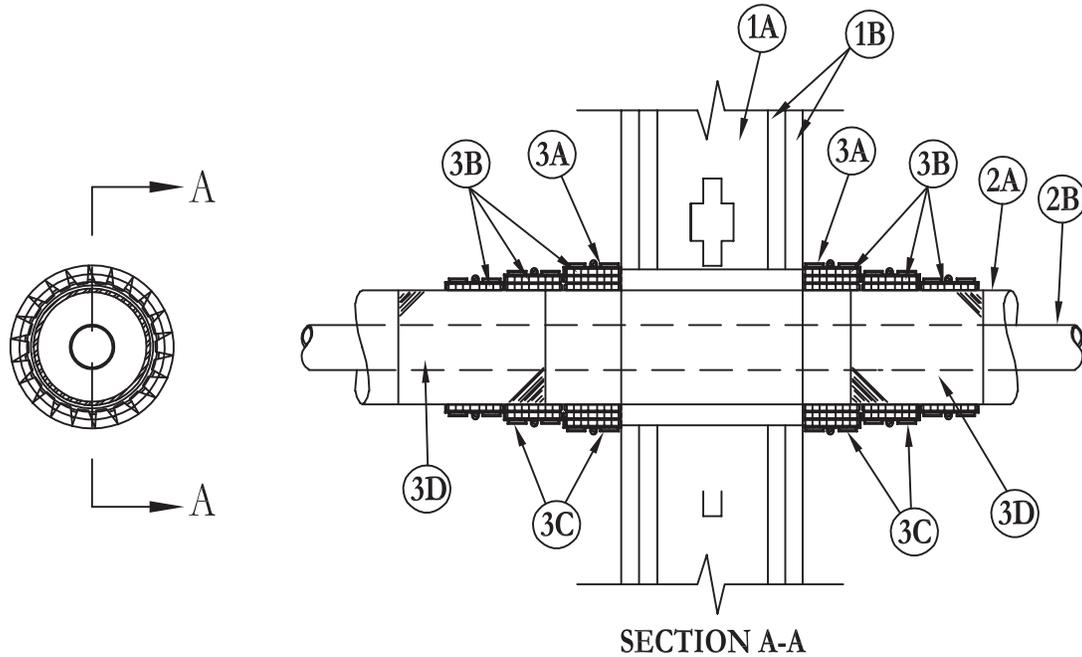

- Wall Assembly** – The 1 and 2 hr fire rated gypsum board/stud wall assembly shall be constructed of the materials and in the manner specified in the individual U300, U400 or V400 Series Wall and Partition Designs in the UL Fire Resistance Directory and shall include the following construction features:
 - Studs** – Wall framing may consist of either wood studs or steel channel studs. Wood studs to consist of nom 2 in. (51 mm) lumber spaced 16 in. (406 mm). Steel studs to be min 3-1/2 in. (89 mm) wide and spaced max 24 in. (610 mm) OC.
 - Gypsum Board*** – Thickness, type, number of layers and fasteners as required in the individual Wall and Partition Design. Diameter of opening shall be 2 in. (51 mm) larger than the outside diam of nonmetallic pipe or conduit (Item 2).

The hourly F and T Ratings of the firestop system is equal to the hourly fire rating of the wall assembly in which it is installed.
- Through Penetrants** – One nonmetallic pipe installed within one nonmetallic pipe and centered within the firestop system. The space between outer pipe and metallic sleeve shall be 1 in. (25 mm). The inner pipe shall be centered within the outer pipe. Nonmetallic spacers shall be used to maintain the inner pipe within the center of the outer pipe at a distance no closer than 10 in. (254 mm) from both wall surfaces. The nom diam of the inner pipe shall be one half the nom diam of the outer pipe. The outer pipe to be rigidly supported on both sides of the wall assembly. The following types and sizes of nonmetallic pipes described in Item A may be used for the outer pipe and the following types and sizes of nonmetallic pipes described in Item B may be used for the inner pipe:
 - Polypropylene (PP) Pipe** – Nom 4 in. or 6 in. (102 mm or 152 mm) diam SDR 32.5 PP pipe for use in closed (process or supply) or vented (drain, waste or vent) piping system.
 - Polypropylene (PP) Pipe** – Nom 2 in. or 3 in. (51 mm or 76 mm) diam SDR 11 PP pipe for use in closed (process or supply) or vented (drain, waste or vent) piping system.
- Firestop System** – The details of the firestop system shall be as follows:
 - Metallic Sleeve** – Nom 28 gauge galvanized steel sleeve friction-fit in wall assembly, extending 2-1/4 (57 mm) beyond both wall surfaces. Each end of the sleeve to be provided with 3/4 in. (19 mm) long slits such that the ends of the sleeve are bent 90 degrees toward the pipe to lock the wrap strip layers (Item 3B) in position. A 1/2 in. (13 mm) wide stainless steel hose clamp to be secured around each end of the sleeve, approximately midway between the wall surface and the end of the sleeve.
 - Fill, Void or Cavity Materials*** – **Wrap Strip** – Nom 1/4 in. (6 mm) thick intumescent elastomeric material faced on one side with aluminum foil, supplied in 2 in. (51 mm) wide strips. Strips tightly wrapped around outer nonmetallic pipe (foil side exposed). Multiple stacks of multiple layers to be butted tightly together with the first layer recessed into sleeve, 3/4 in. (19 mm) from both ends of the sleeve. The min number of layers and stacks of layers required is dependent upon the nom diam of the outer pipe, as shown in the following table:

| Outer Pipe Nom Diam In. (mm) | No. of Wrap Stack | No. of Wrap Strip Layers For 1st Stack | No. of Wrap Strip Layers For 2nd Stack | No. of Wrap Strip Layers For 3rd Stack |
|------------------------------|-------------------|--|--|--|
| 4 (102) | 2 | 4 | 2 | NA |
| 6 (152) | 3 | 4 | 3 | 2 |

3M COMPANY – FS-195+

System No. W-L-2099 *continued*

- C. **Steel Collars** – Nom 2 in. (51 mm) deep collars with 1-1/4 in. (32 mm) wide by 2 in. (51 mm) long anchor tabs and min 1/2 in. (13 mm) long tabs to retain wrap strip layers. Coils of precut min 0.016 in. (0.41 mm) thick (28 gauge) galv sheet steel available from wrap strip manufacturer. As an alternate, collar may be field-fabricated from min 0.016 in. (0.41 mm) thick (28 gauge) galv sheet steel in accordance with instruction sheet supplied by wrap strip manufacturer. Steel collars, with anchor tabs bent outward 90 degrees, wrapped tightly around second and third stack (if third stack is required) of wrap strip layers and pressed tightly against preceding collar or sleeve with min 1 in. overlap at seam. Anchor tabs for collar to be pressed tightly against preceding collar or sleeve and compressed around wrap strip layers using a min 1/2 in. (13 mm) wide by 0.028 in. (0.71 mm) thick stainless steel band clamp at the collar midheight. Anchor tabs to be bent 90 degrees outward and then 90 degrees toward wall, tightly against the preceding collar or sleeve, and secured to the preceding collar or sleeve using 1/2 in. (13 mm) long No. 10 sheet metal screws. Anchor screws to be used with every anchor tab. Retainer tabs 90 degrees toward pipe to lock wrap strip layers in position.
- D. **Foil Tape** – Nom 4 in. (102 mm) wide, 3 mil thick aluminum tape wrapped around pipe prior to the installation of the last stack of wrap strip (Item 3B). Min of one wrap, flush with the next to last stack of wrap strip and proceeding outward.
- E. **Fill, Void or Cavity Materials*** – **Caulk, Sealant or Putty** (Not Shown/Optional) – Generous bead of caulk or putty may be applied to outer perimeter of sleeve at its interface with wall surfaces.
3M COMPANY – CP 25WB+, IC 15WB+, FireDam 150+ caulk, FB-3000 WT sealant or MP+ Stix putty

*Bearing the UL Classification Marking

Reprinted from the Online Certifications Directory with permission from Underwriters Laboratories Inc.
Copyright © 2011 Underwriters Laboratories Inc.®

System No. W-L-2112

May 23, 2005

F Ratings – 1 and 2 Hr (See Item 1)

T Rating – 1/4 Hr

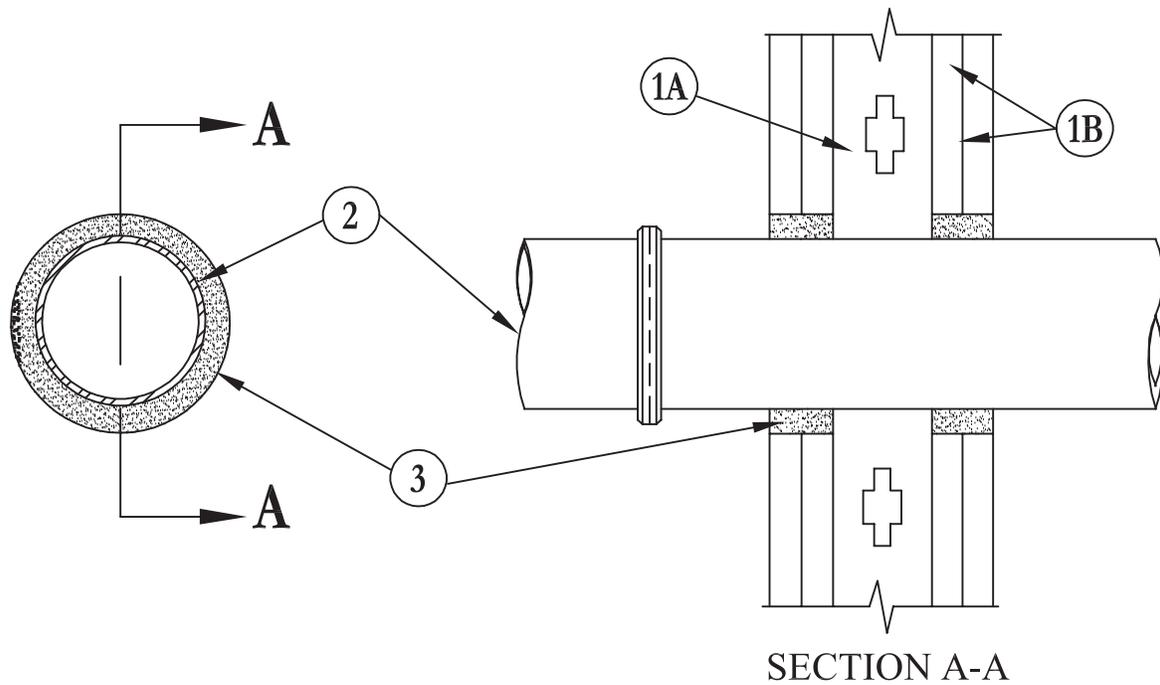

- Wall Assembly** – The fire rated gypsum board/stud wall assembly shall be constructed of the material and in the manner specified in the individual U300, U400 or V400 Series Wall and Partition Designs in the UL Fire Resistance Directory and shall include the following construction features:
 - Studs** – Wall framing may consist of either wood studs or steel channel studs. Wood studs to consist of nom 2 in. by 4 in. (51 mm by 102 mm) lumber spaced 16 in. (406 mm) OC. Steel studs to be min 3-1/2 in. (89 mm) wide and spaced max 24 in. (610 mm) OC.
 - Gypsum Board*** – Thickness, type, number of layers and fasteners as required in the individual Wall and Partition Design. Max diam of opening is 5 in. (127 mm).

The hourly F Rating of the firestop system is equal to the hourly fire rating of the wall assembly in which it is installed.

- Through Penetrating Products* – Glass Pipe** – Nom 3 in. (76 mm) diam (or smaller) glass pipe installed concentrically or eccentrically in opening, for use in closed (process or supply) or vented (drain, waste or vent) piping systems. The annular space between pipe and periphery of opening shall be min 5/8 in. to max 1 in. (16 mm to max 25 mm). Pipe to be rigidly supported on both sides of wall assembly. Pipe connections to be located a min 3 in. (76 mm) from wall surfaces.

SCHOTT SCIENTIFIC GLASS

- Fill, Void or Cavity Materials* – Caulk or Sealant** – Min thickness of 5/8 in. and 1-1/4 in. (16 mm and 32 mm) for 1 and 2 hr rated wall assemblies, respectively, applied within annulus between pipe or conduit and periphery of the opening, flush with both surfaces of wall assembly.

3M COMPANY – IC 15WB+, CP 25WB+ caulk or FB-3000 WT sealant

*Bearing the UL Classification Marking

Reprinted from the Online Certifications Directory with permission from Underwriters Laboratories Inc.

Copyright © 2011 Underwriters Laboratories Inc.®

System No. W-L-2146

May 23, 2005

F Ratings – 1 and 2 Hr (See Item 1)

T Ratings – 1 and 2 Hr (See Item 1)

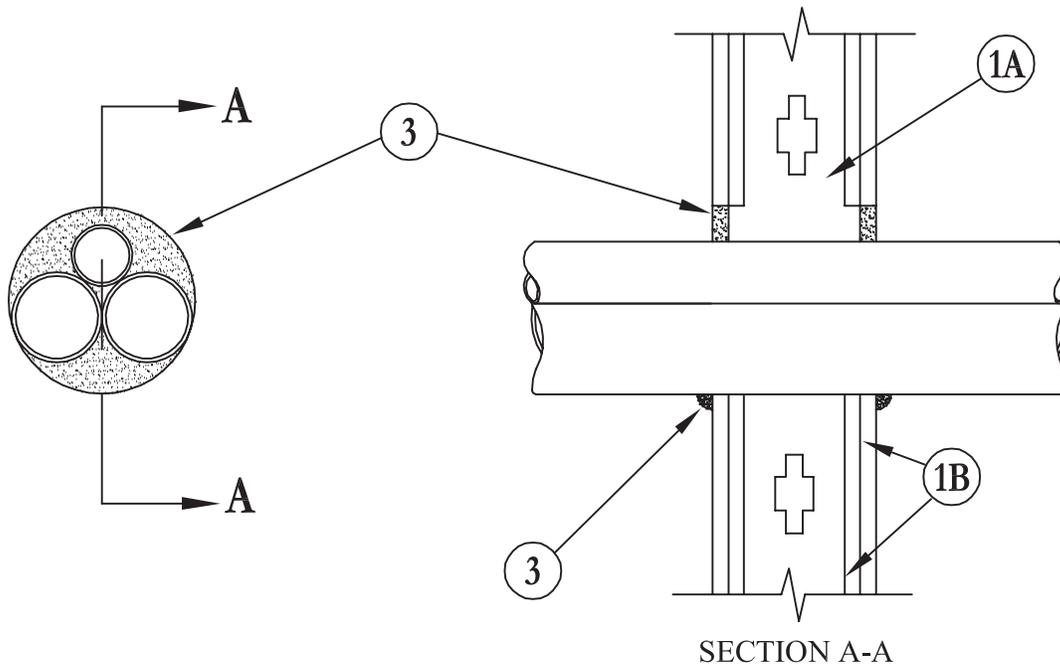

1. **Wall Assembly** – The 1 or 2 hr fire rated gypsum board/stud wall assembly shall be constructed of the materials and in the manner specified in the individual U300, U400 or V400 Series Wall and Partition Designs in the UL Fire Resistance Directory and shall include the following construction features:

A. **Studs** – Wall framing may consist of either wood studs or steel channel studs. Wood studs to consist of nom 2 in. by 4 in. (51 mm by 102 mm) lumber spaced 16 in. (406 mm) OC. Steel studs to be min 3-1/2 in. (89 mm) wide and spaced max 24 in. (610 mm) OC.

B. **Gypsum Board*** – Thickness, type, number of layers and fasteners as required in the individual Wall and Partition Design. Max diam of opening is 3 in. (76 mm).

The hourly F and T Ratings of the firestop system is equal to the hourly fire rating of the wall assembly in which it is installed.

2. **Crosslinked Polyethylene (PEX) Tubing** – Nom 1 in. (25 mm) diam (or smaller) SDR 9 PEX tubing for use in closed (process or supply) piping systems. Max three tubes per opening, tightly bundled. The annular space between tubing and periphery of opening shall be min 0 in. (0 mm) (point contact) to max 1 in. (25 mm). Tubing to be rigidly supported on both sides of wall assembly.
3. **Fill, Void or Cavity Materials* – Caulk or Sealant** – Min 5/8 in. (16 mm) thickness of fill material applied within annulus, flush with each surface of wall. Min 5/8 in. (16 mm) thickness of fill material applied into interstices of tubes on both sides of wall. Min 1/2 in. (13 mm) diam bead of caulk applied to the tubing/wallboard interface at the point contact location on both sides of wall.

3M COMPANY – IC 15WB+, CP 25WB+ caulk or FB-3000 WT sealant

*Bearing the UL Classification Marking

Reprinted from the Online Certifications Directory with permission from Underwriters Laboratories Inc.
Copyright © 2011 Underwriters Laboratories Inc.®

System No. W-L-2147

November 20, 2009

F Rating – 1 And 2 Hr (See Item 1)

T Rating – 1 And 2 Hr (See Item 1)

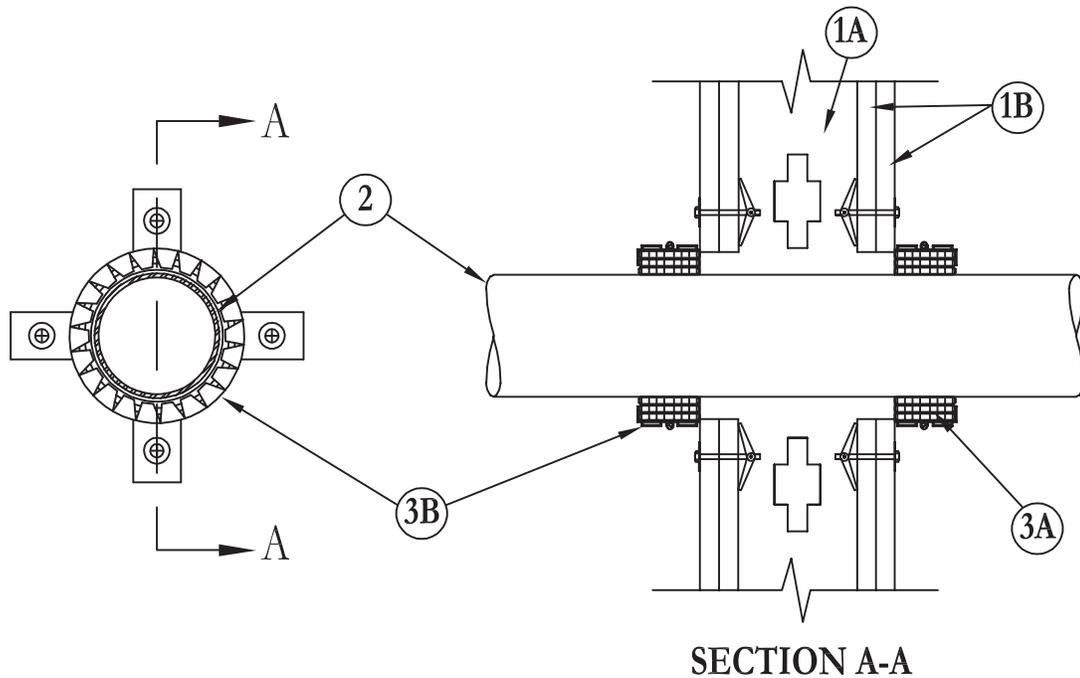

1. **Wall Assembly** – The 1 or 2 hr fire rated gypsum board/stud wall assembly shall be constructed of the materials and in the manner specified in the individual U300, U400 or V400 Series Wall and Partition Designs in the UL Fire Resistance Directory and shall include the following construction features:
 - A. **Studs** – Wall framing may consist of either wood studs or steel channel studs. Wood studs to consist of nom 2 by 4 in. (51 by 102 mm) lumber spaced 16 in. (406 mm) OC. Steel studs to be min 3-1/2 in. (89 mm) wide and spaced max 24 in. (610 mm) OC.
 - B. **Gypsum Board*** – Thickness, type, number of layers and fasteners as required in the individual Wall and Partition Design. Max diam of opening is 5 in. (127 mm).

The hourly F and T Ratings of the firestop system are equal to the hourly fire rating of the wall assembly in which it is installed.
2. **Through Penetrants** – One nonmetallic pipe or conduit to be centered within opening with a nom 1/4 in. (32 mm) annular space between pipe or conduit and periphery of opening. Pipe or conduit to be rigidly supported on both sides of the wall assembly. The following types and sizes of nonmetallic pipes or conduits may be used:
 - A. **Polyvinyl Chloride (PVC) Pipe** – Nom 4 in. (102 mm) diam (or smaller) Schedule 40 solid core or cellular core PVC pipe for use in closed (process or supply) or vented (drain, waste or vent) piping system.
 - B. **Rigid Nonmetallic Conduit++** – Nom 4 in. (102 mm) diam (or smaller) Schedule 40 PVC conduit installed in accordance with the National Electrical Code (NFPA No. 70).
 - C. **Chlorinated Polyvinyl Chloride (CPVC) Pipe** – Nom 4 in. (102 mm) diam (or smaller) SDR13 CPVC pipe for use in closed (process or supply) piping systems.
 - D. **Acrylonitrile Butadiene Styrene (ABS) Pipe** – Nom 4 in. (102 mm) diam (or smaller) Schedule 40 solid core or cellular core ABS pipe for use in closed (process or supply) or vented (drain, waste or vent) piping systems.
 - E. **Fire Retardant Polypropylene (FRPP) Pipe** – Nom 4 in. (102 mm) diam (or smaller) Schedule 40 FRPP pipe for use in closed (process or supply) or vented (drain, waste or vent) piping system.
3. **Firestop System** – The details of the firestop system shall be as follows:
 - A. **Fill, Void or Cavity Materials* – Wrap Strip** – Nom 1/8 in. (3.2 mm) thick intumescent material supplied in 2 in. (51 mm) wide strips. Wrap strip tightly wrapped around nonmetallic pipe with continuous layers and butted tightly against both surfaces of the wall. The min number of layers required is dependent upon the nom diam of the pipe. For nom 2 in. (51 mm) diam (and smaller) pipes, one layer is required. For nom 2-1/2 in. and 3 in. (64 and 76 mm) diam pipes, two layers are required. For nom 3-1/2 in. and 4 in. (89 and 102 mm) diam pipes, three layers are required. Wrap strip layers temporarily held in position using aluminum foil tape, steel wire tie, or equivalent.
3M COMPANY – Ultra GS
 - B. **Steel Collar** – Nom 2 in. (51 mm) deep collar with 1-1/4 in. (32 mm) wide by 2 in. (51 mm) long anchor tabs and min 1/2 in. (13 mm) long tabs to retain wrap strip layers. Coils of precut 0.016 in. (.41 mm) thick (28 gauge) galv sheet steel available from wrap strip manufacturer. As an alternate, collar may be field-fabricated from min 0.016 in. (.41 mm) thick (28 gauge) galv sheet steel in accordance with instruction sheet supplied by wrap strip manufacturer. Steel collar, with anchor tabs bent outward 90 deg, wrapped tightly around wrap strip layers with min 1 in. (25 mm) overlap at seam. Anchor tabs to be pressed tightly against wall surfaces, and collar to be compressed around wrap strip layers using a min 1/2 in. (13 mm) wide by 0.028 in. (.71 mm) thick stainless steel band clamp at the

System No. W-L-2147 *continued*

middle of collar. As an alternate to the band clamp, collar for systems with three or more layers of wrap strip may be fastened together along the overlapping seam with three No. 6 by 3/8 in. (152 by 10 mm) long self-tapping steel screws. Collar to be secured to wall surfaces with 3/16 in. (5 mm) diam steel toggle bolts, or equivalent, in conjunction with min 1-1/4 in. (32 mm) diam steel fender washers. Min of two, three or four anchor bolts, symmetrically located, for nom 2 in. (51 mm) diam (and smaller), nom 3 in. (76 mm) diam (and smaller) and nom 4 in. (102 mm) diam (and smaller), pipes, respectively.

- C. **Fill, Void or Cavity Materials* – Caulk, Sealant or Putty** – (Not Shown) – Min 1/2 in. (13 mm) diam bead of caulk or putty shall be applied to outer perimeter of collar at its interface with wall surface(s).

3M COMPANY – CP 25WB+ caulk, MP+ putty, IC 15WB caulk, FireDam 50+ caulk or FB-3000 WT sealant.

(Note: CP 25WB+ and FireDam 150+ not suitable for use with CPVC pipes.)

- D. **Firestop Device*** – As an alternate to Items 3A and 3B, firestop device to be installed in accordance with the accompanying installation instructions. Firestop device to be installed and latched around pipe and secured to both sides of wall with Ultra Fast Anchors Straps or with 1/4 in. (6 mm) diam by min 1-1/2 in. (38 mm) long steel toggle bolts in conjunction with min 1-1/4 in. (32 mm) diam steel fender washers. Min of two, three or four anchor straps or anchor bolts symmetrically located, for nom 2 in., 3 in. and 4 in. (51 mm, 76 mm, and 102 mm) diam pipe respectively.

3M COMPANY – Ultra RC Pack 2.0, 3.0, 4.0

++Bearing the UL Listing Mark

*Bearing the UL Classification Mark

Reprinted from the Online Certifications Directory with permission from Underwriters Laboratories Inc.

Copyright © 2011 Underwriters Laboratories Inc.®

Through Penetrations

Non-Metallic Pipes

2000 Series

Gypsum

WL

System No. W-L-2148

November 20, 2009

F Rating – 1 Hr

T Rating – 1 Hr

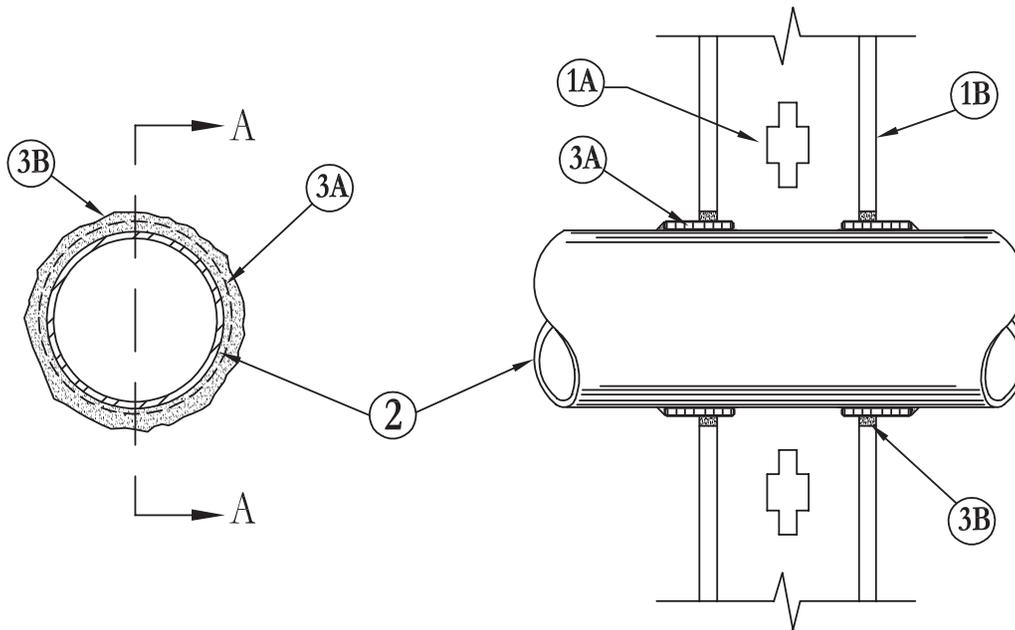

- Wall Assembly** – The 1 hr fire rated gypsum board/stud wall assembly shall be constructed of the materials and in the manner specified in the individual U300, U400 or V400 Series Wall and Partition Designs in the UL Fire Resistance Directory and shall include the following construction features:
 - Studs** – Wall framing may consist of either wood studs or steel channel studs. Wood studs to consist of nom 2 by 4 in. (51 by 102 mm) lumber spaced 16 in. (406 mm) OC. Steel studs to be min 3-1/2 in. (89 mm) wide and spaced max 24 in. (610 mm) OC.
 - Gypsum Board*** – Thickness, type, number of layers and fasteners as required in the individual Wall and Partition Design. Max diam of opening is 2-3/4 in. (70 mm).
- Through Penetrants** – One nonmetallic pipe or conduit to be centered within opening with a nom 3/16 in. (5 mm) annular space between pipe or conduit and periphery of opening. Pipe or conduit to be rigidly supported on both sides of the wall assembly. The following types and sizes of nonmetallic pipes or conduits may be used:
 - Polyvinyl Chloride (PVC) Pipe** – Nom 2 in. (51 mm) diam (or smaller) Schedule 40 solid core or cellular core PVC pipe for use in closed (process or supply) or vented (drain, waste or vent) piping system.
 - Rigid Nonmetallic Conduit++** – Nom 2 in. (51 mm) diam (or smaller) Schedule 40 PVC conduit installed in accordance with the National Electrical Code (NFPA No. 70).
 - Chlorinated Polyvinyl Chloride (CPVC) Pipe** – Nom 2 in. (51 mm) diam (or smaller) SDR13 CPVC pipe for use in closed (process or supply) piping systems.
 - Acrylonitrile Butadiene Styrene (ABS) Pipe** – Nom 2 in. (51 mm) diam (or smaller) Schedule 40 solid core or cellular core ABS pipe for use in closed (process or supply) or vented (drain, waste or vent) piping systems.
 - Fire Retardant Polypropylene (FRPP) Pipe** – Nom 2 in. (51 mm) diam (or smaller) Schedule 40 FRPP pipe for use in closed (process or supply) or vented (drain, waste or vent) piping system.
- Firestop System** – The details of the firestop system shall be as follows:
 - Fill, Void or Cavity Materials* – Wrap Strip** – Nom 1/8 in. (3 mm) thick intumescent material supplied in 2 in. (51 mm) wide strips. One layer of wrap strip tightly wrapped around nonmetallic pipe with end tightly butted and held in place with 2 in. (51 mm) wide min 3 mil foil tape. Wrap strip to be slid into annular space on both sides of wall such that 1/2 to 3/4 in. (13 to 19 mm) of wrap strip extends beyond both surfaces of the wall. Min 18 gauge steel wire tie to be secured around middle of extending portion of wrap strip.
3M COMPANY – Ultra GS
 - Fill, Void or Cavity Materials* – Caulk or Sealant** – Min 5/8 in. (16 mm) thickness of caulk shall be applied within annular space on both sides of wall. An additional min 1/8 in. (3 mm) bead of caulk shall be applied at the exposed end of wrap strip at the pipe/wrap strip interface on both sides of wall.
3M COMPANY – CP 25WB+, IC 15WB+, FireDam 150+ caulk or FB-3000 WT sealant.
(Note: CP 25WB+ and FireDam 150+ not suitable for use with CPVC pipes.)

*Bearing the UL Classification Marking

++Bearing the UL Listing Mark

Reprinted from the Online Certifications Directory with permission from Underwriters Laboratories Inc.
Copyright © 2011 Underwriters Laboratories Inc.®

System No. W-L-2149

November 20, 2009

F Rating – 2 Hr

T Rating – 2 Hr

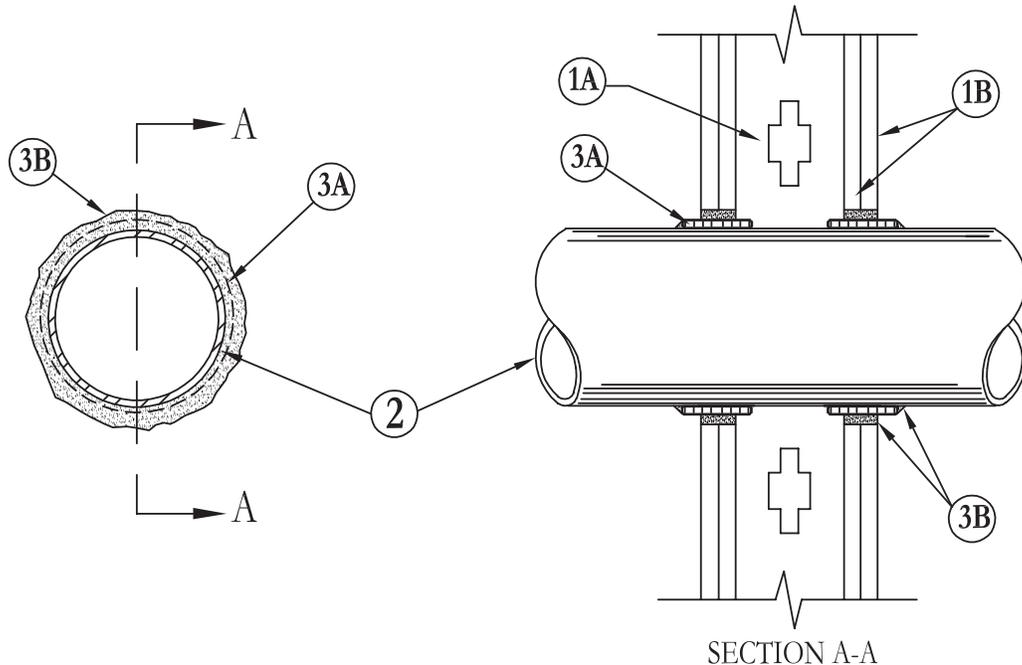

- Wall Assembly** – The 2 hr fire rated gypsum board/stud wall assembly shall be constructed of the materials and in the manner specified in the individual U300, U400 or V400 Series Wall and Partition Designs in the UL Fire Resistance Directory and shall include the following construction features:
 - Studs** – Wall framing may consist of either wood studs or steel channel studs. Wood studs to consist of nom 2 by 4 in. (51 by 102 mm) lumber spaced 16 in. (406 mm) OC. Steel studs to be min 3-1/2 in. (89 mm) wide and spaced max 24 in. (610 mm) OC.
 - Gypsum Board*** – Thickness, type, number of layers and fasteners as required in the individual Wall and Partition Design. Max diam of opening is 3 in. (76 mm).
- Through Penetrants** – One nonmetallic pipe or conduit to be centered within opening with a nom 3/8 in. (10 mm) annular space between pipe or conduit and periphery of opening. Pipe or conduit to be rigidly supported on both sides of the wall assembly. The following types and sizes of nonmetallic pipes or conduits may be used:
 - Polyvinyl Chloride (PVC) Pipe** – Nom 2 in. (51 mm) diam (or smaller) Schedule 40 solid core or cellular core PVC pipe for use in closed (process or supply) or vented (drain, waste or vent) piping system.
 - Rigid Nonmetallic Conduit⁺⁺** – Nom 2 in. (51 mm) diam (or smaller) Schedule 40 PVC conduit installed in accordance with the National Electrical Code (NFPA No. 70).
 - Chlorinated Polyvinyl Chloride (CPVC) Pipe** – Nom 2 in. (51 mm) diam (or smaller) SDR13.5 CPVC pipe for use in closed (process or supply) piping systems.
 - Acrylonitrile Butadiene Styrene (ABS) Pipe** – Nom 2 in. (51 mm) diam (or smaller) Schedule 40 solid core or cellular core ABS pipe for use in closed (process or supply) or vented (drain, waste or vent) piping systems.
 - Fire Retardant Polypropylene (FRPP) Pipe** – Nom 2 in. (51 mm) diam (or smaller) Schedule 40 FRPP pipe for use in closed (process or supply) or vented (drain, waste or vent) piping system.
- Firestop System** – The details of the firestop system shall be as follows:
 - Fill, Void or Cavity Materials* – Wrap Strip** – Nom 1/8 in. (3.2 mm) thick intumescent material supplied in 2 in. (51 mm) wide strips. Two continuous layers of wrap strip tightly wrapped around nonmetallic pipe and held in place with 2 in. (51 mm) wide min 3 mil foil tape. Wrap strip to be slid into annular space on both sides of wall such that 3/8 (10 mm) to 1/2 in. (13 mm) of wrap strip extends beyond both surfaces of the wall. Min 18 gauge steel wire tie to be secured around middle of extending portion of wrap strip.
3M COMPANY – Ultra GS
 - Fill, Void or Cavity Materials* – Caulk or Sealant** – Min 5/8 in. (16 mm) thickness of caulk shall be applied within annular space on both sides of wall. An additional min 1/4 in. (6 mm) bead of caulk shall be applied at the exposed end of wrap strip at the pipe/wrap strip interface on both sides of wall.
3M COMPANY – CP 25WB+ caulk, IC 15WB+ caulk, FireDam 150+ caulk or FB-3000 WT sealant.
(Note: CP 25WB+ and FireDam 150+ not suitable for use with CPVC pipes.)

*Bearing the UL Classification Marking

++Bearing the UL Listing Mark

Reprinted from the Online Certifications Directory with permission from Underwriters Laboratories Inc.

Copyright © 2011 Underwriters Laboratories Inc.®

System No. W-L-2150

November 20, 2009

F Rating – 2 Hr

T Rating – 1-1/2 hr

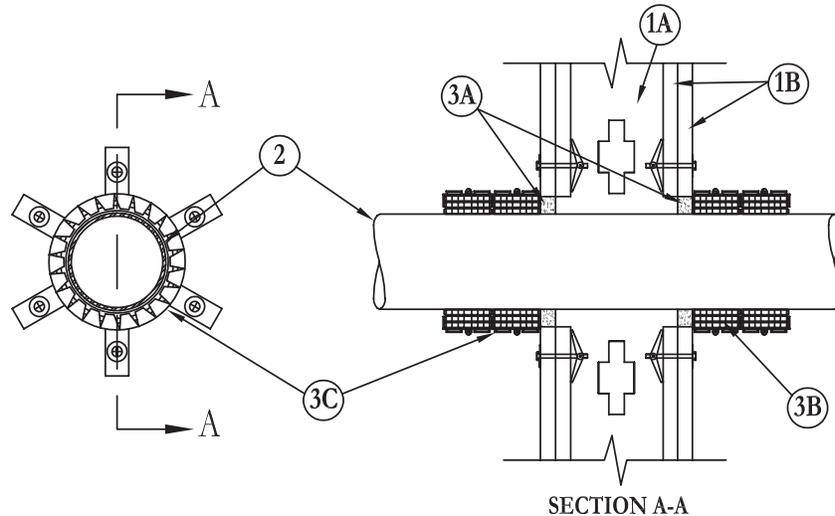

1. **Wall Assembly** – The 2 hr fire rated gypsum board/stud wall assembly shall be constructed of the materials and in the manner specified in the individual U300, U400 or V400 Series Wall and Partition Designs in the UL Fire Resistance Directory and shall include the following construction features:
 - A. **Studs** – Wall framing may consist of either wood studs or steel channel studs. Wood studs to consist of nom 2 by 4 in. (51 by 102 mm) lumber spaced 16 in. (406 mm) OC. Steel studs to be min 3-1/2 in. (89 mm) wide and spaced max 24 in. (610 mm) OC.
 - B. **Gypsum Board*** – Thickness, type, number of layers and fasteners as required in the individual Wall and Partition Design. Max diameter of opening is 6-3/4 in. (171.5 mm).
2. **Through Penetrants** – One nonmetallic pipe or conduit to be centered within opening with a nom 1/8 in. (3.2 mm) annular space between pipe or conduit and periphery of opening. Pipe or conduit to be rigidly supported on both sides of the wall assembly. The following types and sizes of nonmetallic pipes or conduits may be used:
 - A. **Polyvinyl Chloride (PVC) Pipe** – Nom 6 in. (152 mm) diameter (or smaller) Schedule 40 solid core or cellular core PVC pipe for use in closed (process or supply) or vented (drain, waste or vent) piping system.
 - B. **Rigid Nonmetallic Conduit++** – Nom 6 in. (152 mm) diameter (or smaller) Schedule 40 PVC conduit installed in accordance with the National Electrical Code (NFPA No. 70).
 - C. **Chlorinated Polyvinyl Chloride (CPVC) Pipe** – Nom 6 in. (152 mm) diameter (or smaller) SDR13.5 CPVC pipe for use in closed (process or supply) piping systems.
 - D. **Acrylonitrile Butadiene Styrene (ABS) Pipe** – Nom 6 in. (152 mm) diameter (or smaller) Schedule 40 solid core or cellular core ABS pipe for use in closed (process or supply) or vented (drain, waste or vent) piping systems.
 - E. **Fire Retardant Polypropylene (FRPP) Pipe** – Nom 6 in. (152 mm) diameter (or smaller) Schedule 40 FRPP pipe for use in closed (process or supply) or vented (drain, waste or vent) piping system.
3. **Firestop System** – The details of the firestop system shall be as follows:
 - A. **Fill, Void or Cavity Materials* – Caulk, Sealant or Putty** – Min 1/2 in. (13 mm) thickness of caulk or putty shall be applied within annular space on both sides of wall, flush with both wall surfaces.
3M COMPANY – CP 25WB+ caulk, MP+ Stix putty, IC 15WB+ caulk, FireDam 150+ caulk or FB-3000 WT sealant.
 (Note: CP 25WB+ and FireDam 150+ not suitable for use with CPVC pipes.)
 - B. **Fill, Void or Cavity Materials* – Wrap Strip** – Nom 1/8 in. (3.2 mm) thick intumescent material supplied in 2 in. (51 mm) wide strips. Min four continuous layers of wrap strip tightly wrapped around nonmetallic pipe on both sides of the wall and butted tightly against the wall surfaces. An additional stack of four continuous layers of wrap strip tightly wrapped around nonmetallic pipe on both sides of the wall and butted tightly against the first layers of wrap strip.
3M COMPANY – Ultra GS
 - C. **Steel Collar** – Two nom 2 in. (51 mm) deep collars with 1-1/4 in. (32 mm) wide by 2 in. (51 mm) long anchor tabs and min 1/2 in. (13 mm) long tabs to retain wrap strip layers. Coils of precut 0.016 in. (.41 mm) thick (28 gauge) galvanized sheet steel available from wrap strip manufacturer. As an alternate, collars may be field-fabricated from min 0.016 in. (.41 mm) thick (28 gauge) galvanized sheet steel in accordance with instruction sheet supplied by wrap strip manufacturer. Steel collars wrapped tightly around wrap strip layers with min 1 in. (25 mm) overlap at seams, with anchor tabs bent outward 90 degrees for inner collars for securement to wall. Anchor tabs for outer collars to overlap onto inner collars. Collars to be compressed around wrap strip layers using a min 1/2 in. (13 mm) wide by 0.028 in. (.71 mm) thick stainless steel band clamp at each collar's midheight. An additional min 1/2 in. (13 mm) wide by 0.028 in. thick stainless steel band clamp to be tightly fastened around collars at the point where anchor tabs of outer collars overlap onto inner collars. Inner collars to be secured to wall surfaces with 3/16 in. (5 mm) diameter steel toggle bolts, or equivalent, in conjunction with min 1-1/4 in. (32 mm) diameter steel fender washers. Min of six anchor bolts, symmetrically located, required.

*Bearing the UL Classification Marking

++Bearing the UL Listing Mark

Reprinted from the Online Certifications Directory with permission from Underwriters Laboratories Inc.

Copyright © 2011 Underwriters Laboratories Inc.®

System No. W-L-2154

February 12, 2016

F Ratings — 1 and 2 Hr (See Item 1)

T Ratings — 1 and 2 Hr (See Item 1)

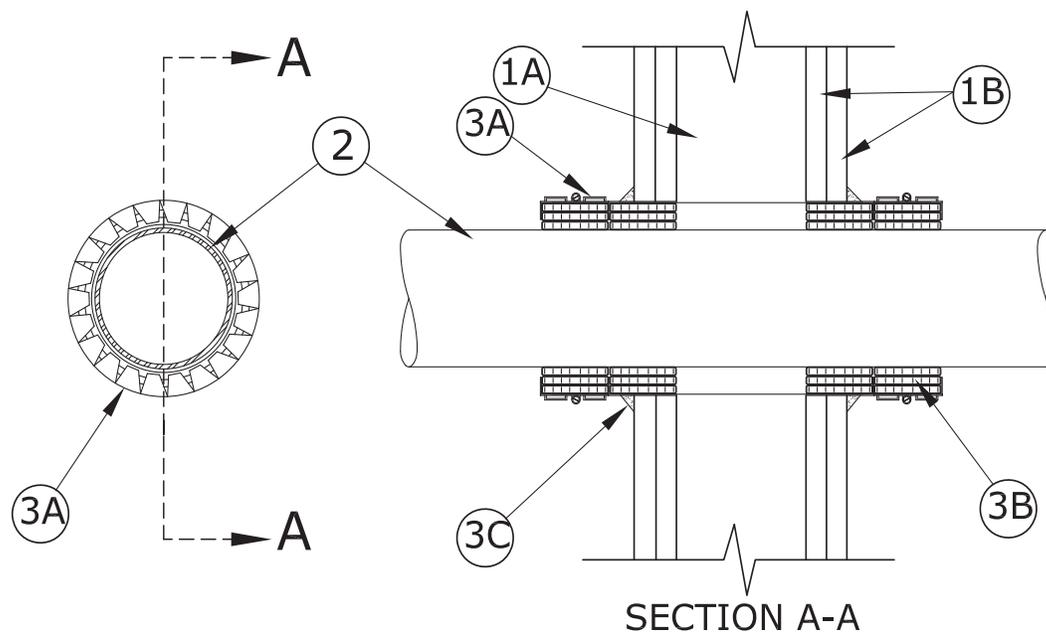

- Wall Assembly** — The 1 or 2 hr fire rated gypsum board/stud wall assembly shall be constructed of the materials and in the manner specified in the individual U300, U400 or V400 Series Wall and Partition Designs in the UL Fire Resistance Directory and shall include the following construction features:

- Studs** — Wall framing may consist of either wood studs or steel channel studs. Wood studs to consist of nom 2 by 4 in. (51 by 102 mm) lumber spaced 16 in. (406 mm) OC. Steel studs to be min 3-1/2 in. (89 mm) wide and spaced max 24 in. (610 mm) OC.
- Gypsum Board*** — Thickness, type, number of layers and fasteners as required in the individual Wall and Partition Design. Max diameter of opening is 7-3/4 in. (196.9 mm).

The hourly F and T Ratings of the firestop system is equal to the hourly fire rating of the wall assembly in which it is installed.

- Through Penetrants** — One nonmetallic pipe or conduit to be centered within opening with a nom 1/4 in. (6 mm) annular space between pipe or conduit and periphery of opening. Pipe or conduit to be rigidly supported on both sides of the wall assembly. The following types and sizes of nonmetallic pipes or conduits may be used:

- Polyvinyl Chloride (PVC) Pipe** — Nom 6 in. (152 mm) diameter (or smaller) Schedule 40 solid core PVC pipe for use in closed (process or supply) or vented (drain, waste or vent) piping system.
- Rigid Nonmetallic Conduit++** — Nom 6 in. (152 mm) diameter (or smaller) Schedule 40 PVC conduit installed in accordance with the National Electrical Code (NFPA No. 70).
- Chlorinated Polyvinyl Chloride (CPVC) Pipe** — Nom 6 in. (152 mm) diameter (or smaller) SDR13.5 CPVC pipe for use in closed (process or supply) piping systems.

- Firestop System** — The details of the firestop system shall be as follows:

- Steel Sleeve** — Minimum 26 gauge galvanized steel cut 6 in. (152 mm) longer than overall width of wall with the outside diameter equal to diameter of opening in wall with a min 1 in. (25 mm) overlap along longitudinal seam. Sleeve placed in wall opening such that 3 in. (76 mm) extends beyond both sides of wall. Edges of sleeve to be provided with 1/2 in. (13 mm) long slits to form retaining tabs.
- Fill, Void or Cavity Materials* — Wrap Strip** — Nom 1/8 in. (3.2 mm) thick intumescent material supplied in 2 in. (51 mm) wide strips. Min four continuous layers of wrap strip tightly wrapped around nonmetallic pipe on both sides of the wall, and recessed within steel sleeve 2-1/2 in. (64 mm) from the end of sleeve on both sides of wall. An additional stack of four continuous layers of wrap strip tightly wrapped around nonmetallic pipe on both sides of the wall and butted tightly against the first layers of wrap strip and recessed 1/2 in. (13 mm) from each end of sleeve. The slit edges of sleeve to be bent 90 degrees toward pipe. Two min 1/2 in. (13 mm) wide by 0.028 in. (.71 mm) thick stainless steel band clamps shall be tightly fastened around sleeve on both sides of wall, approximately 1/2 in. (13 mm) from the wall surfaces and 3/4 in. (19 mm) from each end of sleeve.

3M COMPANY — Ultra GS

- Fill, Void or Cavity Materials* — Caulk or Sealant** — Min 1/2 in. (13 mm) diameter bead of caulk shall be applied to outer perimeter of sleeve on both sides of wall at sleeve/wall interface. Min 1/4 in. (6 mm) diameter bead of caulk shall be applied to outer perimeter of penetrant on both sides of wall at penetrant/wrap strip interface (not shown).

3M COMPANY — CP 25WB+ caulk, IC 15WB+ caulk, FireDam 150+ caulk or FB-3000 WT sealant. (Note: CP 25WB+ and FireDam 150+ not suitable for use with CPVC pipes.)

*Bearing the UL Classification Marking

++Bearing the UL Listing Mark

Reprinted from the Online Certifications Directory with permission from UL

© 2016 UL LLC

System No. W-L-2162

November 20, 2009

F Ratings – 1, 2 and 3 Hr (See Item 1)

T Ratings – 1, 2 and 3 Hr (See Item 1)

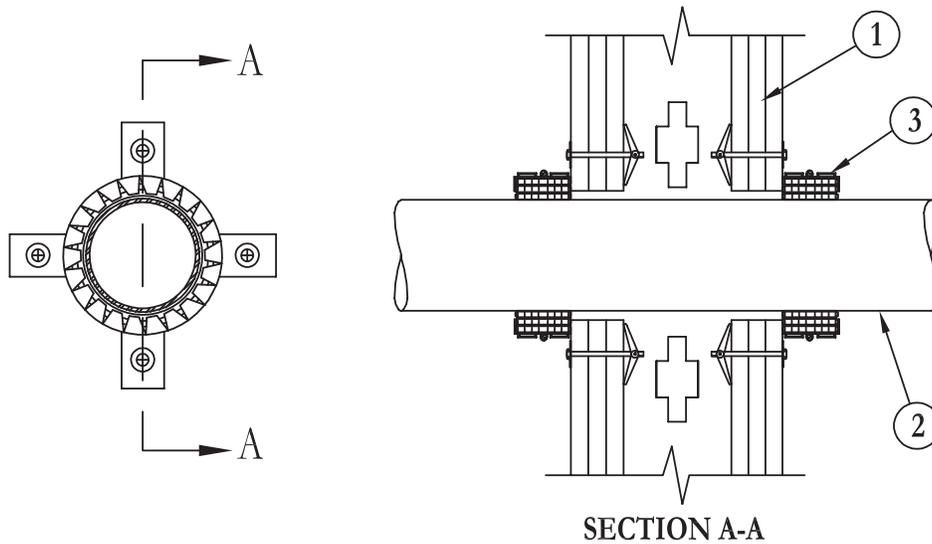

- Wall Assembly** – The 1, 2 or 3 hr fire rated gypsum board/stud wall assembly shall be constructed of the materials and in the manner specified in the individual U300, U400 or V400 Series Wall and Partition Designs in the UL Fire Resistance Directory and shall include the following construction features:

- Studs** – Wall framing may consist of either wood studs or steel channel studs. Wood studs to consist of nom 2 by 4 in. (51 by 102 mm) lumber spaced 16 in. (406 mm) OC. Steel studs to be min 3-1/2 in. (89 mm) wide spaced max 24 in. (610 mm) OC. When wood studs are used, the assembly is limited to 1 and 2 hr. ratings.
- Gypsum Board*** – Thickness, type, number of layers and fasteners as required in the individual Wall and Partition Design. Max diam of opening is 5 in. (127 mm).

The hourly F Rating of the firestop system is equal to the hourly fire rating of the wall assembly in which it is installed.

- Through Penetrants** – One nonmetallic pipe or conduit to be centered within opening with a nom 1/4 in. (6 mm) annular space between pipe or conduit and periphery of opening. Pipe or conduit to be rigidly supported on both sides of the wall assembly. The following types and sizes of nonmetallic pipes or conduits may be used:
 - Polyvinyl Chloride (PVC) Pipe** – Nom 4 in. (102 mm) diam (or smaller) Schedule 40 solid core or cellular core PVC pipe for use in closed (process or supply) or vented (drain, waste or vent) piping system.
 - Rigid Nonmetallic Conduit++** – Nom 4 in. (102 mm) diam (or smaller) Schedule 40 PVC conduit installed in accordance with the National Electrical Code (NFPA No. 70).
 - Chlorinated Polyvinyl Chloride (CPVC) Pipe** – Nom 4 in. (102 mm) diam (or smaller) SDR13.5 CPVC pipe for use in closed (process or supply) piping systems.
 - Acrylonitrile Butadiene Styrene (ABS) Pipe** – Nom 4 in. (102 mm) diam (or smaller) Schedule 40 solid core or cellular core ABS pipe for use in closed (process or supply) or vented (drain, waste or vent) piping systems.
 - Fire Retardant Polypropylene (FRPP) Pipe** – Nom 4 in. (102 mm) diam (or smaller) Schedule 40 FRPP pipe for use in closed (process or supply) or vented (drain, waste or vent) piping system.
 - Polyvinylidene Fluoride (PVDF) Pipe** – Nom. 4 in. (102 mm) diam (or smaller) Schedule 40 PVDF pipe for use in closed (process or supply) or vented (drain, waste or vent) piping systems.

The T Ratings are 1, 2 and 3 Hr for pipes A, B and C in 1, 2 and 3 Hr rated wall assemblies, respectively. The T Ratings for pipe D, E and F are 1 Hr in 1 and 2 Hr rated wall assemblies and 2 Hr in 3 Hr rated wall assemblies.

- Firestop Device – Collar** – Collar to be installed in accordance with the accompanying installation instructions. Collar to be installed and latched around pipe and secured to both sides of wall with 3M Ultra Fast Anchor Straps or with 1/4 in. (6 mm) diam by min 1-1/2 in. (38 mm) long steel toggle bolts in conjunction with min 1-1/4 in. (32 mm) diam steel fender washers. Min of two, three or four anchor straps or anchor bolts, symmetrically located, for nom 2 in. (51 mm) diam (and smaller), nom 3 in. (76 mm) diam and nom 4 in. (102 mm) diam pipes, respectively.

3M COMPANY – Ultra PPD 1.5, 2.0, 3.0 and 4.0

- Fill, Void or Cavity Materials* – Caulk, Sealant or Putty** – (Optional, Not Shown) – Generous bead of caulk or putty may be applied to outer perimeter of collar at its interface with wall surfaces.

3M COMPANY – CP 25WB+ caulk, MP+ Stix putty, IC 15WB+ caulk, FireDam 150+ caulk or FB-3000 WT sealant.

(Note: CP 25WB+ and FireDam 150+ not suitable for use with CPVC pipes.)

*Bearing the UL Classification Marking

++Bearing the UL Listing Mark

Reprinted from the Online Certifications Directory with permission from Underwriters Laboratories Inc.

Copyright © 2011 Underwriters Laboratories Inc.®

System No. W-L-2172

September 07, 2004

F Rating – 1 Hr

T Rating – 1 Hr

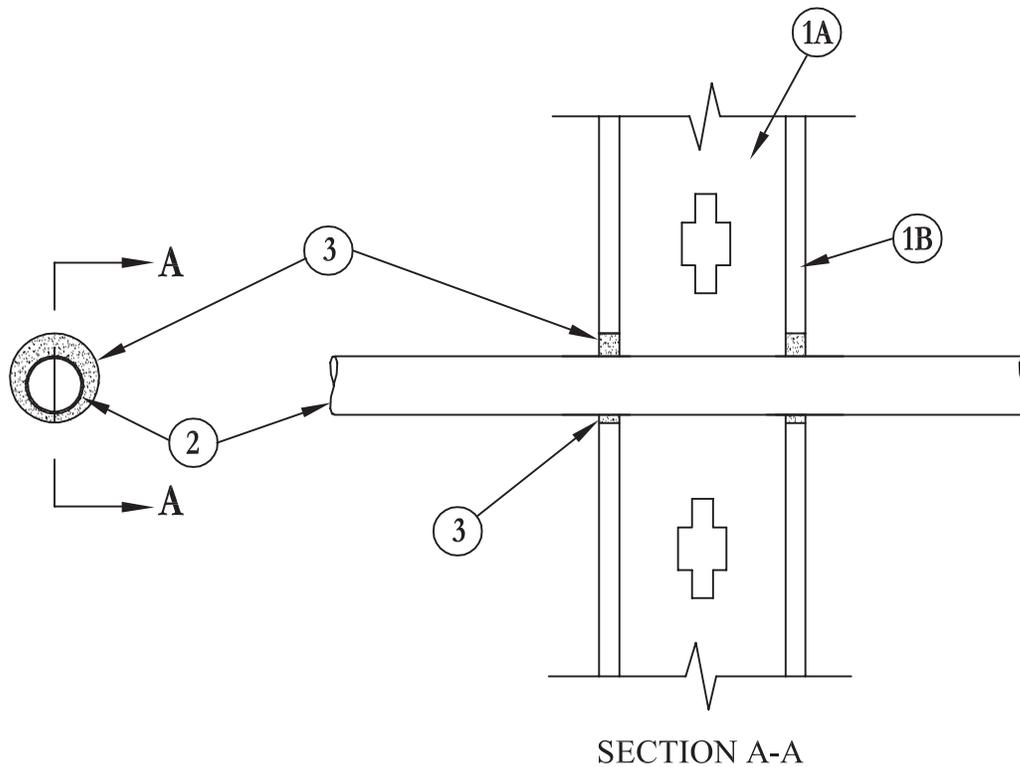

- Wall Assembly** – The fire-rated gypsum wallboard/stud wall assembly shall be constructed of the materials and in the manner specified in the individual U300 or U400 Series Wall and Partition Designs in the UL Fire Resistance Directory and shall include the following construction features:
 - Studs** – Wall framing may consist of either wood studs or steel channel studs. Wood studs to consist of nom 2 in. by 4 in. lumber spaced 16 in. OC. Steel studs to be min 2-1/2 in. wide and spaced max 24 in. OC.
 - Gypsum Board*** – One layer of 5/8 in. thick gypsum wallboard, as specified in the individual Wall and Partition Design. Max diam of opening is 2-1/4 in.
- Through Penetrants** – One nonmetallic pipe or conduit for use in closed (process or supply) or vented (drain, waste or vent) piping systems, installed either concentrically or eccentrically within the firestop system. The annular space between the pipe or conduit and the edge of the opening shall be min 3/8 in. to max 13/16 in. Pipe or conduit to be rigidly supported on both sides of wall assembly. The following types and sizes of nonmetallic pipes or conduits may be used:
 - Polyvinyl Chloride (PVC) Pipe** – Nom 3/4 in. diam (or smaller) Schedule 40 solid core PVC pipe.
 - Chlorinated Polyvinyl Chloride (CPVC) Pipe** – Nom 3/4 in. diam (or smaller) SDR13.5 CPVC pipe.
- Fill, Void or Cavity Material* – Sealant** – Min thickness of 5/8 in. of fill material applied within annulus between pipe or conduit and periphery of the opening, flush with both surfaces of wall assembly.

3M COMPANY – FB-1000 NS or FB-3000 WT sealant

*Bearing the UL Classification Marking

Reprinted from the Online Certifications Directory with permission from Underwriters Laboratories Inc.

Copyright © 2011 Underwriters Laboratories Inc.®

Through Penetrations

Non-Metallic Pipes

2000 Series

Gypsum

WL

System No. W-L-2173

September 07, 2004

F Rating – 1 Hr

T Rating – 0 Hr

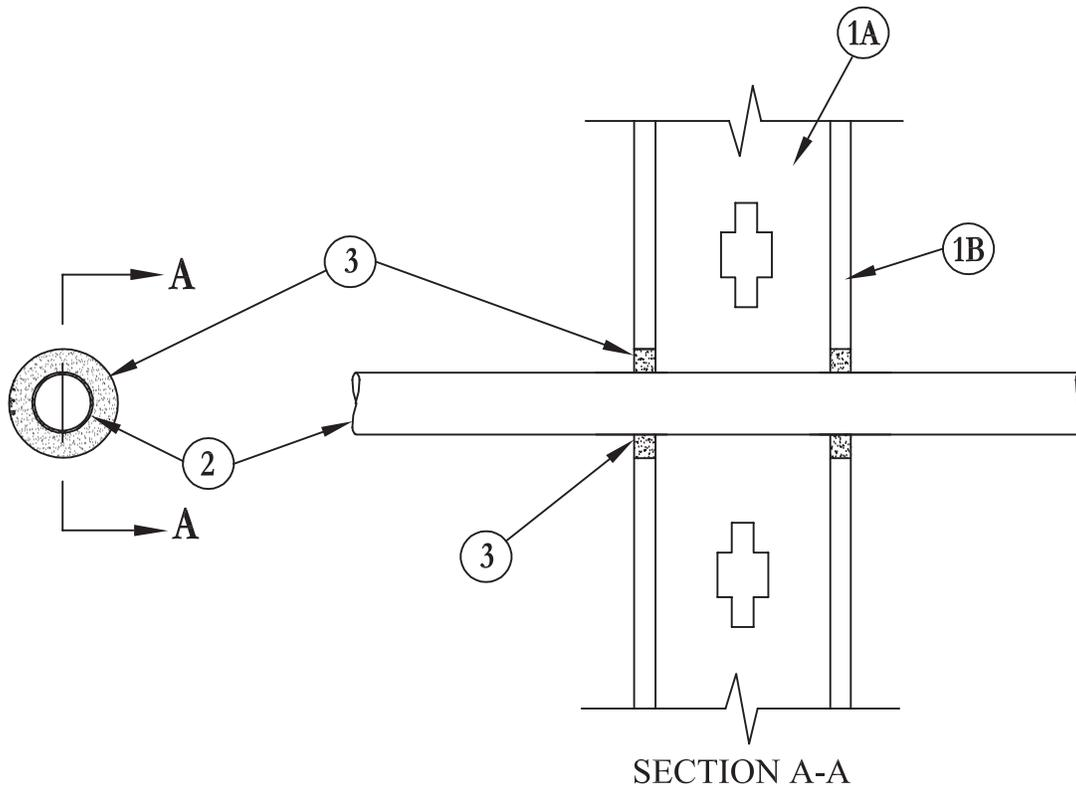

- Wall Assembly** – The fire-rated gypsum wallboard/stud wall assembly shall be constructed of the materials and in the manner specified in the individual U300 or U400 Series Wall and Partition Designs in the UL Fire Resistance Directory and shall include the following construction features:
 - Studs** – Wall framing may consist of either wood studs or steel channel studs. Wood studs to consist of nom 2 in. by 4 in. lumber spaced 16 in. OC. Steel studs to be min 2-1/2 in. wide and spaced max 24 in. OC.
 - Gypsum Board*** – One layer of nom 5/8 in. thick gypsum wallboard, as specified in the individual Wall and Partition Design. Max diam of opening is 2-1/4 in.
- Crosslinked Polyethylene (PEX) Tubing** – Nom 3/4 in. diam (or smaller) SDR 9 PEX tubing for use in closed (process or supply) or vented (drain, waste or vent) piping systems, installed either concentrically or eccentrically within the firestop system. The annular space between the tubing and the edge of the opening shall be min 1/2 in. to max 5/8 in. Tubing to be rigidly supported on both sides of wall assembly.
- Fill, Void or Cavity Material* – Sealant** – Min 5/8 in. thickness of fill material applied within the annulus, flush with both surfaces of wall.
3M COMPANY – FB-1000 NS or FB-3000 WT sealant

*Bearing the UL Classification Marking

Reprinted from the Online Certifications Directory with permission from Underwriters Laboratories Inc.
 Copyright © 2011 Underwriters Laboratories Inc.®

System No. W-L-2174

September 07, 2004
F Ratings – 1 & 2 Hr (See Item 1)
T Rating – 0 Hr

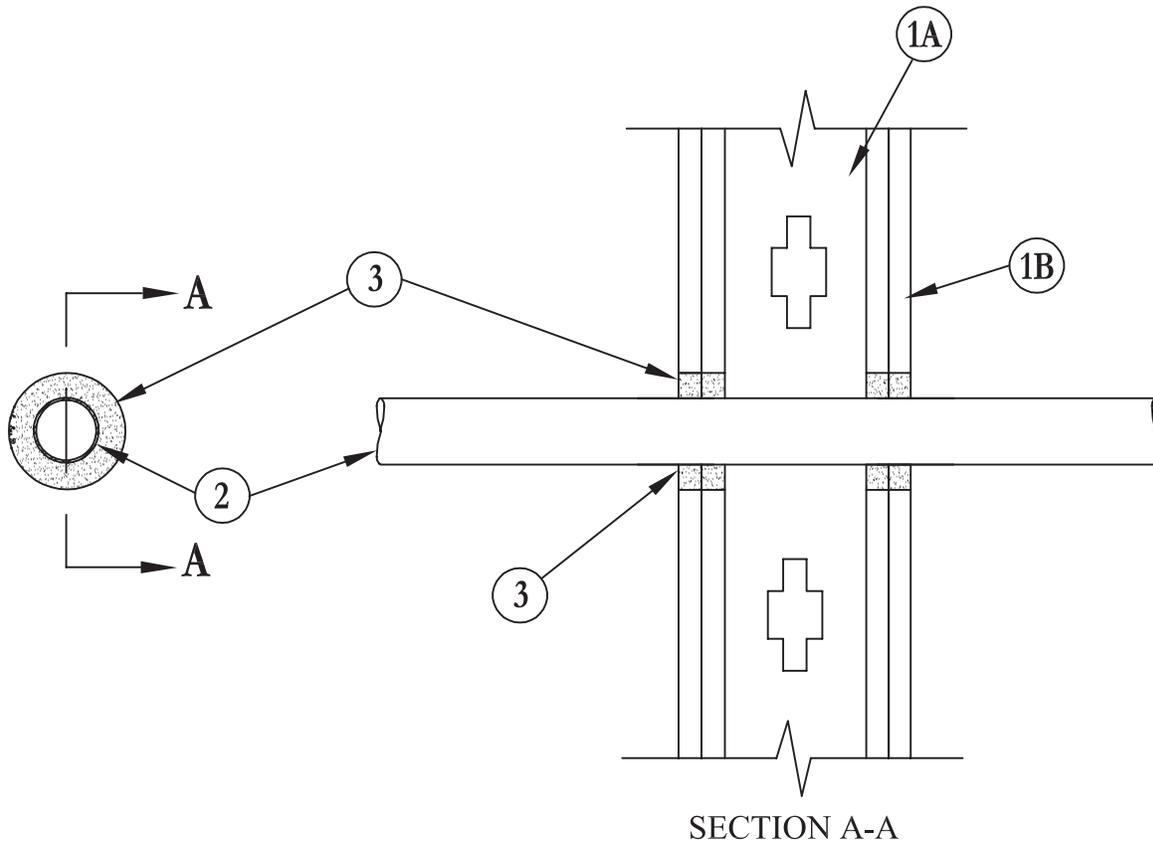

- Wall Assembly** – The 1 or 2 hr fire rated gypsum wallboard/stud wall assembly shall be constructed of the materials and in the manner specified in the individual U300 or U400 Series Wall and Partition Designs in the UL Fire Resistance Directory and shall include the following construction features:
 - Studs** – Wall framing may consist of either wood studs or steel channel studs. Wood studs to consist of nom 2 in. by 4 in. lumber spaced 16 in. OC. Steel studs to be min 2-1/2 in. wide and spaced max 24 in. OC.
 - Gypsum Board*** – Thickness, type, number of layers and fasteners as required in the individual Wall and Partition Design. Max diam of opening is 2-1/4 in.

The hourly F Rating of the firestop system is equal to the hourly fire rating of the wall assembly in which it is installed.
- Through Penetrants** – One nonmetallic pipe or conduit installed either concentrically or eccentrically within the firestop system. The annular space between the pipe or conduit and the edge of the opening shall be min 1/8 in. to max 1/4 in. Pipe or conduit to be rigidly supported on both sides of wall assembly. The following types and sizes of nonmetallic pipes or conduits may be used:
 - Polyvinyl Chloride (PVC) Pipe** – Nom 1-1/2 in. diam (or smaller) Schedule 40 solid core PVC pipe for use in closed (process or supply) or vented (drain, waste or vent) piping systems.
 - Chlorinated Polyvinyl Chloride (CPVC) Pipe** – Nom 1-1/2 in. diam (or smaller) SDR13.5 CPVC pipe for use in closed (process or supply) piping systems.
 - Rigid Nonmetallic Conduit+** – Nom 1-1/2 in. diam (or smaller) Schedule 40 PVC conduit installed in accordance with Article 347 of the National Electrical Code (NFPA No. 70).
- Fill, Void or Cavity Material* – Sealant** – Min thickness of 5/8 in. and 1-1/4 in. of fill material applied within annulus, flush with both surfaces of wall assembly for 1 hr and 2 hr rated wall assemblies, respectively.

3M COMPANY – FB-1000 NS or FB-3000 WT sealant

*Bearing the UL Classification Marking

+Bearing the UL Listing Mark

Reprinted from the Online Certifications Directory with permission from Underwriters Laboratories Inc.
Copyright © 2011 Underwriters Laboratories Inc.®

Through Penetrations

Non-Metallic Pipes

2000 Series

Gypsum

WL

System No. W-L-2180

May 19, 2005

F Ratings – 1 & 2 Hr (See Item 1)

T Ratings – 1 & 2 Hr (See Item 1)

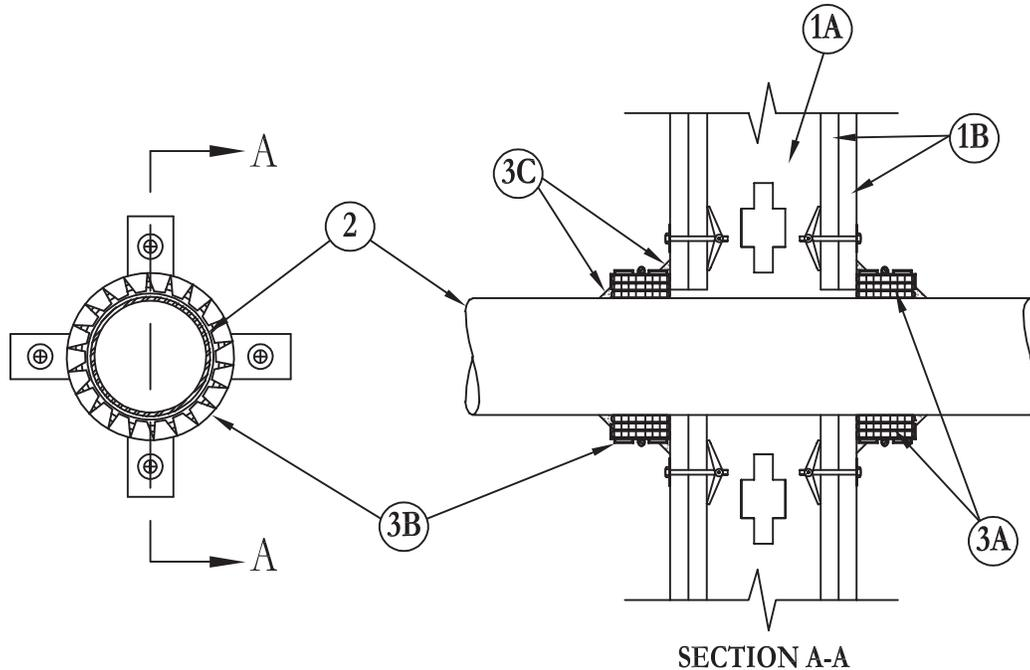

1. **Wall Assembly** – The 1 or 2 hr fire rated gypsum board/stud wall assembly shall be constructed of the materials and in the manner specified in the individual U300, U400 or V400 Series Wall and Partition Designs in the UL Fire Resistance Directory and shall include the following construction features:
 - A. **Studs** – Wall framing may consist of either wood studs or steel channel studs. Wood studs to consist of nom 2 in. by 4 in. (51 mm by 102 mm) lumber spaced 16 in. (406 mm) OC. Steel studs to be min 3-1/2 in. (89 mm) wide and spaced max 24 in. (610 mm) OC.
 - B. **Gypsum Board*** – Thickness, type, number of layers and fasteners as required in the individual Wall and Partition Design. Max diam of opening is 5 in. (127 mm).

The hourly F Rating and T Rating of the firestop system is equal to the hourly fire rating of the wall assembly in which it is installed.
2. **Through Penetrant** – Nom 2 in. (51 mm) diam (or smaller) SDR 11, or nom 4 in. (102 mm) diam (or smaller) SDR 32.5 polyvinylidene fluoride (PVDF) pipe for use in closed (process or supply) or vented (drain, waste or vent) piping systems. One pipe to be centered within opening with a nom 1/4 in. (6 mm) annular space between pipe and periphery of opening. Pipe to be rigidly supported on both sides of the wall assembly.
3. **Firestop System** – The details of the firestop system shall be as follows:
 - A. **Fill, Void or Cavity Materials* – Wrap Strip** – Nom 1/8 in. (3.2 mm) thick intumescent material supplied in 2 in. (51 mm) wide strips. Wrap strip tightly wrapped around nonmetallic pipe with continuous layers and butted tightly against both surfaces of the wall. The min number of layers required is dependent upon the nom diam of the pipe. For nom 2 in. (51 mm) diam (and smaller) pipes, two layers are required. For nom 2-1/2 in. and 3 in. (64 mm and 76 mm) diam pipes, three layers are required. For nom 3-1/2 in. and 4 in. (89 mm and 102 mm) diam pipes, four layers are required. Wrap strip layers temporarily held in position using aluminum foil tape, steel wire tie, or equivalent.

3M COMPANY – Ultra GS
 - B. **Steel Collar** – Nom 2 in. (51 mm) deep collar with 1-1/4 in. (32 mm) wide by 2 in. (51 mm) long anchor tabs and min 1/2 in. (13 mm) long tabs to retain wrap strip layers. Coils of precut 0.016 in. (0.41 mm) thick (28 gauge) galv sheet steel available from wrap strip manufacturer. As an alternate, collar may be field-fabricated from min 0.016 in. (0.41 mm) thick (28 gauge) galv sheet steel in accordance with instruction sheet supplied by wrap strip manufacturer. Steel collar, with anchor tabs bent outward 90°, wrapped tightly around wrap strip layers with min 1 in. (25 mm) overlap at seam. Anchor tabs to be pressed tightly against wall surfaces, and collar to be compressed around wrap strip layers using a min 1/2 in. (13 mm) wide by 0.028 in. (0.71 mm) thick stainless steel band clamp at the middle of collar. As an alternate to the band clamp, collar for systems with three or more layers of wrap strip may be fastened together along the overlapping seam with three No. 6 by 3/8 in. (10 mm) long self-tapping steel screws. Collar to be secured to wall surfaces with 3/16 in. (5 mm) diam steel toggle bolts in conjunction with min 1-1/4 in. (32 mm) diam steel fender washers. Min of two, three or four anchor bolts, symmetrically located, for nom 2 in. (51 mm) diam (and smaller), nom 3 in. (76 mm) diam (and smaller) and nom 4 in. (102 mm) diam (and smaller), pipes, respectively.
 - C. **Fill, Void or Cavity Materials* – Caulk, Sealant or Putty** – Min 1/2 in. (13 mm) diam bead of caulk or putty shall be applied to outer perimeter of collar at its interface with wall surface(s).

3M COMPANY – CP 25WB+, IC 15WB+, FireDam 150+ caulk, FB-3000 WT sealant or MP+ Stix putty

*Bearing the UL Classification Marking

+Bearing the UL Listing Mark

Reprinted from the Online Certifications Directory with permission from Underwriters Laboratories Inc.

Copyright © 2011 Underwriters Laboratories Inc.®

System No. W-L-2264

November 20, 2009

F Ratings – 1 and 2 Hr (See Item 1)

T Ratings – 0, 1 and 2 Hr (See Item 2)

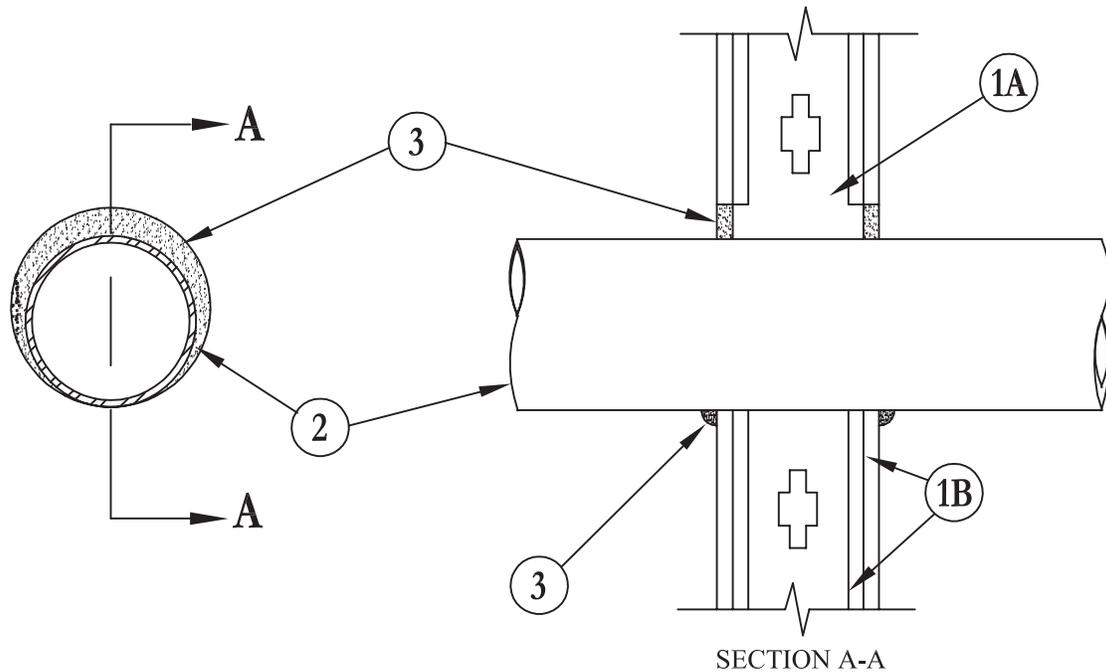

1. **Wall Assembly** – The 1 and 2 hr fire rated gypsum board/stud wall assemblies shall be constructed of the materials and in the manner specified in the individual U300, U400 or V400 Series Wall and Partition Designs in the UL Fire Resistance Directory and shall include the following construction features:

- A. **Studs** – Wall framing may consist of either wood studs or steel channel studs. Wood studs to consist of nom 2 by 4 in. (51 by 102 mm) lumber spaced 16 in. (406 mm) OC. Steel studs to be min 3-1/2 in. (89 mm) wide and spaced max 24 in. (610 mm) OC.
- B. **Gypsum Board*** – Thickness, type, number of layers and fasteners as required in the individual Wall and Partition Design. Diam of opening shall be 1 in. (25 mm) larger than nom pipe diam.

The hourly F Rating of the firestop system is equal to the hourly fire rating of the wall assembly in which it is installed.

2. **Through Penetrants** – One nonmetallic pipe or conduit to be installed either concentrically or eccentrically within the firestop system. The annular space between the pipe or conduit and periphery of opening shall be min of 0 in. (0 mm, point contact) to max 5/8 in. (16 mm). Pipe or conduit to be rigidly supported on both sides of wall assembly. The following types and sizes of nonmetallic pipes or conduits may be used:

- A. **Polyvinyl Chloride (PVC) Pipe** – Nom 2 in. (51 mm) diam (or smaller). Schedule 40 solid core or cellular core PVC pipe for use in closed (process or supply) or vented (drain, waste or vent) piping systems.
- B. **Chlorinated Polyvinyl Chloride (CPVC) Pipe** – Nom 2 in. (51 mm) diam (or smaller) SDR13.5 CPVC pipe for use in closed (process or supply) piping systems.
- C. **Rigid Nonmetallic Conduit+** – Nom 2 in. (51 mm) diam (or smaller). Schedule 40 PVC conduit installed in accordance with the National Electrical Code (NFPA No. 70).
- D. **Acrylonitrile Butadiene Styrene (ABS) Pipe** – Nom 2 in. (51 mm) diam (or smaller). Schedule 40 solid core or cellular core ABS pipe for use in closed (process or supply) or vented (drain, waste or vent) piping systems.

The hourly T Rating of the firestop system is 0 Hr when pipes are used in vented (drain, waste or vent) piping systems. The hourly T Rating of the firestop system is equal to the hourly fire rating of the wall assembly in which it is installed when pipes are used in closed (process or supply) piping systems.

3. **Fill, Void or Cavity Materials* – Caulk or Sealant** – Min thickness of 5/8 in. (16 mm) of caulk applied within annulus between pipe or conduit and periphery of the opening, flush with both surfaces of wall assembly. At the point contact location between pipe or conduit and gypsum board, a min 1/2 in. (13 mm) diam bead of caulk or putty shall be applied at the pipe or conduit/gypsum board interface on both surfaces of wall assembly.

3M COMPANY – FireDam 150+, CP 25WB+, IC 15WB+ caulk or FB-3000 WT sealant.

(Note: CP 25WB+ and FireDam 150+ not suitable for use with CPVC pipes.)

*Bearing the UL Classification Mark

Reprinted from the Online Certifications Directory with permission from Underwriters Laboratories Inc.

Copyright © 2011 Underwriters Laboratories Inc.®

System No. W-L-2265

May 19, 2005

F Rating – 4 Hr

T Rating – 4 Hr

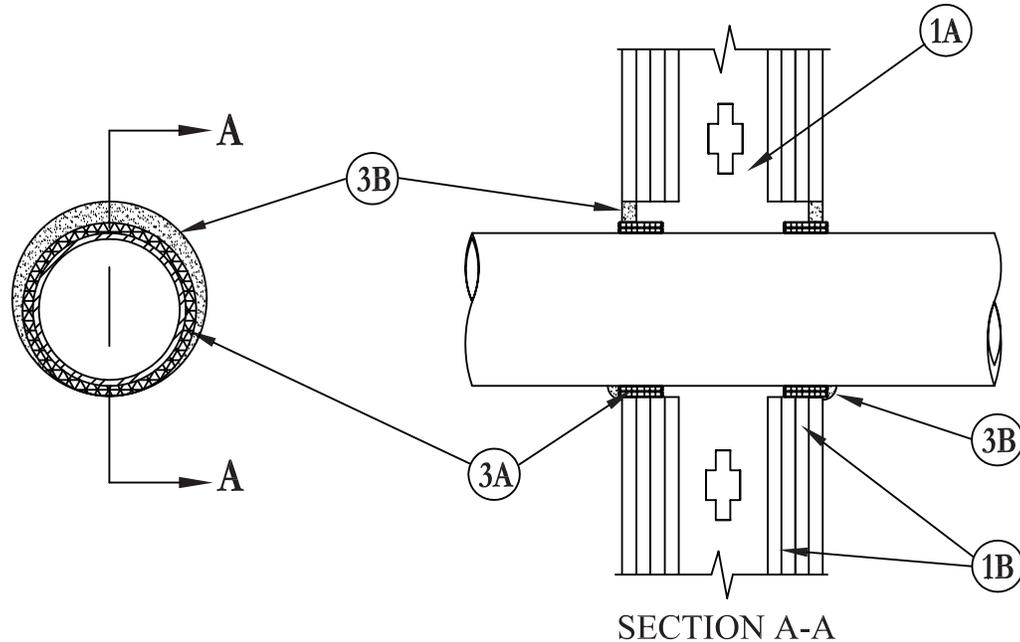

1. **Wall Assembly** – The 4 hr fire rated gypsum board/stud wall assembly shall be constructed of the materials and in the manner specified in the individual U300, U400 or V400 Series Wall and Partition Designs in the UL Fire Resistance Directory and shall include the following construction features:
 - A. **Studs** – Wall framing shall consist of min 3-1/2 in. (89 mm) wide steel channel studs spaced max 24 in. (610 mm) OC.
 - B. **Gypsum Board*** – Thickness, type, number of layers and fasteners as required in the individual Wall and Partition Design. Max diam of opening is 3 in.
2. **Through Penetrants** – One nonmetallic pipe or conduit to be installed either concentrically or eccentrically within the firestop system. The annular space between the pipe or conduit and periphery of opening shall be min of 1/4 in. to max 7/8 in. (4 mm to max 22 mm). Pipe or conduit to be rigidly supported on both sides of wall assembly. The following types and sizes of nonmetallic pipes or conduits may be used:
 - A. **Polyvinyl Chloride (PVC) Pipe** – Nom 1-1/2 in. (38 mm) diam (or smaller). Schedule 40 solid core or cellular core PVC pipe for use in closed (process or supply) or vented (drain, waste or vent) piping systems.
 - B. **Chlorinated Polyvinyl Chloride (CPVC) Pipe** – Nom 1-1/2 in. (38 mm) diam (or smaller) SDR13.5 CPVC pipe for use in closed (process or supply) piping systems.
 - C. **Rigid Nonmetallic Conduit++** – Nom 1-1/2 in. (38 mm) diam (or smaller). Schedule 40 PVC conduit installed in accordance with Article 347 of the National Electrical Code (NFPA No. 70).
 - D. **Acrylonitrile Butadiene Styrene (ABS) Pipe** – Nom 1-1/2 in. (38 mm) diam (or smaller). Schedule 40 solid core or cellular core ABS pipe for use in closed (process or supply) or vented (drain, waste or vent) piping systems.
 - E. **Fire Retardant Polypropylene (FRPP) Pipe** – Nom 1-1/2 in. (38 mm) diam (or smaller). Schedule 40 FRPP pipe for use in closed (process or supply) or vented (drain, waste or vent) piping systems.
3. **Firestop System** – The firestop system shall consist of the following:
 - A. **Fill, Void or Cavity Materials* – Wrap Strip** – Nom 1/8 in. (3.2 mm) thick intumescent material supplied in 2 in. (51 mm) wide strips. Two continuous layers of wrap strip tightly wrapped around nonmetallic pipe and held in place with 2 in. (51 mm) wide min 3 mil foil tape. Wrap strip to be slid into annular space on both sides of wall such that a 1/4 in. (6 mm) of wrap strip extends beyond both surfaces of the wall.
3M COMPANY – Ultra GS
 - B. **Fill, Void or Cavity Materials* – Caulk or Sealant** – Min thickness of 5/8 in. (16 mm) of caulk applied within annulus between wrap strip and periphery of the opening, flush with both surfaces of wall assembly. An additional 1/4 in. (6 mm) diam bead of caulk applied at the wrap strip/gypsum board interface on both sides of wall.
3M COMPANY – IC 15WB+, CP 25WB+ caulk or FB-3000 WT sealant
 (Note: CP 25WB+ not suitable for use with CPVC pipes.)

*Bearing the UL Classification Mark

++Bearing the UL Listing Mark

Reprinted from the Online Certifications Directory with permission from Underwriters Laboratories Inc.

Copyright © 2011 Underwriters Laboratories Inc.®

System No. W-L-2266

May 19, 2005

F Rating – 4 Hr

T Rating – 4 Hr

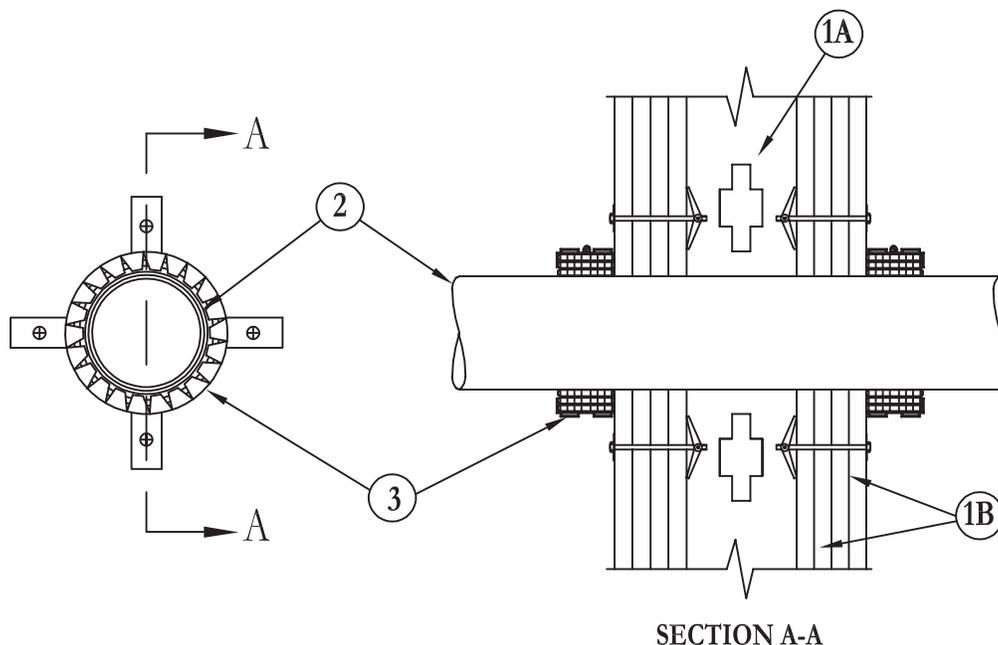

1. **Wall Assembly** – The 4 hr fire rated gypsum board/stud wall assembly shall be constructed of the materials and in the manner specified in the individual U300, U400 or V400 Series Wall and Partition Designs in the UL Fire Resistance Directory and shall include the following construction features:
 - A. **Studs** – Wall framing may consist of either wood studs or steel channel studs. Wood studs to consist of nom 2 in. by 4 in. (51 mm by 102 mm) lumber spaced 16 in. (406 mm) OC. Steel studs to be min 3-1/2 in. (89 mm) wide and spaced max 24 in. (610 mm) OC.
 - B. **Gypsum Board*** – Thickness, type, number of layers and fasteners as required in the individual Wall and Partition Design. Diam of opening is 5 in. (127 mm).
2. **Through Penetrants** – One nonmetallic pipe or conduit to be installed either concentrically or eccentrically within the firestop system. The annular space between the pipe or conduit and periphery of opening shall be min of 0 in. (point contact) to max 1/2 in. (0 mm to max 13 mm). In all cases, the firestop device (Item 3) shall entirely cover the annular space. Pipe or conduit to be rigidly supported on both sides of wall assembly. The following types and sizes of nonmetallic pipes or conduits may be used:
 - A. **Polyvinyl Chloride (PVC) Pipe** – Nom 4 in. (102 mm) diam (or smaller). Schedule 40 solid core or cellular core PVC pipe for use in closed (process or supply) or vented (drain, waste or vent) piping systems.
 - B. **Chlorinated Polyvinyl Chloride (CPVC) Pipe** – Nom 4 in. (102 mm) diam (or smaller) SDR13.5 CPVC pipe for use in closed (process or supply) piping systems.
 - C. **Rigid Nonmetallic Conduit++** – Nom 4 in. (102 mm) diam (or smaller). Schedule 40 PVC conduit installed in accordance with Article 347 of the National Electrical Code (NFPA No. 70).
 - D. **Acrylonitrile Butadiene Styrene (ABS) Pipe** – Nom 4 in. (102 mm) diam (or smaller). Schedule 40 solid core or cellular core ABS pipe for use in closed (process or supply) or vented (drain, waste or vent) piping systems.
 - E. **Fire Retardant Polypropylene (FRPP) Pipe** – Nom 4 in. (102 mm) diam (or smaller). Schedule 40 FRPP pipe for use in closed (process or supply) or vented (drain, waste or vent) piping systems.
 - F. **Polyvinylidene Fluoride (PVDF) Pipe** – Nom. 4 in. (102 mm) diam (or smaller) Schedule 40 PVDF pipe for use in closed (process or supply) or vented (drain, waste or vent) piping systems.
3. **Firestop Device - Collar** – Collar to be installed in accordance with the accompanying installation instructions. Collar to be installed and latched around pipe and secured to both sides of wall with 3M Ultra Fast Anchor Straps. Min of two, three or four anchor straps symmetrically located, for nom 2 in. diam (and smaller), nom 3 in. diam and nom 4 in. (51 mm, 76 mm and 102 mm) diam pipes, respectively.

3M COMPANY – Ultra PPD 1.5, 2.0, 3.0 and 4.0
4. **Fill, Void or Cavity Materials* – Caulk or Sealant** (Optional, not shown) – As an option, caulk may be applied within annulus between the pipe and the periphery of the opening prior to the installation of the collar (Item 3). An additional bead of caulk may be applied at the collar/gypsum board interface on both sides of wall.

3M COMPANY – IC 15WB+, CP 25WB+ caulk or FB-3000 WT sealant
(Note: CP 25WB+ not suitable for use with CPVC pipes.)

*Bearing the UL Classification Mark

++Bearing the UL Listing Mark

Reprinted from the Online Certifications Directory with permission from Underwriters Laboratories Inc.

Copyright © 2011 Underwriters Laboratories Inc.®

System No. W-L-2299

May 19, 2005

F Ratings – 1 & 2 Hr (See Item 1)

T Rating – 0 Hr

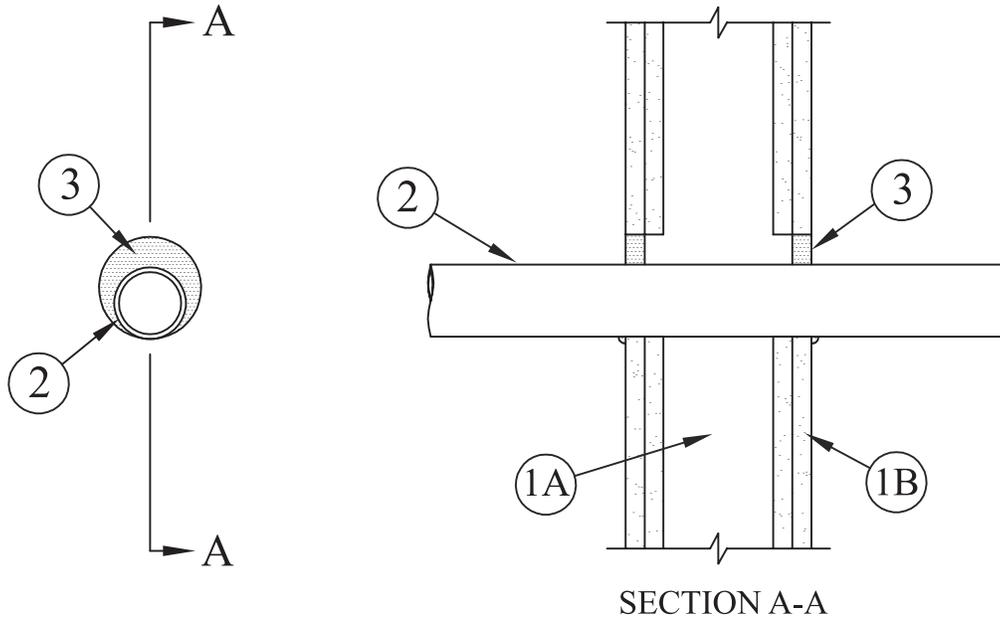

- Wall Assembly** – The 1 or 2 hr fire rated gypsum board/stud wall assembly shall be constructed of the materials and in the manner described in the individual U300, U400 or V400 Series Wall or Partition Design in the UL Fire Resistance Directory and shall include the following construction features:

- Studs** – Wall framing may consist of either wood studs or steel channel studs. Wood studs to consist of nom 2 in. by 4 in. (51 mm by 102 mm) lumber spaced 16 in. (406 mm) OC. Steel studs to be min 3-1/2 in. wide (89 mm) spaced max 24 in. (610 mm) OC.
- Gypsum Board*** – The gypsum board type, thickness, number of layers, fastener type and sheet orientation shall be as specified in the individual U300 or U400 Series Design in the UL Fire Resistance Directory. Max diam of opening is 3-1/2 in. (89 mm).

The hourly F Rating of the firestop system is equal to the hourly fire rating of the wall assembly in which it is installed.

- Through Penetrants** – One nonmetallic pipe or conduit installed eccentrically or concentrically within opening. Annular space between penetrant and periphery of opening to be min 0 in. (point contact) to max 1-1/8 in. (0 mm to max 29 mm). Penetrant to be rigidly supported on both sides of wall. The following types and sizes of penetrants may be used:
 - Polyvinyl Chloride (PVC) Pipe** – Nom 2 in. (51 mm) diam (or smaller) Schedule 40 solid core or cellular core PVC pipe for use in closed (process or supply) or vented (drain, waste or vent) piping system.
 - Chlorinated Polyvinyl Chloride (CPVC) Pipe** – Nom 2 in. (51 mm) diam (or smaller) SDR13.5 CPVC pipe for use in closed (process or supply) piping systems.
 - Rigid Nonmetallic Conduit+** – Nom 2 in. (51 mm) diam (or smaller) Schedule 40 PVC conduit installed in accordance with Article 347 of the National Electrical Code (NFPA No. 70).
 - Acrylonitrile Butadiene Styrene (ABS) Pipe** – Nom 1-1/2 in. (38 mm) diam (or smaller) Schedule 40 solid core or cellular core ABS pipe for use in closed (process or supply) or vented (drain, waste or vent) piping systems.
 - Electrical Nonmetallic Tubing (ENT)+** – Nom 1-1/4 in (32 mm) diam (or smaller) ENT installed in accordance with Article 331 of the National Electrical Code (NFPA No. 70).

See **Electrical Nonmetallic Tubing (FKHU)** category in the Electrical Construction Materials Directory for names of manufacturers.

- Fill, Void or Cavity Material* – Caulk or Sealant** – Min 5/8 in. (16 mm) thickness of caulk applied within annulus, flush with both surfaces of wall. Min 1/4 in. (6 mm) diam bead of caulk applied to gypsum board/penetrant interface at point contact location on both sides of wall.

3M COMPANY – IC 15WB+, CP 25WB+ caulk or FB-3000 WT sealant
(Note: CP 25WB+ not suitable for use with CPVC pipes.)

*Bearing the UL Classification Marking

+Bearing the UL Listing Mark

Reprinted from the Online Certifications Directory with permission from Underwriters Laboratories Inc.

Copyright © 2011 Underwriters Laboratories Inc.®

System No. W-L-2300

May 19, 2005

F Ratings – 1 & 2 Hr (See Item 1)

T Ratings – 0 & 1/2 Hr (See Item 1)

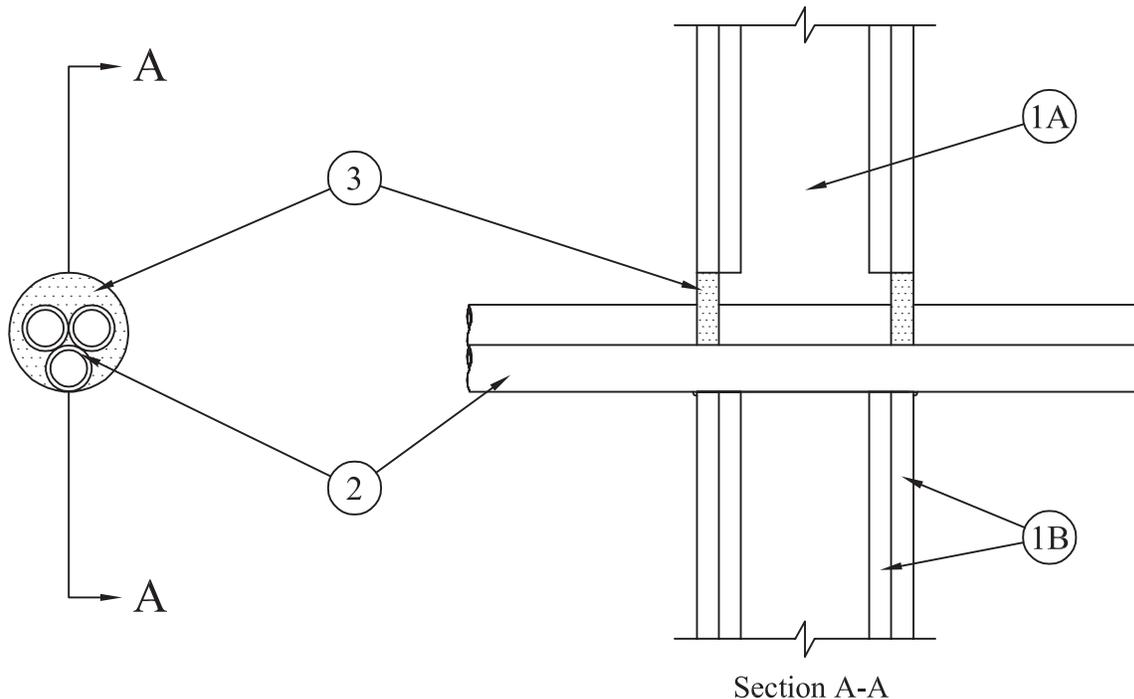

- Wall Assembly** – The 1 or 2 hr fire rated gypsum board/stud wall assembly shall be constructed of the materials and in the manner described in the individual U300, U400 or V400 Series Wall or Partition Design in the UL Fire Resistance Directory and shall include the following construction features:
 - Studs** – Wall framing may consist of either wood studs or steel channel studs. Wood studs to consist of nom 2 in. by 4 in. (51 mm by 102 mm) lumber spaced 16 in. (406 mm) OC. Steel studs to be min 3-1/2 in. (89 mm) wide spaced max 24 in. (610 mm) OC.
 - Gypsum Board*** – The gypsum board type, thickness, number of layers, fastener type and sheet orientation shall be as specified in the individual U300 or U400 Series Design in the UL Fire Resistance Directory. Max diam of opening is 4 in. (102 mm).

The hourly F Rating of the firestop system is equal to the hourly fire rating of the wall assembly in which it is installed. The hourly T Rating is 0 and 1/2 Hr for 1 and 2 Hr rated assemblies, respectively.
- Through Penetrants** – One or more nonmetallic pipes, conduits or tubes installed concentrically or eccentrically within opening. Annular space between penetrants and periphery of opening to be min 0 in. (point contact) to max 1 in. (0 mm to max 25 mm). Space between penetrants shall be min 0 in. (point contact) to max 1 in. (0 mm to max 25 mm). Penetrants to be rigidly supported on both sides of wall. The following types and sizes of penetrants may be used:
 - Polyvinyl Chloride (PVC) Pipe** – Nom 1-1/2 in. (38 mm) diam (or smaller) Schedule 40 solid or cellular core PVC pipe for use in closed (process or supply) or vented (drain, waste or vent) piping systems.
 - Rigid Nonmetallic Conduit++** – Nom 1-1/2 in. (38 mm) diam (or smaller) Schedule 40 PVC conduit installed in accordance with Article 347 of the National Electrical Code (NFPA No. 70).
 - Chlorinated Polyvinyl Chloride (CPVC) Pipe** – Nom 1-1/2 in. (38 mm) diam (or smaller) SDR13.5 CPVC pipe for use in closed (process or supply) piping systems.
 - Crosslinked Polyethylene (PEX) Tubing** – Nom 1 in. (25 mm) diam (or smaller) SDR 9 PEX tubing for use in closed (process or supply) or vented (drain, waste or vent) piping systems.
- Fill, Void or Cavity Material* – Caulk or Sealant** – Min 5/8 in. (16 mm) thickness of caulk applied within annulus, flush with both surfaces of wall. Min 1/4 in. (6 mm) diam bead of caulk applied to gypsum board/penetrant interface at point contact location on both sides of wall.

3M COMPANY – IC 15WB+, CP 25WB+ caulk or FB-3000 WT sealant
(Note: CP 25WB+ not suitable for use with CPVC pipes.)

*Bearing the UL Classification Marking

Reprinted from the Online Certifications Directory with permission from Underwriters Laboratories Inc.
Copyright © 2011 Underwriters Laboratories Inc.®

Through Penetrations

Non-Metallic Pipes

2000 Series

Gypsum

WL

System No. W-L-2355

May 19, 2005

F Rating – 1 Hr

T Rating – 1 Hr

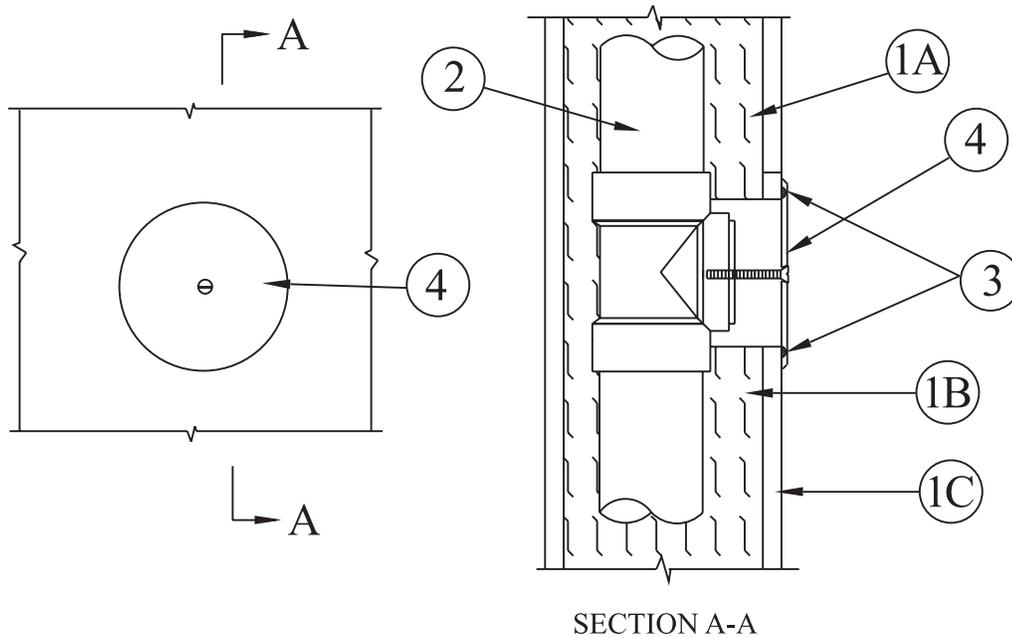

- Wall Assembly** – The fire-rated gypsum board/stud wall assembly shall be constructed of the materials and in the manner specified in the individual U300 Series Wall and Partition Designs in the UL Fire Resistance Directory and shall include the following construction features:
 - Studs** – Wall framing to consist of nom 2 in. by 6 in. (51 mm by 152 mm) (or larger) wood studs or doubled or staggered non 2 in. by 4 in. (51 mm by 102 mm) (or larger) wood studs spaced in accordance with the individual U300 Series Wall and Partition Designs.
 - Insulation*** – R13 (or higher) glass fiber or mineral fiber batt insulation friction fitted into stud cavity.
 - Gypsum Board*** – One layer of nom 5/8 in. (16 mm) thick gypsum board, as specified in the individual Wall and Partition Design. Max diam of opening is 5 in. (127 mm).
- Piping System** – One Nom 3 in. (76 mm) diam (or smaller) Schedule 40 solid core or cellular core PVC pipe with PVC tee clean-out for use in closed (process or supply) or vented (drain, waste or vent) piping systems, installed within stud cavity. PVC clean-out to be located behind opening in gypsum board.
- Fill, Void or Cavity Material* – Caulk, Sealant or Putty** – Min 1/2 in. (13 mm) diam of fill material applied completely around perimeter of opening.
3M COMPANY – IC 15WB+, CP 25WB+ caulk, FB-3000 WT sealant or MPP+ putty
- Cover Plate** – Min 6-1/2 in. (165 mm) diam 24 gauge (or heavier) stainless steel cover plate secured to PVC clean-out with stainless steel screw through center of plate. Cover plate to be tightened squarely to wall and shall overlap surface of gypsum board a min 3/4 in. (19 mm) around entire perimeter of opening.

*Bearing the UL Classification Marking

Reprinted from the Online Certifications Directory with permission from Underwriters Laboratories Inc.
 Copyright © 2010 Underwriters Laboratories Inc.®

System No. W-L-2356

May 19, 2005
F Rating – 2 Hr
T Rating – 0 Hr

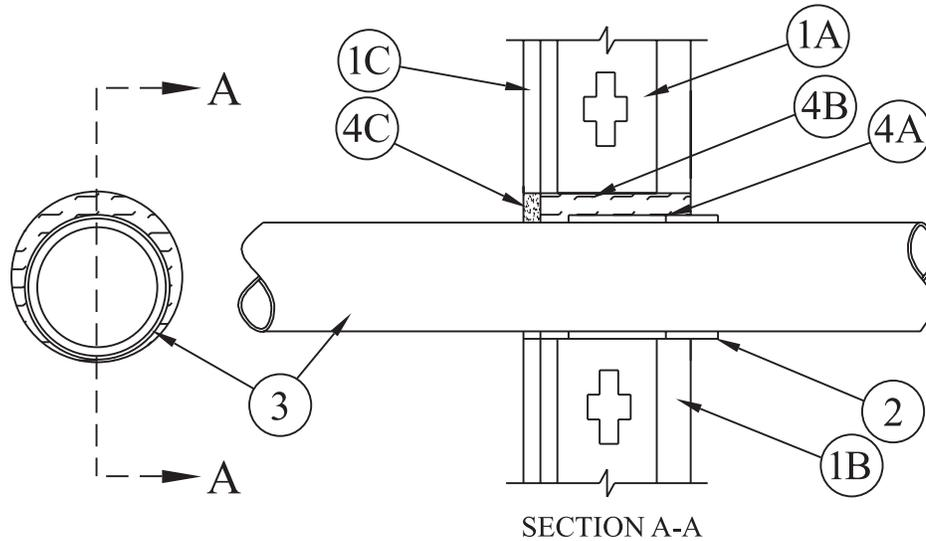

- Wall Assembly** – The 2 hr fire-rated shaft wall assembly shall be constructed of the materials and in the manner specified in the individual U400 or V400 Series Wall and Partition Designs in the UL Fire Resistance Directory and shall include the following construction features:
 - Steel Studs** – C-H-shaped studs, 2-1/2 in. wide by 1-1/2 in. (64 mm wide by 38 mm) deep, spaced 24 in. (610 mm) OC.
 - Gypsum Board*** – 1 in. (25 mm) thick gypsum board liner panels, supplied in nom 24 in. (610 mm) widths as specified in the individual Wall and Partition Design. Max diam of opening is 3 in. (76 mm).
 - Gypsum Board*** – Two layers of 5/8 in. (16 mm) thick gypsum board as specified in the individual Wall and Partition Design. Max diam of opening is 3 in. (76 mm).
- Steel Sleeve** – Cylindrical sleeve fabricated from min 0.019 in. (0.49 mm) thick (28 gauge) galv sheet steel and having a min 2 in. (51 mm) lap along the longitudinal seam. Length of steel sleeve to be equal to thickness of wall or up to 2 in. (51 mm) longer than the thickness of wall such that, when installed, the ends of the sleeve will be flush with wall surface or project up to 1 in. (25 mm) beyond the surface of the wall on each side of the wall assembly. Sleeve installed by coiling the sheet steel to a diam smaller than the max 3 in. (76 mm) diam through opening, inserting the coil through the opening and releasing the coil to let it uncoil against the circular cutouts in the gypsum board layers.
- Through Penetrants** – One nonmetallic pipe or conduit concentrically or eccentrically within the firestop system. The annular space between penetrant and sleeve shall be min 1/8 in. to max 1/2 in. (3.2 mm to 13 mm). Penetrant to be rigidly supported on both sides of wall assembly. The following types and sizes of nonmetallic pipes or conduits:
 - Polyvinyl Chloride (PVC) Pipe** – Nom 2 in. (51 mm) diam (or smaller) Schedule 40 solid core or cellular core PVC pipe for use in closed (process or supply) or vented (drain, waste or vent) piping system.
 - Rigid Nonmetallic Conduit++** – Nom 2 in. (51 mm) diam (or smaller) Schedule 40 PVC conduit installed in accordance with Article 347 of the National Electrical Code (NFPA No. 70).
 - Chlorinated Polyvinyl Chloride (CPVC) Pipe** – Nom 2 in. (51 mm) diam (or smaller) SDR13.5 CPVC pipe for use in closed (process or supply) piping systems.
 - Acrylonitrile Butadiene Styrene (ABS) Pipe** – Nom 2 in. (51 mm) diam (or smaller) Schedule 40 solid core or cellular core ABS pipe for use in closed (process or supply) or vented (drain, waste or vent) piping systems.
- Firestop System** – The firestop system shall consist of the following:
 - Fill, Void or Cavity Materials* – Wrap Strip** – Nom 1/8 in. (3.2 mm) thick intumescent material supplied in 2 in. (51 mm) wide strips. Min one layer of wrap strip tightly wrapped around nonmetallic pipe and held in position using foil tape. Wrap strip to be recessed from finished surface of wall (Item 1C) approx 1-3/4 in. (44 mm) such that the leading edge of wrap strip is flush with inner surface of gypsum board liner panel (Item 1B).
3M COMPANY – Ultra GS
 - Packing Material** – Min 3 in. (76 mm) thickness of min 4 pcf (64 kg/m³) mineral wool batt insulation firmly packed into opening as a permanent form. Packing material to be recessed from finished surface of wall to accommodate the required thickness of fill material.
 - Fill, Void or Cavity Materials* – Caulk or Sealant** – Min 3/4 in. (19 mm) thickness of caulk applied within annulus, flush with finished surface of wall assembly.
3M COMPANY – IC 15WB+, CP 25WB+ caulk or FB-3000 WT sealant
(Note: CP 25WB+ not suitable for use with CPVC pipes.)

*Bearing the UL Classification Marking

Reprinted from the Online Certifications Directory with permission from Underwriters Laboratories Inc.
Copyright © 2011 Underwriters Laboratories Inc.®

System No. W-L-2385

May 19, 2005

F Ratings – 1 and 2 Hr (See Item 1)

T Ratings – 0 and 2 Hr (See Item 1)

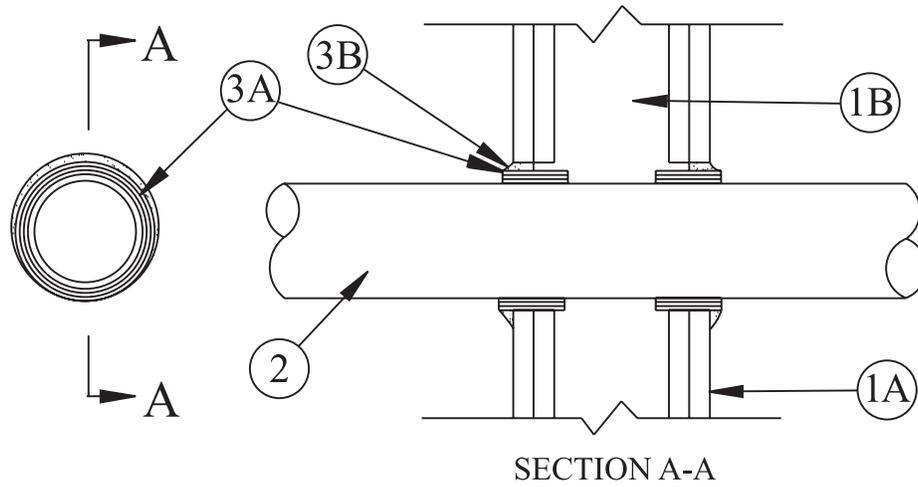

1. **Wall Assembly** – The 1 or 2 hr fire rated gypsum board/stud wall assembly shall be constructed of the materials and in the manner described in the individual U300, U400 or V400 Series Wall or Partition Design in the UL Fire Resistance Directory and shall include the following construction features:
 - A. **Studs**-Wall framing may consist of either wood studs or steel channel studs. Wood studs to consist of nom 2 in. by 4 in. (51 mm by 102 mm) lumber spaced 16 in. (406 mm) OC. Steel studs to be min 3-1/2 in. (89 mm) wide spaced max 24 in. (610 mm) OC.
 - B. **Gypsum Board*** – The gypsum board type, thickness, number of layers, fastener type and sheet orientation shall be as specified in the individual U300 or U400 Series Design in the UL Fire Resistance Directory. Max diam of opening is 4-1/2 in. (114 mm).

The hourly F Rating of the firestop system is equal to the hourly fire rating of the wall assembly in which it is installed. The hourly T Rating is 0 and 2 hr for one and 2 hr rated assemblies, respectively.
2. **Through Penetrants** – One nonmetallic pipe or conduit concentrically or eccentrically within the firestop system. The annular space between penetrant and sleeve shall be min 3/8 in. (10 mm) to max 5/8 in. (16 mm). Penetrant to be rigidly supported on both sides of wall assembly. The following types and sizes of nonmetallic pipes or conduits:
 - A. **Polyvinyl Chloride (PVC) Pipe** – Nom 3 in. (76 mm) diam (or smaller) Schedule 40 solid core or cellular core PVC pipe for use in closed (process or supply) or vented (drain, waste or vent) piping systems.
 - B. **Rigid Nonmetallic Conduit++** - Nom 3 in. (76 mm) diam (or smaller) Schedule 40 PVC conduit installed in accordance with Article 347 of the National Electrical Code (NFPA No. 70).
 - C. **Chlorinated Polyvinyl Chloride (CPVC) Pipe** – Nom 3 in. (76 mm) diam (or smaller) SDR13.5 CPVC pipe for use in closed (process or supply) piping systems.
 - D. **Acrylonitrile Butadiene Styrene (ABS) Pipe** – Nom 3 in. (76 mm) diam (or smaller) Schedule 40 solid core or cellular core ABS pipe for use in closed (process or supply) or vented (drain, waste or vent) piping systems.
3. **Firestop System** - The firestop system shall consist of the following:
 - A. **Fill, Void or Cavity Materials* – Wrap Strip** – Nom 1/8 in. (3.2 mm) thick intumescent material supplied in 2 in. (51 mm) wide strips. Min three layers of wrap strip tightly wrapped around nonmetallic pipe and completely wrapped with min 3 mil foil tape. Wrap strip to be slid into opening such that the outer edge of wrap strip extends approx 1/2 in. from both surfaces of wall.
3M COMPANY – Ultra GS
 - B. **Fill, Void or Cavity Material* – Caulk or Sealant** – Min 5/8 in. (16 mm) thickness of caulk applied within annulus, flush with both surfaces of wall. Min 1/2 in. (13 mm) diam bead of caulk applied to gypsum board/wrap strip interface at point contact location on both sides of wall.
3M COMPANY – IC 15WB+, CP 25WB+ caulk or FB-3000 WT sealant.
 (Note: CP 25WB+ not suitable for use with CPVC pipes.)

*Bearing the UL Classification Marking

Reprinted from the Online Certifications Directory with permission from Underwriters Laboratories Inc.
 Copyright © 2011 Underwriters Laboratories Inc.®

System No. W-L-2397

May 20, 2005

F Ratings – 1 and 2 Hr (See Item 1)

T Ratings – 1 and 2 Hr (See Item 1)

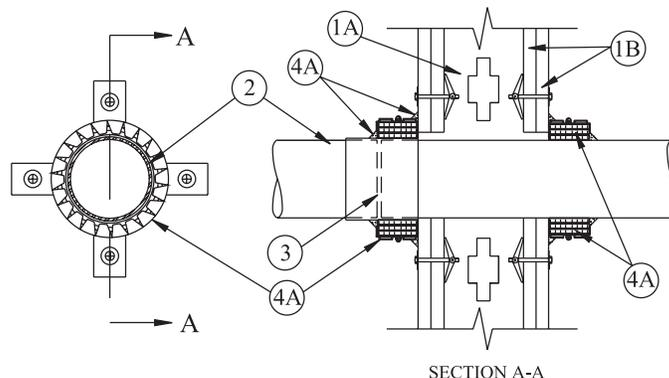

1. **Wall Assembly** – The 1 or 2 hr fire rated gypsum board/stud wall assembly shall be constructed of the materials and in the manner specified in the individual U300, U400 or V400 Series Wall and Partition Designs in the UL Fire Resistance Directory and shall include the following construction features:

- A. **Studs** – Wall framing may consist of either wood studs or steel channel studs. Wood studs to consist of nom 2 by 4 in. (51 by 102 mm) (or larger) lumber spaced 16 in. (406 mm) OC. Steel studs to be min 3-1/2 in. (89 mm) wide and spaced max 24 in. (610 mm) OC.
- B. **Gypsum Board*** – Thickness, type, number of layers and fasteners as required in the individual Wall and Partition Design. Max diam of opening is 5 in. (127 mm).

The hourly F and T Ratings of the firestop system are equal to the hourly fire rating of the wall assembly in which it is installed.

2. **Through Penetrants** – One nonmetallic pipe or conduit to be installed concentrically or eccentrically within opening. Annular space between penetrant and periphery of opening to be min 0 in. (point contact) to max 1/2 in. (13 mm). Pipe or conduit to be rigidly supported on both sides of the wall assembly. The following types and sizes of nonmetallic pipes or conduits may be used:

- A. **Polyvinyl Chloride (PVC) Pipe** – Nom 4 in. (102 mm) diam (or smaller) Schedule 40 solid core or cellular core PVC pipe for use in closed (process or supply) or vented (drain, waste or vent) piping system.
- B. **Rigid Nonmetallic Conduit++** – Nom 4 in. (102 mm) diam (or smaller) Schedule 40 PVC conduit installed in accordance with Article 347 of the National Electrical Code (NFPA No. 70).
- C. **Chlorinated Polyvinyl Chloride (CPVC) Pipe** – Nom 4 in. (102 mm) diam (or smaller) SDR13.5 CPVC pipe for use in closed (process or supply).
- D. **Acrylonitrile Butadiene Styrene (ABS) Pipe** – Nom 4 in. (102 mm) diam (or smaller) Schedule 40 solid core or cellular core ABS pipe for use in closed (process or supply) or vented (drain, waste or vent) piping systems.
- E. **Fire Retardant Polypropylene (FRPP) Pipe** – Nom 4 in. (102 mm) diam (or smaller) Schedule 40 FRPP pipe for use in closed (process or supply) or vented (drain, waste or vent) piping system.

3. **Nonmetallic Pipe Coupling** – Pipe coupling to be of the same size and type of pipe or conduit and installed such that one end of the coupling is flush with either side of the wall assembly and extending outward.

4. **Firestop System** – The details of the firestop system shall be as follows:

- A. **Fill, Void or Cavity Materials* – Wrap Strip** – Nom 1/8 in. (3.2 mm) thick intumescent material supplied in 2 in. (51 mm) wide strips. Wrap strip tightly wrapped around nonmetallic pipe with continuous layers and butted tightly against both surfaces of the wall. The min number of layers required is dependent upon the nom diam of the pipe. For nom 2 in. (51 mm) diam (and smaller) pipes, one layer is required. For nom 2-1/2 in. and 3 in. (64 and 76 mm) diam pipes, two layers are required. For nom 3-1/2 in. and 4 in. (89 and 102 mm) diam pipes, three layers are required. The min number of layers required shall be increased by one layer for the wrap strip installed over the pipe coupling (Item 3). Wrap strip layers temporarily held in position using aluminum foil tape, steel wire tie, or equivalent.

3M COMPANY – Ultra GS

- B. **Steel Collar** – Nom 2 in. (51 mm) deep collar with 1-1/4 in. (32 mm) wide by 2 in. (51 mm) long anchor tabs and min 1/2 in. (13 mm) long tabs to retain wrap strip layers. Coils of precut 0.016 in. (0.41 mm) thick (28 gauge) galv sheet steel available from wrap strip manufacturer. As an alternate, collar may be field-fabricated from min 0.016 in. (0.41 mm) thick (28 gauge) galv sheet steel in accordance with instruction sheet supplied by wrap strip manufacturer. Steel collar, with anchor tabs bent outward 90 deg, wrapped tightly around wrap strip layers with min 1 in. (25 mm) overlap at seam. Anchor tabs to be pressed tightly against wall surfaces, and collar to be compressed around wrap strip layers using a min 1/2 in. (13 mm) wide by 0.028 in. (0.71 mm) thick stainless steel band clamp at the middle of collar. Collar to be secured to wall surfaces with min 3/16 in. (5 mm) diam steel toggle bolts, or equivalent, in conjunction with min 1-1/4 in. (32 mm) diam steel washers. Min of two, three or four anchor bolts, symmetrically located, for nom 2 in. (51 mm) diam (and smaller), nom 3 in. (76 mm) diam (and smaller) and nom 4 in. (102 mm) diam (and smaller), pipes, respectively.

- C. **Fill, Void or Cavity Materials* – Caulk, Sealant or Putty** – Min 1/2 in. (13 mm) diam bead of caulk or putty shall be applied to outer perimeter of collar at the collar/gypsum board interface on both sides of wall.

3M COMPANY – CP 25WB+ caulk, FB-3000 WT sealant or MP+ putty.

(Note: CP 25WB+ not suitable for use with CPVC pipes.)

++Bearing the UL Listing Mark

*Bearing the UL Classification Mark

Reprinted from the Online Certifications Directory with permission from Underwriters Laboratories Inc.

Copyright © 2011 Underwriters Laboratories Inc.®

System No. W-L-2448

June 23, 2015

F Ratings — 1 and 2 Hr (See Item 1)

T Rating — 0 Hr

L Rating At Ambient — 4 CFM/sq ft. (See Item 3B)

L Rating At 400 F — Less Than 1 CFM/sq ft. (See Item 3B)

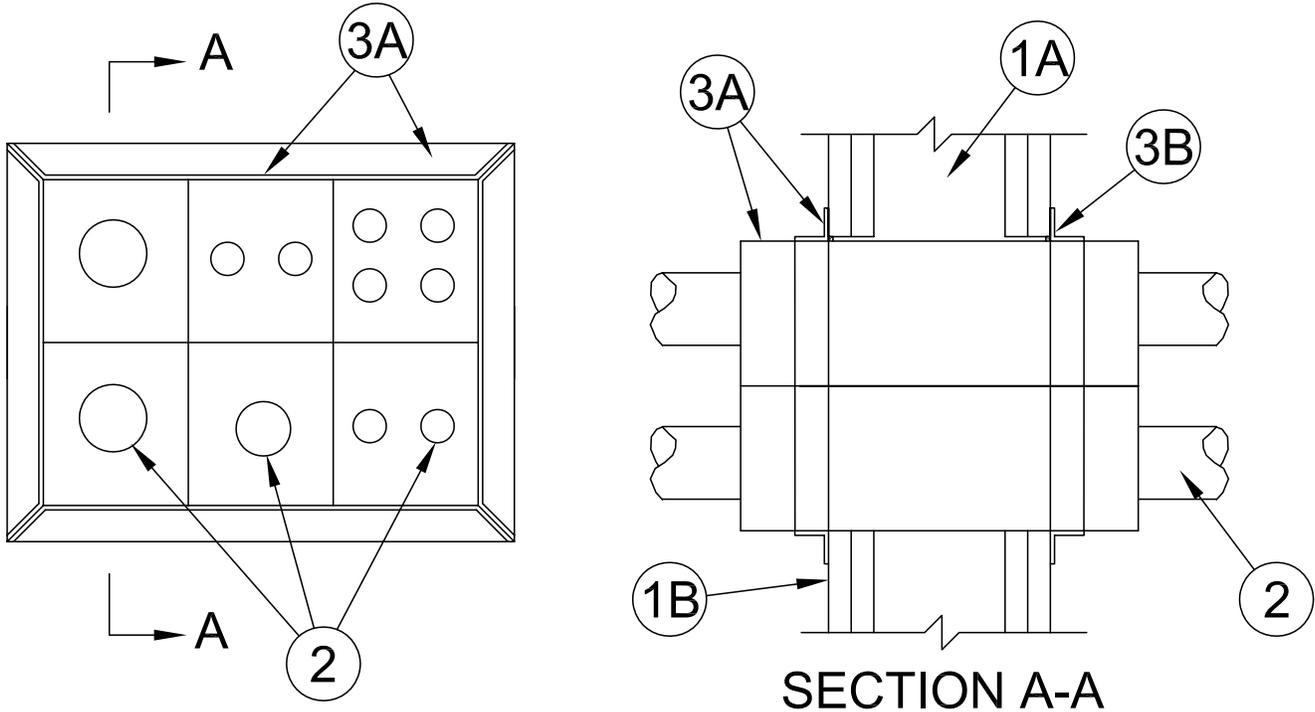

1. **Wall Assembly** — The 1 or 2 hr fire rated gypsum board/stud wall assembly shall be constructed of the materials and in the manner described in the individual U300, U400 or V400 Series Wall and Partition Design in the UL Fire Resistance Directory and shall include the following construction features:

- A. **Studs** — Wall framing may consist of either wood or steel channel studs. Wood studs to consist of nom 2 by 4 in. (51 by 102 mm) lumber spaced 16 in. (406 mm) OC. Steel studs to be min 3-1/2 in. (89 mm) wide spaced max 24 in. (610 mm) OC.
- B. **Gypsum Board*** — The gypsum board type, thickness, number of layers, fastener type and sheet orientation shall be as specified in the individual Wall and Partition Design in the UL Fire Resistance Directory. Max area of opening is 98.5 in.2 (635 cm2) with a max dimension of 12-1/8 in. (308 mm) for square devices. Max diam of opening is 2-1/4 in. (57 mm) for nom 2 in. (51 mm) round devices and 4-1/4 in. (108 mm) for 4 in. (102 mm) round devices.

The hourly F Rating of the firestop system is equal to the hourly fire rating of the wall assembly in which it is installed.

2. **Through Penetrants** — One or more nonmetallic pipes, conduits or tubes, as described in a single line item below, may be installed concentrically or eccentrically within each firestop device (Item 3A) without any limitations on annular space. If multiple through penetrations are installed within the firestop device, the through penetrants may be bundled together. Through penetrants to be rigidly supported on both sides of wall assembly. The following types and sizes of through penetrants may be used:
- A. **Polyvinyl Chloride (PVC) Pipe** — One nom 2 in. (51 mm) diam (or smaller) Schedule 40 solid core PVC pipe for use in closed (process or supply) or vented (drain, waste or vent) piping systems.
- B. **Rigid Nonmetallic Conduit+** — One nom 2 in. (51 mm) diam (or smaller) Schedule 40 PVC conduit installed in accordance with the National Electrical Code (NFPA No. 70).
See **Rigid Nonmetallic, Schedule 40 and 80 PVC Conduit (DZYR)** category in the Electrical Construction Equipment Directory for names of manufacturers.
- C. **Chlorinated Polyvinyl Chloride (CPVC) Pipe** — One nom 2 in. (51 mm) diam (or smaller) SDR11 CPVC pipe for use in closed (process or supply) piping systems.
- D. **Crosslinked Polyethylene (PEX) Tubing** — One nom 2 in. (51 mm) diam (or smaller) SDR 9 PEX tubing for use in closed (process or supply) piping systems.
- E. **Electrical Nonmetallic Tubing (ENT)+** — Max four nom 1-1/4 in. (32 mm) diam (or smaller) ENT installed in accordance with the National Electrical Code (NFPA No. 70).
See **Electrical Nonmetallic Tubing (FKHU)** category in the Electrical Construction Equipment Directory for names of manufacturers.
- F. **Optical Fiber/Communications/Signaling/Coaxial Cable Raceways+** — Max four nom 1-1/4 in. (32 mm) diam (or smaller) plenum rated raceways installed in accordance with the National Electrical Code (NFPA No. 70).
See **Optical Fiber/Communications/Signaling/Coaxial Cable Raceway (QAZM)** category in the Electrical Construction Equipment Directory for names of manufacturers.
- G. **Acrylonitrile Butadiene Styrene (ABS) Pipe** — Nom 2 in. (51 mm) diam (or smaller) Schedule 40 solid or cellular core ABS for use in closed (process or supply) or vented (drain, waste or vent) piping systems

System No. W-L-2448 *continued*

3. **Firestop System** — The firestop system shall consist of the following:

A. **Firestop Device*** — A max of six square firestop devices may be ganged together. As an alternate, one round device may be centered within a round opening. Each device consists of a nom 2-1/2 by 2-1/2 by 10 in. (64 by 64 by 254 mm), a nom 4 by 4 by 10 in. (102 by 102 by 254 mm), a nom 2 in. (51 mm) diam by 10 in. (254 mm) or a nom 4 in. (102 mm) diam by 10 in. (254 mm) powder coated steel transit incorporating internal intumescent material, foam plugs and mounting flanges. Firestop device(s) to be installed within opening with ends projecting an equal distance beyond each surface of wall assembly in accordance with the accompanying installation instructions. The annular space between device(s) and periphery of opening shall be min 0 in. (0 mm, point contact) to max 1/8 in. (3 mm). Firestop device(s) secured in place by means of fill material (Item 3B) and steel split mounting flanges sized to accommodate the firestop device. Steel split mounting flanges installed on both sides of wall after installation of fill material, and secured together with supplied steel set screws. Nom 1 in. (25 mm) thick pre-cut foam plugs sized to accommodate the through penetrant(s) and installed flush with each end of device on both sides of wall assembly. The foam plug in one or both ends of the device is optional except when L Rating is required (See Item 3B).

3M COMPANY — 3M Fire Barrier Pass-Through Device

B. **Fill, Void or Cavity Materials* - Putty or Caulk** — Min 1/8 in. (3 mm) bead of fill material shall be applied at interface of gypsum board and firestop devices immediately prior to the installation of the mounting flanges. As an option, foam plugs may be recessed into device and the recess filled with fill material flush with the ends of the device. If three or less devices (Item 3A) are ganged together, the fill material may be optional. L Rating applies only when fill material is applied at interface of gypsum board and device(s) prior to mounting flanges and with both ends of firestop device(s) filled with nominal 1/8 in. (3.2 mm) of Moldable Putty+.

3M COMPANY — Moldable Putty+, CP 25WB+, IC 15WB+, 3000 WT. CP 25WB+ not suitable for use with CPVC pipes.

+ Bearing the UL Listing Mark

* Indicates such products shall bear the UL or cUL Certification Mark for jurisdictions employing the UL or cUL Certification (such as Canada), respectively.

Through Penetrations

Non-Metallic Pipes

2000 Series

Gypsum

WL

System No. W-L-2483

February 07, 2007
 F Ratings – 1 and 2 Hr (See Item 1)
 T Rating – 0 Hr

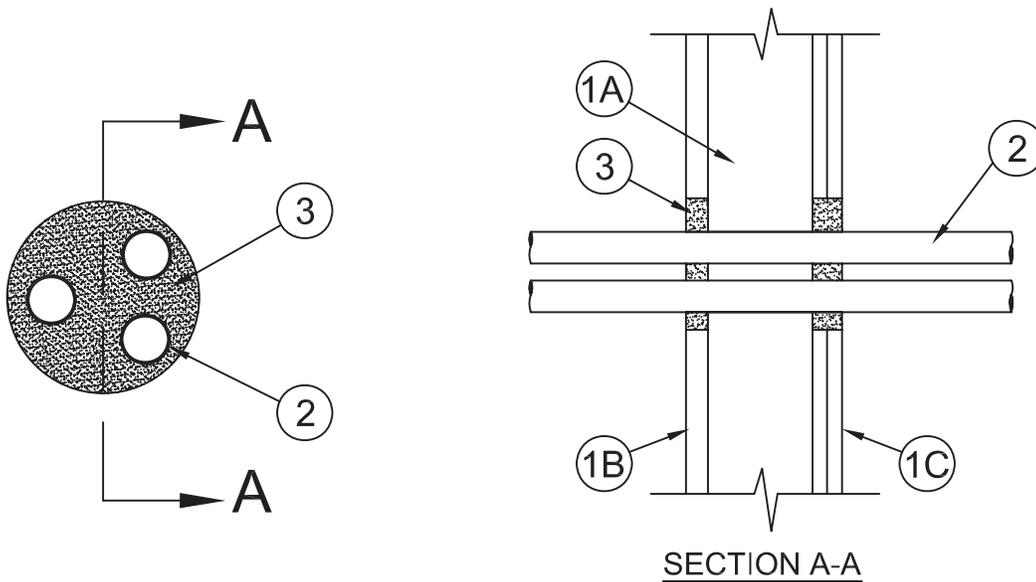

- Wall Assembly** – The 1 or 2 hr fire-rated gypsum board/stud shaft wall assembly shall be constructed of the materials and in the manner specified in the individual U400 or V400 Series Wall and Partition Designs in the UL Fire Resistance Directory and shall incorporate the following construction features:
 - Steel Studs** – “C-H” or “C-T” shaped studs, min 2-1/2 in. (64 mm) wide by 1-1/2 in. (38 mm) deep, fabricated from min No. 25 gauge (0.6 mm thick) galv steel, spaced max 24 in. (610 mm) OC.
 - Gypsum Board*** – 1 in. (25 mm) thick, 24 in. (610 mm) wide gypsum liner panels installed vertically. Max diam of circular cutout in gypsum liner panel is 4-1/2 in. (114 mm).
 - Gypsum Board*** – 1/2 in. or 5/8 in. (13 or 16 mm) thick, 48 in. (1.2 m) wide gypsum boards. The gypsum board type, thickness, number of layers, fastener type and sheet orientation shall be as specified in the individual Wall and Partition Design. Max diam of circular cutout in gypsum board is 4-1/2 in. (114 mm).

The hourly F Rating of the firestop system is equal to the hourly fire rating of the wall assembly in which it is installed.
- Through Penetrants** – One or more nonmetallic pipes, conduits or tubes installed concentrically or eccentrically within opening. Annular space between penetrants and periphery of opening to be min 1/4 in. (6 mm) to max 1 in. (25 mm). Space between penetrants shall be min 1/4 in. (6 mm) to max 1 in. (25 mm). Penetrants to be rigidly supported on both sides of wall. The following types and sizes of penetrants may be used:
 - Polyvinyl Chloride (PVC) Pipe** – Nom 1 in. (25 mm) diam (or smaller) Schedule 40 solid or cellular core PVC pipe for use in closed (process or supply) or vented (drain, waste or vent) piping systems.
 - Rigid Nonmetallic Conduit++** – Nom 1 in. (25 mm) diam (or smaller) Schedule 40 PVC conduit installed in accordance with the National Electrical Code (NFPA No. 70).
 - Chlorinated Polyvinyl Chloride (CPVC) Pipe** – Nom 1 in. (25 mm) diam (or smaller) SDR13.5 CPVC pipe for use in closed (process or supply) piping systems.
 - Crosslinked Polyethylene (PEX) Tubing** – Nom 1 in. (25 mm) diam (or smaller) SDR 9 PEX tubing for use in closed (process or supply) piping systems.
- Fill, Void or Cavity Materials* – Caulk or Sealant** – Caulk or sealant applied within annulus at a thickness equal to the total thickness of the gypsum board on both sides of the wall.

3M COMPANY – CP 25WB+ caulk or FB-3000 WT sealant (**Note:** CP 25WB+ Caulk not suitable for use with CPVC pipes)

*Bearing the UL Classification Mark

Reprinted from the Online Certifications Directory with permission from Underwriters Laboratories Inc.
 Copyright © 2010 Underwriters Laboratories Inc.®

System No. W-L-2543

March 27, 2009

F Rating – 1 and 2 Hr (See Item 1)

T Ratings – 0, 1-1/2 and 2 Hr (See Item 2)

L Rating at Ambient – Less Than 1 CFM/sq ft

L Rating at 400 F – 5 CFM/sq ft

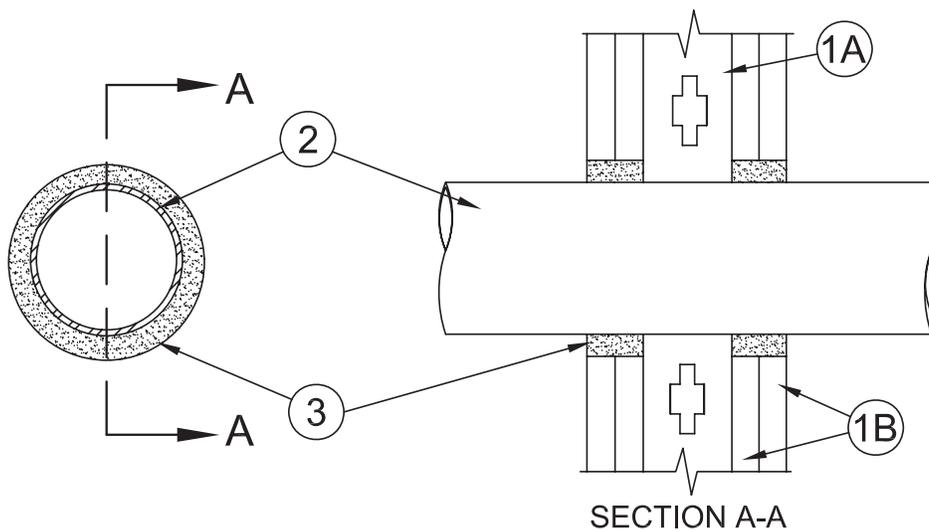

1. **Wall Assembly** – The 1 or 2 Hr fire rated gypsum board/stud wall assembly shall be constructed of the materials and in the manner specified in the individual U300, U400 or V400 Series Wall and Partition Designs in the UL Fire Resistance Directory and shall include the following construction features:

- A. **Studs** – Wall framing may consist of either wood studs or steel channel studs. Wood studs to consist of nom 2 by 4 in. (51 by 102 mm) lumber spaced 16 in. (406 mm) OC. Steel studs to be min 2-1/2 in. (64 mm) wide and spaced max 24 in. (610 mm) OC.
- B. **Wallboard, Gypsum*** – Thickness, type, number of layers and fasteners as required in the individual Wall and Partition Design. Max diam of opening is 3 in. (76 mm).

The hourly F Rating of the firestop system is equal to the hourly fire rating of the wall assembly in which it is installed.

2. **Through-Penetrants** – One nonmetallic pipe, conduit or tubing to be centered within the firestop system. A nom annular space of 5/16 in. (8 mm) is required within the firestop system. Pipe, conduit or tubing to be rigidly supported on both sides of wall assembly. The following types and sizes of nonmetallic pipes, conduits or tubing may be used:
 - A. **Polyvinyl Chloride (PVC) Pipe** – Nom 2 in. (51 mm) diam (or smaller) Schedule 40 solid core PVC pipe for use in closed (process or supply) or vented (drain, waste or vent) piping systems.
 - B. **Chlorinated Polyvinyl Chloride (CPVC) Pipe** – Nom 2 in. (51 mm) diam (or smaller) SDR13.5 CPVC pipe for use in closed (process or supply) piping systems.
 - C. **Rigid Nonmetallic Conduit+** – Nom 2 in. (51 mm) diam (or smaller) Schedule 40 PVC conduit installed in accordance with the National Electrical Code (NFPA No. 70).
 - D. **Crosslinked Polyethylene (PEX) Tubing** – Nom 2 in. (51 mm) diam (or smaller) SDR 7.3 PEX tubing or nom 2 in. (51 mm) diam (or smaller) SDR 9 PEX tubing for use in closed (process or supply) or vented (drain, waste or vent) piping systems.
 - E. **Acrylonitrile Butadiene Styrene (ABS) Pipe** – Nom 2 in. (51 mm) diam (or smaller) Schedule 40 solid or cellular core ABS pipe for use in closed (process or supply) or vented (drain, waste or vent) piping system.
 - F. **Electrical Nonmetallic Tubing (ENT)+** – Nom 2 in. (51 mm) diam (or smaller) corrugated-wall electrical nonmetallic tubing (ENT) constructed of PVC and installed in accordance with Article 331 of the National Electrical Code (NFPA 70).

See **Electrical Nonmetallic Tubing (FKHU)** category in the Electrical Construction Materials Directory for names of manufacturers.
 - G. **Flexible Nonmetallic Conduit, Liquid-Tight (FNMC)+** – Nom 2 in. (51 mm) diam (or smaller) corrugated-wall flexible nonmetallic conduit (FNMC) constructed of PVC and installed in accordance with Article 351 of the National Electrical Code (NFPA 70).

See **Flexible Nonmetallic Conduit, Liquid-Tight (DXOQ)** category in the Electrical Construction Materials Directory for names of manufacturers.
- The T Rating is 0 Hr and 1-1/2 Hr for 1 and 2 Hr rated assemblies, respectively, for Penetrants A, B and C. The T Rating is 0 Hr and 2 Hr for 1 and 2 Hr rated assemblies, respectively, for Penetrants D, F and G. The T Rating is 0 Hr for Penetrant E.**
3. **Fill, Void or Cavity Material*** – Sealant – Min 5/8 in. (16 mm) and 1-1/4 in. (32 mm) thicknesses of fill material required for 1 and 2 Hr rated assemblies, respectively, applied within the annulus, flush with both surfaces of wall.

3M COMPANY

3M FIRE PROTECTION PRODUCTS – FB-3000 WT sealant

*Bearing the UL Classification Mark

Reprinted from the Online Certifications Directory with permission from Underwriters Laboratories Inc.

Copyright © 2011 Underwriters Laboratories Inc.®

System No. W-L-2547

August 04, 2009

F Ratings – 1 and 2 Hr (See Item 1)

T Ratings – 0 and 1-3/4 Hr (See Item 1)

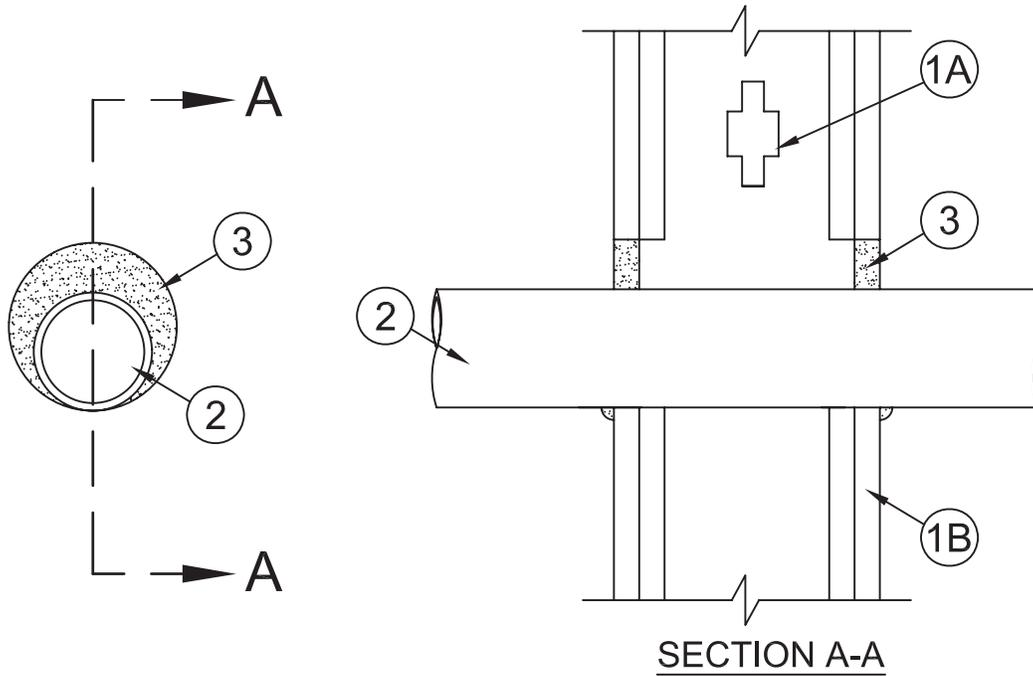

1. **Wall Assembly** – The 1 and 2 hr fire rated gypsum board/stud wall assemblies shall be constructed of the materials and in the manner specified in the individual U300, U400 or V400 Series Wall and Partition Designs in the UL Fire Resistance Directory and shall include the following construction features:

- A. **Studs** – Wall framing may consist of either wood studs or steel channel studs. Wood studs to consist of nom 2 by 4 in. (51 by 102 mm) lumber spaced 16 in. (406 mm) OC. Steel studs to be min 3-1/2 in. (89 mm) wide and spaced max 24 in. (610 mm) OC.
- B. **Gypsum Board*** – Thickness, type, number of layers and fasteners as required in the individual Wall and Partition Design. Diameter of opening shall be 1-1/2 in. (38 mm) larger than the outside diam of tubing (Items 2).

The hourly F Rating of the firestop system is equal to the hourly fire rating of the wall assembly in which it is installed. The hourly T Rating is 0 and 1-3/4 hr for 1 and 2 hr rated assemblies, respectively.

2. **Crosslink Polyethylene (PEX) Tubing** – Nom 2 in. (51 mm) diam (or smaller) SDR 9 PEX tubing for use in closed (process or supply) piping system. Tubing installed concentrically or eccentrically within opening. Annular space between tubing and edge of opening to be min 0 in. to max 1-1/2 in. (38 mm). Tubing to be rigidly supported on both sides of wall assembly.
3. **Fill, Void or Cavity Materials* – Caulk or Sealant** – Min 5/8 in. (16 mm) thickness of fill material applied within the annulus, flush with both surfaces of wall assembly. An additional min 1/2 in. (13 mm) bead of fill material applied at the tubing/gypsum board interface at point contact location on both surfaces of wall assembly.

3M COMPANY**3M FIRE PROTECTION PRODUCTS** – CP 25WB+, IC 15WB+ or FB-3000 WT

*Bearing the UL Classification Mark

Reprinted from the Online Certifications Directory with permission from Underwriters Laboratories Inc.

Copyright © 2010 Underwriters Laboratories Inc.®

System No. W-L-2551

July 09, 2015

F Ratings — 1 and 2 Hr (See Item 1)

T Ratings — 0, 1 and 2 Hr (See Item 1)

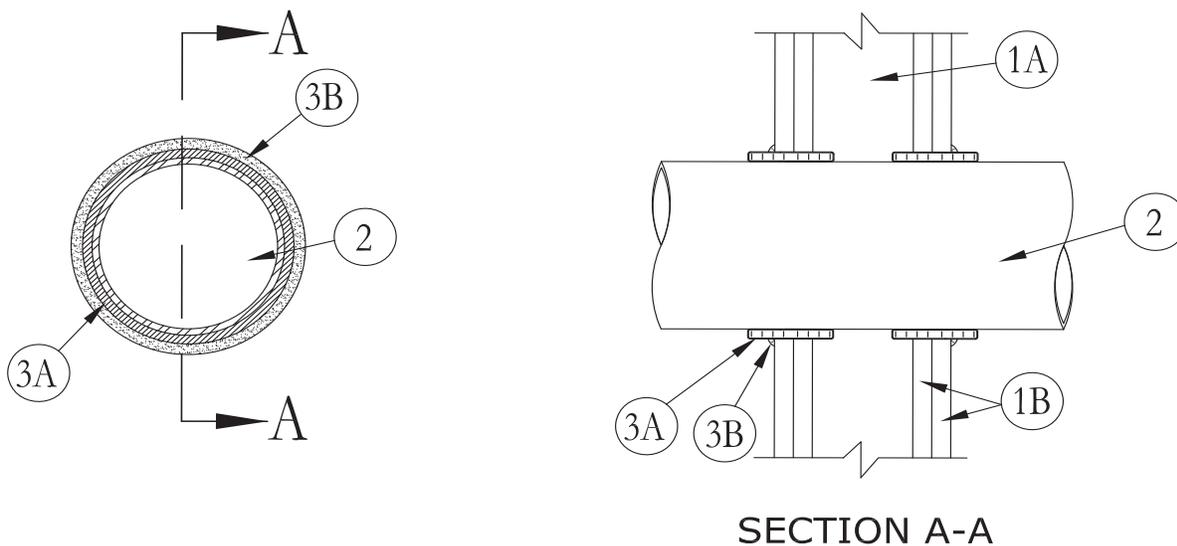

SECTION A-A

1. **Wall Assembly** — The 1 or 2 hr fire rated gypsum board/stud wall assembly shall be constructed of the materials and in the manner described in the individual U300, U400 or V400 Series Wall and Partition Design in the UL Fire Resistance Directory and shall include the following construction features:

- A. **Studs** — Wall framing may consist of either wood studs or steel channel studs. Wood studs to consist of nom 2 by 4 in. (51 by 102 mm) lumber spaced 16 in. (406 mm) OC. Steel studs to be min 3-1/2 in. (89 mm) wide spaced max 24 in. (610 mm) OC.
- B. **Gypsum Board*** — The gypsum board type, thickness, number of layers, fastener type and sheet orientation shall be as specified in the individual Design in the UL Fire Resistance Directory. Max diam of opening is 5 in. (127 mm).

The hourly F Rating of the firestop system is equal to the hourly fire rating of the wall assembly in which it is installed. The hourly T Rating is 1 and 2 hr for 1 and 2 hr rated assemblies, respectively, except that when FRPP pipe (Item 2C) is used together with steel sleeve (Item 1A), T Rating is 0 hr.

- 1A. **Sleeve** — (Optional. Not Shown) — Cylindrical sleeve fabricated from min 28 ga galv sheet steel and having a min 1 in. (25 mm) lap along the longitudinal seam friction fit into wall opening, installed flush with or extending max 5/8 in. (16 mm) beyond both wall surfaces.
2. **Through Penetrants** — One nonmetallic pipe or conduit concentrically or eccentrically within the firestop system. The annular space between penetrant and periphery of opening or sleeve shall be min 3/8 in. (10 mm) to max 5/8 in. (16 mm). Penetrant to be rigidly supported on both sides of wall assembly. The following types and sizes of nonmetallic pipes or conduits:
- A. **Polyvinyl Chloride (PVC) Pipe** — Nom 4 in. (102 mm) diam (or smaller) Schedule 40 solid core or cellular core PVC pipe for use in closed (process or supply) or vented (drain, waste or vent) piping systems.
 - B. **Chlorinated Polyvinyl Chloride (CPVC) Pipe** — Nom 4 in. (102 mm) diam (or smaller) SDR13.5 CPVC pipe for use in closed (process or supply) or vented (drain, waste or vent) piping systems. (See Item 3C below.)
 - C. **Fire Retardant Polypropylene (FRPP) Pipe** — Nom 4 in. (102 mm) diam (or smaller) Schedule 40 FRPP pipe for use in closed (process or supply) or vented (drain, waste or vent) piping systems.
 - D. **Rigid Nonmetallic Conduit+** — Nom 4 in. (102 mm) diam (or smaller) Schedule 40 PVC conduit installed in accordance with the National Electrical Code (NFPA No. 70).
3. **Firestop System** — The firestop system shall consist of the following:
- A. **Fill, Void or Cavity Materials* - Wrap Strip** — Min 3/16 in. (5 mm) thick intumescent material supplied in 2-1/2 in. (64 mm) wide strips. Single layer of pre-cut wrap strip tightly wrapped around nonmetallic pipe and secured with the adhesive closure tab. Wrap strip to be slid into opening or sleeve such that the outer edge of wrap strip extends nom 5/8 in. (16 mm) from both surfaces of wall.

3M COMPANY 3M FIRE PROTECTION PRODUCTS — Tuck-In Wrap Strip WS 200, WS 300 or WS 400
 - B. **Fill, Void or Cavity Material* - Caulk or Sealant** — Min 1/4 in. (6 mm) diam bead of sealant applied to gypsum board or sleeve/wrap strip interface on both sides of wall.

3M COMPANY 3M FIRE PROTECTION PRODUCTS — IC 15WB+, CP25WB+ or FB-3000 WT sealant (CP 25WB+ not suitable for use with CPVC pipes).

Through Penetrations

Non-Metallic Pipes

2000 Series

Gypsum

WL

System No. W-L-2551 *continued*

C. **Foil Tape (Not Shown)** — Required only when CPVC penetrant (Item 2B) is used. Nom 4 in. (102 mm) wide, 3 mil thick aluminum tape installed around pipe prior to installation of wrap strip. Foil tape is to be positioned such that it will be centered under the wrap strip material with adhesive side out.

* **Indicates such products shall bear the UL or cUL Certification Mark for jurisdictions employing the UL or cUL Certification (such as Canada), respectively.**



Through Penetrations

Non-Metallic Pipes

2000 Series

Gypsum

W/L

System No. W-L-2553

July 19, 2010

F Ratings – 1 and 2 Hr (See Item 1)

T Ratings – 1/2, 1 and 2 Hr (See Item 2)

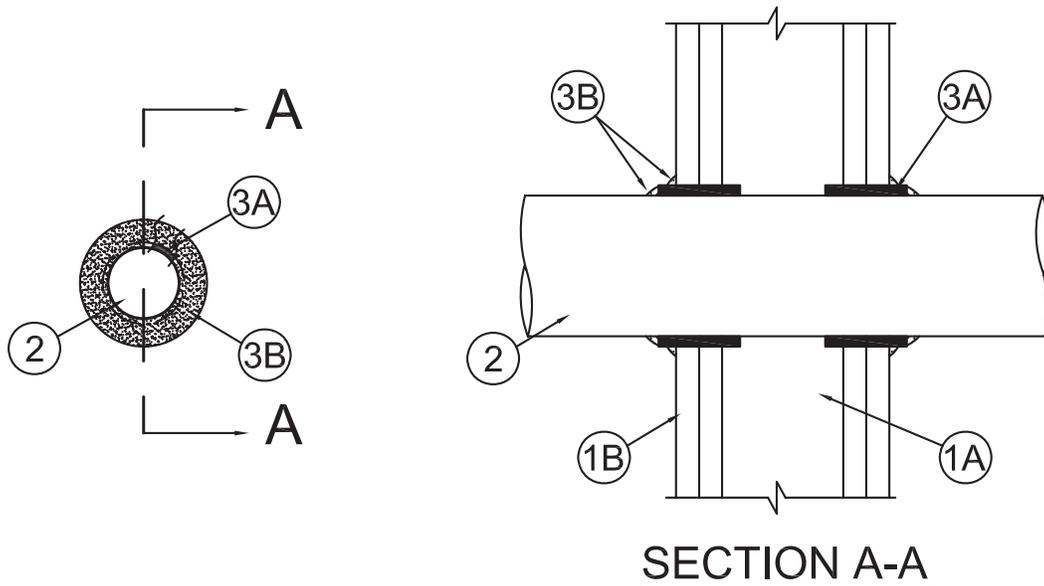

1. **Wall Assembly** – The 1 or 2 hr fire rated gypsum board/stud wall assembly shall be constructed of the materials and in the manner described in the individual U300, U400 or V400 Series Wall and Partition Design in the UL Fire Resistance Directory and shall include the following construction features:
 - A. **Studs** – Wall framing may consist of either wood studs or steel channel studs. Wood studs to consist of nom 2 by 4 in. (51 by 102 mm) lumber spaced 16 in. (406 mm) OC. Steel studs to be min 3-1/2 in. (89 mm) wide spaced max 24 in. (610 mm) OC.
 - B. **Gypsum Board*** – The gypsum board type, thickness, number of layers, fastener type and sheet orientation shall be as specified in the individual Design in the UL Fire Resistance Directory. Max diam of opening is 8 in. (203 mm).

The hourly F Rating of the firestop system is equal to the hourly fire rating of the wall assembly in which it is installed.
2. **Through Penetrant** – One nom 6 in. (152 mm) diam nonmetallic pipe centered in the firestop system. The annular space between the penetrant and the periphery of opening shall be min 3/8 in. (10 mm) to max 5/8 in. (16 mm). Penetrant to be rigidly supported on both sides of wall assembly. The following types and sizes of nonmetallic pipe may be used:
 - A. **Solid Core Polyvinyl Chloride (scPVC) Pipe** – Nom 6 in. (152 mm) diam Schedule 40 solid core PVC pipe for use in closed (process or supply) or vented (drain, waste or vent) piping systems. **The hourly T Rating is 1 hr and 2 hr for 1 hr and 2 hr fire rated assemblies, respectively, when Item 2A is used.**
 - B. **Cellular Core Polyvinyl Chloride (ccPVC) Pipe** – Nom 6 in. (152 mm) diam Schedule 40 cellular core PVC pipe for use in closed (process or supply) or vented (drain, waste or vent) piping systems. **The hourly T Rating is 1/2 hr and 1 hr for 1 hr and 2 hr fire rated assemblies, respectively, when Item 2B is used.**
3. **Firestop System** – The firestop system shall consist of the following:
 - A. **Fill, Void or Cavity Materials* – Wrap Strip** – Nom 3/16 in. (5 mm) thick intumescent material supplied in nom 2-1/2 in. (64 mm) wide strips. Two layers of wrap strip tightly wrapped around nonmetallic pipe and secured with glass fiber-reinforced strapping tape. Wrap strip to be slid into opening such that the outer edge of wrap strip protrudes approx 5/8 in. (16 mm) from both surfaces of wall.

3M COMPANY
3M FIRE PROTECTION PRODUCTS – Fire Barrier Tuck-In WS Roll
 - B. **Fill, Void or Cavity Material* – Caulk or Sealant** – Min 1/4 in. (6 mm) diam bead of sealant applied to gypsum board/wrap strip interface on both sides of wall.

3M COMPANY
3M FIRE PROTECTION PRODUCTS – IC 15WB+, CP 25WB+ or FB-3000 WT sealant

*Bearing the UL Classification Mark

Reprinted from the Online Certifications Directory with permission from Underwriters Laboratories Inc.
Copyright © 2010 Underwriters Laboratories Inc.®



Note: Systems with Nonmetallic Through Penetrant(s) have not been evaluated with a pressure differential of 50 Pa between the exposed and unexposed surfaces as required by the National Building Code of Canada.

System No. W-L-2572

August 16, 2012

ANSI/UL1479 (ASTM E814)

F Ratings – 1 and 2 Hr (See Item 1)

T Ratings – 1 and 2 Hr (See Item 1)

CAN/ULC S115

F Ratings – 1 and 2 Hr (See Item 1)

FT Ratings – 1 and 2 Hr (See Item 1)

FH Ratings – 1 and 2 Hr (See Item 1)

FTH Ratings – 1 and 2 Hr (See Item 1)

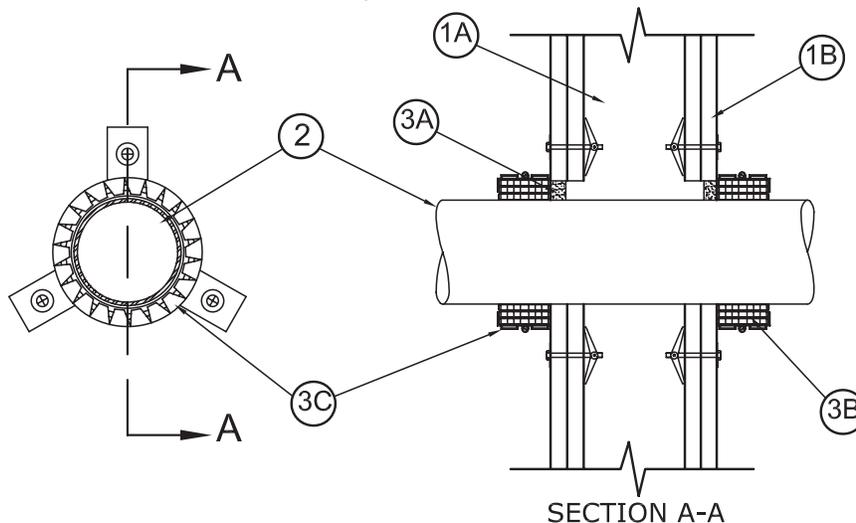

System tested with a pressure differential of 2.5 Pa between the exposed and the unexposed surfaces with the higher pressure on the exposed side.

1. **Wall Assembly** – The 1 or 2 hr fire rated gypsum board/stud wall assembly shall be constructed of the materials and in the manner described in the individual U300, U400, V400 or W400 Series Wall and Partition Design in the UL Fire Resistance Directory and shall include the following construction features:

- A. **Studs** – Wall framing may consist of either wood studs or steel channel studs. Wood studs to consist of nom 2 by 4 in. (51 by 102 mm) lumber spaced 16 in. (406 mm) OC. Steel studs to be min 3-1/2 in. (89 mm) wide spaced max 24 in. (610 mm) OC.
- B. **Gypsum Board*** – The gypsum board type, thickness, number of layers, fastener type and sheet orientation shall be as specified in the individual Design in the UL Fire Resistance Directory. Max diam of opening is 5 in. (127 mm).

The hourly Ratings of the firestop system are equal to the hourly fire rating of the wall assembly in which it is installed.

2. **Through Penetrant** – One nonmetallic pipe to be installed concentrically or eccentrically within the firestop system. The annular space between the penetrant and the periphery of opening shall be min 1/4 in. (6 mm) to max 1 in. (25 mm). Penetrant to be rigidly supported on both sides of wall assembly. The following types and sizes of nonmetallic pipe may be used:
 - A. **Polypropylene (PP) Pipe** – Nom 3 in. (76 mm) diam (or smaller) Aquatherm Fusiotherm SDR 7.4 PP pipe for use in closed (process or supply) or vented (drain, waste or vent) piping systems.
 - B. **Polypropylene (PP) Pipe** – Nom 3 in. (76 mm) diam (or smaller) Aquatherm Climatherm SDR 11 PP pipe for use in closed (process or supply) or vented (drain, waste or vent) piping systems.
3. **Firestop System** – The firestop system shall consist of the following:
 - A. **Fill, Void or Cavity Material* – Caulk or Sealant** – Min 1/4 in. (6 mm) thickness of fill material applied within the annular space, flush with both surfaces of wall.
3M COMPANY
3M FIRE PROTECTION PRODUCTS – IC 15WB+ caulk, CP 25WB+ caulk or FB-3000 WT sealant
 - B. **Fill, Void or Cavity Materials* – Wrap Strip** – Nom 1/8 in. (3.2 mm) thick intumescent material supplied in 2 in. (51 mm) wide strips. Min three layers of wrap strip tightly wrapped around nonmetallic pipe with continuous layers and butted tightly against both surfaces of the wall. Wrap strip layers temporarily held in position using aluminum filament tape, foil tape, steel wire tie, or equivalent.
3M COMPANY
3M FIRE PROTECTION PRODUCTS – Ultra GS
 - C. **Steel Collar** – Nom 2 in. (51 mm) deep collar with 1-1/4 in. (32 mm) wide by 2 in. (51 mm) long anchor tabs and min 1/2 in. (13 mm) long tabs to retain wrap strip layers. Coils of precut 0.016 in. (.41 mm) thick (28 gauge) galv sheet steel available from wrap strip manufacturer. Steel collar, with anchor tabs bent outward 90 degrees, wrapped tightly around wrap strip layers with min 1 in. (25 mm) overlap at seam. Anchor tabs to be pressed tightly against wall surfaces, and collar to be compressed around wrap strip layers using a min 1/2 in. (13 mm) wide by 0.028 in. (0.71 mm) thick stainless steel band clamp at the middle of collar. Collar to be secured to wall surfaces with min 3/16 in. (5 mm) diam steel toggle bolts, or equivalent, in conjunction with min 1 in. (25 mm) diam steel washers. Min three anchor bolts, symmetrically located.

*Bearing the UL Classification Mark

Reprinted from the Online Certifications Directory with permission from UL

© 2013 UL LLC



System No. W-L-2580

August 07, 2015

ANSI/UL1479 (ASTM E814)
 F Ratings — 1 and 2 Hr (See Item 1)
 T Ratings — 1 and 2 Hr (See Item 1)

CAN/ULC S115
 F Ratings — 1 and 2 Hr (See Item 1)
 FT Ratings — 1 and 2 Hr (See Item 1)
 FH Ratings — 1 and 2 Hr (See Item 1)
 FTH Ratings — 1 and 2 Hr (See Item 1)

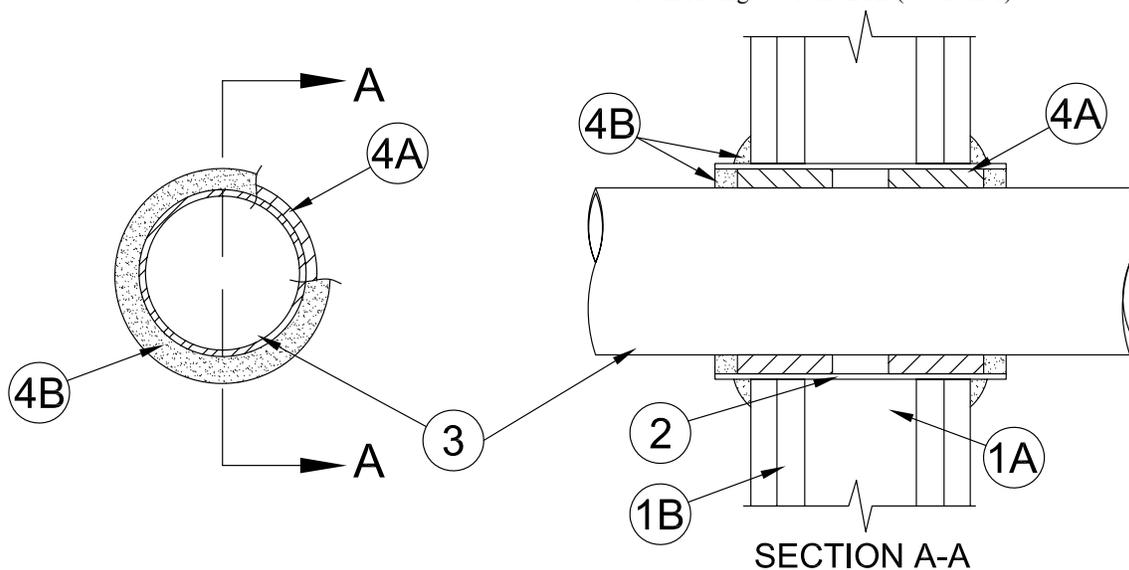

System tested with a pressure differential of 50 Pa between the exposed and the unexposed surfaces with the higher pressure on the exposed side.

- Wall Assembly** — The 1 or 2 hr fire rated gypsum board/stud wall assembly shall be constructed of the materials and in the manner described in the individual U300, U400, V400 or W400 Series Wall and Partition Design in the UL Fire Resistance Directory and shall include the following construction features:
 - Studs** — Wall framing may consist of either wood studs or steel channel studs. Wood studs to consist of nom 2 by 4 in. (51 by 102 mm) lumber spaced 16 in. (406 mm) OC. Steel studs to be min 3-1/2 in. (89 mm) wide spaced max 24 in. (610 mm) OC.
 - Gypsum Board*** — The gypsum board type, thickness, number of layers, fastener type and sheet orientation shall be as specified in the individual Design in the UL Fire Resistance Directory. Max diam of opening is 5-1/2 in. (140 mm).

The hourly F, T, FT, FH and FTH Rating of the firestop system is equal to the hourly fire rating of the wall assembly in which it is installed.

- Sleeve** — Cylindrical sleeve fabricated from min 28 ga galv sheet steel and having a min 1 in. (25 mm) lap along the longitudinal seam friction fit into wall opening, extending nom 1 in. (25 mm) beyond both wall surfaces.
- Through Penetrants** — One nonmetallic pipe or conduit installed concentrically within the firestop system. The annular space between penetrant and periphery of opening shall be nom 1/2 in. (13 mm). Penetrant to be rigidly supported on both sides of wall assembly. The following types and sizes of nonmetallic pipes or conduits:
 - Polyvinyl Chloride (PVC) Pipe** — Nom 2 in. (51 mm) diam (or smaller) Schedule 40 solid core PVC pipe for use in closed (process or supply) or vented (drain, waste or vent) piping systems.
 - Chlorinated Polyvinyl Chloride (CPVC) Pipe** — Nom 2 in. (51 mm) diam (or smaller) SDR13.5 CPVC pipe for use in closed (process or supply) or vented (drain, waste or vent) piping systems.
 - Polyvinylidene Fluoride (PVDF) Pipe** — Nom 4 in. (102 mm) diam (or smaller) Schedule 40 PVDF pipe for use in closed (process or supply) or vented (drain, waste or vent) piping systems.
 - Rigid Nonmetallic Conduit+** — Nom 2 in. (51 mm) diam (or smaller) Schedule 40 PVC conduit installed in accordance with the National Electrical Code (NFPA No. 70).
- Firestop System** — The firestop system shall consist of the following:
 - Fill, Void or Cavity Materials* - Wrap Strip** — Min 3/16 in. (5 mm) thick intumescent material supplied in 2-1/2 in. (64 mm) wide strips. Single layer of pre-cut wrap strip tightly wrapped around nonmetallic pipe and secured with the adhesive closure tab. Wrap strip to be slid into sleeved opening at both sides of wall such that the outer edge of wrap strip is recessed 1/2 in. (13 mm) from both ends of sleeve.

3M COMPANY 3M FIRE PROTECTION PRODUCTS — Tuck-In Wrap Strip
 - Fill, Void or Cavity Material*** — Min 1/2 in. (13 mm) thickness of sealant applied within annulus flush with both ends of sleeve. Min 1/4 in. (6 mm) diam bead of sealant applied to gypsum board/sleeve interface on both sides of wall.

3M COMPANY 3M FIRE PROTECTION PRODUCTS — IC 15WB+, Fire Barrier CP25WB+ or 3000WT sealant. CP 25WB+ not suitable for use with CPVC pipes.
 - Foil Tape (Not Shown)** — Required only when CPVC penetrant (Item 3B) is used. Nom 4 in. (102 mm) wide, 3 mil thick aluminum tape installed around pipe prior to installation of wrap strip. Foil tape is to be positioned such that it will be centered under the wrap strip material with adhesive side out.

* Indicates such products shall bear the UL or cUL Certification Mark for jurisdictions employing the UL or cUL Certification (such as Canada), respectively.



UL System No. W-L-2648
XHEZ - Through-penetration Firestop Systems

January 24, 2017

F Ratings – 1 and 2 Hr (See Item 1)

T Ratings – 1 and 2 Hr (See Item 1)

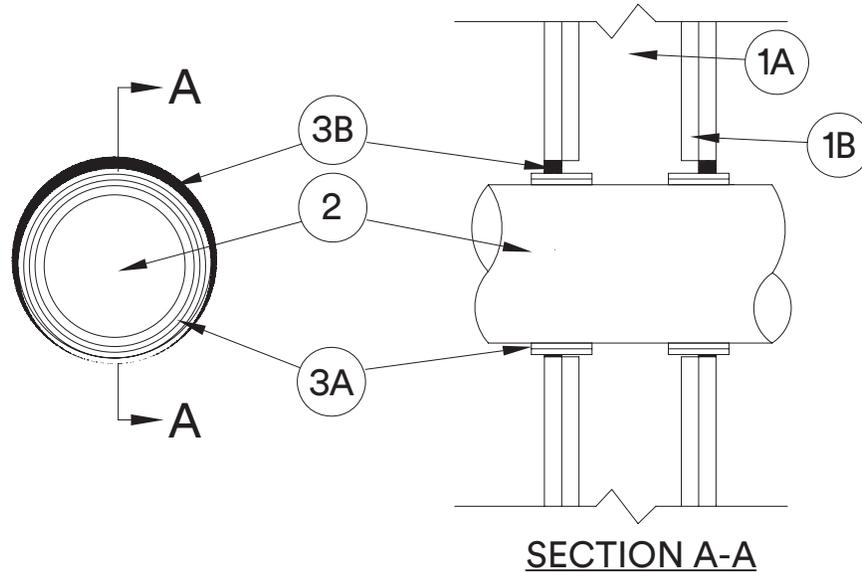

1. **Wall Assembly** – The fire-rated gypsum board/stud wall assembly shall be constructed of the materials and in the manner specified in the individual U300, U400, V400 or W400 Series Wall and Partition Designs in the UL fire Resistance Directory and shall include the construction features noted below:

- A. **Studs** – Wall framing may consist of either wood studs or steel channel studs. Wood studs to consist of nom 2 by 4 in. (51 by 102 mm) lumber spaced max 16 in. (406 mm) OC. Steel studs to be min 3-1/2 in. (89 mm) wide and spaced max 24 in. (610 mm) OC.
- B. **Gypsum Board*** – Nom 5/8 in. (16 mm) thick gypsum board, as specified in the individual Wall and Partition Design. Maximum diam of opening is 9 in. (229 mm).

The hourly F and T Ratings of the firestop system are equal to the hourly fire rating of the wall assembly in which it is installed.

2. **Through Penetrants** – One nonmetallic pipe to be installed either concentrically or eccentrically within the firestop system. The annular space between pipe and the periphery of opening shall be min 3/8 in. (9.5 mm) to a max 3/4 in. (19 mm). The following types and sizes of nonmetallic pipes may be used:

- A. **Polypropylene (PP) Pipe** – Nom 8 in. (200 mm OD) or nom 6 in. (160 mm OD) diam Orion Polystar™ PP-RCT (CT-White) SDR 17 PP pipe for use in closed (process or supply) piping systems.

3. **Firestop System** – The firestop system shall consist of the following:

- A. **Fill, Void or Cavity Materials* – Wrap Strip** – Min 3/16 in. (5 mm) thick intumescent material supplied in 2-1/2 in. (64 mm) wide strips. Two layers of wrap strip are tightly wrapped around the nonmetallic pipe and secured with aluminum foil tape. Wrap strip is to be installed on both sides of wall and slid into the wall opening such that the outer edge of wrap strip is extending 5/8 in. (16 mm) from both surfaces of wall.

3M COMPANY 3M FIRE PROTECTION PRODUCTS – Tuck-In Wrap Strip WS Roll

- B. **Fill, Void or Cavity Materials* – Caulk or Sealant** – Min 5/8 in. (16 mm) thickness of sealant applied within annular space, flush with both sides of wall.

3M COMPANY 3M FIRE PROTECTION PRODUCTS – IC 15WB+ Caulk, CP 25WB+ Caulk, or 3000 WT Sealant



*Indicates such products shall bear the UL Certification Mark for jurisdictions employing the UL Certification.

Reprinted from the Online Certifications Directory with permission from UL©

Non-Metallic Pipes • Wood Frame Floor/Ceiling

| 3M UL Systems | "F" Rating | 3M Product | Through Penetrant Details |
|---------------|------------|--|--|
| F-C-2002 | 2 | 3M™ Fire Barrier Sealant CP 25WB+ 3M™ Fire Barrier Sealant IC 15WB+ 3M™ Fire Barrier Sealant FD 150+ 3M™ Fire Barrier Wrap Strips FS-195+ 3M™ Fire Barrier Ultra Plastic Pipe Device 3M™ Fire Barrier RC-1 Restricting Collar 3M™ Fire Barrier Water Tight Sealant 3000 WT | 4" PVC (closed or vented), 4" SDR 13.5 CPVC (closed). Diam of opening max 1/8" larger than OD of pipe. Concentric installation. Steel collar required. 2 hour F Rating. CP 25WB+ not for CPVC. Also known as FC2002. |
| F-C-2008 | 1 | 3M™ Fire Barrier Sealant CP 25WB+ 3M™ Fire Barrier Wrap Strips FS-195+ 3M™ Fire Barrier Moldable Putty Stix MP+ 3M™ Fire Barrier Water Tight Sealant 3000 WT | 2" PVC (closed or vented), 2" ABS (closed or vented), 2" SDR 13.5 CPVC (closed). 1" corrugated ENT. Max diam of opening 3". Concentric installation. Min 1/4" to max 3/8" annular. 1 hour F Rating. CP 25WB+ not for CPVC. Also known as FC2008. |
| F-C-2024 | 1, 2 | 3M™ Fire Barrier Sealant CP 25WB+ 3M™ Fire Barrier Sealant IC 15WB+ 3M™ Fire Barrier Sealant FD 150+ 3M™ Fire Barrier Wrap Strips FS-195+ 3M™ Fire Barrier Ultra Plastic Pipe Device 3M™ Fire Barrier RC-1 Restricting Collar | 4" PVC, ccPVC, CPVC, ABS, ccABS, steel collar. CP 25WB+ not for CPVC. Also referred as FC2024. |
| F-C-2026 | 1 | 3M™ Fire Barrier Sealant CP 25WB+ 3M™ Fire Barrier Sealant IC 15WB+ 3M™ Fire Barrier Sealant FD 150+ 3M™ Fire Barrier Wrap Strips FS-195+ | 1-1/2" PVC drain fitting. Also referred as FC2026. |
| F-C-2039 | 1 | 3M™ Fire Barrier Sealant CP 25WB+ 3M™ Fire Barrier Sealant IC 15WB+ 3M™ Fire Barrier Moldable Putty Stix MP+ 3M™ Fire Barrier Water Tight Sealant 3000 WT | 1-1/2" PVC (closed or vented), 1-1/2" RNC, 1-1/2" SDR 13.5 CPVC (closed), 1-1/2" ccPVC (closed or vented), 1-1/2" ABS (closed or vented), 1-1/2" ccABS (closed or vented), 1" SDR 9 PEX (closed), 1-1/4" ENT. Opening max 1/8" larger than OD of penetrant. Concentric or eccentric installation. Point contact to max 5/8" annular. 1 hour F Rating. CP 25WB+ not for CPVC. Also known as FC2039. |
| F-C-2064 | 1 | 3M™ Fire Barrier Sealant CP 25WB+ 3M™ Fire Barrier Sealant IC 15WB+ 3M™ Fire Barrier Sealant FD 150+ 3M™ Fire Barrier Wrap Strips FS-195+ 3M™ Fire Barrier Water Tight Sealant 3000 WT | 2" PVC (closed or vented), 2" ccPVC (closed or vented), 2" RNC, 2" ABS (closed or vented), 2" ccABS (closed or vented), 2" SDR 13.5 CPVC (closed). Max diam of opening 4-1/2". Chase wall optional. Foil tape required. 1 hour F rating. CP 25WB+ not for CPVC. Also known as FC2064. |
| F-C-2115 | 1, 2 | 3M™ Fire Barrier Wrap Strips FS-195+ 3M™ Fire Barrier Wrap Ultra GS 3M™ Fire Barrier RC-1 Restricting Collar 3M™ Fire Barrier Sealant CP 25WB+ 3M™ Fire Barrier Sealant FD 150+ 3M™ Fire Barrier Water Tight Sealant 3000 WT 3M™ Fire Barrier Sealant IC 15WB+ | 4" PVC Closed or vented, 4" CCPVC closed or vented, 4 in. ABS closed or vented, 4" ccABS closed or vented. Floor/ceiling assembly with max 5 in. |
| F-C-2120 | 2 | 3M™ Fire Barrier Sealant CP 25WB+ 3M™ Fire Barrier Water Tight Sealant 3000 WT | Max 1 in. PE-AL-PE (closed or vented), max 1 in. PEX-AL-PEX (closed or vented). L505, L511 or L536 assembly. Max opening 1-3/4 in. Nominal 1/4 in. annular for PE-AL-PE, 1/8 for PEX-AL-PEX. Concentric installation. 2 hour F rating. 1 hour T rating. Also known as FC2120. |
| F-C-2121 | 1 | 3M™ Fire Barrier Sealant CP 25WB+ 3M™ Fire Barrier Water Tight Sealant 3000 WT | Max 1 in. PE-AL-PE (closed or vented), max 1 in. PEX-AL-PEX (closed or vented). L500 Series assembly. Max opening 1-3/4 in. Nominal 1/4 in. annular for PE-AL-PE, 1/8 for PEX-AL-PEX. Concentric installation. 1 hour F & T rating. Also known as FC2121. |
| F-C-2129 | 1, 2 | 3M™ Fire Barrier Sealant CP 25WB+ 3M™ Fire Barrier Sealant IC 15WB+ 3M™ Fire Barrier Sealant FD 150+ 3M™ Fire Barrier Ultra Plastic Pipe Device 3M™ Fire Barrier Water Tight Sealant 3000 WT | 4" PVC (closed or vented), 4" CPVC (closed), 4" ccPVC (closed or vented), 4" ABS (closed or vented), 4" ccABS (closed or vented). See system for branch piping details. Opening 1" larger than OD of penetrant. Concentric installation. Chase wall optional. Collar system. 1 & 2 Hour F Rating. Also known as FC2129. |
| F-C-2134 | 1 | 3M™ Fire Barrier Sealant CP 25WB+ 3M™ Fire Barrier Sealant IC 15WB+ 3M™ Fire Barrier Water Tight Sealant 3000 WT | Max 3" PVC, 3" ccPVC, 3" ABS, 3" ccABS-all closed or vented. Optional max 3" branch piping. Max 3" penetrant routed through chase wall. Max opening min 1/2" to max 1" larger than OD of penetrant. Point contact to max 1/2 in. annular space. Caulk only system. 1 hour F rating. No T rating. Also known as FC2134. |
| F-C-2141 | 1 | 3M™ Fire Barrier Wrap Ultra GS 3M™ Fire Barrier Sealant CP 25WB+ 3M™ Fire Barrier Water Tight Sealant 3000 WT | 2" PVC (closed or vented), 2" ccPVC (closed or vented), 2" SDR 13.5 CPVC (closed), 2" RNC, 1-1/2" ABS (closed or vented), 1-1/2" ccABS (closed or vented). Diam of opening min 5/8" to max 1-1/8" larger than nom diam of pipe. Chase wall optional. Concentric or eccentric installation. Point contact to max 1-1/8" annular. 1 hour F Rating. Also known as FC2141. |

Non-Metallic Pipes • Wood Frame Floor/Ceiling

| 3M UL Systems | "F" Rating | 3M Product | Through Penetrant Details |
|---------------|------------|--|--|
| F-C-2240 | 1 | 3M™ Fire Barrier Sealant CP 25WB+ 3M™ Fire Barrier Sealant IC 15WB+ 3M™ Fire Barrier Water Tight Sealant 3000 WT | 1" SDR 9 PEX (closed). Max diam of opening 2". Concentric or eccentric installation. Point contact to max 3/4" annular. 1 hour F Rating. Also known as FC2240. |
| F-C-2241 | 1 | 3M™ Fire Barrier Sealant CP 25WB+ 3M™ Fire Barrier Sealant IC 15WB+ 3M™ Fire Barrier Water Tight Sealant 3000 WT | 2" PVC (closed or vented), 2" ccPVC (closed or vented), 2" SDR 13.5 CPVC (closed), 2" RNC, 2" ABS (closed or vented), 2" ccABS (closed or vented). Diam of opening min 5/8" to max 1-1/8" larger than nom diam of pipe. Chase wall optional. Concentric or eccentric installation. Point contact to max 1-1/8" annular. 1 hour F Rating. Also known as FC2241. |
| F-C-2343 | 1 | 3M™ Fire Barrier Sealant CP 25WB+ 3M™ Fire Barrier Sealant FD 150+ 3M™ Fire Barrier Sealant IC 15WB+ 3M™ Fire Barrier Water Tight Sealant 1000 NS 3M™ Fire Barrier Water Tight Sealant 3000 WT | Max 1/2 in. SDR 9 PEX (vented or closed). Max diameter of opening 1-1/2 in. Chase wall optional. Concentric or eccentric installation. Point contact to max 7/8 in. annular space. 1 hour F rating. Also known as FC2343. |
| F-C-2344 | 1 | 3M™ Fire Barrier Sealant CP 25WB+ 3M™ Fire Barrier Sealant FD 150+ 3M™ Fire Barrier Sealant IC 15WB+ 3M™ Fire Barrier Water Tight Sealant 1000 NS 3M™ Fire Barrier Water Tight Sealant 3000 WT | Max two max 1/2 in. SDR 9 PEX (vented or closed) and max two 3/4 in. SDR 9 PEX (vented or closed). Max diam of opening 2-1/2 in. Concentric or eccentric installation. Point contact to max 7/8 in. annular space. 1 hour F rating. Also known as FC2344. |
| F-C-2349 | 1 | 3M™ Fire Barrier Sealant CP 25WB+ 3M™ Fire Barrier Sealant IC 15WB+ 3M™ Fire Barrier Water Tight Sealant 3000 WT | Max 4 in. toilet flange with max 4 in. PVC, 4 in. ccPVC, 4 in. ABS, or 4 in. ccABS drain pipe (vented). Max 5-1/2 in. diam opening. Point contact to max 1 in. annular. Floor mounted china water closet. Caulk only system. 1 hour F & T rating. Also known as FC2349 |
| F-C-2350 | 1 | 3M™ Fire Barrier Sealant CP 25WB+ 3M™ Fire Barrier Sealant IC 15WB+ 3M™ Fire Barrier Water Tight Sealant 3000 WT | Max 1-1/2 in. Sch 40 PVC tub drain with fittings. Max opening for fitting 8 in. x 12 in. One layer wood or gypsum patch. Max 2-1/2 in. diam opening in patch. Point contact to max 1 in. annular. 1 hour F rating. Caulk only system. Also known as FC2350. |
| F-C-2351 | 1 | 3M™ Fire Barrier Wrap Ultra GS | Nonmetallic shower base receptor with stainless steel drain plate. Nom 2 in. PVC or ccPVC solvent welded to drain and centered in opening. Max diam of opening 6 in. 1 hour F. Tile installed on shower pan. Steel collar required. Also known as FC2351. |
| F-C-2369 | 1 | 3M™ Fire Barrier Sealant CP 25WB+ 3M™ Fire Barrier Water Tight Sealant 3000 WT 3M™ Fire Barrier Sealant IC 15WB+ 3M™ Fire Barrier Sealant FD 150+ 3M™ Fire Barrier Wrap Ultra GS 3M™ Fire Barrier RC-1 Restricting Collar | Max 4" PVC, 4" ccPVC, 4" ABS, 4" ccABS-all closed or vented. Optional max 3" branch piping. Max 4" penetrant routed through chase wall. Max opening min 1/2" to max 1" larger than OD of penetrant. Point contact to max 1/2 in. annular space. Oblong collar on pipe in chase. 1 hour F & T rating. Also known as FC2369. |
| F-C-2387 | 1 | 3M™ Fire Barrier Sealant IC 15WB+ 3M™ Fire Barrier Sealant CP 25WB+ 3M™ Fire Barrier Water Tight Sealant 3000 WT | Max 3 in. PVC, 3 in. ccPVC, 3 in. ABS, 3 in. ccABS, 3 in. PVC. Optional 3 in. branch pipe: 3 in. PVC, 3 in. ccPVC, 3 in. ABS, 3 in. ccABS. L500 series floor/ceiling assembly. Penetrant must route through chase wall. Caulk only-no mineral wool required. 1 hour F rating. Also known as FC2387. |
| F-C-2388 | 1 | 3M™ Fire Barrier Sealant IC 15WB+ 3M™ Fire Barrier Sealant CP 25WB+ 3M™ Fire Barrier Water Tight Sealant 3000 WT 3M™ Fire Barrier Wrap Ultra GS | Max 4 in. PVC, 4 in. ccPVC, 4 in. ABS, 4 in. ccABS, 3 in. CPVC. Optional 3 in. branch pipe: 3 in. PVC, 3 in. ccPVC, 3 in. ABS, 3 in. ccABS. L500 series floor/ceiling assembly. Penetrant must route through chase wall. Oblong wrap strip and collar. Caulk only at branch pipe. 1 hour F rating. Also known as FC2388. |
| F-C-2391 | 1 | 3M™ Fire Barrier Sealant IC 15WB+ 3M™ Fire Barrier Sealant CP 25WB+ 3M™ Fire Barrier Water Tight Sealant 3000 WT | Max 2 in. PEX. L500 floor ceiling assembly. Diameter of opening 1-1/2 in. larger than OD of pipe. Point contact to max 1-1/2 in. annular. Chase wall optional. 1 hour F rating. No mineral wool required-sealant only. Also known as FC2391. |
| F-C-2396 | 1 | 3M™ Fire Barrier Tuck-In Wrap Strips 3M™ Fire Barrier Sealant CP 25WB+ 3M™ Fire Barrier Sealant IC 15WB+ 3M™ Fire Barrier Water Tight Sealant 3000 WT | L500 Series assembly. Optional U300 Series chase wall. Max 4 in. PVC, max 4 in. ccPVC, max 4 in. RNC. Max 6 in. opening. Concentric installation with nominal 3/4 in. annular. 1 hour F & T rating. Also known as FC2396. |
| F-C-2469 | 1 | 3M™ Fire Barrier Water Tight Sealant 3000 WT | Max. 2 in. nonmetallic pipe penetrating a 1 hour rated floor/ceiling assembly. |
| F-E-2001 | 1 | 3M™ Fire Barrier Sealant CP 25WB+ 3M™ Fire Barrier Wrap Strips FS-195+ 3M™ Fire Barrier Wrap Ultra GS 3M™ Fire Barrier Sealant IC 15WB+ 3M™ Fire Barrier Sealant FD 150+ 3M™ Fire Barrier Water Tight Sealant 3000 WT | 3" PVC (closed or vented), 4" ABS (closed or vented), 4" ccABS (closed or vented). See system for branch piping details. Max diam of opening 1" larger than nom diam of penetrant. Point contact to max 1/2" annular. Steel collar required. Aluminum foil tape required. 1 hour F Rating. Also known as FE2001. |

Non-Metallic Pipes • Wood Frame Floor/Ceiling

| 3M UL Systems | "F" Rating | 3M Product | Through Penetrant Details |
|---------------|------------|--|---|
| F-E-2002 | 1 | 3M™ Fire Barrier Sealant CP 25WB+ 3M™ Fire Barrier Sealant IC 15WB+ 3M™ Fire Barrier Sealant FD 150+ 3M™ Fire Barrier Moldable Putty Stix MP+ 3M™ Fire Barrier Water Tight Sealant 3000 WT | 1-1/2" PVC (closed or vented), 1-1/2" RNC, 1-1/2" SDR 13.5 CPVC (closed), 1-1/2" ccPVC (closed or vented), 1-1/2" ABS (closed or vented), 1-1/2" ccABS (closed or vented), 1" SDR 9 PEX (closed), 1-1/4" ENT. Diam of opening 5/8" larger than OD of pipe. Concentric or eccentric installation. Point contact to max 5/8" annular. 1 hour F Rating. CP 25WB+ not for CPVC. Also known as FE2002. |
| F-E-2012 | 1 | 3M™ Fire Barrier Sealant CP 25WB+ 3M™ Fire Barrier Sealant IC 15WB+ 3M™ Fire Barrier Water Tight Sealant 3000 WT | 1" SDR 9 PEX (closed). Max diam of opening 2". Concentric or eccentric installation. Point contact to max 3/4" annular. 1 hour F Rating. Also known as FE2012. |
| F-E-2013 | 1 | 3M™ Fire Barrier Sealant CP 25WB+ 3M™ Fire Barrier Sealant IC 15WB+ 3M™ Fire Barrier Sealant FD 150+ 3M™ Fire Barrier Water Tight Sealant 3000 WT | 2" PVC (closed or vented), 2" SDR 13.5 CPVC (closed) 2" ccPVC (closed or vented), 2" RNC, 1-1/2" ABS (closed or vented), 1-1/2" ccABS (closed or vented). Max diam of opening 3-1/2". Concentric or eccentric installation. Point contact to max 1-1/8" annular. 1 hour F Rating. CP 25WB+ not for CPVC. Also known as FE2013. |
| F-E-2040 | 1 | 3M™ Fire Barrier Sealant IC 15WB+ 3M™ Fire Barrier Sealant CP 25WB+ 3M™ Fire Barrier Water Tight Sealant 3000 WT | Max 2 in. SDR 9 PEX (closed). G500 series floor ceiling assemblies. Diameter of opening 1-1/2 in. larger than OD of PEX. Point contact to max 1-1/2 in. annular space. Concentric or eccentric installation. 1 hour F & T rating. No mineral wool required. Also known as FE2040. |
| F-E-2042 | 1 | 3M™ Fire Barrier Tuck-In Wrap Strips 3M™ Fire Barrier Sealant CP 25WB+ 3M™ Fire Barrier Sealant IC 15WB+ 3M™ Fire Barrier Water Tight Sealant 3000 WT | Max 4 in. PVC, max 4 in. ccPVC, max 4 in. RNC. Max 6 in. opening. Concentric installation with nominal 3/4 in. annular. 1 hour F & T rating. Also known as FE2042. |
| F-E-2044 | 1 | 3M™ Fire Barrier Water Tight Sealant 3000 WT | Max. 2 in. nonmetallic pipe penetrating a 1 hour rated G500 Series floor/ceiling assembly. Chase wall optional. |

System No. F-C-2002

November 20, 2009

F Rating – 2 Hr

T Rating – 2 Hr

L Rating At Ambient – 7 CFM/sq ft

L Rating At 400 F – Less Than 1 CFM/sq ft

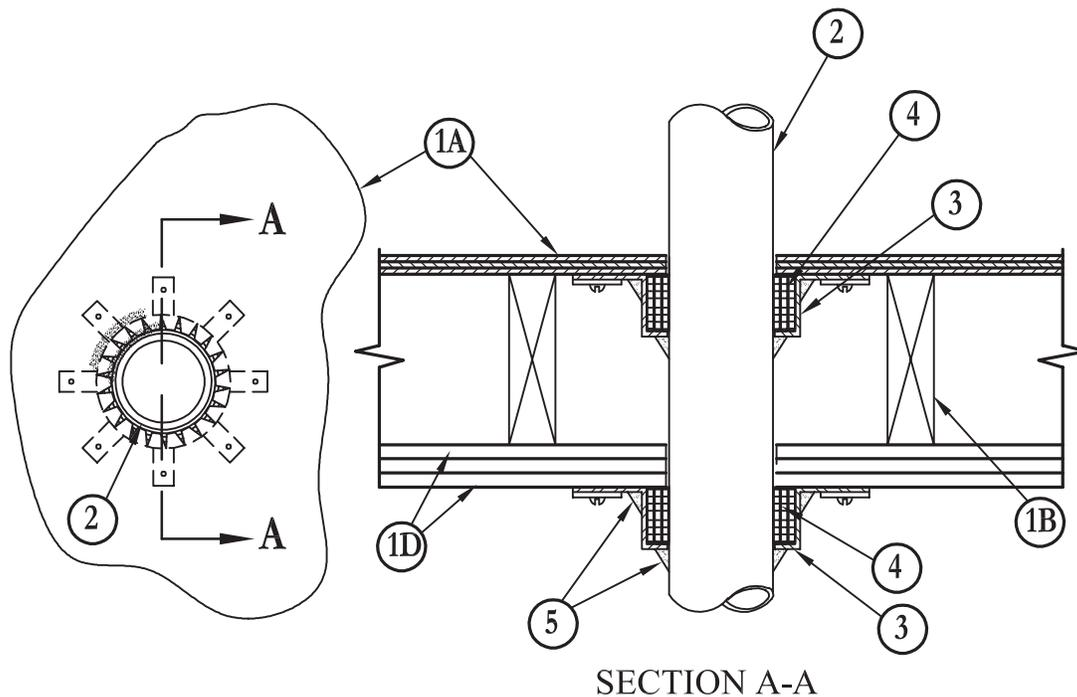

SECTION A-A

- Floor-Ceiling Assembly** – The fire-rated wood joist floor-ceiling assembly shall be constructed of the materials and in the manner specified in Design No. L505, L511 or L536 in the UL Fire Resistance Directory, as summarized below:
 - Flooring System** – Lumber or plywood subfloor with finish floor of lumber, plywood or **Floor Topping Mixture*** as specified in the individual Floor-Ceiling Design. Max diam of opening in flooring is 4-3/4 in. (121 mm).
 - Wood Joists** – Nom 2 by 10 in. (51 by 254 mm) lumber joists spaced 16 in. OC with nom 1 by 3 in. (25 by 76 mm) lumber bridging and with ends firestopped.
 - Furring Channels** – (Not shown) – Resilient galv steel furring channels installed perpendicular to wood joists between first and second layers of wallboard (Item 1D) and spaced max 24 in (610 mm) OC.
 - Gypsum Board*** – Nom 4 ft (122 cm) wide by 5/8 in. (16 mm) thick as specified in the individual Floor-Ceiling Design. First layer of gypsum board nailed to wood joists. Second layer of gypsum board screw-attached to furring channels. The secondary firestop system (Items 3, 4 and 5) must be installed in the joist cavity prior to installation of the gypsum board ceiling.
- Nonmetallic Pipe** – Nom 4 in. (102 mm) diam (or smaller) Schedule 40 solid core polyvinyl chloride (PVC) pipe for use in closed (process or supply) or vented (drain, waste, vent) piping systems or nom 4 in. (102 mm) diam (or smaller) SDR 13.5 chlorinated polyvinyl chloride (CPVC) pipe for use in closed (process or supply) piping systems. Diam of circular openings hole-sawed through flooring system and through two-layer gypsum board ceiling to be no greater than 1/8 in. (3.2 mm) larger than outside diam of pipe. Pipe to be installed approx midway between wood joists and centered in circular openings.
- Fill, Void, or Cavity Materials* – Wrap Strip** – Nom 1/4 in. (6 mm) thick intumescent elastomeric material faced on one side with aluminum foil, supplied in 2 in. (51 mm) wide strips. Nom 2 in. (51 mm) wide strips tightly wrapped around nonmetallic pipe (foil side exposed) with the edges butted against the underside of the subfloor (secondary firestop system) and against the finished gypsum wallboard ceiling (primary firestop system). Wrap strips for primary and secondary firestop systems to be installed identically. For nom 1/2 in. to nom 2 in. (13 to 51 mm) diam pipes, a min of one layer of wrap strip is required. For nom 2-1/2 in. and nom 3 in. (64 mm and 76 mm) diam pipes, a min of two layers of wrap strip is required. For nom 3-1/2 in. and nom 4 in. (89 mm and 102 mm) diam pipes, a min of three layers of wrap strip is required. Each layer of wrap strip to be installed with butted seam, with butted seams in successive layers staggered. Wrap strip layer(s) temporarily held in position using aluminum foil tape, steel wire tie, or equivalent.

3M COMPANY – Type FS-195+
- Steel Collar** – Nom 2 in. (51 mm) deep collar with 1-1/4 in. (32 mm) wide by 2 in. (51 mm) long anchor tabs and min 3/4 in. (19 mm) long tabs to retain wrap strip layers. Coils of precut 0.016 in. (.41 mm) thick (30 gauge) galv sheet steel available from wrap strip manufacturer. As an alternate, collar may be field-fabricated from min 0.016 in. (.41 mm) thick (30 gauge) galv sheet steel in accordance with instruction sheet supplied by wrap strip manufacturer. Steel collar, with anchor tabs bent outward 90 deg, wrapped tightly around wrap strip layers with min 1 in. (25 mm) overlap at the seam. With steel anchor tabs pressed tightly against the subfloor (secondary firestop system) or the finished gypsum wallboard ceiling (primary firestop system), compress collar around wrap strip layers using a min 1/2 in. (13 mm) wide by 0.028 in. (.71 mm) thick stainless steel band clamp with worm drive tightening mechanism at the collar midheight. As an alternate to the band clamps, collars may be secured by a means No 10 by 1/2 in. (13 mm) long sheet metal screws installed in the vertical axis at the center of the 1 in. (25 mm) overlap along the perimeter joint of the collar. A min of three screws is required.

System No. F-C-2002 *continued*

Secure collar to subfloor (secondary firestop system) using min 3/4 in. (19 mm) long steel screws in conjunction with 1-1/4 in. (32 mm) diam steel fender washers. Secure collar to finished gypsum wallboard ceiling (primary firestop system) using 3/16 in. (5 mm) diam steel toggle bolts (1-7/8 in. (48 mm) grip) in conjunction with 1-1/4 in. (32 mm) diam steel fender washers. Min of three fasteners, symmetrically located, required for nom 1/2 in. to nom 3 in. (13 mm to 76 mm) diam pipes. Min of four fasteners, symmetrically located, required for nom 3-1/2 in. and nom 4 in. (89 and 102 mm) diam pipes. As a final step, bend wrap strip retainer tabs 90 deg toward pipe to lock wrap strip layers in position.

5. **Fill, Void or Cavity Materials* – Caulk or Sealant** – Generous bead of caulk to be applied around the perimeter of the steel collar (Item 4) at its interface with the subfloor (secondary firestop system) and gypsum wallboard ceiling (primary firestop system). A nom 1/4 in. (6 mm) diam bead of caulk shall be applied around the perimeter of the nonmetallic pipe at its interface with the wrap strip layers.

3M COMPANY – CP 25 WB+, IC 15WB+, FireDam 150+ caulk or FB-3000 WT sealant.

(Note: CP 25WB+ and FireDam 150+ not suitable for use with CPVC pipes.)

6. **Firestop Device*** – (Not shown) – As an alternate to Items 3 and 4 for nom 1-1/2, 2, 3 or 4 in. (38, 51, 76, 102 mm) diam nonmetallic pipes, a firestop device consisting of a sheet-steel split collar lined with intumescent material and provided with steel clips for attachment may be used. Firestop device to be installed on underside of subfloor and against the finished gypsum wallboard ceiling in accordance with the accompanying installation instructions.

3M COMPANY – PPD 150, PPD 200, PPD 300, PPD 400

*Bearing the UL Classification Mark

Reprinted from the Online Certifications Directory with permission from Underwriters Laboratories Inc.

Copyright © 2010 Underwriters Laboratories Inc.®



Note: Systems with Nonmetallic Through Penetrant(s) have not been evaluated with a pressure differential of 50 Pa between the exposed and unexposed surfaces as required by the National Building Code of Canada.

System No. F-C-2008

May 20, 2005

F Rating – 1 Hr

T Rating – 1 Hr

L Rating At Ambient – 7 CFM/sq ft (See Item 3B)

L Rating At 400 F – Less Than 1 CFM/sq ft (See Item 3B)

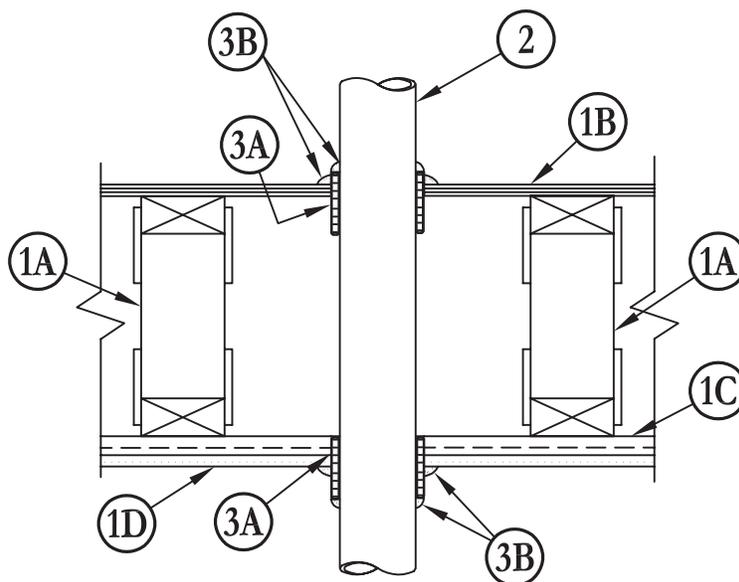

1. **Floor Assembly** – The fire rated wood truss or combination wood and steel truss Floor-Ceiling assembly shall be constructed of the materials and in the manner described in the individual L500 Series Design in the UL Fire Resistance Directory and shall include the following construction features:
 - A. **Trusses** – Min 12 in. (305 mm) deep parallel chord trusses fabricated from 2 by 4 in. (51 mm by 102 mm) lumber in conjunction with galv steel truss plates or **Structural Wood Members*** with bridging as required.
 - B. **Flooring** – Nom 3/4 in. (19 mm) thick plywood flooring with or without **Floor Topping Mixture***. Diam of hole-sawed opening in flooring to be 1/2 in. to 3/4 in. (13 mm to 19 mm) larger than diam of pipe. Max diam of opening in flooring is 3 in. (76 mm).
 - C. **Furring Channels** – Rigid or resilient galv steel furring channels installed perpendicular to bottom chord of trusses.
 - D. **Gypsum Board*** – Nom 4 ft (122 cm) wide by 5/8 in. (16 mm) thick, screw-attached to furring channels. Diam of hole-sawed opening in gypsum wallboard ceiling to be 1/2 in. to 3/4 in. (13 mm to 19 mm) larger than diam of pipe. Max diam of opening in ceiling is 3 in. (76 mm).
2. **Nonmetallic Pipe** – Nom 2 in. (51 mm) diam (or smaller) Schedule 40 polyvinyl chloride (PVC), SDR13.5 chlorinated polyvinyl chloride (CPVC) or solid-core Schedule 40 acrylonitrile-butadiene-styrene (ABS) pipe for use in closed (process or supply) or vented (drain, waste or vent) piping systems. One pipe to be installed approx midway between trusses and centered in circular openings in flooring and in ceiling. A nom 1/4 in. to 3/8 in. (6 mm to 10 mm) annular space is required in the firestop system. Pipe to be rigidly supported on both sides of Floor-Ceiling assembly.
- 2A. **Electrical Nonmetallic Tubing+** – Nom 1 in. (25 mm) diam (or smaller) corrugated wall ENT constructed of polyvinyl chloride. ENT to be installed as a complete system with all terminations in junction boxes, outlet boxes or other approved enclosures as specified in the National Electrical Code. Max one ENT per through opening. ENT to be centered in opening and rigidly supported on both sides of the Floor-Ceiling assembly.

See **Electrical Nonmetallic Tubing** (FKHU) category in Electrical Construction Materials Directory for names of manufacturers.
3. **Firestop System** – The details of the firestop system shall be as follows:
 - A. **Fill, Void or Cavity Materials* – Wrap Strip** – Nom 1/4 in. (6 mm) thick intumescent elastomeric material faced on one side with aluminum foil, supplied to 2 in. (51 mm) wide strips. Nom 2 in. (51 mm) wide strip tightly-wrapped around nonmetallic pipe (foil side exposed), secured with two steel tie wires and slid into hole-sawed opening in flooring (Item 1B) and in gypsum wallboard ceiling (Item 1D). Bottom edge of wrap strip to project 9/16 to 11/16 in. (14 mm to 17.5 mm) below bottom surface of flooring and below bottom (ceiling) surface of gypsum wallboard.

3M COMPANY – FS-195+
 - B. **Fill, Void or Cavity Materials* – Caulk, Sealant or Putty** – Nom 1/4 in. (6 mm) thickness of caulk or putty to be applied to the exposed edge of the wrap strip layer (top of flooring and bottom of gypsum wallboard ceiling). Generous application of caulk or putty to be applied to fill all gaps at the wrap strip/flooring and wrap strip/gypsum wallboard ceiling interfaces.

3M COMPANY – CP 25WB+ caulk, FB-3000 WT sealant or MP+ Stix putty.
(Note: L Ratings apply only when CP 25WB+ caulk or FB-3000 WT sealant is used. CP 25WB+ not suitable for use with CPVC pipes.)

*Bearing the UL Classification Marking

Reprinted from the Online Certifications Directory with permission from Underwriters Laboratories Inc.

Copyright © 2010 Underwriters Laboratories Inc.®



Note: Systems with Nonmetallic Through Penetrant(s) have not been evaluated with a pressure differential of 50 Pa between the exposed and unexposed surfaces as required by the National Building Code of Canada.

System No. F-C-2024

November 20, 2009

F Ratings – 1 and 2 Hr (See Item 1)

T Ratings – 0, 1, 1-1/2 and 2 Hr (See Item 3)

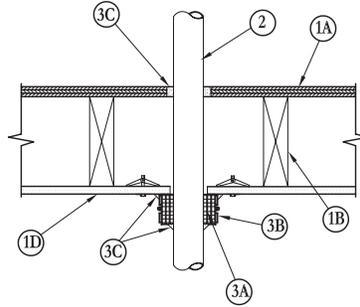

- Floor-Ceiling Assembly** – The 1 hr fire-rated solid or trussed lumber joist floor-ceiling assembly shall be constructed of the materials and in the manner specified in the individual L500 Series Floor-Ceiling Designs in the UL Fire Resistance Directory. The 2 hr fire-rated wood joist floor-ceiling assembly shall be constructed of the materials and in the manner specified in Design Nos. L505, L511 or L536 in the UL Fire Resistance Directory. **The F Rating of the firestop system is equal to the rating of the floor-ceiling assembly.** The general construction features of the floor-ceiling assembly are summarized below:
 - Flooring System** – Lumber or plywood subfloor with finish floor of lumber plywood or **Floor Topping Mixture*** as specified in the individual Floor-Ceiling Design.
 - Wood Joists*** – For 1 hr fire-rated floor-ceiling assemblies nom 10 in. (254 mm) deep (or deeper) lumber, steel or combination lumber and steel joists, trusses or **Structural Wood Members*** with bridging as required and with ends firestopped. For 2 hr fire-rated floor-ceiling assemblies, nom 2 by 10 in. (51 by 254 mm) lumber joists spaced 16 in. (406 mm) OC with nom 1 by 3 in. (25 by 76 mm) lumber bridging and with ends firestopped.
 - Furring Channels** – (Not Shown) – Resilient galv steel furring installed perpendicular to wood joists between first and second layers of wallboard (Item 1D) in 2 hr fire-rated assembly. Furring channels spaced max 24 in. (610 mm) OC.
 - Gypsum Board*** – Nom 4 ft (122 cm) wide by 5/8 in. (16 mm) thick as specified in the individual Floor-Ceiling Design. First layer of wallboard nailed to wood joists. Second layer of wallboard (2 hr fire-rated assembly) screw-attached to furring channels.
- Through Penetrants** – One nonmetallic pipe, conduit or tubing to be installed approx midway between wood joists. Diam of openings hole-sawed through flooring system and through two layers gypsum wallboard ceiling to be 0 to 1/4 in. (0 to 6 mm) larger than the outside diam of through-penetrant. Pipe or conduit to be rigidly supported on both sides of the floor-ceiling assembly. The following types and sizes of nonmetallic pipes or conduits may be used:
 - Polyvinyl Chloride (PVC) Pipe** – Nom 4 in. (102 mm) diam (or smaller) Schedule 40 solid-core PVC pipe for use in closed (process or supply) or vented (drain, waste or vent) piping system.
 - Cellular-Core Polyvinyl Chloride (ccPVC) Pipe** – Nom 4 in. (102 mm) diam (or smaller) Schedule 40 cellular core PVC pipe for use in closed (process or supply) or vented (drain, waste or vent) piping system.
 - Chlorinated Polyvinyl Chloride (CPVC) Pipe** – Nom 4 in. (102 mm) diam (or smaller) SDR13.5 CPVC pipe for use in closed (process or supply) piping systems.
 - Acrylonitrile Butadiene Styrene (ABS) Pipe** – Nom 4 in. (102 mm) diam (or smaller) Schedule 40 solid-core ABS pipe for use in closed (process or supply) or vented (drain, waste or vent) piping systems.
 - Cellular-Core Acrylonitrile Butadiene Styrene (ccABS) Pipe** – Nom 4 in. (102 mm) diam (or smaller) Schedule 40 cellular core ABS pipe for use in closed (process or supply) or vented (drain, waste or vent) piping systems.
- Firestop System** – The details of the firestop system shall be as follows:
 - Fill, Void or Cavity Materials* – Wrap Strip** – Nom 1/4 in. (6 mm) thick intumescent elastomeric material faced on one side with aluminum foil, supplied in 1 and 2 in. (25 and 51 mm) wide strips. Strips tightly wrapped around nonmetallic pipe (foil side exposed) with the edges butted against the bottom surface of the gypsum wallboard ceiling. The min wrap strip width, the number of layers of wrap strip required, the type of pipe and the nom diam, as well as the F and T Rating of the system are shown in the following table:

| Pipe Type | Nom Pipe Diam In. (mm) | F Rating Hr | T Rating Hr | Wrap Strip Width In. (mm) | Min Wrap Strip Layers |
|-------------------------------------|-------------------------|-------------|-------------|---------------------------|-----------------------|
| PVC, CPVC, ABS, ccPVC or ccABS (a) | 1/2 to 1-1/2 (13 to 38) | 1 | 1 | 1 (25) | 1 |
| PVC, CPVC, ABS, ccPVC, or ccABS (a) | 2 to 2-1/2 (51 to 64) | 1 | 1 | 1 (25) | 2 |
| PVC, CPVC, ABS, ccPVC or ccABS (a) | 3 (76) | 1 | 1 | 1 (25) | 3 |
| PVC, CPVC, ABS, ccPVC or ccABS (a) | 1/2 to 2 (13 to 51) | 1 | 1 | 2 (51) | 1 |
| PVC, CPVC, ABS or ccPVC | 2-1/2 to 4 (64 to 102) | 1 | 1 | 2 (51) | 2 |
| ccABS (a) | 2-1/2 to 3 (64 to 76) | 1 | 1/2 | 2 (51) | 2 |
| ccABS (a) | 3-1/2 to 4 (89 to 102) | 1 | 1/2 | 2 (51) | 3 |
| PVC, CPVC, ABS, or ccPVC | 1/2 to 1-1/2 (13 to 38) | 2 | 1-1/2 | 1 (25) | 1 |
| ccABS (a) | 1/2 to 1-1/2 (13 to 38) | 2 | 2 | 2 (51) | 2 |
| ABS, PVC, ccPVC, or CPVC | 1/2 to 2 (13 to 51) | 2 | 1-1/2 | 2 (51) | 1 |
| ABS, PVC, ccPVC or CPVC | 2-1/2 to 3 (64 to 76) | 2 | 1-1/2 | 2 (51) | 2 |
| ABS | 3-1/2 to 4 (89 to 102) | 2 | 1-1/2 | 2 (51) | 3 |
| PVC, ccPVC or CPVC | 3-1/2 to 4 (89 to 102) | 2 | 2 | 2 (51) | 3 |

(a) – Requires use of aluminum tape detailed in Item 3D

3M COMPANY – FS-195+

System No. F-C-2024 continued

- B. **Steel Collar** – Nom 2 in. (51 mm) deep collar with 1-1/4 in. (32 mm) wide by 2 in. (51 mm) long anchor tabs and min 3/4 in. (19 mm) long tabs to retain wrap strip layers. Coils of precut 0.016 in. (.41 mm) thick (30 gauge) galv sheet steel are available from wrap strip manufacturer. As an alternate, collar may be field fabricated from min 0.016 in. (.41 mm) thick (30 gauge) galv sheet steel in accordance with instruction sheet applied by wrap strip manufacturer. Steel collar, with anchor tabs bent outward 90 degrees, wrapped tightly around wrap strip layers with min 1 in. (25 mm) overlap at the seam. With steel anchor tabs pressed tightly against underside of gypsum wallboard ceiling, compress collar around wrap strip layers using a min 1/2 in. (13 mm) wide by 0.028 in. (.71 mm) thick stainless steel band clamp at the collar midheight. As an alternate to the band clamps, collars may be secured by a means No. 10 by 1/2 in. (13 mm) long sheet metal screws installed in the vertical axis at the center of the 1 in. (25 mm) overlap along the perimeter joint of the collar. A min of three screws is required.

Secure collar to gypsum wallboard ceiling using 3/16 in. (5 mm) diam steel toggle bolts (5/8 in. (16 mm) grip) in conjunction with 1-1/4 in. (32 mm) diam steel fender washers. Min of three fasteners, symmetrically located, required for nom 1/2 in. to nom 3 in. (13 mm to 76 mm) diam pipes. Min of four symmetrically located fasteners required for nom 3-1/2 in. and 4 in. (89mm and 102 mm) diam pipes. As a final step, bend wrap strip retainer tabs 90 degrees toward pipe to lock wrap strip layers in position.

- C. **Fill, Void or Cavity Materials* – Caulk or Sealant** – Generous application of caulk to be applied around the perimeter of the steel collar at its interface with the gypsum wallboard ceiling and around the perimeter of the pipe at its interface with the wrap strip layers. Caulk also applied around perimeter of pipe to fill annular space to max extent possible, flush with top surface of floor.

3M COMPANY – CP25 WB+, IC 15WB+ caulk, FireDam 150+ caulk or FB-3000 WT sealant.

(Note: CP 25WB+ and FireDam 150+ not suitable for use with CPVC pipes.)

- D. **Foil Tape** (not shown) – Nom 4 in. (102 mm) wide, 3 mil thick aluminum tape wrapped around pipe prior to the installation of the wrap strip (Item 3A). Min of one wrap, flush with the ceiling and proceeding downward. Tape is required only for nom 3-1/2 in. to 4 in. (89 mm to 102 mm) diam ABS pipes and for all ABS pipes.

- E. **Firestop Device*** – (Not Shown) – As an alternate to Item A and B when nom 1-1/2 in. (32 mm), 2 in. (51 mm), 3 in. (76 mm), or 4 in. (102 mm) diam nonmetallic pipes are used, a firestop device consisting of a sheet-steel split collar lined with intumescent material and provided with steel clips for attachment may be used in accordance with the table below. Firestop device to be installed on underside of ceiling in accordance with the accompanying installation instructions.

| Pipe Type | Nom Pipe Diam In. (mm) | F Rating Hr | T Rating Hr | Firestop Device |
|-------------------------------------|------------------------|-------------|-------------|--------------------|
| PVC, CPVC, ABS, ccPVC or ccABS (a) | 1-1/2 (32) | 1 | 1 | PPD 1.5 or PPD 150 |
| PVC, CPVC, ABS, ccPVC, or ccABS (a) | 2 (51) | 1 | 1 | PPD 2 or PPD 200 |
| PVC, CPVC, ABS, ccPVC or ccABS (a) | 3 (76) | 1 | 1 | PPD 3 or PPD 300 |
| PVC, CPVC, ABS, or ccPVC | 4 (102) | 1 | 1 | PPD 4 or PPD 400 |
| ccABS (a) | 2 (51) | 1 | 1/2 | PPD 200 |
| ccABS (a) | 3 (76) | 1 | 1/2 | PPD 300 |
| ccABS (a) | 4 (102) | 1 | 1/2 | PPD 400 |
| PVC, CPVC, ABS, or ccPVC | 1-1/2 (32) | 2 | 1-1/2 | PPD 1.5 or PPD 150 |
| ccABS (a) | 1-1/2 (32) | 2 | 2 | PPD 150 |
| ABS, PVC, ccPVC, or CPVC | 1-1/2 (32) | 2 | 1-1/2 | PPD 150 |
| ABS, PVC, ccPVC or CPVC | 2 (51) | 2 | 1-1/2 | PPD 200 |
| ABS, PVC, ccPVC, or CPVC | 3 (76) | 2 | 1-1/2 | PPD 300 |
| PVC, ccPVC or CPVC | 4 (102) | 2 | 2 | PPD 400 |
| ABS | 4 (102) | 2 | 1-1/2 | PPD 400 |

(a) – Requires use of aluminum tape detailed in Item 3D

*Bearing the UL Classification Marking

Reprinted from the Online Certifications Directory with permission from Underwriters Laboratories Inc.

Copyright © 2010 Underwriters Laboratories Inc.®



Note: Systems with Nonmetallic Through Penetrant(s) have not been evaluated with a pressure differential of 50 Pa between the exposed and unexposed surfaces as required by the National Building Code of Canada.

System No. F-C-2026

May 18, 2005

F Rating – 1 Hr

T Rating – 1 Hr

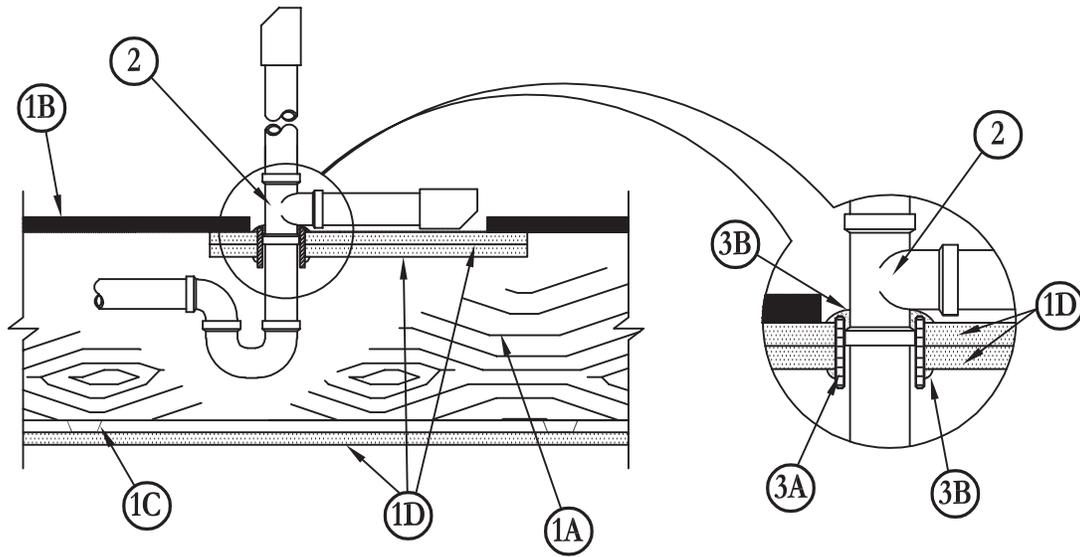

1. **Floor-Ceiling Assembly** – The fire-rated solid or trussed lumber joist Floor-Ceiling assembly shall be constructed of the materials and in the manner specified in the individual L500 Series Floor-Ceiling Designs in the UL Fire Resistance Directory and shall include the following construction features:
 - A. **Joists** – Nom 10 in. (254 mm) deep (or deeper) lumber, steel or combination lumber and steel joists, trusses or **Structural Wood Members*** with bridging as required and with ends firestopped.
 - B. **Flooring System** – Lumber or plywood subfloor with finish floor of lumber, plywood or **Floor Topping Mixture*** as specified in the individual Floor-Ceiling Design. Rectangular cutout in flooring to accommodate the bathtub drain piping (Item 2) to be max 8 by 12 in. (203 mm by 305 mm).
 - C. **Furring Channels** – Rigid or resilient galv steel furring channels installed perpendicular to joists.
 - D. **Gypsum Board*** – Nom 4 ft (122 cm) wide by 5/8 in. (16 mm) thick. Wallboard screw-attached to furring channels as specified in the individual Floor-Ceiling Design. Two pieces of gypsum wallboard, each min 4 in. (102 mm) longer and wider than the cutout in the flooring, screw-attached to bottom of flooring concentric with cutout. Diam of opening hole-sawed through both layers of the gypsum wallboard patch to be 1/2 in. to 5/8 in. (13 mm to 16 mm) larger than outside diam of bathtub drain piping (Item 2).
2. **Drain Piping** – Nom 1-1/2 in. (38 mm) diam Schedule 40 PVC pipe and drain fittings cemented together and provided with PVC bathtub waste/overflow fitting.
3. **Firestop System** – The details of the firestop system shall be as follows:
 - A. **Fill, Void or Cavity Materials* – Wrap Strip** – Nom 1/4 in. (6 mm) thick intumescent elastomeric material faced on one side with aluminum foil, supplied in 2 in. (51 mm) wide strips. Nom 2 in. (51 mm) wide strip tightly-wrapped around PVC drain piping (foil side exposed), secured with two steel wire ties, and slid into hole-sawed opening in gypsum wallboard patch (Item 1D). Bottom edge of wrap strip to project approx 1/2 in. (13 mm) below bottom surface of gypsum wallboard patch.
3M COMPANY – FS-195+
 - B. **Fill, Void or Cavity Materials* – Caulk or Sealant** – Nom 1/4 in. (6 mm) diam bead of caulk to be applied to perimeter of wrap strip at its egress from the underside of the gypsum wallboard patch. Nom 1/4 in. (6 mm) thickness of caulk to be applied to the exposed edge of the wrap strip layer and to fill all gaps between the wrap strip layer and the tee of the drain fitting on the top surface of the gypsum wallboard patch.
3M COMPANY – CP 25WB+, IC 15 WB+, FireDam 150+ caulk or FB-3000 WT sealant

*Bearing the UL Classification Marking

Reprinted from the Online Certifications Directory with permission from Underwriters Laboratories Inc.

Copyright © 2010 Underwriters Laboratories Inc.®



Note: Systems with Nonmetallic Through Penetrant(s) have not been evaluated with a pressure differential of 50 Pa between the exposed and unexposed surfaces as required by the National Building Code of Canada.

System No. F-C-2039

May 18, 2005

F Rating – 1 Hr

T Ratings – 0 & 1 Hr (See Item 2)

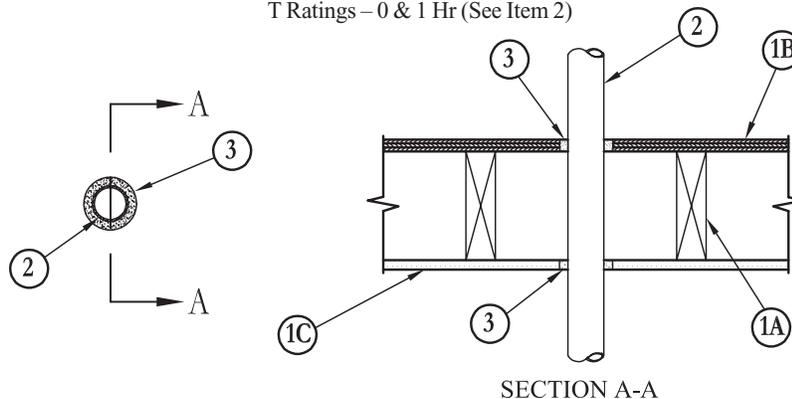

1. **Floor Assembly** – The 1 hr fire rated wood truss or combination wood and steel truss Floor-Ceiling assembly shall be constructed of the materials and in the manner described in the individual L500 Series Design in the UL Fire Resistance Directory, as summarized below:
 - A. **Joists** – Nom 10 in. (254 mm) deep (or deeper) lumber, steel or combination lumber and steel joists, trusses or **Structural Wood Members*** with bridging as required and ends firestopped.
 - B. **Flooring System** – Lumber or plywood subfloor with finish floor of lumber, plywood or **Floor Topping Mixture*** as specified in the individual Floor-Ceiling Design. Diameter of opening shall be 5/8 in. (16 mm) larger than the outside diam of nonmetallic pipe or conduit (Item 2).
 - C. **Gypsum Board*** – Nom a 4 ft (122 cm) wide by 5/8 in. (16 mm) thick, screw-attached to furring channels. Diameter of opening shall be 5/8 in. (16 mm) larger than the outside diam of nonmetallic pipe or conduit (Item 2).
 - 1.1 **Chase Wall** (Optional, not shown) – The through penetrants (Item 2) may be routed through a 1 hr fire-rated single, double or staggered wood stud/gypsum wallboard chase wall constructed of the materials and in the manner specified in the individual U300 Series Wall and Partition Designs in the UL Fire Resistance Directory and shall include the following construction features:
 - A. **Studs** – Nom 2 in. by 6 in. (51 mm by 152 mm) or double nom 2 in. by 4 in. (51 mm by 102 mm) lumber studs.
 - B. **Sole Plate** – Nom 2 in. by 6 in. (51 mm by 152 mm) or parallel 2 in. by 4 in. (51 mm by 102 mm) lumber plates, tightly butted.
 - C. **Top Plate** – The double top plate shall consist of two nom 2 in. by 6 in. (51 mm by 152 mm) or two sets of parallel 2 in. by 4 in. (51 mm by 102 mm) lumber plates, tightly butted. Diameter of opening shall be 5/8 in. (16 mm) larger than outside diam of nonmetallic pipe or conduit.
 - D. **Gypsum Board*** – Thickness, type, number of layers and fasteners shall be as specified in individual Wall and Partition Design.
 2. **Through Penetrants** – One nonmetallic pipe, tubing or conduit to be installed concentrically or eccentrically within the firestop system. Annular space between pipe, tubing or conduit and edge of opening to be min 0 in. (point contact) and max 5/8 in. (0 mm to max 16 mm). Pipe, tubing or conduit to be rigidly supported on both sides of floor-ceiling assembly. The following types and sizes of nonmetallic pipes, tubing or conduit may be used:
 - A. **Polyvinyl Chloride (PVC) Pipe** – Nom 1-1/2 in. (38 mm) diam (or smaller) Schedule 40 solid core PVC pipe for use in closed (process or supply) or vented (drain, waste or vent) piping system.
 - B. **Rigid Nonmetallic Conduit++** – Nom 1-1/2 in. (38 mm) diam (or smaller) Schedule 40 solid core PVC conduit installed in accordance with Article 347 of the National Electrical Code (NFPA No. 70).
 - C. **Chlorinated Polyvinyl Chloride (CPVC) Pipe** – Nom 1-1/2 in. (38 mm) diam (or smaller) SDR13.5 CPVC pipe for use in closed (process or supply) piping systems.
 - D. **Cellular Core Polyvinyl Chloride (ccPVC) Pipe** – Nom 1-1/2 in. (38 mm) diam (or smaller) Schedule 40 cellular core PVC pipe for use in closed (process or supply) or vented (drain, waste or vent) piping system.
 - E. **Acrylonitrile Butadiene Styrene (ABS) Pipe** – Nom 1-1/2 in. (38 mm) diam (or smaller) Schedule 40 solid core ABS pipe for use in closed (process or supply) or vented (drain, waste or vent) piping system.
 - F. **Cellular Core Acrylonitrile Butadiene Styrene (ccABS) Pipe** – Nom 1-1/2 in. (38 mm) diam (or smaller) Schedule 40 cellular core ABS pipe for use in closed (process or supply) or vented (drain, waste or vent) piping system.
 - G. **Crosslink Polyethylene (PGX) Tube** – Nom 1 in. (25 mm) diam (or smaller) SDR 9 PEX tube for use in closed (process or supply) piping system.
 - H. **Electrical Nonmetallic (ENT) Tubing+** – Nom 1-1/4 in. (32 mm) diam (or smaller) corrugated wall electrical nonmetallic tubing constructed of polyvinyl chloride. ENT to be installed as a complete system with all terminations in junction boxes, outlet boxes or other approved enclosures as specified in the National Electrical Code.
- The hourly T Rating is 1 Hr when pipes/conduits A, B, C, G or H are used. The hourly T Rating is 0 Hr when pipes D, E or F are used.**
3. **Fill, Void or Cavity Materials*** – **Caulk, Sealant or Putty** – Min 3/4 in. (19 mm) thickness of fill material applied within the annulus, flush with top surface of floor or sole plate. Min 5/8 in. (16 mm) thickness of fill material applied within the annulus, flush with bottom surface of ceiling or top plate. An additional min 1/4 in. (6 mm) crown of fill material applied to perimeter of penetrant at its egress from the top of flooring and underside of ceiling or from top of sole plate and underside of top plate.

3M COMPANY – CP 25WB+, IC 15WB+ caulk, FB-3000 WT sealant or MP+ Stix putty
(Note: CP 25WB+ not suitable for use with CPVC pipes.)

*Bearing the UL Classification Marking

++Bearing the UL Listing Mark

Reprinted from the Online Certifications Directory with permission from Underwriters Laboratories Inc.
Copyright © 2010 Underwriters Laboratories Inc.®



Note: Systems with Nonmetallic Through Penetrant(s) have not been evaluated with a pressure differential of 50 Pa between the exposed and unexposed surfaces as required by the National Building Code of Canada.

System No. F-C-2064

November 20, 2009

F Rating – 1 Hr

T Rating – 1 Hr

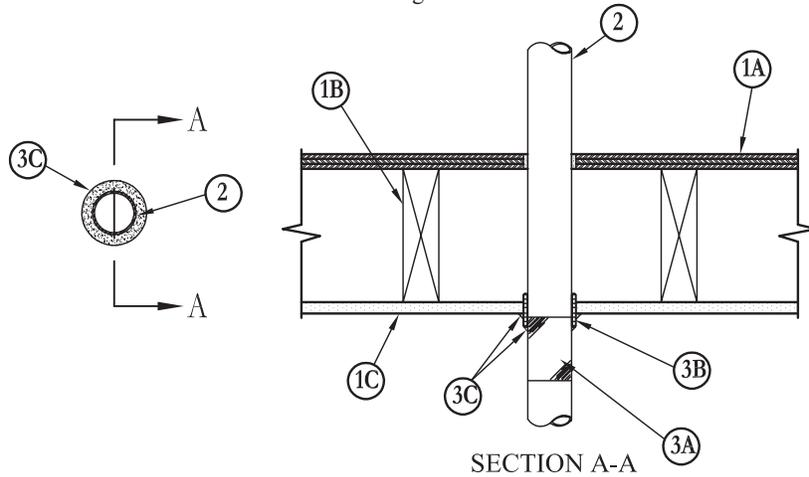

1. **Floor-Ceiling Assembly** – The 1 hr fire-rated solid or trussed lumber joist floor-ceiling assembly shall be constructed of the materials and in the manner specified in the individual L500 Series Floor-Ceiling Designs in the UL Fire Resistance Directory, as summarized below:
 - A. **Flooring System** – Lumber or plywood subfloor with finish floor of lumber, plywood or **Floor Topping Mixture*** as specified in the individual Floor-Ceiling Design. Max diam of floor opening is 4-1/2 in. (114 mm).
 - B. **Joists** – Nom 10 in. (254 mm) deep (or deeper) lumber, steel or combination lumber and steel joists, trusses or **Structural Wood Members*** with bridging as required and with ends firestopped.
 - C. **Gypsum Board*** – Nom 4 ft (122 cm) wide by 5/8 in. (16 mm) thick as specified in the individual Floor-Ceiling Design. Gypsum board nailed to wood joists. Max diam of ceiling opening is 4-1/2 in. (114 mm).
- 1.1 **Chase Wall** – (Optional, not shown) – The through penetrants (Item 2) may be routed through a 1 hr fire-rated single, double or staggered wood stud/gypsum wallboard chase wall constructed of the material and in the manner specified in the individual U300 Series Wall and Partition Designs in the UL Fire Resistance Directory and shall include the following construction features:
 - A. **Studs** – Nom 2 by 6 in. (51 by 152 mm) or double nom 2 by 4 in. (51 by 102 mm) lumber studs.
 - B. **Sole Plate** – Nom 2 by 6 in. (51 by 152 mm) or parallel 2 by 4 in. (51 by 102 mm) lumber plates, tightly butted.
 - C. **Top Plate** – The double top plate shall consist of two nom 2 by 6 in. (51 by 152 mm) or two sets of parallel 2 by 4 in (51 by 102 mm) lumber plates, tightly butted. Max diam of opening is 4-1/2 in. (114 mm).
 - D. **Gypsum Board*** – Thickness, type, number of layers and fasteners shall be as specified in individual Wall and Partition Design.
2. **Through Penetrants** – One nonmetallic pipe or conduit to be installed approx midway between wood joists. Diam of openings hole-sawed through flooring system and through gypsum board ceiling or top plates of optional chase wall to be 1/2 to 5/8 in. (13 mm to 16 mm) larger than the outside diam of through-penetrant. Pipe or conduit to be rigidly supported on both sides of the floor-ceiling assembly. The following types and sizes of nonmetallic pipes or conduits may be used:
 - A. **Polyvinyl Chloride (PVC) Pipe** – Nom 2 in. (51 mm) diam (or smaller) Schedule 40 solid core or cellular core PVC pipe for use in closed (process or supply) or vented (drain, waste or vent) piping system.
 - B. **Rigid Nonmetallic Conduit+** – Nom 2 in. (51 mm) diam (or smaller) Schedule 40 PVC conduit installed in accordance with Article 347 of the National Electrical Code (NFPA No. 70).
 - C. **Chlorinated Polyvinyl Chloride (CPVC) Pipe** – Nom 2 in. (51 mm) diam (or smaller) SDR13.5 CPVC pipe for use in closed (process or supply) piping systems.
 - D. **Acrylonitrile Butadiene Styrene (ABS) Pipe** – Nom 2 in. (51 mm) diam (or smaller) Schedule 40 solid core or cellular core ABS pipe for use in closed (process or supply) or vented (drain, waste or vent) piping systems.
3. **Firestop System** – The details of the firestop system shall be as follows:
 - A. **Foil Tape** – Nom 4 in. (102 mm) wide, 3 mil thick aluminum tape wrapped around pipe prior to the installation of the wrap strip (Item 3B). Min of one wrap, flush with the ceiling and extending downward.
 - B. **Fill, Void or Cavity Material*** – Nom 1/4 in. (6 mm) thick intumescent material supplied in 2 in. (51 mm) wide strips. One wrap strip tightly wrapped around perimeter of penetrant (foil side exposed) and held in position using two steel wire ties. wrap strip recessed into opening such that 1/2 to 3/4 in. (13 to 19 mm) extends below the bottom surface of the gypsum board ceiling or top plate when optional chase wall is used.

3M COMPANY – FS-195+
 - C. **Fill, Void or Cavity Materials* – Caulk or Sealant** – Min 5/8 in. (16 mm) thickness of caulk applied within annular space between wrap strip and periphery of opening flush with bottom surface of ceiling or top plate. Min 1/2 in. (13 mm) crown of caulk applied around the perimeter of the wrap strip at its interface with the gypsum board ceiling or top plate. Min 1/4 in. (6 mm) crown of caulk applied around the perimeter of penetrant at its interface with the wrap strip. Min 3/4 in. (19 mm) thickness of caulk applied to completely fill annular space, flush with top surface of floor.

3M COMPANY – CP 25WB+, IC 15WB+, FireDam 150+ caulk or FB-3000 WT sealant.
(Note: CP 25WB+ and FireDam 150+ not suitable for use with CPVC pipes.)

*Bearing the UL Classification Mark

Reprinted from the Online Certifications Directory with permission from Underwriters Laboratories Inc.
Copyright © 2011 Underwriters Laboratories Inc.®

System No. F-C-2115

June 23, 2015

F Ratings — 1 and 2 Hr (See Item 1)

T Ratings — 1 and 2 Hr (See Item 1)

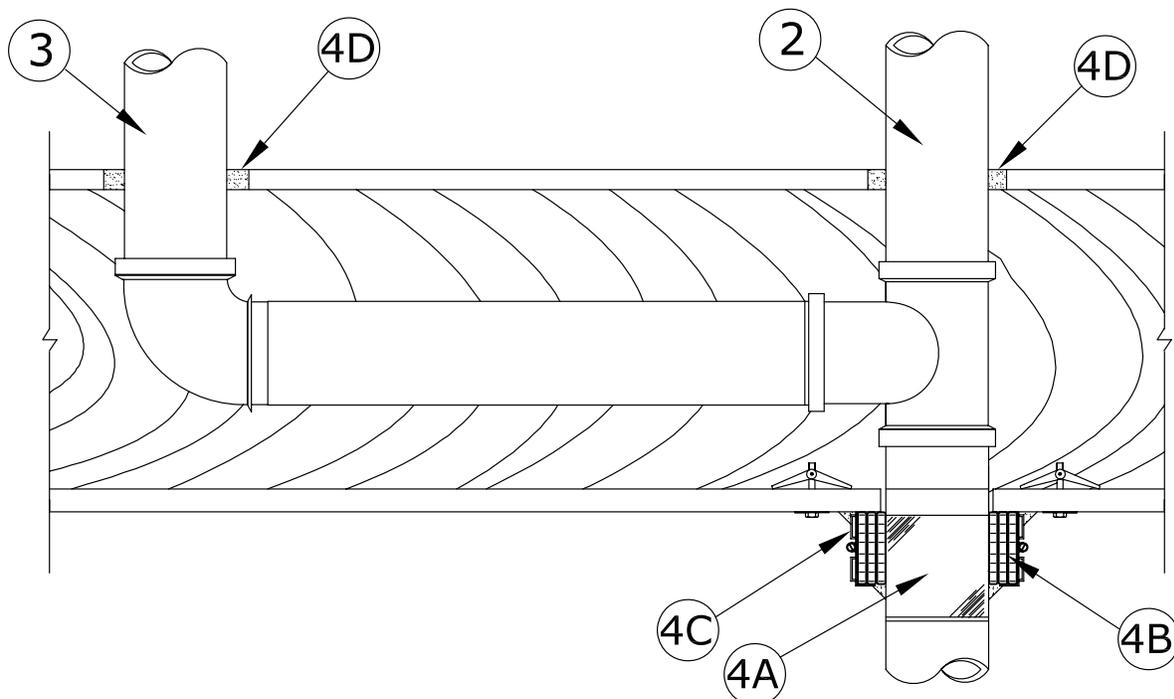

1. **Floor-Ceiling Assembly** — The 1 hr fire-rated solid or trussed lumber joist floor-ceiling assembly shall be constructed of the materials and in the manner specified in the individual L500 Series Design in the UL Fire Resistance Directory. The 2 hr fire-rated wood joist floor-ceiling assembly shall be constructed of the materials and in the manner specified in Design Nos. L505, L511 or L536 in the UL Fire Resistance Directory. **The F and T Ratings of the firestop system are equal to the rating of the floor-ceiling assembly.** The general construction features of the floor-ceiling assembly are summarized below:
 - A. **Flooring System** — Lumber or plywood subfloor with finish floor of lumber, plywood or **Floor Topping Mixture*** as specified in the individual Floor-Ceiling Design. Diameter of opening shall be max 1 in. (25 mm) larger than the nom diam of pipe (Items 2 and 3). As an option, the opening for the branch piping (Item 3) may be rectangular, 8 in. by 12 in. (203 by 305 mm) max for 1 hr rated assemblies only.
 - B. **Wood Joists** — For 1 hr fire-rated floor-ceiling assemblies, nom 10 in. (254 mm) deep (or deeper) lumber, steel or combination lumber and steel joists, trusses or **Structural Wood Members*** with bridging as required and with ends firestopped. For 2 hr fire-rated floor-ceiling assemblies, nom 2 by 10 in. (51 by 254 mm) lumber joists spaced 16 in. (406 mm) OC with nom 1 by 3 in. (25 by 76 mm) lumber bridging and with ends firestopped.
 - C. **Gypsum Board*** — Nom 4 ft (122 cm) wide by 5/8 in. (16 mm) thick, as specified in the individual Floor-Ceiling Design. First layer of gypsum board nailed to wood joists. Second layer of gypsum board (2 hr fire-rated assembly) screw-attached to furring channels. Diam of opening shall be max 1 in. (25 mm) larger than the nom diam of pipe (Item 2). Gypsum board plate for rectangular floor opening in 1 hr rated assemblies to be one or two piece, sized to overlap opening a min of 2 in. (51 mm) on all sides and shall be screw attached to underside of flooring with drywall or wood screws a max of 4 in. (102 mm) OC. Diam of opening to be 1 in. (25 mm) larger than nom diam of branch piping.
- 1.1 **Chase Wall** — (Optional, not shown) — The through penetrant (Item 2) may be routed through a 1 or 2 hr fire-rate single, double or staggered wood stud/gypsum board chase wall constructed of the materials and in the manner specified in the individual U300 Series Wall and Partition Designs in the UL Fire Resistance Directory and shall include the following construction features:
 - A. **Studs** — Nom 2 by 6 in. (51 by 152 mm) or double nom 2 by 4 in. (51 by 102 mm) lumber studs.
 - B. **Sole Plate** — Nom 2 by 6 in. (51 by 152 mm) or parallel 2 by 4 in. (51 by 102 mm) lumber plates, tightly butted. Diam of opening shall be max 1 in. (25 mm) larger than the nom diam of pipe (Item 2).
 - C. **Top Plate** — The double top plate shall consist of two nom 2 by 6 in. (51 by 152 mm) or two sets of parallel 2 by 4 in. (51 by 102 mm) lumber plates, tightly butted. Diam of opening shall be max 1 in. (25 mm) larger than the nom diam of pipe (Item 2).
 - D. **Gypsum Board*** — Thickness, type, number of layers and fasteners shall be as specified in individual Wall and Partition Design.
2. **Through Penetrant** — One nonmetallic pipe to be installed within the firestop system. Pipe to be rigidly supported on both sides of floor-ceiling assembly. The annular space between pipe and periphery of opening shall be min of 0 in. (point contact) to max 1/2 in. (0 to max 13 mm). Pipe may be installed with continuous point contact. The following types and sizes of nonmetallic pipes may be used:
 - A. **Polyvinyl Chloride (PVC) Pipe** — Nom 4 in. (102 mm) diam (or smaller) Schedule 40 solid core PVC pipe for use in closed (process or supply) or vented (drain, waste or vent) piping system.
 - B. **Cellular Core Polyvinyl Chloride (ccPVC) Pipe** — Nom 4 in. (102 mm) diam (or smaller) Schedule 40 cellular core PVC pipe for use in closed (process or supply) or vented (drain, waste or vent) piping system.
 - C. **Acrylonitrile Butadiene Styrene (ABS) Pipe** — Nom 4 in. (102 mm) diam (or smaller) Schedule 40 solid core ABS pipe for use in closed (process or supply) or vented (drain, waste or vent) piping system.
 - D. **Cellular Core Acrylonitrile Butadiene Styrene (ccABS) Pipe** — Nom 4 in. (102 mm) diam (or smaller) Schedule 40 cellular core ABS pipe for use in closed (process or supply) or vented (drain, waste or vent) piping system.

System No. F-C-2115 continued

Through Penetrations

Non-Metallic Pipes

2000 Series

Wood Frame Floor/Ceiling

FC

3. **Branch Piping** — (Optional) One nonmetallic pipe with or without nom 3 in. (76 mm) diam (or smaller) toilet flange (not shown) to be connected to through penetrant (Item 2) and installed within opening in subfloor or gypsum board plate. The annular space between pipe and periphery of opening shall be min 0 in. (point contact) to max 1/2 in. (0 to max 13 mm) Pipe may be installed with continuous point contact. Branch piping may terminate in a max 3 in. diam toilet flange, which corresponds to the type of branch piping. The following types and sizes of nonmetallic pipes may be used:
 - A. **Polyvinyl Chloride (PVC) Pipe** — Nom 3 in. (76 mm) diam (or smaller) Schedule 40 solid core PVC pipe for use in closed (process or supply) or vented (drain, waste or vent) piping system.
 - B. **Cellular Core Polyvinyl Chloride (ccPVC) Pipe** — Nom 3 in. (76 mm) diam (or smaller) Schedule 40 cellular core PVC pipe for use in closed (process or supply) or vented (drain, waste or vent) piping system.
 - C. **Acrylonitrile Butadiene Styrene (ABS) Pipe** — Nom 3 in. (76 mm) diam (or smaller) Schedule 40 solid core ABS pipe for use in closed (process or supply) or vented (drain, waste or vent) piping system.
 - D. **Cellular Core Acrylonitrile Butadiene Styrene (ccABS) Pipe** — Nom 3 in. (76 mm) diam (or smaller) Schedule 40 cellular core ABS pipe for use in closed (process or supply) or vented (drain, waste or vent) piping system.
4. **Firestop System** — The details of the firestop system shall be as follows:
 - A. **Foil Tape** — Nom 4 in. (102 mm) wide, 3 mil thick aluminum tape wrapped around pipe prior to the installation of the wrap strip (Item 4B). Min of one wrap, flush with the ceiling or top plate and proceeding downward. Not required when wrap strip Item 4B2 is used. Required only on pipes noted in table shown in Item 4B1.
 - B1. **Fill, Void or Cavity Materials* — Wrap Strip** — Nom 1/4 in. (6 mm) thick intumescent elastomeric material faced on one side with aluminum foil, supplied in 1 and 2 in. (25 and 51 mm) wide strips. Strips tightly wrapped around nonmetallic pipe (foil side exposed) with the edges butted against the bottom surface of the gypsum wallboard ceiling. The min wrap strip width and the number of layers of wrap strip required are dependent upon the type of pipe and the nom diam as shown in the following table:

| Pipe Type | Nom Pipe Diam, In. (mm) | Wrap Strip Width, In. (mm) | Min Wrap Strip Layers |
|-------------------------|-------------------------|----------------------------|-----------------------|
| PVC | 1/2 (13) to 1-1/2 (38) | 1 (25) | 1 |
| PVC | 2 (51) to 2-1/2 (64) | 1 (25) | 2 |
| PVC | 3 (76) | 1 (25) | 3 |
| ccPVC, ABS or ccABS (a) | 2 (51) | 1 (25) | 2 |
| ABS, PVC or ccPVC | 1/2 (13) to 2 (51) | 2 (51) | 1 |
| ABS, PVC or ccPVC | 2-1/2 (64) to 3 (76) | 2 (51) | 2 |
| PVC | 3-1/2 (89) to 4 (102) | 2 (51) | 3 |
| ABS (a) | 3-1/2 (89) to 4 (102) | 2 (51) | 3 |
| ccPVC | 3-1/2 (89) to 4 (102) | 2 (51) | 3 |
| ccABS (a) | 1/2 (13) to 2 (51) | 2 (51) | 1 |
| ccABS (a) | 2-1/2 (64) to 3 (76) | 2 (51) | 2 |
| ccABS (a) | 3-1/2 (89) to 4 (102) | 2 (51) | 3 |

(a) — Requires use of aluminum tape detailed in Item 4A.

3M COMPANY — FS-195+

- B2. **Fill, Void or Cavity Materials* — Wrap Strip** — (Alternate material to Item 4B1) Nom 1/8 in. (3.2 mm) thick intumescent material supplied in 2 in. (51 mm) wide strips. Wrap strip tightly wrapped around nonmetallic pipe with continuous layers and butted tightly against the bottom surface of the gypsum board ceiling or top plate. The min number of layers required is dependent upon the nom diam of the pipe and the hourly F Rating of the system. For 1 hr rated assemblies, the number of wrap strip layers are as follows. For nom 2 in. (51 mm) diam (and smaller) pipes, one layer is required. For nom 2-1/2 in. and 3 in. (64 and 76 mm) diam pipes, two layers are required. For nom 3-1/2 in. and 4 in. (89 and 102 mm) diam pipes, three layers are required. For 2 hr rated assemblies, the number of wrap strip layers are as follows. For nom 2 in. (51 mm) diam (and smaller) pipes, two layers are required. For nom 2-1/2 in. and 3 in. (64 and 76 mm) diam pipes, three layers are required. For nom 3-1/2 in. and 4 in. (89 and 102 mm) diam pipes, four layers are required.

3M COMPANY — Ultra GS

- C. **Steel Collar** — Nom 1 or 2 in. (25 or 51 mm) deep collar with 1-1/4 in. (32 mm) wide by 2 in. (51 mm) long anchor tabs and min 3/4 in. (19 mm) long tabs to retain wrap strip layers. Coils of precut min 0.016 in. (.41 mm) thick (28 gauge) galv sheet steel are available from wrap strip manufacturer. As an alternate, collar may be field fabricated from min 0.016 in. (.41 mm) thick (28 gauge) galv sheet steel in accordance with instruction sheet supplied by wrap strip manufacturer. Steel collar, with anchor tabs bent outward 90 degrees, wrapped tightly around wrap strip layers with min 1 in. (25 mm) overlap at the seam. A min 1/2 in. (13 mm) wide by min 0.028 in. (.71 mm) thick stainless steel band clamp secured around collar at midheight. As an alternate to the band clamp, collar for systems with three or more layers of wrap strip may be fastened together along the overlapping seam with three No. 6 by 3/8 in. (10 mm) long self-tapping steel screws. Collar secured to gypsum board ceiling using 3/16 in. (5 mm) diam steel toggle bolts (5/8 in. (16 mm) grip) in conjunction with 1-1/4 in. (32 mm) diam steel fender washers. Collar secured to top plate when chase wall is used using min 1 in. (25 mm) long No. 12 (or larger) steel wood screws in conjunction with 1-1/4 in. (32 mm) diam steel fender washers. Min of two fasteners, symmetrically located, required for nom 1/2 in. to nom 2 in. (13 mm to 51 mm) diam pipes. Min of three fasteners, symmetrically located, required for nom 2-1/2 in. to nom 3 in. (64 mm to 76 mm) diam pipes. Min of four symmetrically located fasteners required for nom 3-1/2 in. and 4 in. (89 mm and 102 mm) diam pipes. Wrap strip retainer tabs to be bent 90 degrees toward pipe to lock wrap strip layers in position.
- D. **Fill, Void or Cavity Materials* — Caulk or Sealant** — Min 3/4 in. (19 mm) thickness of caulk applied within annular space around perimeter of through penetrant and branch piping (Items 2 and 3), flush with top surface of floor. Min 1/2 in. (13 mm) diam bead applied at the pipe/floor interface and the pipe/gypsum board or plate interface and at the seams in the gypsum board plate.

System No. F-C-2115 *continued*

3M COMPANY — CP 25WB+, IC 15WB+, FireDam 150+ caulk or FB-3000 WT sealant. CP 25WB+ not suitable for use with CPVC pipes.

- E. **Firestop Device*** — As an alternate to Items 4B1, 4B2 and 4C, firestop device to be installed in accordance with the accompanying installation instructions. Firestop device to be installed and a latched around pipe and secured to underside of ceiling with Ultra Fast Anchors or with 3/16 in. (5 mm) diam steel toggle bolts (5/8 in. (16 mm) grip) in conjunction with 1-1/4 in. (32 mm) diam steel fender washers. Collar secured to top plate when chase wall is used with Ultra Fast Anchor Straps or 1/4 in. by 2 in. (6 by 51 mm) long steel screws in conjunction with 3/4 in. (19 mm) diam steel washers. Min of two fasteners, symmetrically located, required for nom 2 in. (51 mm) diam pipes. Min of three symmetrically located fasteners required for nom 3 in. (76 mm) diam pipes. Min of four symmetrically located fasteners required for nom 4 in. (102 mm) diam pipes.

3M COMPANY — Ultra RC Pack 2.0, 3.0, 4.0

- * Indicates such products shall bear the UL or cUL Certification Mark for jurisdictions employing the UL or cUL Certification (such as Canada), respectively.

Through Penetrations

Non-Metallic Pipes

2000 Series

Wood Frame Floor/Ceiling

FC

System No. F-C-2120

September 03, 2004

F Rating – 2 Hr

T Rating – 1 Hr

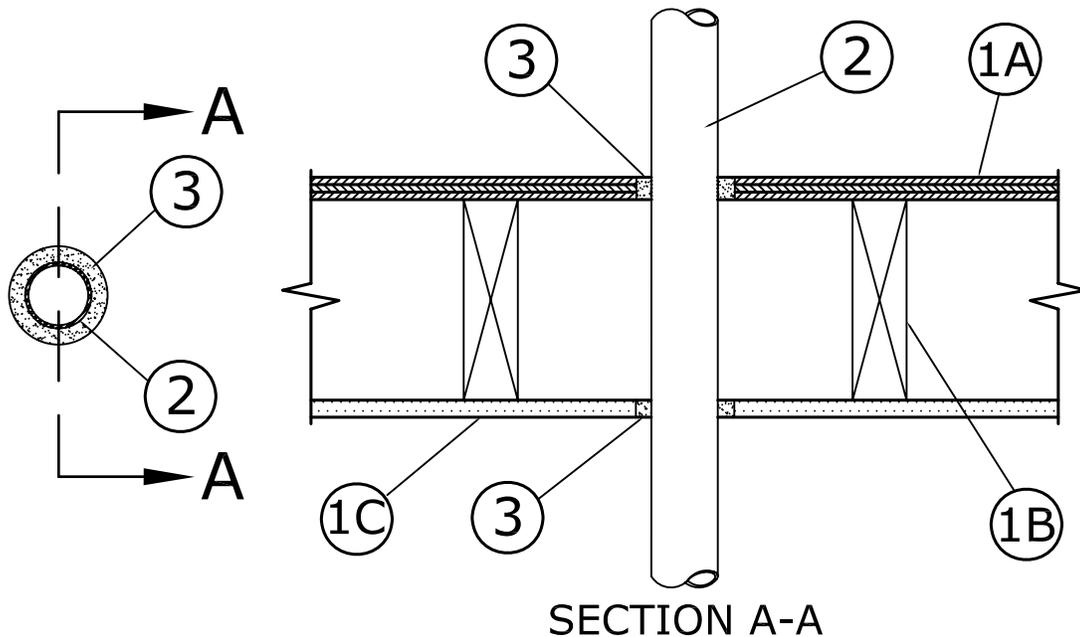

SECTION A-A

1. **Floor-Ceiling Assembly** – The 2 hr fire-rated wood joist floor-ceiling assembly shall be constructed of the materials and in the manner specified in the Design No. L505, L511 or L536 in the UL Fire Resistance Directory, as summarized below:
 - A. **Flooring System** – Lumber or plywood subfloor with finish floor of lumber, plywood or **Floor Topping Mixture*** as specified in the individual Floor-Ceiling Design. Max diam of opening in flooring is 1-3/4 in.
 - B. **Wood Joists** – Nom 2 by 10 in. lumber joists spaced 16 in. OC with nom 1 by 3 in. lumber bridging and with ends firestopped.
 - C. **Furring Channels** – (Not Shown) – Resilient galv steel furring installed perpendicular to wood joists between first and second layers of wallboard (Item 1D). Furring channels spaced max 24 in. OC.
 - D. **Gypsum Board*** – Nom 4 ft wide by 5/8 in. thick as specified in the individual Floor-Ceiling Design. First layer of wallboard nailed to wood joists. Second layer of wallboard screw-attached to furring channels. Max diam of ceiling opening is 1-3/4 in.
2. **Through Penetrant** – One nonmetallic pipe for use in closed (process or supply) or vented (drain, waste or vent) piping systems, centered within the firestop system. Pipe to be rigidly supported on both sides of the floor or wall assembly. The following type and size of nonmetallic pipe may be used:
 - A. **Polyethylene/Aluminum/Polyethylene Composite Pressure Pipe (PE-AL-PE)** – Nom 1 in. diam (or smaller) PE-AL-PE pipe. The annular space shall be 1/4 in.
 - B. **Crosslinked Polyethylene/Aluminum/Crosslinked Polyethylene Composite Pressure Pipe (PEX-AL-PEX)** – Nom 1 in. diam (or smaller) PEX-AL-PEX pipe. The annular space shall be 1/8 in.
3. **Firestop System** – The details of the firestop system shall consist of the following:
 - A. **Fill, Void or Cavity Material* – Caulk or Sealant** – At top of assembly, min 1/2 in. thickness of fill material applied within the annulus. Additional fill material to be installed such that a min 1/4 in. crown is formed around the through-penetrant on the top surface of the floor. At bottom of assembly, min 1-1/4 in. thickness of fill material applied within the annulus, flush with bottom surface of ceiling.

3M COMPANY — CP 25WB+ or FB-3000 WT

*Bearing the UL Classification Mark

Reprinted from the Online Certifications Directory with permission from UL

© 2012 UL LLC

System No. F-C-2121

September 03, 2004

F Rating – 1 Hr

T Rating – 1 Hr

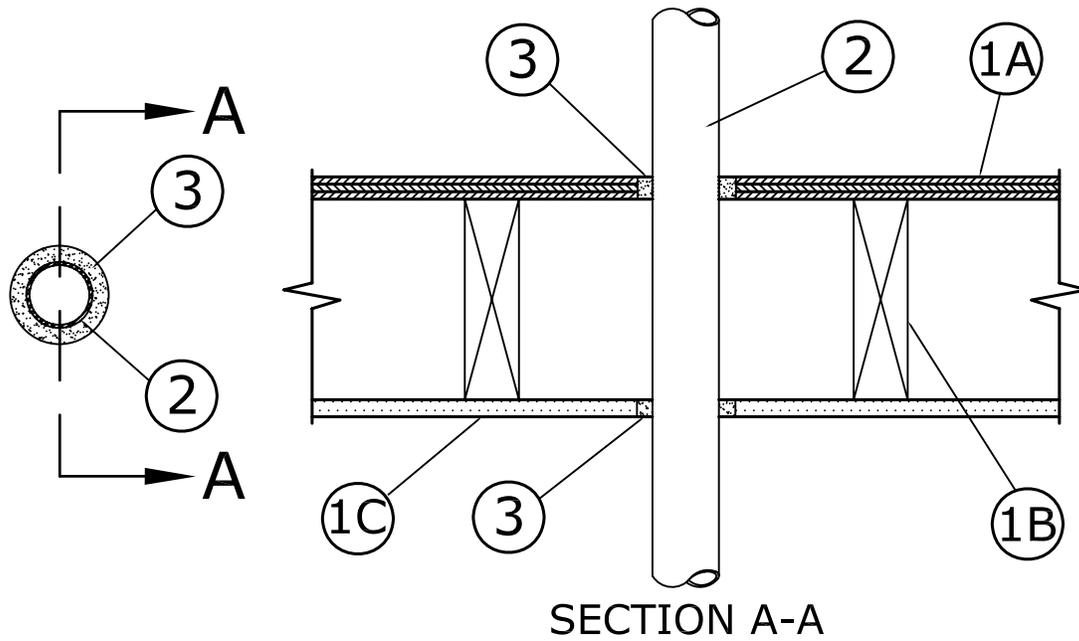

1. **Floor-Ceiling Assembly** – The fire-rated wood joist floor-ceiling assembly shall be constructed of the materials and in the manner specified in the individual L500 series Floor-Ceiling Designs in the UL Fire Resistance Directory, as summarized below:
 - A. **Flooring System** – Lumber or plywood subfloor with finish floor of lumber, plywood or **Floor Topping Mixture*** as specified in the individual Floor-Ceiling Design. Max diam of opening in flooring is 1-3/4 in.
 - B. **Wood Joists** – Nom 2 by 10 in. lumber joists spaced 16 in. OC with nom 1 by 3 in. lumber bridging and with ends firestopped.
 - C. **Gypsum Board*** – Nom 4 ft wide by 5/8 in. thick as specified in the individual Floor-Ceiling Design. First layer of wallboard nailed to wood joists. Second layer of wallboard screw-attached to joists through first layer. Max diam of opening in ceiling is 1-3/4 in.
2. **Through Penetrant** – One nonmetallic pipe for use in closed (process or supply) or vented (drain, waste or vent) piping system centered within the firestop system. Pipe to be rigidly supported on both sides of the floor or wall assembly. The following type and size of nonmetallic pipe may be used:
 - A. **Polyethylene/Aluminum/Polyethylene Composite Pressure Pipe (PE-AL-PE)** – Nom 1 in. diam (or smaller) PE-AL-PE pipe. The annular space shall be 1/4 in.
 - B. **Crosslinked Polyethylene/Aluminum/Crosslinked Polyethylene Composite Pressure Pipe (PEX-AL-PEX)** – Nom 1 in. diam (or smaller) PEX-AL-PEX pipe. The annular space shall be 1/8 in.
3. **Firestop System** – The details of the firestop system shall consist of the following:
 - A. **Fill, Void or Cavity Material* – Caulk or Sealant** – At top of assembly, min 1/2 in. thickness of fill material applied within the annulus. Additional fill material to be installed such that a min 1/4 in. crown is formed around the through-penetrant on the top surface of the floor. At bottom of assembly, min 1-1/4 in. thickness of fill material applied within the annulus, flush with bottom surface of ceiling.
3M COMPANY – CP 25WB+ or FB-3000 WT

*Bearing the UL Classification Mark

Reprinted from the Online Certifications Directory with permission from UL

© 2012 UL LLC

System No. F-C-2129

January 05, 2006

F Ratings – 1 And 2 Hr (See Item 1)

T Ratings – 1 And 2 Hr (See Item 1)

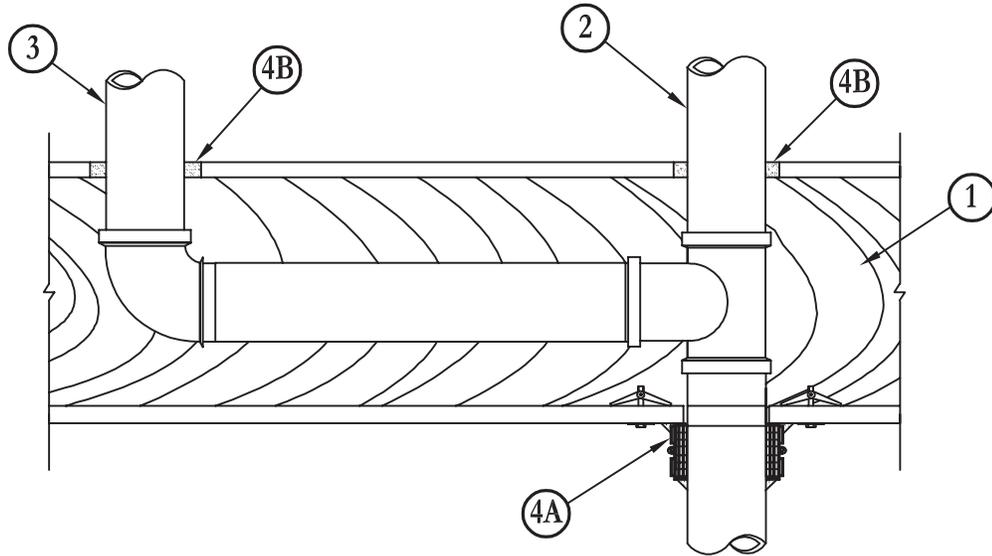

1. **Floor-Ceiling Assembly** – The 1 hr fire-rated solid or trussed lumber joist floor-ceiling assembly shall be constructed of the materials and in the manner specified in the individual L500 Series Floor-Ceiling Designs in the UL Fire Resistance Directory. The 2 hr fire-rated wood joist floor-ceiling assembly shall be constructed of the materials and in the manner specified in Design Nos. L505, L511 or L536 in the UL Fire Resistance Directory. **The F and T Ratings of the firestop system are equal to the rating of the floor-ceiling assembly.** The general construction features of the floor-ceiling assembly are summarized below:
 - A. **Flooring System** – Lumber of plywood subfloor with finish floor of lumber plywood or **Floor Topping Mixture*** as specified in the individual Floor-Ceiling Design. Diam of opening shall be 1 in. (25 mm) larger than nom diam of nonmetallic pipe or conduit (Item 2) and branch piping (Item 3).
 - B. **Wood Joists*** – For 1 hr fire-rated floor-ceiling assemblies nom 10 in. (254 mm) deep (or deeper) lumber, steel or combination lumber and steel joists, trusses or **Structural Wood Members*** with bridging as required and with ends firestopped. For 2 hr fire-rated floor-ceiling assemblies, nom 2 (51 mm) by 10 in. (254 mm) lumber joists spaced 16 in. (406 mm) OC with nom 1 by 3 in. (25 by 76 mm) lumber bridging and with ends firestopped.
 - C. **Furring Channels** – (Not Shown) – Resilient galv steel furring installed perpendicular to wood joists between first and second layers of wallboard (Item 1D) in 2 hr fire-rated assembly. Furring channels spaced max 24 in. (610 mm) OC.
 - D. **Gypsum Board*** – Nom 4 ft (122 cm) wide by 5/8 in. (16 mm) thick as specified in the individual Floor-Ceiling Design. First layer of gypsum board nailed to wood joists. Second layer of gypsum board (2 hr fire-rated assembly) screw-attached to furring channels. Diam of opening shall be 1 in. (25 mm) larger than nom diam of nonmetallic pipe or conduit (Item 2).
- 1.1 **Chase Wall** – (Optional, not shown) – The through penetrant (Item No. 2) may be routed through a 1 or 2 hr fire-rated single, double or staggered wood stud/gypsum board chase wall constructed of the materials and in the manner specified in the individual U300 Series Wall and Partition Designs in the UL Fire Resistance Directory and shall include the following construction features:
 - A. **Studs** – Nom 2 by 6 in. (51 by 152 mm) or double nom 2 by 4 in. (51 by 102 mm) lumber studs.
 - B. **Sole Plate** – Nom 2 by 6 in. (51 by 152 mm) or parallel 2 by 4 in. (51 by 102 mm) lumber plates, tightly butted.
 - C. **Top Plate** – The double top plate shall consist of two nom 2 by 6 in. (51 by 152 mm) or two sets of parallel 2 by 4 in. (51 by 102 mm) lumber plates, tightly butted. Diam of opening shall be 1 in. (25 mm) larger than the nom diam of nonmetallic pipe or conduit (Item 2).
 - D. **Gypsum Board*** – Thickness, type, number of layers and fasteners shall be as specified in individual Wall and Partition Design.
2. **Through Penetrant** – One nonmetallic pipe to be centered within the firestop system. Pipe to be rigidly supported on both sides of floor-ceiling assembly. The following types and sizes of nonmetallic pipes may be used:
 - A. **Polyvinyl Chloride (PVC) Pipe** – Nom 4 in. (102 mm) diam (or smaller) Schedule 40 solid core PVC pipe for use in closed (process or supply) or vented (drain, waste or vent) piping system.
 - B. **Cellular Core Polyvinyl Chloride (ccPVC) Pipe** – Nom 4 in. (102 mm) diam (or smaller) Schedule 40 cellular core PVC pipe for use in closed (process or supply) or vented (drain, waste or vent) piping system.
 - C. **Acrylonitrile Butadiene Styrene (ABS) Pipe** – Nom 4 in. (102 mm) diam (or smaller) Schedule 40 solid core ABS pipe for use in closed (process or supply) or vented (drain, waste or vent) piping system.
 - D. **Cellular Core Acrylonitrile Butadiene Styrene (ccABS) Pipe** – Nom 4 in. (102 mm) diam (or smaller) Schedule 40 cellular core ABS pipe for use in closed (process or supply) or vented (drain, waste or vent) piping systems.
3. **Branch Piping** – (Optional) One nonmetallic pipe connected to through penetrant (Item 2) and centered within opening in subfloor. The following types and sizes of nonmetallic pipes may be used:
 - A. **Polyvinyl Chloride (PVC) Pipe** – Nom 3 in. (76 mm) diam (or smaller) Schedule 40 solid core PVC pipe for use in closed (process or supply) or vented (drain, waste or vent) piping systems.

System No. F-C-2129 *continued*

- B. **Cellular Core Polyvinyl Chloride (ccPVC) Pipe** – Nom 3 in. (76 mm) diam (or smaller) Schedule 40 cellular core PVC pipe for use in closed (process or supply) or vented (drain, waste or vent) piping systems.
 - C. **Acrylonitrile Butadiene Styrene (ABS) Pipe** – Nom 3 in. (76 mm) diam (or smaller) Schedule 40 solid core ABS pipe for use in closed (process or supply) or vented (drain, waste or vent) piping systems.
 - D. **Cellular Core Acrylonitrile Butadiene Styrene (ccABS) Pipe** – Nom 3 in. (76 mm) diam (or smaller) Schedule 40 cellular core ABS pipe for use in closed (process or supply) or vented (drain, waste or vent) piping systems.
4. **Firestop System** – The details of the firestop system shall be as follows:
- A. **Firestop Device – Collar** – Collar to be installed in accordance with the accompanying installation instructions. Collar to be installed and latched around pipe and secured to underside of ceiling with 3M Ultra Fast Anchor Straps or with 1/4 in. diam by min 1-1/2 in. (6 mm by 38 mm) long steel toggle bolts in conjunction with min 1-1/4 in. (32 mm) diam steel fender washers. Min of two, three or four anchor straps or anchor bolts, symmetrically located, for nom 2 in. diam (and smaller), nom 3 in. diam and nom 4 in. (51 mm, 76 mm, 102 mm) diam pipes, respectively.
3M COMPANY – Ultra PPD 1.5, 2.0, 3.0 and 4.0
 - B. **Fill, Void or Cavity Materials* – Caulk or Sealant** – Min 3/4 in. (19 mm) thickness of caulk applied within annular space around perimeter of through penetrant and branch piping (Items 2 and 3), flush with top surface of floor.
3M COMPANY – CP 25WB+, IC 15WB+, FireDam 150+ caulk or FB-3000 WT sealant

*Bearing the UL Classification Marking

++Bearing the UL Listing Mark

Reprinted from the Online Certifications Directory with permission from Underwriters Laboratories Inc.
Copyright © 2011 Underwriters Laboratories Inc.®

System No. F-C-2134

XHEZ - Through-penetration Firestop Systems

June 23, 2015

F Rating — 1 Hr

T Rating — 0 Hr

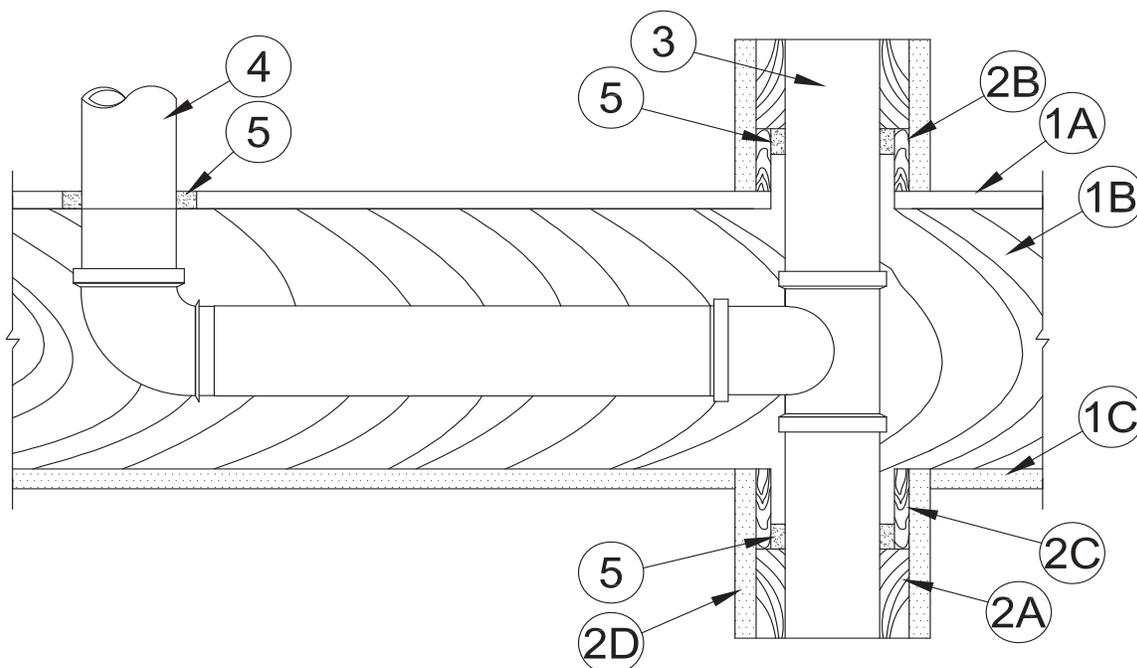

1. **Floor Assembly** — The 1 hr fire rated wood truss or combination wood and steel truss Floor-Ceiling assembly shall be constructed of the materials and in the manner described in the individual L500 Series Design in the UL Fire Resistance Directory, as summarized below:
 - A. **Flooring System** — Lumber or plywood subfloor with finish floor of lumber, plywood or **Floor Topping Mixture*** as specified in the individual Floor-Ceiling Design. Diam of opening shall be 1/2 in. to 1 in. (13 to 25 mm) larger than the outside diam of nonmetallic pipe (Items 3 and 4).
 - B. **Joists** — Nom 10 in. (254 mm) deep (or deeper) lumber, steel or combination lumber and steel joists, trusses or **Structural Wood Members*** with bridging as required and ends firestopped.
 - C. **Gypsum Board*** — Nom 4 ft (1.2 m) wide by 5/8 in. (16 mm) thick, attached as described in the individual Floor-Ceiling Design.
2. **Chase Wall** — The through penetrant (Item No. 3) shall be routed through a 1 hr fire-rated single, double or staggered wood studs/gypsum board chase wall constructed of the materials and in the manner specified in the individual U300 Series Wall and Partition Designs in the UL Fire Resistance Directory and shall include the following construction features:
 - A. **Studs** — Nom 2 by 4 in. (51 by 102 mm) or 2 by 6 in. (51 by 152 mm) lumber studs.
 - B. **Sole Plate** — Nom 2 by 4 in. (51 by 102 mm) or 2 by 6 in. (51 by 152 mm) lumber plates. Diam of opening or length of notch-out in sole plate to be 1/2 in. to 1 in. (13 to 25 mm) larger than outside diam of pipe.
 - C. **Top Plate** — The double top plate shall consist of two nom 2 by 4 in. (51 by 102 mm) or 2 by 6 in. (51 by 152 mm) lumber plates. Diam of opening or length of notch-out in top plate to be 1/2 in. to 1 in. (13 to 25 mm) larger than outside diam of pipe.
 - D. **Gypsum Board*** — Thickness, type, number of layers and fasteners shall be as specified in individual Wall and Partition Design.
3. **Through Penetrant** — One nonmetallic pipe to be installed within the firestop system. Pipe to be rigidly supported on both sides of floor-ceiling assembly. The annular space between pipe and periphery of opening shall be min 0 in. (point contact) to max 1/2 in. (0 to max 13 mm). The following types and sizes of nonmetallic pipes may be used:
 - A. **Polyvinyl Chloride (PVC) Pipe** — Nom 3 in. (76 mm) diam (or smaller) Schedule 40 solid core PVC pipe for use in closed (process or supply) or vented (drain, waste or vent) piping system.
 - B. **Cellular Core Polyvinyl Chloride (ccPVC) Pipe** — Nom 3 in. (76 mm) diam (or smaller) Schedule 40 cellular core PVC pipe for use in closed (process or supply) or vented (drain, waste or vent) piping system.
 - C. **Acrylonitrile Butadiene Styrene (ABS) Pipe** — Nom 3 in. (76 mm) diam (or smaller) Schedule 40 solid core ABS pipe for use in closed (process or supply) or vented (drain, waste or vent) piping system.
 - D. **Cellular Core Acrylonitrile Butadiene Styrene (ccABS) Pipe** — Nom 3 in. (76 mm) diam (or smaller) Schedule 40 cellular core ABS pipe for use in closed (process or supply) or vented (drain, waste or vent) piping system.
 - E. **Chlorinated Polyvinyl Chloride (CPVC) Pipe** — Nom 3 in. (76 mm) diam (or smaller) SDR13.5 CPVC pipe for use in closed (process or supply) piping systems.
4. **Branch Piping** — (Optional) - One nonmetallic pipe to be connected to through penetrant (Item 3) and installed within opening in subfloor . The annular space between pipe and periphery of opening shall be min 0 in. (point contact) to max 1/2 in. (13 mm) . The following types and sizes of nonmetallic pipes may be used:
 - A. **Polyvinyl Chloride (PVC) Pipe** — Nom 3 in. (76 mm) diam (or smaller) Schedule 40 solid core PVC pipe for use in closed (process or supply) or vented (drain, waste or vent) piping system.
 - B. **Cellular Core Polyvinyl Chloride (ccPVC) Pipe** — Nom 3 in. (76 mm) diam (or smaller) Schedule 40 cellular core PVC pipe for use in closed (process or supply) or vented (drain, waste or vent) piping system.
 - C. **Acrylonitrile Butadiene Styrene (ABS) Pipe** — Nom 3 in. (76 mm) diam (or smaller) Schedule 40 solid core ABS pipe for use in closed (process or supply) or vented (drain, waste or vent) piping systems.

Through Penetrations

Non-Metallic Pipes

2000 Series

Wood Frame Floor/Ceiling

FC

System No. F-C-2134 *continued*

D. Cellular Core Acrylonitrile Butadiene Styrene (ccABS) Pipe — Nom 3 in. (76 mm) diam (or smaller) Schedule 40 cellular core ABS pipe for use in closed (process or supply) or vented (drain, waste or vent) piping system.

5. Fill, Void or Cavity Materials* — Caulk or Sealant — Min 3/4 in. (19 mm) thickness of caulk applied within annular space around perimeter of through penetrant (Item 3), flush with top surface of floor or sole plate and flush with bottom surface of top plate. Min 3/4 in. (19 mm) thickness of caulk applied within annular space around perimeter of branch piping (Item 4), flush with top surface of floor. Min 1/2 in. (13 mm) diam bead applied at the pipe/floor interface and the pipe/ plate interface.

3M COMPANY — CP 25WB+ caulk, IC 15WB+ caulk or FB-3000 WT sealant. CP 25WB+ not suitable for use with CPVC pipes.

* Indicates such products shall bear the UL or cUL Certification Mark for jurisdictions employing the UL or cUL Certification (such as Canada), respectively.



Through Penetrations

Non-Metallic Pipes

2000 Series

Wood Frame Floor/Ceiling

FC

System No. F-C-2141

May 20, 2005
 F Rating – 1 Hr
 T Rating – 1 Hr

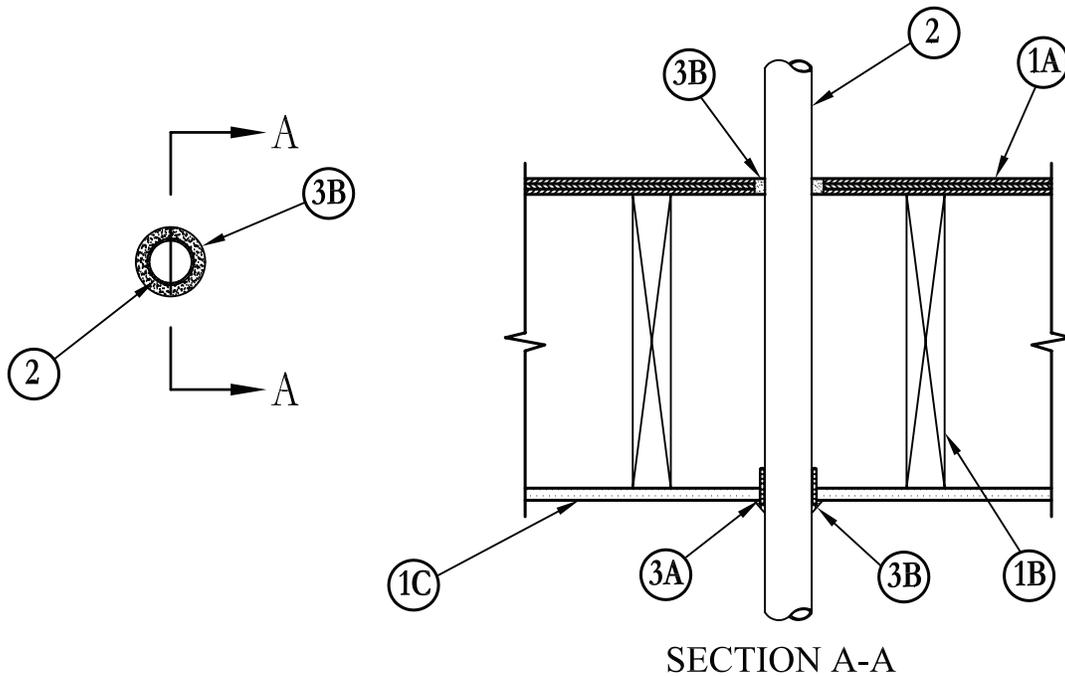

SECTION A-A

1. **Floor-Ceiling Assembly** – The fire-rated solid or trussed lumber joist floor-ceiling assembly shall be constructed of the materials and in the manner specified in the individual L500 Series Floor-Ceiling Designs in the UL Fire Resistance Directory, as summarized below:
 - A. **Flooring System** – Lumber or plywood subfloor with finish floor of lumber, plywood or **Floor Topping Mixture*** as specified in the individual Floor-Ceiling Design. Diam of opening shall be 3/4 in. (19 mm) larger than the nom diam of penetrant (Item 2).
 - B. **Joists** – Nom 10 in. (254 mm) deep (or deeper) lumber, steel or combination lumber and steel joists, trusses or **Structural Wood Members*** with bridging as required and with ends firestopped.
 - C. **Gypsum Board*** – Nom 4 ft (122 cm) wide by 5/8 in. (16 mm) thick as specified in the individual Floor-Ceiling Design. Wallboard nailed to wood joists. Diam of opening shall be 3/4 in. (19 mm) larger than the nom diam of penetrant (Item 2).
- 1.1 **Chase Wall** (Optional, not shown) – The through penetrants (Item No. 2) may be routed through a fire-rated single, double or staggered wood stud/gypsum wallboard chase wall constructed of the materials and in the manner specified in the individual U300 Series Wall and Partition Designs in the UL Fire Resistance Directory and shall include the following construction features:
 - A. **Studs** – Nom 2 by 6 in. (51 mm by 152 mm) or double nom 2 by 4 in. (51 mm by 102 mm) lumber studs.
 - B. **Sole Plate** – Nom 2 by 6 in. (51 mm by 152 mm) or parallel 2 by 4 in. (51 mm by 102 mm) lumber plates, tightly butted. Diam of opening shall be 3/4 in. (19 mm) larger than the nom diam of penetrant (Item 2).
 - C. **Top Plate** – The double top plate shall consist of two nom 2 by 6 in. (51 mm by 152 mm) or two sets of parallel 2 by 4 in. (51 mm by 102 mm) lumber plates, tightly butted. Diam of opening shall be 3/4 in. (19 mm) larger than the nom diam of penetrant (Item 2).
 - D. **Gypsum Board*** – Thickness, type, number of layers and fasteners shall be as specified in individual Wall and Partition Design.
2. **Through Penetrants** – One nonmetallic pipe or conduit to be installed either concentrically or eccentrically within the firestop system. Pipe or conduit to be rigidly supported on both sides of floor assembly. The annular space between pipe, conduit or tubing and periphery of opening shall be min of 1/8 in. to max 1/4 in. (3.2 mm to max 6 mm) The following types and sizes of nonmetallic pipes or conduits may be used:
 - A. **Polyvinyl Chloride (PVC) Pipe** – Nom 2 in. (51 mm) diam (or smaller) Schedule 40 solid core or cellular core PVC pipe for use in closed (process or supply) or vented (drain, waste or vent) piping system.
 - B. **Acrylonitrile Butadiene Styrene (ABS) Pipe** – Nom 2 in. (51 mm) diam (or smaller) Schedule 40 solid core or cellular core ABS pipe for use in closed (process or supply) or vented (drain, waste or vent) piping system.
 - C. **Rigid Nonmetallic Conduit++** – Nom 2 in. (51 mm) diam (or smaller) Schedule 40 PVC conduit installed in accordance with Article 347 of the National Electrical Code (NFPA No. 70).
 - D. **Chlorinated Polyvinyl Chloride (CPVC) Pipe** – Nom 2 in. (51 mm) diam (or smaller) SDR13.5 CPVC pipe for use in closed (process or supply) piping systems.
3. **Firestop System** – The details of the firestop system shall be as follows:
 - A. **Fill, Void or Cavity Materials* – Wrap Strip** – Nom 1/8 in. (3.2 mm) thick intumescent material supplied in 2 in. (51 mm) wide strips. One wrap strip tightly wrapped around perimeter of penetrant and held in position using 2 in. (51 mm) wide, 3 mil thick aluminum tape wrapped completely around wrap strip. Wrap strip recessed into opening such that 1/2 to 3/4 in. (13 mm to 19 mm) extends below the bottom surface of the gypsum wallboard ceiling or top plate when optional chase wall is used.

3M COMPANY – Ultra GS

System No. F-C-2141 *continued*

- B. **Fill, Void or Cavity Materials* – Caulk or Sealant** – Min 5/8 in. (16 mm) thickness of caulk applied within annular space between wrap strip and periphery of opening flush with bottom surface of ceiling or top plate. Min 1/4 in. (6 mm) crown of caulk applied around the perimeter of the wrap strip at its interface with the gypsum wallboard ceiling or top plate. Min 3/4 in. (19 mm) thickness of caulk applied to completely fill annular space, flush with top surface of floor.

3M COMPANY – CP 25WB+ caulk or FB-3000 WT sealant

(Note: CP 25WB+ not suitable for use with CPVC pipes.)

++Bearing the UL Listing Mark

*Bearing the UL Classification Mark

Reprinted from the Online Certifications Directory with permission from Underwriters Laboratories Inc.

Copyright © 2011 Underwriters Laboratories Inc.®

Through Penetrations

Non-Metallic Pipes

2000 Series

Wood Frame Floor/Ceiling

FC

System No. F-C-2240

May 18, 2005

F Rating – 1 Hr

T Rating – 1 Hr

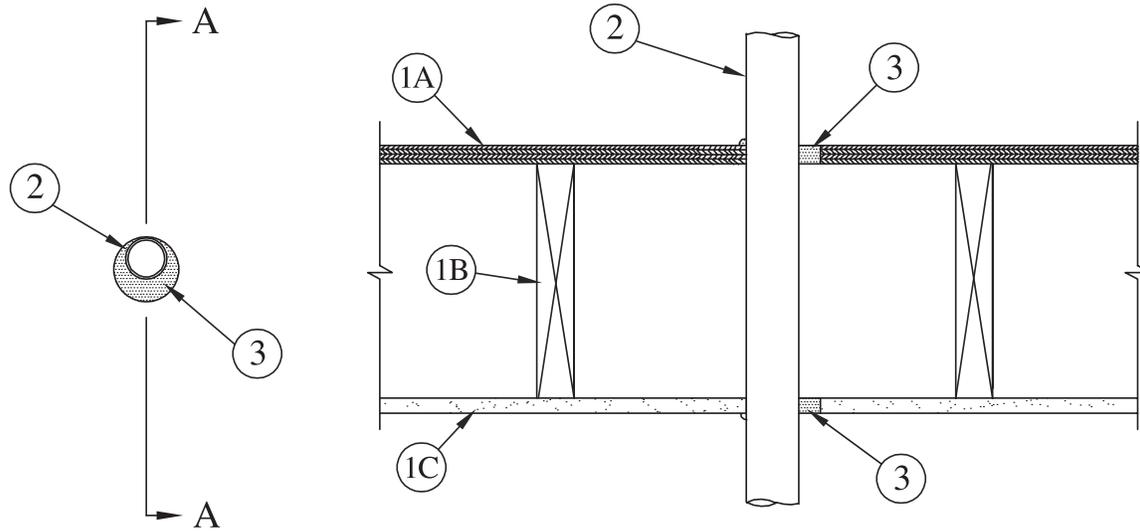

SECTION A-A

1. **Floor-Ceiling Assembly** – The 1 hr fire-rated solid or trussed lumber joist floor-ceiling assembly shall be constructed of the materials and in the manner specified in the individual L500 Series Floor-Ceiling Designs in the UL Fire Resistance Directory. The general construction details of the floor-ceiling assembly are summarized below:
 - A. **Flooring System** – Lumber or plywood subfloor with finish floor of lumber, plywood or **Floor Topping Mixture*** as specified in the individual Floor-Ceiling Design. Max diam of opening is 2 in. (51 mm).
 - B. **Wood Joists** – Nom 10 in. (254 mm) deep (or deeper) lumber, steel or combination lumber and steel joists, trusses or **Structural Wood Members*** with bridging as required and with ends firestopped.
 - C. **Gypsum Board*** – Nom 4 ft (122 cm) wide by 5/8 in. (16 mm) thick as specified in the individual Floor-Ceiling Design. Max diam of opening is 2 in. (51 mm).
- 1.1 **Chase Wall** (Optional, not shown) – The through penetrants (Item No. 2) may be routed through a fire-rated single, double or staggered wood stud/gypsum board chase wall having a fire rating consistent with that of the floor-ceiling assembly. The chase wall shall be constructed of the materials and in the manner specified in the individual U300 Series Wall and Partition Designs in the UL Fire Resistance Directory and shall include the following construction features:
 - A. **Studs** – Nom 2 in. by 6 in. (51 mm by 152 mm) or double nom 2 in. by 4 in. (51 mm by 102 mm) lumber studs.
 - B. **Sole Plate** – Nom 2 in. by 6 in. (51 mm by 152 mm) or parallel 2 in. by 4 in. (51 mm by 102 mm) lumber plates, tightly butted. Max diam of opening is 2 in. (51 mm).
 - C. **Top Plate** – The double top plate shall consist of two nom 2 in. by 6 in. (51 mm by 152 mm) or two sets of parallel 2 by 4 in. 2 in. by 4 in. (51 mm by 102 mm) lumber plates, tightly butted. Max diam of opening is 2 in. (51 mm).
 - D. **Gypsum Board*** – Thickness, type, number of layers and fasteners shall be as specified in individual Wall and Partition Design.
2. **Crosslinked Polyethylene (PEX) Tubing** – One nom 1 in. (25 mm) diam (or smaller) SDR 9 PEX tubing for use in closed (process or supply) piping systems. Tubing installed concentrically or eccentrically within opening. Annular space between tubing and periphery of opening to be min 0 in. (point contact) to max 3/4 in. (0 mm to max 19 mm). Tubing to be rigidly supported on both sides of floor-ceiling.
3. **Fill, Void or Cavity Materials* – Caulk or Sealant** – Min 3/4 in. (19 mm) thickness of caulk applied within annulus, flush with top surface of floor or sole plate. Min 5/8 in. (16 mm) thickness of caulk applied within annulus, flush with bottom surface of ceiling or top plate. Min 1/4 in. (6 mm) diam bead of caulk applied at point contact locations at tubing/floor or sole plate interface on top surface of floor or sole plate and at tubing/ceiling or top plate interface.

3M COMPANY – IC 15WB+, CP 25WB+ caulk or FB-3000 WT sealant

*Bearing the UL Classification Marking

Reprinted from the Online Certifications Directory with permission from Underwriters Laboratories Inc.
Copyright © 2011 Underwriters Laboratories Inc.®

System No. F-C-2241

May 18, 2005

F Rating – 1 Hr

T Rating – 0 Hr

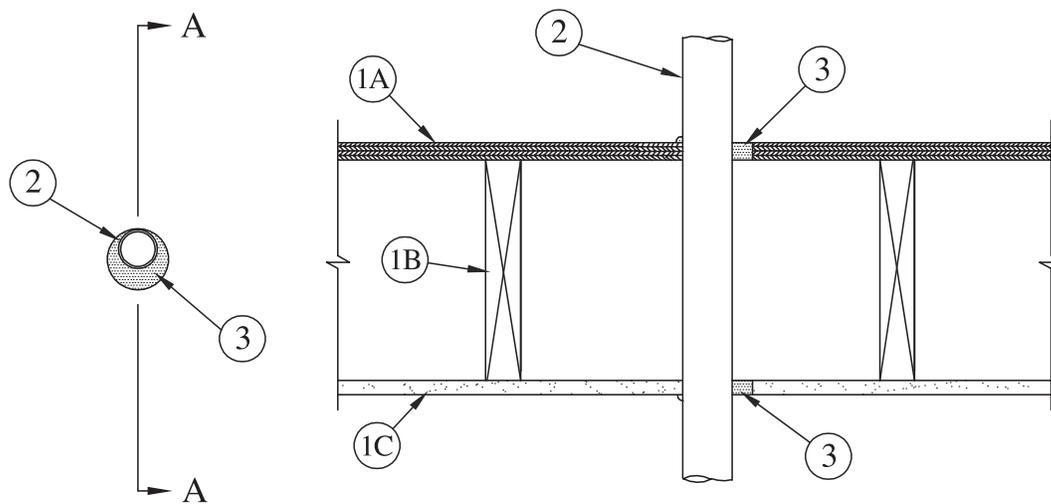

SECTION A-A

1. **Floor-Ceiling Assembly** – The 1 hr fire-rated solid or trussed lumber joist floor-ceiling assembly shall be constructed of the materials and in the manner specified in the individual L500 Series Floor-Ceiling Designs in the UL Fire Resistance Directory. The general construction details of the floor-ceiling assembly are summarized below:
 - A. **Flooring System** – Lumber or plywood subfloor with finish floor of lumber, plywood or **Floor Topping Mixture*** as specified in the individual Floor-Ceiling Design. Diam of opening shall min 5/8 in. (16 mm) to max 1-1/8 in. (29 mm) larger than nom pipe diam.
 - B. **Wood Joists** – Nom 10 in. (254 mm) deep (or deeper) lumber, steel or combination lumber and steel joists, trusses or **Structural Wood Members*** with bridging as required and with ends firestopped.
 - C. **Gypsum Board*** – Nom 4 ft (122 mm) wide by 5/8 in. (16 mm) thick as specified in the individual Floor-Ceiling Design. Diam of opening shall min 5/8 in. (16 mm) to max 1-1/8 in. (29 mm) larger than nom pipe diam.
- 1.1 **Chase Wall** – (Optional, not shown) - The through penetrants (Item No. 2) may be routed through a fire-rated single, double or staggered wood stud/gypsum board chase wall having a fire rating consistent with that of the floor-ceiling assembly. The chase wall shall be constructed of the materials and in the manner specified in the individual U300 Series Wall and Partition Designs in the UL Fire Resistance Directory and shall include the following construction features:
 - A. **Studs** – Nom 2 by 6 in. (51 by 152 mm) or double nom 2 by 4 in. (51 by 102 mm) lumber studs.
 - B. **Sole Plate** – Nom 2 by 6 in. (51 by 152 mm) or parallel 2 by 4 in. 51 by (102 mm) lumber plates, tightly butted. Diam of opening shall min 5/8 in. (16 mm) to max 1-1/8 in. (29 mm) larger than nom pipe diam.
 - C. **Top Plate** – The double top plate shall consist of two nom 2 by 6 in. (51 by 152 mm) or two sets of parallel 2 by 4 in. (51 by 102 mm) lumber plates, tightly butted. Diam of opening shall min 5/8 in. (16 mm) to max 1-1/8 in. (29 mm) larger than nom pipe diam.
 - D. **Gypsum Board*** – Thickness, type, number of layers and fasteners shall be as specified in individual Wall and Partition Design.
2. **Through Penetrants** – One nonmetallic pipe or conduit installed eccentrically or concentrically within opening. Annular space between penetrant and periphery of opening to be min 0 in. (point contact) to max 1-1/8 in. (0 to max 29 mm) Penetrant to be rigidly supported on both sides of wall. The following types and sizes of penetrants may be used:
 - A. **Polyvinyl Chloride (PVC) Pipe** – Nom 2 in. (51 mm) diam (or smaller) Schedule 40 solid core or cellular core PVC pipe for use in closed (process or supply) or vented (drain, waste or vent) piping systems.
 - B. **Chlorinated Polyvinyl Chloride (CPVC) Pipe** – Nom 2 in. (51 mm) diam (or smaller) SDR13.5 CPVC pipe for use in closed (process or supply) piping systems.
 - C. **Rigid Nonmetallic Conduit+** – Nom 2 in. (51 mm) diam (or smaller) Schedule 40 PVC conduit installed in accordance with Article 347 of the National Electrical Code (NFPA No. 70).
 - D. **Acrylonitrile Butadiene Styrene (ABS) Pipe** – Nom 1-1/2 in. (38 mm) diam (or smaller) Schedule 40 solid core or cellular core ABS pipe for use in closed (process or supply) or vented (drain, waste or vent) piping systems.
3. **Fill, Void or Cavity Materials* - Caulk or Sealant** – Min 3/4 in. (19 mm) thickness of caulk applied within annulus, flush with top surface of floor or sole plate. Min 5/8 in. (16 mm) thickness of caulk applied within annulus, flush with bottom surface of ceiling or top plate. Min 1/4 in. (6 mm) diam bead of caulk applied at point contact locations at penetrant/floor or sole plate interface on top surface of floor or sole plate and at penetrant/ceiling or top plate interface.

3M COMPANY – IC 15WB+, CP 25WB+ caulk or FB-3000 WT sealant
(Note: CP 25WB+ not suitable for use with CPVC pipes.)

*Bearing the UL Classification Mark

Reprinted from the Online Certifications Directory with permission from Underwriters Laboratories Inc.
Copyright © 2011 Underwriters Laboratories Inc.®

System No. F-C-2343

October 26, 2006

F Rating – 1 Hr

T Rating – 1 Hr

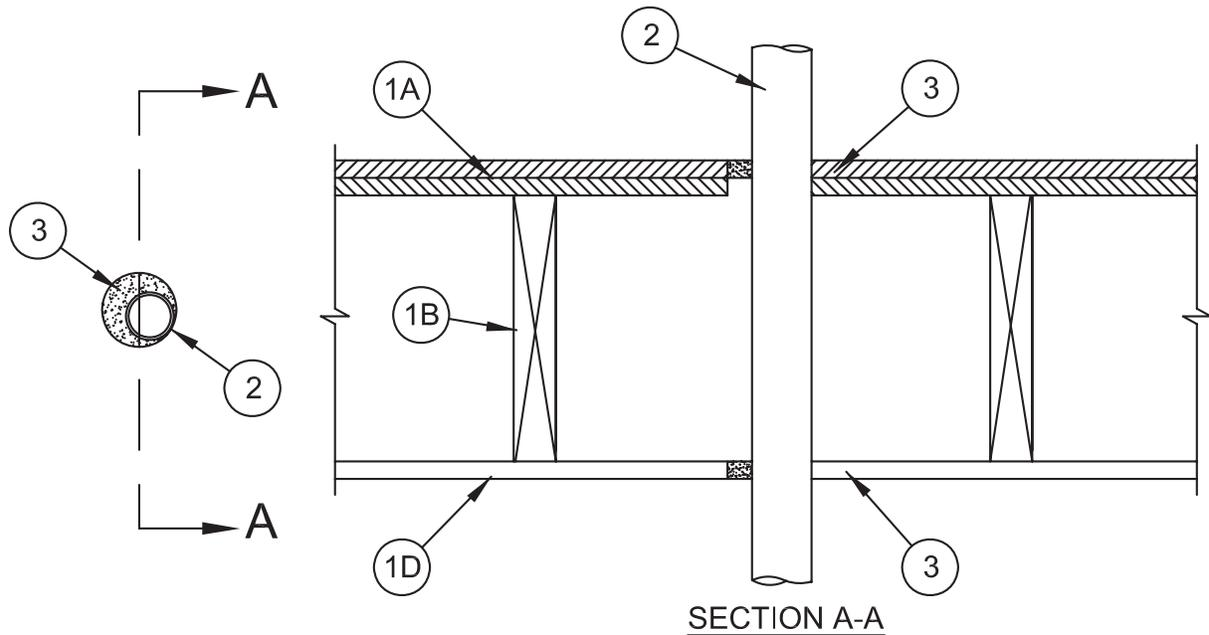

1. **Floor-Ceiling Assembly** – The 1 hr fire-rated solid or trussed lumber joist floor-ceiling assembly shall be constructed of the materials and in the manner specified in the individual L500 Series Floor-Ceiling Designs in the UL Fire Resistance Directory. The general construction details of the floor-ceiling assembly are summarized below:
 - A. **Flooring System** – Lumber or plywood subfloor with finish floor of lumber, plywood or **Floor Topping Mixture*** as specified in the individual Floor-Ceiling Design. Diam of opening shall be 1 in. (25 mm) larger than nom pipe diam. Max diam of opening is 1-1/2 in. (38 mm).
 - B. **Wood Joists** – Nom 10 in. (254 mm) deep (or deeper) lumber, steel or combination lumber and steel joists, trusses or **Structural Wood Members*** with bridging as required and with ends firestopped.
 - C. **Gypsum Board*** – Nom 4 ft (1.2 m) wide by 5/8 in. (16 mm) thick as specified in the individual Floor-Ceiling Design. Diam of opening shall be 1 in. (25 mm) larger than nom pipe diam. Max diam of opening is 1-1/2 in. (38 mm).
- 1.1. **Chase Wall** – (Optional, not shown) - The through penetrants (Item No. 2) may be routed through a fire-rated single, double or staggered wood stud/gypsum board chase wall having a fire rating consistent with that of the floor-ceiling assembly. The chase wall shall be constructed of the materials and in the manner specified in the individual U300 Series Wall and Partition Designs in the UL Fire Resistance Directory and shall include the following construction features:
 - A. **Studs** – Nom 2 by 6 in. (51 by 152 mm) or double nom 2 by 4 in. (51 by 102 mm) lumber studs.
 - B. **Sole Plate** – Nom 2 by 6 in. (51 by 152 mm) or parallel 2 by 4 in. (51 by 102 mm) lumber plates, tightly butted. Diam of opening shall be 1 in. (25 mm) larger than nom pipe diam. Max diam of opening is 1-1/2 in. (38 mm).
 - C. **Top Plate** – The double top plate shall consist of two nom 2 by 6 in. (51 by 152 mm) or two sets of parallel 2 by 4 in. (51 by 102 mm) lumber plates, tightly butted. Diam of opening shall be 1 in. (25 mm) larger than nom pipe diam. Max diam of opening is 1-1/2 in. (38 mm).
 - D. **Gypsum Board*** – Thickness, type, number of layers and fasteners shall be as specified in individual Wall and Partition Design.
2. **Crosslinked Polyethylene (PEX) Tubing** – Nom 1/2 in. (13 mm) diam (or smaller) SDR 9 PEX tubing for use in vented (drain, waste or vent) or closed (process or supply) piping systems. Tubing installed concentrically or eccentrically within opening. Annular space between tubing and periphery of opening to be min 0 in. (point contact) to max 7/8 in. (22 mm). Tubing to be rigidly supported on both sides of floor-ceiling assembly.
3. **Fill, Void or Cavity Materials* – Caulk** – Min 3/4 in. (19 mm) thickness of caulk applied within annulus, flush with top surface of floor or sole plate. Min 5/8 in. (16 mm) thickness of caulk applied within annulus, flush with bottom surface of ceiling or top plate. Min 1/4 in. (6 mm) diam bead of caulk applied at point contact locations at penetrant/floor or sole plate interface on top surface of floor or sole plate and at penetrant/ceiling or top plate interface on bottom surface of ceiling or top plate.

3M COMPANY – FD-150+, IC 15WB+, CP 25WB+, 1000 NS or FB-3000 WT sealant

*Bearing the UL Classification Mark

Reprinted from the Online Certifications Directory with permission from Underwriters Laboratories Inc.
Copyright © 2011 Underwriters Laboratories Inc.®

System No. F-C-2344

October 26, 2006

F Rating – 1 Hr

T Rating – 1/4 Hr

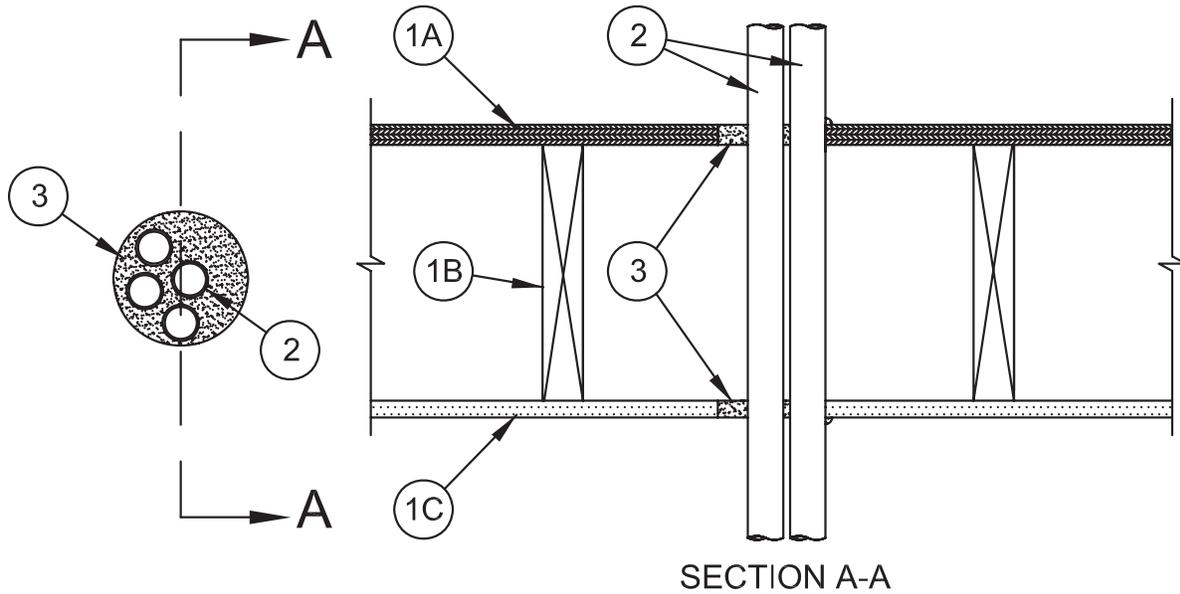

1. **Floor-Ceiling Assembly** – The 1 hr fire-rated solid or trussed lumber joist floor-ceiling assembly shall be constructed of the materials and in the manner specified in the individual L500 Series Floor-Ceiling Designs in the UL Fire Resistance Directory. The general construction details of the floor-ceiling assembly are summarized below:
 - A. **Flooring System** – Lumber or plywood subfloor with finish floor of lumber, plywood or **Floor Topping Mixture*** as specified in the individual Floor-Ceiling Design. Diam of opening shall be 1 in. (25 mm) larger than diam of pipe bundle. Max diam of opening is 2-1/2 in. (64 mm).
 - B. **Wood Joists** – Nom 10 in. (254 mm) deep (or deeper) lumber, steel or combination lumber and steel joists, trusses or **Structural Wood Members*** with bridging as required and with ends firestopped.
 - C. **Gypsum Board*** – Nom 4 ft (1.2 m) wide by 5/8 in. (16 mm) thick as specified in the individual Floor-Ceiling Design. Diam of opening shall be 1 in. (25 mm) larger than diam of pipe bundle. Max diam of opening is 2-1/2 in. (64 mm).
- 1.1. **Chase Wall** – (Optional, not shown) - The through penetrants (Item No. 2) may be routed through a fire-rated single, double or staggered wood stud/gypsum board chase wall having a fire rating consistent with that of the floor-ceiling assembly. The chase wall shall be constructed of the materials and in the manner specified in the individual U300 Series Wall and Partition Designs in the UL Fire Resistance Directory and shall include the following construction features:
 - A. **Studs** – Nom 2 by 6 in. (51 by 152 mm) or double nom 2 by 4 in. (51 by 102 mm) lumber studs.
 - B. **Sole Plate** – Nom 2 by 6 in. (51 by 152 mm) or parallel 2 by 4 in. (51 by 102 mm) lumber plates, tightly butted. Diam of opening shall be 1 in. (25 mm) larger than diam of pipe bundle. Max diam of opening is 2-1/2 in. (64 mm).
 - C. **Top Plate** – The double top plate shall consist of two nom 2 by 6 in. (51 by 152 mm), or two sets of parallel 2 by 4 in. (51 by 102 mm) lumber plates, tightly butted. Diam of opening shall be 1 in. (25 mm) larger than diam of pipe bundle. Max diam of opening is 2-1/2 in. (64 mm).
 - D. **Gypsum Board*** – Thickness, type, number of layers and fasteners shall be as specified in individual Wall and Partition Design.
2. **Crosslinked Polyethylene (PEX) Tubing** – Max two nom 1/2 in. (13 mm) diam (or smaller) SDR 9 PEX tubing and max two 3/4 in. (19 mm) for use in vented (drain, waste or vent) or closed (process or supply) piping systems. Tubing installed concentrically or eccentrically within opening. Annular space between tubing and periphery of opening to be min 0 in. (point contact) to max 7/8 in. (22 mm). Tubing to be rigidly supported on both sides of floor-ceiling assembly.
3. **Fill, Void or Cavity Materials*** – **Caulk** – Min 3/4 in. (19 mm) thickness of caulk applied within annulus, flush with top surface of floor or sole plate. Min 5/8 in. (16 mm) thickness of caulk applied within annulus, flush with bottom surface of ceiling or top plate. Min 1/4 in. (6 mm) diam bead of caulk applied at point contact locations at penetrant/floor or sole plate interface on top surface of floor or sole plate and at penetrant/ceiling or top plate interface on bottom surface of ceiling or top plate.

3M COMPANY – FD-150+, IC 15WB+, CP 25WB+, 1000 NS or FB-3000 WT sea lant

*Bearing the UL Classification Mark

Reprinted from the Online Certifications Directory with permission from Underwriters Laboratories Inc.
Copyright © 2011 Underwriters Laboratories Inc.®

System No. F-C-2349

July 30, 2009
 F Rating – 1 Hr
 T Rating – 1 Hr

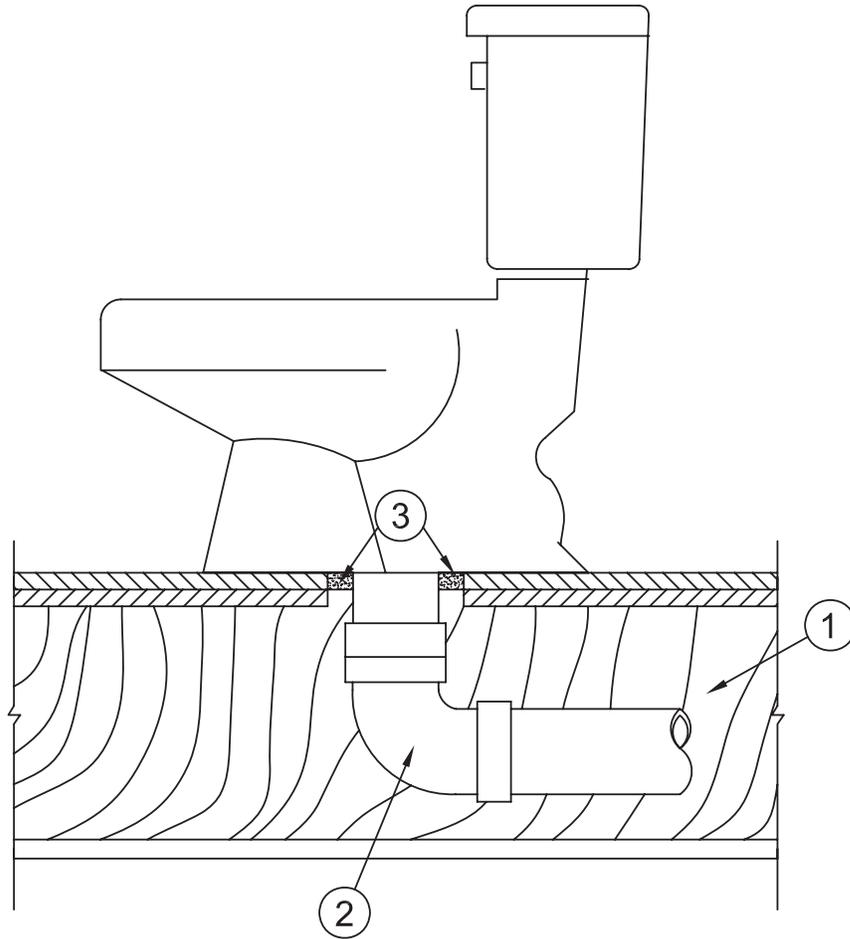

1. **Floor-Ceiling Assembly** – The 1 hr fire-rated solid or trussed lumber joist floor-ceiling assembly shall be constructed of the materials and in the manner specified in the individual L500 Series Floor-Ceiling Designs in the UL Fire Resistance Directory. The general construction details of the floor-ceiling assembly are summarized below:
 - A. **Flooring System** – Lumber or plywood subfloor with finish floor of lumber, plywood or **Floor Topping Mixture*** as specified in the individual Floor-Ceiling Design. Diam of opening shall be 1 in. (25 mm) larger than diam of pipe. Max diam of opening is 5-1/2 in. (140 mm).
 - B. **Wood Joists** – Nom 10 in. (254 mm) deep (or deeper) lumber, steel or combination lumber and steel joists, trusses or **Structural Wood Members*** with bridging as required and with ends firestopped.
 - C. **Gypsum Board*** – Nom 4 ft (1.2 m) wide by 5/8 in. (16 mm) thick as specified in the individual Floor-Ceiling Design.
2. **Nonmetallic Pipe** – One nonmetallic drain pipe with max 4 in. (102 mm) diam toilet flange installed within the firestop system. The annular space between drain pipe and periphery of opening shall be min 0 in. (point contact) to max 1 in. (25 mm). Pipe to be rigidly supported on lower side of floor assembly. Pipe to be rigidly supported on lower side of floor assembly. The following types and sizes of nonmetallic pipes, fittings and flanges may be used:
 - A. **Polyvinyl Chloride (PVC) Pipe** – Nom 4 in. (102 mm) diam (or smaller) Schedule 40 solid core or cellular core PVC pipe for use in vented (drain, waste or vent) piping system.
 - B. **Acrylonitrile Butadiene Styrene (ABS) Pipe** – Nom 4 in. (102 mm) diam (or smaller) Schedule 40 cellular core or solid core ABS pipe for use in vented (drain, waste or vent) piping systems.
3. **Fill, Void or Cavity Materials* – Caulk or Sealant** – Min 1/2 in. (13 mm) thickness of caulk applied within annular space around perimeter of pipe (Item 2), flush with top surface of floor.
3M COMPANY – IC 15WB+, CP 25WB+, FB-3000WT
4. **Water Closet** – Floor mounted vitreous china water closet.

*Bearing the UL Classification Mark

Reprinted from the Online Certifications Directory with permission from Underwriters Laboratories Inc.
 Copyright © 2011 Underwriters Laboratories Inc.®

System No. F-C-2350

June 13, 2007

F Rating – 1 Hr

T Rating – 1 Hr

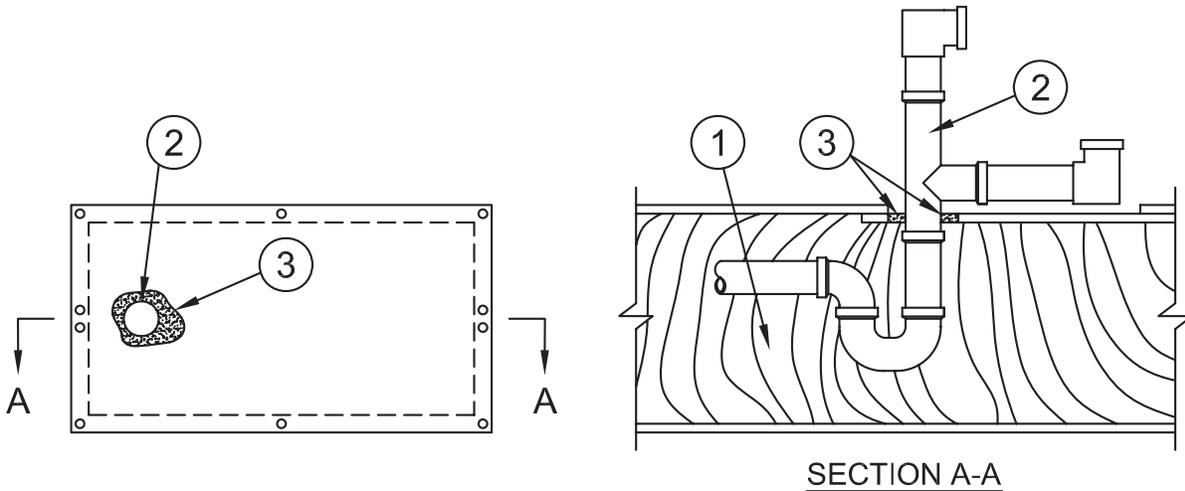

1. **Floor-Ceiling Assembly** – The 1 hr fire-rated solid or trussed lumber joist floor-ceiling assembly shall be constructed of the materials and in the manner specified in the individual L500 Series Floor-Ceiling Designs in the UL Fire Resistance Directory. The general construction details of the floor-ceiling assembly are summarized below:
 - A. **Flooring System** – Lumber or plywood subfloor with finish floor of lumber, plywood or **Floor Topping Mixture*** as specified in the individual Floor-Ceiling Design. Rectangular cutout in flooring to accommodate the bathtub drain piping (Item 2) to be max 8 by 12 in. (203 by 305 mm). Cutout to be patched using one layer of min 3/4 in. (19 mm) thick plywood or min 5/8 in. (16 mm) thick gypsum board (Item 1C). One piece of plywood or gypsum board, min 2 in. (51 mm) longer and wider than the cutout in the flooring, cut in half in short dimension at opening hole-sawed for bathtub drain piping (Item 2). Two halves positioned below flooring, concentric with cutout, with cut edges tightly butted with no visible openings, and screw attached by means of 1-1/2 in. (38 mm) long laminate screw spaced max 4-1/2 in. (114 mm) OC. Diam of opening hole-sawed through patch to be 3/8 in. (10 mm) larger than outside diam of bathtub drain piping. Max diameter opening is 2-1/2 in. (63.5 mm)
 - B. **Wood Joists** – Nom 10 in. (254 mm) deep (or deeper) lumber, steel or combination lumber and steel joists, trusses or **Structural Wood Members*** with bridging as required and with ends firestopped.
 - C. **Gypsum Board*** – Nom 4 ft (1.2 m) wide by 5/8 in. (16 mm) thick as specified in the individual Floor-Ceiling Design.
2. **Drain Piping** – Nom 1-1/2 in. (38 mm) diam (or smaller) Schedule 40 polyvinyl chloride (PVC) pipe and drain fittings cemented together and provided with PVC bathtub waste/overflow fittings. The annular space shall be min 0 in. (point contact) to max 1 in. (25 mm).
3. **Fill, Void or Cavity Materials*** – **Caulk or Sealant** – Min 5/8 in. (16 mm) thickness of sealant applied within annular space around perimeter of Drain Piping, flush with top surface of plywood or gypsum wallboard patch.

3M COMPANY – IC 15WB+ Sealant, CP 25WB+ Caulk, FB-3000 WT Sealant

*Bearing the UL Classification Mark

Reprinted from the Online Certifications Directory with permission from Underwriters Laboratories Inc.

Copyright © 2011 Underwriters Laboratories Inc.®

System No. F-C-2351

January 12, 2009

F Rating – 1 Hr

T Rating – 1 Hr

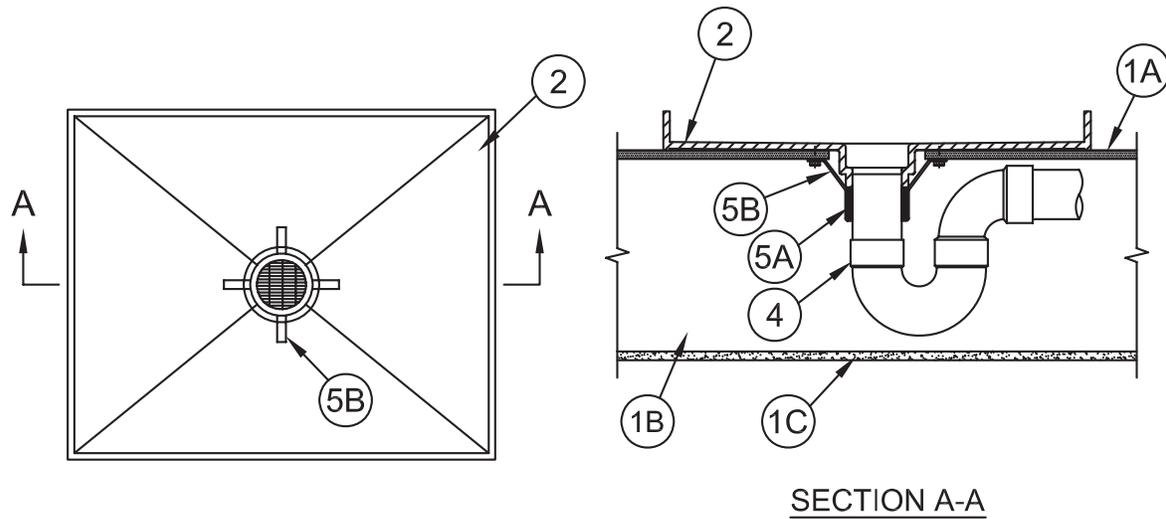

1. **Floor-Ceiling Assembly** – The 1 hr fire-rated wood joist floor-ceiling assembly shall be constructed of the materials and in the manner specified in the individual L500 Designs in the UL Fire Resistance Directory, as summarized below:
 - A. **Flooring System** – Lumber or plywood subfloor with finish floor of lumber, plywood or **Floor Topping Mixture*** as specified in the individual Floor-Ceiling Design. Max diam of opening is 6 in. (152 mm).
 - B. **Wood Joists** – Nom 10 in. (254 mm) deep (or deeper) lumber, steel or combination lumber and steel joists, trusses or **Structural Wood Members*** with bridging as required and with ends firestopped.
 - C. **Gypsum Board*** – Thickness, type, number of layers and fasteners as required in the individual Floor-Ceiling Design.
2. **Plastic Plumbing Fixtures+** – **Shower Base Receptor** – One-piece molded nonmetallic shower base receptor with stainless steel drain plate. Shower base receptor to be installed in accordance with the manufacturer's instructions.

TILE-REDI USA L L C – Model 3360L, 3360R, 37NEO, 3737, 4837, 4837ADA, 4837MB or 4848
3. **Tile** – (Not Shown) - Ceramic or stone tile applied to shower pan floor with epoxy adhesive in accordance with shower base receptor installation instructions.
4. **Nonmetallic Pipe** – Nom 2 in. (51 mm) diam Schedule 40 solid or cellular core PVC pipe solvent-welded into drain in the bottom of the shower base receptor and centered in the floor opening.
5. **Firestop System** – The details of the firestop system shall be as follows:
 - A. **Fill, Void or Cavity Materials*** – **Wrap Strip** – Nom 1/8 in. (3.2 mm) thick intumescent material supplied in 2 in. (51 mm) wide strips. Single layer of wrap strip tightly wrapped around nonmetallic drain pipe (Item 4) with a butted seam and with the top edge of the wrap strip abutting the hub of the shower drain. Wrap strip layer temporarily held in position using tape.

3M COMPANY
3M FIRE PROTECTION PRODUCTS – Ultra GS
 - B. **Steel Collar** – Nom 2 in. (51 mm) deep collar with 1-1/4 in. (32 mm) wide by 2 in. (51 mm) long anchor tabs and tabs to retain wrap strip layer. Coils of precut 0.016 in. (0.41 mm) thick (28 gauge) galv sheet steel available from wrap strip manufacturer. Steel collar, with anchor tabs bent outward 90 deg, wrapped tightly around wrap strip with min 1 in. (25 mm) overlap at seam. Anchor tabs to be pressed tightly against hub of shower drain and collar to be compressed around wrap strip using a min 1/2 in. (13 mm) wide stainless steel clamp at the collar midheight. Collar to be secured to underside of flooring system with steel screws with min 1-1/4 in. (32 mm) diam steel washers in conjunction with steel extension straps. Hanger tab extension straps to be fabricated from min 0.022 in. (0.6 mm) thick galv sheet steel. Taper straps from 1/4 in. (6 mm) wide to 1 in. (25 mm) wide with sufficient length to allow 1-1/2 to 2 in. (38 to 51 mm) lap onto floor. Straps secured to collar by inserting min 1 in. (25 mm) length of 1/4 in. (6 mm) wide end into hole on mounting tab and bending 180 degrees. Min of two anchor screws, diametrically opposed, are required.

*Bearing the UL Classification Mark

Reprinted from the Online Certifications Directory with permission from Underwriters Laboratories Inc.
Copyright © 2010 Underwriters Laboratories Inc.®

System No. F-C-2369

June 23, 2015

F Rating — 1 Hr

T Rating — 1 Hr

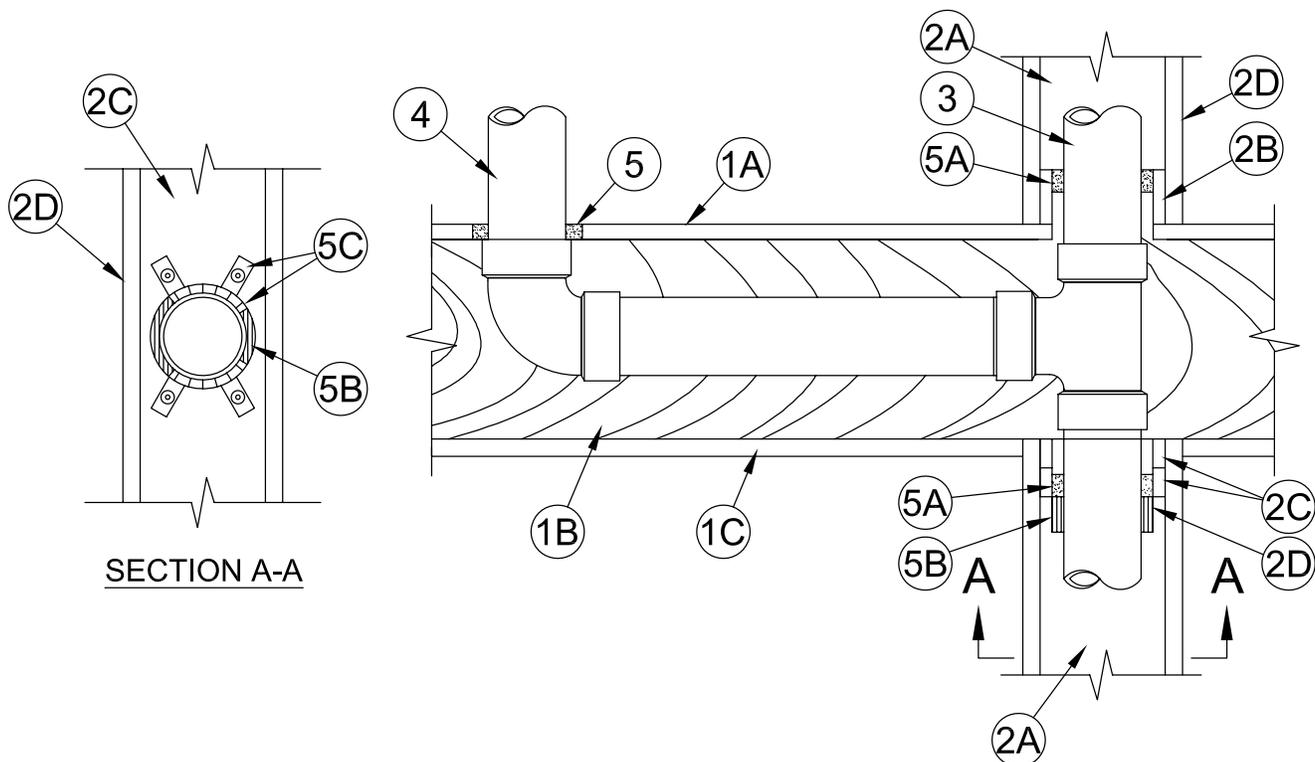

1. **Floor Assembly** — The 1 hr fire rated wood truss or combination wood and steel truss Floor-Ceiling assembly shall be constructed of the materials and in the manner described in the individual L500 Series Design in the UL Fire Resistance Directory, as summarized below:
 - A. **Flooring System** — Lumber or plywood subfloor with finish floor of lumber, plywood or **Floor Topping Mixture*** as specified in the individual Floor-Ceiling Design. Diam of opening shall be 1/2 in. to 1 in. (13 to 25 mm) larger than the outside diam of nonmetallic pipe (Items 3 and 4).
 - B. **Joists** — Nom 10 in. (254 mm) deep (or deeper) lumber, steel or combination lumber and steel joists, trusses or **Structural Wood Members*** with bridging as required and ends firestopped.
 - C. **Gypsum Board*** — Nom 4 ft (1.2 m) wide by 5/8 in. (16 mm) thick, attached as described in the individual Floor-Ceiling Design.
2. **Chase Wall** — The through penetrant (Item No. 3) shall be routed through a 1 hr fire-rated single, double or staggered wood studs/gypsum board chase wall constructed of the materials and in the manner specified in the individual U300 Series Wall and Partition Designs in the UL Fire Resistance Directory and shall include the following construction features:
 - A. **Studs** — Nom 2 by 6 in. (51 by 152 mm) lumber studs.
 - B. **Sole Plate** — Nom 2 by 6 in. (51 by 152 mm) lumber plates. Diam of opening or length of notch-out in sole plate to be 1/2 in. (13 mm) larger than outside diam of pipe.
 - C. **Top Plate** — The double top plate shall consist of two nom 2 by 6 in. (51 by 152 mm) lumber plates. Diam of opening or length of notch-out in top plate to be 1/2 in. (13 mm) larger than outside diam of pipe.
 - D. **Gypsum Board*** — Thickness, type, number of layers and fasteners shall be as specified in individual Wall and Partition Design.
3. **Through Penetrant** — One nonmetallic pipe to be installed within the firestop system. Pipe to be rigidly supported on both sides of floor-ceiling assembly. The annular space between pipe and periphery of opening shall be min 0 in. (point contact) to max 1/2 in. (0 to 13 mm). The following types and sizes of nonmetallic pipes may be used:
 - A. **Polyvinyl Chloride (PVC) Pipe** — Nom 4 in. (102 mm) diam (or smaller) Schedule 40 solid core PVC pipe for use in closed (process or supply) or vented (drain, waste or vent) piping system.
 - B. **Cellular Core Polyvinyl Chloride (ccPVC) Pipe** — Nom 4 in. (102 mm) diam (or smaller) Schedule 40 cellular core PVC pipe for use in closed (process or supply) or vented (drain, waste or vent) piping system.
 - C. **Acrylonitrile Butadiene Styrene (ABS) Pipe** — Nom 4 in. (102 mm) diam (or smaller) Schedule 40 solid core ABS pipe for use in closed (process or supply) or vented (drain, waste or vent) piping system.
 - D. **Cellular Core Acrylonitrile Butadiene Styrene (ccABS) Pipe** — Nom 4 in. (102 mm) diam (or smaller) Schedule 40 cellular core ABS pipe for use in closed (process or supply) or vented (drain, waste or vent) piping system.
 - E. **Chlorinated Polyvinyl Chloride (CPVC) Pipe** — Nom 4 in. (102 mm) diam (or smaller) SDR13.5 CPVC pipe for use in closed (process or supply) piping systems.
4. **Branch Piping** — (Optional) - One nonmetallic pipe to be connected to through penetrant (Item 3) and installed within opening in subfloor. The annular space between pipe and periphery of opening shall be min 0 in. (point contact) to max 1/2 in. (13 mm). The following types and sizes of nonmetallic pipes may be used:
 - A. **Polyvinyl Chloride (PVC) Pipe** — Nom 3 in. (76 mm) diam (or smaller) Schedule 40 solid core PVC pipe for use in closed (process or supply) or vented (drain, waste or vent) piping system.

System No. F-C-2369 *continued*

- B. **Cellular Core Polyvinyl Chloride (ccPVC) Pipe** — Nom 3 in. (76 mm) diam (or smaller) Schedule 40 cellular core PVC pipe for use in closed (process or supply) or vented (drain, waste or vent) piping system.
- C. **Acrylonitrile Butadiene Styrene (ABS) Pipe** — Nom 3 in. (76 mm) diam (or smaller) Schedule 40 solid core ABS pipe for use in closed (process or supply) or vented (drain, waste or vent) piping systems.
- D. **Cellular Core Acrylonitrile Butadiene Styrene (ccABS) Pipe** — Nom 3 in. (76 mm) diam (or smaller) Schedule 40 cellular core ABS pipe for use in closed (process or supply) or vented (drain, waste or vent) piping system.
5. **Firestop System** — The details of the firestop system shall be as follows:

- A. **Fill, Void or Cavity Materials*** — **Caulk or Sealant** — Min 3/4 in. (19 mm) thickness of caulk applied within annular space around perimeter of through penetrant (Item 3), flush with top surface of floor or sole plate and flush with bottom surface of top plate. Min 3/4 in. (19 mm) thickness of caulk applied within annular space around perimeter of branch piping (Item 4), flush with top surface of floor. Min 1/2 in. (13 mm) diam bead applied at the pipe/floor interface and the pipe/plate interface.

3M COMPANY 3M FIRE PROTECTION PRODUCTS — CP 25WB+ caulk, IC 15WB+ caulk or FB-3000 WT sealant. CP 25WB+ not suitable for use with CPVC pipes.

- B. **Fill, Void or Cavity Materials*** — **Wrap Strip** — Nom 1/8 in. (3.2 mm) thick intumescent material supplied in 2 in. (51 mm) wide strips. Wrap strip tightly wrapped around nonmetallic pipe and butted tightly against the bottom surface of the top plate. Two continuous layers and two partial layers of wrap strip are required. The two partial layers of wrap strip shall each be installed on opposing sides of the pipe, in line with the direction of the top plate. The ends of the partial layers shall be on a line tangent to the periphery of the continuous layers and parallel with the edge of the top plate. Layers of wrap strip temporarily held in place with tape.

3M COMPANY 3M FIRE PROTECTION PRODUCTS — Ultra GS

- C. **Steel Collar** — Nom 2 in. (51 mm) deep collar with 1-1/4 in. (32 mm) wide by 2 in. (51 mm) long anchor tabs and min 3/4 in. (19 mm) long tabs to retain wrap strip layers. Coils of precut 0.016 in. (0.41 mm) thick galv sheet steel available from wrap strip manufacturer. As an alternate, collar may be field-fabricated from min 0.016 in. (0.41 mm) thick galv sheet steel in accordance with instruction sheet supplied by wrap strip manufacturer. Steel collar, with anchor tabs bent outward 90 deg, wrapped tightly around wrap strip layers with min 1 in. (25 mm) overlap at the seam. With steel anchor tabs pressed tightly against the top plate, compress collar around wrap strip layers using a min 1/2 in. (13 mm) wide by 0.028 in. (.71 mm) thick stainless steel band clamp with worm drive tightening mechanism at the collar midheight. Secure collar to top plate with four anchor tabs, two on each side of pipe, using min 1-1/4 in. (32 mm) long steel screws in conjunction with 1 1/4 in. (32 mm) diam steel fender washers. As a final step, bend wrap strip retainer tabs 90 deg toward pipe to lock wrap strip layers in position.

* Indicates such products shall bear the UL or cUL Certification Mark for jurisdictions employing the UL or cUL Certification (such as Canada), respectively.

Through Penetrations

Non-Metallic Pipes

2000 Series

Wood Frame Floor/Ceiling

FC

System No. F-C-2387

March 20, 2009

F Rating – 1 Hr

T Rating – 0 Hr

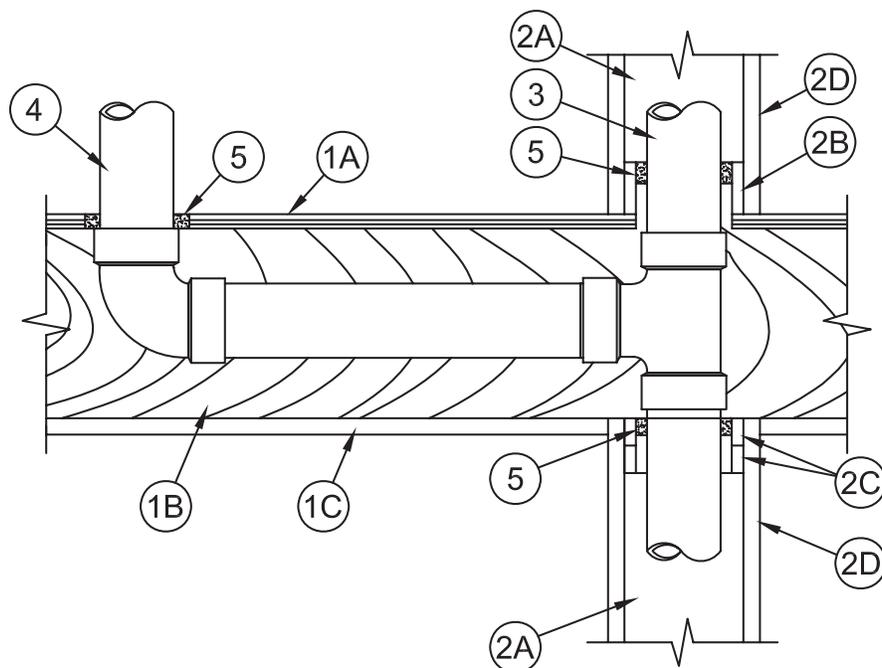

- 1. Floor Assembly** – The 1 hr fire rated wood truss or combination wood and steel truss Floor-Ceiling assembly shall be constructed of the materials and in the manner described in the individual L500 Series Design in the UL Fire Resistance Directory, as summarized below:
 - A. Flooring System** – Lumber or plywood subfloor with finish floor of lumber, plywood or **Floor Topping Mixture*** as specified in the individual Floor-Ceiling Design. Diam of opening shall be 1/2 in. to 1 in. (13 to 25 mm) larger than the outside diam of nonmetallic pipe (Items 3 and 4).
 - B. Joists** – Nom 10 in. (254 mm) deep (or deeper) lumber, steel or combination lumber and steel joists, trusses or **Structural Wood Members*** with bridging as required and ends firestopped.
 - C. Gypsum Board*** – Nom 4 ft (1.2 m) wide by 5/8 in. (16 mm) thick, attached as described in the individual Floor-Ceiling Design.
- 2. Chase Wall** – The through penetrant (Item No. 3) shall be routed through a single, double or staggered wood studs/gypsum board chase wall and shall include the following construction features:
 - A. Studs** – Nom 2 by 4 in. (51 by 102 mm) or 2 by 6 in. (51 by 152 mm) lumber studs.
 - B. Sole Plate** – Nom 2 by 4 in. (51 by 102 mm) or 2 by 6 in. (51 by 152 mm) lumber plates. Diam of opening or length of notch-out in sole plate to be 1/2 in. to 1 in. (13 to 25 mm) larger than outside diam of pipe.
 - C. Top Plate** – The single or double top plate shall consist of one or two nom 2 by 4 in. (51 by 102 mm) or 2 by 6 in. (51 by 152 mm) lumber plates. Diam of opening or length of notch-out in top plate to be 1/2 in. to 1 in. (13 to 25 mm) larger than outside diam of pipe.
 - D. Gypsum Board** – Min 1/2 in. thick rated or nonrated gypsum board.
- 3. Through Penetrant** – One nonmetallic pipe to be installed within the firestop system. Pipe to be rigidly supported on both sides of floor-ceiling assembly. The annular space between pipe and periphery of opening shall be min 0 in. (point contact) to max 1/2 in. (0 to max 13 mm). The following types and sizes of nonmetallic pipes may be used:
 - A. Polyvinyl Chloride (PVC) Pipe** – Nom 3 in. (76 mm) diam (or smaller) Schedule 40 solid core PVC pipe for use in closed (process or supply) or vented (drain, waste or vent) piping system.
 - B. Cellular Core Polyvinyl Chloride (ccPVC) Pipe** – Nom 3 in. (76 mm) diam (or smaller) Schedule 40 cellular core PVC pipe for use in closed (process or supply) or vented (drain, waste or vent) piping system.
 - C. Acrylonitrile Butadiene Styrene (ABS) Pipe** – Nom 3 in. (76 mm) diam (or smaller) Schedule 40 solid core ABS pipe for use in closed (process or supply) or vented (drain, waste or vent) piping system.
 - D. Cellular Core Acrylonitrile Butadiene Styrene (ccABS) Pipe** – Nom 3 in. (76 mm) diam (or smaller) Schedule 40 cellular core ABS pipe for use in closed (process or supply) or vented (drain, waste or vent) piping system.
 - E. Chlorinated Polyvinyl Chloride (CPVC) Pipe** – Nom 3 in. (76 mm) diam (or smaller) SDR13.5 CPVC pipe for use in closed (process or supply) piping systems.
- 4. Branch Piping** – (Optional) – One nonmetallic pipe to be connected to through penetrant (Item 3) and installed within opening in subfloor. The annular space between pipe and periphery of opening shall be min 0 in. (point contact) to max 1/2 in. (13 mm). The following types and sizes of nonmetallic pipes may be used:
 - A. Polyvinyl Chloride (PVC) Pipe** – Nom 3 in. (76 mm) diam (or smaller) Schedule 40 solid core PVC pipe for use in closed (process or supply) or vented (drain, waste or vent) piping system.

System No. F-C-2387 *continued*

- B. **Cellular Core Polyvinyl Chloride (ccPVC) Pipe** – Nom 3 in. (76 mm) diam (or smaller) Schedule 40 cellular core PVC pipe for use in closed (process or supply) or vented (drain, waste or vent) piping system.
 - C. **Acrylonitrile Butadiene Styrene (ABS) Pipe** – Nom 3 in. (76 mm) diam (or smaller) Schedule 40 solid core ABS pipe for use in closed (process or supply) or vented (drain, waste or vent) piping systems.
 - D. **Cellular Core Acrylonitrile Butadiene Styrene (ccABS) Pipe** – Nom 3 in. (76 mm) diam (or smaller) Schedule 40 cellular core ABS pipe for use in closed (process or supply) or vented (drain, waste or vent) piping system.
5. **Fill, Void or Cavity Materials* – Caulk or Sealant** – Min 3/4 in. (19 mm) thickness of caulk applied within annular space around perimeter of through penetrant (Item 3), flush with top surface of floor or sole plate and flush with bottom surface of lower top plate. Min 3/4 in. (19 mm) thickness of caulk applied within annular space around perimeter of branch piping (Item 4), flush with top surface of floor. Min 1/2 in. (13 mm) diam bead applied at the pipe/floor interface.

3M COMPANY

3M FIRE PROTECTION PRODUCTS – CP 25WB+ caulk, IC 15WB+ caulk or FB-3000 WT sealant

(Note: CP 25WB+ not suitable for use with CPVC pipes.)

*Bearing the UL Classification Mark

Reprinted from the Online Certifications Directory with permission from Underwriters Laboratories Inc.
Copyright © 2011 Underwriters Laboratories Inc.®

Through Penetrations

Non-Metallic Pipes

2000 Series

Wood Frame Floor/Ceiling

FC

System No. F-C-2388

March 20, 2009

F Rating – 1 Hr

T Rating – 1 Hr

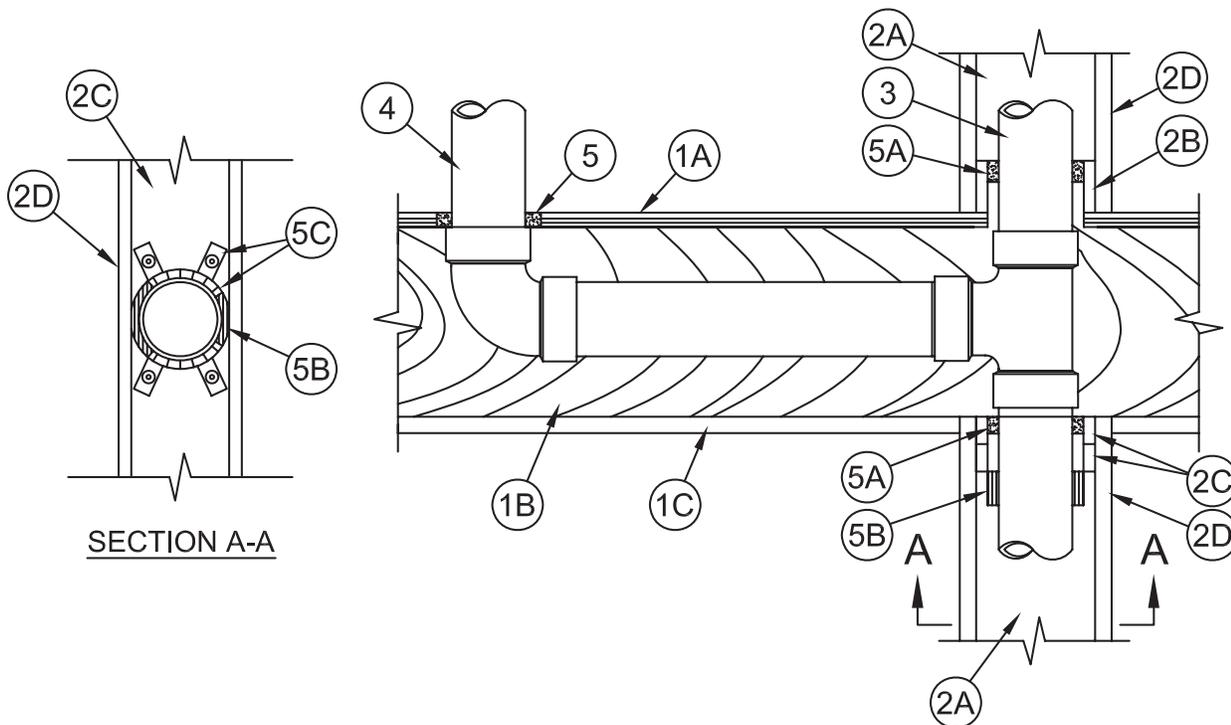

1. **Floor Assembly** – The 1 hr fire rated wood truss or combination wood and steel truss Floor-Ceiling assembly shall be constructed of the materials and in the manner described in the individual L500 Series Design in the UL Fire Resistance Directory, as summarized below:
 - A. **Flooring System** – Lumber or plywood subfloor with finish floor of lumber, plywood or **Floor Topping Mixture*** as specified in the individual Floor-Ceiling Design. Diam of opening shall be 1/2 in. to 1 in. (13 to 25 mm) larger than the outside diam of nonmetallic pipe (Items 3 and 4).
 - B. **Joists** – Nom 10 in. (254 mm) deep (or deeper) lumber, steel or combination lumber and steel joists, trusses or **Structural Wood Members*** with bridging as required and ends firestopped.
 - C. **Gypsum Board*** – Nom 4 ft (1.2 m) wide by 5/8 in. (16 mm) thick, attached as described in the individual Floor-Ceiling Design.
2. **Chase Wall** – The through penetrant (Item No. 3) shall be routed through a single, double or staggered wood studs/gypsum board chase wall and shall include the following construction features:
 - A. **Studs** – Nom 2 by 6 in. (51 by 152 mm) lumber studs.
 - B. **Sole Plate** – Nom 2 by 6 in. (51 by 152 mm) lumber plates. Diam of opening or length of notch-out in sole plate to be 1/2 in. (13 mm) larger than outside diam of pipe.
 - C. **Top Plate** – The single or double top plate shall consist of one or two nom 2 by 6 in. (51 by 152 mm) lumber plates. Diam of opening or length of notch-out in top plate to be 1/2 in. (13 mm) larger than outside diam of pipe.
 - D. **Gypsum Board** – Min 1/2 in. (13 mm) thick rated or nonrated gypsum board.
3. **Through Penetrant** – One nonmetallic pipe to be installed within the firestop system. Pipe to be rigidly supported on both sides of floor-ceiling assembly. The annular space between pipe and periphery of opening shall be min 0 in. (point contact) to max 1/2 in. (0 to 13 mm). The following types and sizes of nonmetallic pipes may be used:
 - A. **Polyvinyl Chloride (PVC) Pipe** – Nom 4 in. (102 mm) diam (or smaller) Schedule 40 solid core PVC pipe for use in closed (process or supply) or vented (drain, waste or vent) piping system.
 - B. **Cellular Core Polyvinyl Chloride (ccPVC) Pipe** – Nom 4 in. (102 mm) diam (or smaller) Schedule 40 cellular core PVC pipe for use in closed (process or supply) or vented (drain, waste or vent) piping system.
 - C. **Acrylonitrile Butadiene Styrene (ABS) Pipe** – Nom 4 in. (102 mm) diam (or smaller) Schedule 40 solid core ABS pipe for use in closed (process or supply) or vented (drain, waste or vent) piping system.
 - D. **Cellular Core Acrylonitrile Butadiene Styrene (ccABS) Pipe** – Nom 4 in. (102 mm) diam (or smaller) Schedule 40 cellular core ABS pipe for use in closed (process or supply) or vented (drain, waste or vent) piping system.
 - E. **Chlorinated Polyvinyl Chloride (CPVC) Pipe** – Nom 4 in. (102 mm) diam (or smaller) SDR13.5 CPVC pipe for use in closed (process or supply) piping systems.
4. **Branch Piping** – (Optional) – One nonmetallic pipe to be connected to through penetrant (Item 3) and installed within opening in subfloor. The annular space between pipe and periphery of opening shall be min 0 in. (point contact) to max 1/2 in. (13 mm). The following types and sizes of nonmetallic pipes may be used:
 - A. **Polyvinyl Chloride (PVC) Pipe** – Nom 3 in. (76 mm) diam (or smaller) Schedule 40 solid core PVC pipe for use in closed (process or supply) or vented (drain, waste or vent) piping system.

System No. F-C-2388 *continued*

- B. Cellular Core Polyvinyl Chloride (ccPVC) Pipe** – Nom 3 in. (76 mm) diam (or smaller) Schedule 40 cellular core PVC pipe for use in closed (process or supply) or vented (drain, waste or vent) piping system.
- C. Acrylonitrile Butadiene Styrene (ABS) Pipe** – Nom 3 in. (76 mm) diam (or smaller) Schedule 40 solid core ABS pipe for use in closed (process or supply) or vented (drain, waste or vent) piping systems.
- D. Cellular Core Acrylonitrile Butadiene Styrene (ccABS) Pipe** – Nom 3 in. (76 mm) diam (or smaller) Schedule 40 cellular core ABS pipe for use in closed (process or supply) or vented (drain, waste or vent) piping system.
5. **Firestop System** – The firestop system shall consist of the following:
- A. **Fill, Void or Cavity Materials* – Caulk or Sealant** – Min 3/4 in. (19 mm) thickness of caulk applied within annular space around perimeter of through penetrant (Item 3), flush with top surface of floor or sole plate and flush with bottom surface of lower top plate. Min 3/4 in. (19 mm) thickness of caulk applied within annular space around perimeter of branch piping (Item 4), flush with top surface of floor. Min 1/2 in. (13 mm) diam bead applied at the pipe/floor interface.
- 3M COMPANY**
3M FIRE PROTECTION PRODUCTS – CP 25WB+ caulk, IC 15WB+ caulk or FB-3000 WT sealant
(Note: CP 25WB+ not suitable for use with CPVC pipes.)
- B. **Fill, Void or Cavity Materials* – Wrap Strip** – Nom 1/8 in. (3.2 mm) thick intumescent material supplied in 2 in. (51 mm) wide strips. Wrap strip tightly wrapped around nonmetallic pipe and butted tightly against the bottom surface of the top plate. Two continuous layers and two partial layers of wrap strip are required. The two partial layers of wrap strip shall each be installed on opposing sides of the pipe, in line with the direction of the top plate. The ends of the partial layers shall be on a line tangent to the periphery of the continuous layers and parallel with the edge of the top plate. Layers of wrap strip temporarily held in place with tape.
- 3M COMPANY**
3M FIRE PROTECTION PRODUCTS – Ultra GS
- C. **Steel Collar** – Nom 2 in. (51 mm) deep collar with 1-1/4 in. (32 mm) wide by 2 in. (51 mm) long anchor tabs and min 3/4 in. (19 mm) long tabs to retain wrap strip layers. Coils of precut 0.016 in. (0.41 mm) thick galv sheet steel available from wrap strip manufacturer. As an alternate, collar may be field-fabricated from min 0.016 in. (0.41 mm) thick galv sheet steel in accordance with instruction sheet supplied by wrap strip manufacturer. Steel collar, with anchor tabs bent outward 90 deg, wrapped tightly around wrap strip layers with min 1 in. (25 mm) overlap at the seam. With steel anchor tabs pressed tightly against the top plate, compress collar around wrap strip layers using a min 1/2 in. (13 mm) wide by 0.028 in. (.71 mm) thick stainless steel band clamp with worm drive tightening mechanism at the collar midheight. Secure collar to top plate with four anchor tabs, two on each side of pipe, using min 1-1/4 in. (32 mm) long steel screws in conjunction with 1 1/4 in. (32 mm) diam steel fender washers. As a final step, bend wrap strip retainer tabs 90 deg toward pipe to lock wrap strip layers in position.

*Bearing the UL Classification Mark

Reprinted from the Online Certifications Directory with permission from Underwriters Laboratories Inc.
Copyright © 2011 Underwriters Laboratories Inc.®

System No. F-C-2391

August 04, 2009

F Rating – 1 Hr

T Rating – 1 Hr

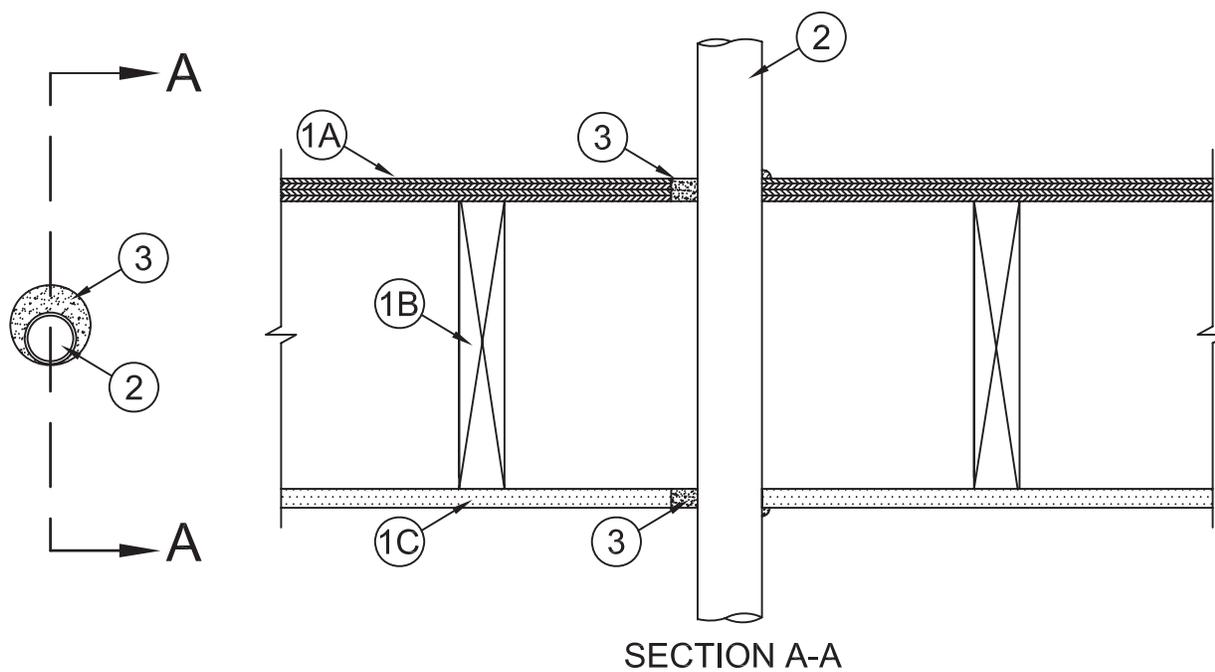

1. **Floor-Ceiling Assembly** – The 1 hr fire-rated solid or trussed lumber joist floor-ceiling assembly shall be constructed of the materials and in the manner specified in the individual L500 Series Floor-Ceiling Designs in the UL Fire Resistance Directory. The general construction details of the floor-ceiling assembly are summarized below:
 - A. **Flooring System** – Lumber or plywood subfloor with finish floor of lumber, plywood or **Floor Topping Mixture*** as specified in the individual Floor-Ceiling Design. Diameter of opening shall be 1-1/2 in. (38 mm) larger than the outside diam of tubing (Items 2).
 - B. **Wood Joists** – Nom 10 in. (254 mm) deep (or deeper) lumber, steel or combination lumber and steel joists, trusses or **Structural Wood Members*** with bridging as required and with ends firestopped.
 - C. **Gypsum Board*** – Nom 4 ft (1219 mm) wide by 5/8 in. (16 mm) thick as specified in the individual Floor-Ceiling Design. . Diameter of opening shall be 1-1/2 in. (38 mm) larger than the outside diam of tubing (Items 2).
- 1.1 **Chase Wall** – (Optional, not shown) - The tubing (Item No. 2) may be routed through a fire-rated single, double or staggered wood stud/ gypsum board chase wall having a fire rating consistent with that of the floor-ceiling assembly. The chase wall shall be constructed of the materials and in the manner specified in the individual U300 Series Wall and Partition Designs in the UL Fire Resistance Directory and shall include the following construction features:
 - A. **Studs** – Nom 2 by 6 in. (51 by 152 mm) or double nom 2 by 4 in. (51 by 102 mm) lumber studs.
 - B. **Sole Plate** – Nom 2 by 6 in. (51 by 152 mm) or parallel 2 by 4 in. (51 by 102 mm) lumber plates, tightly butted. . Diameter of opening shall be 1-1/2 in. (38 mm) larger than the outside diam of tubing (Items 2)
 - C. **Top Plate** – The double top plate shall consist of two nom 2 by 6 in. (51 by 152 mm) or two sets of parallel 2 by 4 in. (51 by 102 mm) lumber plates, tightly butted. . Diameter of opening shall be 1-1/2 in. (38 mm) larger than the outside diam of tubing (Items 2).
 - D. **Gypsum Board*** – Thickness, type, number of layers and fasteners shall be as specified in individual Wall and Partition Design.
2. **Crosslink Polyethylene (PEX) Tubing** – Nom 2 in. (51 mm) diam (or smaller) SDR 9 PEX tubing for use in closed (process or supply) piping system. Tubing installed concentrically or eccentrically within opening. Annular space between tubing and edge of opening to be min 0 in. to max 1-1/2 in. (38 mm). Tubing to be rigidly supported on both sides of floor-ceiling assembly.
3. **Fill, Void or Cavity Materials* – Caulk or Sealant** – Min 3/4 in. (19 mm) thickness of fill material applied within the annulus, flush with top surface of floor. Min 5/8 in. (16 mm) thickness of fill material applied within the annulus, flush with bottom surface of ceiling. An additional min 1/2 in. (13 mm) bead of fill material applied at the tubing/floor interface at point contact location on top surface of floor and at the tubing/ceiling interface at point contact location on lower surface of floor.

3M COMPANY

3M FIRE PROTECTION PRODUCTS – CP 25WB+, IC 15WB+ or FB-3000 WT

*Bearing the UL Classification Mark

Reprinted from the Online Certifications Directory with permission from Underwriters Laboratories Inc.

Copyright © 2010 Underwriters Laboratories Inc.®

Through Penetrations

Non-Metallic Pipes

2000 Series

Wood Frame Floor/Ceiling

FC

System No. F-C-2396

April 25, 2013

F Rating – 1 Hr

T Rating – 1 Hr

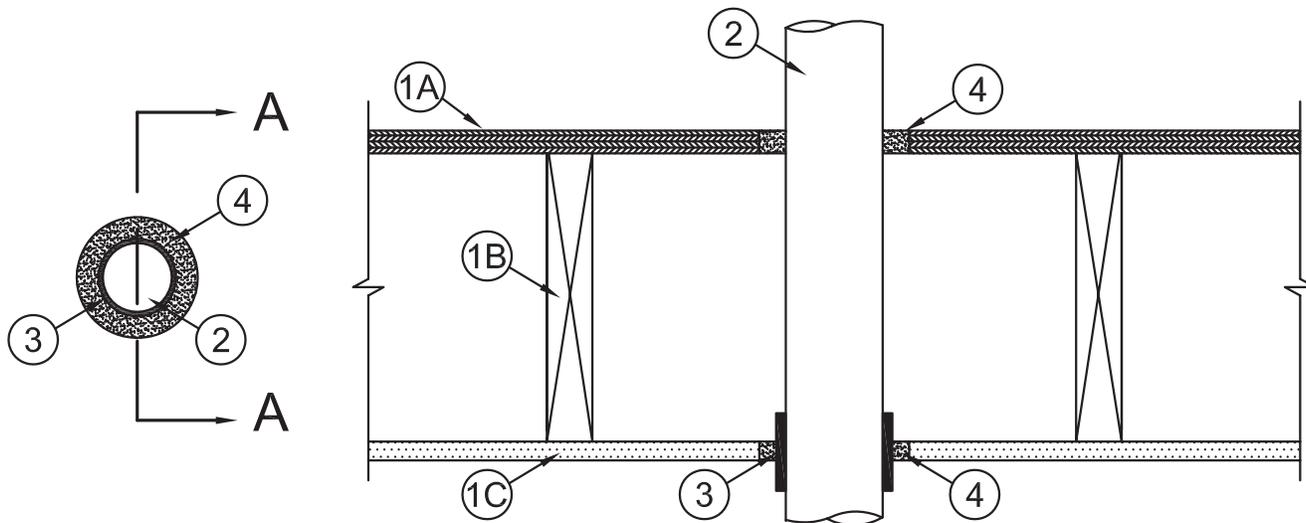

SECTION A-A

1. **Floor-Ceiling Assembly** – The 1 hr fire rated wood joist floor-ceiling assembly shall be constructed of the materials and in the manner specified in the individual L500 Designs in the UL Fire Resistance Directory, as summarized below:
 - A. **Flooring System** – Lumber or plywood subfloor with finish floor of lumber, plywood or **Floor Topping Mixture*** as specified in the individual Floor-Ceiling Design. Max diam of opening is 6 in. (152 mm).
 - B. **Wood Joists** – Nom 10 in. (254 mm) deep (or deeper) lumber, steel or combination lumber and steel joists, trusses or **Structural Wood Members*** with bridging as required and with ends firestopped.
 - C. **Gypsum Board*** – Thickness, type, number of layers and fasteners as required in the individual Floor-Ceiling Design. Max diam of opening is 6 in. (152 mm).
- 1.1 **Chase Wall** – (Optional, not shown) – The tubing (Item No. 2) may be routed through a fire-rated single, double or staggered wood stud/gypsum board chase wall having a fire rating consistent with that of the floor-ceiling assembly. The chase wall shall be constructed of the materials and in the manner specified in the individual U300 Series Wall and Partition Designs in the UL Fire Resistance Directory and shall include the following construction features:
 - A. **Studs** – Nom 2 by 6 in. (51 by 152 mm) or double nom 2 by 4 in. (51 by 102 mm) lumber studs.
 - B. **Sole Plate** – Nom 2 by 6 in. (51 by 152 mm) or parallel 2 by 4 in. (51 by 102 mm) lumber plates, tightly butted. Diameter of opening shall be 1-1/2 in. (38 mm) larger than the outside diam of tubing (Items 2).
 - C. **Top Plate** – The double top plate shall consist of two nom 2 by 6 in. (51 by 152 mm) or two sets of parallel 2 by 4 in. (51 by 102 mm) lumber plates, tightly butted. Diameter of opening shall be 1-1/2 in. (38 mm) larger than the outside diam of tubing (Items 2).
 - D. **Gypsum Board*** – Thickness, type, number of layers and fasteners shall be as specified in individual Wall and Partition Design.
2. **Through Penetrant** – One nonmetallic pipe or conduit to be centered within the opening. Annular space between the pipe or conduit and the periphery of the opening shall be nom 3/4 in. (19 mm). Penetrant to be rigidly supported on both sides of floor-ceiling assembly. The following types and sizes of nonmetallic pipe or conduit may be used:
 - A. **Polyvinyl Chloride (PVC) Pipe** – Nom 4 in. (102 mm) diam (or smaller) Schedule 40 solid or cellular core PVC pipe for use in closed (process or supply) or vented (drain, waste or vent) piping systems.
 - B. **Rigid Nonmetallic Conduit (RNC)+** – Nom 4 in. (102 mm) diam (or smaller) Schedule 40 PVC conduit installed in accordance with the National Electrical Code (NFPA 70).
3. **Fill, Void or Cavity Material* – Wrap Strip** – Min 3/16 in. (5 mm) thick intumescent material supplied in 2-1/2 in. (64 mm) wide strips. Single layer of pre-cut wrap strip tightly wrapped around nonmetallic pipe and secured with the adhesive closure tab. Wrap strip is to be recessed within the opening in the gypsum board ceiling such that the bottom of the wrap strip layer is 7/8 in. (22 mm) below the bottom plane of the ceiling.

3M COMPANY

3M FIRE PROTECTION PRODUCTS – Fire Barrier Tuck-In Wrap Strip WS 200, WS 300 or WS 400

4. **Fill, Void or Cavity Material* – Sealant** – Min 3/4 in. (19 mm) thickness of fill material applied within the annulus, flush with the top surface of the floor. Min 5/8 in. (16 mm) thickness of fill material applied within the annulus, flush with the bottom surface of the gypsum board ceiling.

3M COMPANY

3M FIRE PROTECTION PRODUCTS – IC 15WB+, CP 25WB+ or FB-3000 WT Sealant

*Bearing the UL Classification Mark

Reprinted from the Online Certifications Directory with permission from UL © 2013 UL LLC



System No. F-E-2001

November 20, 2009

F Rating – 1 Hr

T Rating – 1 Hr

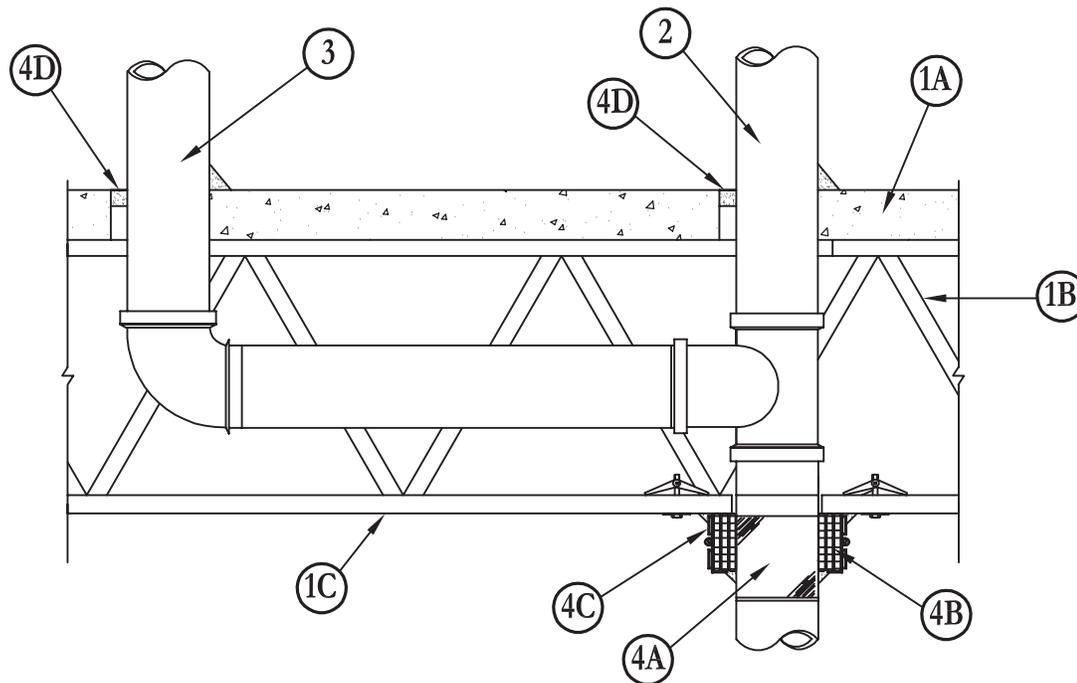

1. **Floor-Ceiling Assembly** – The 1 hr fire rated concrete and steel joist Floor-Ceiling assembly shall be constructed of the materials and in the manner described in the individual G500 Series Design in the UL Fire Resistance Directory, as summarized below:
 - A. **Flooring** – Lightweight or normal weight (100-150 pcf or 1600-2400 kg/m³) concrete as specified in the individual G500 Series Design. Diam of opening shall be max 1 in. (25 mm) larger than the nom diam of pipe (Items 2 and 3).
 - B. **Joists** – Steel joists or **Structural Steel Members*** as specified in the individual G500 Series Design.
 - C. **Gypsum Board*** – Min 5/8 in. (16 mm) thick, screw-attached to furring channels as specified in the individual G500 Series Design. Max diam of opening is 5-1/2 in. (140 mm).
2. **Through Penetrants** – One nonmetallic pipe to be installed within the firestop system. Pipe to be rigidly supported on both sides of floor-ceiling assembly. The annular space between pipe and periphery of opening shall be min 0 in. (0 mm, point contact) to max 1/2 in. (13 mm). Pipe may be installed with continuous point contact. The following types and sizes of nonmetallic pipes may be used:
 - A. **Polyvinyl Chloride (PVC) Pipe** – Nom 4 in. (102 mm) diam (or smaller) Schedule 40 solid core PVC pipe for use in closed (process or supply) or vented (drain, waste or vent) piping system.
 - B. **Cellular Core Polyvinyl Chloride (ccPVC) Pipe** – Nom 4 in. (102 mm) diam (or smaller) Schedule 40 cellular core PVC pipe for use in closed (process or supply) or vented (drain, waste or vent) piping system.
 - C. **Acrylonitrile Butadiene Styrene (ABS) Pipe** – Nom 4 in. (102 mm) diam (or smaller) Schedule 40 solid core ABS pipe for use in closed (process or supply) or vented (drain, waste or vent) piping system.
 - D. **Cellular Core Acrylonitrile Butadiene Styrene (ccABS) Pipe** – Nom 4 in. (102 mm) diam (or smaller) Schedule 40 cellular core ABS pipe for use in closed (process or supply) or vented (drain, waste or vent) piping system.
3. **Branch Piping** – One nonmetallic pipe with or without nom 3 in. (76 mm) diam (or smaller) toilet flange (not shown) to be connected to through penetrant (Item 2) and installed within opening in floor. The annular space between pipe and periphery of opening shall be min 0 in. (0 mm, point contact) to max 1/2 in. (13 mm). Pipe may be installed with continuous point contact. Branch piping may terminate in a max 3 in. (76 mm) diam toilet flange, which corresponds to the type of branch piping. The following types and sizes of nonmetallic pipes may be used:
 - A. **Polyvinyl Chloride (PVC) Pipe** – Nom 3 in. (76 mm) diam (or smaller) Schedule 40 solid core PVC pipe for use in closed (process or supply) or vented (drain, waste or vent) piping system.
 - B. **Cellular Core Polyvinyl Chloride (ccPVC) Pipe** – Nom 3 in. (76 mm) diam (or smaller) Schedule 40 cellular core PVC pipe for use in closed (process or supply) or vented (drain, waste or vent) piping system.
 - C. **Acrylonitrile Butadiene Styrene (ABS) Pipe** – Nom 3 in. (76 mm) diam (or smaller) Schedule 40 solid core ABS pipe for use in closed (process or supply) or vented (drain, waste or vent) piping system.
 - D. **Cellular Core Acrylonitrile Butadiene Styrene (ccABS) Pipe** – Nom 3 in. (76 mm) diam (or smaller) Schedule 40 cellular core ABS pipe for use in closed (process or supply) or vented (drain, waste or vent) piping system.

System No. F-E-2001 continued

Through Penetrations

Non-Metallic Pipes

2000 Series

Wood Frame Floor/Ceiling

FE

4. **Firestop System** – The details of the firestop system shall be as follows:

- A. **Foil Tape** – Nom 4 in. (102 mm) wide, 3 mil thick aluminum tape wrapped around pipe prior to the installation of the wrap strip (Item 4B). Min of one wrap, flush with the ceiling and proceeding downward. Not required when wrap strip in Item 4.B2 is used. Required only on pipes noted in table shown in Item 4.B1.
- B1. **Fill, Void or Cavity Materials* – Wrap Strip** – Nom 1/4 in. (6 mm) thick intumescent elastomeric material faced on one side with aluminum foil, supplied in 1 and 2 in. (25 and 51 mm) wide strips. Strips tightly wrapped around nonmetallic pipe (foil side exposed) with the edges butted against the bottom surface of the gypsum board ceiling. The min wrap strip width and the number of layers of wrap strip required are dependent upon the type of pipe and the nom diam as shown in the following table:

| Pipe Type | Nom Pipe Diam In. (mm) | Wrap Strip Width In. (mm) | Min Wrap Strip Layers |
|-------------------------|-------------------------|---------------------------|-----------------------|
| PVC or CPVC | 1/2 to 1-1/2 (13 to 38) | 1 (25) | 1 |
| PVC or CPVC | 2 to 2-1/2 (51 to 64) | 1 (25) | 2 |
| PVC or CPVC | 3 (76) | 1 (25) | 3 |
| ccPVC, ABS or ccABS (a) | 2 (51) | 1 (25) | 2 |
| ABS, PVC, ccPVC or CPVC | 1/2 to 2 (13 to 51) | 2 (51) | 1 |
| ABS, PVC, ccPVC or CPVC | 2-1/2 to 3 (64 to 76) | 2 (51) | 2 |
| PVC or CPVC | 3-1/2 to 4 (89 to 102) | 2 (51) | 3 |
| ABS (a) | 3-1/2 to 4 (89 to 102) | 2 (51) | 3 |
| ccPVC | 3-1/2 to 4 (89 to 102) | 2 (51) | 3 |
| ccABS (a) | 1/2 to 2 (13 to 51) | 2 (51) | 1 |
| ccABS (a) | 2-1/2 to 3 (64 to 76) | 2 (51) | 2 |
| ccABS (a) | 3-1/2 to 4 (89 to 102) | 2 (51) | 3 |

(a) - Requires use of aluminum tape detailed in Item 4A.

3M COMPANY – FS-195+

- B2. **Fill, Void or Cavity Materials* – Wrap Strip** – (Alternate material to Item 4.B1) Nom 1/8 in. (3.2 mm) thick intumescent material supplied in 2 in. (51 mm) wide strips. Wrap strip tightly wrapped around nonmetallic pipe with continuous layers and butted tightly against the bottom surface of the gypsum board ceiling. The min number of layers required is dependent upon the nom diam of the pipe and the hourly F Rating of the system. The number of wrap strip layers are as follows. For nom 2 in. (51 mm) diam (and smaller) pipes, one layer is required. For nom 2-1/2 in. and 3 in. (64 mm and 76 mm) diam pipes, two layers are required. For nom 3-1/2 in. and 4 in. (89 mm and 102 mm) diam pipes, three layers are required.

3M COMPANY – Ultra GS

- C. **Steel Collar** – Nom 1 or 2 in. (25 or 51 mm) deep collar with 1-1/4 in. (32 mm) wide by 2 in. (51 mm) long anchor tabs and min 3/4 in. (19 mm) long tabs to retain wrap strip layers. Coils of precut min 0.016 in. (.41 mm) thick (28 gauge) galv sheet steel are available from wrap strip manufacturer. As an alternate, collar may be field fabricated from min 0.016 in. (.41 mm) thick (28 gauge) galv sheet steel in accordance with instruction sheet applied by wrap strip manufacturer. Steel collar, with anchor tabs bent outward 90 degrees, wrapped tightly around wrap strip layers with min 1 in. (25 mm) overlap at the seam. A min 1/2 in. (13 mm) wide by min 0.028 in. (.71 mm) thick stainless steel band clamp secured around collar at midheight. As an alternate to the band clamp, collar for systems with three or more layers of wrap strip may be fastened together along the overlapping seam with three No. 6 by 3/8 in. (152 by 10 mm) long self-tapping steel screws. Collar secured to gypsum wallboard ceiling using 3/16 in. (5 mm) diam steel toggle bolts (5/8 in. (16 mm) grip) in conjunction with 1-1/4 in. (32 mm) diam steel fender washers. Min of two fasteners, symmetrically located, required for nom 1/2 in. to nom 2 in. (13 mm to 51 mm) diam pipes. Min of three symmetrically located fasteners required for nom 2-1/2 in. to nom 3 in. (64 mm to 76 mm) diam pipes. Min of four symmetrically located fasteners required for nom 3-1/2 in. and 4 in. (89 mm to 102 mm) diam pipes. Wrap strip retainer tabs to be bent 90 degrees toward pipe to lock wrap strip layers in position.

- D. **Fill, Void or Cavity Materials* – Caulk or Sealant** – Min 3/4 in. (19 mm) thickness of caulk applied within annular space around perimeter of through penetrant and branch piping (Items 2 and 3), flush with top surface of floor. Min 1/2 in. (13 mm) diam bead applied at the pipe/floor interfaces at point contact locations on the top surface of floor.

3M COMPANY – CP 25WB+, IC 15WB+, FireDam 150+ caulk or FB-3000 WT sealant
(Note: CP 25WB+ and FireDam 150+ not suitable for use with CPVC pipes.)

*Bearing the UL Classification Mark

Reprinted from the Online Certifications Directory with permission from Underwriters Laboratories Inc.
Copyright © 2010 Underwriters Laboratories Inc.®



Note: Systems with Nonmetallic Through Penetrant(s) have not been evaluated with a pressure differential of 50 Pa between the exposed and unexposed surfaces as required by the National Building Code of Canada.

System No. F-E-2002

November 20, 2009

F Rating – 1 Hr

T Ratings – 0 and 1 Hr (See Item 2)

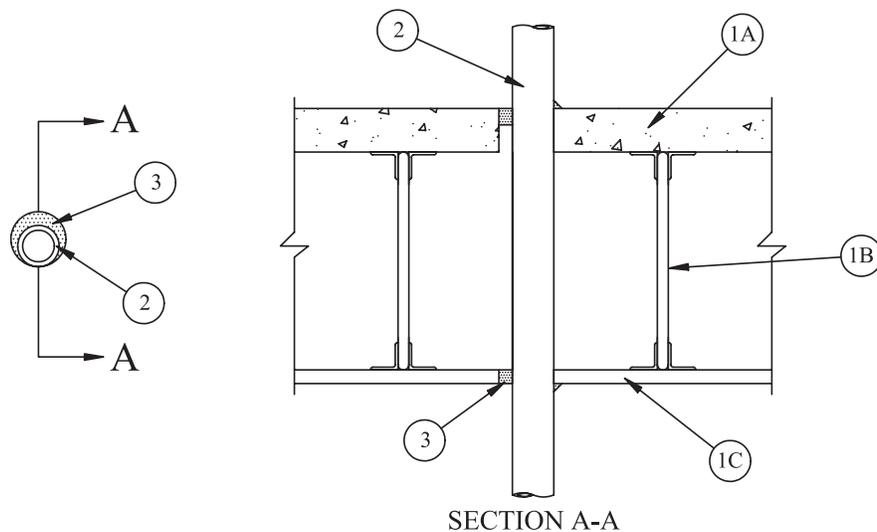

- Floor-Ceiling Assembly** – The 1 hr fire rated concrete and steel joist Floor-Ceiling assembly shall be constructed of the materials and in the manner described in the individual G500 Series Design in the UL Fire Resistance Directory, as summarized below:
 - Flooring** – Lightweight or normal weight (100-150 pcf or 1600-2400 kg/m³) concrete as specified in the individual G500 Series Design. Diameter of opening shall be 5/8 in. (16 mm) larger than the outside diam of nonmetallic pipe or conduit (Items 2).
 - Joists** – Steel joists or **Structural Steel Members*** as specified in the individual G500 Series Design.
 - Gypsum Board*** – Min 5/8 in. (16 mm) thick, screw-attached to furring channels as specified in the individual G500 Series Design. Diameter of opening shall be 5/8 in. (16 mm) larger than the outside diam of nonmetallic pipe or conduit (Item 2).
- Through Penetrants** – One nonmetallic pipe or conduit to be installed concentrically or eccentrically within the firestop system. Annular space between pipe or conduit and edge of opening to be min 0 in. (0 mm, point contact) to max 5/8 in. (16 mm). Pipe or conduit to be rigidly supported on both sides of floor-ceiling assembly. The following types and sizes of nonmetallic pipes or conduits may be used:
 - Polyvinyl Chloride (PVC) Pipe** – Nom 1-1/2 in. (38 mm) diam (or smaller) Schedule 40 solid core PVC pipe for use in closed (process or supply) or vented (drain, waste or vent) piping systems.
 - Rigid Nonmetallic Conduit⁺⁺** – Nom 1-1/2 in. (38 mm) diam (or smaller) Schedule 40 solid core PVC conduit installed in accordance with Article 347 of the National Electrical Code (NFPA No. 70).
 - Chlorinated Polyvinyl Chloride (CPVC) Pipe** – Nom 1-1/2 in. (38 mm) diam (or smaller) SDR13.5 CPVC pipe for use in closed (process or supply) piping system.
 - Cellular Core Polyvinyl Chloride (ccPVC) Pipe** – Nom 1-1/2 in. (38 mm) diam (or smaller) Schedule 40 cellular core PVC pipe for use in closed (process or supply) or vented (drain, waste or vent) piping system.
 - Acrylonitrile Butadiene Styrene (ABS) Pipe** – Nom 1-1/2 in. (38 mm) diam (or smaller) Schedule 40 solid core ABS pipe for use in closed (process or supply) or vented (drain, waste or vent) piping system.
 - Cellular Core Acrylonitrile Butadiene Styrene (ccABS) Pipe** – Nom 1-1/2 in. (38 mm) diam (or smaller) Schedule 40 cellular core ABS pipe for use in closed (process or supply) or vented (drain, waste or vent) piping system.
 - Crosslink Polyethylene (PEX) Tube** – Nom 1 (25 mm) in. diam (or smaller) SDR 9 PGX tube for use in closed (process or supply) piping system.
 - Electrical Nonmetallic (ENT) Tubing⁺⁺** – Nom 1-1/4 in. (32 mm) diam (or smaller) corrugated wall electrical nonmetallic tubing constructed of polyvinyl chloride. ENT to be installed as a complete system with all terminations in junction boxes, outlet boxes or other approved enclosures as specified in the National Electrical Code. Max one ENT centered in firestop system with an annular space of 1 in. (25 mm) ENT rigidly supported on both sides of the floor-ceiling assembly.

The hourly T Rating is 1 Hr when pipes/conduits A, B, C, G or H are used. The hourly T Rating is 0 Hr when pipes D, E or F are used.
- Fill, Void or Cavity Materials* – Caulk, Sealant or Putty** – Min 3/4 in. (19 mm) thickness of fill material applied within the annulus, flush with top surface of floor. Min 5/8 in. (16 mm) thickness of fill material applied within the annulus, flush with bottom surface of ceiling. An additional min 1/4 in. (6 mm) bead of fill material applied at the pipe/floor interface at point contact location on top surface of floor and at the pipe/ceiling interface at point contact location on lower surface of floor.

3M COMPANY – CP 25WB+ caulk, MP+ Stix putty, IC 15WB+ caulk, FireDam 150+caulk or FB-3000 WT sealant.
(Note: CP 25WB+ and FireDam 150+ not suitable for use with CPVC pipes.)

*Bearing the UL Classification Mark

++Bearing the UL Listing Mark

Reprinted from the Online Certifications Directory with permission from Underwriters Laboratories Inc.
Copyright © 2010 Underwriters Laboratories Inc.®



Note: Systems with Nonmetallic Through Penetrant(s) have not been evaluated with a pressure differential of 50 Pa between the exposed and unexposed surfaces as required by the National Building Code of Canada.

System No. F-E-2012

May 20, 2005
 F Rating – 1 Hr
 T Rating – 1 Hr

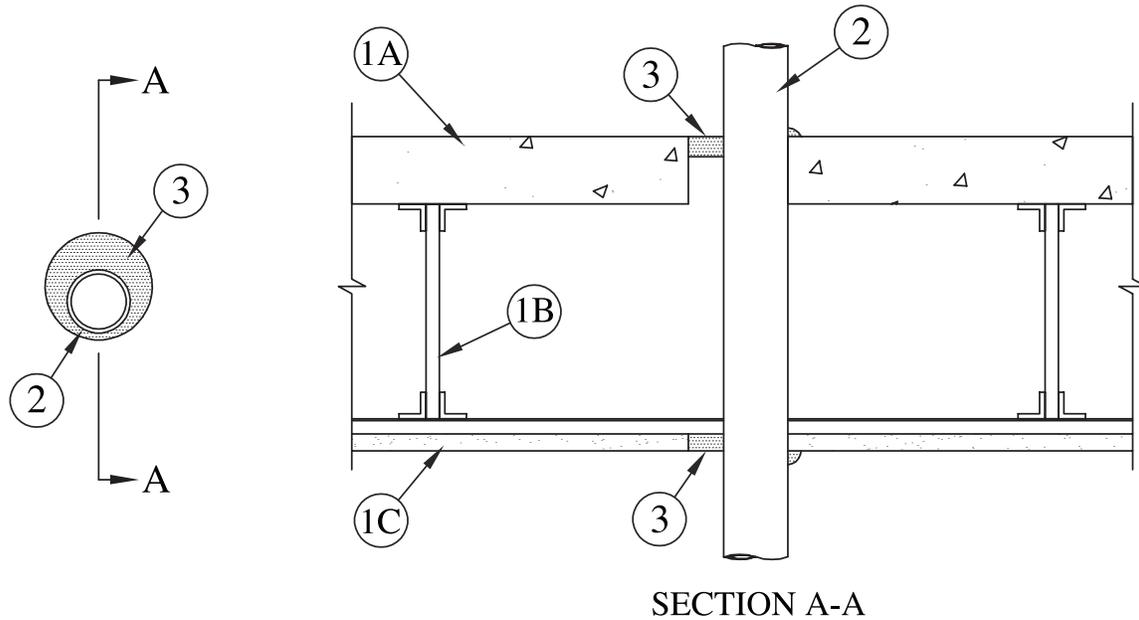

SECTION A-A

- Floor-Ceiling Assembly** – The 1 hr fire rated concrete and steel joist Floor-Ceiling assembly shall be constructed of the materials and in the manner described in the individual G500 Series Design in the UL Fire Resistance Directory, as summarized below:
 - Flooring** – Normal or Lightweight concrete as specified in the individual G500 Series Design. Max diam of opening is 2 in. (51 mm).
 - Joists** – Steel joists or **Structural Steel Members*** as specified in the individual G500 Series Design.
 - Gypsum Board*** – Min 5/8 in. (16 mm) thick, screw-attached to furring channels as specified in the individual G500 Series Design. Max diam of opening is 2 in. (51 mm).
- Crosslinked Polyethylene (PEX) Tubing** – One nom 1 in. (25 mm) diam (or smaller) SDR 9 PEX tubing for use in closed (process or supply) piping systems. Tubing installed concentrically or eccentrically within opening. Annular space between tubing and periphery of opening to be min 0 in. (point contact) to max 3/4 in. (0 mm to max 19 mm). Tubing to be rigidly supported on both sides of floor-ceiling.
- Fill, Void or Cavity Materials* – Caulk or Sealant** – Min 3/4 in. (19 mm) thickness of caulk applied within annulus, flush with top surface of floor. Min 5/8 in. (16 mm) thickness of caulk applied within annulus, flush with bottom surface of ceiling. Min 1/4 in. (6 mm) diam bead of caulk applied at point contact locations at tubing/floor interface on top surface of floor and at tubing/ceiling interface.

3M COMPANY – IC 15WB+, CP 25WB+ caulk or FB-3000 WT sealant.

*Bearing the UL Classification Marking

Reprinted from the Online Certifications Directory with permission from Underwriters Laboratories Inc.

Copyright © 2011 Underwriters Laboratories Inc.®

System No. F-E-2013

November 20, 2009

F Rating – 1 Hr

T Rating – 0 Hr

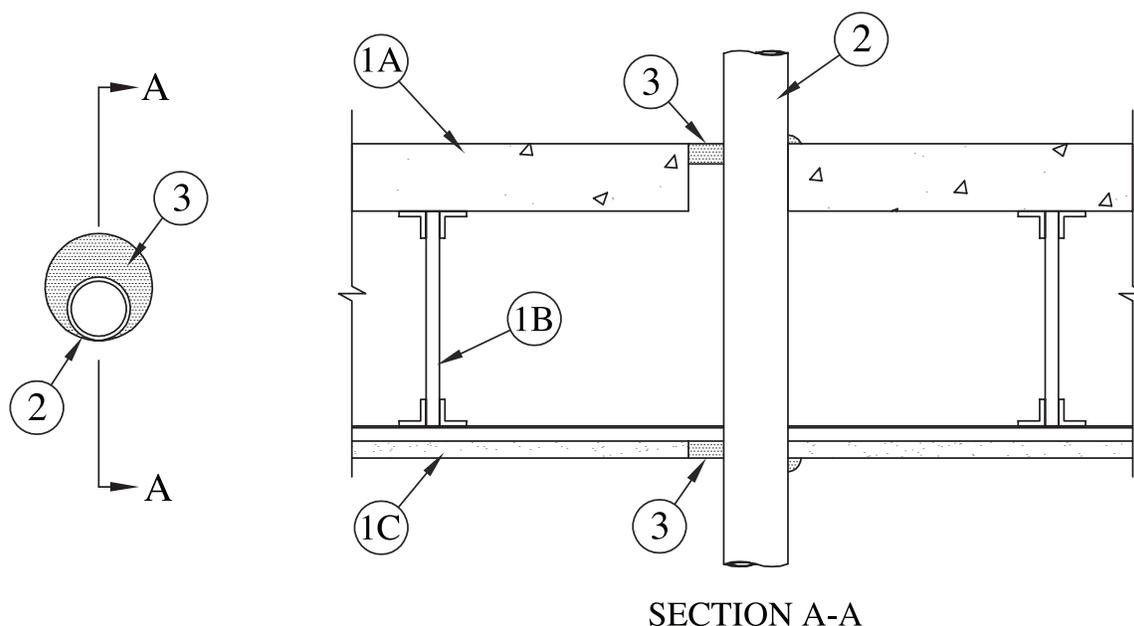

1. **Floor-Ceiling Assembly** – The 1 hr fire rated concrete and steel joist Floor-Ceiling assembly shall be constructed of the materials and in the manner described in the individual G500 Series Design in the UL Fire Resistance Directory, as summarized below:
 - A. **Flooring** – Lightweight or normal weight (100-150 pcf or 1600-2400 kg/m³) concrete as specified in the individual G500 Series Design. Max diam of opening is 3-1/2 in. (89 mm).
 - B. **Joists** – Steel joists or **Structural Steel Members*** as specified in the individual G500 Series Design.
 - C. **Gypsum Board*** – Min 5/8 in. (16 mm) thick, screw-attached to furring channels as specified in the individual G500 Series Design. Max diam of opening is 3-1/2 in. (89 mm).
2. **Through Penetrants** – One nonmetallic pipe or conduit installed eccentrically or concentrically within opening. Annular space between penetrant and periphery of opening to be min 0 in. (0 mm, point contact) to max 1-1/8 in. (29 mm). Penetrant to be rigidly supported on both sides of wall. The following types and sizes of penetrants may be used:
 - A. **Polyvinyl Chloride (PVC) Pipe** – Nom 2 in. (51 mm) diam (or smaller) Schedule 40 solid core or cellular core PVC pipe for use in closed (process or supply) or vented (drain, waste or vent) piping system.
 - B. **Chlorinated Polyvinyl Chloride (CPVC) Pipe** – Nom 2 in. (51 mm) diam (or smaller) SDR13.5 CPVC pipe for use in closed (process or supply) piping systems.
 - C. **Rigid Nonmetallic Conduit**+ – Nom 2 in. (51 mm) diam (or smaller) Schedule 40 PVC conduit installed in accordance with Article 347 of the National Electrical Code (NFPA No. 70).
 - D. **Acrylonitrile Butadiene Styrene (ABS) Pipe** – Nom 1-1/2 in. (38 mm) diam (or smaller) Schedule 40 solid core or cellular core ABS pipe for use in closed (process or supply) or vented (drain, waste or vent) piping systems.
3. **Fill, Void or Cavity Materials*** – **Caulk or Sealant** – Min 3/4 in. (19 mm) thickness of caulk applied within annulus, flush with top surface of floor. Min 5/8 in. (16 mm) thickness of caulk applied within annulus, flush with bottom surface of ceiling. Min 1/4 in. (6 mm) diam bead of caulk applied at point contact locations at penetrant/floor interface on top surface of floor and at penetrant/ceiling interface.

3M COMPANY – IC 15WB+, CP 25WB+, FireDam 150+ caulk or FB-3000 WT sealant.
(Note: CP 25WB+ and FireDam 150+ not suitable for use with CPVC pipes.)

*Bearing the UL Classification Mark

Reprinted from the Online Certifications Directory with permission from Underwriters Laboratories Inc.
Copyright © 2011 Underwriters Laboratories Inc.®

Through Penetrations

Non-Metallic Pipes

2000 Series

Wood Frame Floor/Ceiling

FE

System No. F-E-2040

August 04, 2009

F Rating – 1 Hr

T Rating – 1 Hr

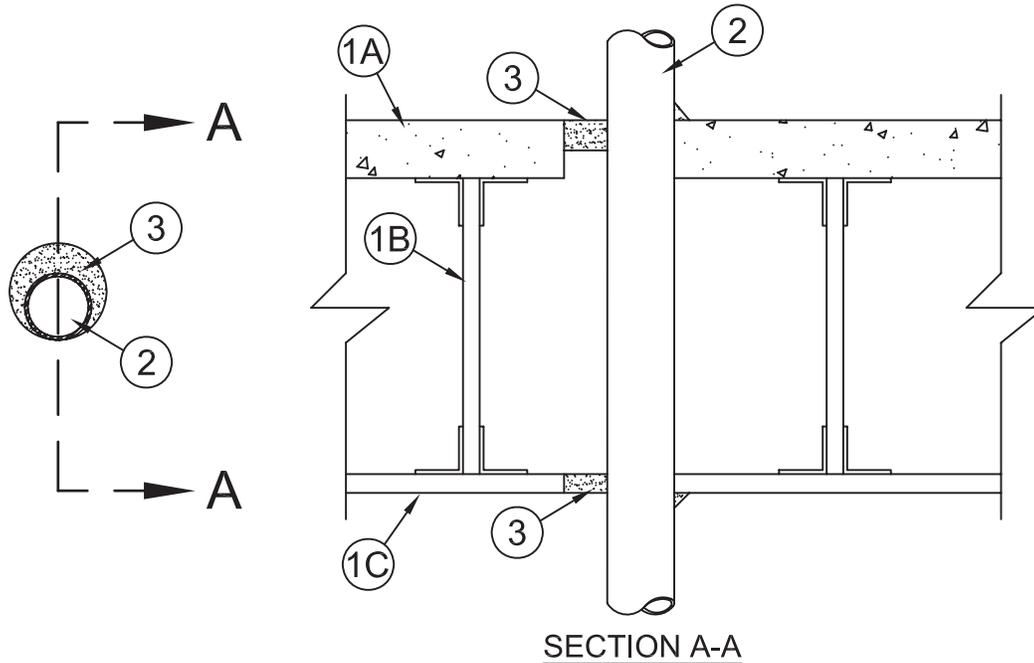

1. **Floor-Ceiling Assembly** – The 1 hr fire rated concrete and steel joist Floor-Ceiling assembly shall be constructed of the materials and in the manner described in the individual G500 Series Design in the UL Fire Resistance Directory, as summarized below:
 - A. **Flooring** – Lightweight or normal weight (100-150 pcf or 1600-2400 kg/m³) concrete as specified in the individual G500 Series Design. Diameter of opening shall be 1-1/2 in. (38 mm) larger than the outside diam of tubing (Items 2).
 - B. **Joists** – Steel joists or **Structural Steel Members*** as specified in the individual G500 Series Design.
 - C. **Gypsum Board*** – Min 5/8 in. (16 mm) thick, screw-attached to furring channels as specified in the individual G500 Series Design. Diameter of opening shall be 1-1/2 in. (38 mm) larger than the outside diam of tubing (Item 2).
2. **Crosslink Polyethylene (PEX) Tubing** – Nom 2 (51 mm) in. diam (or smaller) SDR 9 PEX tubing for use in closed (process or supply) piping system. Tubing installed concentrically or eccentrically within opening. Annular space between tubing and edge of opening to be min 0 in. to max 1-1/2 in. (38 mm). Tubing to be rigidly supported on both sides of floor-ceiling assembly.
3. **Fill, Void or Cavity Materials* – Caulk or Sealant** – Min 3/4 in. (19 mm) thickness of fill material applied within the annulus, flush with top surface of floor. Min 5/8 in. (16 mm) thickness of fill material applied within the annulus, flush with bottom surface of ceiling. An additional min 1/2 in. (13 mm) bead of fill material applied at the tubing/floor interface at point contact location on top surface of floor and at the tubing/ceiling interface at point contact location on lower surface of floor.

3M COMPANY**3M FIRE PROTECTION PRODUCTS** – CP 25WB+, IC 15WB+ or FB-3000 WT

*Bearing the UL Classification Mark

Reprinted from the Online Certifications Directory with permission from Underwriters Laboratories Inc.
Copyright © 2010 Underwriters Laboratories Inc.®

System No. F-E-2040

August 04, 2009

F Rating – 1 Hr

T Rating – 1 Hr

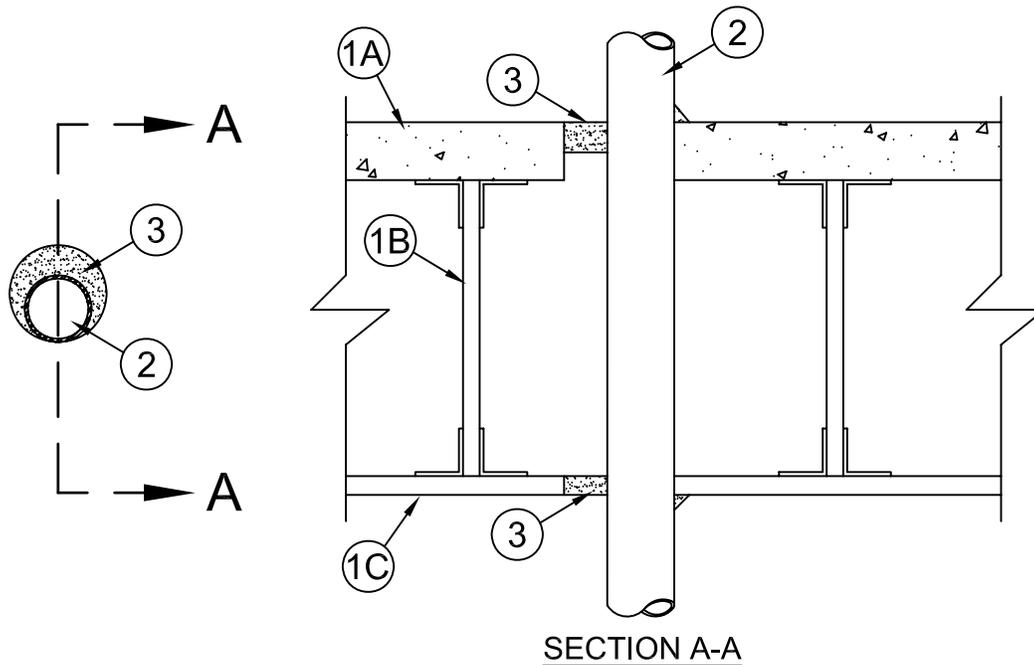

SECTION A-A

1. **Floor-Ceiling Assembly** – The 1 hr fire rated concrete and steel joist Floor-Ceiling assembly shall be constructed of the materials and in the manner described in the individual G500 Series Design in the UL Fire Resistance Directory, as summarized below:
 - A. **Flooring** – Lightweight or normal weight (100-150 pcf or 1600-2400 kg/m³) concrete as specified in the individual G500 Series Design. Diameter of opening shall be 1-1/2 in. (38 mm) larger than the outside diam of tubing (Items 2).
 - B. **Joists** – Steel joists or **Structural Steel Members*** as specified in the individual G500 Series Design.
 - C. **Gypsum Board*** – Min 5/8 in. (16 mm) thick, screw-attached to furring channels as specified in the individual G500 Series Design. Diameter of opening shall be 1-1/2 in. (38 mm) larger than the outside diam of tubing (Item 2).
2. **Crosslink Polyethylene (PEX) Tubing** – Nom 2 (51 mm) in. diam (or smaller) SDR 9 PEX tubing for use in closed (process or supply) piping system. Tubing installed concentrically or eccentrically within opening. Annular space between tubing and edge of opening to be min 0 in. to max 1-1/2 in. (38 mm). Tubing to be rigidly supported on both sides of floor-ceiling assembly.
3. **Fill, Void or Cavity Materials* – Caulk or Sealant** – Min 3/4 in. (19 mm) thickness of fill material applied within the annulus, flush with top surface of floor. Min 5/8 in. (16 mm) thickness of fill material applied within the annulus, flush with bottom surface of ceiling. An additional min 1/2 in. (13 mm) bead of fill material applied at the tubing/floor interface at point contact location on top surface of floor and at the tubing/ceiling interface at point contact location on lower surface of floor.

3M COMPANY**3M FIRE PROTECTION PRODUCTS** – CP 25WB+, IC 15WB+ or FB-3000 WT

*Bearing the UL Classification Mark

Reprinted from the Online Certifications Directory with permission from UL

© 2012 UL LLC

System No. F-E-2042

August 09, 2010

F Rating – 1 Hr

T Rating – 1 Hr

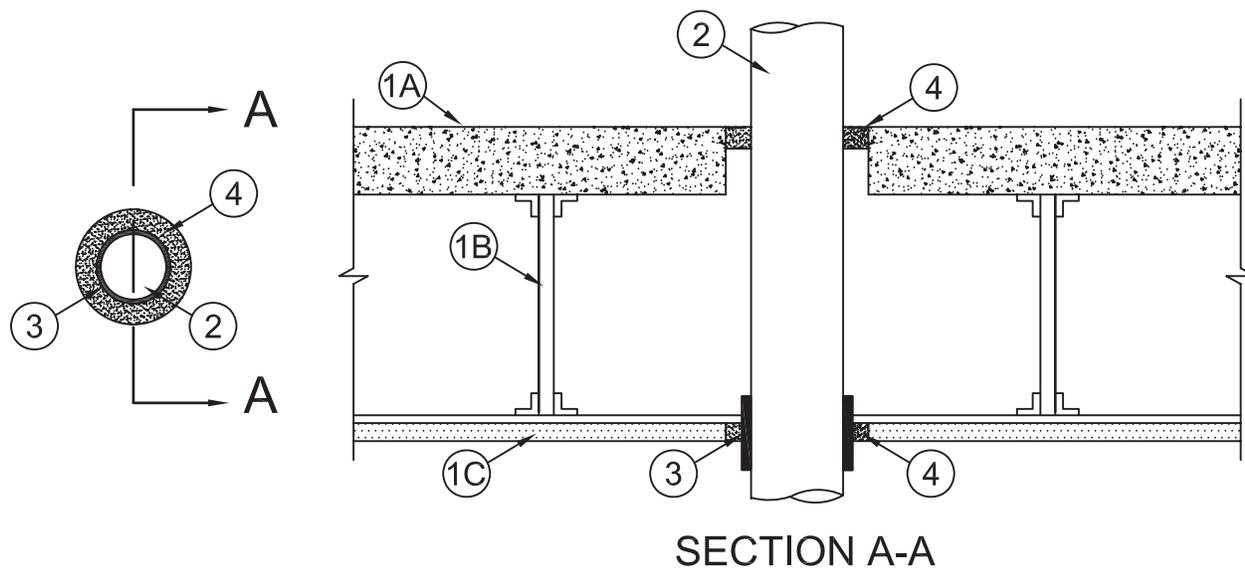

- Floor-Ceiling Assembly** – The 1 hr fire rated concrete and steel joist Floor-Ceiling assembly shall be constructed of the materials and in the manner described in the individual G500 Series Design in the UL Fire Resistance Directory, as summarized below:
 - Concrete Floor** – Normal weight or lightweight (100-150 pcf or 1600-2400 kg/m³) concrete over metal lath or steel deck as specified in the individual G500 Series Design. Max diam of floor opening is 6 in. (152 mm).
 - Joists** – Steel joists or **Structural Steel Members*** as specified in the individual G500 Series Design.
 - Gypsum Board*** – Min 5/8 in. (16 mm) thick, screw-attached to steel furring channels as specified in the individual G500 Series Design. Max diam of ceiling opening is 6 in. (152 mm).
- Through Penetrant** – One nonmetallic pipe or conduit to be centered within the opening. Annular space between the pipe or conduit and the periphery of the opening shall be nom 3/4 in. (19 mm). Penetrant to be rigidly supported on both sides of floor-ceiling assembly. The following types and sizes of nonmetallic pipe or conduit may be used:
 - Polyvinyl Chloride (PVC) Pipe** – Nom 4 in. (102 mm) diam (or smaller) Schedule 40 solid or cellular core PVC pipe for use in closed (process or supply) or vented (drain, waste or vent) piping systems.
 - Rigid Nonmetallic Conduit (RNC)+** – Nom 4 in. (102 mm) diam (or smaller) Schedule 40 PVC conduit installed in accordance with the National Electrical Code (NFPA 70).
- Fill, Void or Cavity Material*** – **Wrap Strip** – Min 3/16 in. (5 mm) thick intumescent material supplied in 2-1/2 in. (64 mm) wide strips. Single layer of pre-cut wrap strip tightly wrapped around nonmetallic pipe and secured with the adhesive closure tab. Wrap strip is to be recessed within the opening in the gypsum board ceiling such that the bottom of the wrap strip layer is 7/8 in. (22 mm) below the bottom plane of the ceiling.

3M COMPANY
3M FIRE PROTECTION PRODUCTS – Fire Barrier Tuck-In Wrap Strip WS 200, WS 300 or WS 400
- Fill, Void or Cavity Material*** – **Sealant** – Min 3/4 in. (19 mm) thickness of fill material applied within the annulus, flush with the top surface of the floor. Min 5/8 in. (16 mm) thickness of fill material applied within the annulus, flush with the bottom surface of the gypsum board ceiling.

3M COMPANY
3M FIRE PROTECTION PRODUCTS – IC 15WB+, CP 25WB+ or FB-3000 WT Sealant

*Bearing the UL Classification Mark

Reprinted from the Online Certifications Directory with permission from Underwriters Laboratories Inc.

Copyright © 2010 Underwriters Laboratories Inc.®



Note: Systems with Nonmetallic Through Penetrant(s) have not been evaluated with a pressure differential of 50 Pa between the exposed and unexposed surfaces as required by the National Building Code of Canada.

Through Penetrations

Non-Metallic Pipes

2000 Series

Wood Frame Floor/Ceiling

FE

System No. F-E-2044

June 11, 2012

F Rating – 1 Hr

FT Rating – 0 Hr

FH Rating – 1 Hr

FTH Rating – 0 Hr

Leakage Rating at Ambient – Less Than 1 CFM/ft²

Leakage Rating at 204° C – 5 CFM/ft²

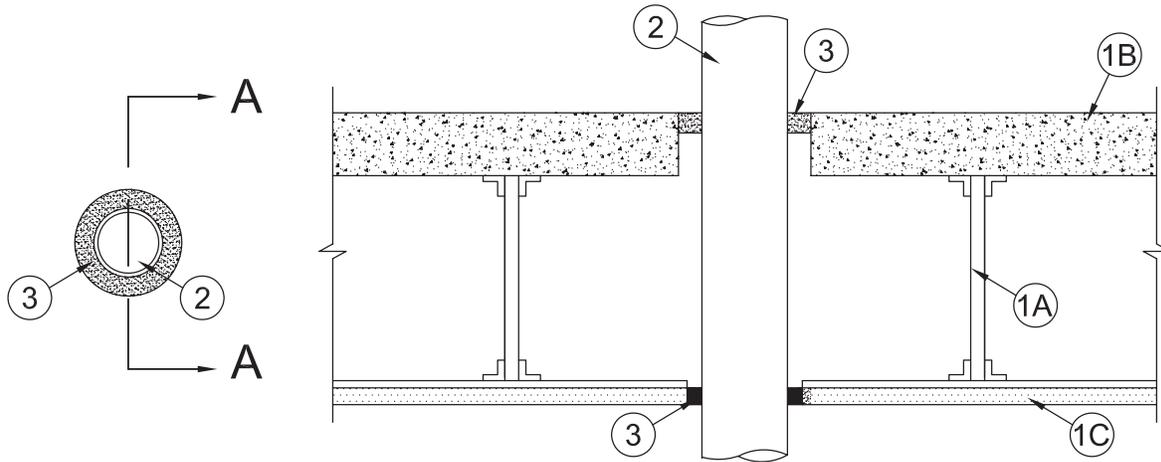

SECTION A-A

System tested with a pressure differential of 50 Pa between the exposed and the unexposed surfaces with the higher pressure on the exposed side.

- 1. Floor-Ceiling Assembly** – The 1 Hr fire rated concrete and steel joist Floor-Ceiling assembly shall be constructed of the materials and in the manner described in the individual G500 Series Design in the UL Fire Resistance Directory, as summarized below:
 - A. Joists** – Steel joists or **Structural Steel Members*** as specified in the individual G500 Series Design.
 - B. Flooring** – Normal weight or lightweight concrete as specified in the individual G500 Series Design. Diam of opening to be 25 mm (1 in.) larger than nom size of penetrant.
 - C. Gypsum Board*** – Min 5/8 in. (10 mm) thick, screw-attached to furring channels as specified in the individual G500 Series Design. Diam of opening to be 25 mm (1 in.) larger than nom size of penetrant.
- 1.1 Chase Wall** – (Optional, Not Shown) – The through penetrant (Item 2) may be routed through a 1 hr fire rated single, double or staggered wood stud/gypsum board chase wall constructed of the materials and in the manner specified in the individual U300 Series Wall and Partition Designs in the UL Fire Resistance Directory and shall include the following construction features:
 - A. Studs** – Nom 51 by 102 mm (2 by 4 in.) (or larger) or double nom 51 by 102 mm (2 by 4 in.) lumber studs.
 - B. Sole Plate** – Nom 51 by 102 mm (2 by 4 in.) (or larger) or parallel 51 by 102 mm (2 by 4 in.) lumber plates, tightly butted. Diam of opening to be 25 mm (1 in.) larger than nom size of penetrant.
 - C. Top Plate** – The double top plate shall consist of two nom 51 by 102 mm (2 by 4 in.) (or larger) or two sets of parallel nom 51 by 102 mm (2 by 4 in.) (or larger) lumber plates, tightly butted. Diam of opening to be 25 mm larger than nom size of penetrant.
 - D. Gypsum Board*** – Thickness, type, number of layers and fasteners shall be as specified in individual Wall and Partition Design.
- 2. Through Penetrant** – One nonmetallic pipe, conduit or tubing to be centered within the firestop system. Annular space between pipe and edge of opening to be min 6 mm (1/4 in.) to max 10 mm (3/8 in.). Pipe to be rigidly supported on both sides of floor-ceiling assembly. The following types and sizes of nonmetallic pipes may be used:
 - A. Polyvinyl Chloride (PVC) Pipe** – Nom 51 mm (2 in.) diam (or smaller) Schedule 40 solid or cellular core PVC pipe for use in closed (process or supply) or vented (drain, waste or vent) piping system.
 - B. Chlorinated Polyvinyl Chloride (CPVC) Pipe** – Nom 51 mm (2 in.) diam (or smaller) SDR13.5 CPVC pipe for use in closed (process or supply) piping systems.
 - C. Acrylonitrile Butadiene Styrene (ABS) Pipe** – Nom 51 mm (2 in.) diam (or smaller) Schedule 40 solid or cellular core ABS pipe for use in closed (process or supply) or vented (drain, waste or vent) piping system.
 - D. Rigid Nonmetallic Conduit+** – Nom 51 mm (2 in.) diam (or smaller) Schedule 40 PVC conduit installed in accordance with the National Electrical Code (NFPA No. 70).
 - E. Electrical Nonmetallic Tubing (ENT)+** – Nom 51 mm (2 in.) diam (or smaller) corrugated-wall electrical nonmetallic tubing (ENT) constructed of polyvinyl chloride (PVC) and installed in accordance with the National Electrical Code (NFPA No. 70).
 - F. Flexible Nonmetallic Conduit, Liquid-Tight (FNMC)+** – Nom 51 mm (2 in.) diam (or smaller) corrugated-wall flexible nonmetallic conduit, liquid-tight (FNMC) constructed of polyvinyl chloride (PVC) and installed in accordance with the National Electrical Code (NFPA No. 70).
 - G. Crosslinked Polyethylene (PEX) Tubing** – Nom 51 mm (2 in.) diam (or smaller) SDR 7.3 or SDR 9 PEX tubing for use in closed (process or supply) piping systems or nom 51 mm (2 in.) diam (or smaller) SDR 9 PEX tubing for use in closed (process or supply) or vented (drain, waste or vent) piping systems.

System No. F-E-2044 *continued*

- Fill, Void or Cavity Materials* – Sealant** – Min 19 mm (3/4 in.) thickness of fill material applied within the annulus, flush with top surface of floor or sole plate. Min 16 mm (5/8 in.) thickness of fill material applied within the annulus, flush with bottom surface of ceiling or lower top plate.

3M COMPANY

3M FIRE PROTECTION PRODUCTS – FB-3000 WT Sealant

*Bearing the UL Classification Mark

+ Bearing the UL Listing Mark

Reprinted from the Online Certifications Directory with permission from UL
© 2012 UL LLC



Through Penetrations

Non-Metallic Pipes

2000 Series

Wood Frame Floor/Ceiling

FE

Cables

CAJ

Concrete floors with a minimum thickness less than or equal to 5 inches (127 mm)
Concrete or masonry walls with a minimum thickness less than or equal to 8 inches (203 mm)

CBJ

Concrete floors with a minimum thickness greater than 5 inches (127 mm)
Concrete or masonry walls with a minimum thickness less than or equal to 8 inches (203 mm)

FA

Concrete floors/Steel decks
Concrete or masonry walls with a minimum thickness less than or equal to 8 inches (203 mm)

FB

Concrete floors/Steel decks
Concrete floors with a minimum thickness greater than 5 inches (127 mm)

FC

Floor assemblies
Framed floors

FE

Truss floor assemblies

WJ

Floor assemblies
Concrete or masonry walls with a minimum thickness less than or equal to 8 inches (203 mm)

WL

Wall assemblies
Framed walls

Cables • Concrete

| 3M UL Systems | "F" Rating | 3M Product | Through Penetrant Details |
|---------------|------------|---|---|
| C-AJ-3005 | 1, 2, 3 | 3M™ Fire Barrier Sealant CP 25WB+ 3M™ Fire Barrier Sealant IC 15WB+ 3M™ Fire Barrier Composite Sheet CS-195+ 3M™ Fire Barrier Wrap Strips FS-195+ 3M™ Fire Barrier Moldable Putty Stix MP+ 3M™ Expantrol™ Flexible Intumescent Strip E-FIS 3M™ Fire Barrier Wrap Ultra GS 3M™ Fire Barrier Water Tight Sealant 3000 WT | Max. 4 in. cable bundle penetrating a max. 36 square foot opening in a concrete floor or wall utilizing CS 195+ Composite Sheet, FS 195+ Wrap Strip, and sealant. 1, 2, or 3 hour F rating. |
| C-AJ-3021 | 2 | 3M™ Fire Barrier Moldable Putty Stix MP+ 3M™ Fire Barrier Packing Material PM4 | Max. 6-1/4 in. opening in a concrete floor or wall having max. 40 percent cable fill. |
| C-AJ-3029 | 2 | 3M™ Fire Barrier Silicone Sealant 2000+ 3M™ Fire Barrier Water Tight Sealant 1000 NS 3M™ Fire Barrier Water Tight Sealant 1003 SL | Single telephone cable penetrating a concrete floor or wall. |
| C-AJ-3030 | 1.5, 2, 3 | 3M™ Fire Barrier Sealant CP 25WB+ 3M™ Fire Barrier Water Tight Sealant 3000 WT | Max. 8 in. diameter opening with max. 40 percent cable fill through a minimum 2.5 in. thick concrete floor or wall. Steel or PVC sleeve optional. |
| C-AJ-3031 | 2 | 3M™ Fire Barrier Sealant CP 25WB+ | Single Metal Clad cable penetrating a min. 4.5 in. thick concrete floor or wall. |
| C-AJ-3041 | 2, 3 | 3M™ Fire Barrier Silicone Sealant 2000+ 3M™ Fire Barrier Water Tight Sealant 1000 NS 3M™ Fire Barrier Water Tight Sealant 1003 SL | Single Metal Clad cable penetrating a min. 4.5 in. thick concrete floor or wall. |
| C-AJ-3044 | 2 | 3M™ Fire Barrier Sealant CP 25WB+ 3M™ Fire Barrier Sealant IC 15WB+ 3M™ Fire Barrier Composite Sheet CS-195+ 3M™ Fire Barrier Wrap Strips FS-195+ 3M™ Fire Barrier Moldable Putty Stix MP+ 3M™ Expantrol™ Flexible Intumescent Strip E-FIS 3M™ Fire Barrier Water Tight Sealant 3000 WT 3M™ Fire Barrier Wrap Ultra GS | Multiple max. 3-1/4 in. telephone riser cables penetrating a max. 240 square inch opening in a concrete floor or wall. Utilizing CS 195+ Composite Sheet, FS 195+ Wrap Strips, and sealant. |
| C-AJ-3058 | 2 | 3M™ Fire Barrier Wrap Strips FS-195+ 3M™ Fire Barrier Ultra Plastic Pipe Device 3M™ Fire Barrier Moldable Putty Stix MP+ 3M™ Fire Barrier Moldable Putty Pads MPP+ 3M™ Fire Barrier RC-1 Restricting Collar | Telephone and/or fiber optic cables within a max. 4 in. PVC sleeve which extends min. 6 in. beyond both surfaces of the concrete wall or floor. |
| C-AJ-3080 | 2, 3 | 3M™ Fire Barrier Sealant CP 25WB+ 3M™ Fire Barrier Sealant IC 15WB+ | Multiple Metal Clad or twisted copper conductor cables penetrating a max. 6 in. diameter opening in a concrete floor or wall. |
| C-AJ-3107 | 2 | 3M™ Fire Barrier Sealant CP 25WB+ | Single Metal Clad cable penetrating a min. 4.5 in. thick concrete floor or wall. |
| C-AJ-3108 | 2, 3 | 3M™ Fire Barrier Sealant CP 25WB+ | Multiple Metal Clad cables penetrating a max. 6 in. diameter opening in a concrete floor or wall. |
| C-AJ-3110 | 2 | 3M™ Fire Barrier Sealant CP 25WB+ | Single Metal Clad cable penetrating a min. 4.5 in. thick concrete floor or wall. |
| C-AJ-3111 | 2, 3 | 3M™ Fire Barrier Sealant CP 25WB+ | Multiple Metal Clad cables penetrating a max. 6 in. diameter opening in a concrete floor or wall. |
| C-AJ-3137 | 2 | 3M™ Fire Barrier Sealant CP 25WB+ 3M™ Fire Barrier Water Tight Sealant 3000 WT | Max. 4 in. diameter opening, steel sleeve optional, in a concrete floor or wall with max. 60.5% aggregate cross-sectional area cable fill. |
| C-AJ-3150 | 2, 3 | 3M™ Fire Barrier Water Tight Sealant 1000 NS 3M™ Fire Barrier Water Tight Sealant 1003 SL 3M™ Fire Barrier Water Tight Sealant 3000 WT | Max. 6 in. diameter opening, steel or PVC sleeve optional, in a concrete floor or wall with max. 45% aggregate cross-sectional area cable fill. |
| C-AJ-3164 | 2 | 3M™ Fire Barrier Sealant CP 25WB+ 3M™ Fire Barrier Sealant IC 15WB+ 3M™ Fire Barrier Sealant FD 150+ 3M™ Fire Barrier Water Tight Sealant 3000 WT | Max. 4 in. diameter opening in a concrete floor or wall with max. 60% aggregate cross-sectional area cable fill. |
| C-AJ-3200 | 2 | 3M™ Fire Barrier Sealant CP 25WB+ 3M™ Fire Barrier Sealant IC 15WB+ 3M™ Fire Barrier Water Tight Sealant 3000 WT 3M™ Fire Barrier Packing Material PM4 | Max. 6 in. diameter opening, steel sleeve optional, in a concrete floor or wall with max. 49% aggregate cross-sectional area cable fill. |
| C-AJ-3250 | 2, 3 | 3M™ Fire Barrier Pass-Through Products 3M™ Fire Barrier Water Tight Sealant 3000 WT 3M™ Fire Barrier Sealant CP 25WB+ 3M™ Fire Barrier Sealant IC 15WB+ 3M™ Fire Barrier Moldable Putty Stix MP+ | Fire Barrier Pass-Through Device system for single or multiple Devices through a min. 2.5 in. thick concrete floor or wall. |

Cables • Concrete

| 3M UL Systems | "F" Rating | 3M Product | Through Penetrant Details |
|------------------|------------|--|---|
| C-AJ-3263 | 2, 3 | 3M™ Fire Barrier Sealant CP 25WB+ 3M™ Fire Barrier Sealant IC 15WB+ 3M™ Fire Barrier Water Tight Sealant 3000 WT | Bottom side or top side access for a max. 6 in. diameter opening in a min. 2.5 in. thick concrete floor or wall. Max. 44% aggregate cross-sectional area cable fill. Steel sleeve optional. |
| C-AJ-3300 | 2, 3 | 3M™ Fire Barrier Water Tight Sealant 1000 NS 3M™ Fire Barrier Water Tight Sealant 1003 SL 3M™ Fire Barrier Water Tight Sealant 3000 WT | Max. 3 in. metal clad cable penetrating a max. 5 in. opening in a concrete floor or wall. |
| C-AJ-3310 | 2, 3 | 3M™ Fire Barrier Putty Sleeves 3M™ Fire Barrier Moldable Putty Stix MP+ | Putty Sleeve Kit system for cables penetrating a concrete floor or wall. |
| C-AJ-3321 | 2 | 3M™ Fire Barrier Rated Foam FIP 1-Step | Max. 6 in. diameter opening in a min. 2.5 in. thick concrete floor or wall with max. 65% aggregate cross-sectional area cable fill. Utilizing Fire Barrier Rated Foam, FIP 1-Step. |
| C-AJ-3339 | 2 | 3M™ Fire Barrier Plug | Max. 5 in. diameter opening in a concrete floor or wall, steel sleeve optional, utilizing a Fire Barrier Plug and sealant. |
| C-BJ-3016 | 4 | 3M™ Fire Barrier Sealant CP 25WB+ 3M™ Fire Barrier Composite Sheet CS-195+ 3M™ Fire Barrier Wrap Strips FS-195+ 3M™ Fire Barrier Water Tight Sealant 3000 WT | Multiple cables and/or max. 3 in. diameter cable bundles penetrating the same max. 1500 square in. opening in a 4 hour concrete floor or wall. |
| C-BJ-3017 | 4 | 3M™ Fire Barrier Sealant CP 25WB+ 3M™ Fire Barrier Sealant IC 15WB+ 3M™ Fire Barrier Composite Sheet CS-195+ 3M™ Fire Barrier Moldable Putty Stix MP+ 3M™ Fire Barrier Water Tight Sealant 3000 WT | Multiple cables and/or max. 3 in. diameter cable bundles penetrating the same max. 1500 square in. opening in a 4 hour concrete floor or wall. |
| F-A-3001 | 1, 2, 3 | 3M™ Fire Barrier Sealant CP 25WB+ 3M™ Fire Barrier Water Tight Sealant 3000 WT | Fiber optic cables, 150 pair 24 AWG telephone. Single or max 2" cable bundles min 4" to max 8" apart. Max area of opening 500 sq. in. Max length 50". Max width 10". Support hanger system. Steel cover plate or support strip required. Mineral wool required. 3 hour F Rating. Also known as FA3001. |
| F-A-3002 | 1, 2 | 3M™ Fire Barrier Sealant CP 25WB+ 3M™ Fire Barrier Sealant IC 15WB+ 3M™ Fire Barrier Water Tight Sealant 3000 WT | 25 pair No. 24 AWG, No. 18 AWG RG 6/U coaxial, 3/C with ground No. 12 AWG cable, 3/C No. 2/0 AWG copper or aluminum SE cable. Max 18% cable fill. Max diam of opening 2 in.. Hollow core system. Sealant only-no mineral wool required. 2 hour F Rating. 1 hour T rating. Also known as FA3002. |
| F-A-3017 | 1, 2, 3 | 3M™ Fire Barrier Cast-In Devices for Metal Pipes 3M™ Fire Barrier Water Tight Sealant 1000 NS 3M™ Fire Barrier Water Tight Sealant 1003 SL 3M™ Fire Barrier Sealant CP 25WB+ 3M™ Fire Barrier Sealant FD 150+ 3M™ Fire Barrier Sealant IC 15WB+ 3M™ Fire Barrier Moldable Putty Stix MP+ 3M™ Fire Barrier Water Tight Sealant 3000 WT | 200 pair No. 22 AWG, 1/C No. 750 Kcmil, 7/C No. 12 AWG, 3/C No. 3/0 AWG, 3/C No. 2/0 AWG, 110/125 fiber optic, 3/C with ground No. 8 AWG, 4 pair No. 24 AWG RG/U, 12 AWG MC. Point contact to max 2" annular. Mineral wool required. 3 hour F Rating. Also known as FA3017. |
| F-A-3020 | 1, 2 | 3M™ Fire Barrier Cast-In Devices for Metal Pipes | Max. 3" diameter of various power and low voltage cables (see system) through max. 4" CID in min. 2-1/2" thick concrete over fluted steel pan deck. Also referred to as FA3020. |
| F-A-3053 | 1, 2 | 3M™ Fire Barrier Pillows 3M™ Fire Barrier Self-Locking Pillows 3M™ Fire Barrier MP+ Moldable Putty Stix | Cable rack with max. 62% aggregate cable fill percentage penetrating a concrete floor. Utilizing Fire Barrier Pillows and MP+ Putty Stix. |
| F-B-3004 | 1, 2 | 3M™ Fire Barrier Sealant CP 25WB+ 3M™ Fire Barrier Composite Sheet CS-195+ 3M™ Fire Barrier Moldable Putty Stix MP+ 3M™ Fire Barrier Water Tight Sealant 3000 WT 3M™ Fire Barrier Wrap Ultra GS 3M™ Expantrol™ Flexible Intumescent Strip E-FIS | 20" x 2" cable rack, 72 pair 26 AWG, 750 kcmil. Max area of opening 288 sq. in. Max dimension 24". Steel angles, sheathing, and stirrups required. Optional steel cover plate. Bottom side application. 2 hour F Rating. Also known as FB3004. |
| F-B-3005 | 1 | 3M™ Fire Barrier Sealant CP 25WB+ 3M™ Fire Barrier Sealant IC 15WB+ | 1/2" diameter metal clad cable penetrating a min. 6 in thick concrete floor. |
| F-B-3008 | 1, 2 | 3M™ Fire Barrier Sealant CP 25WB+ 3M™ Fire Barrier Sealant IC 15WB+ 3M™ Fire Barrier Sealant FD 150+ 3M™ Fire Barrier Water Tight Sealant 3000 WT | 1/C 350 kcmil, 150 pair 24 ga cable, 3/C 2/0 aluminum or copper cable, 3/C 12 AWG MC cable, RG 6/U No. 18 AWG coaxial, max 2-125/250 fiber optic cable. Max diam of opening 4". Hollow core included. Min 24% to max 60% visual fill. Concentric or eccentric installation. Point contact to max 2" annular. Mineral wool required. 2 hour F Rating. Also referred as FB3008. |

| 3M UL Systems | "F" Rating | 3M Product | Through Penetrant Details |
|---------------|------------|---|--|
| F-B-3013 | 1, 2 | 3M™ Fire Barrier Moldable Putty Stix MP+ 3M™ Fire Barrier Moldable Putty Pads MPP+ 3M™ Fire Barrier Pillows 3M™ Fire Barrier Self-Locking Pillows | Max. 40% fill of power and low voltage cables through min. 8" thick concrete floor. Also referred to as FB3013. |
| F-B-3016 | 1, 2 | 3M™ Fire Barrier Pillows 3M™ Fire Barrier Self-Locking Pillows 3M™ Fire Barrier Composite Sheet CS-195+ 3M™ Expanrol™ Flexible Intumescent Strip E-FIS 3M™ Fire Barrier Wrap Ultra GS 3M™ Fire Barrier Moldable Putty 3M™ Fire Barrier Sealant CP 25WB+ 3M™ Fire Barrier Water Tight Sealant 3000 WT | Max area of opening 288 sq. in. with max dimension 24 in. Annular between max 20 in. wide ladder cable rack and opening min point contact to max 8 in. Steel sheathing required. 34% fill of telecommunications or power cables. 2 hour F. Steel channel sleeve required. Pillows not required between sheathing and channel sleeve. Optional steel coverplate. Also known as FB3016. |
| F-B-3017 | 1, 2 | 3M™ Fire Barrier Pillows 3M™ Fire Barrier Self-Locking Pillows 3M™ Fire Barrier MP+ Moldable Putty Stix | Cable rack with max. 62% cable fill penetrating a max. 432 square in. opening in a concrete floor slab through structural steel sheathing. |
| F-B-3018 | 1, 2 | 3M™ Fire Barrier Sealant CP 25WB+ 3M™ Fire Barrier Packing Material PM4 | Max 5 in. diameter 161 KV 20000MM power cables. Max 3 per opening. Min 8 in. concrete floor. Max 400 sq. in. opening with max 20 in. dimension. 3M Packing Material PM rolled into cylinders. 2 hour F and T rating. Also known as FB3018. |
| W-J-3081 | 1, 2 | 3M™ Fire Barrier Sealant CP 25WB+ 3M™ Fire Barrier Sealant IC 15WB+ | Maximum 200 pair, 350 kcmil, 7/C 12, 3/C 2/O, 4/C 2/O AWG, 110/125 fiber optic, 3/C with ground, RG/U coaxial cable, 4 pair, armored cable or metal clad cable. Also referred as WJ3081. |
| W-J-3082 | 1, 2 | 3M™ Fire Barrier Sealant CP 25WB+ 3M™ Fire Barrier Sealant IC 15WB+ | Multiple 4" diameter cable bundle, 200 pair, 350 kcmil, 7/C, 3/C, 4/C 2/O AWG, 110/125 fiber optic, 3/C with ground, RG/U coaxial cable, 4 pair, armored cable or metal clad cable. Also referred as WJ3082. |
| W-J-3169 | 1, 2 | 3M™ Fire Barrier Sealant CP 25WB+ 3M™ Fire Barrier Water Tight Sealant 3000 WT 3M™ Fire Barrier Self-Locking Pillows 3M™ Fire Barrier Pillows 3M™ Fire Barrier Moldable Putty Stix MP+ | Any UL listed cable, armored cable, metal clad cable. See system for details. Max area of opening 225 sq. in. with max dimension of 22-1/2 in. Max 49% aggregate cross-sectional area. Annular between cable and opening point contact to max 4 in. Horizontal between cable min 1/4 in. to max 4 in. Vertical between cable min 1-1/2 in. to max 4 in. 2 hour F rating. Also known as WJ3169. |
| W-J-3170 | 1, 2 | 3M™ Fire Barrier Sealant CP 25WB+ 3M™ Fire Barrier Water Tight Sealant 3000 WT 3M™ Fire Barrier Sealant IC 15WB+ 3M™ Fire Barrier Sealant FD 150+ | Any UL listed cable, armored cable, metal clad cable. See system for details. Max area of opening 67-1/2 sq. in. with max dimension of 22-1/2 in. Max 49% aggregate cross-sectional area. Annular between cable and opening point contact to max 1-1/4 in. Horizontal between cable min 1/4 in. to max 1 in. No packing material required. 2 hour F rating. Also known as WJ3170. |
| W-J-3171 | 1, 2 | 3M™ Fire Barrier Sealant CP 25WB+ 3M™ Fire Barrier Water Tight Sealant 3000 WT 3M™ Fire Barrier Sealant IC 15WB+ | Any UL listed cable, armored cable, metal clad cable. See system for details. Max area of opening 182 sq. in. with max dimension of 45-1/2 in. Max 49% aggregate cross-sectional area. Annular between cable and opening point contact to max 2 in. Horizontal between cable min 1/4 in. to max 1 in. Packing material required. 2 hour F rating. Also known as WJ3171. |
| W-J-3177 | 1, 2 | 3M™ Fire Barrier Sealant CP 25WB+ 3M™ Fire Barrier Sealant IC 15WB+ 3M™ Fire Barrier Water Tight Sealant 3000 WT 3M™ Fire Barrier Rated Foam FIP 1-Step | Max 6 in. EMT sleeve or Schedule 5 pipe. 50% cable fill. Min 4-1/2 in. concrete wall. Annular space between sleeve and opening point contact to max 1/2 in. Sleeve flush with each side of wall or may extend a maximum 18 in. beyond each side of wall. Mineral wool required inside sleeve. 1 & 2 hour F rating. Also known as WJ3177. |
| W-J-3185 | 1, 2 | 3M™ Fire Barrier Sealant CP 25WB+ 3M™ Fire Barrier Packing Material PM4 | Max 5 in. diameter 161 KV 20000MM power cables. Max 3 per opening. Min 8 in. concrete wall. Max diam of opening 14 in. 14 in. PVC sleeve cast in place extending 1 in. past wall face. Metal enclosure attached to one side of wall. 3M Packing Material PM rolled into cylinders. 2 hour F and T rating. Sealant on one side of wall only. Also known as WJ3185. |

System No. C-AJ-3005

December 31, 2008

F Ratings – 1, 2 and 3 Hr (See Items 1 and 2)

T Rating – 0 Hr

L Rating At Ambient – 76 CFM/sq ft (See Item 5)

L Rating At 400 F – 7 CFM/sq ft (See Item 5)

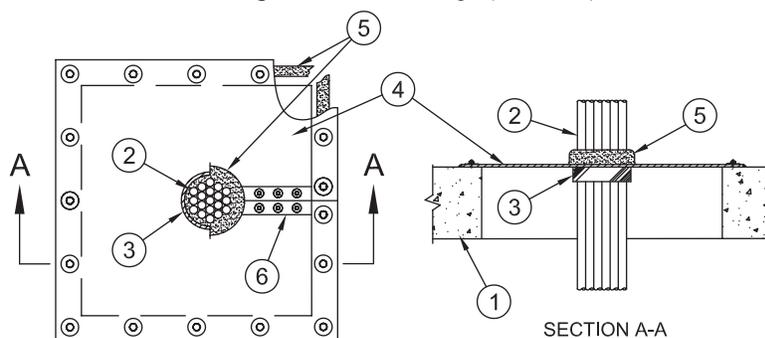

- Floor or Wall Assembly** – Lightweight or normal weight (100-150 pcf) (1601 - 2400 kg/m³) concrete. Min thickness of concrete floor or wall is 2-1/2 in. (64 mm) for 1 hr F Rating and 4-1/2 in. (114 mm) for 2 and 3 hr F Ratings. Wall may also be constructed of any UL Classified **Concrete Blocks***. Max area of opening 36 sq ft (232 cm²) with one dimension of opening being 36 in. (914 mm) or less. See **Concrete Blocks (CAZT)** category in the Fire Resistance Directory for names of manufacturers.
- Cables** – Nom 4 in. (102 mm) diam (or smaller) tight bundle of cable. Cable bundle rigidly supported on both sides of floor or wall assembly. The following types and sizes of cables may be used:
 - Max 150 pair No. 24 AWG telephone cable; polyvinyl chloride (PVC) insulation and jacket materials. **When telephone cable is used, F Rating is 1 or 2 hr, depending on floor or wall thickness.**
 - Max No. 2/0 AWG multiconductor power/control cable; cross-linked polyethylene (XLPE) insulation, PVC jacket. **When power/control cable is used, F Rating is 1 or 3 hr, depending on floor or wall thickness.**
 - Max 350 kcmil single-conductor power cable; XLPE insulation. When power cable is used, F Rating is 1 or 3 hr, depending on floor or wall thickness.
- Fill, Void or Cavity Materials* – Wrap Strip** – Nom 1/4 in. (6 mm) thick intumescent elastomeric material faced on one side with aluminum foil, supplied in strips. Min 2 in. (51 mm) wide strip wrapped around cable bundle (foil side exposed) and secured in place with steel wire or aluminum foil tape. Wrap strip to extend approx 7/8 in. (22 mm) beyond each face of the intumescent sheet (Item 4). Prior to installation of the wrap strip on cable bundle, caulk (Item 5) to be forced into cable bundle to fill all interstices between cables throughout 2 in. (51 mm) height of wrap strip layer.

3M COMPANY – FS-195+
- Fill, Void or Cavity Materials* – Intumescent Sheet** – Rigid aluminum foil-faced sheet with galv steel sheet backer. Sheet cut to tightly follow the contours of the cable wrap strip and with a min lap of 2 in. (51 mm) on all sides of the through opening. Sheet to be installed with the galv steel sheet backer exposed (aluminum foil facing against floor or wall surface). Sheet secured to top surface of floor and both sides of wall using min 3/16 in. diam by 1-1/4 in. (5 mm by 32 mm) long steel masonry fasteners with min 1-1/4 in. (32 mm) diam steel fender washers. Max spacing of fasteners not to exceed 6 in. OC.

3M COMPANY – CS-195+
- Fill, Void or Cavity Materials* – Graphite Seal, Caulk or Putty** – One layer of 1/2 in. x 1/16 in. (13 mm by 1.6 mm) adhesive backed graphite intumescent seal positioned under intumescent sheet around entire perimeter of through opening or min 1/4 in. (6 mm) diam continuous bead of caulk or putty applied to edge of intumescent sheet at its interface with surface of floor or wall around entire perimeter of through opening. Generous application of caulk or putty to be applied around the base of the wrap strip at its egress from the intumescent sheet(s) in addition to completely covering the wrap strip up to the interface(s) with the cable bundle. All interstices between cables to be filled with caulk or putty throughout the 2 in. (51 mm) height of the wrap strip.

3M COMPANY – E-FIS or Ultra GS seals, CP 25WB+ caulk, IC 15WB+ caulk, FB-3000 WT sealant or MP+ Stix putty
(Note: L Ratings apply only when CP-25 WB+ or FB-3000 WT is used.)
- Steel Cover Strip** – Min 2 in. (51 mm) wide strip of min 0.015 in. (.4 mm) thick (30 gauge) galv steel centered over entire length of slit made in intumescent sheet (Item 4) to permit installation about the cable bundle. Prior to installation of the steel strip, slit in intumescent sheet covered with nom 1/4 in. (6 mm) diam bead of caulk (Item 5). Steel cover strip secured to galv steel backer of intumescent sheet with steel sheet-metal screws or steel rivets spaced max 2 in. (51 mm) OC on each side of slit.
- Support Channel** – (Not Shown) – When area of through opening exceeds 1440 sq in. (9290 cm²), an intermediate support channel shall be installed flush with top surface of floor or both surfaces of wall. Support channels to be min 1-5/8 by 1-5/8 in. (41 mm by 41 mm) and formed of min 0.093 in. (2.4 mm) thick (No. 12 gauge) painted or galv steel. Ends of steel channel bolted or welded to steel angles anchored to inside walls of through opening. When steel support channels are centered beneath butted seams of intumescent sheets, no steel cover strip (Item 6) is required over butted seam. Intumescent sheet secured to steel support channels with steel sheet metal screws in conjunction with min 1-1/4 in. (32 mm) diam steel fender washers.

When support channel is used beneath butted seam of intumescent sheets, fasteners spaced max 3 in. (76 mm) OC. on each side of butted seam. When support channel is located away from intumescent sheet seam, fasteners spaced max 6 in. (152 mm) OC. Prior to installation of the intumescent sheet(s), a nom 1/4 in. (6 mm) diam continuous bead of caulk (Item 5) shall be applied as gasket over the steel support channel.

*Bearing the UL Classification Mark

Reprinted from the Online Certifications Directory with permission from Underwriters Laboratories Inc.
Copyright © 2010 Underwriters Laboratories Inc.®



System No. C-AJ-3021

March 28, 2012

ANSI/UL1479 (ASTM E814)

F Rating – 2 Hr

T Rating – 0 Hr

CAN/ULC S115

F Rating – 2 Hr

FT Rating – 0 Hr

FH Rating – 2 Hr

FTH Rating – 0 Hr

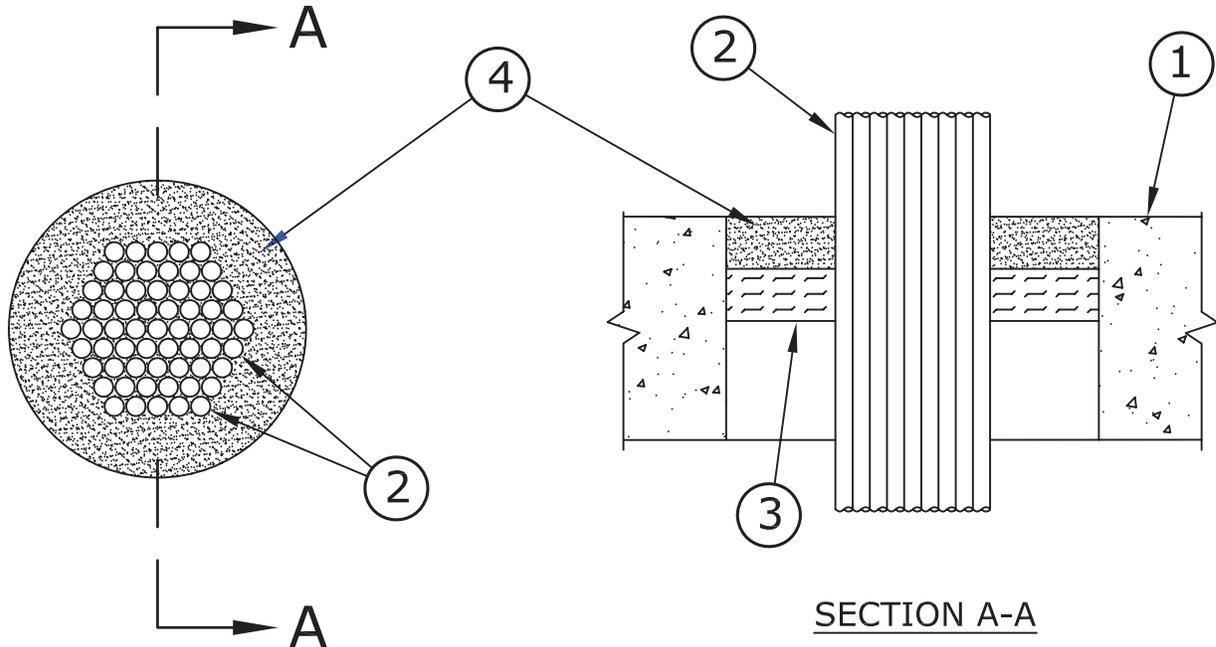
**SECTION A-A**

1. **Floor or Wall Assembly** – Min 4-1/2 in. (114 mm) thick lightweight or normal weight (100-150 pcf or 1600-2400 kg/m³) concrete. Wall may also be constructed of any UL Classified **Concrete Blocks***. Max diam of opening is 6-1/4 in. (159 mm).
See **Concrete Blocks*** (CAZT) category in the Fire Resistance Directory for names of manufacturers.
- 1A. **Steel Sleeve** – (Optional, Not Shown) – Nom 4 in. (102 mm) diam (or smaller) Schedule 10 (or heavier) steel pipe sleeve cast into floor or wall assembly. Sleeve to be flush with floor or wall surfaces.
2. **Cables** – Min 12 percent to max 40 percent fill area per max 4 in. (102 mm) diam steel sleeved through opening. Min 20 percent to max 40 percent fill area per max 6-1/4 in. (159 mm) diam non-sleeved through opening. Cables to be rigidly supported on both sides of floor or wall assembly. The following types and sizes of cables may be used:
 - A. Max 7/C No. 12 AWG multiple copper conductor power and control cables with polyvinyl chloride (PVC) insulation and jacket materials.
 - B. Multiple fiber optical communication cables jacketed with PVC and having a max outside diam of 3/4 in.
 - C. Max 200 pair No. 24 AWG copper conductor telephone cables with PVC insulation and jacket materials.
 - D. Max 350 kcmil power cables with PVC insulation and jacket material.
3. **Packing Material** – Nom 1 in. (25 mm) thickness of ceramic (aluminum silica) fiber blanket or mineral wool batt insulation firmly packed into opening as a permanent form. Packing material to be recessed min 1 in. (25 mm) from top surface of floor or sleeve or from both surfaces of wall.
- 3A. **Forming Material*** – As an alternate to the packing material in Item 3, nom 4 in. (102 mm) wide strips of min 1/2 in. (13 mm) thick compressible mat to be stacked to a thickness greater than the width of the annular space and compression-fitted, edge-first, to fill the annular space to a min 4 in. (102 mm) depth. As an option, the strips of min 1/2 in. (13 mm) thick compressible mat may be folded in half, lengthwise, and stacked to a thickness greater than the width of the annular space and compression-fitted, edge-first, to fill the annular space to a min 2 in. (51 mm) depth. Top of forming material to be recessed from top surface of floor or from both surfaces of wall as necessary to accommodate the required thickness of caulk fill material.

3M COMPANY**3M FIRE PROTECTION PRODUCTS** – Fire Barrier Packing Material

4. **Fill, Void, or Cavity Materials*** – **Putty** – Moldable putty material kneaded by hand and applied to fill annular space (and interstices between cables to max extent possible) to a min depth of 1 in. (25 mm), flush with top surface of floor or sleeve In wall assemblies, required putty depth to be installed symmetrically on both sides of wall.

3M COMPANY**3M FIRE PROTECTION PRODUCTS** – Type MPS-2+

*Bearing the UL Classification Mark

Reprinted from the Online Certifications Directory with permission from UL

© 2013 UL LLC



System No. C-AJ-3029

May 09, 2013

ANSI/UL2079

F Rating – 2 Hr

T Rating – 2 Hr

L Rating At Ambient – Less Than 1 CFM/sq ft

L Rating At 400 F – Less Than 1 CFM/sq ft

CAN/ULC S115

F Rating – 2 Hr

FT Rating – 2 Hr

FH Rating – 2 Hr

FTH Rating – 2 Hr

L Rating At Ambient – Less Than 1 CFM/sq ft

L Rating At 400 F – Less Than 1 CFM/sq ft

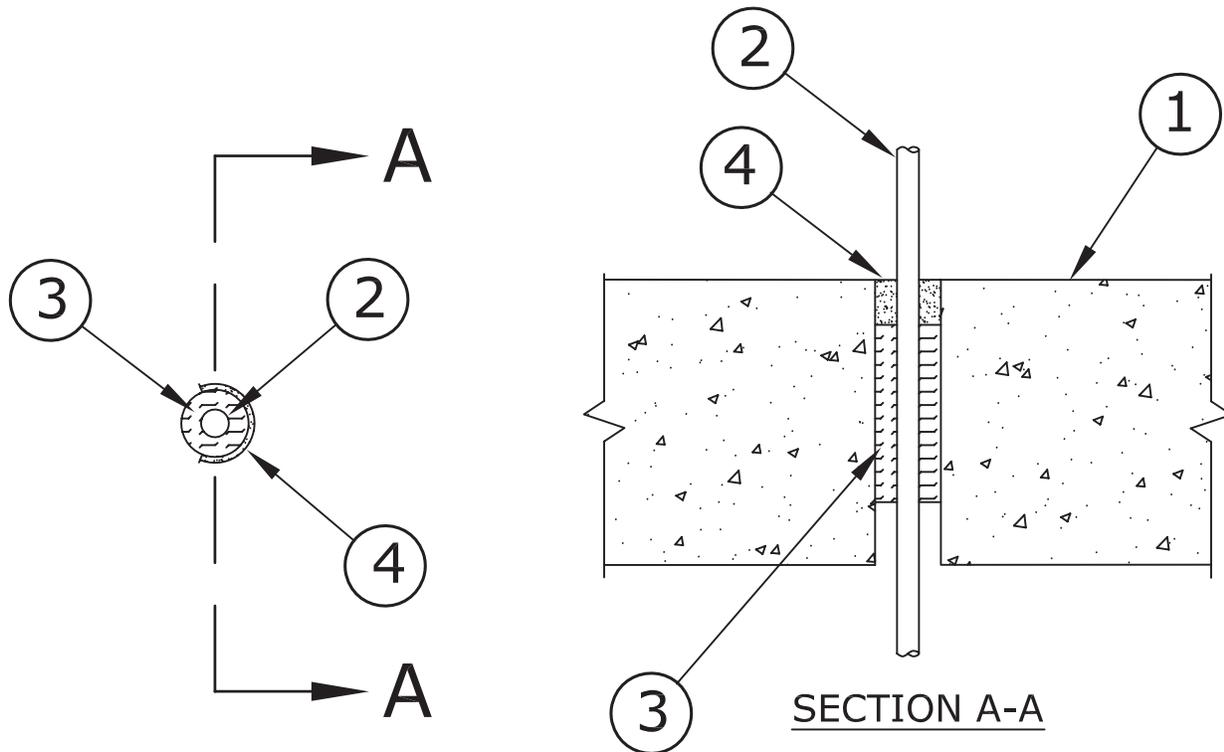

1. **Floor or Wall Assembly** – Min 4-1/2 in. (114 mm) thick reinforced lightweight or normal weight (100-150 pcf or 1600-2400 kg/m³) concrete. Wall may also be constructed of any UL Classified **Concrete Blocks***. Max diam of opening is 1 in. (25 mm).
See **Concrete Block** (CAZT) category in the Fire Resistance Directory for names of manufacturers.

2. **Cable** – One max 25 pair No. 24 AWG telephone cable with polyvinyl chloride (PVC) insulation and jacket.
3. **Packing Material** – Min 3 in. (76 mm) thickness of min 4.0 pcf (64 kg/m³) mineral wool batt insulation firmly packed into opening as a permanent form. Packing material to be recessed from top surface of floor or from both surfaces of wall as required to accommodate the required thickness of fill material.
4. **Fill, Void or Cavity Material* – Sealant** – Min 1/2 in. (13 mm) thickness of fill material to be applied within the annulus, flush with the top surface of floor or with both surfaces of wall.

3M COMPANY – Type FB-1000 NS, FB-1003SL (floors only), FB-2000 or FB-2000+.

*Bearing the UL Classification Mark

Reprinted from the Online Certifications Directory with permission from UL

© 2013 UL LLC



System No. C-AJ-3030

March 05, 2007

F Ratings – 1-1/2, 2 and 3 Hr (See Item 5)

T Rating – 0 Hr

L Rating At Ambient – 129 CFM/sq ft

L Rating At 400 F – 92 CFM/sq ft

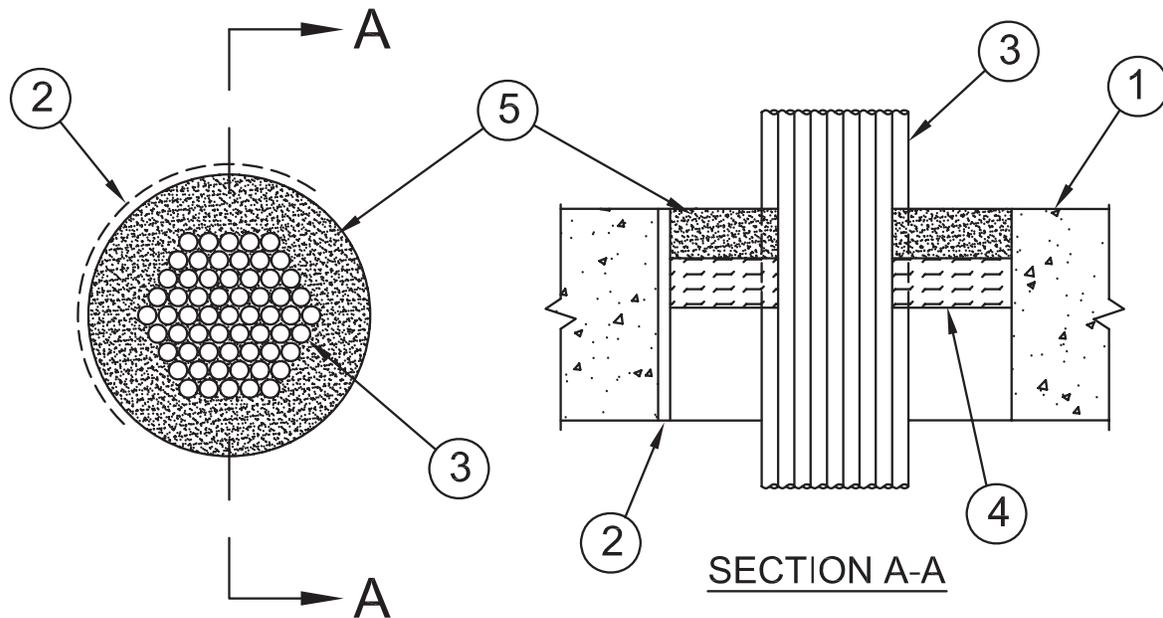

1. **Floor or Wall Assembly** – Min 2-1/2 in. (64 mm) thick lightweight or normal weight (100-150 pcf or 1600-2400 kg/m³) concrete. Wall may also be constructed of any UL Classified **Concrete Blocks***. Max diam of opening is 8 in. (203 mm).
See **Concrete Block (CAZT)** category in the Fire Resistance Directory for names of manufacturers.
2. **Sleeve** – (Optional) – Nom 8 in. (203 mm) diam (or smaller) Schedule 40 (or heavier) steel pipe or nom 6 in. (152 mm) diam (or smaller) Schedule 40 polyvinyl chloride (PVC) pipe cast into floor or wall assembly. Sleeve to be flush with or project max 2 in. (51 mm) from top surface of floor or both surfaces of wall. When PVC sleeve is used, max cable conductor size is No. 12 AWG. As an alternate, nom 8 in. (203 mm) diam (or smaller) sleeve fabricated from nom 0.019 in. (0.48 mm) thick galv steel cast or grouted into floor or wall assembly flush with floor or wall surfaces.
3. **Cables** – Aggregate cross-sectional area of cables to be min 10 percent to max 40 percent of the cross-sectional area of the opening. Cables to be rigidly supported on both sides of the floor or wall assembly. Any combination of the following types and sizes of cables may be used:
 - A. Max 1000 kcmil single-conductor copper or aluminum power cable; cross-linked polyethylene insulation.
 - B. Max No. 2/0 AWG multiconductor copper or aluminum power cables; cross-linked polyethylene, polyvinyl chloride, neoprene rubber, hypalon or silicone rubber insulation and jacket materials.
 - C. Max No. 12 AWG multiconductor copper control cables; cross-linked polyethylene, polyvinyl chloride, neoprene rubber, hypalon or silicone rubber insulation and jacket materials.
 - D. Max 400 pair No. 24 AWG copper telephone cables; polyvinyl chloride insulation and jacket materials.
 - E. Multiple fiber optical communication cable jacketed with PVC and having a max outside diam of 5/8 in.
 - F. Max 200 pair No. 22 AWG (or smaller) copper conductor with polyvinyl chloride (PVC) insulation and jacketing material.
 - G. Max 3/C No. 3/0 AWG (or smaller) copper or aluminum conductor SER cables with PVC insulation and jacket.
 - H. Max 3/C No. 2/0 AWG (or smaller) copper conductor PVC jacketed aluminum clad or steel clad TECK 90 cable.
 - I. Max 3/C with ground No. 8 AWG (or smaller) copper conductor NM cable with PVC insulation and jacket.
 - J. RG/U coaxial cable with fluorinated ethylene (FE) or PVC insulation and jacket.
 - K. Max 4 pair No. 24 AWG (or smaller) copper conductor data cable with Hylar jacket and insulation.
 - L. Max 3/C No. 12 AWG (or smaller) MC (BX) copper cable with polyvinyl chloride insulation and jacket materials.
 - M. **Through Penetrating Product*** – Any cables, **Armored Cable+** or **Metal Clad Cable+** currently Classified under the Through Penetrating Product category. See **Through Penetrating Product (XHLY)** category in the Fire Resistance Directory for names of manufacturers
4. **Packing Material** – Min 1 in. (25 mm) thickness of 4 pcf (64 kg/m³) mineral wool batt insulation firmly packed into opening as a permanent form. Packing material to be recessed from top surface of floor or sleeve or from both surfaces of wall or ends of sleeve as required to accommodate the required thickness of fill material (Item 5).

System No. C-AJ-3030 *continued*

5. **Fill, Void or Cavity Material* – Caulk or Sealant** – Applied to fill the through opening to a min thickness of 1 in. (25 mm) flush with the top surface of the floor or sleeve or both surfaces of wall or ends of sleeve. Caulk to be forced into interstices of cable group to max extent possible. F Rating of firestop systems is dependent upon the through opening size, the thickness of the concrete, the sleeve type and percent cable fill, as tabulated below:

| Max Through Opening Diam In. (mm) | Min Concrete Thkns In. (mm) | Sleeve Type | % Cable Fill | F Rating Hr |
|-----------------------------------|-----------------------------|-------------|--------------|-------------|
| 6 (152) | 2-1/2 (64) | PVC | 15-40 | 2 |
| 6 (152) | 2-1/2 (64) | PVC | 10-15 | 3 |
| 6 (152) | 4-1/2 (114) | PVC | 10-40 | 3 |
| 6 (152) | 4-1/2 (114) | None | 10-40 | 3 |
| 6 (152) | 4-1/2 (114) | Steel | 10-40 | 3 |
| 8 (203) | 2-1/2 (64) | None | 15-40 | 1-1/2 |
| 8 (203) | 4-1/2 (114) | None | 15-33 | 2 |
| 8 (203) | 2-1/2 (64) | None | 10-15 | 3 |
| 8 (203) | 2-1/2 (64) | Steel | 15-40 | 1-1/2 |
| 8 (203) | 2-1/2 (64) | Steel | 10-15 | 3 |
| 8 (203) | 4-1/2 (114) | Steel | 10-22 | 3 |

3M COMPANY – CP 25WB+ caulk or FB-3000 WT sealant.

*Bearing the UL Classification Marking

Reprinted from the Online Certifications Directory with permission from Underwriters Laboratories Inc.
Copyright © 2010 Underwriters Laboratories Inc.®



Through Penetrations

Cables

3000 Series

Concrete

CAJ

System No. C-AJ-3031

January 9, 1996

(Formerly System No. 337)

F Rating – 2 Hr

T Ratings – 0, 3/4 and 2 Hr (See Item 2)

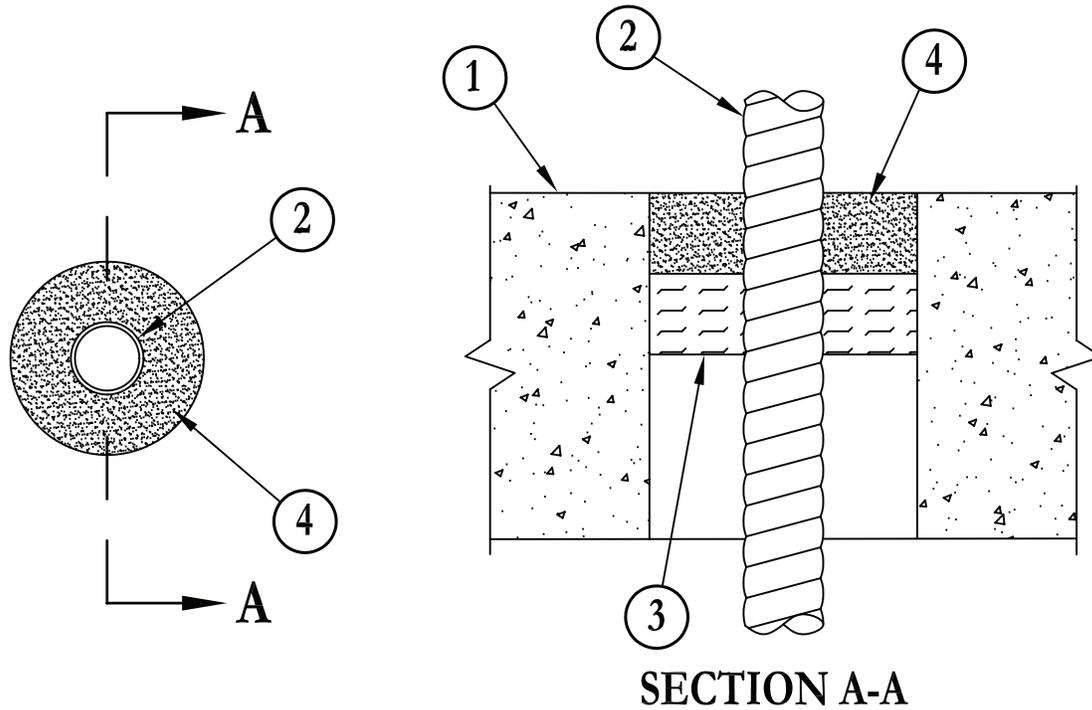
**SECTION A-A**

- Floor or Wall Assembly** – Min 4-1/2 in. thick lightweight or normal weight (100-150 pcf) concrete. Wall may also be constructed of any UL Classified **Concrete Blocks***. Diam of circular through opening in floor or wall assembly to be 3/4 in. to 1-1/2 in. larger than diam of through penetrating product (Item 2) installed in through opening. Max diam of opening is 3 in.
See **Concrete Blocks (CAZT)** category in the Fire Resistance Directory for names of manufacturers.
- Through Penetrating Product*** – Max four copper conductor No. 2 AWG (or smaller) aluminum or steel **Armored Cable+** or **Metal – Clad Cable+**. Max one armored cable or metal clad cable installed near center of circular through opening in floor or wall assembly. Through penetrating product to be rigidly supported on both sides of floor or wall assembly. **When max No. 2 AWG armored cable or metal clad cable is used in floor assembly, T Rating is 0 hr. When max No. 2 AWG armored cable or metal clad cable is used in wall assembly less than 6 in. thick, T Rating is 0 hr. When max No. 2 AWG armored cable or metal clad cable is used in min 6 in. thick wall assembly, T Rating is 3/4 hr. When max No. 12 AWG armored cable or metal clad cable is used in min 6 in. thick wall assembly, T Rating is 2 hr.**

AFC CABLE SYSTEMS INC

- Packing Material** – Nom 1 in. thickness of ceramic (alumina silica) fiber blanket or mineral wool batt insulation firmly packed into opening as a permanent form. Packing material to be recessed min 1 in. from top surface of floor or from both surfaces of wall.
- Fill, Void or Cavity Material* – Caulk** – Applied to fill the annular space around the through penetrating product. In floors, a min 1 in. depth of fill material to be installed flush with top surface of floor. In walls, a min 1 in. depth of fill material to be installed flush with wall surface on both sides of wall assembly.

3M COMPANY – CP 25WB+

*Bearing the UL Classification Marking

+Bearing the UL Listing Mark

Reprinted from the Online Certifications Directory with permission from Underwriters Laboratories Inc.
Copyright © 2010 Underwriters Laboratories Inc.®



System No. C-AJ-3041

May 09, 2013

ANSI/UL2079

F Rating – 3 Hr

T Rating – 0 and 1/2 Hr (See Item 2)

CAN/ULC S115

F Rating – 3 Hr

FT Rating – 0 and 1/2 Hr (See Item 2)

FH Rating – 3 Hr

FTH Rating – 0 and 1/2 Hr (See Item 2)

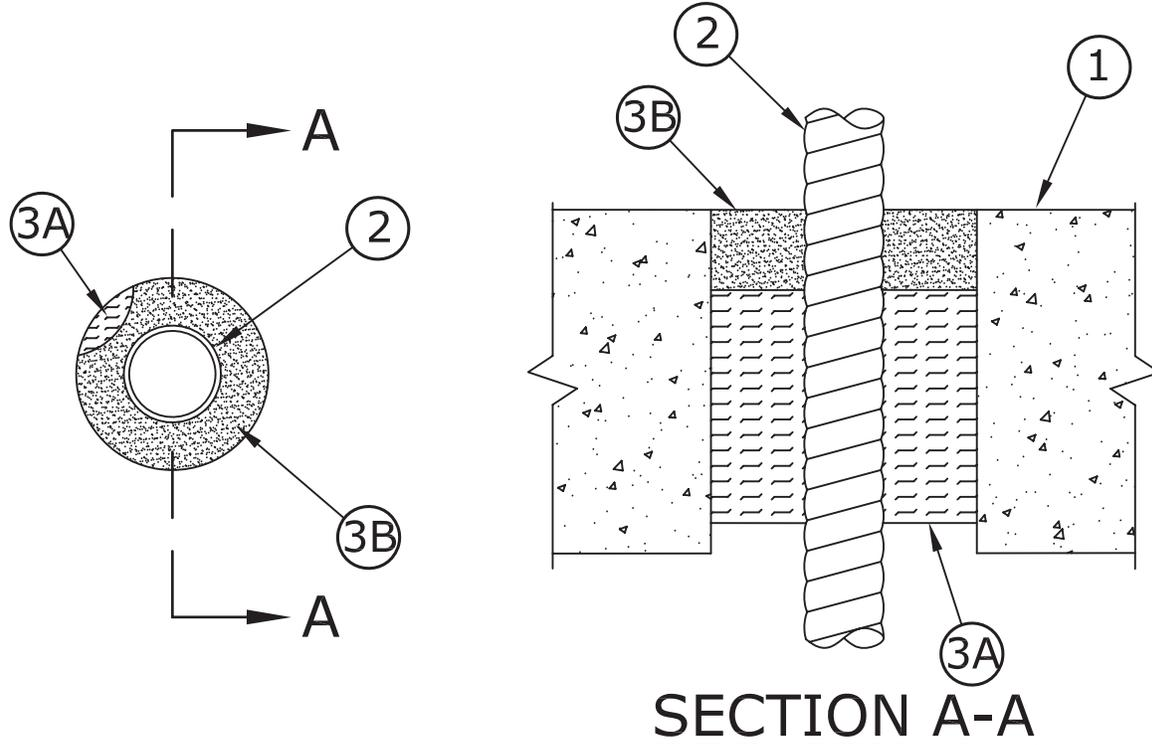

1. **Floor or Wall Assembly** – Min 4-1/2 in. (114 mm) thick reinforced lightweight or normal weight (100-150 pcf or 1600-2400 kg/m³) concrete. Wall may also be constructed of any UL Classified **Concrete Blocks***. Max diam of opening is 5 in. (127 mm). See **Concrete Block (CAZT)** category in the Fire Resistance Directory for names of manufacturers.
2. **Through Penetrating Products*** – Max four aluminum conductor 1000 kcmil (or smaller) **Metal Clad Cable** (jacketed or unjacketed). Max one metal clad cable to be installed near center of circular opening in floor or wall assembly. The annular space between the cable and periphery of the opening shall be min 3/4 to max 1-1/4 in. (19 to 32 mm). Through penetrating product to be rigidly supported on both surfaces of floor or wall assembly.

GENERAL CABLE INDUSTRIES INC – Stabiloy MC Cable

The T, FT and FTH Rating for the firestop system is 1/2 hr except that for cable sizes greater than 750 kcmil, the T, FT and FTH Rating is 0 hr.

3. **Firestop System** – The firestop system shall consist of the following:
 - A. **Packing Material** – Min 3 in. (76 mm) thickness of min 4.0 pcf (64 kg/m³) mineral wool batt insulation firmly packed into opening as a permanent form. In floors, forming material is recessed min 1/2 in. (13 mm) below top surface of floor. In walls, forming material is centered in the wall's mid-depth and recessed a min of 1/2 in. (13 mm) from both surfaces of the wall.
 - B. **Fill, Void or Cavity Material* – Sealant** – Min 1/2 in. (13 mm) thick layer of fill material applied within the annulus, flush with top surface of floor and with both surfaces of wall.

3M COMPANY – Type FB-1000 NS, FB-1003SL (floors only), FB-2000 or FB-2000+.

*Bearing the UL Classification Mark

Reprinted from the Online Certifications Directory with permission from UL
© 2013 UL LLC



System No. C-AJ-3044

May 19, 2005

F Rating – 2 Hr

T Ratings – 0 and 1/2 Hr (See Item 2)

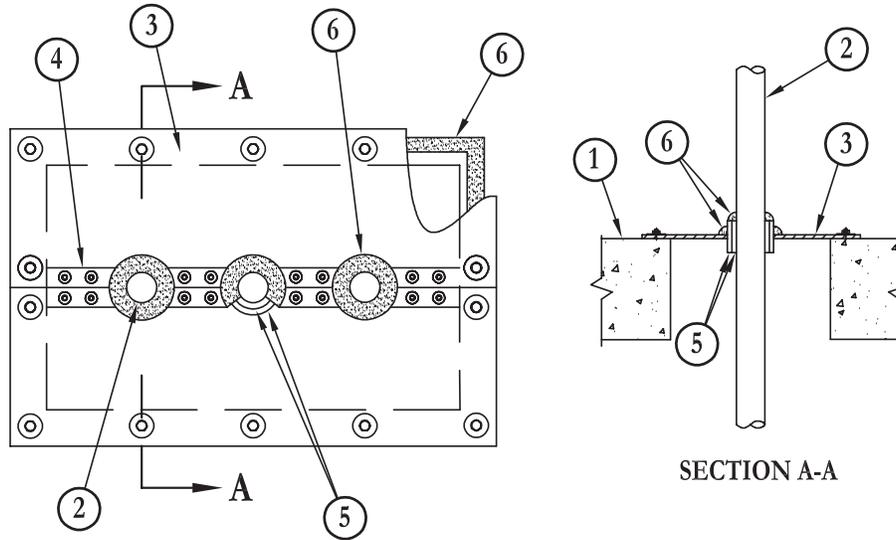

- 1. Floor or Wall Assembly** – Min 4-1/2 in. (114) thick lightweight or normal weight (100-150 pcf or 1600-2400 kg/m³) concrete. Wall may also be constructed of any UL Classified **Concrete Blocks***. Max area of opening not to exceed 240 sq in. (1548 cm²) with max dimension of 30 in. (762 mm).
See **Concrete Blocks (CAZT)** category in Fire Resistance Directory for names of manufacturers.

- 2. Telephone Riser Cable** – Multi conductor telephone riser cable with max No. 22 AWG copper conductors insulated with PVC skinned expanded polyethylene. Conductors encased in an overlapped corrugated aluminum shield with a PVC jacket. Outside diam of riser cable not to exceed 3.25 in. (82.6). Aggregate cross-sectional area of copper conductors within riser cable not to exceed 1.14 sq in. (735 mm²). **When aggregate cross-sectional area of copper conductors within riser cable is equal to or less than 0.905 sq in. (23 mm), T Rating is 1/2 hr. When aggregate cross-sectional area of copper conductors within riser cable is greater than 0.905 sq in. (23 mm), T Rating is 0 hr.** When more than one riser cable is installed in through opening, the min separation between cables is 2 in. (51 mm). Cables to be rigidly supported on both sides of floor or wall assembly.
- 3. Fill, Void or Cavity Materials* – Intumescent Sheet** – Rigid aluminum foil-faced sheet with a galv steel sheet backer. Diam of circular cutout in sheet to accommodate each riser cable to be 1 in. (25 mm) larger than diam of cable such that the cutout closely follows the contours of the wrap strip layers (Items 5) on the cable. Sheet cut to lap a min of 2 in. (51 mm) on the concrete on all sides of the through opening. Sheet to be installed with the galv steel sheet backer exposed (aluminum foil facing against floor or wall surface). Sheet secured to top surface of floor (or both surfaces of wall) using min 3/16 in. (5 mm) diam by 1-1/2 in. (38 mm) long steel expansion bolts, or equivalent, in conjunction with min 1-1/4 in. (32 mm) diam steel fender washers. Max spacing of fasteners not to exceed 6 in. (152 mm) OC with additional fasteners located on each side of butted seam or slit made to permit installation of the sheet around individual riser cables. When a single riser cable is installed in a circular through opening with a diam 1 to 1-1/2 in. (25 mm to 38 mm) larger than the diam of the riser cable, the intumescent sheet is not required.

3M COMPANY – CS-195+

- 4. Steel Cover Strip** – Min 2 in. (51 mm) wide strip of min 0.020 in. (0.51 mm) thick (No. 26 gauge) galv steel centered over entire length of seam or slit made in intumescent sheet (Item 3) to permit installation about the riser cable(s). Steel cover strip secured to galv steel sheet backer of intumescent sheet with steel sheet metal screws spaced max 2 in. (51 mm) OC on each side of seam or slit.
- 5. Fill, Void or Cavity Materials* – Wrap Strip** – Nom 1/4 in. (6 mm) thick intumescent elastomeric material faced on one side with aluminum foil, supplied in nom 2 in. (51 mm) wide by 24 in. (610 mm) long strips. Two layers of nom 2 in. (51 mm) wide strips tightly wrapped around individual riser cables with the foil face exposed. Each layer of wrap strip to be installed with butted seams in layers staggered. Wrap strip layers to be secured in place with two steel wire ties. When intumescent sheet (Item 3) is used, the wrap strip layers are to extend approx 7/8 in. (22 mm) beyond each face of the intumescent sheet(s). When no intumescent sheet is used (see conditions under Item 3), the wrap strip layers shall be slid into annular space such that the top edges are recessed min 1/4 in. (6 mm) from the top surface of floor. In wall assemblies, the wrap strip layers shall be installed in the same manner used for floor assemblies but shall be installed symmetrically on both sides of the wall.

3M COMPANY – FS-195+

- 6. Fill, Void or Cavity Materials* – Graphite Seal, Caulk, Sealant or Putty** – One layer of 1/2 in. x 1/16 in. (13 mm by 1.6 mm) adhesive backed graphite intumescent seal positioned under intumescent sheet around entire perimeter of through opening or min 1/4 in. (6 mm) diam continuous bead of caulk or putty applied to edge of intumescent sheet at its interface with surface of floor or wall around entire perimeter of through opening. Nom 1/4 diam (6 mm) bead of caulk or putty applied to perimeter of wrap strip around riser cable at interface with intumescent sheet. Additional caulk or putty applied to cover exposed edges of wrap strip around perimeter of riser cable. When riser cable is centered in circular through opening and no intumescent sheet is used, a min 2 in. (51 mm) depth of caulk or putty is required in annular space between wrap strip layers and concrete and a min 1/4 in. (6 mm) depth of caulk or putty is required over edges of wrap strip layers flush with surface of floor or wall.

3M COMPANY – E-FIS or Ultra GS seals, CP 25WB+, IC 15WB+ caulk, FB-3000 WT sealant or MP+ Stix putty.

*Bearing the UL Classification Marking

Reprinted from the Online Certifications Directory with permission from Underwriters Laboratories Inc.
Copyright © 2010 Underwriters Laboratories Inc.®



System No. C-AJ-3058

December 05, 2000
(Formerly System No. 591)
F Rating – 2 Hr
T Rating – 2 Hr

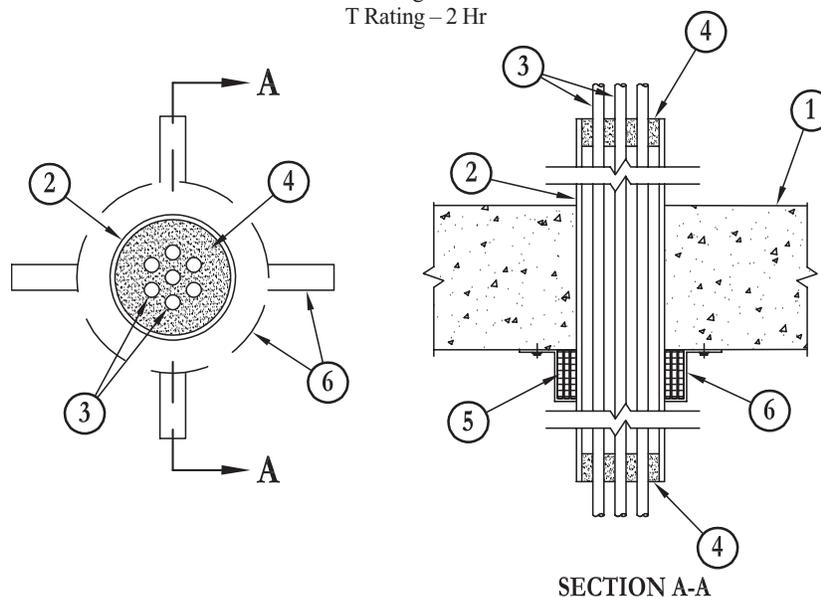

- Floor or Wall Assembly** – Min 4-1/2 in. thick reinforced lightweight or normal weight (100-150 pcf) concrete. Floor may also be constructed of any min 6 in. thick UL Classified hollow core **Precast Concrete Units***. Wall may also be constructed of any UL Classified **Concrete Block***.
See **Concrete Blocks (CAZT)** and **Precast Concrete Units (CFTV)** categories in the Fire Resistance Directory for names of manufacturers.
- Nonmetallic Sleeve** – Nom 4 in. diam (or smaller) Schedule 40 polyvinyl chloride (PVC) pipe or **Rigid Nonmetallic Conduit+** formed of PVC. Length of sleeve to be equal to thickness of floor or wall plus 12 in. such that, when installed, the ends of the sleeve will project min 6 in. beyond each surface of the floor or wall assembly. Sleeve to be cast in place during concrete placement or grouted into oversized through opening using hydraulic cement or sand-cement grout throughout the thickness of the floor or wall assembly. Diam of oversized through opening to be 1/2 in. to 1-1/2 in. larger than outside diam of sleeve. Breached cores in precast concrete units and concrete blocks shall be plugged with pieces of mineral wool batt insulation prior to installation of the sleeve and grout to ensure that the grout completely fills the annular space around the sleeve throughout the thickness of the floor or wall.
- Cables** – Aggregate cross-sectional area of cables in opening to be min 0 percent to max 33 percent of the cross-sectional area of the sleeve. Cables to be rigidly supported on both sides of floor or wall assembly. Any combination of the following types and sizes of cable may be used:
 - Max 150 pair No. 24 AWG copper conductor telephone cables with PVC insulation and jacket materials.
 - Multiple fiber optical communication cables jacketed with PVC or PE and having a max outside diam of 3/4 in.
- Fill, Void or Cavity Materials* – Putty** – Moldable putty material kneaded by hand and packed tightly into end of sleeve (and interstices between cables to max extent possible) on each side of floor or wall assembly. Min putty depth at each end of sleeve is 1 in.
3M COMPANY – MP+ Stix, Cable Wrap putty
- Fill, Void or Cavity Materials* – Wrap Strip** – Nom 1/4 in. thick intumescent elastomeric material faced on one side with aluminum foil, supplied in 2 in. wide strips. Nom 2 in. wide strips tightly-wrapped around nonmetallic sleeve (foil side exposed) with the top edges butted against the underside of the concrete floor. For nom 2 in. diam (or smaller) sleeves, a min of one layer of wrap strip is required. For nom 2-1/2 and 3 in. diam sleeves, a min of two layers of wrap strip is required. For nom 3-1/2 and 4 in. diam sleeves, a min of three layers of wrap strip is required. Each layer of wrap strip to be installed with butted seam. Butted seams in successive layers staggered. Wrap strip layers temporarily held in position using aluminum foil tape, steel wire tie, or equivalent. In wall assemblies, the wrap strip is to be installed in the same manner used for floor assemblies, but it shall be installed symmetrically on both sides of the wall assembly.
3M COMPANY – FS-195, FS-195+
- Steel Collar** – Nom 2 in. deep collar with 1-1/4 in. wide by 2 in. long anchor tabs and min 1/2 in. long tabs to retain wrap strip layers. Coils of precut 0.016 in. thick (30 gauge) galv sheet steel available from wrap strip manufacturer. As an alternate, collar may be field-fabricated from min 0.016 in. thick (30 gauge) galv sheet steel in accordance with instruction sheet supplied by wrap strip manufacturer. Steel collar, with anchor tabs bent outward 90 deg, wrapped tightly around wrap strip layers with min 1 in. overlap at seam. With steel collar anchor tabs pressed tightly against floor or wall surface(s), compress collar around wrap strip layers using a min 1/2 in. wide by 0.028 in. thick stainless steel band clamp with worm drive tightening mechanism at the collar midheight. Secure collar to floor or wall surface(s) with 1/4 in. diam by min 1-1/2 in. long steel expansion bolts, or equivalent, in conjunction with steel nuts and min 1-1/4 in. diam steel fender washers. Three anchor bolts, symmetrically located, required for nom 1/2 in. to nom 3 in. diam pipes. Four anchor bolts, symmetrically located, required for nom 3-1/2 and 4 in. diam pipes. As a final step, bend retainer tabs 90 deg toward pipe to lock wrap strip layers in position.
- Firestop Device*** (Not Shown) – An alternate to Item 5 and 6 for nom 1-1/2, 2, 3 or 4 in. diam nonmetallic sleeves, a firestop device consisting of a sheet-steel split collar lines with intumescent material and provided with steel clips for attachment may be used. Firestop device to be installed on underside of floor or on both sides of wall in accordance with the accompanying installation instructions.
3M COMPANY – PPD 150, PPD 200, PPD 300, PPD 400

*Bearing the UL Classification Mark

Reprinted from the Online Certifications Directory with permission from Underwriters Laboratories Inc.
Copyright © 2010 Underwriters Laboratories Inc.®



System No. C-AJ-3080

August 18, 2011

F Rating – 3 Hr

T Rating – 0 Hr

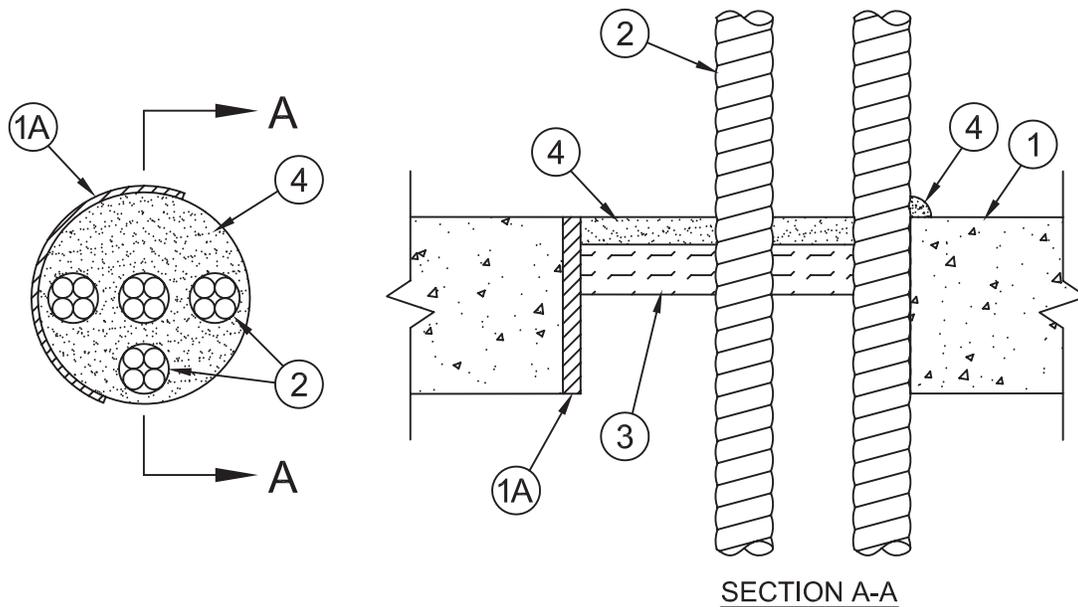

- 1. Floor or Wall Assembly** – Min 4-1/2 in. (114 mm) thick lightweight or normal weight (100-150 pcf or 1600 - 2400 kg/m³) concrete. Wall may also be constructed of any UL Classified **Concrete Blocks***. When individual cable (Item 2) is installed in through opening, diam of opening to be 3/4 in. to 1-1/2 in. (19 mm to 38 mm) larger than diam of cable. When more than one cable is installed in opening, diam of opening to be sufficient to allow separation between cables for installation of caulk fill material (Item 4). Max diam of opening is 6 in. (152 mm).

See **Concrete Block (CAZT)** category in the Fire Resistance Directory for names of manufacturers.

- 1A. Sleeve** – (Optional) – Nom 6 in. (152 mm) diam (or smaller) Schedule 40 PVC pipe or Schedule 10 (or heavier) steel pipe cast into concrete floor or wall. Sleeve to be flush with or project max 1-1/2 in. (38 mm) from top surface of floor or both surfaces of wall.
- 2. Through Penetrating Products*** – Aggregate cross-sectional area of cables to be 15 to 30 percent of the cross-sectional area of the opening. Min annular space between cable and edge of through opening is zero in. (point contact). Through penetrating products to be rigidly supported on both sides of floor or wall assembly. The following types of through-penetrating products may be used:
 - Max four copper conductors No. 4/0 AWG (or smaller) aluminum or steel **Armored Cable#** or **Metal-Clad Cable+**.
AFC CABLE SYSTEMS INC
 - Two or more twisted copper conductor No. 6 AWG (or smaller) **Power Limited Circuit Cable+** with or without a jacket under a metal armor.
AFC CABLE SYSTEMS INC
 - Two or more twisted copper conductor No. 10 AWG (or smaller) **Power Limited Fire Alarm Cable+** with or without a jacket under a metal armor.
AFC CABLE SYSTEMS INC
 - Two or more twisted copper conductor No. 12 AWG (or smaller) **Non Power Limited Fire Alarm Cable+** with or without a jacket under a metal armor.
AFC CABLE SYSTEMS INC
- 3. Packing Material** – Polyethylene backer rod or nom 1 in. (25 mm) thickness of mineral wool batt insulation firmly packed into opening as a permanent form. Packing material to be recessed from top surface of floor or from both surfaces of wall as necessary to accommodate the required thickness of caulk fill material (Item 4).
- 4. Fill, Void or Cavity Material* – Caulk** – Applied to fill the annular space around the through penetrating product. When an individual cable is installed in a max 3 in. (76 mm) diam through opening, a min 1/2 in. (13 mm) depth of caulk fill material is required. When more than one cable is installed in through opening or through opening is larger than 3 in. (76 mm) diam, a min 1 in. (25 mm) depth of caulk fill material is required. Caulk fill material to be installed flush with top surface of floor. In walls, caulk fill material to be installed flush with wall surface on both sides of wall assembly.

3M COMPANY – CP 25WB+ or IC 15WB+

*Bearing the UL Classification Marking

#Bearing the UL Listing Mark

Reprinted from the Online Certifications Directory with permission from UL

© 2012 UL LLC



System No. C-AJ-3107

January 11, 1999

F Rating – 2 Hr

T Ratings – 0, 3/4 and 2 Hr (See Item 2)

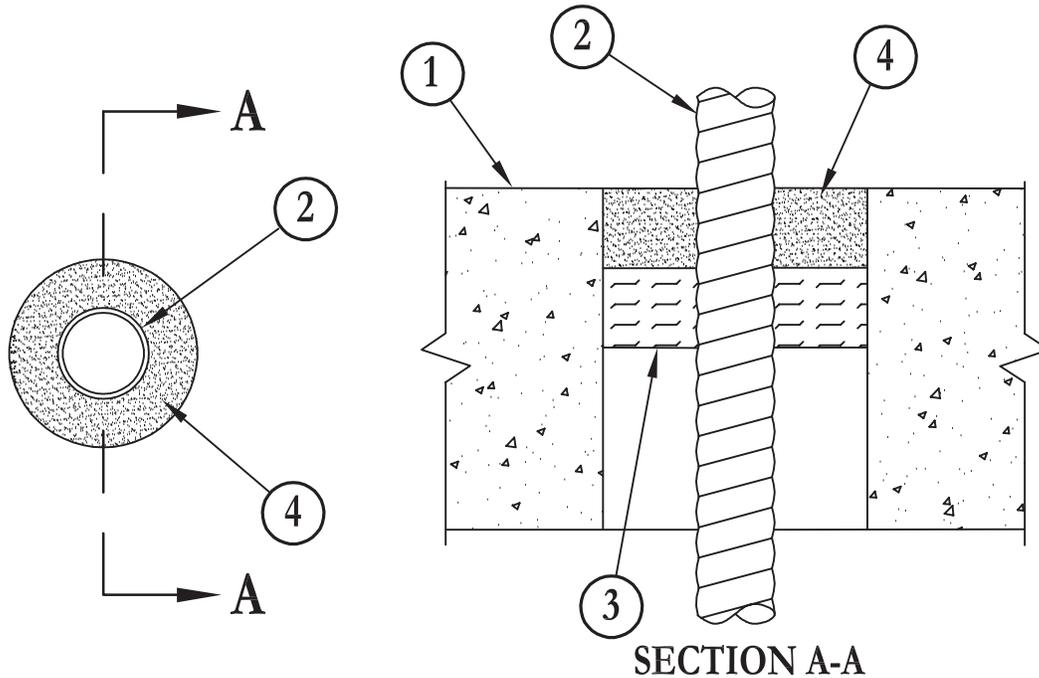

1. **Floor or Wall Assembly** – Min 4-1/2 in. thick lightweight or normal weight (100-150 pcf) concrete. Wall may also be constructed of any UL Classified **Concrete Blocks***. Diam of circular through opening in floor or wall assembly to be 3/4 in. to 1-1/2 in. larger than diam of through penetrating product (Item 2) installed in through opening. Max diam of opening is 3 in.
See **Concrete Blocks (CAZT)** category in the Fire Resistance Directory for names of manufacturers.
2. **Through Penetrating Product*** – Max four copper conductor No. 2 AWG (or smaller) aluminum **Metal – Clad Cable+**. Max one metal clad cable installed near center of circular through opening in floor or wall assembly. Through penetrating product to be rigidly supported on both sides of floor or wall assembly. **When max No. 2 AWG metal clad cable is used in floor assembly, T Rating is 0 hr. When max No. 2 AWG metal clad cable is used in wall assembly less than 6 in. thick, T Rating is 0 hr. When max No. 2 AWG metal clad cable is used in min 6 in. thick wall assembly, T Rating is 3/4 hr. When max No. 12 AWG metal clad cable is used in min 6 in. thick wall assembly, T Rating is 2 hr.**

NEXANS CANADA INC

3. **Packing Material** – Nom 1 in. thickness of ceramic (alumina silica) fiber blanket or mineral wool batt insulation firmly packed into opening as a permanent form. Packing material to be recessed min 1 in. from top surface of floor or from both surfaces of wall.
4. **Fill, Void or Cavity Material* – Caulk** – Applied to fill the annular space around the through penetrating product. In floors, a min 1 in. depth of fill material to be installed flush with top surface of floor. In walls, a min 1 in. depth of fill material to be installed flush with wall surface on both sides of wall assembly.

3M COMPANY – CP 25WB+

*Bearing the UL Classification Marking

#Bearing the UL Listing Mark

Reprinted from the Online Certifications Directory with permission from Underwriters Laboratories Inc.

Copyright © 2010 Underwriters Laboratories Inc.®



Through Penetrations

Cables

3000 Series

Concrete

CAJ

System No. C-AJ-3108

January 11, 1999

F Rating – 3 Hr

T Rating – 0 Hr

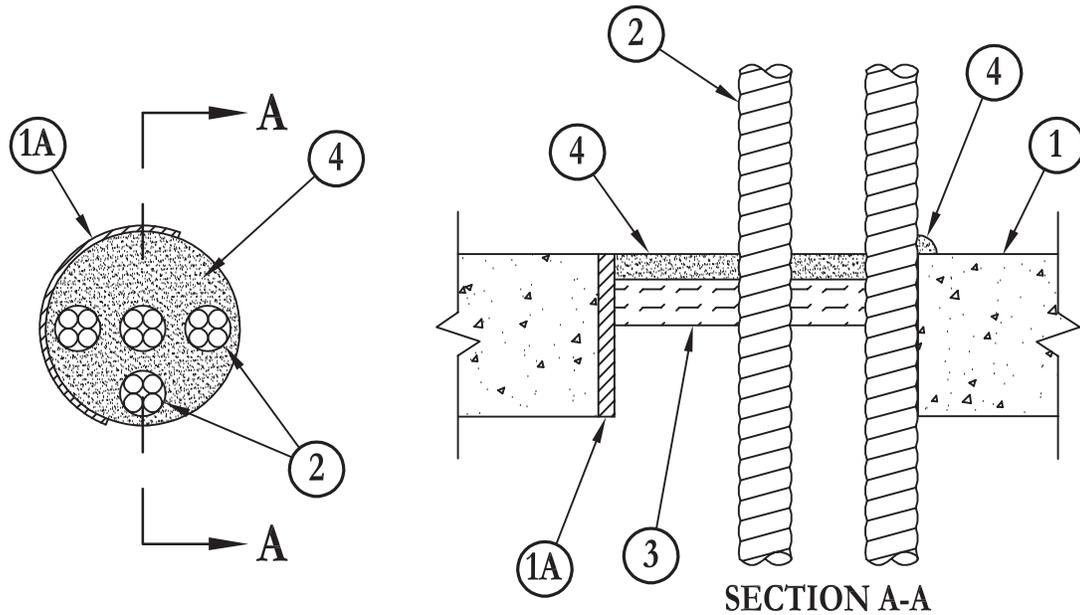

1. **Floor or Wall Assembly** – Min 4-1/2 in. thick lightweight or normal weight (100-150 pcf) concrete. Wall may also be constructed of any UL Classified **Concrete Blocks***. When individual cable (Item 2) is installed in through opening, diam of opening to be 3/4 in. to 1-1/2 in. larger than diam of cable. When more than one cable is installed in opening, diam of opening to be sufficient to allow separation between cables for installation of caulk fill material (Item 4). Max diam of opening is 6 in.

See **Concrete Blocks (CAZT)** category in the Fire Resistance Directory for names of manufacturers.

- 1A. **Sleeve (Optional)** – Nom 6 in. diam (or smaller) Schedule 40 PVC pipe or Schedule 10 (or heavier) steel pipe cast into concrete floor or wall. Sleeve to be flush with or project max 1-1/2 in. from top surface of floor or both surfaces of wall.
2. **Through Penetrating Products*** – Max four copper conductor No. 2/0 AWG (or smaller) aluminum Metal-Clad Cable#. Aggregate cross-sectional area of cables to be 15 to 30 percent of the cross-sectional area of the opening. Min annular space between cable and edge of through opening is zero in. (point contact). Through penetrating products to be rigidly supported on both sides of floor or wall assembly.

NEXANS CANADA INC

3. **Packing Material** – Polyethylene backer rod or nom 1 in. thickness of mineral wool batt insulation firmly packed into opening as a permanent form. Packing material to be recessed from top surface of floor or from both surfaces of wall as necessary to accommodate the required thickness of caulk fill material (Item 4).
4. **Fill, Void or Cavity Material* – Caulk** – Applied to fill the annular space around the through penetrating product. When an individual cable is installed in a max 3 in. diam through opening, a min 1/2 in. depth of caulk fill material is required. When more than one cable is installed in through opening or through opening is larger than 3 in. diam, a min 1 in. depth of caulk fill material is required. Caulk fill material to be installed flush with top surface of floor. In walls, caulk fill material to be installed flush with wall surface on both sides of wall assembly.

3M COMPANY – CP 25WB+

*Bearing the UL Classification Marking

#Bearing the UL Listing Mark

Reprinted from the Online Certifications Directory with permission from Underwriters Laboratories Inc.

Copyright © 2010 Underwriters Laboratories Inc.®



System No. C-AJ-3110

April 10, 1996

F Rating – 2 Hr

T Ratings – 0, 3/4 & 2 Hr (See Item 2)

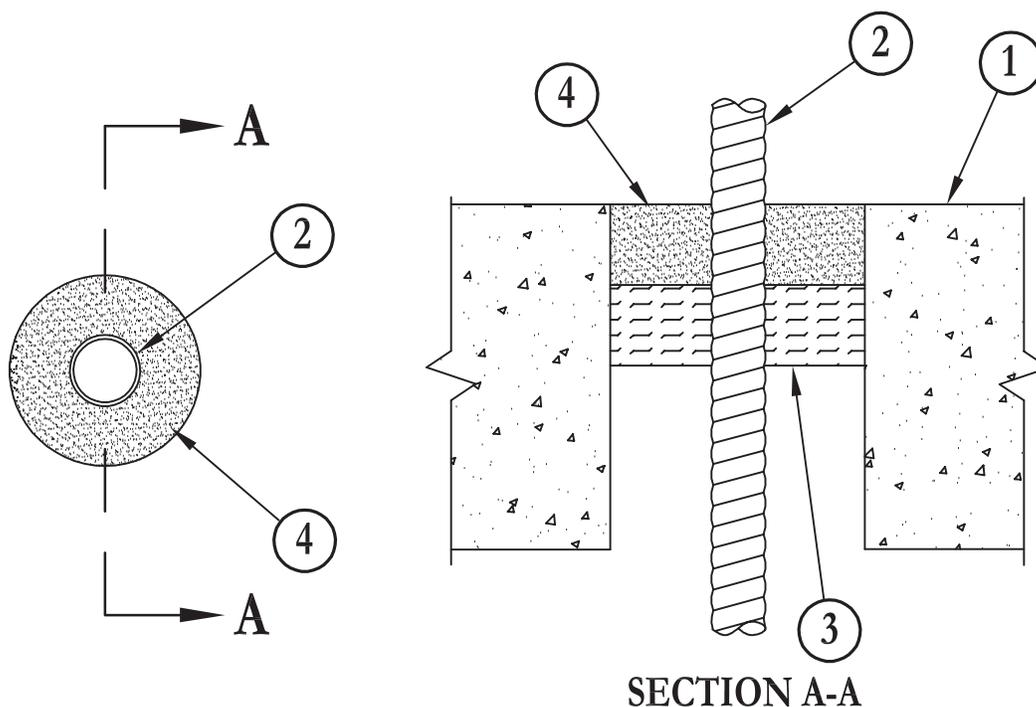

1. **Floor or Wall Assembly** – Min 4-1/2 in. thick lightweight or normal weight (100-150 pcf) concrete. Wall may also be constructed of any UL Classified **Concrete Blocks***. Diam of circular through opening in floor or wall assembly to be 3/4 in. to 1-1/2 in. larger than diam of through penetrating product (Item 2) installed in through opening. Max diam of opening is 3 in.
See **Concrete Blocks (CAZT)** category in the Fire Resistance Directory for names of manufacturers.
2. **Through Penetrating Product*** – Max four copper conductor No. 2 AWG (or smaller) aluminum or steel Armored Cable+ or Metal - Clad Cable+. Max one armored cable or metal clad cable installed near center of circular through opening in floor or wall assembly. Through penetrating product to be rigidly supported on both sides of floor or wall assembly. When max No. 2 AWG armored cable or metal clad cable is used in floor assembly, T Rating is 0 hr. When max No. 2 AWG armored cable or metal clad cable is used in wall assembly less than 6 in. thick, T Rating is 0 hr. When max No. 2 AWG armored cable or metal clad is used in min 6 in. thick wall assembly, T Rating is 3/4 hr. When max No. 12 AWG armored cable or metal clad cable is used in min 6 in. thick wall assembly, T Rating is 2 hr.

CONDUCTORS CM SA DE CV

3. **Packing Material** – Nom 1 in. thickness of ceramic (alumina silica) fiber blanket or mineral wool batt insulation firmly packed into opening as a permanent form. Packing material to be recessed min 1 in. from top surface of floor or from both surfaces of wall.
4. **Fill, Void or Cavity Material* – Caulk** – Applied to fill annular space around the through penetrating product. In floors, a min 1 in. depth of fill material to be installed flush with top surface of floor. In walls, a min 1 in. depth of fill material to be installed flush with wall surface on both sides of wall assembly.

3M COMPANY – CP 25WB+

*Bearing the UL Classification Marking

+Bearing the UL Listing Mark

Reprinted from the Online Certifications Directory with permission from Underwriters Laboratories Inc.
Copyright © 2010 Underwriters Laboratories Inc.®



Through Penetrations

Cables

3000 Series

Concrete

CAJ

System No. C-AJ-3111

April 10, 1996
 F Rating – 3 Hr
 T Rating – 0 Hr

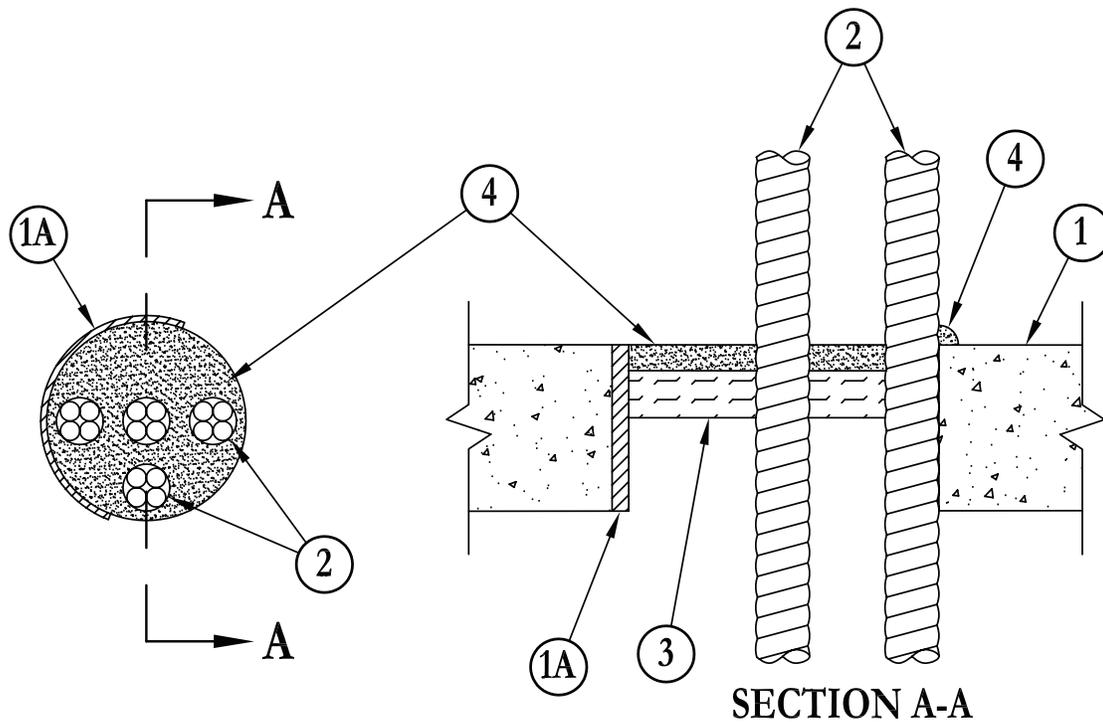

- Floor or Wall Assembly** – Min 4-1/2 in. thick lightweight or normal weight (100-150 pcf) concrete. Wall may also be constructed of any UL Classified **Concrete Blocks***. When individual cable (Item 2) is installed in through opening, diam of opening to be 3/4 in. to 1-1/2 in. larger than diam of cable. When more than one cable is installed in opening, diam of opening to be sufficient to allow separation between cables for installation of caulk fill material (Item 4). Max diam of opening is 6 in.

See **Concrete Blocks (CAZT)** category in the Fire Resistance Directory for names of manufacturers.

- Sleeve (Optional)** – Nom 6 in. diam (or smaller) Schedule 40 PVC pipe or Schedule 10 (or heavier) steel pipe cast into concrete floor or wall. Sleeve to be flush with or project max 1-1/2 in. from top of surface of floor or both surfaces of wall.
- Through Penetrating Products*** – Max four copper conductor No. 2/0 AWG (or smaller) aluminum or steel Armored Cable# or Metal-Clad Cable#. Aggregate cross-sectional area of cables to be 15 to 30 percent of the cross-sectional area of the opening. Min annular space between cable and edge of through opening is zero in. (point contact). Through penetrating products to be rigidly supported on both sides of floor or wall assembly.

CONDUCTORS CM SA DE CV

- Packing Material** – Polyethylene backer rod or nom 1 in. thickness of mineral wool batt insulation firmly packed into opening as a permanent form. Packing material to be recessed from top surface of floor or from both surfaces of wall as necessary to accommodate the required thickness of caulk fill material (Item 4).
- Fill, Void or Cavity Material* – Caulk** – Applied to fill the annular space around the through penetrating product. When an individual cable is installed in a max 3 in. diam through opening, a min 1/2 in. depth of caulk fill material is required. When more than one cable is installed in through opening or through opening is larger than 3 in. diam, a min 1 in. depth of caulk fill material is required. Caulk fill material to be installed flush with top surface of floor. In walls, caulk fill material to be installed flush with wall surface on both sides of wall assembly.

3M COMPANY – CP 25WB+

*Bearing the UL Classification Marking

#Bearing the UL Listing Mark

Reprinted from the Online Certifications Directory with permission from Underwriters Laboratories Inc.
 Copyright © 2010 Underwriters Laboratories Inc.®



System No. C-AJ-3137

September 03, 2004

F Rating – 2 Hr

T Rating – 0 Hr

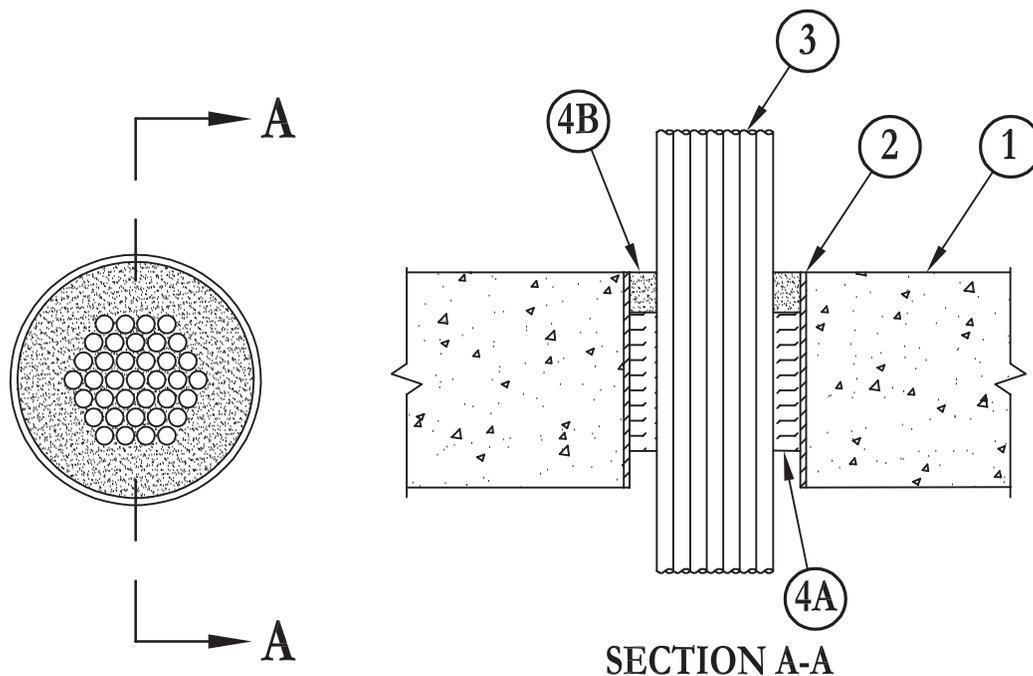

1. **Floor or Wall Assembly** – Min 4-1/2 in. thick reinforced lightweight or normal weight (100-150 pcf) concrete. Floor may also be constructed of any min 6 in. thick UL classified hollow-core **Precast Concrete Units***. Wall may also be constructed of any UL Classified **Concrete Blocks***. Max diam of opening is 4 in.

See **Concrete Blocks (CAZT)** and **Precast Concrete Units (CFTV)** categories in the Fire Resistance Directory for names of manufacturers.

2. **Steel Sleeve (Optional)** – Nom 4 in. diam (or smaller) Schedule 10 (or heavier) steel sleeve cast or grouted into floor or wall assembly.
3. **Cables** – Aggregate cross-sectional area of cables in sleeve or opening to be min 11 percent to max 60.5 percent of the cross-sectional area inside the sleeve or opening. The annular space between cables and periphery of opening shall be min of 0 in. (point contact) to max 2-3/4 in. Cables to be rigidly supported on both sides of floor or wall assembly. Any combination of the following types and sizes of cable may be used:
 - A. Max 1/C 350 kcmil (or smaller) copper conductor cable with cross-linked polyethylene (XLPE) jacket.
 - B. Max 200 pair No. 24 AWG copper conductor telecommunication cables; polyvinyl chloride (PVC) insulation and jacket.
 - C. Max 7/C No. 12 AWG copper conductor power and control cables; XLPE or PVC insulation with XLPE or PVC jacket.
 - D. Max 3/C No. 2/0 AWG copper or aluminum conductor cables; PVC insulation and jacket.
 - E. Max 3/C No. 2/0 (or smaller) copper conductor PVC jacketed aluminum clad or steel clad TEK cable.
 - F. Max 1-10/125 Fiber Optic (F.O.) cable; PVC insulation and jacket.
 - G. Max 3/C with ground No. 12 AWG (or smaller) copper conductor NM cable with PVC insulation and jacket.

4. **Firestop System** – The details of the firestop system shall be as follows:

- A. **Packing Material** – Min 1 in. thickness of min 4 pcf mineral wool batt insulation firmly packed into opening as a permanent form. Packing material to be recessed from top surface of floor or from both surfaces of wall as required to accommodate the required thickness of fill material. When floor is constructed of hollow-core precast concrete units, packing material to be recessed from both surfaces of floor as required to accommodate the required thickness of fill material.
- B. **Fill, Void or Cavity Materials* – Caulk or Sealant** – Min 1/2 in. thickness of fill material applied within the annulus, flush with top surface of floor or with both surfaces of wall. Min 1/2 in. thickness of fill material applied into interstices of cables on the top surface of floor or both surfaces of wall. When floor is constructed of hollow-core precast concrete units, fill material to be installed symmetrically on both sides of the floor, flush with floor surfaces.

3M COMPANY – CP 25WB+ caulk or FB-3000 WT sealant.

*Bearing the UL Classification Marking

Reprinted from the Online Certifications Directory with permission from Underwriters Laboratories Inc.

Copyright © 2010 Underwriters Laboratories Inc.®



System No. C-AJ-3150

August 23, 2004

F Rating – 3 Hr

T Ratings – 0 and 1 Hr (See Item 3)

W Rating – Class I

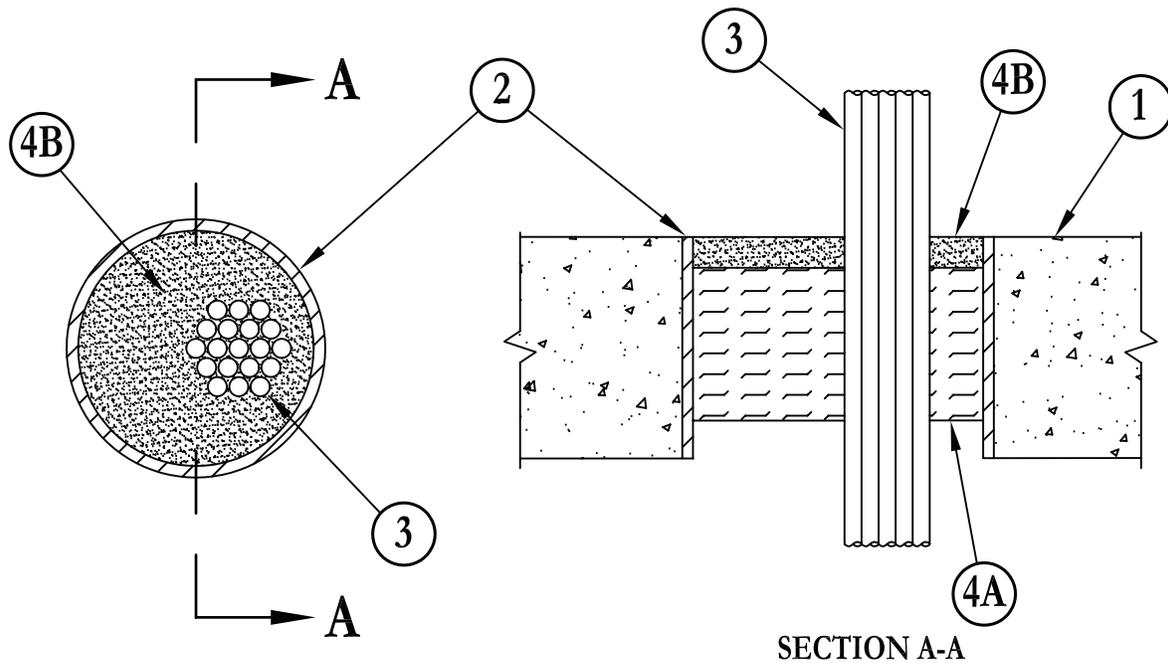

1. **Floor or Wall Assembly** – Min 4-1/2 in. thick reinforced lightweight or normal weight (100-150 pcf) concrete. Wall may also be constructed of any UL Classified **Concrete Blocks***. Max diam of opening is 6 in.
See **Concrete Blocks (CAZT)** category in the Fire Resistance Directory for names of manufacturers.
2. **Sleeve (Optional)** The following sleeves may be used:
 - A. **Metallic Sleeve** – Nom 6 in. diam (or smaller) steel Schedule 40 (or heavier) pipe cast or grouted into floor or wall assembly, flush with floor or wall surfaces.
 - B. **Nonmetallic Sleeve** – Nom 6 in. diam (or smaller) Schedule 40 polyvinyl chloride (PVC) pipe cast or grouted into floor or wall assembly, flush with floor or wall surfaces.
3. **Cables** – Aggregate cross-sectional area of cables in opening to be max 45 percent of the cross-sectional area of the opening. Min separation between cables and between cables and periphery of opening is 1/8 in. Cables to be rigidly supported on both sides of floor or wall assembly. The following types and sizes of copper conductor cables may be used:
 - A. Max 1/C 500 kcmil cable with cross linked polyethylene (XLPE) jacket.
 - B. Max 8/C No. 12 AWG or max 12/C No. 14 AWG cable with XLPE insulation and jacket.
 - C. Max 100 pair No. 24 AWG cable with PVC insulation and jacket.

T Rating is 1/2 Hr for cables A and B. T Rating is 0 Hr for cable C.
4. **Firestop System** – The firestop system shall consist of the following:
 - A. **Packing Material** – Min 3-3/4 in. thickness of min 4.5 pcf mineral wool batt insulation firmly packed into opening as a permanent form so that the width of the wool is compressed at least 50 percent. Packing material to be recessed from top surface of floor or from both surfaces of wall as required to accommodate the required thickness of fill material.
 - B. **Fill, Void or Cavity Material* – Sealant** – Min 1/4 in. thickness of sealant applied within the annulus, flush with the top surface of floor or with both surfaces of wall. Sealant to be forced into interstices of cable group to max extent possible.
3M COMPANY – FB-1000 NS (floors or walls), FB-1003 SL or FB-3000 WT sealant.

*Bearing the UL Classification Marking

Reprinted from the Online Certifications Directory with permission from Underwriters Laboratories Inc.
Copyright © 2010 Underwriters Laboratories Inc.®



System No. C-AJ-3164

May 22, 2009

F Rating – 2 Hr

T Rating – 0 Hr

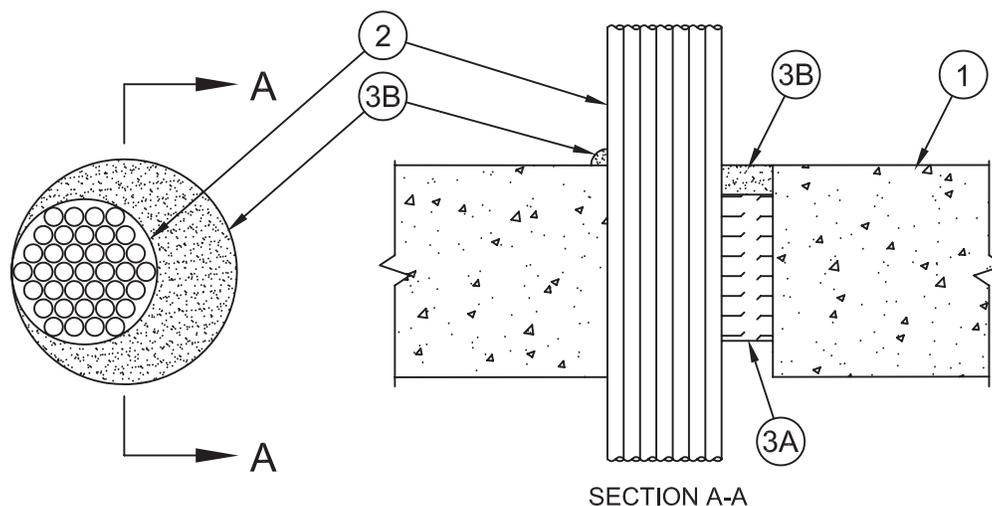

1. **Floor or Wall Assembly** – Min 4-1/2 in. (114 mm) thick reinforced lightweight or normal weight (100-150 pcf or 1600 - 2400 kg/m³) concrete. Wall may also be constructed of any UL Classified **Concrete Blocks***. Max diam of opening is 4 in. (102 mm).

See **Concrete Blocks (CAZT)** category in the Fire Resistance Directory for names of manufacturers.

2. **Cables** – Aggregate cross-sectional area of cables in opening to be min 24 percent to max 60 percent of the cross-sectional area inside the opening. The annular space between cables and periphery of opening shall be min of 0 in. (point contact) to max 2 in. (0 mm to 51 mm). Cables to be rigidly supported on both sides of floor or wall assembly. Any combination of the following types and sizes of cable may be used:

- A. Max 1/C 350 kcmil (or smaller) copper conductor cable with cross-linked polyethylene (XLPE) jacket.
- B. Max 250 pair No. 24 AWG copper conductor telecommunication cables with polyvinyl chloride (PVC) insulation and jacket.
- C. Max 7/C No. 12 AWG copper conductor power and control cables with XLPE or PVC insulation with XLPE or PVC jacket.
- D. Max 3/C No. 2/0 AWG copper or aluminum conductor cables with PVC insulation and jacket.
- E. Max 3/C No. 2/0 (or smaller) copper conductor PVC jacketed aluminum clad or steel clad TEK cable.
- F. Max 1-10/125 Fiber Optic (F.O.) cable with PVC insulation and jacket.
- G. Max 3/C with ground No. 12 AWG (or smaller) copper conductor NM cable with PVC insulation and jacket.
- H. Max 3/C No. 2/0 AWG copper conductor XHHW-2 w/grd aluminum interlocked armor cable with or without PVC jacket.

SERVICE WIRE CO

- I. Max 3/C No. 2/0 AWG copper conductor XHHW-2 w/grd tray cable.

SERVICE WIRE CO

3. **Firestop System** – The details of the firestop system shall be as follows:
 - A. **Packing Material** – Min 3 in. (76 mm) thickness of min 4 pcf (64 kg/m³) mineral wool batt insulation firmly packed into opening as a permanent form. Packing material to be recessed from top surface of floor or from both surfaces of wall as required to accommodate the required thickness of fill material
 - B. **Fill Void or Cavity Materials* – Caulk or Sealant** – Min 1/2 in. (13 mm) thickness of fill material applied within the annulus, flush with top surface of floor or with both surfaces of wall. Min 1/2 (13 mm) in. thickness of fill material applied into interstices of cables on the top surface of floor or both surfaces of wall. Min 1/2 in. (13 mm) diam bead of caulk applied to the cable/concrete interface at the point contact location on the top surface of floor or both surfaces of wall.

3M COMPANY – FD-150+, CP 25WB+, IC 15WB+ caulk or FB-3000 WT sealant

*Bearing the UL Classification Mark

Reprinted from the Online Certifications Directory with permission from Underwriters Laboratories Inc.
Copyright © 2010 Underwriters Laboratories Inc.®



Through Penetrations

Cables

3000 Series

Concrete

CAJ

System No. C-AJ-3200

October 01, 2008

F Rating – 2 Hr

T Rating – 1/4 Hr

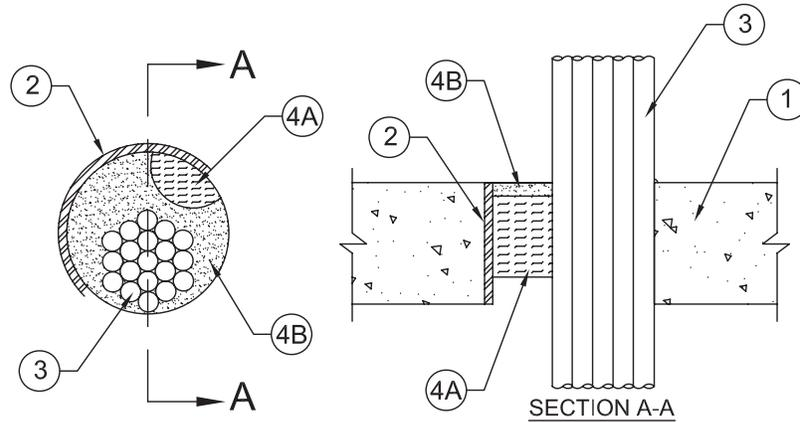

1. **Floor or Wall Assembly** – Min 4-1/2 in. (114 mm) thick reinforced lightweight or normal weight (100-150 pcf or 1600 - 2400 kg/m³) concrete. Floor assembly may also be constructed of any min 6 in. thick UL Classified hollow-core **Precast Concrete Units***. Wall may also be constructed of any UL Classified **Concrete Blocks***. Max diam of opening 6 in. (152 mm).
See **Concrete Blocks (CAZT)** and **Precast Concrete Units (CFTV)** categories in Fire Resistance Directory for names of manufacturers.
2. **Steel Sleeve** – (Optional) - Nom 6 in. (152 mm) diam (or smaller) Schedule 10 (or heavier) steel sleeve cast or grouted into floor or wall assembly. Steel sleeve may be installed flush or may project max 2 in. (51 mm) beyond the floor or wall surfaces. As an alternate, nom 6 in. (152 mm) diam (or smaller) sleeve fabricated from nom 0.019 in. (0.48 mm) thick galv steel cast or grouted into floor or wall assembly flush with floor or wall surfaces.
3. **Cables** – Aggregate cross-sectional area of cables in opening to be max 49 percent of the cross-sectional area inside the sleeve or opening. Annular space between cables and periphery of opening or sleeve shall be min of 0 in. (0 mm) (point contact) to max 2 in. (51 mm). Cables to be rigidly supported on both sides of floor or wall assembly. Any combination of the following types and sizes of cable may be used;

- A. Max 200 pair No. 22 AWG (or smaller) copper conductor with polyvinyl chloride (PVC) insulation and jacketing material.
- B. Max 1/C No. 750 kcmil (or smaller) copper conductor cable with cross-linked polyethylene (XLPE) jacket.
- C. Max 7/C No. 12 AWG (or smaller) copper conductor power and control cables with XLPE or PVC insulation with XLPE or PVC jacket.
- D. Max 3/C No. 4/0 AWG (or smaller) copper or aluminum conductor SER cables with PVC or XLPE insulation and jacket.
- E. Max 3/C No. 2/0 AWG (or smaller) copper conductor PVC jacketed aluminum clad or steel clad TECK 90 cable.
- F. Max 110/125 fiber optic (F.O.) cable with PVC insulation and jacket.
- G. Max 3/C with ground No. 8 AWG (or smaller) copper conductor NM cable with PVC insulation and jacket.
- H. RG/U coaxial cable with fluorinated ethylene (FE) or PVC insulation and jacket.
- I. Max 4 pair No. 24 AWG (or smaller) copper conductor data cable with Hylar jacket and insulation.
- J. Max three conductor No. 12 AWG (or smaller) MC (BX) copper cable with polyvinyl chloride insulation and jacket materials.
- K. **Through Penetrating Product*** - Any cables, **Armored Cable+** or **Metal Clad Cable+** currently Classified under the **Through Penetrating Product** category.

See **Through Penetrating Product (XHLY)** category in the Fire Resistance Directory for names of manufacturers.

4. **Firestop System** – The details of the firestop system shall be as follows:
 - A. **Packing Material** – Min 3 in. (76 mm) thickness of min 4 pcf (64 kg/m³) mineral wool batt insulation firmly packed into opening as a permanent form. Packing material to be recessed from top surface of floor or top edge of sleeve or from both surfaces of wall or both ends of sleeve as required to accommodate the required thickness of fill material. In floors constructed of hollow-core concrete, packing material to be recessed from top and bottom surfaces of floor or sleeve as required to accommodate the required thickness of fill material.
 - A1. **Forming Material*** – As an alternate to the packing material in Item 4A, nom 4 in. (102 mm) wide strips of min 1/2 in (13 mm) thick compressible mat to be stacked to a thickness greater than the width of the annular space and compression-fitted, edge-first, to fill the annular space to a min 4 in. (102 mm) depth. Top of forming material to be recessed from top surface of floor or top edge of sleeve or from both surfaces of wall as necessary to accommodate the required thickness of caulk fill material. In floors constructed of hollow-core concrete, packing material to be recessed from top and bottom surfaces of floor or sleeve as required to accommodate the required thickness of fill material.
 - B. **Fill, Void or Cavity Materials*** – Caulk or Sealant – Min 1/2 in. (13 mm) thickness of caulk applied within the annulus, flush with top surface of floor or top edge of sleeve or with both surfaces of wall or both ends of sleeves. In floors constructed of hollow-core concrete, min 1/2 in. (13 mm) thickness of caulk applied within the annulus, flush with top and bottom surfaces of floor or sleeves. Min 1/4 in. (6 mm) diam bead of caulk applied to the penetrant/concrete or penetrant/sleeve interface at the point contact location on the top surface of floor or both surfaces of wall or hollow-core concrete.

3M COMPANY – IC 15WB+, CP 25WB+ caulk or FB-3000 WT sealant.

*Bearing the UL Classification Mark

+ Bearing the UL Listing Mark

Reprinted from the Online Certifications Directory with permission from Underwriters Laboratories Inc.
Copyright © 2010 Underwriters Laboratories Inc.®



System No. C-AJ-3250

May 23, 2011

F Ratings – 2 and 3 Hr (See Item 1)

T Ratings – 0 and 1 Hr (See Items 2, 3A and 3B)

L Rating At Ambient – 4 to 7 CFM/sq ft (See Item 3B)

L Rating At 400 F – Less Than 1 CFM/sq ft (See Item 3B)

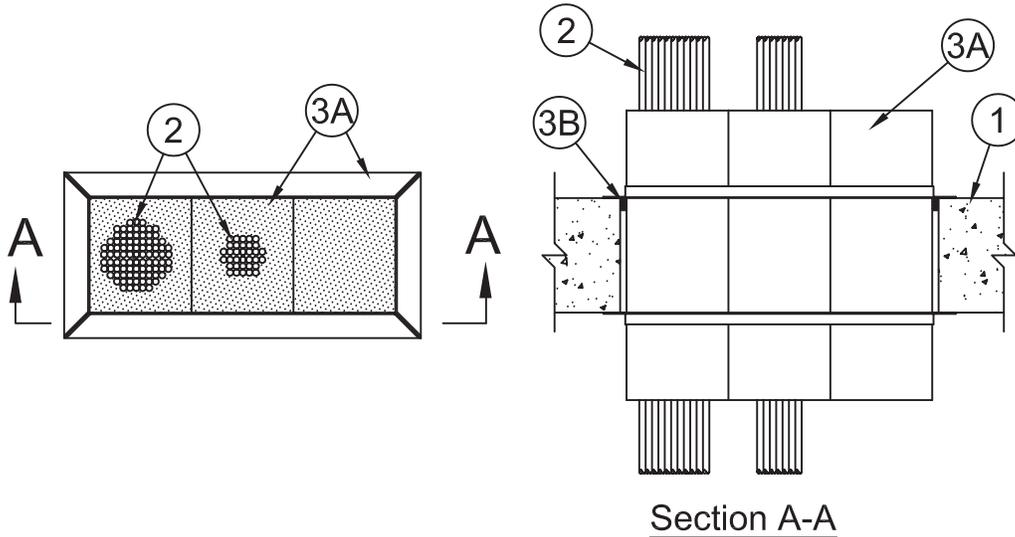

1. **Floor or Wall Assembly** – Min 2-1/2 in. (64 mm) thick reinforced lightweight or normal weight (100-150 pcf or 1600-2400 kg/m³) concrete. Wall may also be constructed of any UL Classified **Concrete Blocks***. Max area of opening is 50 in.² (323 cm²) with a max dimension of 12-1/8 in. (308 mm) for square devices. Max diam of opening is 2-1/2 in. (64 mm) for 2 in. (51 mm) round devices. Max diam of opening is 4-1/2 in. (114 mm) for 4 in. (114 mm) round devices. **When thickness of floor or wall assembly is less than 4-1/2 in. (114 mm), F Rating is 2 hr.**

See **Concrete Blocks** (CAZT) category in Fire Resistance Directory for names of manufacturers.

2. **Cables** – Within the loading area of each firestop device module the cables may represent a 0 to 100 percent visual fill. Cable bundle to be rigidly supported on both sides of floor or wall assembly. Any combination of the following types and sizes of cables may be used:

- A. Max 2/C No. 18 AWG copper conductor thermostat cable with polyvinyl chloride (PVC) insulation and jacket materials.
- B. Max 4 pair No. 24 AWG copper conductor Cat5e or Cat 6 telephone cable with PVC insulation and jacket materials.
- C. Max RG/U (or smaller) coaxial cable with foam high density polyethylene insulation and PVC jacket materials.
- D. Max 3/C (with ground) No. 14 AWG (or smaller) nonmetallic sheathed (Romex) cable with PVC insulation and jacket materials.
- E. Max 1/C No. 8 AWG copper conductor cable with PVC insulation and nylon jacket materials.
- F. Max 12 core No. 26 AWG shielded multi coax cable with foam high density polyethylene insulation and PVC jacket.
- G. Max 48MM62.5 micron fiber optic cables with having a min FT-6 rating.
- H. Max 62.5/125 micron fiber optic cables with having a min Riser rating.
- I. Max 1/C 3/0 AWG copper conductor cable with PVC insulation and jacket materials.
- J. Max three copper conductors (with ground) No. 12 AWG **Metal Clad Cable+**.
- K. Max four copper conductors No. 2 AWG **Metal Clad Cable+**.

AFC CABLE SYSTEMS INC

- L. Max 1/C 2/0 AWG non halogen copper conductor cable.
- M. Max 300 pair No. 24 AWG copper conductor telephone cable with PVC insulation and jacket materials.
- N. Max 30 pair No. 22 copper conductor shielded switchboard cable with PVC insulation and jacket materials.
- O. Max RG/6 (or smaller) coaxial cable with fluorinated ethylene (FE) or PVC insulation and jacket materials.
- P. Max RG/U (or smaller) coaxial cable with fluorinated ethylene (FE) or PVC insulation and jacket materials.
- Q. Max 7/C No. 12 AWG copper conductors with PVC insulation and jacket materials.
- R. Max 4 pair No. 23 AWG copper conductor Cat 6 telephone cable with PVC insulation and jacket materials.
- S. Max three copper conductors (with ground) No. 12 AWG steel **Armored Cable+**.
- T. Max 04-02 2.5M fiber optic cables having a max diameter of 0.450 in. (11.4 mm).
- U. Max 1/C No. 750 kcmil copper conductors with PVC insulation and fabric jacket materials.
- V. Max 3/C with ground No. 4/0 AWG copper or aluminum conductor SER cable with cross linked polyethylene (XLPE) or PVC insulation and jacket.

When min floor or wall thickness is 4-1/2 in. (114 mm) and when cable fill is comprised of Item 2B, T Rating is 1 Hr. Otherwise, T Rating is 0 Hr.

System No. C-AJ-3250 *continued*

Through Penetrations

Cables

3000 Series

Concrete

CAJ

3. **Firestop System** – The firestop system shall consist of the following:

- A. **Firestop Device*** – A max of three square firestop devices may be ganged together. As an alternate, one round device may be centered within a round opening. Each device consists of a nom 4 by 4 by 10 in. (102 by 102 by 254 mm) or 4 in. (102 mm) diam by 10 in. (254 mm) powder coated steel transit incorporating internal intumescent material, foam plugs and mounting flanges. Firestop device to be centered within opening and installed with ends projecting an equal distance beyond each surface of the floor or wall assembly in accordance with the accompanying installation instructions. The annular space between the firestop device(s) and the periphery of the opening shall be nom 1/8 in. (3 mm). Firestop devices secured in place by means of fill material (Item 4B) and steel split mounting flanges sized to accommodate the firestop device. Steel split mounting flanges installed on both sides of floor or wall after installation of fill material and secured to together with supplied steel set screws. Nom 1 in. (25 mm) thick pre-cut foam plugs sized to accommodate the cable bundle and installed flush with each end of device on both sides of floor or wall assembly. When installed in a wall assembly the foam plug in one or both ends of the device is optional except when L Rating is required (See Item 3B). **When foam plugs are omitted in wall assembly, T Rating is 0 hr.**

3M COMPANY – 3M Fire Barrier Pass-Through Device

- B. **Fill, Void or Cavity Materials* – Caulk or Putty** – Min 1 in. (25 mm) thickness of fill material applied within the annulus, flush with top surface of floor or with both surfaces of wall prior to the installation of the mounting flanges. When the annular space is 1/8 in. (3.2 mm) or less, the fill material in the annulus is optional. Also, as an option, the foam plugs may be recessed into device and the recess filled with putty or caulk flush with the ends of the device. When annulus around firestop device module(s) is filled with caulk or putty and when both ends of each firestop device module are filled with a nominal 1/8 in. (3.2 mm) depth of caulk or putty the following L Ratings apply:

| Max Percent Cable Fill In Device | L Rating At Ambient, CFM/sq ft (CFM/Firestop Device Module) | L Rating At 400F, CFM/sq ft (CFM/Firestop Device Module) |
|----------------------------------|---|--|
| 0 | 4 (Less Than 1) | Less Than 1 (Less Than 1) |
| 50 | 7 (1) | Less Than 1 (Less Than 1) |

3M COMPANY – Moldable Putty+, CP 25WB+, IC 15WB+, 3000 WT

*Bearing the UL Classification Mark

+ Bearing the UL Listing Mark

Reprinted from the Online Certifications Directory with permission from Underwriters Laboratories Inc.
Copyright © 2011 Underwriters Laboratories Inc.®



System No. C-AJ-3263

June 12, 2006
F Rating – 3 Hr
T Rating – 1/4 Hr

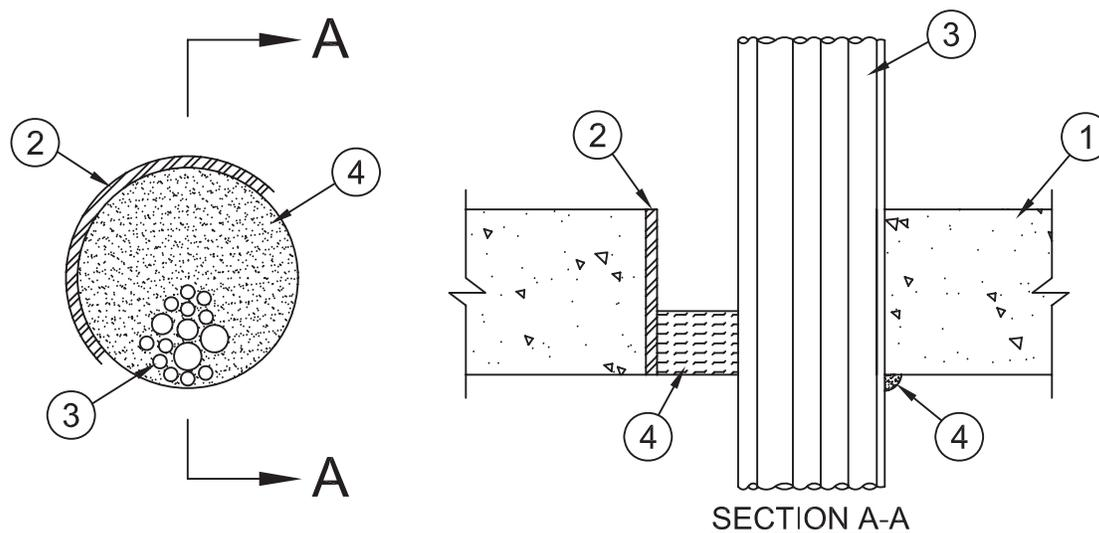

- Floor or Wall Assembly** – Min 2-1/2 in. (64 mm) thick reinforced lightweight or normal weight (100-150 pcf or 1600-2400 kg/m³) concrete. Floor assembly may also be constructed of any min 6 in. (152 mm) thick UL Classified hollow-core **Precast Concrete Units***. Wall may also be constructed of any UL Classified **Concrete Blocks***. Max diam of opening 6 in. (152 mm).
See **Concrete Blocks (CAZT)** and **Precast Concrete Units (CFTV)** categories in Fire Resistance Directory for names of manufacturers.
- Steel Sleeve** – (Optional) – Nom 6 in. (152 mm) diam (or smaller) Schedule 10 (or heavier) steel sleeve cast or grouted into floor or wall assembly. Steel sleeve may be installed flush or may project max 2 in. (51 mm) beyond the floor or wall surfaces.
- Cables** – Aggregate cross-sectional area of cables in opening to be max 44 percent of the cross-sectional area inside the sleeve or opening. Annular space between cables and periphery of opening or sleeve shall be min of 0 in. (0 mm, point contact) to max 2 in. (51 mm). Cables to be rigidly supported on both sides of floor or wall assembly. Any combination of the following types and sizes of cable may be used:
 - Max 200 pair No. 22 AWG (or smaller) copper conductor with polyvinyl chloride (PVC) insulation and jacketing material.
 - Max 1/C No. 750 kcmil (or smaller) copper conductor cable with cross-linked polyethylene (XLPE) jacket.
 - Max 7/C No. 12 AWG (or smaller) copper conductor power and control cables with XLPE or PVC insulation with XLPE or PVC jacket.
 - Max 3/C No. 4/0 AWG (or smaller) copper or aluminum conductor SER cables with PVC insulation and jacket.
 - Max 3/C No. 2/0 AWG (or smaller) copper conductor PVC jacketed aluminum clad or steel clad TECK 90 cable.
 - Max 110/125 fiber optic (F.O.) cable with PVC insulation and jacket.
 - Max 3/C with ground No. 8 AWG (or smaller) copper conductor NM cable with PVC insulation and jacket.
 - RG/U coaxial cable with fluorinated ethylene (FE) or PVC insulation and jacket.
 - Max 4 pair No. 24 AWG (or smaller) copper conductor data cable with Hylar jacket and insulation.
 - Max three conductor No. 12 AWG (or smaller) MC (BX) copper cable with polyvinyl chloride insulation and jacket materials.
 - Through Penetrating Product*** – Any aluminum or steel jacketed **Armored Cable**+ or **Metal Clad Cable**+ currently Classified under the **Through Penetrating Product** category.
See **Through Penetrating Product (XHLY)** category in the Fire Resistance Directory for names of manufacturers.
- Fill, Void or Cavity Materials* – Caulk or Sealant** – Min 1-1/2 in. (38 mm) thickness of caulk applied within the annulus, flush with bottom or top surface of floor or with both surfaces of wall. Min 1/4 in. (6 mm) diam bead of caulk applied to the penetrant/concrete or penetrant/sleeve interface at the point contact location on the bottom or top surface of floor or both surfaces of wall.

3M COMPANY – IC 15WB+ Caulk, CP 25WB+ Caulk or FB-3000 WT Sealant

Bearing the UL Listing Mark

*Bearing the UL Classification Mark

Reprinted from the Online Certifications Directory with permission from Underwriters Laboratories Inc.
Copyright © 2010 Underwriters Laboratories Inc.®



System No. C-AJ-3300

October 28, 2008

F Ratings – 2 and 3 Hr (See Item 2)

T Rating – 0 Hr

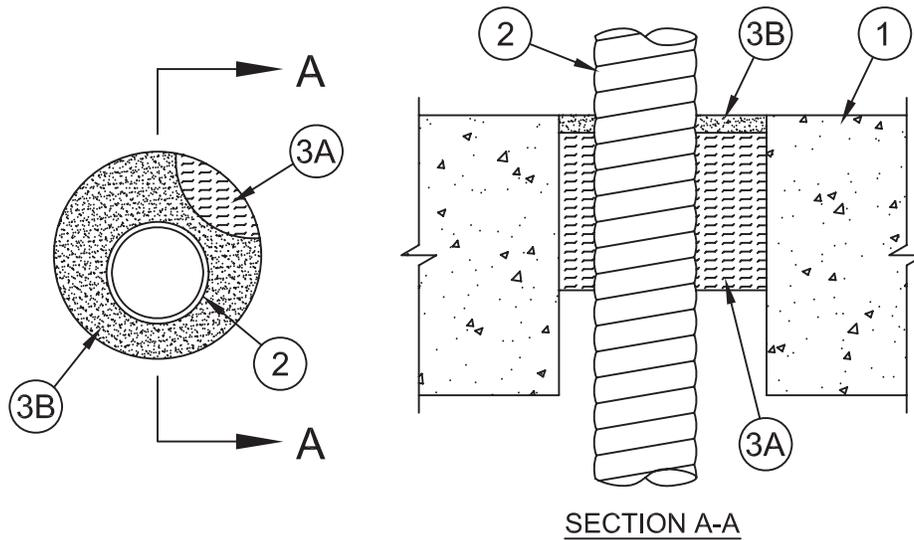

- Floor or Wall Assembly** – Min 4-1/2 in. (114 mm) thick reinforced lightweight or normal weight (100-150 pcf or 1600-2400 kg/m³) concrete. Wall may also be constructed of any UL Classified **Concrete Blocks***. Max diam of opening is 5 in. (127 mm).
See **Concrete Blocks (CAZT)** category in the Fire Resistance Directory for names of manufacturers.
- Through Penetrating Products*** – Nom 3 in. (76 mm) diam (or smaller), jacketed or unjacketed aluminum or steel Metal Clad (Type MC) cable with max four 750 kcmil (or smaller) aluminum or copper Type THHN or XHHW conductors. Max one metal clad cable to be installed near center of circular opening in floor or wall assembly. For 3 Hr F Rating, the annular space between the cable and periphery of the opening shall be min 1/2 in. (13 mm) to max 1-1/2 in. (38 mm). For 2 hr F Rating, the annular space between cable and periphery of opening shall be min 0 in. (point contact) to max 2 in. (51 mm). Through penetrating product to be rigidly supported on both sides of floor or wall assembly.

SOUTHWIRE CO – Type MC**ALCAN CABLE, DIV OF ALCAN ALUMINUM CORP** – Stabiloy MC Cable

- Firestop System** – The firestop system shall consist of the following:
 - Packing Material** – Min 3 in. (76 mm) thickness of min 4 pcf (64 kg/m³) mineral wool batt insulation firmly packed into opening as a permanent form. In floors, forming material is recessed min 1/4 in. (6 mm) below top surface of floor. In walls, forming material is centered in the mid-depth of wall and recessed a min of 1/4 in. (6 mm) from both surfaces of the wall to accommodate the fill material.
 - Fill Void or Cavity Materials* – Sealant** – Min 1/4 in. (6 mm) thickness of fill material applied within the annulus, flush with top surface of floor and with both surfaces of wall. Min 1/2 in. (13 mm) diam bead of fill material applied to the penetrant/concrete interface at the point contact location on the top surface of floor or both sides of wall.

3M COMPANY**3M FIRE PROTECTION PRODUCTS** – FB-1000 NS, FB-1003SL or FB-3000 WT

*Bearing the UL Classification Mark

Reprinted from the Online Certifications Directory with permission from Underwriters Laboratories Inc.

Copyright © 2010 Underwriters Laboratories Inc.®

System No. C-AJ-3310

October 11, 2011

ANSI/UL1479 (ASTM E814)

F Rating – 3 Hr

T Rating – 0 Hr

CAN/ULC S115

F Rating – 3 Hr

FT Rating – 0 Hr

FH Rating – 3 Hr

FTH Rating – 0 Hr

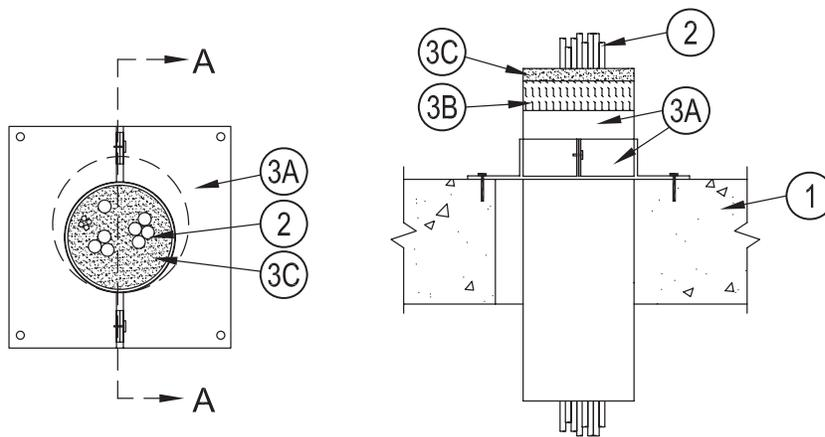

SECTION A-A

- Floor or Wall Assembly** – Min 4-1/2 in. (114 mm) thick reinforced lightweight or normal weight (100-150 pcf or 1600-2400 kg/m³) concrete. Floor assembly may also be constructed of any min 6 in. (152 mm) thick UL Classified hollow-core **Precast Concrete Units***. Wall may also be constructed of any UL Classified **Concrete Blocks***. Max diam of opening 6 in. (152 mm).
See **Concrete Blocks (CAZT)** and **Precast Concrete Units (CFTV)** categories in Fire Resistance Directory for names of manufacturers.
- Cables** – Aggregate cross-sectional area of cables in opening to be max 48 percent of the cross-sectional area inside the sleeve or opening. Annular space between cables and periphery of opening or sleeve shall be min of 0 in. (point contact) to max 2 in. (51 mm). Cables to be rigidly supported on both sides of floor or wall assembly. Any combination of the following types and sizes of cable may be used;
 - Max 400 pair No. 24 AWG (or smaller) copper conductor with polyvinyl chloride (PVC) insulation and jacketing material.
 - Max 1/C No. 750 kcmil (or smaller) copper conductor cable with cross-linked polyethylene (XLPE) jacket.
 - Max 7/C No. 12 AWG (or smaller) copper conductor power and control cables with XLPE or PVC insulation with XLPE or PVC jacket.
 - Max 3/C No. 4/0 AWG (or smaller) copper or aluminum conductor SER cables with PVC insulation and jacket.
 - Max 110/125 fiber optic (F.O.) cable with PVC insulation and jacket.
 - Max 3/C with ground No. 8 AWG (or smaller) copper conductor NM cable with PVC insulation and jacket.
 - Max No. 18 AWG RG/U coaxial cable with fluorinated ethylene (FE) or PVC insulation and jacket.
 - Max 4 pair No. 24 AWG (or smaller) copper conductor data cable with Hylar jacket and insulation.
 - Max 4 Pair No 22 AWG (or smaller) Cat 6 copper conductor with PVC insulation and jacket
 - Max 3/C No. 2/0 AWG (or smaller) aluminum or copper conductor cable with XLPE insulation and PVC jacket.
 - Max 3/C No. 2/0 aluminum or copper SE cable with PVC insulation and jacket.
 - Max three conductor No. 12 AWG (or smaller) MC (BX) copper cable with polyvinyl chloride insulation and jacket materials.
 - Through Penetrating Product*** – Any cables, **Armored Cable+** or **Metal Clad Cable+** currently Classified under the Through Penetrating Product category.
See **Through Penetrating Product (XHLY)** category in the Fire Resistance Directory for names of manufacturers.
- Firestop System** – The firestop system shall consist of the following:
 - Firestop Device*** – One firestop device module centered within the opening. The firestop device module consists of a 12 in. (305 mm) long galv steel split sleeve with galv steel flange plates. Firestop device module to be installed in accordance with the accompanying installation instructions. The space between the firestop device module and the periphery of the opening shall be min 0 in. (point contact) to max 1 in. (25 mm). Firestop device module secured in place by means of steel flange plates sized to accommodate the firestop device module. Steel flange plate installed on top sides of concrete floor or both sides of a wall or hollow core floor and secured around firestop device module with steel screws. The steel flange plate is then secured to both sides of the floor or wall assembly with masonry screws. The firestop device module is to be installed with its ends projecting an equal distance beyond each surface of the floor or wall assembly. After the installation of the cables (Item 2) and the packing material (Item 3B, if required), the supplied putty material (Item 3C) is to be packed into the end(s) of the firestop device with care taken to fill the interstices between the cables. A minimum depth of 1 in. (25mm) is required for the putty material at each end of device on the wall assemblies and the top side for floor assemblies.

3M COMPANY

3M FIRE PROTECTION PRODUCTS – 3M Fire Barrier Putty Sleeve Kit DT 100, DT 200 or DT 400

System No. C-AJ-3310 *continued*

- B. **Packing Material** – (Required for installation with cable fill of less than 40 percent. Optional on DT 100 and DT200 assemblies in wall assemblies.) – Min 2 in. (51 mm) thickness of min 4 pcf (64 kg/m³) mineral wool batt insulation firmly packed into top end of sleeve (Item 3A) as a permanent form. Packing material to be recessed from top end of sleeve to accommodate the required thickness of fill material.
- C. **Fill, Void or Cavity Material*** – After the installation of the packing material (Item 3B, if required), the supplied putty material is to be packed into each end of the firestop device. A min 1 in. (25mm) depth of the putty material is required at each end of device on the wall assemblies and the top side for floor assemblies.

3M COMPANY

3M FIRE PROTECTION PRODUCTS – 3M Fire Barrier MP+ Putty Stix

+Bearing the UL Listing Mark

*Bearing the UL Classification Mark

Reprinted from the Online Certifications Directory with permission from UL

© 2012 UL LLCv



Through Penetrations

Cables

3000 Series

Concrete

CAJ

System No. C-AJ-3321

July 29, 2013

ANSI/UL1479 (ASTM E814)
 F Ratings – 2 Hr
 T Rating – 1/4 Hr
 L Rating at Ambient - Less than 1 CFM/sq ft
 L Rating at 400 F - Less than 1 CFM/sq ft

CAN/ULC S115
 F Ratings – 2 Hr
 FT Rating – 1/4 Hr
 FH Ratings – 2 Hr
 FTH Rating – 1/4 Hr
 L Rating at Ambient - Less than 1 CFM/sq ft
 L Rating at 400 F - Less than 1 CFM/sq ft

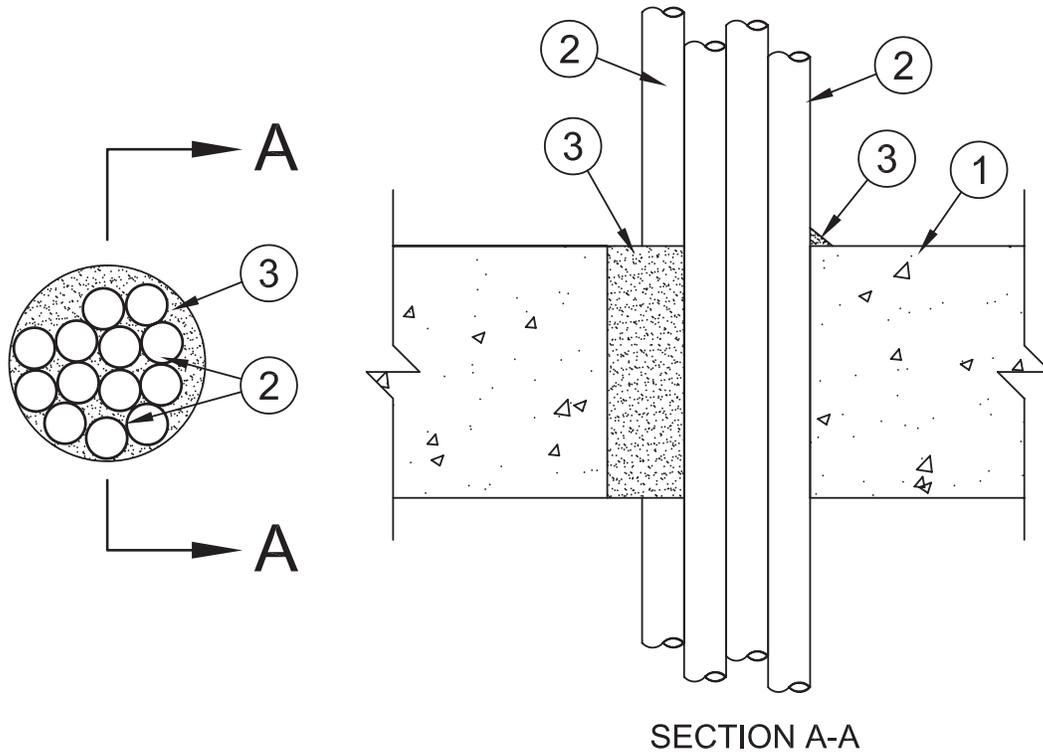

1. **Floor or Wall Assembly** – Min 2-1/2 in. (64 mm) thick lightweight or normal weight (100-150 pcf or 1600-2400 kg/m³) concrete. Max diam of opening is 6 in. (152 mm).
 2. **Cables** – Aggregate cross-sectional area of cables to be max 65 percent of the cross-sectional area of the opening. The annular space between cables and between cables and periphery of opening shall be min of 0 in. (point contact) to max 2 in. (51 mm). Any combination of the following types and sizes of cables may be used:
 - A. Max 200 pair No. 22 AWG (or smaller) copper conductor with polyvinyl chloride (PVC) insulation and jacketing material.
 - B. Max 1/C No. 750 kcmil (or smaller) copper conductor cable with cross-linked polyethylene (XLPE) jacket.
 - C. Max 7/C No. 12 AWG (or smaller) copper conductor power and control cables with XLPE or PVC insulation with XLPE or PVC jacket.
 - D. Max 3/C No. 4/0 AWG (or smaller) copper or aluminum conductor SER cables with PVC or XLPE insulation and jacket.
 - E. Max 3/C No. 2/0 AWG (or smaller) copper conductor PVC jacketed aluminum clad or steel clad TECK 90 cable.
 - F. Max 110/125 fiber optic (F.O.) cable with PVC insulation and jacket.
 - G. Max 3/C with ground No. 8 AWG (or smaller) copper conductor NM cable with PVC insulation and jacket.
 - H. RG/U coaxial cable with fluorinated ethylene (FE) or PVC insulation and jacket.
 - I. Max 4 pair No. 24 AWG (or smaller) copper conductor data cable with Hylar jacket and insulation.
 - J. Max three conductor No. 12 AWG (or smaller) MC (BX) copper cable with polyvinyl chloride insulation and jacket materials.
 - K. **Through Penetrating Product*** – Any cables, **Armored Cable+** or **Metal Clad Cable+** currently Classified under the **Through Penetrating Product** category.
- See **Through Penetrating Product** (XHLY) category in the Fire Resistance Directory for names of manufacturers.
3. **Fill, Void or Cavity Material*** – **Foam** – Min 2-1/2 in. (64 mm) thickness of fill material applied within the annulus, flush with top surface of floor or both surfaces of wall. Foam to be injected into the interstices between all cables. An additional 1/2 in. (13 mm) bead of foam shall be applied at the point contact locations.

3M COMPANY – Fire Barrier Rated Foam, FIP 1-Step

*Bearing the UL Classification Mark

Reprinted from the Online Certifications Directory with permission from UL
 © 2013 UL LLC



System No. C-AJ-3339

March 30, 2016

| ANSI/UL1479 (ASTM E814) | CAN/ULC S115 |
|-------------------------|-------------------|
| F Rating — 2 Hr | F Rating — 2 Hr |
| T Rating — 0 Hr | FT Rating — 0 Hr |
| | FH Rating — 2 Hr |
| | FTH Rating — 0 Hr |

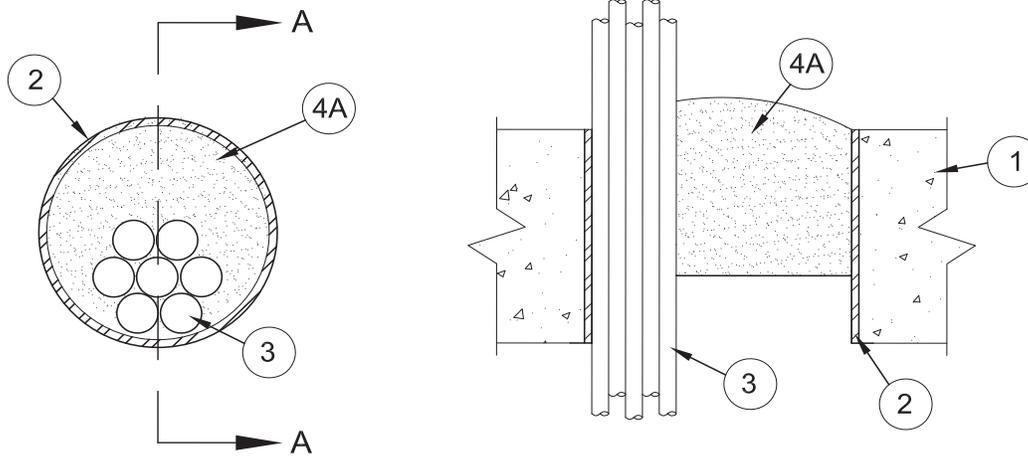

SECTION A-A

- Floor or Wall Assembly** — Min 4-1/2 in. (114 mm) thick reinforced lightweight or normal weight (100-150 pcf or 1600 - 2400 kg/m³) concrete. Wall may also be constructed of any UL Classified Concrete Blocks*. Max diameter of opening is nom 5 in. (127 mm).

See **Concrete Blocks** (CAZT) category in the Fire Resistance Directory for names of manufacturers.

- Metallic Sleeve** — (Optional) — Nom 2 or 4-1/2 in. (51 or 114 mm) diameter Schedule 5 (or heavier) steel sleeve or rigid steel conduit or electrical metallic tubing cast or grouted into floor or wall flush with floor or wall surfaces.

- Cables** — Aggregate cross-sectional area of bundled cables in opening to be max 60 percent of the cross-sectional area of the opening. Cables to be tightly bundled together and rigidly supported on both sides of the floor or wall assembly. Any combination of the following types and sizes of cables may be used:

- Max 300 pair No. 24 AWG (or smaller) copper conductor telecommunication cables with polyvinyl chloride (PVC) insulation and jacket.
- Max 1/C 750 kcmil (or smaller) copper conductor cable with cross-linked polyethylene (XLPE) insulation and jacket.
- Max 3/C No. 2 AWG copper or aluminum conductor cables with PVC insulation and jacket.
- Max 7/C No. 12 AWG copper conductor power and control cables with PVC or cross-linked polyethylene (XLPE) insulation and jacket and PVC jacket.
- Multiple fiber optic communication cables jacketed with PVC and having a max outside diameter of 1/2 in. (13mm).
- Max 3/C copper conductor No. 10 AWG (or smaller) with bare aluminum ground, PVC insulated steel or aluminum Metal-Clad cable.

- Firestop System** — The firestop system shall consist of the following:

- Fill, Void or Cavity Material*** — Plug sized for the steel sleeve or opening diameter to be friction-fitted within the sleeve or opening such that the outer circumference of the dome-shaped plug is flush with the top surface of the floor or with both surfaces of the wall. Plug cut to fit around the cable bundle and installed tightly within the opening.

3M COMPANY 3M FIRE PROTECTION PRODUCTS — 3M™ Fire Barrier Plug PLG2, 3M™ Fire Barrier Plug PLG4

- Fill, Void or Cavity Material*** — (Not Shown) — Fill material forced into interstices of cables to max extent possible.

3M COMPANY 3M FIRE PROTECTION PRODUCTS — CP 25WB+ Caulk or FB-3000 WT Sealant.

* Indicates such products shall bear the UL or cUL Certification Mark for jurisdictions employing the UL or cUL Certification (such as Canada), respectively.



Through Penetrations

Cables

3000 Series

Concrete

CAJ

System No. C-BJ-3016

September 07, 2004

(Formerly System No. 233)

F Rating – 4 Hr

T Ratings – 1, 1-1/2 and 2 Hr (See Items 2 and 6)

L Rating At Ambient – 129 CFM/sq ft

L Rating At 400 F – 92 CFM/sq ft

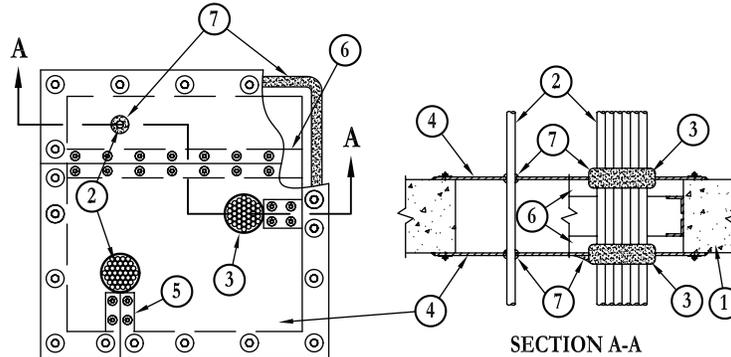

1. **Floor or Wall Assembly** – Min 5-1/2 in. thick lightweight or normal weight (100-150 pcf) concrete. Wall may also be constructed of any UL Classified **Concrete Blocks***. Max area of opening 1500 sq in. with max dimension of 50 in.
See **Concrete Blocks (CAZT)** category in the Fire Resistance Directory for names of manufacturers.
2. **Cables** – Individual cable or tightly-bound circular bundle of cables having a max bundle diam of 3 in. Min spacing between individual cables and/or cable bundles is 6 in. Cables rigidly supported on both sides of floor or wall assembly. The following types and sizes of copper conductor cables may be used:
 - A. Max 100 pair No. 24 AWG telephone cable; polyvinyl chloride (PVC) insulation and jacket materials. **When max 100 pr telephone cable is used, T Rating is 1-1/2 hr.**
 - B. Max 25 pr No. 24 AWG telephone cable; PVC insulation and jacket materials. **When max 25 pr telephone cable is used, T Rating is 2 hr.**
 - C. Max No. 12 AWG multi conductor power and control cable; PVC or cross-linked polyethylene insulation, PVC jacket. **When max No. 12 AWG multi conductor cable is used, T Rating is 2 hr.**

When an individual cable of the types listed above is installed in a max 1 in. diam through opening in the intumescent sheets (Item 4) and when only caulk fill material (Item 7) is used around the base of the cable at its egress from the intumescent sheet, the T Rating is 1 hr.

3. **Fill, Void or Cavity Materials* – Wrap Strip** – Nom 1/4 in. thick intumescent elastomeric material faced on one side with aluminum foil, supplied in nom 2 in. wide by 24 in. long strips. Single layer of wrap strip tightly-wrapped around each cable bundle. Wrap strip layer installed with foil side exposed and secured in place with steel wire ties. Wrap strip to extend approx 7/8 in. beyond each face of the intumescent sheet (Item 4) on both sides of the floor or wall assembly.
3M COMPANY – FS-195+
4. **Fill, Void or Cavity Materials* – Intumescent Sheet** – Rigid aluminum foil-faced sheet with galv steel sheet backer. Sheet cut to tightly-follow the contours of the individual cables and the contours of the wrap strip (Item 3) on the cable bundles. Sheets to lap a min of 2 in. on the floor or wall surface on all sides of the opening on both sides of the floor or wall assembly. Sheet to be installed with the galv steel sheet backer exposed (aluminum foil facing against floor or wall surface) and secured to floor or wall surface with min 3/16 in. diam by 1-1/4 in. long steel masonry fasteners with min 1-1/4 in. diam steel washers. Max spacing of fasteners not to exceed 6 in. with additional fasteners located on each side of butted seams or slits made to permit installation of the sheet around the individual penetrating items.
3M COMPANY – CS-195+
5. **Steel Cover Strip** – Min 2 in. wide strip of min 0.020 in. thick galv steel centered over butted seams of adjoining intumescent sheets and over entire length of each slit made in intumescent sheet (Item 4) to permit installation about the penetrating item(s). Prior to installation of the steel strip, the seam or slit in the intumescent sheet shall be covered with a nom 1/4 in. diam bead of caulk (Item 7). Steel cover strip secured to galv steel sheet backer of intumescent sheet with steel sheet metal screws or steel rivets spaced max 3 in. OC on each side of seam or slit.
6. **Support Channel** – When area of through opening exceeds 750 sq in., an intermediate support channel shall be installed on each side of floor or wall assembly, flush with floor or wall surface. Support channels to be min 1-5/8 by 1-5/8 in. and formed of min 0.093 in. thick (No. 12 ga) painted or galv steel. Ends of steel channel bolted or welded to steel angles anchored to inside walls of through opening. When steel support channels are centered beneath butted seams of intumescent sheets, no steel cover strip (Item 5), is required over butted seam. Intumescent sheets secured to steel support channels with steel sheet metal screws in conjunction with min 1-1/4 in. diam steel fender washers. When support channel is used beneath butted seam of intumescent sheets, fasteners spaced max 3 in. OC. on each side of butted seam. When support channel is located away from intumescent sheet seam, fasteners spaced max 6 in. OC. Prior to installation of the intumescent sheet(s), a nom 1/4 in. diam continuous bead of caulk (Item 7) shall be applied as a gasket over the steel support channel.
When steel support channels are used, T Rating is 1-1/2 hr.
7. **Fill, Void or Cavity Materials* – Caulk or Sealant** – Generous application of caulk to be applied around the base of the individual cables and contour applied wrap strip on cable bundle at their egress from the intumescent sheet on both sides of the floor or wall assembly. An additional bead of caulk shall be applied to the exposed edges of the wrap strip at its interface with the cable bundle on both sides of floor or wall assembly. An additional 1/4 in. diam bead of caulk shall be applied to edge of intumescent sheet at its interface with surface of floor or wall around entire perimeter. Caulk to be forced into interstices between bundled cables to max extent possible within confines of wrap strip on both sides of floor or wall assembly.
3M COMPANY – CP 25WB+ caulk or FB-3000 WT sealant.

*Bearing the UL Classification Mark

Reprinted from the Online Certifications Directory with permission from Underwriters Laboratories Inc.

Copyright © 2010 Underwriters Laboratories Inc.®



System No. C-BJ-3017

May 18, 2005

F Rating – 4 Hr

T Ratings – 1 and 1-1/2 Hr (See Item 2)

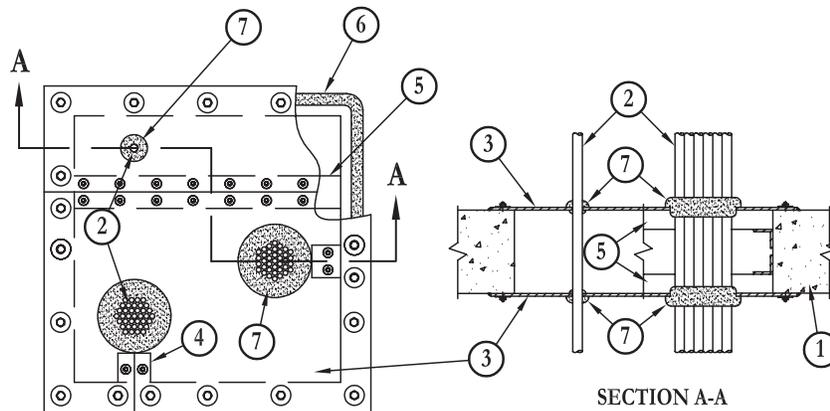

- Floor or Wall Assembly** – Min 8 in. (203 mm) thick normal weight (min 140 pcf or 2243 kg/m³) concrete. Wall may also be constructed of any UL Classified **Concrete Blocks***. Max area of opening 1500 sq in. (9677 cm²) with max dimension of 50 in. (1270 mm). See **Concrete Blocks (CAZT)** category in the Fire Resistance Directory for names of manufacturers.
- Cables** – Individual cables or tightly-bound circular bundle of cables having a max bundle diam of 3 in. (76 mm). Min spacing between individual cables and/or cable bundles is 6 in. (152 mm). Cables rigidly supported on both sides of floor or wall assembly. The following types and sizes of copper conductor cables may be used:
 - Max 100 pair No. 24 AWG telephone cable; polyvinyl chloride insulation and jacket materials. **When max 100 pair telephone cable is used, T Rating is 1 hr.**
 - Max 25 pair No.24 AWG telephone cable; polyvinyl chloride insulation and jacket materials. **When max 25 pair telephone cable is used, T Rating is 1-1/2 hr.**
 - Max No. 12 AWG multi conductor power and control cables; polyvinyl chloride or cross-linked polyethylene insulation, polyvinyl chloride jacket. **When max No. 12 AWG multi conductor cable is used, T Rating is 1 hr.**When an individual cable of the types listed above is installed in a max 1 in. (25 mm) diam through opening in the intumescent sheets (Item 3), the T Rating is 1-1/2 hr.
- Fill, Void or Cavity Materials*** – **Intumescent Sheet** – Rigid aluminum foil-faced sheet with galv steel sheet backer. Sheet cut to tightly-follow the contours of the individual cable or cable bundle but with a nom 1/4 in. to 3/8 in. (6 mm to 10 mm) wide annular space maintained between the penetrating item and the edges of the cutout in the intumescent sheet. Sheets to lap a min of 2 in. (51 mm) on the floor or wall surface on all sides of through opening on both sides of the floor or wall assembly. Sheet to be installed with the galv steel sheet backer exposed (aluminum foil facing against floor or wall surface) and secured to floor or wall surface with min 3/16 in. (5 mm) diam by 1-1/4 in. (32 mm) long steel masonry fasteners with min 1-1/4 in. (32 mm) diam steel washers. Max spacing of fasteners not to exceed 6 in. (152 mm) with additional fasteners located on each side of butted seams or slits made to permit installation of the sheet around individual penetrating items.

3M COMPANY – CS-195+
- Steel Cover Strip** – Min 2 in. (51 mm) wide strip of min. 0.020 in. (0.51 mm) thick galv steel centered over butted seams of adjoining intumescent sheets and over entire length of each slit made in intumescent sheet (Item 3) to permit installation about the penetrating item(s). Prior to installation of the steel strip, the seam or slit in the intumescent sheet shall be covered with a nom 1/4 in. (6 mm) diam bead of caulk (Item 6). Steel cover strip secured to galv steel sheet backer of intumescent sheet with steel sheet metal screws or steel rivets spaced max 3 in. (76 mm) OC on each side of seam or slit.
- Support Channel** – When area of through opening exceeds 750 sq in. (19 m), an intermediate support channel shall be installed on each side of floor or wall assembly, flush with floor or wall surface. Support channels to be min 1-5/8 in. by 1-5/8 in. (41 mm by 41 mm) and formed of min 0.093 in. (2.4 mm) thick (No. 12 gauge) painted or galv steel. Ends of steel channel bolted or welded to steel angles anchored to inside walls of through opening. When steel support channels are centered beneath butted seams of intumescent sheets, no steel cover strip (Item 4) is required over butted seam. Intumescent sheets secured to steel support channels with steel sheet metal screws in conjunction with min 1-1/4 in. (32 mm) diam steel fender washers. When support channel is used beneath butted seam of intumescent sheets, fasteners spaced max 3 in. (76 mm) OC on each side of butted seam. When support channel is located away from intumescent sheet seam, fasteners spaced max 6 in. OC. Prior to installation of the intumescent sheet(s), a nom 1/4 in. (6 mm) diam continuous bead of caulk (Item 6) shall be applied as a gasket over the support channel.
- Fill, Void or Cavity Material*** – **Caulk or Sealant** – Nom 1/4 in. (6 mm) diam continuous bead of caulk to be applied to edge intumescent sheet at its interface with surface of floor or wall around entire perimeter. (Item 5). Caulk also applied as a sealant over intumescent sheet seams.

3M COMPANY – CP 25WB+ caulk or FB-3000 WT sealant.
- Fill, Void or Cavity Materials*** – **Putty** – Moldable putty material kneaded by hand and packed into nom 1/4 in. to 3/8 in. (6 mm to 10 mm) annular space between individual cable or cable bundle and edges of cutout in intumescent sheet on both sides of floor or wall assembly. Putty material to be “domed” min 1 in. (25 mm) beyond intumescent sheet around perimeter of individual cable or cable bundle on both sides of floor or wall assembly.

3M COMPANY – MP+ Stix

*Bearing the UL Classification Mark

Reprinted from the Online Certifications Directory with permission from Underwriters Laboratories Inc.

Copyright © 2010 Underwriters Laboratories Inc.®



System No. F-A-3001

September 07, 2004

(Formerly System No. 560)

F Ratings – 3 Hr

T Rating – 0 Hr

L Rating At Ambient – 76 CFM/sq ft

L Rating At 400 F – 7 CFM/sq ft

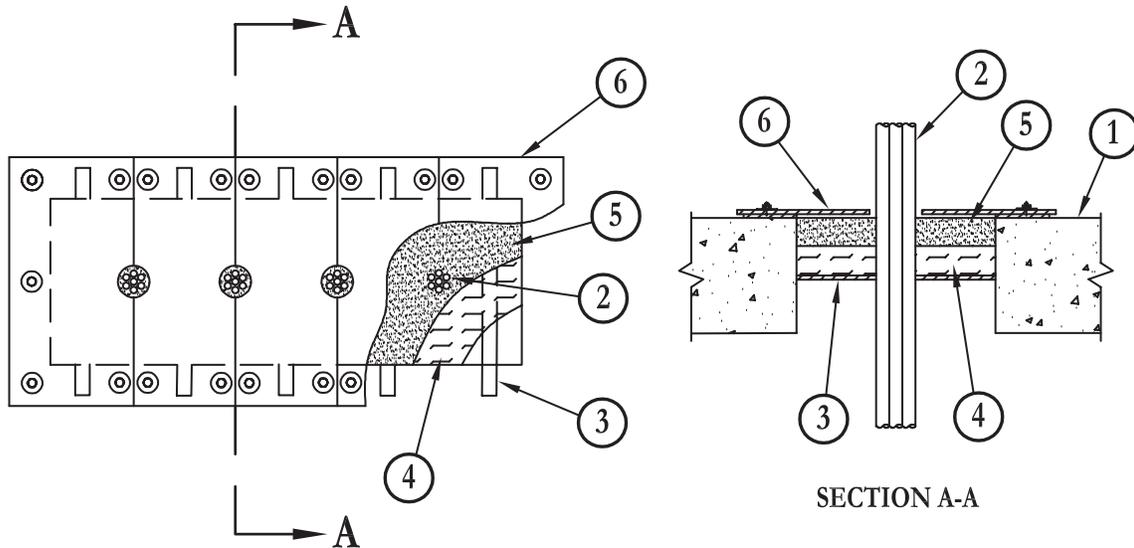

SECTION A-A

1. **Floor Assembly** – Min 4-1/2 in. thick lightweight or normal weight (100-150 pcf) concrete. Max area of rectangular through opening 500 sq in. with max length of 50 in. and with max width of 10 in.
2. **Cable** – Cables installed individually or in tight bundles having a max outside diam of 2 in. Individual or bundled cables installed along longitudinal centerline of through opening and spaced 4 to 8 in. apart. Cables rigidly supported on both sides of floor assembly. The following types and sizes of cable may be used:
 - A. Multiple fiber optical communication cables jacketed with polyethylene (PE) or polyvinyl chloride (PVC) and having a max outside diam of 3/4 in.
 - B. Max 150 pair No. 24 AWG copper conductor telephone cables with PVC insulation and jacket materials.
3. **Support Hanger** – Min 1 in. wide strips of min 0.034 in. thick (20 gauge) galv steel sheet bent to form a “hat” -shape with each “brim” of the hat shape bearing 1-1/2 to 2 in. on the top surface of the floor and with a min “crown” depth of 2 in. to accommodate the forming material (Item 4) and the caulk fill material (Item 5). Support hangers spaced max 8 in. OC with at least one support hanger located on each side of each cable bundle. When steel cover plate (Item 6) is not used and when width of opening is greater than 6 in., ends of each support hanger shall be secured to top surface of floor with min 3/16 in. diam by 1-1/2 in. long steel anchor bolts, or equivalent, in conjunction with min 1-1/4 in. diam steel fender washers.
- 3A. **Support Strip** (Not shown) – When steel cover plate (Item 6) is not used and when the annular space between the cables and the long edges of the through opening is greater than 2 in., support strips are required along both long edges of the opening. Support strips to consist of min 2 in. wide strips of min 0.034 in. thick (20 gauge) galv steel. Length of support strips to be 1 in. less than length of opening. Support strips placed atop support hangers within opening prior to installation of forming material (Item 4).
4. **Forming Material** – Min 1 in. thick mineral wool batt insulation material having a min density of 4 pcf tightly friction-fitted into through opening, atop support hangers, to prevent leakage of the caulk fill material (Item 5). Top surface of mineral wool batt forming material to be recessed min 1 in. from top surface of concrete floor slab.
5. **Fill, Void or Cavity Materials* – Caulk or Sealant** – Applied to fill the through opening to a min depth of 1 in., flush with top surface of floor.

3M COMPANY – CP 25WB+ caulk or FB-3000 WT sealant.
6. **Steel Cover Plate** – Min 0.034 in. thick (20 gauge) galv steel sheet cut to closely follow the contours of the individual and bundled telephone cables and with a min lap of 2 in. on all sides of the through opening. Steel cover plate sections secured to top surface of floor with min 3/16 in. diam by 1-1/2 in. long steel anchor bolts, or equivalent, in conjunction with min 1-1/4 in. diam steel fender washers. Max spacing of cover plate fasteners not to exceed 8 in. OC with additional fasteners required on each side of butted seams. When width of through opening is 8 in. or less, steel cover plate is not required.

*Bearing the UL Classification Marking

Reprinted from the Online Certifications Directory with permission from Underwriters Laboratories Inc.

Copyright © 2010 Underwriters Laboratories Inc.®



System No. F-A-3002

January 02, 2009

F Rating – 2 Hr

T Rating – 1 Hr

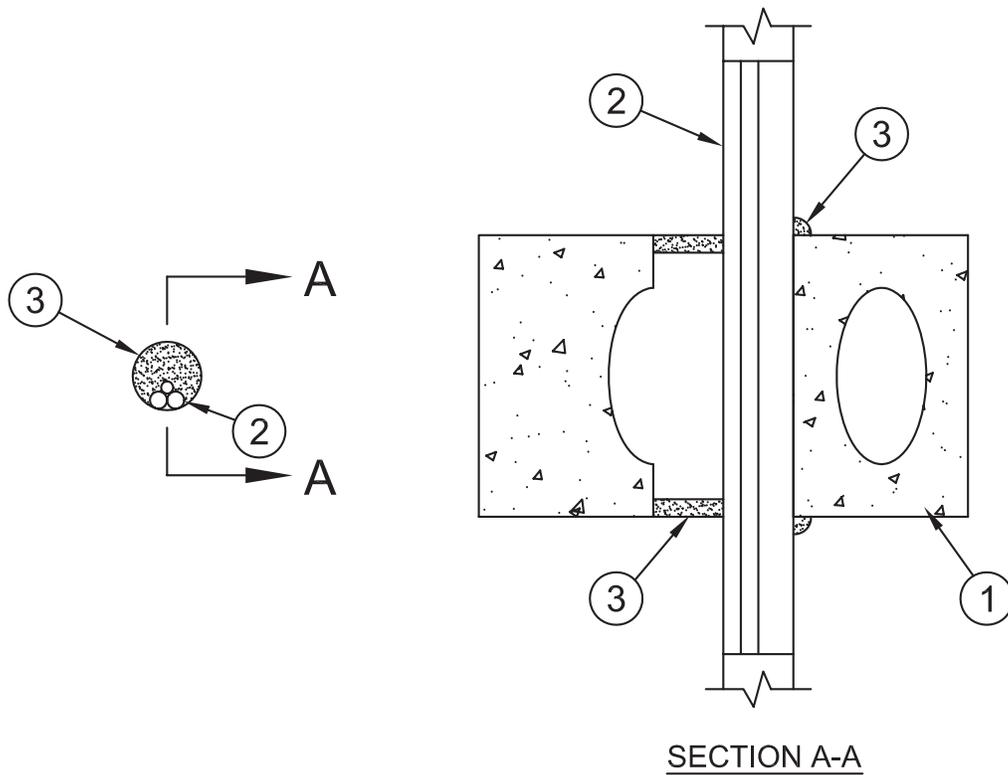

- 1. Floor Assembly** – Min 6 in. (152 mm) thick UL Classified hollow-core **Precast Concrete Units***. Floor may also be constructed of any min 6 in. (152 mm) thick reinforced lightweight or normal weight (100-150 pcf or 1600 - 2400 kg/m³) concrete. Max diam of opening is 2 in. (51 mm).
See **Precast Concrete Units** (CFTV) category in the Fire Resistance Directory for names of manufacturers.
- 2. Cables** – Aggregate cross-sectional area of cables in opening to be max 18 percent of the cross-sectional area of opening. Cables to be rigidly supported on both sides of floor or wall assembly. Any combination of the following types and sizes of copper conductor cable may be used:
 - A. Max 25 pair No. 24 AWG (or smaller) copper conductor with polyvinyl chloride (PVC) insulation and jacket.
 - B. Max No. 18 AWG RG 6/U coaxial cable with PVC insulation and jacket.
 - C. Max 3/C with ground No. 12 AWG (or smaller) NM cable with PVC insulation and jacket.
 - D. Max 3/C No. 2/0 AWG copper or aluminum conductor SE cables; PVC insulation and jacket.
- 3. Fill, Void or Cavity Materials* – Caulk or Sealant** – Min 1/2 in. (13 mm) thickness of fill material applied within the annulus, flush with each surface of floor. Min 1/2 in. (13 mm) thickness of fill material applied into interstices of cables on both sides of floor. Min 1/2 in. (13 mm) diam bead of caulk applied to the cable/concrete interface at the point contact locations on both surfaces of floor.

3M COMPANY – CP 25 WB+, IC 15WB+ caulk or FB-3000 WT sealant

*Bearing the UL Classification Mark

Reprinted from the Online Certifications Directory with permission from Underwriters Laboratories Inc.
Copyright © 2010 Underwriters Laboratories Inc.®



Through Penetrations

Cables

3000 Series

Concrete

FA

System No. F-A-3017

May 18, 2005
F Rating – 3 Hr
T Rating – 1/4 Hr

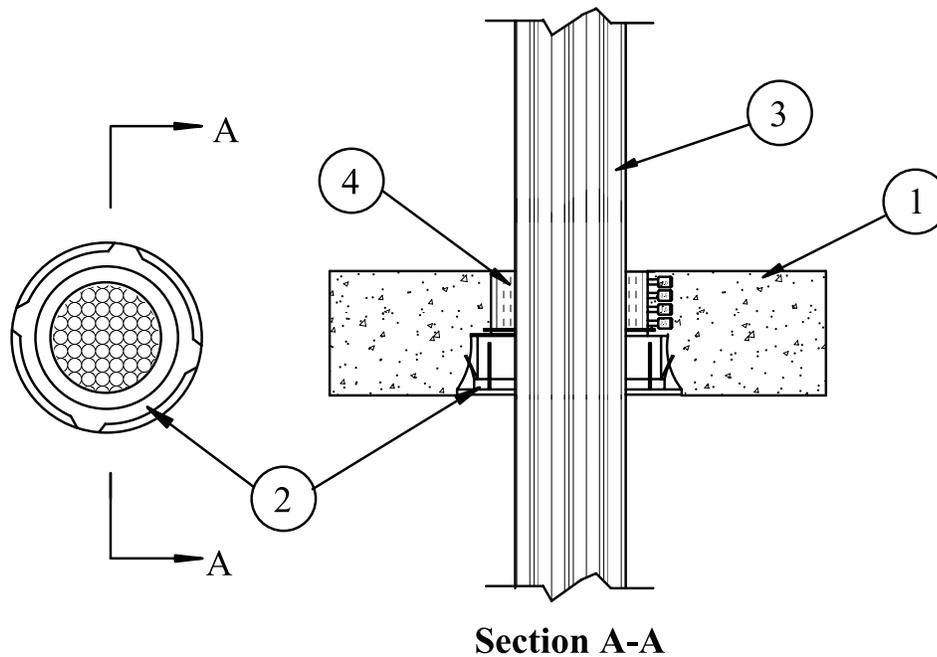

1. **Floor Assembly** – Min 4-1/2 in. (114 mm) thick reinforced lightweight or normal weight (100-150 pcf or 1600-2400 kg/m³) concrete.
2. **Firestop Device*** – Cast in place firestop device permanently embedded during concrete placement or grouted in concrete assembly in accordance with accompanying installation instructions. The device may be trimmed flush with top surface of floor or may project up to a max 3-1/2 in. (89 mm). above top surface of floor.
 - 3M COMPANY** – 3M Fire Barrier Cast-In Device 2MCID, 3MCID, 4MCID
- 2A. **Firestop Device – Height Adapter*** (not shown) – For use in floors greater than 8 in. thick. Adapter snaps onto top of firestop device (Item 2).
 - 3M COMPANY** – 3M Fire Barrier Cast-In Device Height Adapter, 2HA, 3HA, 4HA
3. **Cables** – Max cable bundles of 2-1/2, 3 and 4 in. (64, 76, and 102 mm) diam for 2MCID, 3MCID and 4MCID devices, respectively. Annular space between cables and periphery of opening shall be min of 0 in. (point contact) to max 2 in. (0 mm to max 51 mm) Cables may or may not be routed through flexible metal conduit with or without vinyl coating. Cables to be rigidly supported on both sides of floor assembly. Any combination of the following types and sizes of cable may be used;
 - A. Max 200 pair No. 22 AWG (or smaller) copper conductor with polyvinyl chloride (PVC) insulation and jacketing material.
 - B. Max 1/C No. 750 kcmil (or smaller) copper conductor cable with cross-linked polyethylene (XLPE) jacket.
 - C. Max 7/C No. 12 AWG (or smaller) copper conductor power and control cables with XLPE or PVC insulation with XLPE or PVC jacket.
 - D. Max 3/C No. 3/0 AWG (or smaller) copper or aluminum conductor SER cables with PVC insulation and jacket.
 - E. Max 3/C No. 2/0 AWG (or smaller) copper conductor PVC jacketed aluminum clad or steel clad TECK 90 cable.
 - F. Max 110/125 fiber optic (F.O.) cable with PVC insulation and jacket.
 - G. Max 3/C with ground No. 8 AWG (or smaller) copper conductor NM cable with PVC insulation and jacket.
 - H. RG/U coaxial cable with fluorinated ethylene (FE) or PVC insulation and jacket.
 - I. Max 4 pair No. 24 AWG (or smaller) copper conductor data cable with Hylar jacket and insulation.
 - J. Max three conductor No. 12 AWG (or smaller) MC (BX) copper cable with polyvinyl chloride insulation and jacket materials.
 - K. **Through Penetrating Product*** – Any cables, Armored Cable+ or Metal Clad Cable+ currently Classified under the Through Penetrating Product category.
 - See **Through Penetrating Product** (XHLY) category in the Fire Resistance Directory for names of manufacturers
4. **Packing Material** – Min 2 in. (51 mm) thick of min 4 pcf (64kg/m³) mineral wool batt insulation firmly packed within annulus, flush with the top surface of floor.
- 4A. **Fill, Void or Cavity Materials – Sealant, Caulk or Putty*** (optional, not shown) – As an option, the packing material (Item 2B) may be reduced in thickness by 1/4 to 1/2 in. (6 mm to 13 mm) and recessed from the top surface of floor to accommodate a 1/4 to 1/2 in. (6 mm to 13 mm) thickness of sealant, caulk or putty, installed within annulus, flush with the top surface of floor.
 - 3M COMPANY** – FB-1000 NS, FB-1003 SL, FB-3000 WT sealant, CP 25WB+, FireDam 150+, IC 15WB+ caulk or MP+ Stix putty.

*Bearing the UL Classification Mark

Reprinted from the Online Certifications Directory with permission from Underwriters Laboratories Inc.
Copyright © 2010 Underwriters Laboratories Inc.®



System No. F-A-3020

August 18, 2003

F Rating – 2 Hr

T Rating – 1/4 Hr

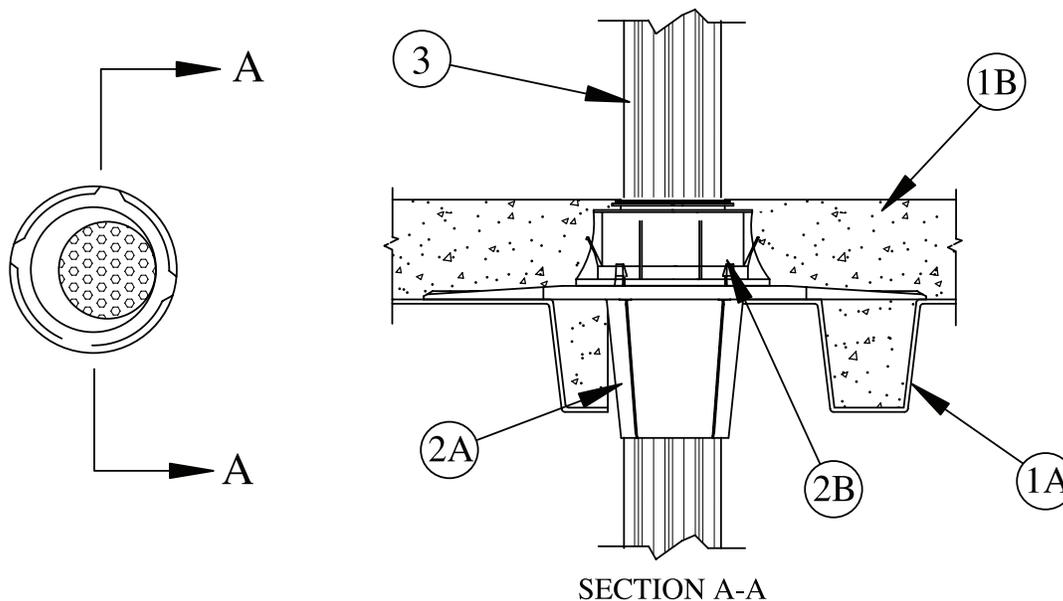

- Floor Assembly** – The fire-rated unprotected concrete and steel floor assembly shall be constructed of the materials and in the manner specified in the individual D900 Series designs in the UL Fire Resistance Directory and as summarized below:
 - Concrete** – Min 2-1/2 in. (64 mm) thick reinforced lightweight or normal weight (100-150 pcf or 1600-2400 kg/m³) concrete.
 - Steel Floor and Form Units*** – Composite or noncomposite max 3 in. (76 mm) deep fluted galv units as specified in the individual Floor-Ceiling design.
- Firestop Devices*** – The firestop devices are cast in place and permanently embedded during concrete placement or grouted in concrete assembly in accordance with accompanying installation instructions.
 - Firestop Device – Metal Deck Adapter*** – Adapter installed through opening in deck and secured with four sheet metal screws to deck in accordance with installation instructions.
3M COMPANY – 3M Fire Barrier Cast-In Device Metal Deck Adapter, 2MDA, 3MDA, 4MDA
 - Firestop Device** – Snapped into top of metal deck adapter in accordance with accompanying installation instructions. The device may be trimmed flush with top surface of floor or may project up to a max 5-1/2 in. (140 mm) above top surface of floor.
3M COMPANY – 3M Fire Barrier Cast-In Device, 2MCID, 3MCID, 4MCID
- Cables** – A max 3 in. (76 mm) diam of tightly bundled cables to be installed eccentrically or concentrically within the firestop system. Annular space between cables and periphery of opening shall be min of 0 in. (point contact) to max 1-1/2 in. (0 mm to max 38 mm). Cables to be rigidly supported on both sides of floor assembly. Any combination of the following types and sizes of cable may be used;
 - Max 300 pair No. 22 AWG (or smaller) copper conductor with polyvinyl chloride (PVC) insulation and jacketing material.
 - Max 1/C No. 750 kcmil (or smaller) copper conductor cable with cross-linked polyethylene (XLPE) jacket.
 - Max 7/C No. 12 AWG (or smaller) copper conductor power and control cables with XLPE or PVC insulation with XLPE or PVC jacket.
 - Max 3/C No. 3/0 AWG (or smaller) copper or aluminum conductor SER cables with PVC insulation and jacket.
 - Max 3/C No. 2/0 AWG (or smaller) copper conductor PVC jacketed aluminum clad or steel clad TECK 90 cable.
 - Max 110/125 fiber optic (F.O.) cable with PVC insulation and jacket.
 - Max 3/C with ground No. 8 AWG (or smaller) copper conductor NM cable with PVC insulation and jacket.
 - RG/U coaxial cable with fluorinated ethylene (FE) or PVC insulation and jacket.
 - Max 4 pair No. 24 AWG (or smaller) copper conductor data cable with Hylar jacket and insulation.
 - Max three conductor No. 12 AWG (or smaller) MC (BX) copper cable with polyvinyl chloride insulation and jacket materials.
 - Through Penetrating Product*** – Any cables, **Armored Cable+** or **Metal Clad Cable+** currently Classified under the **Through Penetrating Product** category.
See **Through Penetrating Product** (XHLY) category in the Fire Resistance Directory for names of manufacturers
- Packing Material** (not shown) – Min 2 in. (51 mm) thickness of min 4 pcf (64 kg/m³) mineral wool batt insulation firmly packed into the top of the firestop device (Item 2B) a permanent form, flush with the top surface of the floor.

*Bearing the UL Classification Mark

Reprinted from the Online Certifications Directory with permission from Underwriters Laboratories Inc.
Copyright © 2010 Underwriters Laboratories Inc.®

System No. F-A-3053

September 20, 2011

ANSI/UL1479 (ASTM E814)

F Rating – 2Hr

T Ratings – 1 and 1-1/2 Hr (See Item 4)

CAN/ULC S115

F Rating – 2 Hr

FT Ratings – 1 and 1-1/2 Hr (See Item 4)

FH Rating – 2 Hr

FTH Ratings – 1 and 1-1/2 Hr (See Item 4)

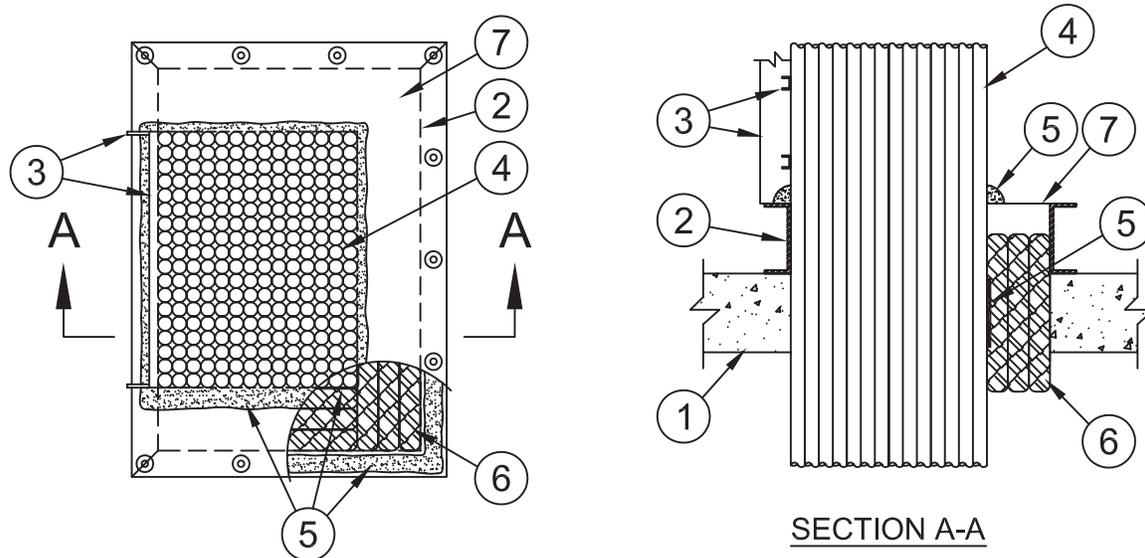
**SECTION A-A**

1. **Floor Assembly** – Min 4-1/2 in. (114 mm) thick reinforced lightweight or normal weight (100-150 pcf or 1600-2400 kg/m³) concrete. Max area of opening is 432 in.² (0.28 m²) with max dimension of 24 in. (610 mm).
2. **Sheathing** – Nom 1-5/8 by 4 in. (41 by 102 mm) high C4X5.4 structural steel channels with mitered ends formed into four-sided enclosure with welded corners. Inside dimensions of enclosure, between flange tips, to be equal to the inside dimensions of the floor opening. Sheathing channels secured to the top surface of the concrete floor by means of nominal 1/4 in. (6 mm) diam by 1-3/4 in. (45 mm) long concrete anchors with nom 1/4 in. (6 mm) by 1-1/4 in. (32 mm) diam steel fender washers. Rope of putty (Item 7) installed as gasket between sheathing and top of floor.
3. **Cable Rack** – Max 18 in. (457 mm) wide ladder type cable rack with 2 in. (51 mm) side rails fabricated from min 0.136 in. (3.5 mm) thick steel and with nom 1 in. (25 mm) wide rungs spaced max 9 in. (229 mm) OC. Width of cable rack to be min 4 in. (102 mm) less than width of opening. Side rails of cable rack to be offset min 2 in. (51 mm) from side edges of opening. Cable rack welded to top flange of sheathing channel (Item 2).
4. **Cables** – Max 62 percent fill of cables calculated based on the inside dimensions of the floor opening and the outside dimensions of the cable bundle. Power cables to be installed in accordance with the National Electrical Code (NFPA No. 70). The cables are to be laced, banded or tied to the cable rack to form a tight bundle against one side of the opening with minimal interstices between cables. The annular space between the cables and the side of the opening with the cable rack shall be 0 in. (point contact). The annular space between the cable bundle and the sides of the opening shall be min 2 in. (51 mm) to max 9 in. (229 mm). Any combination of the following types and sizes of cables may be used:
 - A. Max 300 pair No. 24 AWG (or smaller) copper conductor telecommunication cable with PVC insulation and jacket materials.
 - B. Max 1/C No. 3/0 AWG copper conductor cable with PVC insulation and jacket materials.
 - C. Max three copper conductors (with ground) No. 12 AWG steel Armored Cable+.
 - D. Max three copper conductor (with ground) No. 2 AWG Metal Clad Cable+.
 - E. Max 1/C No. 750 kcmil (or smaller) copper conductor power cable with cross-linked polyethylene (XLPE) insulation and fabric jacket materials.
 - F. Max 3/C (with ground) No. 4/0 AWG (or smaller) copper or aluminum conductor SER cable with XLPE or PVC insulation and jacket.
 - G. Max 100 pair No. 24 AWG (or smaller) copper conductor telecommunication cable with PVC insulation and jacket materials.
 - H. Max 4/C No. 18 AWG (or smaller) copper conductor thermostat cable with polyvinyl chloride (PVC) insulation and jacket materials.
 - I. Max four pair No. 22 AWG (or smaller) copper conductor Category 5 or Category 6 data cable with PVC insulation and jacket materials.
 - J. Max 3/C (with ground) No. 10 AWG (or smaller) nonmetallic sheathed (Romex) cable with PVC insulation and jacket materials.
 - K. Max twelve core No. 24 AWG shielded coaxial cable with high density polyethylene foam insulation and fluorinated ethylene (FE) or PVC jacket.
 - L. Max 62.5/125 micron fiber optic cable with having a min Riser rating.
 - M. Max 7/C No. 12 AWG (or smaller) copper conductor control cable with PVC insulation and jacket materials.

When Item 4A, 4B, 4C, 4D, 4E or 4F is used, T, FT and FTH Ratings are 1 hr. Otherwise, T, FT and FTH Ratings are 1-1/2 hr.

System No. F-A-3053 continued

5. **Fill, Void or Cavity Material* – Putty** – Min 1/4 in. (6 mm) diam continuous rope of putty applied beneath sheathing (Item 2) around entire perimeter of through opening. Min 1/8 in. (3mm) thick by 4 in. (102mm) wide continuous band of putty installed around the cable bundle such that the top edge of the band is flush with the top surface of the floor. Prior to installation of the steel cover plate all voids between the pillows and the concrete shall be filled with a min 1/2 in. (13 mm) depth of putty and a min 1/4 in. (6 mm) diam rope of putty shall be applied over the top surface of the steel sheathing. After installation of the steel cover a “dome” of putty fill material shall be tightly packed around the perimeter of the cable bundle at its egress from the steel cover. The “dome” of putty shall be min 1 in. (25 mm) thick and extend to a min height of 1 in. (25 mm) above the top of the steel cover with the interstices between cables filled with putty to the maximum extent possible.

3M COMPANY

3M FIRE PROTECTION PRODUCTS – MP+ Putty

6. **Fill Void or Cavity Material* – Pillows** – Nom 9 in. (229 mm) long by 6 in. (152 mm) wide by 2 and 3 in. (51 and 76 mm) thick plastic covered pillows tightly-packed to fill annular space between the cables and the concrete floor. Pillows installed with 9 in. (229 mm) dimension projecting through the floor and centered in the floor thickness. The pillows may be cut to decrease the width and repaired with min 0.002 in. (0.05mm) thick polyester tape with acrylic adhesive. The tape must overlap onto the existing pillow a min of 1/2 in. (13mm).

3M COMPANY

3M FIRE PROTECTION PRODUCTS – Fire Barrier Pillow or Fire Barrier Self-Locking Pillows

7. **Steel Cover** – Min 20 ga galv steel plate cut to tightly follow contours of cable bundle and secured to structural steel channel sheathing (Item 2) with No. 8 self-tapping screws spaced max 6 in. (152 mm) OC.

+Bearing the UL Listing Mark

*Bearing the UL Classification Mark

Reprinted from the Online Certifications Directory with permission from Underwriters Laboratories Inc.
Copyright © 2011 Underwriters Laboratories Inc.®



Through Penetrations

Cables

3000 Series

Concrete

FA

System No. F-B-3004

September 07, 2004

F Rating – 2 Hr

T Ratings – 1-1/2 and 2 Hr (See Item 5)

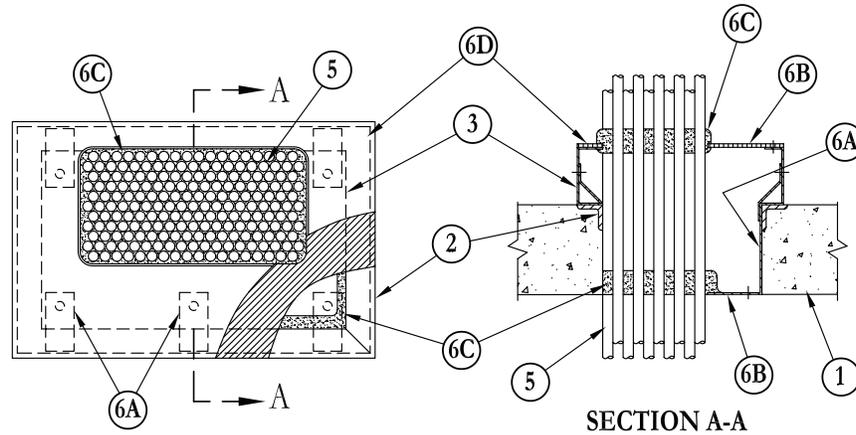

1. **Floor Assembly** – Min 8 in. thick reinforced normal weight (145-150 pcf or 2300-2400 kg/m³) concrete. Max area of opening is 288 sq in. (1858 cm²) with max dimension of 24 in. (610 mm).
2. **Steel Angles** – Nom 2 by 2 by 1/4 in. (51 by 51 by 6 mm) steel angles cast into the concrete floor flush with its top surface.
3. **Sheathing** – Nom 1-5/8 by 4 in. (41 by 102 mm) high C4X5.4 structural steel channels with mitered ends formed into four sided enclosure with welded corners. Inside dimensions of enclosure, between flange tips, to be equal to the inside dimensions of the floor opening. Sheathing channels welded to steel angles (Item 2) around the entire perimeter of the opening.
4. **Cable Rack** (Not shown) – Max 20 in. (508 mm) wide ladder type cable rack fabricated from min 0.136 in. (3.45 mm) thick steel channels with nom 2 in. (51 mm) wide side rails and nom 1 in. (25 mm) wide rungs spaced 9 in. (229 mm) OC. Cable rack shall be welded to top flange of sheathing channel (Item 3).
5. **Cables** – Max 34 percent fill (based on the available area of the opening) of either telecommunication or power cable. The cables are to be laced to the cable rack and to each other to form a tight bundle against one side of the opening with min interstices between cables. The following types of cables may be used:
 - A. Max 72 pair No. 26 AWG telecommunication cable with PVC insulation and jacket materials. When telecommunication cable is used, the T Rating is 2 hr.
 - B. Single conductor max 750 kcmil Type RHW power cable. When single conductor power cable is used, T Rating is 1-1/2 hr.
6. **Firestop System** – The firestop system shall consist of the following items
 - A. **Stirrups** – Nom 2 in. (51 mm) wide by 1/8 in. (3.2 mm) thick steel strip formed into stirrup with sufficient length to support intumescent sheet (Item 6B) approx flush with bottom surface of floor. Top of stirrup angled for bolt attachment against web of steel channel (Item 3). Bottom of stirrup bent 90 degrees to form a 2 in. (51 mm) long flange for support and attachment of the intumescent sheet. The stirrups shall be located in each corner of the opening and spaced max 12 in. (305mm) OC.
 - B. **Fill, Void or Cavity Material* – Intumescent Sheet** – Rigid aluminum foil faced sheet with galv steel sheet backer. Intumescent sheet cut to tightly fit inside through opening atop stirrup flanges (Item 6A) and to closely follow the contours of the cable bundle. Intumescent sheet installed in opening atop stirrup flanges, with galv steel sheet face down, and recessed max 1/8 in. (3.2 mm) from bottom surface of floor. Intumescent sheet secured to each stirrup with 1/4 in. (6 mm) diam by 1 in. (25 mm) long steel bolts with nuts and washers or min No. 8 self-tapping sheet metal screws and 1-1/4 (32 mm) fender washers. Second intumescent sheet cut to fit outside dimensions of sheathing and to tightly follow contours of the cable bundle. Intumescent sheet installed atop sheathing, with galv steel sheet face up, and secured to top flange of sheathing channels in conjunction with the steel cover plate (Item 6D) with 1/4 in. (6 mm) diam by 1 in. (25 mm) steel bolts with nuts and washers spaced max 8 in. (203 mm) OC.

3M COMPANY – CS-195+
 - C. **Fill, Void or Cavity Materials* – Graphite Seal, Caulk, Sealant or Putty** – One layer of 1/2 in. (13 mm) x 1/16 in. (1.6 mm) adhesive backed graphite intumescent seal positioned under intumescent sheet around entire perimeter of through opening or min 1/4 in. (6 mm) diam continuous bead of caulk or putty applied to edge of intumescent sheet at its interface with surface of floor around entire perimeter of through opening. Additional putty applied at the perimeter of each intumescent sheet and the base of the cable bundle at its egress from each intumescent sheet. After installation of the intumescent sheet within the through opening, a min 1/2 in. (13 mm) diam bead of putty shall be installed around the top edges of the sheet and the periphery of the opening. Additional putty to be “domed” around the perimeter of the cable bundle to a min thickness of 1 in. (25 mm) and to a height of 2 in. (51 mm) atop the intumescent sheet. Prior to installation of the top intumescent sheet and steel cover plate, a min 1/2 in. (13 mm) diam bead of putty shall be applied over the top surface of the steel sheathing. After installation of the top intumescent sheet and the steel cover plate, A “dome” of putty fill material shall be tightly packed around the perimeter of the cable bundle at its egress from the steel cover plate. The “dome” of putty shall be min 1 in. (25 mm) thick and extend to min height of 2 in. (51 mm) above the top of the steel cover plate.

3M COMPANY – E-FIS or Ultra GS seals, CP 25WB+ caulk, FB-3000 WT sealant or MP+ Stix putty.
 - D. **Steel Cover Plate** (Optional) – Min 0.100 in. (2.54 mm) (12 gauge) galv steel cover plate cut to fit the contour of the cable bundle. Steel cover plate placed atop the intumescent sheet and secured to sheathing, through intumescent sheet, with 1/4 in. (6 mm) diam by 1 in. (25 mm) long steel bolts with nuts and washers spaced max 8 in. (203 mm) OC.

*Bearing the UL Classification Mark

Reprinted from the Online Certifications Directory with permission from Underwriters Laboratories Inc.

Copyright © 2010 Underwriters Laboratories Inc.®



System No. F-B-3005

May 18, 2005

F Rating – 1 Hr

T Rating – 0 Hr

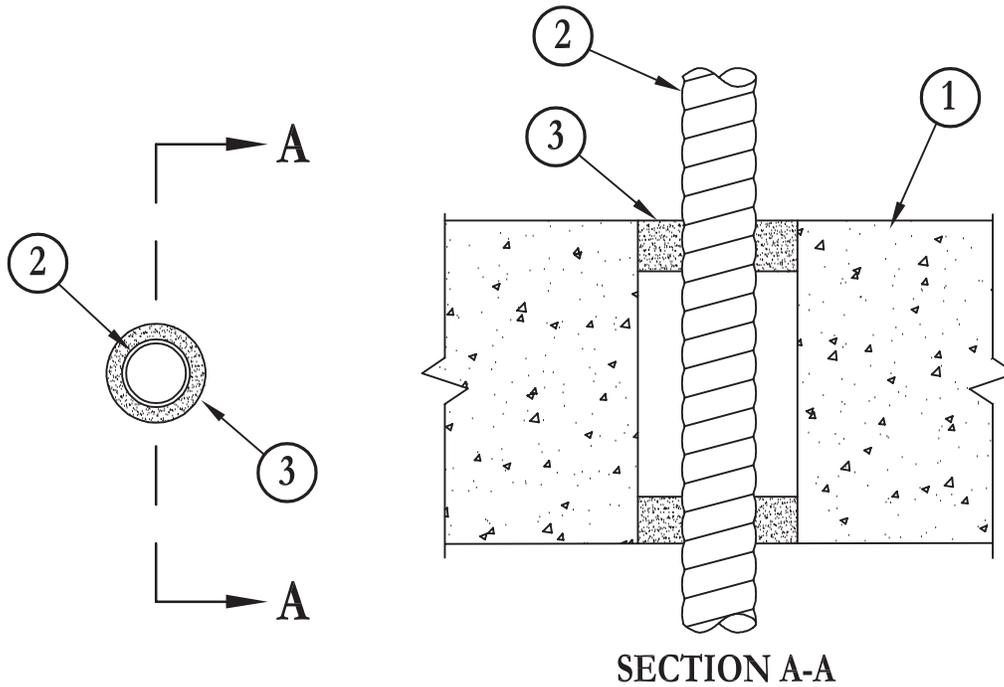

1. **Floor or Wall Assembly** – Min 6 in. (152 mm) thick reinforced lightweight or normal weight (100-150 pcf or 1600-2400 kg/m³) concrete. Floor may also be constructed of any min 6 in. (152 mm) thick UL Classified hollow-core **Precast Concrete Units***. Max diam of opening is 2 in. (51 mm).
See **Precast Concrete Units** (CFTV) category in the Fire Resistance Directory for names of manufacturers.
2. **Metal-Clad Cable**** – Max one nom 1/2 in. (13 mm) diameter (or smaller) steel or aluminum metal clad cable.
3. **Fill, Void or Cavity Materials*** – **Caulk** – Min 1-1/4 in. (6 mm) thickness of fill material applied within the annulus, flush with bottom surface of floor. Min 1/2 in. (13 mm) thickness of fill material applied within the annulus, flush with top surface of floor.
3M COMPANY – CP 25WB+ or IC 15WB+ caulk

++Bearing the UL Listing Mark

*Bearing the UL Classification Marking

Reprinted from the Online Certifications Directory with permission from Underwriters Laboratories Inc.
Copyright © 2010 Underwriters Laboratories Inc.®



Through Penetrations
Cables
3000 Series
Concrete
FB

System No. F-B-3008

May 18, 2005
 F Rating – 2 Hr
 T Rating – 1/4 Hr

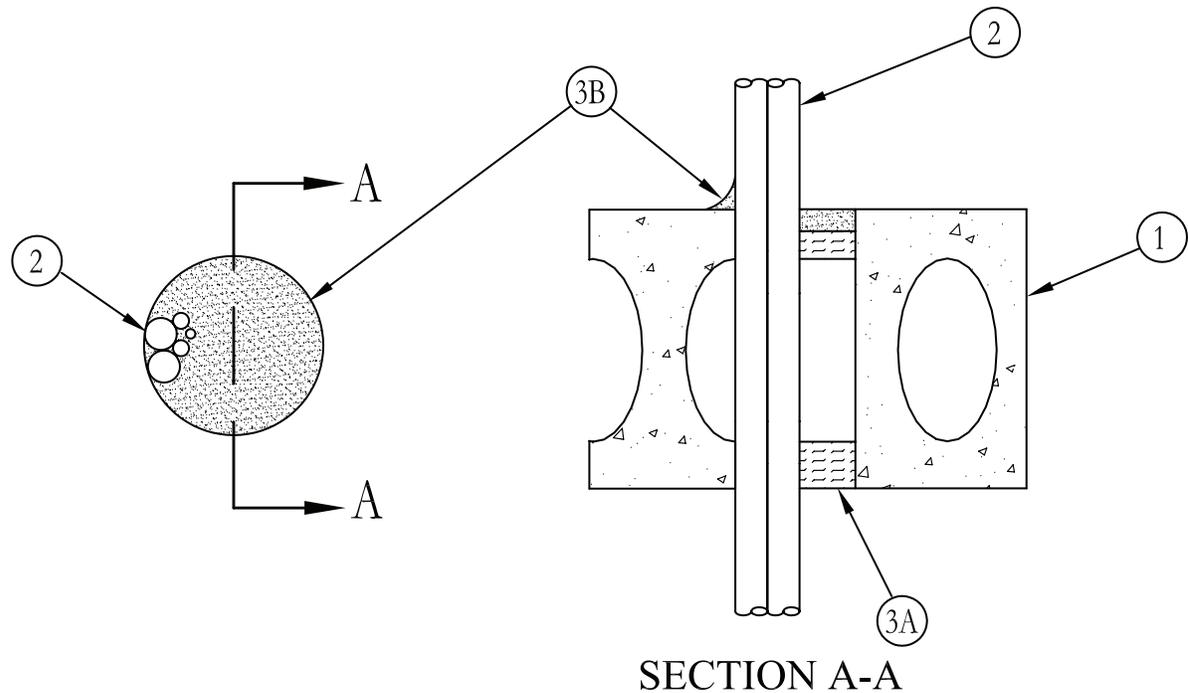

1. **Floor Assembly** – Min 6 in. (152 mm) thick UL Classified hollow-core **Precast Concrete Units***. Floor may also be constructed of any min 6 in. (152 mm) thick reinforced lightweight or normal weight (100-150 pcf or 1600-2400 kg/m³) concrete. Max diam of opening is 4 in. (102 mm).
 See **Precast Concrete Units** (CFTV) category in the Fire Resistance Directory for names of manufacturers.
2. **Cables** – Aggregate cross-sectional area of cables in opening to be min 24 percent to max 60 percent of the cross-sectional area of opening. Cables to be installed either concentrically or eccentrically within the firestop system. The annular space between cables and periphery of opening shall be min of 0 in. (point contact) to max 2 in. (0 mm to max 51 mm). Cables to be rigidly supported on both sides of floor or wall assembly. Any combination of the following types and sizes of copper conductor cable may be used:
 - A. Max 1/C 350 kcmil (or smaller) cable with PVC jacket.
 - B. Max 150 pair 24 ga (or smaller) cable with PVC insulation and jacket.
 - C. 3/C 2/0 aluminum or copper (or smaller) SE cable with ground with PVC insulation and jacket.
 - D. Max 3/C No. 12 AWG (or smaller) MC cable with PVC insulation and jacket.
 - E. Max RG 6/U No. 18 AWG (or smaller) coaxial cable with PVC insulation and jacket.
 - F. Max 2-125/250 fiber optic cable with polyethylene insulation.
3. **Firestop System** – The firestop system shall consist of the following:
 - A. **Packing Material** – Min 1-1/2 in. (38 mm) thickness of min 4 pcf (64 kg/m³) density mineral wool batt insulation firmly packed into the opening at the bottom surface of the floor. Min 1 in. (25 mm) thickness of min 4 pcf (64 kg/m³) density mineral wool batt insulation firmly packed into the top surface of the floor and recessed from the top surface to accommodate the required thickness of fill material.
 - B. **Fill, Void or Cavity Materials*** – **Caulk or Sealant** – Min 1/2 in. (13 mm) thickness of fill material applied within annulus, flush with top surface of floor. Min 1/2 in. (13 mm) diam bead of fill material applied to the cable/concrete interface at the point contact location at the top surface of floor.
3M COMPANY – FireDam 150+, CP 25WB+, IC 15WB+ caulk or FB-3000 WT sealant.

*Bearing the UL Classification Mark

Reprinted from the Online Certifications Directory with permission from Underwriters Laboratories Inc.
 Copyright © 2010 Underwriters Laboratories Inc.®



System No. F-B-3013

September 20, 2011

ANSI/UL1479 (ASTM E814)

F Rating – 2 Hr

T Ratings – 3/4 and 2 Hr (See Item 2)

L Ratings At Ambient – 7 and 22 CFM/sq ft (See Item 3)

L Ratings At 400 F – 4 and 21 CFM/sq ft (See Item 3)

CAN/ULC S115

F Rating – 2 Hr

FT Ratings – 3/4 and 2 Hr (See Item 2)

FH Rating – 2 Hr

FTH Ratings – 3/4 and 2 Hr (See Item 2)

L Ratings At Ambient – 7 and 22 CFM/sq ft (See Item 3)

L Ratings At 400 F – 4 and 21 CFM/sq ft (See Item 3)

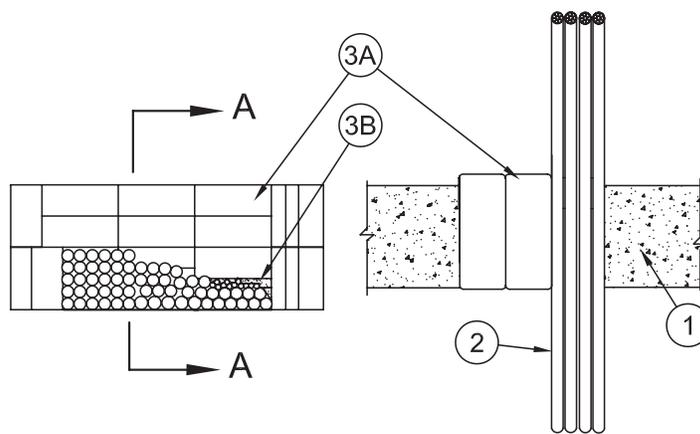

SECTION A-A

- Floor Assembly** – Min 8 in. (203 mm) thick lightweight or normal weight (100-150 pcf or 1600 to 2400 kg/m³) reinforced concrete. Max area of opening is 360 sq in. (0.23 m²) with max dimension of 30 in. (763 mm).
- 1A. Riser** – (Not Shown) – Nom 1-5/8 by 4 in. (41 by 102 mm) high C4X5.4 structural steel channels with mitered ends formed into four-sided enclosure with welded corners. Inside dimensions of enclosure, between flange tips, to be equal to the inside dimensions of the floor opening. Channels secured to floor with min 3/16 in. (5 mm) diam by min 1-1/4 in. (32 mm) long masonry anchors.
- Cables** – Max 40 percent fill (based on the available area of the opening). The cables are to be laced to the cable rack and to each other to form a tight bundle against one side of the opening with min interstices between cables. The annular space between the cables and periphery of opening shall be min 0 in. (point contact) to max 12 in. (305 mm). Any combination of the following types and sizes of cables may be used:
 - Max 750 kcmil single-conductor power cables; cross-linked polyethylene (XLPE) insulation.
 - Max 7C No. 12 AWG (or smaller) multi conductor power and control cables; XLPE insulation, XLPE or polyvinyl chloride (PVC) jacket.
 - Max 300 pair No. 22 AWG (or smaller) copper conductor with PVC insulation and jacket.
 - Max No. 18 AWG RG 6/U coaxial cable with PVC insulation and jacket.
 - Max 4/C No. 2/0 AWG (or smaller) copper or aluminum conductor cables with XLPE or PVC insulation and jacket.
 - Max 1-10/125 Fiber Optic (F.O.) cable with PVC insulation and jacket.

T, FT and FTH Ratings are 2 Hr for cable F and 3/4 Hr for all other cables.

- 2A. Cable Rack** – (Not shown) – Max 20 in. (508) wide ladder type cable rack fabricated from min 0.136 in. (3.5 mm) thick steel channels with nom 2 in. (51 mm) wide side rails and nom 1 in. (25 mm) wide rungs spaced 9 in. (229 mm) OC. Cable rack shall be welded to top flange of riser (Item 1A).
- Firestop System** – The firestop system shall consist of the following:
 - Fill Void or Cavity Material* – Pillows** – Max 9 in. (229 mm) long by 6 in. (152 mm) wide by 2 and 3 in. (51 and 76 mm) thick plastic covered pillows tightly-packed to fill annular space between cables and periphery of opening. Pillows installed with 9 in. (229 mm) dimension projecting through floor or wall and centered within the opening.
3M COMPANY – Fire Barrier Pillow or Fire Barrier Self-Locking Pillows
 - Fill Void or Cavity Material* – Putty** – After installation of pillows (Item 3B) all voids within the opening shall be filled with a min 1 in. (25 mm) thickness of putty. The individual cables may be wrapped with a min 1/4 in. (6 mm) thick by min 2 in. (51 mm) width of putty such that the putty extends approximately 1/2 in. (13 mm) above top surface of floor.
3M COMPANY – MP+, Cable Wrap

L Ratings are 7 and 4 CFM/sq ft. at ambient and 400° F, respectively, when individual cables are wrapped with 3M Cable Wrap or MP+ putty in accordance with the installation instructions. L Ratings are 22 and 21 CFM/sq ft. at ambient and 400° F, respectively, when individual cables are not wrapped with 3M Cable Wrap or MP+ putty.

*Bearing the UL Classification Mark

Reprinted from the Online Certifications Directory with permission from Underwriters Laboratories Inc.

Copyright © 2011 Underwriters Laboratories Inc.®



System No. F-B-3016

September 20, 2011

ANSI/UL1479 (ASTM E814)

F Rating – 2 Hr

T Ratings – 1/2 and 1 Hr (See Item 4)

CAN/ULC S115

F Rating – 2 Hr

FT Ratings – 1/2 and 1 Hr (See Item 4)

FH Rating – 1 Hr

FTH Ratings – 1/2 and 1 Hr (See Item 4)

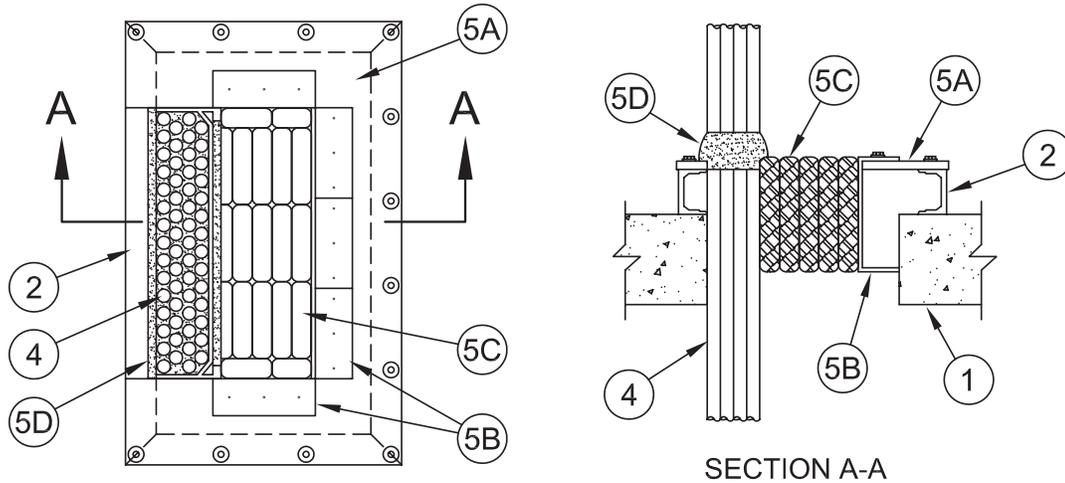
**SECTION A-A**

1. **Floor Assembly** – Min 8 in. (203 mm) thick reinforced normal weight (145-150 pcf or 2300-2400 kg/m³) concrete. Max area of opening is 288 in.² (0.19 m²) with max dimension of 24 in. (610 mm).
2. **Sheathing** – Nom 1-5/8 by 4 in. (41 by 102 mm) high C4X5.4 structural steel channels with mitered ends formed into four-sided enclosure with welded corners. Inside dimensions of enclosure, between flange tips, to be equal to the inside dimensions of the floor opening. Sheathing channels secured to the top surface of the concrete floor by means of nominal nom 1/4 in. (6 mm) diam by 1-3/4 in. (45 mm) long concrete anchors with nom 1/4 in. (6 mm) by 1-1/4 in. (32 mm) diam steel fender washers.
3. **Cable Rack** – (Not shown) – Max 20 in. (508 mm) wide ladder type cable rack with 2 in. (51 mm) side rails fabricated from min 0.136 in. (3.5 mm) thick galv steel and nom 1 in. (25 mm) wide rungs spaced 9 in. (229 mm) OC. Cable tray shall be welded to top flange of sheathing channel (Item 2).
4. **Cables** – Max 34 percent fill (based on the available area of the opening) of various types of telecommunication or power cables. The cables are to be laced to the cable rack and to each other to form a tight bundle against one side of the opening with min interstices between cables. The following types of cables may be used:
 - A. Max 72 pair No. 26 AWG (or smaller) telecommunication cable with polyvinyl chloride (PVC) insulation and jacket materials.
 - B. Single conductor max 1000 kcmil Type power cable.
 - C. Max 300 pair No. 22 AWG (or smaller) copper conductor telecommunication cables with polyvinyl chloride (PVC) insulation and jacket.
 - D. Max 7/C No. 12 AWG copper conductor power and control cables with XLPE or PVC insulation with XLPE or PVC jacket.
 - E. Max 4/C No. 2/0 AWG copper or aluminum conductor cables with PVC insulation and jacket.
 - F. Max 1-10/125 Fiber Optic (F.O) cable with PVC insulation and jacket.
 - G. Max No. 18 AWG Type RG coaxial cable with polyvinyl chloride insulation.

When Item 4C is used, T, FT and FTH Ratings are 1/2 hr. Otherwise, T, FT and FTH Ratings are 1 hr.

5. **Firestop System** – The firestop system shall consist of the following items
 - A. **Fill, Void or Cavity Material* – Intumescent Sheet** – Rigid aluminum foil faced sheet with galv steel sheet backer. Intumescent sheet cut to size and to extend 2 in. (51 mm) beyond the steel sheathing (Item 2) over the annular space of the opening. Intumescent sheet with galv sheet face up secured to top flange of sheathing channels (Item 2) using nom 1/4 in. (6 mm) diam by 1 in. (25 mm) long steel bolts with nuts and washers spaced max 8 in. (203 mm) OC.
3M COMPANY – Type CS-195+
 - B. **Steel Channels** – Nom 9 in. deep by 0.028 in. (229 by 0.71 mm) thick steel channels with 2 in. (51 mm) flanges formed into a three sided steel sleeve within opening. Top flange of steel channel installed over intumescent sheet (Item 5A) and extended into annular space within opening with edge of bottom flange resting against inside surface of floor opening. Top flange of channels secured to intumescent sheet (Item 5A) with steel sheet metal screws spaced max 8 in. (203 mm) OC.
 - C. **Fill Void or Cavity Material* – Pillows** – Nom 9 in. (229 mm) long by 6 in. (152 mm) wide by 2 and 3 in. (51 and 76 mm) thick plastic covered pillows tightly-packed to fill annular space between the cables and the steel channel enclosure. Pillows installed with 9 in. (229 mm) dimension projecting through the floor and flush with the top surface of the intumescent sheet.
3M COMPANY – Fire Barrier Pillow or Fire Barrier Self-Locking Pillows

System No. F-B-3016 continued

D. **Fill, Void or Cavity Materials* – Graphite Seal, Caulk, Sealant and Putty** – One layer of 1/2 in. (13 mm) wide by 1/16 in. (1.6 mm) thick adhesive-backed graphite intumescent seal or min 1/4 in. (6 mm) diam continuous bead of caulk or putty applied beneath sheathing around entire perimeter of through opening. Prior to installation of the intumescent sheet (and optional steel cover plate, when used), a min 1/2 in. (13 mm) diam bead of caulk, sealant or putty shall be applied over the top surface of the steel sheathing. After installation of the intumescent sheet a “dome” of putty fill material shall be tightly packed around the perimeter of the cable bundle at its egress from the intumescent sheet and pillows. The “dome” of putty shall be min 1 in. (25 mm) thick and extend to a min height of 2 in. (51 mm) above the top of the intumescent sheet and pillows. The interstices between cables are to be filled with putty to the maximum extent possible.

3M COMPANY – Fire Barrier Pillow or Fire Barrier Self-Locking Pillows

E. **Steel Cover Plate** – (Optional, Not Shown) – Min 0.100 in. (2.54 mm) galv steel cover plate cut to fit the contour of the cable fill and to cover the entire top surface of the firestop system. Cover plate secured to sheathing, through intumescent sheet, with the same nom 1/4 in. (6 mm) diam by 1 in. (25 mm) long steel bolts with nuts and washers used to secure the intumescent sheet.

*Bearing the UL Classification Mark

Reprinted from the Online Certifications Directory with permission from Underwriters Laboratories Inc.
Copyright © 2011 Underwriters Laboratories Inc.®



Through Penetrations

Cables

3000 Series

Concrete

FB

System No. F-B-3017

September 20, 2011

ANSI/UL1479 (ASTM E814)

F Rating – 2 Hr

T Rating – 1-1/2 Hr

CAN/ULC S115

F Rating – 2 Hr

FT Rating – 1-1/2 Hr

FH Rating – 2 Hr

FTH Rating – 1-1/2 Hr

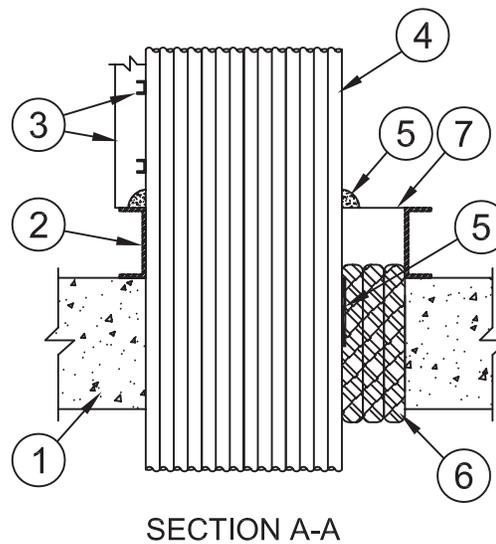
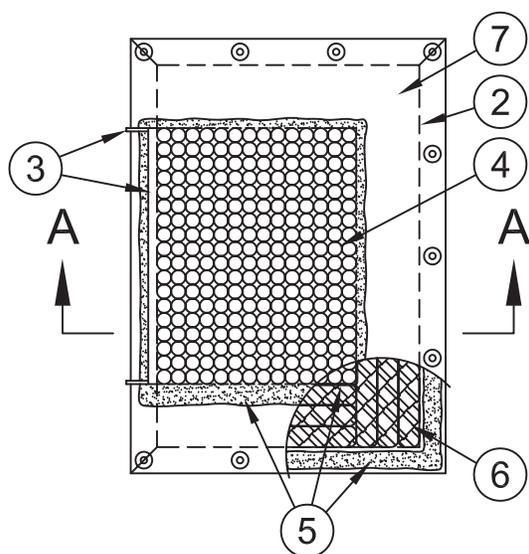

1. **Floor Assembly** – Min 8 in. (203 mm) thick reinforced lightweight or normal weight (100-150 pcf or 1600-2400 kg/m³) concrete. Max area of opening is 432 in.² (0.28 m²) with max dimension of 24 in. (610 mm).
2. **Sheathing** – Nom 1-5/8 by 4 in. (41 by 102 mm) high C4X5.4 structural steel channels with mitered ends formed into four-sided enclosure with welded corners. Inside dimensions of enclosure, between flange tips, to be equal to the inside dimensions of the floor opening. Sheathing channels secured to the top surface of the concrete floor by means of nominal nom 1/4 in. (6 mm) diam by 1-3/4 in. (45 mm) long concrete anchors with nom 1/4 in. (6 mm) by 1-1/4 in. (32 mm) diam steel fender washers. Rope of putty (Item 7) installed as gasket between sheathing and top of floor.
3. **Cable Rack** – Max 18 in. (457 mm) wide ladder type cable rack with 2 in. (51 mm) side rails fabricated from min 0.136 in. (3.5 mm) thick steel and with nom 1 in. (25 mm) wide rungs spaced max 9 in. (229 mm) OC. Width of cable rack to be min 4 in. (102 mm) less than width of opening. Side rails of cable rack to be offset min 2 in. (51 mm) from side edges of opening. Cable rack welded to top flange of sheathing channel (Item 2).
4. **Cables** – Max 62 percent fill of cables calculated based on the inside dimensions of the floor opening and the outside dimensions of the cable bundle. Power cables to be installed in accordance with the National Electrical Code (NFPA No. 70). The cables are to be laced, banded or tied to the cable rack to form a tight bundle against one side of the opening with minimal interstices between cables. The annular space between the cables and the side of the opening with the cable rack shall be 0 in. (point contact). The annular space between the cable bundle and the sides of the opening shall be min 2 in. (51 mm) to max 9 in. (229 mm). Any combination of the following types and sizes of cables may be used:
 - A. Max 300 pair No. 24 AWG (or smaller) copper conductor telecommunication cable with PVC insulation and jacket materials.
 - B. Max 1/C No. 3/0 AWG copper conductor cable with PVC insulation and jacket materials.
 - C. Max three copper conductors (with ground) No. 12 AWG steel Armored Cable+.
 - D. Max three copper conductor (with ground) No. 2 AWG Metal Clad Cable+.
 - E. Max 1/C No. 750 kcmil (or smaller) copper conductor power cable with cross-linked polyethylene (XLPE) insulation and fabric jacket materials.
 - F. Max 3/C (with ground) No. 4/0 AWG (or smaller) copper or aluminum conductor SER cable with XLPE or PVC insulation and jacket.
 - G. Max 4/C No. 18 AWG (or smaller) copper conductor thermostat cable with polyvinyl chloride (PVC) insulation and jacket materials.
 - H. Max four pair No. 22 AWG (or smaller) copper conductor Category 5 or Category 6 data cable with PVC insulation and jacket materials.
 - I. Max 3/C (with ground) No. 10 AWG (or smaller) nonmetallic sheathed (Romex) cable with PVC insulation and jacket materials.
 - J. Max twelve core No. 24 AWG shielded coaxial cable with high density polyethylene foam insulation and fluorinated ethylene (FE) or PVC jacket.
 - K. Max 62.5/125 micron fiber optic cable with having a min Riser rating.
 - L. Max 7/C No. 12 AWG (or smaller) copper conductor control cable with PVC insulation and jacket materials.
5. **Fill, Void or Cavity Material* – Putty** – Min 1/4 in. (6 mm) diam continuous rope of putty applied beneath sheathing (Item 2) around entire perimeter of through opening. Min 1/8 in. (3mm) thick by 4 in. (102mm) wide continuous band of putty installed around the cable bundle such that the top edge of the band is flush with the top surface of the floor. Prior to installation of the steel cover plate all voids between the

System No. F-B-3017 *continued*

pillows and the concrete shall be filled with a min 1/2 in. (13 mm) depth of putty and a min 1/4 in. (6 mm) diam rope of putty shall be applied over the top surface of the steel sheathing. After installation of the steel cover a “dome” of putty fill material shall be tightly packed around the perimeter of the cable bundle at its egress from the steel cover. The “dome” of putty shall be min 1 in. (25 mm) thick and extend to a min height of 1 in. (25 mm) above the top of the steel cover with the interstices between cables filled with putty to the maximum extent possible.

3M COMPANY

3M FIRE PROTECTION PRODUCTS – MP+ Putty

6. **Fill Void or Cavity Material* – Pillows** – Nom 9 in. (229 mm) long by 6 in. (152 mm) wide by 2 and 3 in. (51 and 76 mm) thick plastic covered pillows tightly-packed to fill annular space between the cables and the concrete floor. Pillows installed with 9 in. (229 mm) dimension projecting through the floor and centered in the floor thickness. The pillows may be cut to decrease the width and repaired with min 0.002 in. (0.05mm) thick polyester tape with acrylic adhesive. The tape must overlap onto the existing pillow a min of 1/2 in. (13mm).

3M COMPANY

3M FIRE PROTECTION PRODUCTS – Fire Barrier Pillow or Fire Barrier Self-Locking Pillows

7. **Steel Cover** – Min 20 ga galv steel plate cut to tightly follow contours of cable bundle and secured to structural steel channel sheathing (Item 2) with No. 8 self-tapping screws spaced max 6 in. (152 mm) OC.

+Bearing the UL Listing Mark

*Bearing the UL Classification Mark

Reprinted from the Online Certifications Directory with permission from Underwriters Laboratories Inc.
Copyright © 2011 Underwriters Laboratories Inc.®



Through Penetrations

Cables

3000 Series

Concrete

FB

System No. F-B-3018

April 29, 2010

F Rating – 2 Hr

T Rating – 2 Hr

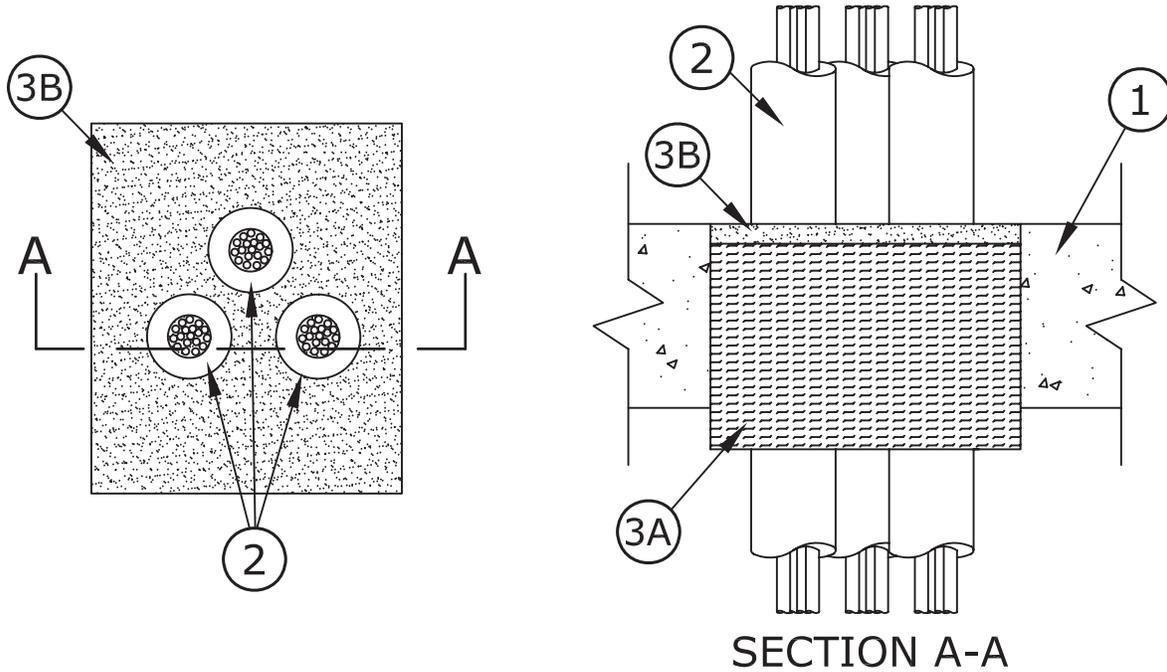

1. **Floor Assembly** – Min 8 in. (203 mm) thick reinforced lightweight normal weight (100-150 pcf or 1600-2400 kg/m³) concrete. Max area of opening is 400 in.² (0.26 m²) with max dimension of 20 in. (508 mm).
2. **Cables** – Max 5 in. (127 mm) diam 161 KV 2000MM² power cables with nom 0.91 in. (23 mm) thick polyethylene jacket. Max three cables per opening. Annular space between cables to be min 5 in. (127 mm) to max 8 in. (203 mm). Annular space between cables and periphery of opening to be min 2 in. (51 mm) to max 10 in. (254 mm).
3. **Firestop System** – The firestop system shall consist of the following items:
 - A. **Forming Material*** – Nom 4 in. (102 mm) wide strips of min 1/2 in (13 mm) thick compressible mat. Mat to be tightly rolled into nom 2 in. (51 mm) to nom 10 in. (254 mm) diam cylindrical shapes, compressed min 50 percent in diam and installed edge-first into the annular space to a min 8 in. (203 mm) depth consisting of two 4 in. (102 mm) deep layers. There shall be no voids between cylindrical shapes and the joints between cylindrical shapes shall be staggered between layers. The bottom layer of forming material may extend max 1 in. (25 mm) below the bottom surface of the floor. Top layer of forming material to be recessed from top surface of floor to accommodate the required thickness of fill material (Item 3B).
 - 3M COMPANY**
3M FIRE PROTECTION PRODUCTS – Fire Barrier Packing Material
 - B. **Fill, Void or Cavity Materials*** – **Caulk** – Min 1 in. (25 mm) thickness of caulk applied within the annulus, flush with top surface of floor.
 - 3M COMPANY**
3M FIRE PROTECTION PRODUCTS – CP 25WB+

*Bearing the UL Classification Marking

Reprinted from the Online Certifications Directory with permission from Underwriters Laboratories Inc.
Copyright © 2010 Underwriters Laboratories Inc.®



System No. W-J-3081

May 19, 2005
F Rating – 2 Hr
T Rating – 1/2 Hr

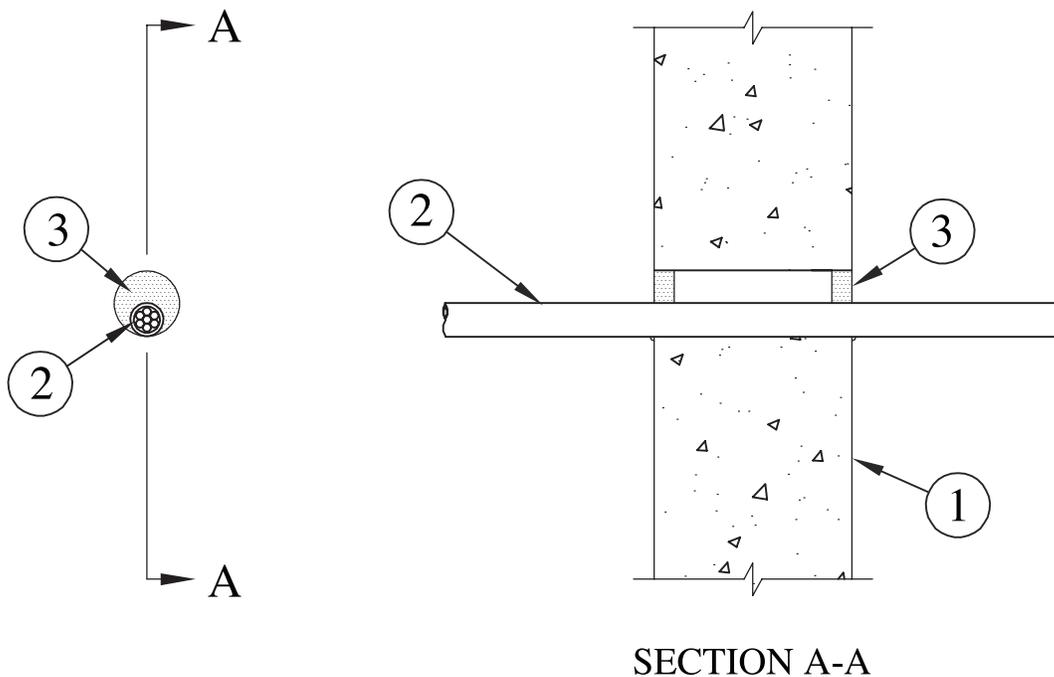

- Wall Assembly** – Min 6 in. (152 mm) thick reinforced lightweight or normal weight (100-150 pcf or 1600-2400 kg/m³) concrete wall. Wall may also be constructed of any UL Classified **Concrete Blocks***. Max diam of opening is 8 in. (203 mm).
See **Concrete Blocks (CAZT)** category in the Fire Resistance Directory for names of manufacturers.
- Cable** – One cable installed eccentrically or concentrically within opening. Annular space between cable and periphery of opening to be min 0 in. (0 mm) (point contact) to max 1 in. (0 mm to 25 mm). Cable to be rigidly supported on both sides of the wall. The following types and sizes of cable may be used:
 - Max 200 pair No. 22 AWG (or smaller) copper conductor with polyvinyl chloride (PVC) insulation and jacketing material.
 - Max 1/C No. 350 kcmil (or smaller) copper conductor cable with cross-linked polyethylene (XLPE) or PVC jacket.
 - Max 7/C No. 12 AWG (or smaller) copper conductor power and control cables with XLPE or PVC insulation with XLPE or PVC jacket.
 - Max 3/C No. 2/0 AWG (or smaller) copper or aluminum conductor SER cables with XLPE or PVC insulation and jacket.
 - Max 4/C No. 2/0 AWG (or smaller) copper conductor, aluminum clad or steel clad TECK 90 cable with or without PVC jacketed.
 - Max 110/125 fiber optic (F.O.) cable with PVC insulation and jacket.
 - Max 3/C with ground No. 8 AWG (or smaller) copper conductor NM cable with PVC insulation and jacket.
 - Max RG/U coaxial cable with fluorinated ethylene insulation and jacket.
 - Max 4 pair No. 24 AWG (or smaller) copper conductor data cable with Hylar jacket and insulation.
 - Through Penetrating Product*** – Any cables, **Armored Cable+** or **Metal Clad Cable+** currently Classified under the Through Penetrating Product category.
See **Through Penetrating Product (XHLY)** category in the Fire Resistance Directory for names of manufacturers
- Fill, Void or Cavity Material*** – **Caulk or Sealant** – Min 5/8 in. (16 mm) thickness of caulk applied within annulus, flush with both surfaces of wall. Min 1/4 in. (6 mm) diam bead of caulk applied to cable/wall interface at point contact location on both sides of wall.
3M COMPANY – IC 15WB+, CP 25WB+ caulk or FB-3000 WT sealant

*Bearing the UL Classification Marking

Reprinted from the Online Certifications Directory with permission from Underwriters Laboratories Inc.
Copyright © 2010 Underwriters Laboratories Inc.®



Through Penetrations

Cables

3000 Series

Concrete

WJ

System No. W-J-3082

May 19, 2005
 F Rating – 2 Hr
 T Rating – 1/2 Hr

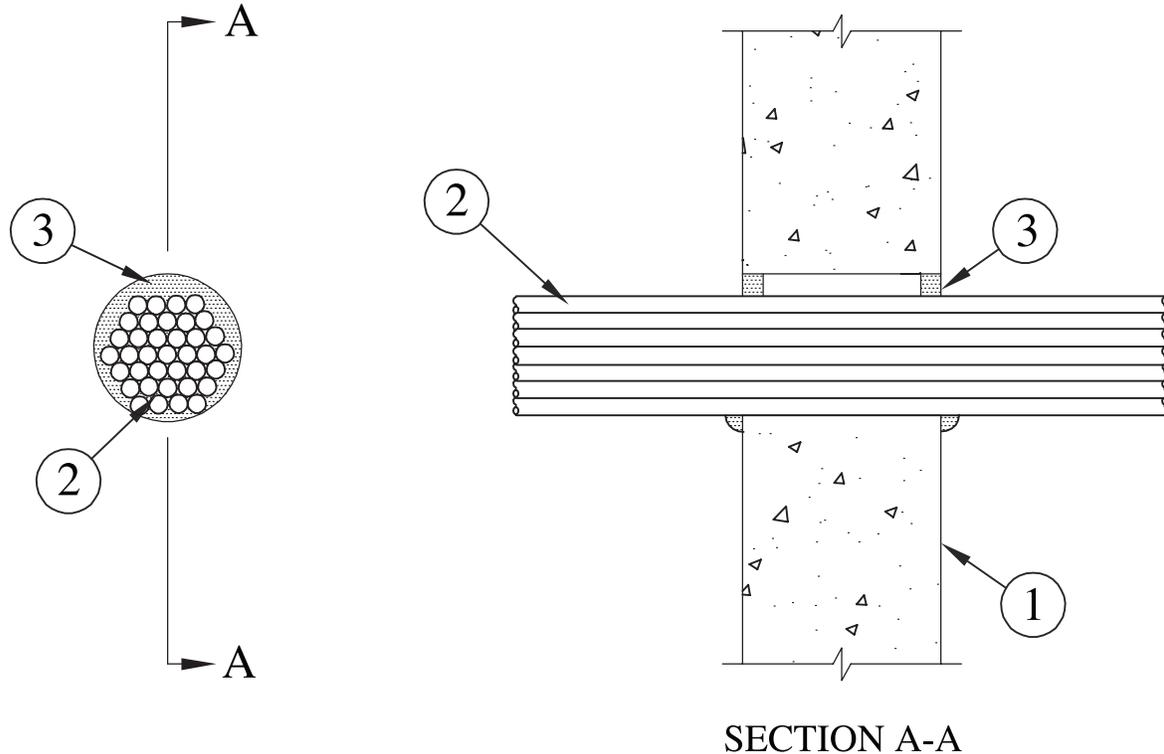

1. **Wall Assembly** – Min 6 in. (152 mm) thick reinforced lightweight or normal weight (100-150 pcf or 1600-2400 kg/m³) concrete wall. Wall may also be constructed of any UL Classified **Concrete Blocks***. Max diam of opening is 5 in. (127 mm)
 See **Concrete Blocks (CAZT)** category in the Fire Resistance Directory for names of manufacturers.
2. **Cables** – Max 4 in. (102 mm) diam cable bundle installed eccentrically or concentrically within opening. Annular space between cable bundle and periphery of opening to be min 0 in. (point contact) to max 1 in. (0 mm to max 25 mm). Cable bundle to be rigidly supported on both sides of wall. The following types and sizes of cables may be used:
 - A. Max 200 pair No. 22 AWG (or smaller) copper conductor with polyvinyl chloride (PVC) insulation and jacketing material.
 - B. Max 1/C No. 350 kcmil (or smaller) copper conductor cable with cross-linked polyethylene (XLPE) or PVC jacket.
 - C. Max 7/C No. 12 AWG (or smaller) copper conductor power and control cables with XLPE or PVC insulation with XLPE or PVC jacket.
 - D. Max 3/C No. 2/0 AWG (or smaller) copper or aluminum conductor SER cables with XLPE or PVC insulation and jacket.
 - E. Max 4/C No. 2/0 AWG (or smaller) copper conductor, aluminum clad or steel clad TECK 90 cable with or without PVC jacketed.
 - F. Max 110/125 fiber optic (F.O.) cable with PVC insulation and jacket.
 - G. Max 3/C with ground No. 8 AWG (or smaller) copper conductor NM cable with PVC insulation and jacket.
 - H. Max RG/U coaxial cable with fluorinated ethylene insulation and jacket.
 - I. Max 4 pair No. 24 AWG (or smaller) copper conductor data cable with Hylar jacket and insulation.
 - J. **Through Penetrating Product*** – Any cables, **Armored Cable+** or **Metal Clad Cable+** currently Classified under the Through Penetrating Product category.
 See **Through Penetrating Product (XHLY)** category in the Fire Resistance Directory for names of manufacturers
3. **Fill, Void or Cavity Material*** – **Caulk or Sealant** – Min 5/8 in. (16 mm) thickness of caulk applied within annulus, flush with both surfaces of wall. Min 1/4 in. (6 mm) diam bead of caulk applied to cable bundle/wall interface at point contact location on both sides of wall.
3M COMPANY – IC 15WB+, CP 25WB+ caulk or FB-3000 WT sealant

*Bearing the UL Classification Marking

Reprinted from the Online Certifications Directory with permission from Underwriters Laboratories Inc.
 Copyright © 2010 Underwriters Laboratories Inc.®



System No. W-J-3169

September 20, 2011

ANSI/UL1479 (ASTM E814)

F Rating – 2 Hr

T Rating – 0 Hr

CAN/ULC S115

F Rating – 2 Hr

FT Rating – 0 Hr

FH Rating – 2 Hr

FTH Rating – 0 Hr

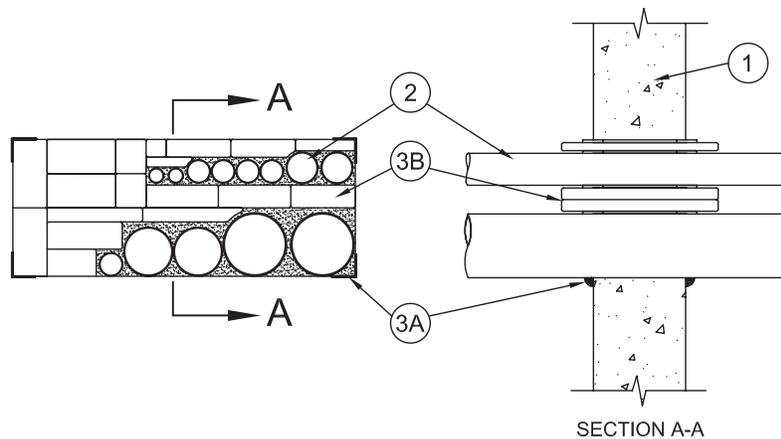

1. **Wall Assembly** – Min 4-1/2 in. (114 mm) thick reinforced lightweight or normal weight (100-150 pcf or 1600-2400 kg/m³) concrete. Wall may also be constructed of any UL Classified **Concrete Blocks***. Max area of opening is 225 sq in. (1452 sq cm) with a max dimension of 22-1/2 in. (572 mm).

See **Concrete Blocks** (CAZT) category in the Fire Resistance Directory for names of manufacturers.

2. **Cable** – Aggregate cross-sectional area of cables in opening to be max 49 percent of the cross-sectional area inside the opening installed either concentrically or eccentrically within the firestop system. The annular space between cable and periphery of opening shall be min 0 in. (0 mm) (point contact) to max 4 in. (102 mm). The horizontal space between cable shall be min 1/4 in. (6 mm) to max 4 in. (102 mm). The vertical space between cable shall be min 1-1/2 in. (38 mm) to max 4 in. (102 mm). Cable to be rigidly supported on both sides of wall assembly. Any combination of the following types and sizes of cable may be used:
 - A. Max 200 pair No. 22 AWG (or smaller) copper conductor with polyvinyl chloride (PVC) insulation and jacketing material.
 - B. Max 1/C No. 750 kcmil (or smaller) copper conductor cable with cross-linked polyethylene (XLPE) jacket.
 - C. Max 7/C No. 12 AWG (or smaller) copper conductor power and control cables with XLPE or PVC insulation with XLPE or PVC jacket.
 - D. Max 3/C No. 4/0 AWG (or smaller) copper or aluminum conductor SER cables with PVC or XLPE insulation and jacket.
 - E. Max 3/C No. 2/0 AWG (or smaller) copper conductor PVC jacketed aluminum clad or steel clad TECK 90 cable.
 - F. Max 110/125 fiber optic (F.O.) cable with PVC insulation and jacket.
 - G. Max 3/C with ground No. 8 AWG (or smaller) copper conductor NM cable with PVC insulation and jacket.
 - H. RG/U coaxial cable with fluorinated ethylene (FE) or PVC insulation and jacket.
 - I. Max 4 pair No. 24 AWG (or smaller) copper conductor data cable with Hylar jacket and insulation.
 - J. Max three conductor No. 12 AWG (or smaller) MC (BX) copper cable with polyvinyl chloride insulation and jacket materials.
 - K. **Through Penetrating Product*** – Any cables, **Armored Cable+** or **Metal Clad Cable+** currently Classified under the Through Penetrating Product category.

See **Through Penetrating Product** (XHLY) category in the Fire Resistance Directory for names of manufacturers.

3. **Firestop System** – The firestop system shall consist of the following:
 - A. **Fill Void or Cavity Material* – Caulk, Sealant or Putty** – Min 1/2 in. (13 mm) thickness of caulk or putty formed to a min 1 in. (25 mm) width and applied within annulus at all corners of opening and extending a min 1 in. (25 mm) in both directions from each corner, flush with both surfaces of wall. Min 1/4 in. (6 mm) thickness, min 2 in. (51 mm) width of caulk or putty wrapped applied around each penetrant such that caulk or putty extends approximately 1/2 in. (51 mm) beyond both surfaces of wall. After installation of pillows (Item 4B) all voids within the opening shall be filled with a min 1 in. (25 mm) thickness of caulk or putty.

3M COMPANY

3M FIRE PROTECTION PRODUCTS – MPS-2+ or CP 25 WB+ or FB-3000 WT

- B. **Fill Void or Cavity Material* – Pillows** – Max 9 in. (229 mm) long by 6 in. (152 mm) wide by 2 and 3 in. (51 and 76 mm) thick plastic covered pillows tightly-packed to fill annular space between penetrants and periphery of opening and installed with 9 in. (229 mm) dimension projecting through wall and centered within the opening.

3M COMPANY

3M FIRE PROTECTION PRODUCTS – Fire Barrier Pillow or Fire Barrier Self-Locking Pillows

*Bearing the UL Classification Mark

Reprinted from the Online Certifications Directory with permission from Underwriters Laboratories Inc.

Copyright © 2011 Underwriters Laboratories Inc.®



System No. W-J-3170

October 01, 2008

F Rating – 2 Hr

T Rating – 0 Hr

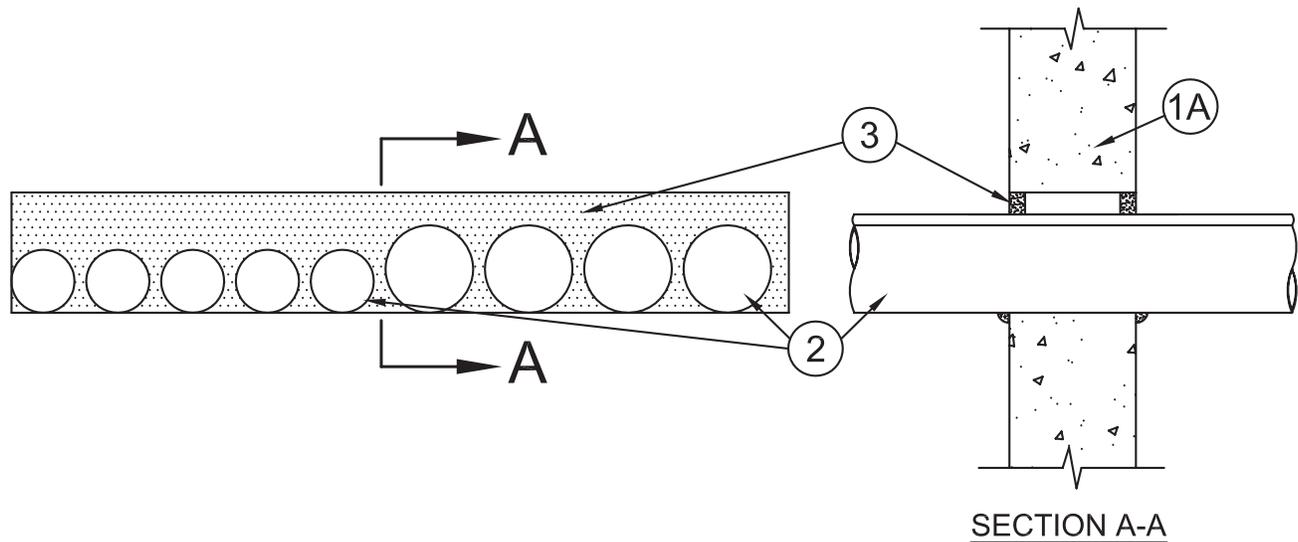

- Wall Assembly** – Min 4-1/2 in. (114 mm) thick reinforced lightweight or normal weight (100-150 pcf or 1600-2400 kg/m³) concrete. Wall may also be constructed of any UL Classified **Concrete Blocks***. Max area of opening is 67-1/2 sq. in. (435 sq cm) with max dimension of 22-1/2 in. (572 mm).

See **Concrete Blocks** (CAZT) category in the Fire Resistance Directory for names of manufacturers.

- Cable** – Aggregate cross-sectional area of cables in opening to be max 49 percent of the cross-sectional area inside the opening installed either concentrically or eccentrically within the firestop system. The annular space between cable and periphery of opening shall be min 0 in. (0 mm, point contact) to max 1-1/4 in. (32 mm). The horizontal space between cable shall be min 1/4 in. (6 mm) to max 1 in. (25 mm). Cable to be rigidly supported on both sides of wall assembly. Any combination of the following types and sizes of cable may be used:
 - Max 200 pair No. 22 AWG (or smaller) copper conductor with polyvinyl chloride (PVC) insulation and jacketing material.
 - Max 1/C No. 750 kcmil (or smaller) copper conductor cable with cross-linked polyethylene (XLPE) jacket.
 - Max 7/C No. 12 AWG (or smaller) copper conductor power and control cables with XLPE or PVC insulation with XLPE or PVC jacket.
 - Max 3/C No. 4/0 AWG (or smaller) copper or aluminum conductor SER cables with XLPE or PVC insulation and jacket.
 - Max 3/C No. 2/0 AWG (or smaller) copper conductor PVC jacketed aluminum clad or steel clad TECK 90 cable.
 - Max 110/125 fiber optic (F.O.) cable with PVC insulation and jacket.
 - Max 3/C with ground No. 8 AWG (or smaller) copper conductor NM cable with PVC insulation and jacket.
 - RG/U coaxial cable with fluorinated ethylene (FE) or PVC insulation and jacket.
 - Max 4 pair No. 24 AWG (or smaller) copper conductor data cable with Hylar jacket and insulation.
 - Max three conductor No. 12 AWG (or smaller) MC (BX) copper cable with polyvinyl chloride insulation and jacket materials.
 - Through Penetrating Product*** – Any cables, **Armored Cable+** or **Metal Clad Cable+** currently Classified under the Through Penetrating Product category.
See **Through Penetrating Product** (XHLY) category in the Fire Resistance Directory for names of manufacturers.
- Fill, Void or Cavity Material* – Caulk or Sealant** – Min 5/8 in. (16 mm) thickness of fill material applied within the annulus, flush with both surfaces of wall. Min 1/2 in. (13 mm) diam bead of caulk applied to the penetrant/gypsum board interface at the point contact location on both sides of wall.

3M COMPANY

3M FIRE PROTECTION PRODUCTS – CP 25WB+, FireDam 150+, IC 15WB+ caulk or FB-3000 WT sealant

*Bearing the UL Classification Mark

Reprinted from the Online Certifications Directory with permission from Underwriters Laboratories Inc.
Copyright © 2010 Underwriters Laboratories Inc.®



System No. W-J-3171

October 01, 2008

F Rating – 2 Hr

T Rating – 0 Hr

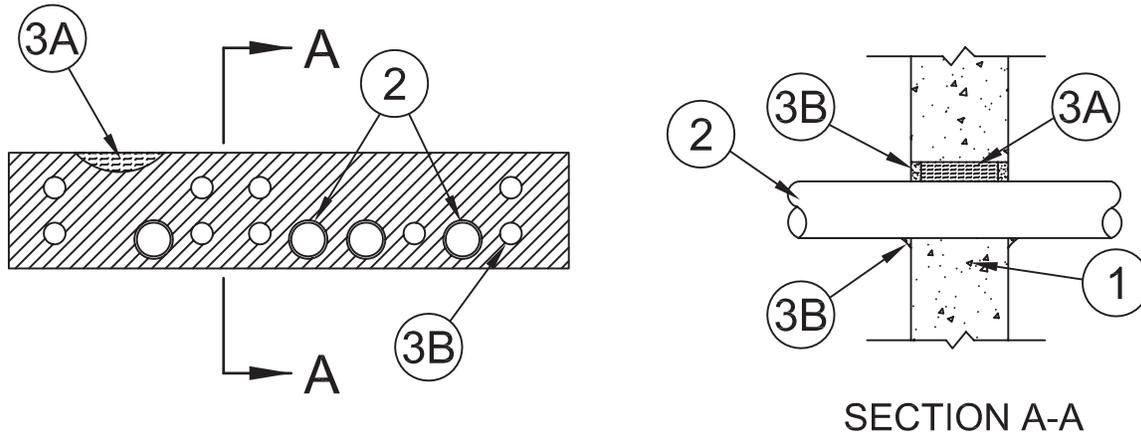

1. **Wall Assembly** – Min 4-1/2 in. (114 mm) thick reinforced lightweight or normal weight (100-150 pcf or 1600-2400 kg/m³) concrete. Wall may also be constructed of any UL Classified **Concrete Blocks***. Max area of opening to be 182 in.² (1174 cm²) with a max dimension of 45-1/2 in. (1156 mm).

See **Concrete Blocks** (CAZT) category in the Fire Resistance Directory for names of manufacturers.

2. **Cable** – Aggregate cross-sectional area of cables in opening to be max 49 percent of the cross-sectional area inside the opening installed either concentrically or eccentrically within the firestop system. The annular space between cable and periphery of opening shall be min 0 in. (0 mm) (point contact) to max 2 in. (51 mm). The horizontal space between cable shall be min 1/4 in. (6 mm) to max 2 in. (51 mm). Cable to be rigidly supported on both sides of wall assembly. Any combination of the following types and sizes of cable may be used:
 - A. Max 200 pair No. 22 AWG (or smaller) copper conductor with polyvinyl chloride (PVC) insulation and jacketing material.
 - B. Max 1/C No. 750 kcmil (or smaller) copper conductor cable with cross-linked polyethylene (XLPE) jacket.
 - C. Max 7/C No. 12 AWG (or smaller) copper conductor power and control cables with XLPE or PVC insulation with XLPE or PVC jacket.
 - D. Max 3/C No. 4/0 AWG (or smaller) copper or aluminum conductor SER cables with PVC or XLPE insulation and jacket.
 - E. Max 3/C No. 2/0 AWG (or smaller) copper conductor PVC jacketed aluminum clad or steel clad TECK 90 cable.
 - F. Max 110/125 fiber optic (F.O.) cable with PVC insulation and jacket.
 - G. Max 3/C with ground No. 8 AWG (or smaller) copper conductor NM cable with PVC insulation and jacket.
 - H. RG/U coaxial cable with fluorinated ethylene (FE) or PVC insulation and jacket.
 - I. Max 4 pair No. 24 AWG (or smaller) copper conductor data cable with Hylar jacket and insulation.
 - J. Max three conductor No. 12 AWG (or smaller) MC (BX) copper cable with polyvinyl chloride insulation and jacket materials.
 - K. **Through Penetrating Product*** – Any cables, **Armored Cable**+ or **Metal Clad Cable**+ currently Classified under the Through Penetrating Product category.

See **Through Penetrating Product** (XHLY) category in the Fire Resistance Directory for names of manufacturers.

3. **Firestop System** – The firestop system shall consist of the following:
 - A. **Packing Material** – Min 3-3/4 in. (95 mm) or 5 in. (127 mm) thickness of min 4 pcf (64 kg/m³) mineral wool batt insulation firmly packed into opening for 1 and 2 hr rated assemblies, respectively. Packing material to be recessed from both sides of wall assembly to accommodate the required thickness of fill material.
 - B. **Fill, Void or Cavity Material*** – **Caulk or Sealant** – Min 1/2 in. (13 mm) thickness of caulk applied within annulus, flush with both surfaces of wall. Min 1/4 in. (6 mm) diam bead of caulk applied to gypsum board/penetrant interface at point contact location on both sides of wall.

3M COMPANY

3M FIRE PROTECTION PRODUCTS – IC 15WB+, CP 25WB+ caulk or FB-3000 WT sealant

*Bearing the UL Classification Mark

Reprinted from the Online Certifications Directory with permission from Underwriters Laboratories Inc.
Copyright © 2010 Underwriters Laboratories Inc.®



System No. W-J-3177

January 28, 2014

ANSI/UL1479 (ASTM E814)

F Ratings – 1 and 2 Hr (See Item 1)

T Rating – 0 Hr

CAN/ULC S115

F Ratings – 1 and 2 Hr (See Item 1)

FT Rating – 0 Hr

FH Ratings – 1 and 2 Hr (See Item 1)

FTH Rating – 0 Hr

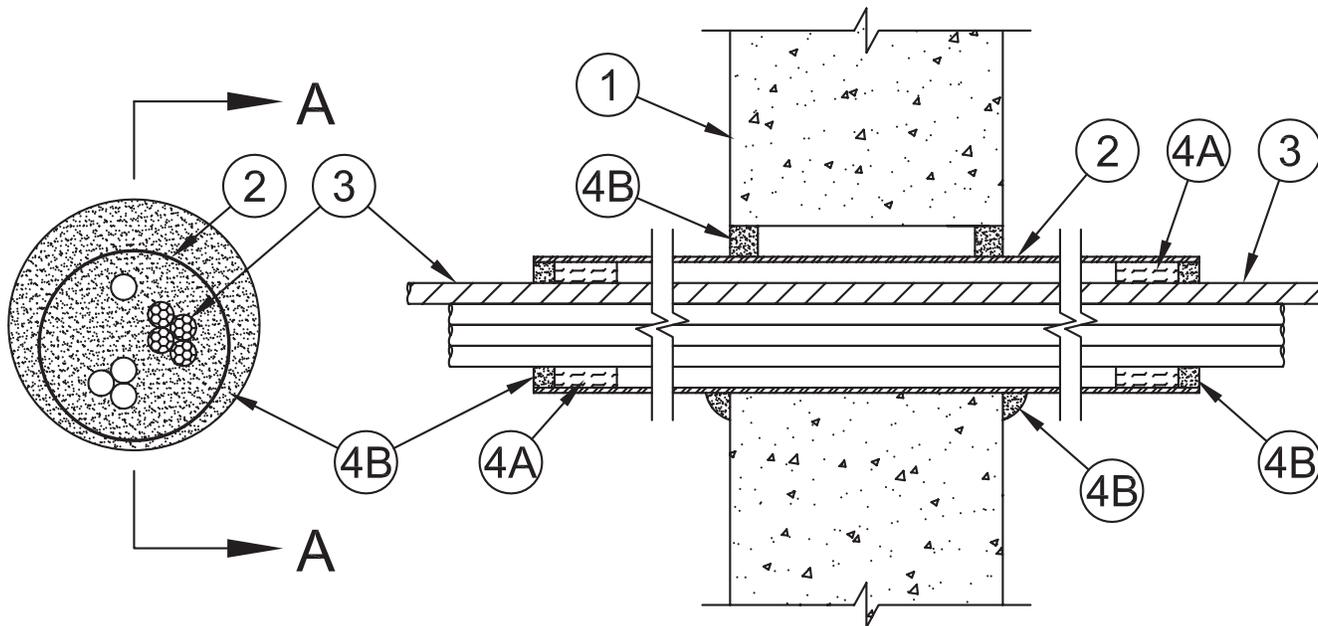

SECTION A-A

- Wall Assembly** – Min 4-1/2 in. (114 mm) thick reinforced lightweight or normal weight (100-150 pcf) concrete. Wall may also be constructed of any UL Classified **Concrete Blocks***. Max diameter of the opening is 6-1/2 in. (165 mm).
See **Concrete Blocks** (CAZT) category in the Fire Resistance Directory for names of manufacturers.
The hourly F Rating of the firestop system is equal to the hourly fire rating of the wall assembly in which it is installed.
- Steel Sleeve** – Nom 6 in. (152 mm) diam (or smaller) steel electrical metallic tubing (EMT) or Schedule 5 steel pipe. The annular space between the steel sleeve and the periphery of opening shall be min 0 in. (point contact) to max 1/2 in. (13mm) Sleeve may extend up to 18 in. (457 mm) beyond each surface of the wall.
- Cables** – Aggregate cross-sectional area of cables in steel sleeve to be 50 percent of the aggregate cross-sectional area of the sleeve. Cables to be rigidly supported on both sides of wall assembly. The annular space between cables and periphery of sleeve shall be min 0 in. (point contact) to max 1/2 in. (13mm) The annular space between cables shall be min 0 in. (point contact) to max 1 in. (25mm). Any combination of the following types and sizes of cables may be used:
 - Max 300 pair No. 24 AWG (or smaller) copper conductor with polyvinyl chloride (PVC) insulation and jacket.
 - Max 1-10/125 Fiber Optic (F.O.) cable, PVC insulation and jacket.
 - Max 3/C No. 2/0 AWG (or smaller) aluminum or copper conductor cable with XLPE insulation and PVC jacket.
 - Max 7/C No. 12 AWG (or smaller) copper conductor cable with PVC insulation and jacket.
 - Max No. 18 AWG RG 6/U coaxial cable with PVC insulation and jacket.
 - Max 4 Pair No 22 AWG (or smaller) Cat 6 copper conductor with PVC insulation and jacket.
 - Max 3/C No. 2/0 aluminum or copper SE cable with PVC insulation and jacket.
 - Max four aluminum conductor No. 10 AWG (or smaller) aluminum or steel, Armored cable# or Metal-Clad Cable+.**AFC CABLE SYSTEMS INC – MC Lite**
- Firestop System** – The firestop system shall consist of the following:
 - Packing Material** – Min 2 in. (51 mm) thickness of min 4.0 pcf (64 kg/m³) mineral wool batt insulation firmly packed into each end of sleeve as a permanent form. Packing material to be recessed from each end of sleeve to accommodate the required thickness of fill material.
 - Fill, Void or Cavity Material* – Sealant or Putty** – Min 5/8 in. (16 mm) thickness of fill material applied within the annulus, flush with both sides of wall. At point contact, a min 1/2 in. (13mm) bead of fill material shall be applied at sleeve/wall interface on both sides of wall when sleeve extends beyond surface of wall. Min 1/2 in. (13 mm) thickness of fill material applied within the sleeve, flush with both ends. Min 1/2 in. (13 mm) thickness of fill material applied within the interstices of the cable bundles.

System No. W-J-3177 continued

3M COMPANY

3M FIRE PROTECTION PRODUCTS – IC 15WB+, CP 25WB+ or FB-3000 WT

- C. **Fill, Void or Cavity Material*** – (Not Shown) – As an alternate to Item 4B above, min 5/8 in. (16 mm) thickness of fill material applied within the annulus, flush with both sides of the wall. At point contact, a min. 1/2 in. (13 mm) bead of fill material at sleeve/wall interface on both sides of wall when sleeve extends beyond surface of the wall. Min. 2-1/2 in. (63 mm) thickness of fill material applied within the sleeve, flush with both ends. Foam to be injected into the interstices between all cables. When this fill material is used, item 4A is not required.

3M COMPANY – Fire Barrier rated Foam, FIP 1 - Step

*Bearing the UL Classification Mark

+Bearing the UL Listing Mark

Reprinted from the Online Certifications Directory with permission from UL
© 2014 UL LLC



Through Penetrations

Cables

3000 Series

Concrete

CAJ

System No. W-J-3185

April 29, 2010

F Rating – 2 Hr

T Rating – 2 Hr

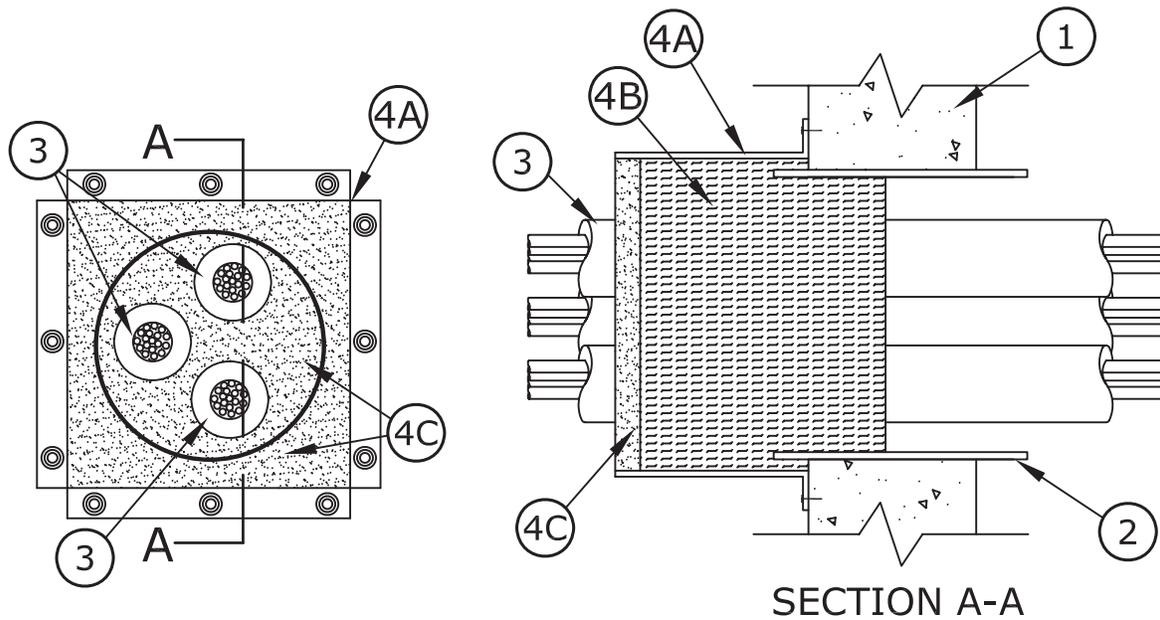

1. **Wall Assembly** – Min 8 in. (203 mm) thick reinforced lightweight or normal weight (100-150 pcf or 1600-2400 kg/m³) concrete wall. Wall may also be constructed of any UL Classified **Concrete Blocks***. Max diam of wall opening shall be 14 in. (356 mm).
See **Concrete Blocks (CAZT)** category in the Fire Resistance Directory for names of manufacturers.
 2. **Polyvinyl Chloride (PVC) Sleeve** – Nom 14 in. 356 mm) diam (or smaller) Schedule 80 PVC sleeve cast or grouted into wall assembly. The sleeve shall be sized to extend 1 in. (25 mm) beyond each wall surface.
 3. **Cables** – Max 5 in. (127 mm) diam 161 KV 2000MM² power cables with nom 0.91 in. (23 mm) thick polyethylene jacket. Max three cables per opening. Annular space between cables to be min 1 in. (25 mm) to max 5 in. (127 mm). Annular space between cables and PVC sleeve to be min 1 in. (25 mm) to max 5 in. (127 mm).
 4. **Firestop System** – The firestop system shall consist of the following items:
 - A. **Metal Enclosure** – Nom 17 by 17 in. (432 by 432 mm) by 10 in. (254 mm) deep, min 0.045 in. (1.14 mm) thick galvanized steel enclosure provided with a 2 in. (51 mm) wide flange on all sides for attachment to the wall. Enclosure to be attached to one side of wall with min 3/8 in. (10 mm) diam by min 1-1/4 in. (32 mm) long steel masonry anchors in conjunction with min 1-1/4 in. (32 mm) diam steel washers spaced a max 1 in. (25 mm) from each end and at the center of each flange.
 - B. **Forming Material*** – Nom 4 in. (102 mm) wide strips of min 1/2 in (13 mm) thick compressible mat. Mat to be tightly rolled or folded into various shapes, compressed min 50 percent in thickness and installed edge-first into the annular space to a min 10.7 in. (272 mm) depth. There shall be no voids between shapes and the joints between shapes shall be staggered between layers. The layers of forming material shall be installed such that the depth of the forming material is recessed 1 in. (25 mm) from the outer surface of the metal enclosure and extends into the PVC sleeve a min of 1.7 in. (43 mm).
- 3M COMPANY**
3M FIRE PROTECTION PRODUCTS – Fire Barrier Packing Material
- C. **Fill, Void or Cavity Materials*** – **Caulk** – Min 1 in. (25 mm) thickness of caulk applied within the annulus, flush with outer surface of the metal enclosure.
- 3M COMPANY**
3M FIRE PROTECTION PRODUCTS – CP 25WB+

*Bearing the UL Classification Mark

Reprinted from the Online Certifications Directory with permission from Underwriters Laboratories Inc.
Copyright © 2010 Underwriters Laboratories Inc.®



Cables • Gypsum

| 3M UL Systems | "F" Rating | 3M Product | Through Penetrant Details |
|---------------|------------|--|---|
| W-L-3001 | 1, 2 | 3M™ Fire Barrier Sealant CP 25WB+ 3M™ Fire Barrier Moldable Putty Stix MP+ 3M™ Fire Barrier Moldable Putty Pads MPP+ | 150 pair 24 AWG, 10 AWG Romex, fiber optical, 7/C 12 AWG. Also referred as WL3001. |
| W-L-3009 | 2 | 3M™ Fire Barrier Silicone Sealant 2000+ 3M™ Fire Barrier Water Tight Sealant 1000 NS | U300/U400 Series gypsum wall. Max 5: 7/C 12 AWG cables. Max diam of opening 6 in. Min 1/2 in. annular space. 2 hour F rating. 1/2 hour T rating. Also known as WL3009. |
| W-L-3015 | 1, 2 | 3M™ Fire Barrier Sealant CP 25WB+ | 2 AWG steel or aluminum armored or metal clad cable. Also referred as WL3015. |
| W-L-3030 | 1, 2 | 3M™ Fire Barrier Sealant CP 25WB+ 3M™ Fire Barrier Sealant IC 15WB+ 3M™ Fire Barrier Sealant FD 150+ 3M™ Fire Barrier Wrap Strips FS-195+ 3M™ Fire Barrier Moldable Putty Stix MP+ | 350 kcmil, 2/0 AWG, 150 pair 24 AWG. Also referred as WL3030. |
| W-L-3031 | 1, 2 | 3M™ Fire Barrier Moldable Putty Stix MP+ 3M™ Fire Barrier Moldable Putty Pads MPP+ | 150 pair 24 AWG, 12 AWG, fiber optic cables: 28 gauge steel sleeve. Also referred as WL3031. |
| W-L-3032 | 1, 2 | 3M™ Fire Barrier Sealant CP 25WB+ | 350 kcmil, 12 AWG power, 150 pair 24 AWG: 28 gauge steel sleeve. Also referred as WL3032. |
| W-L-3041 | 2 | 3M™ Fire Barrier Silicone Sealant 2000+ 3M™ Fire Barrier Water Tight Sealant 1000 NS | U300 or U400 Series Wall. Max 4/C max 1000 kcmil aluminum metal clad cable. Diam of opening min 1-1/2 in. to max 2-1/2 in. larger than penetrant OD. Min 1-1/2 in. to max 2-1/2 in. annular. 2 hour F rating. Also known as WL3041. |
| W-L-3062 | 1, 2 | 3M™ Fire Barrier Sealant CP 25WB+ | 2/0 AWG steel or aluminum armored or metal clad cable: 28 gauge steel sleeve. Also referred as WL3062. |
| W-L-3068 | 2 | 3M™ Fire Barrier Sealant CP 25WB+ 3M™ Fire Barrier Moldable Putty Stix MP+ | 350 kcmil, 150 pair, 12 AWG, fabricated steel sleeve. Also referred as WL3068. |
| W-L-3074 | 1, 2 | 3M™ Fire Barrier Sealant CP 25WB+ | 2 AWG aluminum metal clad cable. Also referred as WL3074. |
| W-L-3075 | 1, 2 | 3M™ Fire Barrier Sealant CP 25WB+ | 2/0 AWG aluminum metal clad cable. Also referred as WL3075. |
| W-L-3077 | 1, 2 | 3M™ Fire Barrier Sealant CP 25WB+ | 2 AWG aluminum metal clad cable. Also referred as WL3077. |
| W-L-3078 | 1, 2 | 3M™ Fire Barrier Sealant CP 25WB+ | 2/0 AWG aluminum or steel armored cable or metal clad cable, steel sleeve. Also referred as WL3078. |
| W-L-3080 | 2 | 3M™ Fire Barrier Sealant CP 25WB+ 3M™ Fire Barrier Composite Sheet CS-195+ 3M™ Fire Barrier Moldable Putty Stix MP+ 3M™ Fire Barrier Moldable Putty Pads MPP+ | 600 kcmil, 900 pair, 7/C 12 AWG, 3/C 2 AWG, 18 AWG G/U coaxial. Also referred as WL3080. |
| W-L-3081 | 1 | 3M™ Fire Barrier Sealant CP 25WB+ 3M™ Fire Barrier Moldable Putty Stix MP+ | 350 kcmil, 150 pair, 12 AWG, fabricated steel sleeve. Also referred as WL3081. |
| W-L-3082 | 2 | 3M™ Fire Barrier Sealant CP 25WB+ 3M™ Fire Barrier Moldable Putty Stix MP+ | 350 kcmil, 150 pair, 12 AWG, fabricated steel sleeve. Also referred as WL3082. |
| W-L-3110 | 1, 2 | 3M™ Fire Barrier Sealant CP 25WB+ | 4" cable bundle power copper cables, aluminum cables, TEK, metal clad steel or aluminum coaxial cable. Also referred as WL3110. |
| W-L-3123 | 1, 2 | 3M™ Fire Barrier Sealant CP 25WB+ | 5 AWG aluminum on steel metal clad cable. Also referred as WL3123. |
| W-L-3129 | 1, 2 | 3M™ Fire Barrier Water Tight Sealant 1000 NS | Telecomm, power, aluminum clad cable. Also referred as WL3129. |
| W-L-3130 | 1, 2 | 3M™ Fire Barrier Water Tight Sealant 1000 NS | Maximum 4" copper conductor no. 2/0 AWG, aluminum or metal clad cable. Also referred as WL3130. |
| W-L-3148 | 1, 2 | 3M™ Fire Barrier Sealant CP 25WB+ 3M™ Fire Barrier Sealant IC 15WB+ 3M™ Fire Barrier Sealant FD 150+ | 4" cable bundle power copper cables, aluminum cables, coaxial cable. Also referred as WL3148. |
| W-L-3149 | 1, 2 | 3M™ Fire Barrier Sealant CP 25WB+ 3M™ Fire Barrier Sealant IC 15WB+ 3M™ Fire Barrier Sealant FD 150+ | 150 pair, fiber optic, aluminum/copper conductor, aluminum or steel TEK cable. Also referred as WL3149. |
| W-L-3194 | 1, 2 | 3M™ Fire Barrier Sealant CP 25WB+ 3M™ Fire Barrier Sealant IC 15WB+ | 200 pair, 350 kcmil, 7/C 12, 3/C 2/0, 4/C 2/0, 110/125 fiber optic, 3/C with ground, RG/U coaxial cable, 4 pair, armored cable or metal clad cable. Also referred as WL3194. |
| W-L-3195 | 1, 2 | 3M™ Fire Barrier Sealant CP 25WB+ 3M™ Fire Barrier Sealant IC 15WB+ | Multiple 4" diameter bundle, 200 pair, 350 kcmil, 7/C 12, 3/C 2/0, 4/C 2/0, 110/125 fiber optic, 3/C with ground, RG/U coaxial cable, 4 pair, armored cable or metal clad cable. Also referred as WL3195. |

Cables • Gypsum

| 3M UL Systems | "F" Rating | 3M Product | Through Penetrant Details |
|-----------------|------------|--|--|
| W-L-3289 | 1, 2, 3, 4 | 3M™ Fire Barrier Pass-Through Products 3M™ Fire Barrier Water Tight Sealant 3000 WT 3M™ Fire Barrier Sealant CP 25WB+ 3M™ Fire Barrier Sealant IC 15WB+ 3M™ Fire Barrier Moldable Putty Stix MP+ | See system for cable types/sizes. 0 to 100% cable fill. U300, U400 or V400 gypsum wallboard assembly. Max area of opening 98.5 sq in. with max dimension of 12-1/8 in. for square devices. Max diam of opening 2-1/2 in. for 2 in. , 4-1/4 in. for 4 in. round devices. Max 6 square ganged together. Max one round device per opening. 1, 2, 3 and 4 hour F rating. Also known as WL3289. |
| W-L-3321 | 1, 2 | 3M™ Fire Barrier Sealant CP 25WB+ 3M™ Fire Barrier Water Tight Sealant 3000 WT | Max 4 in. bundle. See system for cable listing. Max diameter of opening 4-1/2 in. U400 or V400 series gypsum shaft wall assembly. Multiple penetrants. Concentric or eccentric installation. Point contact to max 1/2 in. annular. Optional flexible steel conduit sleeve. 1 & 2 hour F rating. Also known as WL3321. |
| W-L-3336 | 1, 2 | 3M™ Fire Barrier Sealant CP 25WB+ 3M™ Fire Barrier Water Tight Sealant 3000 WT 3M™ Fire Barrier Self-Locking Pillows 3M™ Fire Barrier Pillows 3M™ Fire Barrier Moldable Putty Stix MP+ | Any UL listed cable, armored cable, metal clad cable. See system for details. Max area of opening 225 sq. in. with max dimension 22-1/2 in. Opening must be framed. Max 49% aggregate cross-sectional area. Annular between cable & opening point contact to max 4 in. Horizontal between cable min 1/4 in. to max 4 in. Vertical between cable min 1-1/2 in. to max 4 in. 1 & 2 hour F rating. Also known as WL3336. |
| W-L-3337 | 1, 2 | 3M™ Fire Barrier Sealant CP 25WB+ 3M™ Fire Barrier Water Tight Sealant 3000 WT 3M™ Fire Barrier Sealant IC 15WB+ 3M™ Fire Barrier Sealant FD 150+ | Any UL listed cable, armored cable, metal clad cable. See system for details. Max area of opening 67-1/2 sq. in. with max dimension of 22-1/2 in. Max 49% aggregate cross-sectional area. Annular between cable and opening point contact to max 1-1/4 in. Horizontal between cable min 1/4 in. to max 1 in. No packing material required. 1 & 2 hour F rating. Also known as WL3337 |
| W-L-3338 | 1, 2 | 3M™ Fire Barrier Sealant CP 25WB+ 3M™ Fire Barrier Sealant IC 15WB+ 3M™ Fire Barrier Water Tight Sealant 3000 WT | Any UL listed cable, armored cable, metal clad cable. See system for details. Max area of opening 182 sq. in. with max dimension of 45-1/2 in. Framed opening with vertical studs intact. Max 49% aggregate cross-sectional area. Annular between cable and opening point contact to max 2 in. Horizontal between cable min 1/4 in. to max 1 in. Packing material required. 1 & 2 hour F rating. Also known as WL3338. |
| W-L-3347 | 1, 2 | 3M™ Fire Barrier Sealant IC 15WB+ 3M™ Fire Barrier Sealant CP 25WB+ 3M™ Fire Barrier Water Tight Sealant 3000 WT 3M™ Fire Barrier Rated Foam FIP 1-Step | Max 6 in. EMT sleeve or Sched 5 pipe. 50% cable fill. Annular space between sleeve and opening point contact to max 1/2 in. Sleeve flush with each side of wall or may extend a maximum 18 in. beyond each side of wall. Mineral wool required. 1 & 2 hour F rating. Also known as WL3347. |
| W-L-3371 | 1, 2 | 3M™ Fire Barrier Putty Sleeves 3M™ Fire Barrier Moldable Putty Stix MP+ | Max 48% cable fill. Max 6-1/2 in. opening. U300 or U400 Series wall with wood or steel studs. Space between device and periphery of opening point contact to max 1 in. 1 and 2 hour F rating. 1/2 hour T rating. Also known as WL3371. |
| W-L-3372 | 3, 4 | 3M™ Fire Barrier Putty Sleeves 3M™ Fire Barrier Moldable Putty Stix MP+ | Max 48% cable fill. Max 6-1/2 in. opening. U300 or U400 Series wall with wood or steel studs. Space between device and periphery of opening point contact to max 1 in. Packing material required. 3 and 4 hour F rating. 1/2 hour T rating. Also known as WL3372. |
| W-L-3423 | 1, 2 | 3M™ Fire Barrier Sealant IC 15WB+ 3M™ Fire Barrier Sealant CP 25WB+ 3M™ Fire Barrier Water Tight Sealant 3000 WT 3M™ Fire Barrier Moldable Putty Stix MP+ | Cables penetrating a gypsum wallboard assembly. Cross-sectional area of cables to be max 48 percent. Opening size 6-1/2 in. |
| W-L-3426 | 1, 2 | 3M™ Fire Barrier Plug 3M™ Fire Barrier Rated Foam FIP 1-Step | Max 2 in. or 4-1/2 in. opening in a gypsum wallboard assembly sleeved with No. 28 MSG galvanized sheet steel. Cables penetrating assembly through sleeve with 60% cable fill. |
| W-L-3436 | 1, 2 | 3M™ Fire Barrier Sealant CP 25WB+ 3M™ Fire Barrier Sealant IC 15WB+ 3M™ Fire Barrier Water Tight Sealant 3000 WT 3M™ Fire Barrier Sealant FD 150+ | Max. 2 in. cable bundle making a membrane penetration through one side only of a 1 or 2 hour rated gypsum wallboard assembly. |

System No. W-L-3001

September 07, 2004

(Formerly System No. 149)

F Ratings – 1 and 2 Hr (See Item 1)

T Ratings – 3/4, 1, 1-1/2 and 2 Hr (See Item 2)

L Rating At Ambient – 15 CFM/sq ft (See Item 3)

L Rating At 400 F – less than 1 CFM/sq ft (See Item 3)

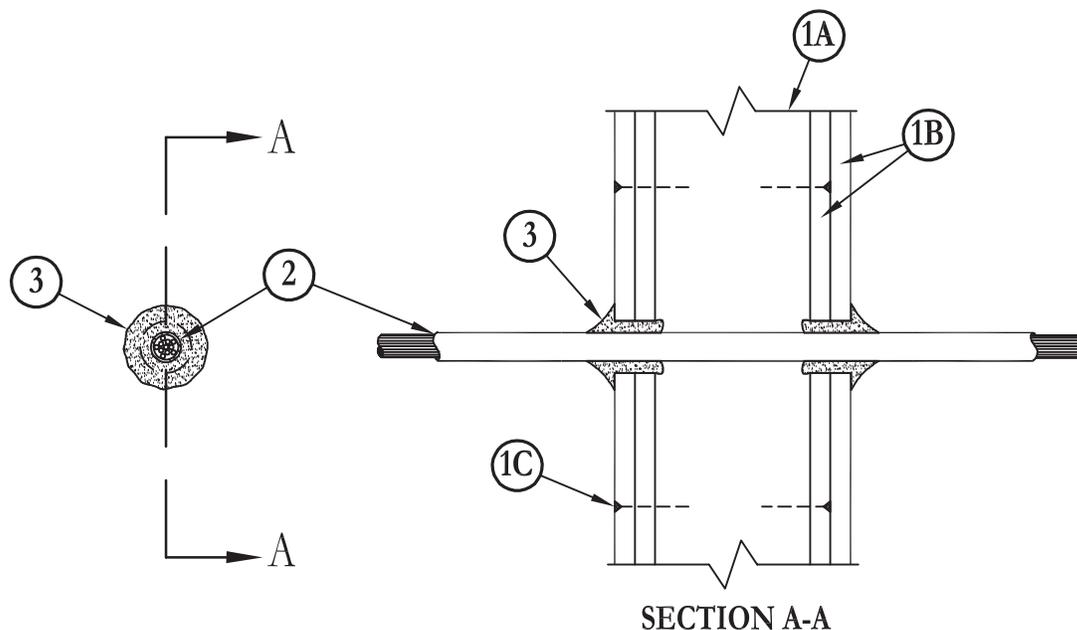

- Wall Assembly** – The 1 or 2 hr fire-rated gypsum wallboard/stud wall assembly shall be constructed of the materials and in the manner described in the individual U300 or U400 Series Wall or Partition Designs in the UL Fire Resistance Directory and shall include the following construction features:
 - Studs** – Wall framing may consist of either wood studs or steel channel studs. Wood studs to consist of nom 2 by 4 in. lumber spaced 16 in. OC with nom 2 by 4 in. lumber end plates and cross braces. Steel studs to be min 3-5/8 in. wide by 1-3/8 in. deep channels spaced max 24 in OC.
 - Gypsum Board*** – Nom 1/2 or 5/8 in. thick, 4 ft wide with square or tapered edges. The gypsum wallboard type, thickness, number of layers and sheet orientation shall be as specified in the individual Wall or Partition Design. Diam of circular through opening to be 3/8 in. to 5/8 in. larger than outside diam of cable or cable bundle.
 - Fasteners** – When wood stud framing is employed gypsum wallboard layers attached to studs with cement coated nails as specified in the individual Wall or Partition Design. When steel channel stud framing is employed, gypsum wallboard attached to studs with Type S self-drilling, self-tapping bugle-head steel screws as specified in the individual Wall or Partition Design.

The hourly F Rating of the firestop system is equal to the hourly fire rating of the wall assembly in which it is installed.

- Cables** – Individual cable or max 1 in. diam cable bundle installed in through opening with an annular space of min 0 in. (point contact) to max 3/4 in. Cable to be rigidly supported on both sides of wall assembly. The following types and sizes of cables may be used:
 - Max 150 pair No. 24 AWG copper conductor telephone cable with polyvinyl chloride (PVC) insulation and jacket materials. **When max 25 pair telephone cable is used, T Rating is 2 hr. When 50 to 150 pair telephone cable is used in 1 hr fire rated wall, T Rating is 3/4 hr. When 50 to 150 pair telephone cable is used in 2 hr fire rated wall, T Rating is 1 hr.**
 - Max No. 10 AWG multiple copper conductor Type NM (“Romex”) nonmetallic sheathed cable with PVC insulation and jacket materials. **When Type NM cable is used, max T Rating is 1-1/2 hr.**
 - Multiple fiber optical communication cable jacketed with PVC and having a max outside diam of 5/8 in. **When fiber optic cable is used, max T Rating is 2 hr.**
 - Max 12 AWG multi conductor (max seven conductors) power/control cable with cross-linked polyethylene (XLPE) insulation and XLPE or PVC jacket materials. **When multi conductor power/control cable is used, max T Rating is 2 hr.**
 - Max four conductor with ground No. 2 AWG (or smaller) aluminum SER cables with polyvinyl chloride insulation and jacket materials.
- Fill, Void or Cavity Materials* – Caulk, Sealant or Putty** – Caulk or putty fill material installed to completely fill annular space between cable and gypsum wallboard on both sides of wall and with a min 1/4 in. diam bead of caulk or putty applied to perimeter of cable(s) at its egress from each side of the wall.

3M COMPANY – MP+ Stix putty, CP 25WB+ caulk, FB-3000 WT sealant or Cable Wrap putty
(Note: L Ratings apply only when CP 25WB+ caulk or FB-3000 WT is used.)

*Bearing the UL Classification Mark

Reprinted from the Online Certifications Directory with permission from Underwriters Laboratories Inc.
Copyright © 2010 Underwriters Laboratories Inc.®



System No. W-L-3009

May 09, 2013

F Rating – 2 Hr

T Rating – 1/2 Hr

L Rating At Ambient – Less Than 1 CFM/sq ft

L Rating At 400 F – Less Than 1 CFM/sq ft

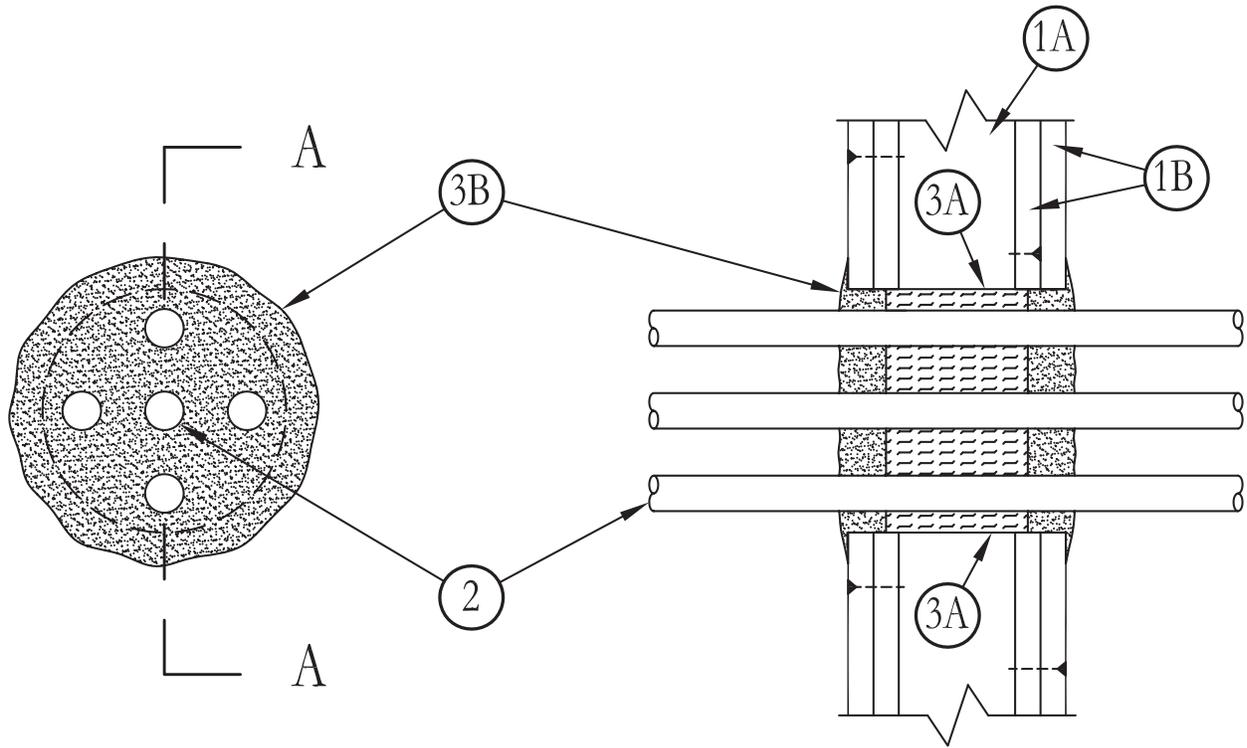
**SECTION A-A**

1. **Wall Assembly** – The fire rated gypsum wallboard/stud wall assembly shall be constructed of the materials and in the manner specified in the individual U300 or U400 Series Wall and Partition Designs in the UL Fire Resistance Directory and shall include the following construction features:
 - A. **Studs** – Wall framing may consist of either wood studs or steel channel studs. Wood studs to consist of nom 2 by 4 in. (51 by 102 mm) lumber spaced 16 in. (406 mm) OC. Steel studs to be min 2-1/2 in. (64 mm) wide and spaced max 24 in. (610 mm) OC.
 - B. **Gypsum Board*** – Two layers of nom 5/8 in. (16 mm) thick gypsum wallboard, as specified in the individual Wall and Partition Design. Max diam of opening is 6 in. (406 mm).
2. **Cables** – Max five 7/C No. 12 AWG cables having polyvinyl chloride (PVC) or cross-linked polyethylene insulation with PVC jacket. Min separation between cables and between cables and periphery of opening shall be 1/2 in. (13 mm). Cables to be rigidly supported on both sides of wall assembly.
3. **Firestop System** – The firestop system shall consist of the following:
 - A. **Packing Material** – Min 3 in. (76 mm) thickness of min 4.0 pcf (64 kg/m³) mineral wool batt insulation firmly packed into opening as a permanent form. Packing material to be recessed from both surfaces of wall as required to accommodate the required thickness of fill material.
 - B. **Fill, Void or Cavity Material* – Sealant** – Min 1 in. (25 mm) thickness of fill material applied within the annulus on both surfaces of wall. Additional fill material to be installed such that a min 1/4 in. (6 mm) crown is formed around the penetrating item.

3M COMPANY – Types FB-1000 NS, FB-2000, FB-2000+.

*Bearing the UL Classification Mark

Reprinted from the Online Certifications Directory with permission from UL

© 2013 UL LLC



System No. W-L-3015

August 18, 2011

F Rating – 1 and 2 Hr (See Item 3)

T Ratings – 0, 3/4 and 2 Hr (See Item 2)

L Rating at ambient – less than 1 CFM per sq ft. (See Item 3)

L Rating at 400 F – less than 1 CFM per sq ft. (See Item 3)

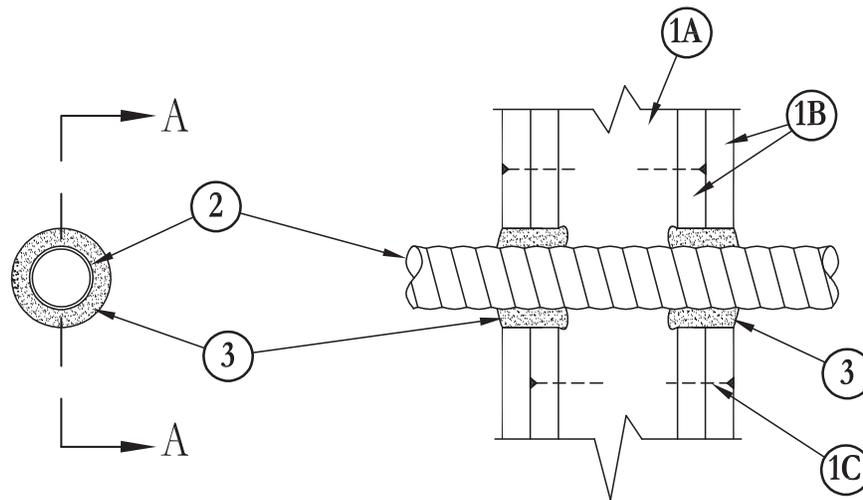

SECTION A-A

- Wall Assembly** – The 1 or 2 hr fire rated gypsum board/stud wall assembly shall be constructed of the materials and in the manner described in the individual U300 or U400 Series Wall or Partition Designs in the UL Fire Resistance Directory and shall include the following construction features:
 - Studs** – Wall framing may consist of either wood studs or steel channel studs. Wood studs to consist of nom 2 by 4 in. lumber spaced 16 in. OC with nom 2 by 4 in. lumber end plates and cross braces. Steel studs to be min 3-5/8 in. wide by 1-3/8 in. deep channels spaced max 24 in. OC.
 - Gypsum Board*** – Nom 5/8 in. thick, 4 ft. wide with square or tapered edges. The gypsum board type, number of layers and sheet orientation shall be as specified in the individual Wall and Partition Design. Max diam of openings cut in gypsum board is 2 in.
 - Fasteners** – When wood stud framing is employed, gypsum board attached to studs with cement coated nails as specified in the individual Wall or Partition Design. When steel channel stud framing is employed, gypsum board attached to studs with Type S self-drilling, self-tapping bugle-head steel screws as specified in the individual Wall or Partition Design.

Diam of circular through opening cut through gypsum board on each side of wall assembly to be min 1/4 in. to max 11/16 in. larger than diam of through penetrating product (Item 2) installed in through opening. Side edge of circular opening to be min 3 in. from nearest stud in wall cavity.
- Through Penetrating Product*** – Max one armored cable or metal clad cable to be installed near center of circular opening in gypsum board. Through penetrating product to be rigidly supported on both sides of wall assembly. The following types of Through-Penetrating Products may be used:
 - Max four copper conductors No. 2/0 AWG (or smaller) aluminum or steel Armored Cable# or Metal-Clad Cable+.
AFC CABLE SYSTEMS INC
 - Two or more twisted copper conductors No. 6 AWG (or smaller) Power Limited Circuit Cable+ with or without a jacket under a metal armor.
AFC CABLE SYSTEMS INC
 - Two or more twisted copper conductors No. 10 AWG (or smaller) Power Limited Fire Alarm Cable+ with or without a jacket under a metal armor.
AFC CABLE SYSTEMS INC
 - Two or more twisted copper conductors No. 12 AWG (or smaller) Non Power Limited Fire Alarm Cable+ with or without a jacket under a metal armor.
AFC CABLE SYSTEMS INC

When installed in 1 hr fire rated wall assembly, T Rating is 0 hr. When installed in 2 hr fire rated wall assembly, T Rating is 3/4 hr when max armored cable, metal-clad cable or power limited circuit cables are used. The T Rating is 2 hr when non power limited fire alarm cable is used.
- Fill, Void or Cavity Material*** – **Caulk** – Caulk fill material forced into annular space around entire circumference of through penetrating product to completely fill opening in gypsum board on each side of the wall assembly. A min 5/8 in. thickness of caulk is required for the 1 hr F Rating. A min 1-1/4 in. thickness of caulk is required for the 2 hr F Rating.
3M COMPANY – CP 25WB+.

*Bearing the UL Classification Mark

Reprinted from the Online Certifications Directory with permission from UL

© 2012 UL LLC



System No. W-L-3030

May 19, 2005

(Formerly System No. 571)

F Ratings – 1 and 2 Hr (See Item 1)

T Rating – 1/2 Hr

L Rating At Ambient – 76 CFM/sq ft (See Item 4)

L Rating At 400 F – 7 CFM/sq ft (See Item 4)

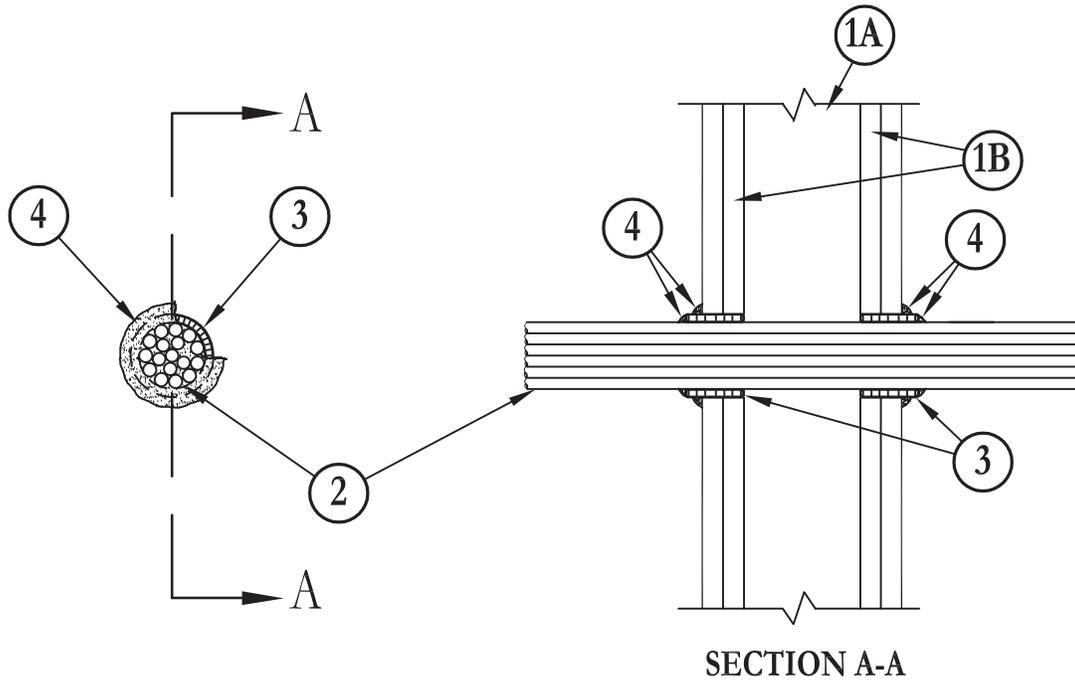

1. **Wall Assembly** – The 1 or 2 hr fire rated gypsum board/stud wall assembly shall be constructed of the materials and in the manner described in the individual U300, U400 or V400 Series Wall or Partition Designs in the UL Fire Resistance Directory and shall include the following construction features:
 - A. **Studs** – Wall framing may consist of either wood studs or steel channel studs. Wood studs to consist of nom 2 in. by 4 in. (51 mm by 102 mm) lumber spaced 16 in. (406 mm) OC with nom 2 in. by 4 in. (51 mm by 102 mm) lumber end plates and cross braces. Steel studs to be min 3-5/8 in. (92 mm) wide by 1-3/8 in. (35 mm) deep channels spaced max 24 in. (610 mm) OC.
 - B. **Gypsum Board*** – Nom 5/8 in. (16 mm) thick, 4 ft. (122 cm) wide with square or tapered edges. The gypsum board type, number of layers and sheet orientation shall be as specified in the individual Wall and Partition Design. Diam of circular cutout in gypsum board layers on each side of wall to be 1/2 in. to 3/4 in. (13 mm to 19 mm) larger than diam of tight cable bundle (Item 2). Max diam of cutouts is 4-1/2 in. (114 mm).

The hourly F Rating of the firestop system is 1 hr when installed in a 1 hr fire rated wall and 2 hr when installed in a 2 hr fire rated wall.

2. **Cables** – Max 4 in. (102 mm) diam tight bundle of cables centered in circular cutouts in gypsum board and rigidly supported on both sides of wall assembly. Any combination of the following types and sizes of copper conductor cables may be used:
 - A. Max 350 kcmil single-conductor power cables; cross-linked polyethylene (XLPE) or polyvinyl chloride (PVC) insulation.
 - B. Max 7/C No. 12 AWG cables; PVC insulation and jacket.
 - C. Max 3/C No. 2/0 AWG multi conductor power and control cables; XLPE or PVC insulation, XLPE or (PVC) jacket.
 - D. Max 200 pair No. 24 AWG telecommunication cables; PVC insulation and jacket.
 - E. Max 6/94 Fiber Optic (F.O.) cable; PVC insulation and jacket.
3. **Fill, Void or Cavity Material* – Wrap Strip** – Nom 1/4 in. (6 mm) thick intumescent elastomeric material faced on one side with aluminum foil, supplied in nom 2 in. (51 mm) wide strips. Nom 2 in. (51 mm) wide strip tightly-wrapped around cable bundle (foil side out) with seam butted. Wrap strip layer securely bound with steel wire tie and slid into annular space approx 1-1/4 in. (32 mm) such that approx 3/4 in. (19 mm) of the wrap strip width protrudes from the wall surface on each side of the assembly.

3M COMPANY – FS-195+

4. **Fill, Void or Cavity Materials* – Caulk, Sealant or Putty** – Min 1/4 in. (6 mm) diam continuous bead of caulk or putty applied to the wrap strip/wall interface and to the exposed edge of the wrap strip approximate 3/4 in. (19 mm) from the wall surface on each side of wall assembly. Caulk or putty to be forced into the interstices of the cable bundle to the max extent possible within the confines of the wrap strip on each side of the wall assembly.

3M COMPANY – CP 25WB+, IC 15WB+, FireDam 150+ caulk, FB-3000 WT sealant or MP+ Stix putty

(Note: L Ratings apply only when CP 25WB+ caulk or FB-3000 WT is used.)

*Bearing the UL Classification Marking

Reprinted from the Online Certifications Directory with permission from Underwriters Laboratories Inc.

Copyright © 2010 Underwriters Laboratories Inc.®



System No. W-L-3031

December 05, 2000

(Formerly System No. 589)

F Ratings – 1 and 2 Hr (See Item 1)

T Ratings – 1/2, 1 and 1-1/2 Hr (See Item 3)

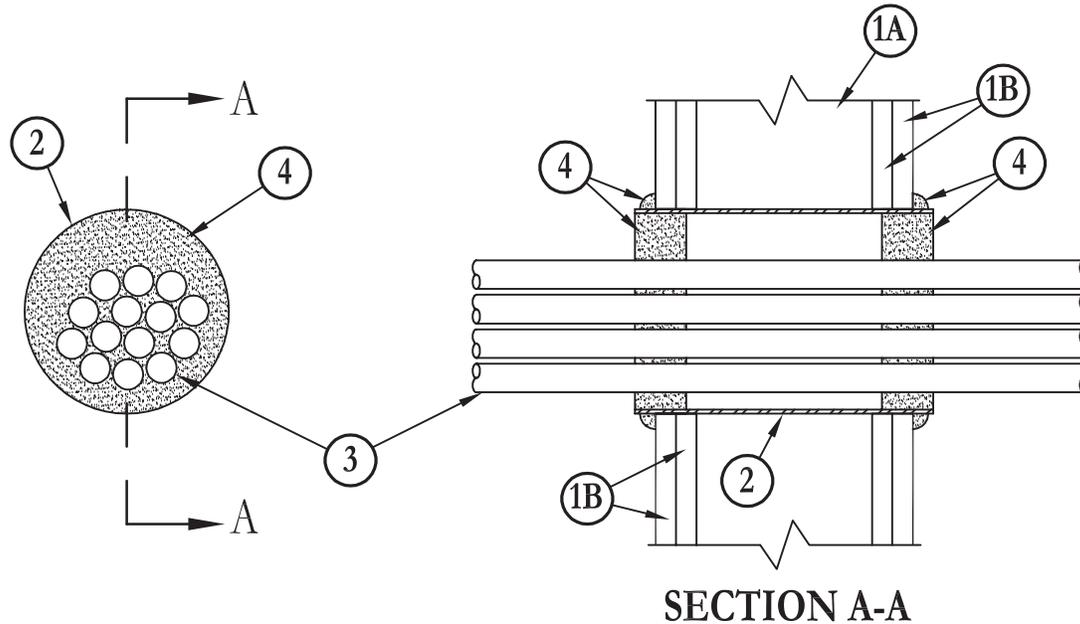

- Wall Assembly** – The 1 or 2 hr fire-rated gypsum wallboard/stud wall assembly shall be constructed of the materials and in the manner described in the individual U300 or U400 Series Wall or Partition Design in the UL Fire Resistance Directory and shall include the following construction features:
 - Studs** – Wall framing may consist of either wood studs or steel channel studs. Wood studs to consist of nom 2 by 4 in. lumber spaced 16 in. OC with nom 2 by 4 in. lumber end plates and cross braces. Steel studs to be min 3-1/2 in. wide by 1-3/8 in. deep channels spaced max 24 in. OC.
 - Gypsum Board*** – 5/8 in. thick, 4 ft wide with square or tapered edges. The gypsum wallboard type, thickness, number of layers, fastener type and sheet orientation shall be as specified in the individual U300 or U400 Series Design in the UL Fire Resistance Directory. Max diam of opening is 4 in.

The hourly F Rating of the firestop system is 1 hr when installed in a 1 hr fire rated wall and 2 hr when installed in a 2 hr fire rated wall.
- Steel Sleeve** – Cylindrical sleeve fabricated from min 0.019 in. thick (28 gauge) galv sheet steel and having a min 2 in. lap along the longitudinal seam. Length of steel sleeve to be equal to thickness of wall plus approx 7/8 to 1 in. such that, when installed, the ends of the sleeve will project approx 7/16 to 1/2 in. beyond the surface of the wall on each side of the wall assembly. Sleeve installed by coiling the sheet steel to a diam smaller than the max 4 in. diam through openings, inserting the coil through the openings and releasing the coil to let it uncoil against the circular cutouts in the gypsum wallboard layers.
- Cables** – Aggregate cross-sectional area of cables in opening to be min 10 percent to max 40 percent of the cross-sectional area of the sleeved opening in wall. Cables to be rigidly supported on both sides of wall assembly. Any combination of the following types and sizes of cable may be used:
 - Max 150 pair No. 24 AWG copper conductor telecommunication cables; PVC insulation and jacket materials. **When multi conductor telecommunication cable is used, T Rating is 1/2 hr.**
 - Max 12 AWG multi conductor Type TC copper power and control cables; Type XHHW conductors (XLP insulation) with XLP or PVC jacket. **When max 12 AWG multi conductor cables are used, T Rating is 1 hr.**
 - Multiple fiber optical communication cable jacketed with PVC and having a max outside diam of 5/8 in. **When fiber optic cable is used, T Rating is 1-1/2 hr.**
- Fill, Void or Cavity Materials* – Putty** – Min 1 in. thickness of moldable putty packed tightly into annular space between cables and sheet steel sleeve (and interstices between cables, if possible), flush with each end of steel sleeve. A nom 1/4 in. diam continuous “rope” or putty shall be applied around the circumference of the steel sleeve at its egress from the gypsum wallboard layers on both sides of the wall assembly.

3M COMPANY – MP+ Stix, Cable Wrap putty

*Bearing the UL Classification Mark

Reprinted from the Online Certifications Directory with permission from Underwriters Laboratories Inc.
Copyright © 2010 Underwriters Laboratories Inc.®



System No. W-L-3032

September 07, 2004

(Formerly System No. 590)

F Ratings – 1 and 2 Hr (See Item 1)

T Rating – 0 and 1/4 Hr (See Item 3F)

L Rating At Ambient – 76 CFM/sq ft

L Rating At 400 F – 7 CFM/sq ft

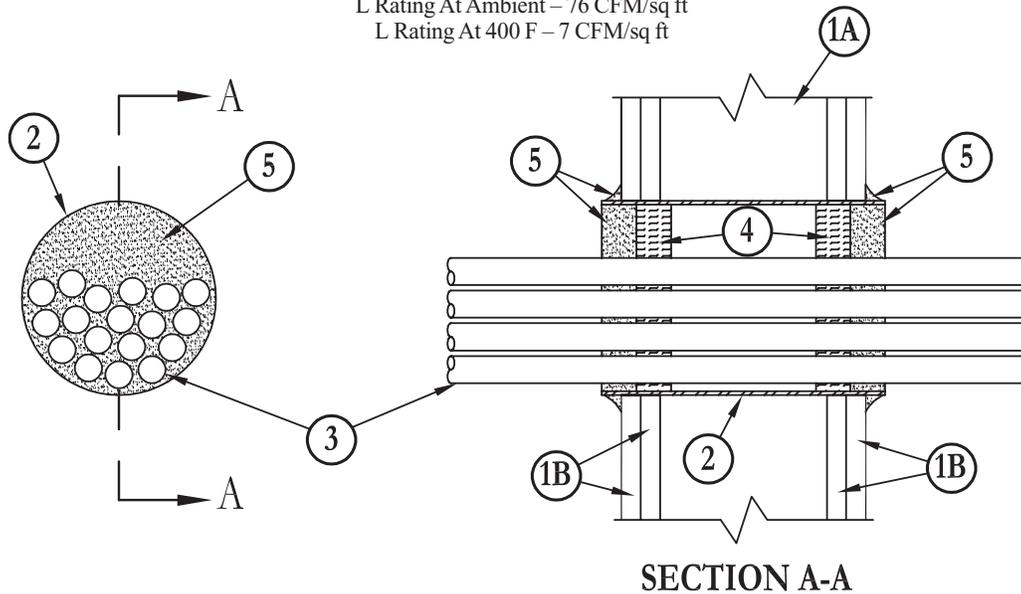

- Wall Assembly** – The 1 or 2 hr fire-rated gypsum wallboard/stud wall assembly shall be constructed of the materials and in the manner described in the individual U300 or U400 Series Wall or Partition Design in the UL Fire Resistance Directory and shall include the following construction features:

- Studs** – Wall framing may consist of either wood studs or steel channel studs. Wood studs to consist of nom 2 by 4 in. lumber spaced 16 in. OC with nom 2 by 4 in. lumber end plates and cross braces. Steel studs to be min 3-1/2 in. wide by 1-3/8 in. deep channels spaced max 24 in. OC.
- Gypsum Board*** – 5/8 in. thick, 4ft wide with square or tapered edges. The gypsum wallboard type, thickness, number of layers, fastener type and sheet orientation shall be as specified in the individual U300 or U400 Series Design in the UL Fire Resistance Directory. Max diam of opening is 6 in.

The hourly F Rating of the firestop system is 1 hr when installed in a 1 hr fire rated wall and 2 hr when installed in a 2 hr fire rated wall.

- Steel Sleeve** – Cylindrical sleeve fabricated from min 0.019 in. thick (28 gauge) galv sheet steel and having a min 2 in. lap along the longitudinal seam. Length of steel sleeve to be equal to thickness of wall plus approx 7/8 to 1 in. such that, when installed, the ends of the sleeve will project approx 7/16 to 1/2 in. beyond the surface of the wall on each side of the wall assembly. Sleeve installed by coiling the sheet steel to diam smaller than the max 6 in. diam through openings, inserting the coil through the openings and releasing the coil to let it uncoil against the circular cutouts in the gypsum wallboard layers.
- Cables** – Aggregate cross-sectional area of cables in opening to be min 8 percent to max 36 percent of the cross-sectional area of the sleeved opening in wall. Cables to be rigidly supported on both sides of wall assembly. The space between cables and periphery of opening shall be min 1/4 in. to max 2-1/2 in. Min separation between Armored Cables and/or Metal-Clad Cables (Item 3F) and between Armored Cables and/or Metal-Clad Cables and all other types of cables shall be 1/4 in. Any combination of the following types and sizes of copper conductor cable may be used:
 - Max 350 kcmil single conductor power cables; cross-linked polyethylene (XLPE) insulation.
 - Max 200 pair No. 24 AWG conductor telecommunication cables; polyvinyl chloride (PVC) insulation and jacket.
 - Max 7/C No. 2/0 AWG multi conductor power and control cables; XLPE or PVC insulation with XLPE or PVC jacket.
 - Max 3/C No. 2/0 AWG cables; PVC insulation and jacket.
 - Max 6/94 Fiber Optic (F.O.) cable; PVC insulation and jacket.
 - Max four copper conductor No. 2/0 AWG (or smaller) aluminum or steel Armored Cable or Metal-Clad Cable Classified as a Through Penetrating Product. **The T Rating is 0 Hr when armored cables or metal-clad cables are used.**

See **Through Penetrating Product*** (XHLY) Category in the Fire Resistance Directory for names of manufacturers. Any aluminum or steel Armored Cable or Metal-Clad Cable Classified as a Through Penetrating Product meeting the above specifications may be used.

- Packing Material** – Min 1 in. thickness of mineral wool batt insulation firmly packed into steel sleeve on both sides of the wall assembly as permanent forms. Packing material to be recessed min 1 in. from end of steel sleeve (min 1/2 in. from surface of gypsum wallboard) on both sides of wall assembly.
- Fill, Void or Cavity Material* – Caulk or Sealant** – Min 1 in. thickness of fill material applied within the annulus, flush with both ends of the steel sleeve. A nom 1/4 in. diam continuous bead of caulk shall be applied around the circumference of the steel sleeve at its egress from the gypsum wallboard layers on both sides of the wall assembly.

3M COMPANY – CP 25WB+ caulk or FB-3000 WT sealant

*Bearing the UL Classification Marking

Reprinted from the Online Certifications Directory with permission from Underwriters Laboratories Inc.

Copyright © 2010 Underwriters Laboratories Inc.®



System No. W-L-3041

May 09, 2013

ANSI/UL2079

F Rating – 2 Hr

T Rating – 0 and 1/2 Hr (See Item 2)

CAN/ULC S115

F Rating – 2 Hr

FT Rating – 0 and 1/2 Hr (See Item 2)

FH Rating – 2 Hr

FTH Rating – 0 and 1/2 Hr (See Item 2)

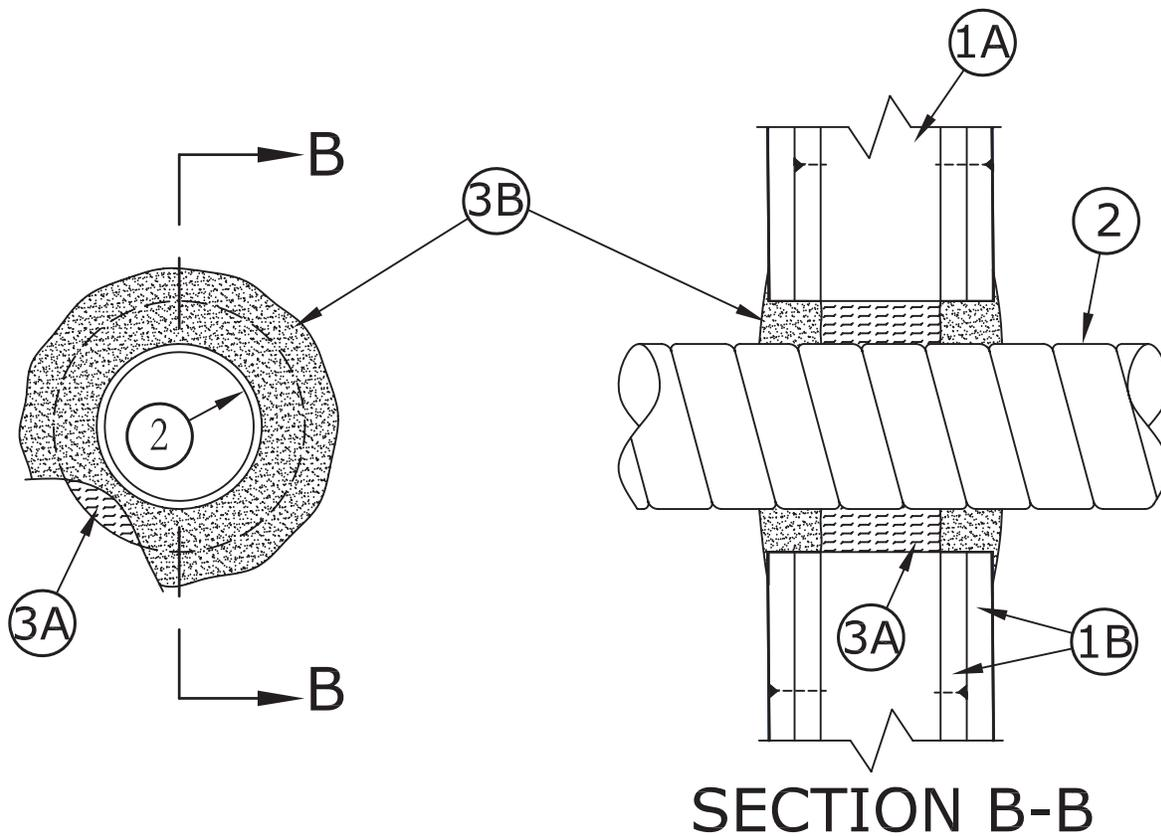

1. **Wall Assembly** – The fire-rated gypsum board/stud wall assembly shall be constructed of the material and in the manner specified in the individual U300 or U400 Series Wall and Partition Designs in the UL Fire Resistance Directory and shall include the following construction features:

- Studs** – Wall framing may consist of either wood studs and steel channel studs. Wood studs to consist of nom 2 by 4 in. (51 by 102 mm) lumber spaced 16 in. (406 mm) OC. Steel studs to be min 2-1/2 in. (64 mm) wide and spaced 24 in. (610 mm) OC.
- Gypsum Board*** – Two layers of nom 5/8 in. (19 mm) thick gypsum board, as specified in the individual Wall and Partition Design. Diam of circular through opening cut through both layers of gypsum board on each side of wall assembly shall be min 1-1/2 in. (38 mm) to max 2-1/2 in. (64 mm) larger than the diam of each through penetrating product (Item 2) installed in through opening.

2. **Through Penetrating Product*** – Max four aluminum conductors 1000 kcmil (or smaller) **Metal Clad Cable** (jacketed or unjacketed). Max one metal clad cable to be installed within the circular opening in gypsum wallboard layers. The annular space between the cable and the periphery of the opening shall range from min 1-1/2 to max 2-1/2 in. (38 to 64 mm). Through penetration product to be rigidly supported on both sides of wall assembly.

GENERAL CABLE INDUSTRIES INC – Stabiloy MC Cable

The T, FT and FTH Rating for the firestop system is ½ hr except that for cable sizes greater than 750 kcmil, the T, FT and FTH Rating is 0 hr.

3. **Firestop System** – The firestop system shall consist of the following:

- Forming Material** – Min 3 in. (76 mm) thickness of min 4 pcf (64 kg/m³) mineral wool batt insulation having a min density of 4 pcf (64 kg/m³) firmly packed into the opening as a permanent form. Packing material to be recessed from both surface of wall as required to accommodate the required thickness of fill material.
- Fill, Void or Cavity Material* – Sealant** – Nom 1 in. (25 mm) thickness of fill material applied within the annulus, flush with both surfaces of wall.

3M COMPANY – Types FB-1000 NS, FB-2000, FB-2000+

*Bearing the UL Classification Mark

Reprinted from the Online Certifications Directory with permission from UL
© 2013 UL LLC



System No. W-L-3062

August 18, 2011

F Rating – 1 and 2 Hr (See Item 5)

T Rating – 3/4 Hr

L Rating At Ambient – less than 1 CFM per sq ft

L Rating At 400 F – less than 1 CFM per sq ft

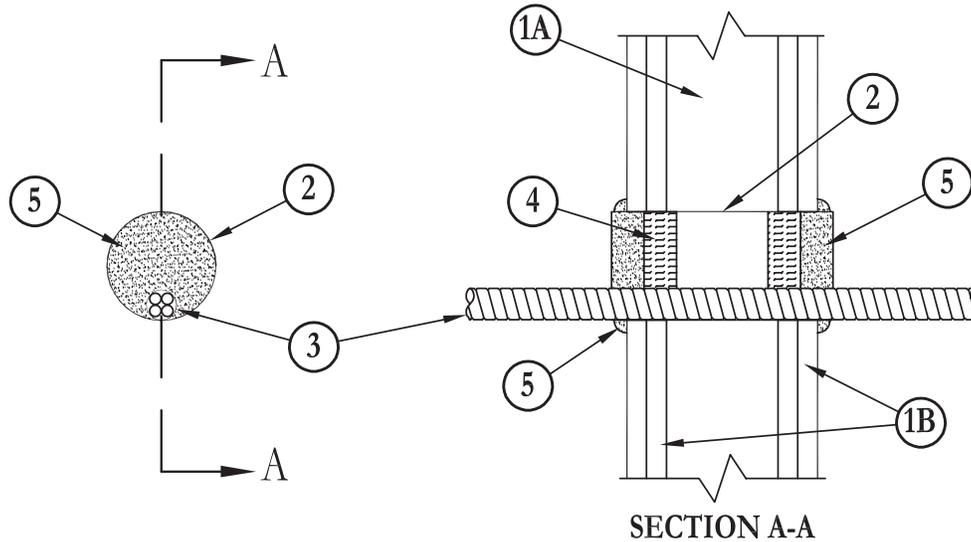

1. **Wall Assembly** – The 1 or 2 hr fire-rated gypsum board/stud wall assembly shall be constructed of the materials and in the manner specified in the individual U300 or U400 Series Wall or Partition Designs in the UL Fire Resistance Directory and shall include the following construction features:
 - A. **Studs** – Wall framing may consist of either wood studs or steel channel studs. Wood studs to consist of nom 2 by 4 in. lumber spaced 16 in. OC. Steel studs to be min 3-5/8 in. wide and spaced max 24 in. OC.
 - B. **Gypsum Board*** – Nom 5/8 in. thick, 4 ft wide with square or tapered edges. The gypsum board type, number of layers, fastener type and sheet orientation shall be as specified in the individual Wall and Partition Design. Max diam of opening in gypsum board is 4 in.
2. **Steel Sleeve** – Cylindrical sleeve fabricated from min 0.019 in. thick (No. 28 gauge) galv sheet steel and having a min 2 in. lap along the longitudinal seam. Length of sleeve to be equal to thickness of wall plus 1 in. such that, when installed, the ends of the sleeve will project approx 1/2 in. beyond each surface of the wall on both sides of the wall assembly. The diam of the openings cut in the gypsum board on each side of the wall assembly to be max 2-1/2 in. larger than outside diam of penetrant. Sleeve installed by coiling the sheet steel to a diam smaller than the through opening, inserting the coil through the openings and releasing the coil to let it uncoil against the circular cutouts in the gypsum board.
3. **Through Penetrating Product*** – Max one through-penetrating product per sleeved opening. Min annular space between cable and edge of through opening is zero in. (point contact). Through penetrating product to be rigidly supported on both sides of wall assembly. The following types of through-penetrating products may be used:
 - A. Max four copper conductors No. 2/0 AWG (or smaller) aluminum or steel Armored Cable# or Metal-Clad Cable+.
 - AFC CABLE SYSTEMS INC**
 - B. Two or more twisted copper conductor No. 6 AWG (or smaller) Power Limited Circuit Cable+ with or without a jacket under a metal armor.
 - AFC CABLE SYSTEMS INC**
 - C. Two or more twisted copper conductor No. 10 AWG (or smaller) Power Limited Fire Alarm Cable+ with or without a jacket under a metal armor.
 - AFC CABLE SYSTEMS INC**
 - D. Two or more twisted copper conductor No. 12 AWG (or smaller) Non Power Limited Fire Alarm Cable+ with or without a jacket under a metal armor.
 - AFC CABLE SYSTEMS INC**
4. **Packing Material** – Polyethylene backer rod or min 1 in. thickness of mineral wool batt insulation firmly packed into opening as a permanent form. Packing material to be recessed min 1/2 in. from board surface on both sides of wall.
5. **Fill, Void or Cavity Material* – Caulk** – Applied to fill the annular space around the flexible metal conduit. A min 1 in. depth of fill material is to be installed flush with edge of sleeve on both sides of wall assembly. A min 1/2 in. diam bead of caulk shall be applied to the steel sleeve/board interface around the entire perimeter of the sleeve on each side of the wall. A bead of caulk shall also be applied between the cable and the steel sleeve at the point contact location on both sides of wall. The hourly F Rating of the firestop system is 1 hr when installed in a 1 hr fire rated wall and 2 hr when installed in a 2 hr fire rated wall.

3M COMPANY – CP 25WB+

#Bearing the UL Listing Mark

*Bearing the UL Classification Mark

Reprinted from the Online Certifications Directory with permission from UL

© 2012 UL LLC



System No. W-L-3068

August 24, 2011

F Rating – 2 Hr

T Rating – 0 Hr

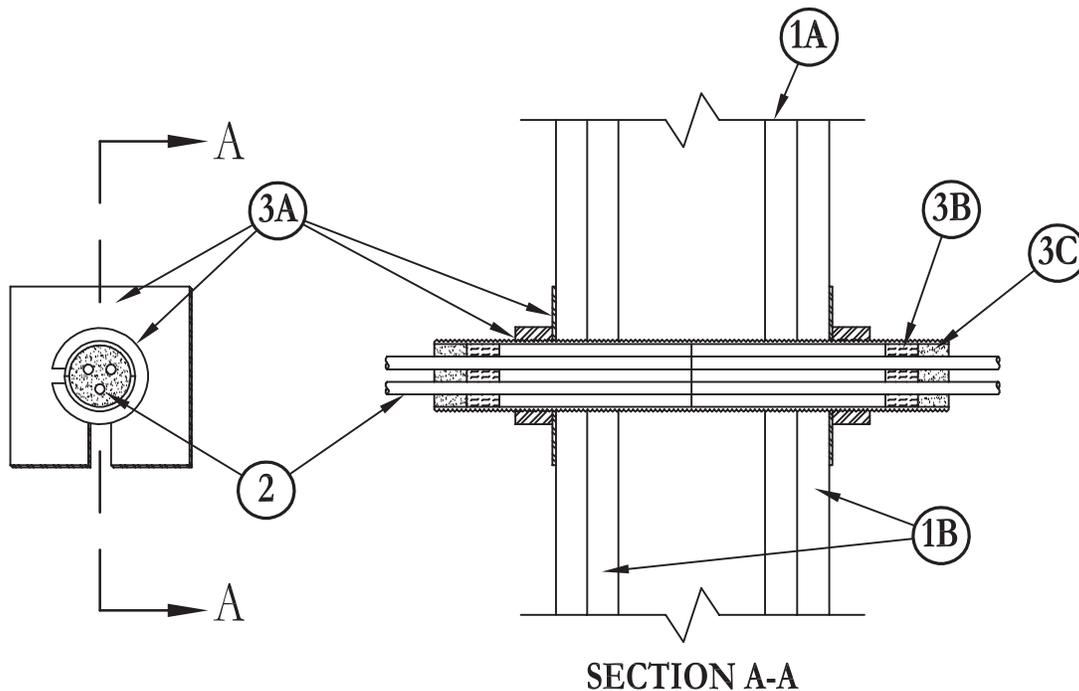

- Wall Assembly** – The fire-rated gypsum wallboard/stud wall assembly shall be constructed of the materials and in the manner specified in the individual U300 or U400 Series Wall and Partition Designs in the UL Fire Resistance Directory and shall include the following construction features:
 - Studs** – Wall framing may consist of either wood studs or steel channel studs. Wood studs to consist of nom 2 by 4 in. lumber spaced 16 in. OC. Steel studs to be min 3-5/8 in. wide and spaced max 24 in. OC.
 - Gypsum Board*** – Two layers of nom 5/8 in. thick gypsum wallboard, as specified in the individual Wall and Partition Design.
- Cables** – Aggregate cross-sectional area of cables in Split Sleeve to be min 8 percent to max 36 percent of the aggregate cross-sectional area of the Split Sleeve. Cables to be rigidly supported on both sides of wall assembly. Any combination of the following types and sizes of copper conductor cable may be used:
 - Max 350 kcmil single conductor Type XHHW power cables; cross-linked polyethylene (XLPE) insulation.
 - Max 150 pair No. 24 AWG conductor telecommunication cables; polyvinyl chloride (PVC) insulation and jacket materials.
 - Max No. 12 AWG multiconductor Type TC power and control cables; Type XHHW conductors XLPE insulation with XLPE or PVC jacket.
- Firestop System** – The firestop system shall consist of the following:
 - Firestop Device*** – Threaded steel sleeve halves incorporating split nuts and split washers sized to fit the specific diam of the opening. Device shall be installed around cables in accordance with the accompanying installation instructions. Device provided in nom 1, 2 and 4 in. sizes. Max diam of opening in wall for 1, 2 and 4 in. size devices are 1-1/4, 2-7/16 and 4-1/2 in., respectively.

UNIQUE FIRE STOP PRODUCTS INC – Split Sleeve
 - Packing Material** – Min 1 in. thickness of min 4.0 pcf mineral wool batt insulation firmly packed into Split Sleeve as a permanent form. Packing material to be recessed from each end of Split Sleeve as required to accommodate the required thickness of fill material.
 - Fill, Void or Cavity Material* – Caulk, Sealant or Putty** – Min 1 in. thickness of fill material applied within the Split Sleeve, flush with both ends.

3M COMPANY – CP 25WB+ Caulk, MPS-2+ Putty or FB-3000 WT Sealant

*Bearing the UL Classification Mark

Reprinted from the Online Certifications Directory with permission from UL
© 2012 UL LLC



Through Penetrations

Cables

3000 Series

Gypsum

WL

System No. W-L-3074

December 15, 1998

F Rating – 1 and 2 Hr (See Item 3)

T Ratings – 0, 3/4 and 2 Hr (See Item 2)

L Rating at ambient – less than 1 CFM per sq ft

L Rating at 400 F – less than 1 CFM per sq ft

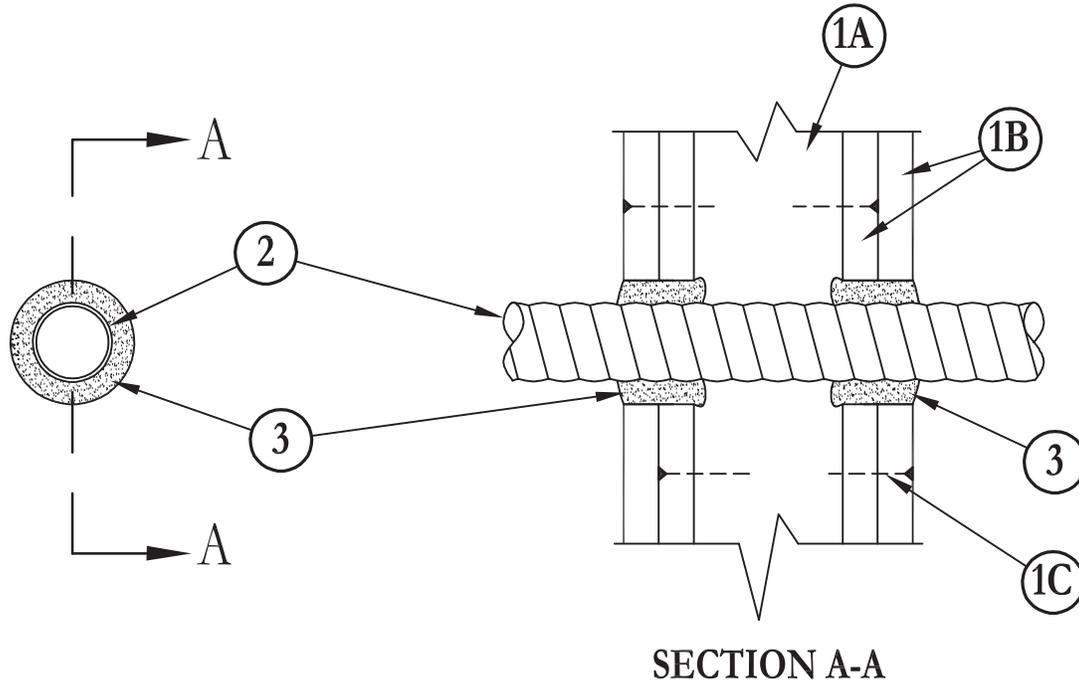
**SECTION A-A**

1. **Wall Assembly** – The 1 or 2 hr fire rated gypsum wallboard/stud wall assembly shall be constructed of the materials and in the manner described in the individual U300 or U400 Series Wall or Partition Designs in the UL Fire Resistance Directory and shall include the following construction features:
 - A. **Studs** – Wall framing may consist of either wood studs or steel channel studs. Wood studs to consist of nom 2 by 4 in. lumber spaced 16 in. OC with nom 2 by 4 in. lumber end plates and cross braces. Steel studs to be min 3-5/8 in. wide by 1-3/8 in. deep channels spaced max 24 in. OC.
 - B. **Gypsum Board*** – Nom 5/8 in. thick, 4 ft. wide with square or tapered edges. The gypsum wallboard type, number of layers and sheet orientation shall be as specified in the individual Wall and Partition Design. Max diam of openings cut in gypsum wallboard is 2 in.
 - C. **Fasteners** – When wood stud framing is employed, gypsum wallboard attached to studs with cement coated nails as specified in the individual Wall or Partition Design. When steel channel stud framing is employed, gypsum wallboard attached to studs with Type S self-drilling, self-tapping bugle-head steel screws as specified in the individual Wall or Partition Design.

Diam of circular through opening cut through gypsum wallboard on each side of wall assembly to be min 1/4 in. to max 11/16 in. larger than diam of through penetrating product (Item 2) installed in through opening. Side edge of circular opening to be min 3 in. from nearest stud in wall cavity.
2. **Through Penetrating Product*** – Max four copper conductor No. 2 AWG (or smaller) aluminum Metal-Clad Cable+. Max one metal clad cable to be installed near center of circular opening in gypsum wallboard. Through penetrating product to be rigidly supported on both sides of wall assembly. **When installed in 1 hr fire rated wall assembly, T Rating is 0 hr. When installed in 2 hr fire rated wall assembly, T Rating is 3/4 hr when max No. 2 AWG cable is used and 2 hr when max 12 AWG cable is used.**

NEXANS CANADA INC

3. **Fill, Void or Cavity Material* – Caulk** – Caulk fill material forced into annular space around entire circumference of through penetrating product to completely fill opening in gypsum wallboard on each side of the wall assembly. A min 5/8 in. thickness of caulk is required for the 1 hr F Rating. A min 1-1/4 in. thickness of caulk is required for the 2 hr F Rating.

3M COMPANY – CP 25WB+

*Bearing the UL Classification Mark

Reprinted from the Online Certifications Directory with permission from Underwriters Laboratories Inc.

Copyright © 2010 Underwriters Laboratories Inc.®



System No. W-L-3075

December 15, 1998

F Rating – 1 and 2 Hr (See Item 5)

T Rating – 3/4 Hr

L Rating At Ambient – less than 1 CFM per sq ft

L Rating At 400 F – less than 1 CFM per sq ft

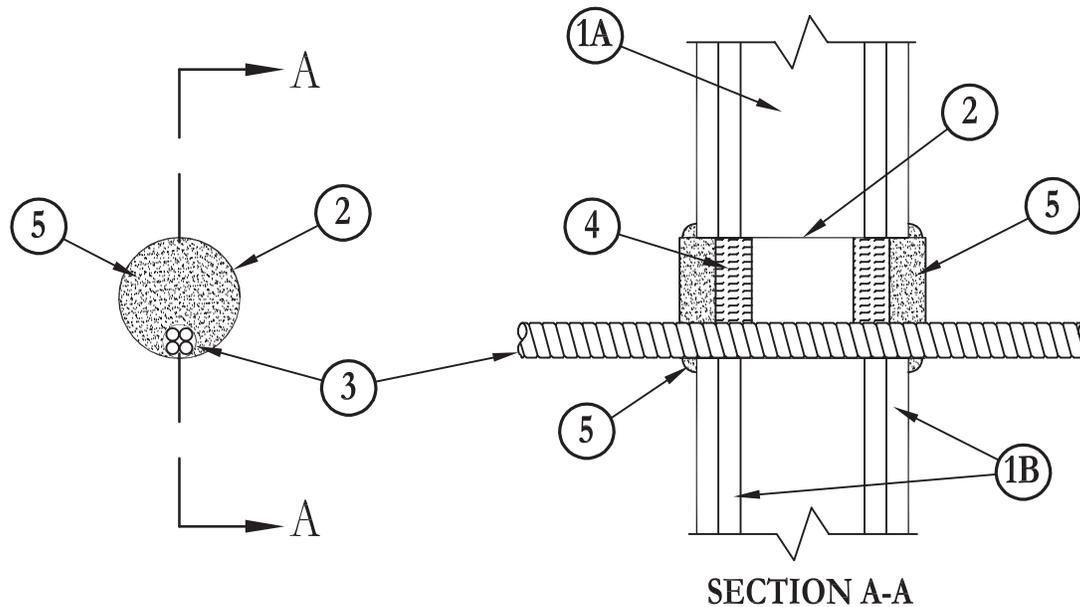

- Wall Assembly** – The 1 or 2 hr fire-rated gypsum wallboard/stud wall assembly shall be constructed of the materials and in the manner specified in the individual U300 or U400 Series Wall or Partition Designs in the UL Fire Resistance Directory and shall include the following construction features:
 - Studs** – Wall framing may consist of either wood studs or steel channel studs. Wood studs to consist of nom 2 by 4 in. lumber spaced 16 in. OC. Steel studs to be min 3-5/8 in. wide and spaced max 24 in. OC.
 - Gypsum Board*** – Nom 5/8 in. thick, 4 ft wide with square or tapered edges. The gypsum wallboard type, number of layers, fastener type and sheet orientation shall be as specified in the individual Wall and Partition Design. Max diam of opening in gypsum wallboard is 4 in.
 - Steel Sleeve** – Cylindrical sleeve fabricated from min 0.019 in. thick (No. 28 gauge) galv sheet steel and having a min 2 in. lap along the longitudinal seam. Length of sleeve to be equal to thickness of wall plus 1 in. such that, when installed, the ends of the sleeve will project approx 1/2 in. beyond each surface of the wall on both sides of the wall assembly. The diam of the openings cut in the gypsum wallboard on each side of the wall assembly to be max 2-1/2 in. larger than outside diam of flexible metal conduit. Sleeve installed by coiling the sheet steel to a diam smaller than the through opening, inserting the coil through the openings and releasing the coil to let it uncoil against the circular cutouts in the gypsum wallboard.
 - Through Penetrating Product*** – Max four copper conductor No. 2/0 AWG (or smaller) aluminum Metal-Clad Cable#. Max one cable per sleeved opening. Min annular space between cable and edge of through opening is zero in. (point contact). Through penetrating product to be rigidly supported on both sides of wall assembly.
- NEXANS CANADA INC**
- Packing Material** – Polyethylene backer rod or min 1 in. thickness of mineral wool batt insulation firmly packed into opening as a permanent form. Packing material to be recessed min 1/2 in. from wallboard surface on both sides of wall.
 - Fill, Void or Cavity Material* – Caulk** – Applied to fill the annular space around the flexible metal conduit. A min 1 in. depth of fill material is to be installed flush with edge of sleeve on both sides of wall assembly. A min 1/2 in. diam bead of caulk shall be applied to the steel sleeve/wallboard interface around the entire perimeter of the sleeve on each side of the wall. A bead of caulk shall also be applied between the cable and the steel sleeve at the point contact location on both sides of wall. The hourly F Rating of the firestop system is 1 hr when installed in a 1 hr fire rated wall and 2 hr when installed in a 2 hr fire rated wall.

3M COMPANY – CP 25WB+

*Bearing the UL Classification Mark

Reprinted from the Online Certifications Directory with permission from Underwriters Laboratories Inc.
Copyright © 2010 Underwriters Laboratories Inc.®



System No. W-L-3077

December 15, 1998

F Rating – 1 and 2 Hr (See Item 3)

T Ratings – 0, 3/4 and 2 Hr (See Item 2)

L Rating at Ambient – less than 1 CFM per sq ft. (See Item 3)

L Rating at 400 F – less than 1 CFM per sq ft. (See Item 3)

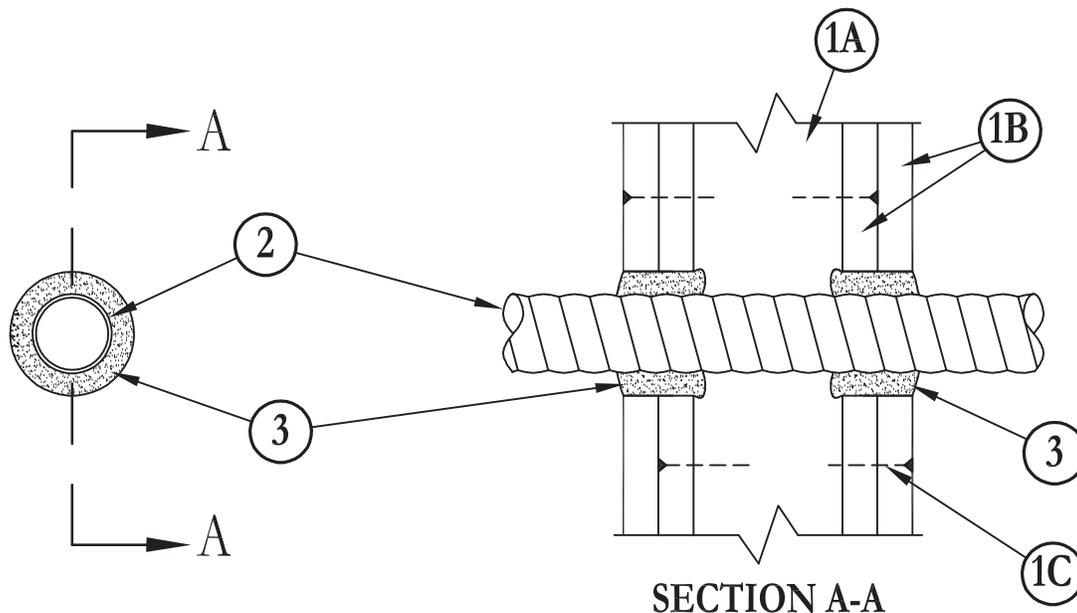

- Wall Assembly** – The 1 or 2 hr fire rated gypsum wallboard/stud wall assembly shall be constructed of the materials and in the manner described in the individual U300 or U400 Series Wall or Partition Designs in the UL Fire Resistance Directory and shall include the following construction features:
 - Studs** – Wall framing may consist of either wood studs or steel channel studs. Wood studs to consist of nom 2 by 4 in. lumber spaced 16 in. OC with nom 2 by 4 in. lumber end plates and cross braces. Steel studs to be min 3-5/8 in. wide by 1-3/8 in. deep channels spaced max 24 in. OC.
 - Gypsum Board*** – Nom 5/8 in. thick, 4 ft. wide with square or tapered edges. The gypsum wallboard type, number of layers and sheet orientation shall be as specified in the individual Wall and Partition Design. Max diam of openings cut in gypsum wallboard is 2 in.
 - Fasteners** – When wood stud framing is employed, gypsum wallboard attached to studs with cement coated nails as specified in the individual Wall or Partition Design. When steel channel stud framing is employed, gypsum wallboard attached to studs with Type S self-drilling, self-tapping bugle-head steel screws as specified in the individual Wall or Partition Design.
Diam of circular through opening cut through gypsum wallboard on each side of wall assembly to be min 1/4 in. to max 11/16 in. larger than diam of through penetrating product (Item 2) installed in through opening. Side edge of circular opening to be min 3 in. from nearest stud in wall cavity.
- Through Penetrating Product*** – Max four copper conductor No. 2 AWG (or smaller) aluminum or steel **Armored Cable+** or **Metal-Clad Cable+**. Max one armored cable or metal clad cable to be installed near center of circular opening in gypsum wallboard. Through penetrating product to be rigidly supported on both sides of wall assembly. **When installed in 1 hr fire rated wall assembly, T Rating is 0 hr. When installed in 2 hr fire rated wall assembly, T Rating is 3/4 hr when max No. 2 AWG cable is used and 2 hr when max 12 AWG cable is used.**

CONDUCTORS C M S A D E C V

- Fill, Void or Cavity Material* – Caulk** – Caulk fill material forced into annular space around entire circumference of through penetrating product to completely fill opening in gypsum wallboard on each side of the wall assembly. A min 5/8 in. thickness of caulk is required for the 1 hr F Rating. A min 1-1/4 in. thickness of caulk is required for the 2 hr F Rating.

3M COMPANY – CP 25WB+

*Bearing the UL Classification Marking

Reprinted from the Online Certifications Directory with permission from Underwriters Laboratories Inc.
Copyright © 2010 Underwriters Laboratories Inc.®



System No. W-L-3078

January 18, 1999

F Ratings – 1 and 2 Hr (See Item 5)

T Rating – 3/4 Hr

L Rating At Ambient – less than 1 CFM per sq ft

L Rating At 400 F – less than 1 CFM per sq ft

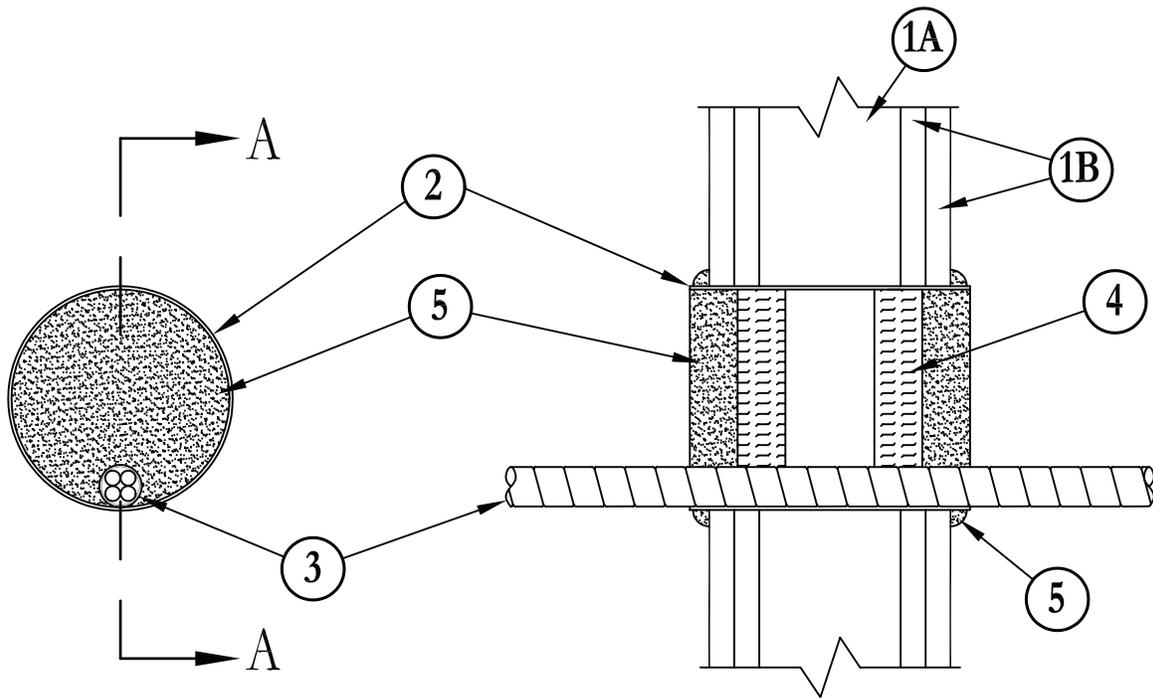

SECTION A-A

- Wall Assembly** – The 1 or 2 hr fire-rated gypsum wallboard/stud wall assembly shall be constructed of the materials and in the manner specified in the individual U300 or U400 Series Wall or Partition Designs in the UL Fire Resistance Directory and shall include the following construction features:
 - Studs** – Wall framing may consist of either wood studs or steel channel studs. Wood studs to consist of nom 2 by 4 in. lumber spaced 16 in. OC. Steel studs to be min 3-5/8 in. wide and spaced max 24 in. OC.
 - Gypsum Board*** – Nom 5/8 in. thick, 4 ft wide with square or tapered edges. The gypsum wallboard type, number of layers, fastener type and sheet orientation shall be as specified in the individual Wall and Partition Design. Max diam of opening in gypsum wallboard is 4 in.
- Steel Sleeve** – Cylindrical sleeve fabricated from min 0.019 in. thick (No. 28 gauge) galv sheet steel and having a min 2 in. lap along the longitudinal seam. Length of sleeve to be equal to thickness of wall plus 1 in. such that, when installed, the ends of the sleeve will project approx 1/2 in. beyond each surface of the wall on both sides of the wall assembly. The diam of the openings cut in the gypsum wallboard on each side of the wall assembly to be max 2-1/2 in. larger than outside diam of flexible metal conduit. Sleeve installed by coiling the sheet steel to a diam smaller than the through opening, inserting the coil through the openings and releasing the coil to let it uncoil against the circular cutouts in the gypsum wallboard.
- Through Penetrating Product*** – Max four copper conductor No. 2/0 AWG (or smaller) aluminum or steel **Armored Cable#** or **Metal-Clad Cable#**. Max one cable per sleeved opening. Min annular space between cable and edge of through opening is zero in. (point contact). Through penetrating product to be rigidly supported on both sides of wall assembly.

CONDUCTORS CM SA DE CV

- Packing Material** – Polyethylene backer rod or min 1 in. thickness of mineral wool batt insulation firmly packed into opening as a permanent form. Packing material to be recessed min 1/2 in. from wallboard surface on both sides of wall.
- Fill, Void or Cavity Material* – Caulk** – Applied to fill the annular space around the flexible metal conduit. A min 1 in. depth of fill material is to be installed flush with edge of sleeve on both sides of wall assembly. A min 1/2 in. diam bead of caulk shall be applied to the steel sleeve/wallboard interface around the entire perimeter of the sleeve on each side of the wall. A bead of caulk shall also be applied between the cable and the steel sleeve at the point contact location on both sides of wall. The hourly F Rating of the firestop system is 1 hr when installed in a 1 hr fire rated wall and 2 hr when installed in a 2 hr fire rated wall.

3M COMPANY – CP 25WB+

#Bearing the UL Listing Mark

*Bearing the UL Classification Marking

Reprinted from the Online Certifications Directory with permission from Underwriters Laboratories Inc.

Copyright © 2010 Underwriters Laboratories Inc.®



System No. W-L-3080

December 16, 2011

F Rating – 2 HR

T Rating – 0 HR

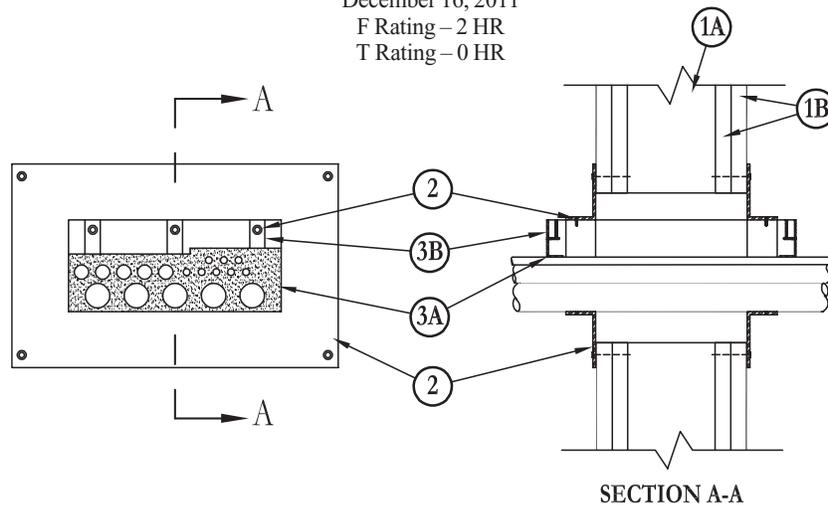

1. **Wall Assembly** – The 2 hr fire rated gypsum wallboard/stud wall assembly shall be constructed of the materials and in the manner specified in the individual U400 Series Wall and Partition Designs in the UL Fire Resistance Directory and shall include the following construction features:
 - A. **Studs** – Wall framing shall consist of steel channel studs to be min 3-1/2 in. wide and spaced max 24 in. OC. Additional 3-1/2 in. wide steel studs shall be used to completely frame opening.
 - B. **Gypsum Board*** – Thickness, type, number of layers and fasteners as required in the individual Wall and Partition Design. Max size of opening to be 12-1/2 in. wide by 6 in. high.
2. **Through Penetrating Products* – Metallic Sleeve** – Nom 12 in. by 5 in. (or smaller) by 20 in. long steel sleeve to be installed either concentrically or eccentrically within the firestop system from either side of wall. An annular space of min 0 in. (point contract) to max 1 in. is required within the firestop system. Sleeve is provided with a steel flange with the overall dimensions of 18-1/4 in. wide by 11-1/4 in high, welded to the sleeve at each corner. Additionally, fasteners are used to secure the flange to the sleeve along the top and bottom of sleeve by means of 1/2 in. long No. 10 (or larger) TEK screws spaced 5 in. OC max. Sleeve is provided with a flanged steel cover plate with the overall dimensions of 18-1/4 in. wide by 11-1/4 in. high. Cover plate to be surface mounted on opposite side of wall and secured to the sleeve by means of No. 10 (or larger) TEK screws spaced a max of 1 in. from each corner of sleeve on all four sides. Additional No. 10 (or larger) TEK screws are used to secure the cover plate to the sleeve along the top and bottom of sleeve, 5 in. OC max. The flanges for the sleeve and cover plate are secured through the wallboard to the studs framing the opening by means of 2 -1/2 in. long Type S self-tapping steel screws at all four corners of the sleeve and cover plate.

CABLOFIL INC – Type P-W.
3. **Cables** – Aggregate cross-sectional area of cables in sleeve to be max 50.4 percent of the cross-sectional area inside the sleeve. Cables to be rigidly supported on both sides of wall assembly. Any combination of the following types and sizes of copper conductor cable may be used:
 - A. Max 600 kcmil single conductor power cables; cross-linked polyethylene (XLPE) or polyvinyl chloride (PVC) insulation.
 - B. Max 900 pair No. 24 AWG conductor telecommunication cables; polyvinyl chloride (PVC) insulation and jacket.
 - C. Max 7/C No. 12 AWG multiconductor power and control cables; XLPE or PVC insulation with XLPE or PVC jacket.
 - D. Max 3/C No. 2/O AWG cables; PVC insulation and jacket.
 - E. Max 1-10/125 Fiber Optic (F.O.) cable; PVC insulation and jacket.
 - F. Max No. 18 AWG RG 6/U coaxial cable; XLPE or PVC insulation and jacket.
4. **Firestop System** – The details of the firestop system shall be as follows:
 - A. **Fill, Void or Cavity Material* – Caulk, Sealant or Putty** – Min 1-1/4 in. thickness of fill material applied around perimeter of cables and within the interstices between cables, recessed approximately 1/4 in. in both ends of sleeve. Fill material to extend a min of 1/4 in. above cables. Min 1/4 in. crown of fill material applied at the point contact location between cables and sleeve and between cables and intumescent sheet (Item 3 B), on both sides of wall assembly. An additional 1/4 in. thickness of fill material to be used to plug cable tray mounting holes on sides of sleeve when a cable tray is not attached to the sleeve.

3M COMPANY – CP 25WB+ Caulk, MPS-2+ putty, Cable Wrap putty or FB-3000 WT Sealant
 - B. **Fill, Void or Cavity material* – Intumescent Sheet** – Rigid foil-faced sheet with galv steel sheet backer. Sheet cut to fit tightly into end of sleeve on both sides of wall, flush with the ends of the sleeve, filling the annular space between the top of the cables and the sleeve with galv steel sheet facing outward. Bottom of sheet to be cut to follow the contour of the cables with a max 1/4 in. space between the sheet and the cables. Sheet secured to top of sleeve with a min of three 24 gauge (or larger), min 1 in. wide steel angles. The length of the angle leg secured to top of sleeve is 2 in. min. The length of the angle leg secured to the intumescent sheet is not less than 1 in. shorter than the height of the sheet. The angles are located a max of 1 in. from each side of the sleeve and at the center of the sleeve. The angles are secured to sleeve with a min of one 1/2 in. long No. 10 (or larger) TEK screw. The angles are secured to sheet with a min of one 1/2 in. long No. 10 (or larger) TEK screw for angle legs 2 in. long or shorter and by a min of two 1/2 in. long No. 10 (or larger) TEK screws for angle legs longer Than 2 in.

3M COMPANY – CS-195+

*Bearing the UL Classification Marking

Reprinted from the Online Certifications Directory with permission from UL

© 2012 UL LLC



System No. W-L-3081

August 24, 2011

F Rating – 1 Hr

T Rating – 0 Hr

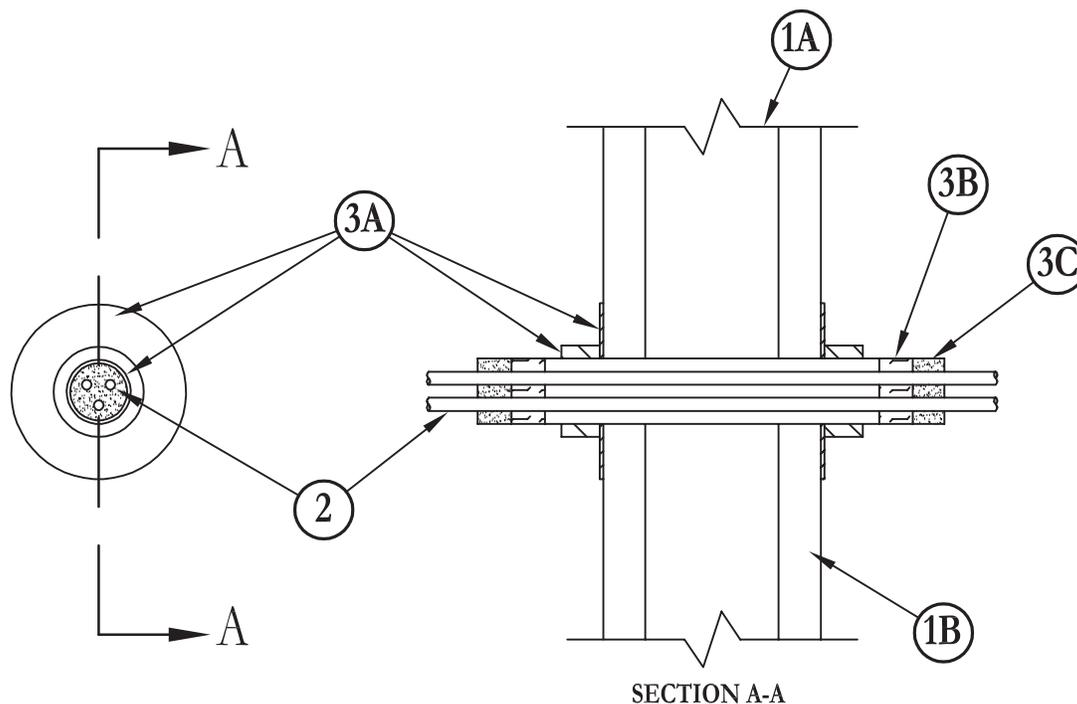

- Wall Assembly** – The 1 hr fire-rated gypsum wallboard/stud wall assembly shall be constructed of the materials and in the manner specified in the individual U300 or U400 Series Wall and Partition Designs in the UL Fire Resistance Directory and shall include the following construction features:
 - Studs** – Wall framing may consist of either wood studs or steel channel studs. Wood studs to consist of nom 2 by 4 in. lumber spaced 16 in. OC. Steel studs to be min 3-5/8 in. wide and spaced max 24 in. OC.
 - Gypsum Board*** – One layers of nom 5/8 in. thick gypsum wallboard, as specified in the individual Wall and Partition Design.
- Cables** – Aggregate cross-sectional area of cables in Smooth Sleeve to be min 8 percent to max 36 percent of the aggregate cross-sectional area of the Smooth Sleeve. Cables to be rigidly supported on both sides of wall assembly. Any combination of the following types and sizes of copper conductor cable may be used:
 - Max 350 kcmil single conductor Type XHHW power cables; cross-linked polyethylene (XLPE) insulation.
 - Max 150 pair No. 24 AWG conductor telecommunication cables; polyvinyl chloride (PVC) insulation and jacket materials.
 - Max No. 12 AWG multiconductor Type TC power and control cables; Type XHHW conductors XLPE insulation with XLPE or PVC jacket.
- Firestop System** – The firestop system shall consist of the following:
 - Firestop Device*** – Smooth steel sleeve device incorporating flat washers secured by sliding compression couplers. Device shall be installed in accordance with the accompanying installation instructions. Device provided in nom 1, 2 and 4 in. sizes. Max diam of opening in wall for 1, 2 and 4 in. size devices are 1-1/8, 2-1/4 and 4-1/2 in., respectively.
UNIQUE FIRE STOP PRODUCTS INC – Smooth Sleeve
 - Packing Material** – Min 1 in. thickness of min 4.0 pcf mineral wool batt insulation firmly packed into Smooth Sleeve as a permanent form. Packing material to be recessed from each end of Smooth Sleeve as required to accommodate the required thickness of fill material.
 - Fill, Void or Cavity Material* – Caulk, Sealant or Putty** – Min 1 in. thickness of fill material applied within the Smooth Sleeve, flush with both ends.
3M COMPANY – CP 25WB+ Caulk, MPS-2+ Putty or FB-3000 WT Sealant.

*Bearing the UL Classification Mark

Reprinted from the Online Certifications Directory with permission from UL

© 2012 UL LLC



System No. W-L-3082

August 24, 2011

F Rating – 2 Hr

T Rating – 0 Hr

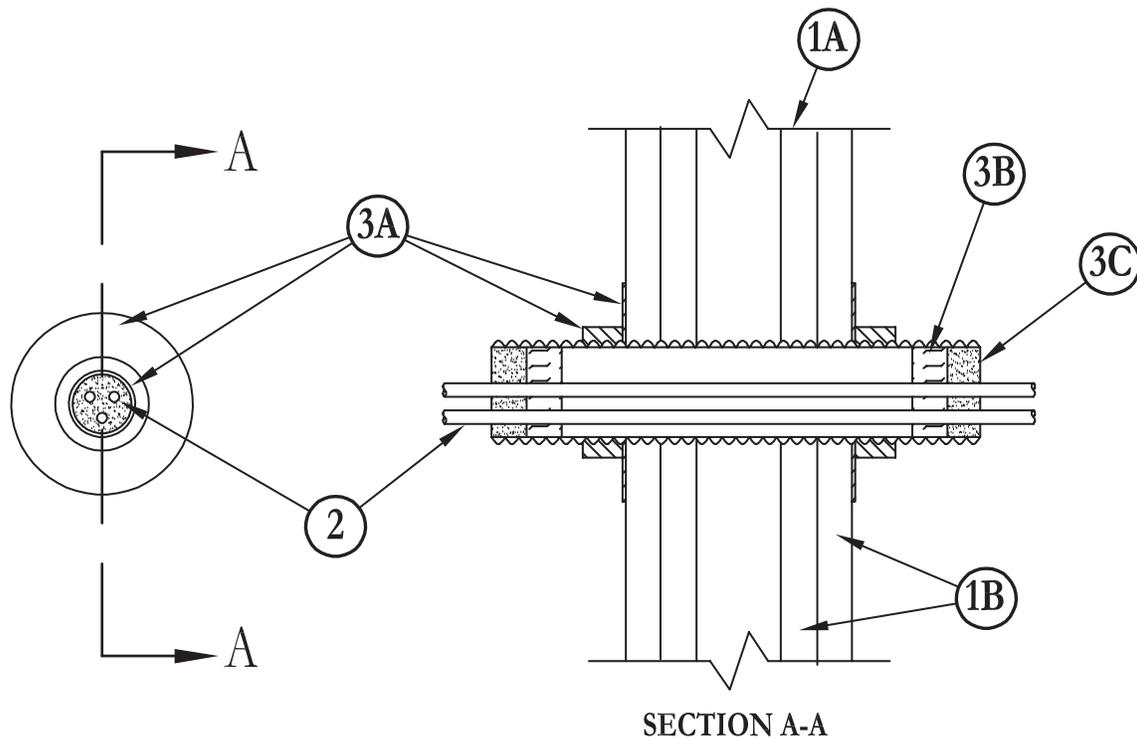

SECTION A-A

1. **Wall Assembly** – The fire-rated gypsum wallboard/stud wall assembly shall be constructed of the materials and in the manner specified in the individual U300 or U400 Series Wall and Partition Designs in the UL Fire Resistance Directory and shall include the following construction features:
 - A. **Studs** – Wall framing may consist of either wood studs or steel channel studs. Wood studs to consist of nom 2 by 4 in. lumber spaced 16 in. OC. Steel studs to be min 3-5/8 in. wide and spaced max 24 in. OC.
 - B. **Gypsum Board*** – Two layers of nom 5/8 in. thick gypsum wallboard, as specified in the individual Wall and Partition Design.
2. **Cables** – Aggregate cross-sectional area of cables in Threaded Sleeve to be min 8 percent to max 36 percent of the aggregate cross-sectional area of the Threaded Sleeve. Cables to be rigidly supported on both sides of wall assembly. Any combination of the following types and sizes of copper conductor cable may be used:
 - A. Max 350 kcmil single conductor Type XHHW power cables; cross-linked polyethylene (XLPE) insulation.
 - B. Max 150 pair No. 24 AWG conductor telecommunication cables; polyvinyl chloride (PVC) insulation and jacket materials.
 - C. Max No. 12 AWG multiconductor Type TC power and control cables; Type XHHW conductors XLPE insulation with XLPE or PVC jacket.
3. **Firestop System** – The firestop system shall consist of the following:
 - A. **Firestop Device*** – Threaded steel sleeve device incorporating flat washers secured by threaded couplings. Device shall be installed in accordance with the accompanying installation instructions. Device provided in nom 1, 2 and 4 in. sizes. Max diam of opening in wall for 1, 2, and 4 in. size devices are 1-5/16, 2-3/8 and 4-1/2 in., respectively.
UNIQUE FIRE STOP PRODUCTS INC – Threaded Sleeve
 - B. **Packing Material** – Min 1 in. thickness of min 4.0 pcf mineral wool batt insulation firmly packed into Threaded Sleeve as a permanent form. Packing material to be recessed from each end of Threaded Sleeve as required to accommodate the required thickness of fill material.
 - C. **Fill, Void or Cavity Material*** – **Caulk, Sealant or Putty** – Min 1 in. thickness of fill materials applied within the Threaded Sleeve, flush with both ends.
3M COMPANY – CP 25WB+ Caulk, MPS-2+ Putty or FB-3000 WT Sealant

*Bearing the UL Classification Mark

Reprinted from the Online Certifications Directory with permission from UL
© 2012 UL LLC

System No. W-L-3110

September 07, 2004

F Ratings – 1 and 2 Hr (See Item 1)

T Rating – 0 Hr

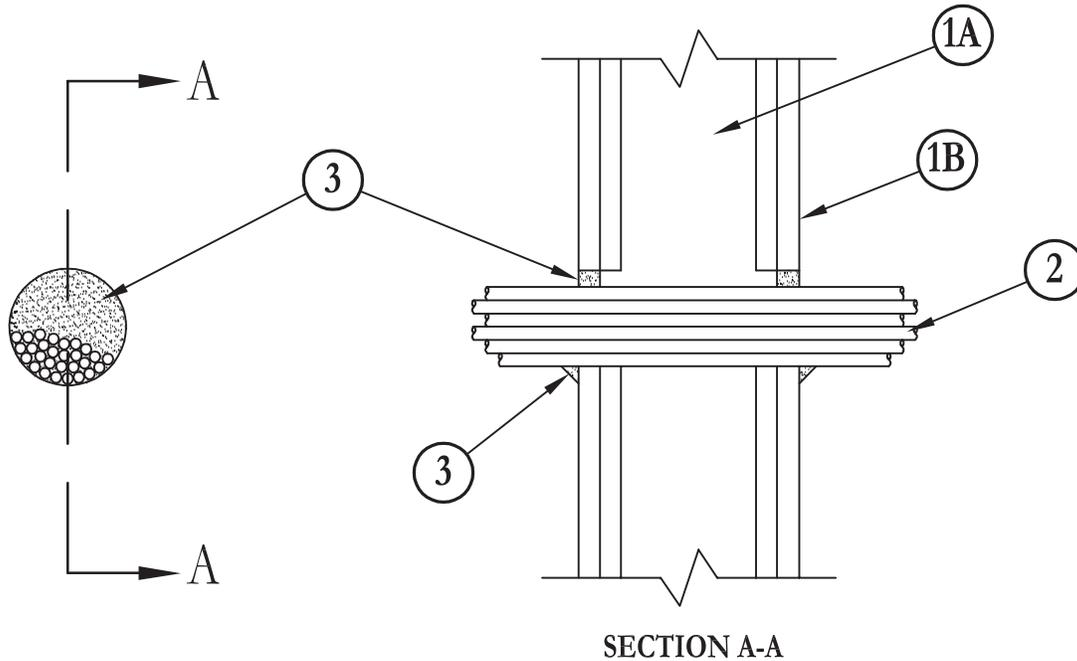

- Wall Assembly** – The 1 or 2 hr fire rated gypsum wallboard/stud wall assembly shall be constructed of the materials and in the manner specified in the individual U300 or U400 Series Wall and Partition Designs in the UL Fire Resistance Directory and shall include the following construction features:
 - Studs** – Wall framing may consist of either wood studs or steel channel studs. Wood studs to consist of nom 2 by 4 in. lumber spaced 16 in. OC. Steel studs to be min 3-1/2 in. wide and spaced max 24 in. OC.
 - Gypsum Board*** – Thickness, type, number of layers and fasteners as required in the individual Wall and Partition Design. Max diam of opening is 4-1/2 in.

The hourly F Rating of the firestop system is equal to the hourly fire rating of the wall assembly in which it is installed.

- Cables** – Max 4 in. diam tight bundle of cables installed eccentrically or concentrically in opening. The annular space between the bundled cables and the periphery of the opening to be min. 0 in. (point contact) to a maximum 1/2 in. Cables may or may not be routed through flexible steel conduit with or without vinyl coating. Cables to be rigidly supported on both sides of wall assembly. Any combination of the following types and sizes of cables may be used:
 - Max 150 pair No. 24 AWG (or smaller) copper conductor with polyvinyl chloride (PVC) insulation and jacket.
 - Max 1/C 350 kcmil (or smaller) copper conductor cable with cross-linked polyethylene (XLPE) jacket.
 - Max 3/C No. 2/0 AWG (or smaller) aluminum or copper conductor cable with XLPE insulation and PVC jacket.
 - Max 7/C No. 12 AWG (or smaller) copper conductor cable with PVC insulation and jacket.
 - Max No. 18 AWG RG 6//U coaxial cable with PVC insulation and jacket.
 - Max 3/C with ground No. 12 AWG (or smaller) NM cable with PVC insulation and jacket.
 - Through Penetrating Product*** – Max 3/C No. 2 AWG (or smaller) aluminum or steel clad **Armored Cable*** or aluminum or steel clad **Metal Clad Cable*** with copper conductors.

ALFLEX CORP

- Fill, Void or Cavity Materials* – Caulk or Sealant** – Min 5/8 in. thickness of fill material applied within annulus, flush with each surface of wall. Min 5/8 in. thickness of fill material applied into interstices of cables on both sides of wall.

3M COMPANY – CP 25WB+ caulk or FB-3000 WT sealant

*Bearing the UL Classification Marking

Reprinted from the Online Certifications Directory with permission from Underwriters Laboratories Inc.
Copyright © 2010 Underwriters Laboratories Inc.®



Through Penetrations

Cables

3000 Series

Gypsum

WL

System No. W-L-3123

September 26, 2001

F Ratings – 1 and 2 Hr (See Item 3)

T Ratings – 0, 3/4 and 2 Hr (See Item 2)

L Rating At Ambient – Less Than 1 CFM/sq ft (See Item 3)

L Rating At 400 F – Less Than 1 CFM/sq ft (See Item 3)

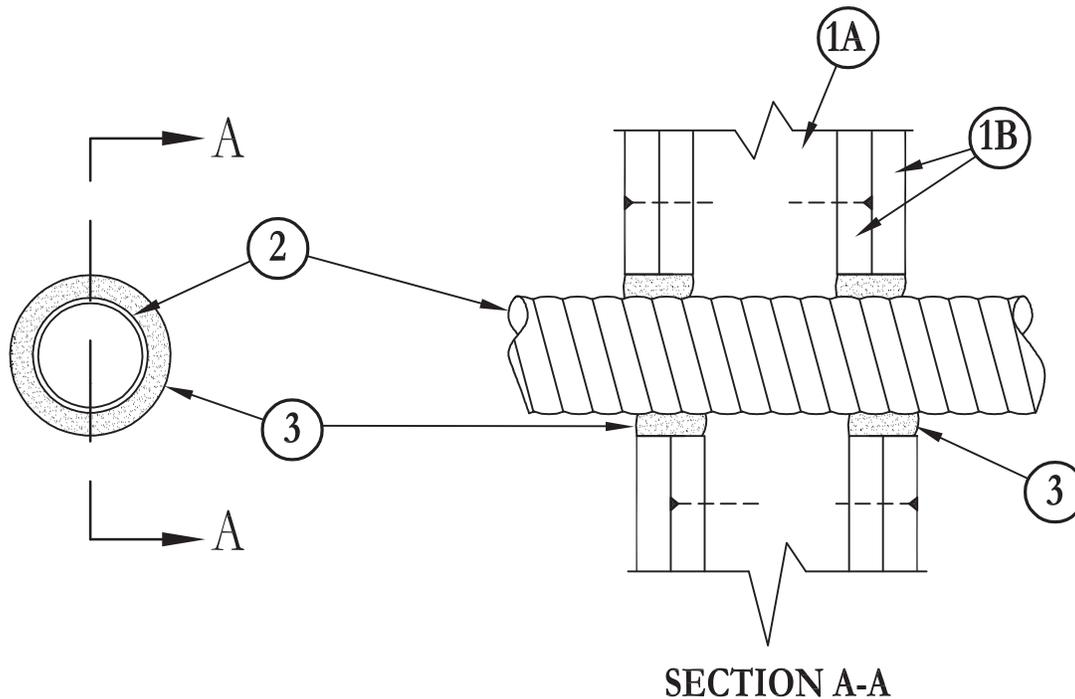

1. **Wall Assembly** – The 1 or 2 hr fire rated gypsum wallboard/stud wall assembly shall be constructed of the materials and in the manner described in the individual U300 or U400 Series Wall or Partition Designs in the UL Fire Resistance Directory and shall include the following construction features:
 - A. **Studs** – Wall framing may consist of either wood studs or steel channel studs. Wood studs to consist of nom 2 by 4 in. lumber spaced 16 in. OC with nom 2 by 4 in. lumber end plates and cross braces. Steel studs to be min 3-5/8 in. wide by 1-3/8 in. deep channels spaced max 24 in. OC.
 - B. **Gypsum Board*** – Nom 5/8 in. thick, 4 ft wide with square or tapered edges. The gypsum wallboard type, number of layers and sheet orientation shall be as specified in the individual Wall and Partition Design. Max diam of openings cut in gypsum wallboard is 2 in.
 - C. **Fasteners** – When wood stud framing is employed, gypsum wallboard attached to studs with cement-coated nails as specified in the individual Wall or Partition Design. When steel channel stud framing is employed, gypsum wallboard attached to studs with Type S self-drilling, self-tapping bugle-head steel screws as specified in the individual Wall or Partition Design.

Diam of circular through opening cut through gypsum wallboard on each side of wall assembly to be min 1/4 in. to max 11/16 in. larger than diam of through penetrating product (Item 2) installed in through opening. Side edge of circular opening to be min 3 in. from nearest stud in wall cavity.
2. **Through Penetrating Product*** – Max four copper conductor No. 5 AWG (or smaller) aluminum or steel **Metal-Clad Cable**+. Max one metal-clad cable to be installed near center of circular opening in gypsum wallboard. Through penetrating product to be rigidly supported on both sides of wall assembly. When installed in 1 hr fire rated wall assembly, T Rating is 0 hr. When installed in 2 hr fire rated wall assembly, T Rating is 3/4 hr when max No. 5 AWG cable is used and 2 hr when max 12 AWG cable is used.

NORTHERN CABLES INC

3M COMPANY – CP 25WB+

*Bearing the UL Classification Mark

Reprinted from the Online Certifications Directory with permission from Underwriters Laboratories Inc.
 Copyright © 2010 Underwriters Laboratories Inc.®



System No. W-L-3129

September 07, 2004

F Rating – 1 and 2 Hr (See Item 1 and 3)

T Rating – 0 and 1/2 Hr (See Item 1)

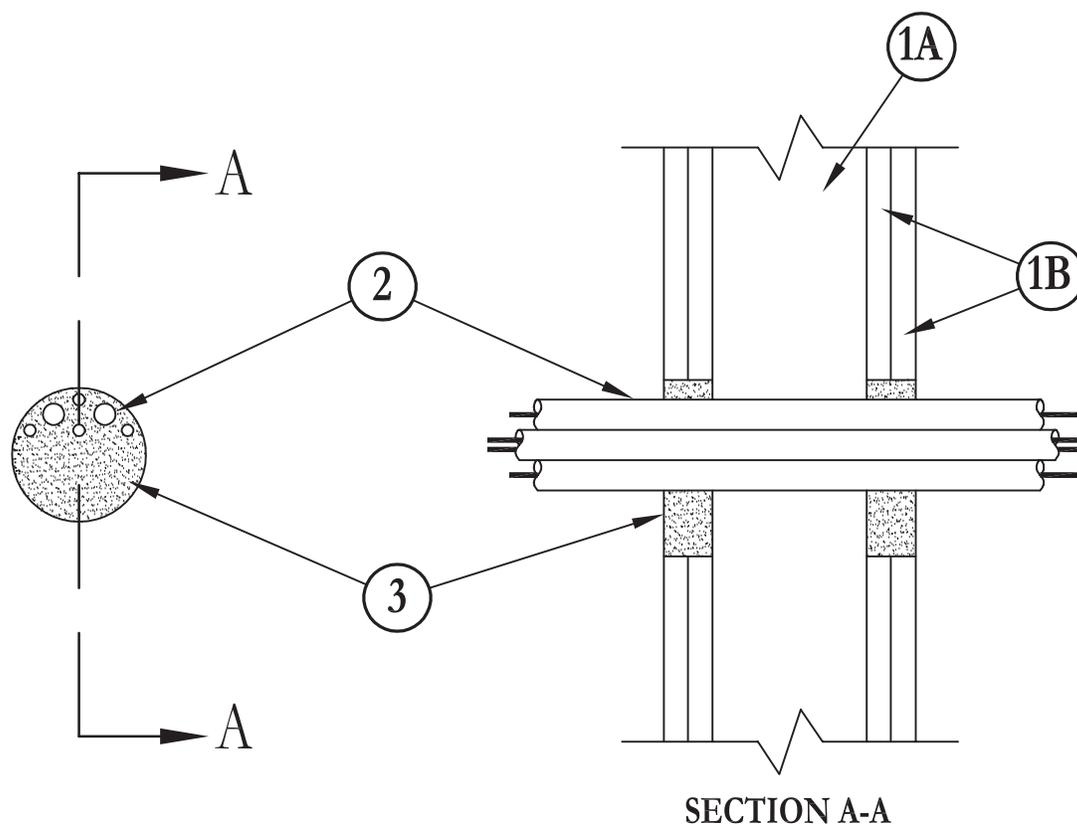

- Wall Assembly** – The 1 or 2 hr fire rated gypsum wallboard/stud wall assembly shall be constructed of the materials and in the manner specified in the individual U300 or U400 Series Wall and Partition Designs in the UL Fire Resistance Directory and shall include the following construction features:
 - Studs** – Wall framing may consist of either wood studs or steel channel studs. Wood studs to consist of nom 2 by 4 in. lumber spaced 16 in. OC. Steel studs to be min 3-1/2 in. wide and spaced max 24 in. OC.
 - Gypsum Board*** – Thickness, type, number of layers and fasteners as required in the individual Wall and Partition Design. Max diam of opening is 4 in.

The hourly F Rating of the firestop system is equal to the hourly fire rating of the wall assembly in which it is installed. The hourly T Rating is 0 hr for 1 hr rated assemblies and 1/2 hr for 2 hr assemblies.
- Cables** – Aggregate cross-sectional area of cables in opening to be max 37 percent of the aggregate cross-sectional area of the opening. Annular space between cables and edge of opening shall be min 0 in. (point contact) to max 2-1/2 in. Separation between cables shall be min 1/8 in. Cables to be rigidly supported on both sides of wall assembly. Any combination of the following types and sizes of copper conductor cables may be used:
 - Max 100 pair No. 24 AWG cables with polyvinyl chloride (PVC) insulation and jacket.
 - Max 3/C No. 2 AWG polyvinyl chloride (PVC) jacketed aluminum clad cable with cross-linked polyethylene (XLPE) insulation.
 - Max 2/C No. 14 AWG polyvinyl chloride (PVC) jacketed aluminum clad cable with cross-linked polyethylene (XLPE) insulation.
- Fill, Void or Cavity Material* – Sealant** – Min thickness of 5/8 in. and 1-1/4 in. of sealant for 1 and 2 hr rated wall assemblies, respectively, applied within annulus between cables and between cables and periphery of opening, flush with both surfaces of wall assembly. At the point contact location between cables and gypsum wallboard, a min 1/2 in. diam bead of sealant shall be applied at the cable/wallboard interface on both surfaces of wall assembly.

3M COMPANY – FB – 1000 NS, FB-3000 WT sealant

*Bearing the UL Classification Marking

Reprinted from the Online Certifications Directory with permission from Underwriters Laboratories Inc.
Copyright © 2010 Underwriters Laboratories Inc.®



System No. W-L-3130

September 07, 2004

F Rating – 1 and 2 Hr (See Items 1 and 3)

T Rating – 0 Hr

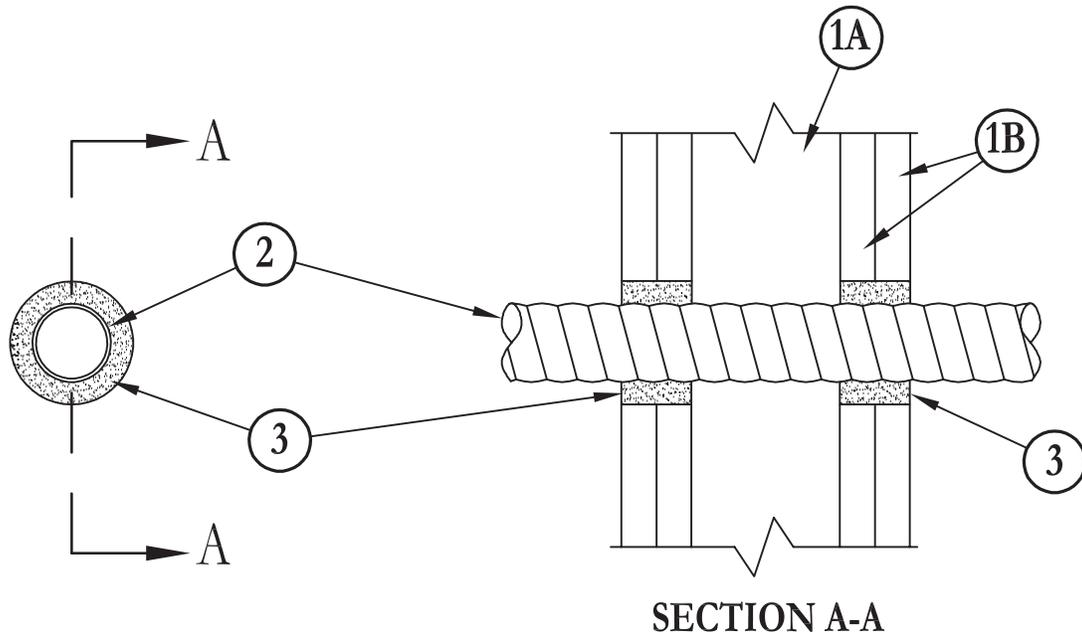

- Wall Assembly** – The 1 or 2 hr fire rated gypsum wallboard/stud wall assembly shall be constructed of the materials and in the manner specified in the individual U300 or U400 Series Wall and Partition Designs in the UL Fire Resistance Directory and shall include the following construction features:
 - Studs** – Wall framing may consist of either wood studs or steel channel studs. Wood studs to consist of nom 2 by 4 in lumber spaced 16 in. OC. Steel studs to be min 3-1/2 in. wide and spaced max 24 in. OC.
 - Gypsum Board*** – Thickness, type, number of layers and fasteners as required in the individual Wall and Partition Design. Max diam of opening is 2 in.

The hourly F Rating of the firestop system is equal to the hourly fire rating of the wall assembly in which it is installed.
- Through Penetrating Product*** – Max four copper conductor No. 2/0 AWG (or smaller) aluminum or steel **Metal-Clad Cable+** centered in opening. The annular space between metal-clad cable and periphery of opening is min 1/4 in. to max 3/4 in. Metal-clad cable to be rigidly supported on both sides of wall assembly.

AFC CABLE SYSTEMS INC

- Fill, Void or Cavity Material* – Sealant** – Min thickness of 5/8 in. and 1-1/4 in. of sealant for 1 and 2 hr rated wall assemblies, respectively, applied within annulus, flush with both surfaces of wall.

3M COMPANY – FB – 1000 NS, FB-3000 WT sealant

*Bearing the UL Classification Marking

Reprinted from the Online Certifications Directory with permission from Underwriters Laboratories Inc.
Copyright © 2010 Underwriters Laboratories Inc.®



System No. W-L-3148

May 19, 2005

F Ratings – 1 and 2 Hr (See Item 1)

T Ratings – 0 and 1/2 Hr (See Item 1)

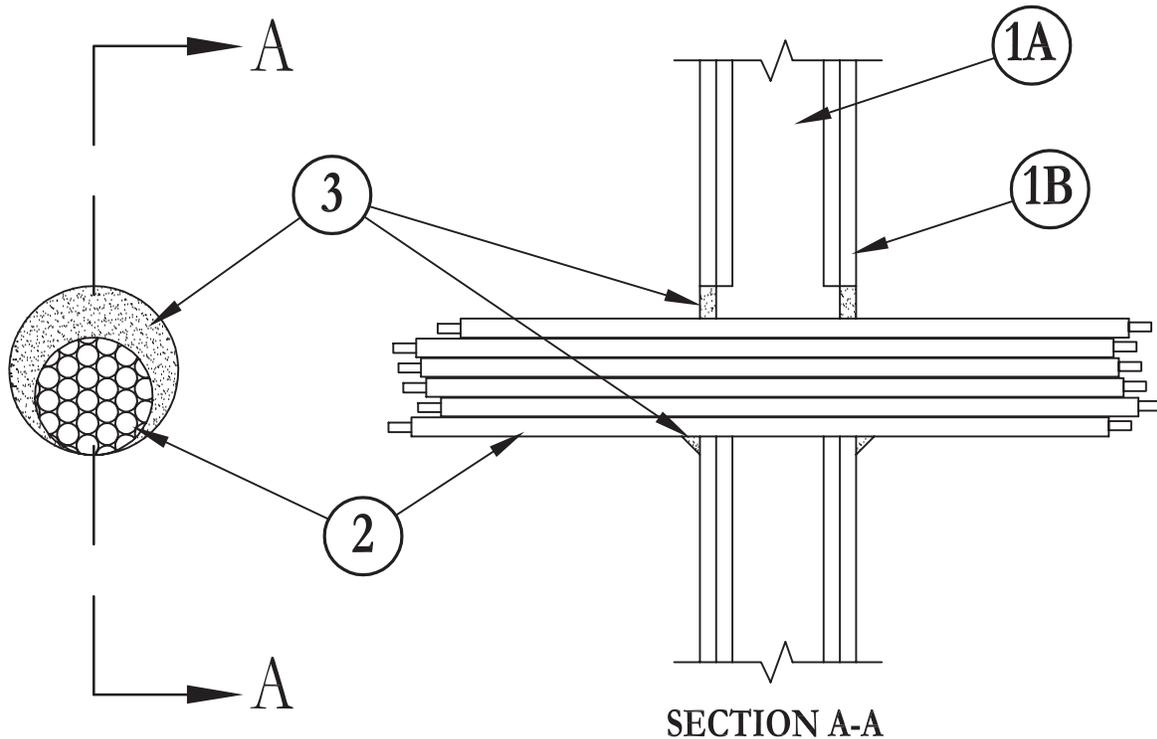

- Wall Assembly** – The 1 or 2 hr fire rated gypsum board/stud wall assembly shall be constructed of the materials and in the manner specified in the individual U300, U400 or V400 Series Wall and Partition Designs in the UL Fire Resistance Directory and shall include the following construction features:
 - Studs** – Wall framing may consist of either wood studs or steel channel studs. Wood studs to consist of nom 2 in. by 4 in. (51 mm by 102 mm) lumber spaced 16 in. (406 mm) OC. Steel studs to be min 3-1/2 in. (89 mm) wide and spaced max 24 in. (610 mm) OC.
 - Gypsum Board*** – Thickness, type, number of layers and fasteners as required in the individual Wall and Partition Design. Max diam of opening is 4-1/2 in. (114 mm).

The hourly F Rating of the firestop is equal to the hourly fire rating of the wall assembly in which it is installed. The T Ratings are 0 and 1/2 hr when installed in 1 and 2 hr rated walls, respectively.

- Cables** – Max 4 in. (102 mm) diam tight bundle of cables to be installed either concentrically or eccentrically within the opening. The annular space between the cable bundle and the periphery of the opening to be min 0 in. (point contact) to max 1/2 in. (0 mm to max 13 mm) Any combination of the following types and sizes of cables may be used:
 - Max 150 pair No. 24 AWG (or smaller) copper conductor with polyvinyl chloride (PVC) insulation and jacket.
 - Max 1/C 350 kcmil (or smaller) copper conductor cable with cross-linked polyethylene (XLPE) jacket.
 - Max 3/C No. 2/0 AWG (or smaller) aluminum or copper conductor cable with XLPE insulation and PVC jacket.
 - Max 7/C No. 12 AWG (or smaller) copper conductor cable with PVC insulation and jacket.
 - Max No. 18 AWG RG 6/U coaxial cable with PVC insulation and jacket.
 - Max 3/C with ground No. 12 AWG (or smaller) NM cable with PVC insulation and jacket.
 - Max 3/C No. 2/0 aluminum or copper SE cable with PVC insulation and jacket.
 - Max 3/C No. 2/0 (or smaller) copper conductor PVC jacketed aluminum clad or steel clad TEK cable.
- Fill, Void or Cavity Materials* – Caulk or Sealant** – Min 5/8 in. (16 mm) thickness of fill material applied within annulus, flush with each surface of wall. Min 5/8 in. (16 mm) thickness of fill material applied into interstices of cables on both sides of wall. Min 1/2 in. (13 mm) diam bead of caulk applied at the cable/wallboard interface to the point contact location on both sides of wall.

3M COMPANY – FireDam 150+, CP 25WB+, IC 15WB+ caulk or FB-3000 WT sealant

*Bearing the UL Classification Marking

Reprinted from the Online Certifications Directory with permission from Underwriters Laboratories Inc.

Copyright © 2010 Underwriters Laboratories Inc.®



System No. W-L-3149

May 19, 2005

F Ratings – 1 and 2 Hr (See Item 1)

T Ratings – 0 and 1/2 Hr (See Item 1)

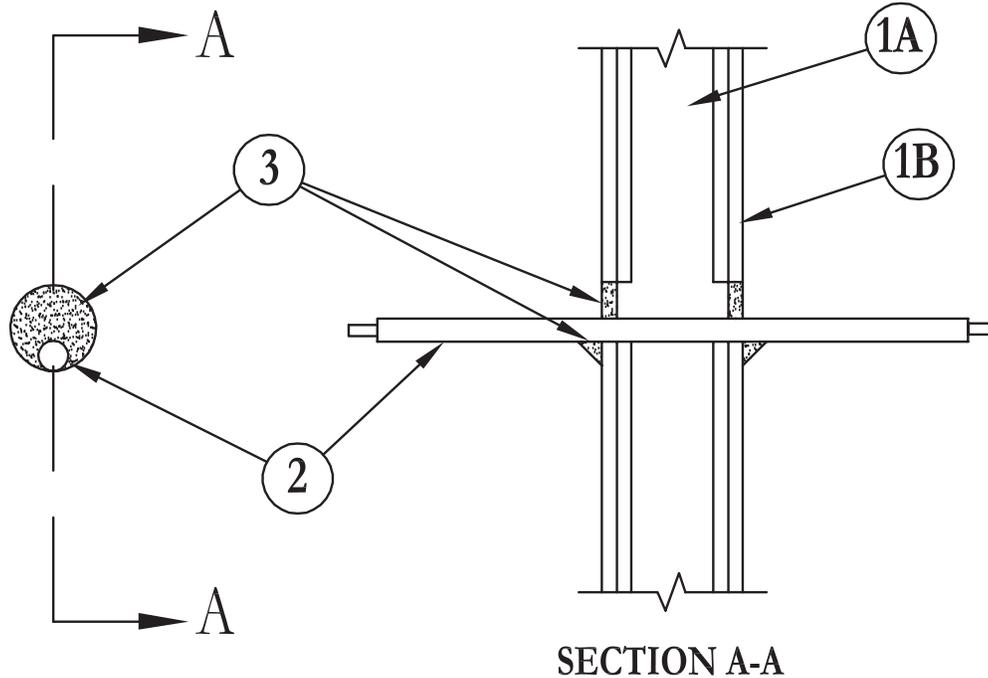

- Wall Assembly** – The 1 or 2 hr fire rated gypsum board/stud wall assembly shall be constructed of the materials and in the manner specified in the individual U300, U400 or V400 Series Wall and Partition Designs in the UL Fire Resistance Directory and shall include the following construction features:
 - Studs** – Wall framing may consist of either wood studs or steel channel studs. Wood studs to consist of nom 2 in. by 4 in. (51 mm by 102 mm) lumber spaced 16 in. (406 mm) OC. Steel studs to be min 3-1/2 in. (89 mm) wide and spaced max 24 in. (610 mm) OC.
 - Gypsum Board*** – Thickness, type, number of layers and fasteners as required in the individual Wall and Partition Design. Max diam of opening is 2 in. (51 mm).

The hourly F Rating of the firestop is equal to the hourly fire rating of the wall assembly in which it is installed. The T Ratings are 0 and 1/2 hr when installed in 1 and 2 hr rated walls, respectively.
- Cables** – Individual cable or max 1 in. (25 mm) diam cable bundle installed in through opening with an annular space of min 0 in. (point contact) to max 1 in. (0 mm to max 25 mm). Cables to be rigidly supported on both sides of wall assembly. Any of the following type and size of cables may be used:
 - Max 150 pair No. 24 AWG (or smaller) copper conductor with polyvinyl chloride (PVC) insulation and jacket.
 - Max 1-10/125 Fiber Optic (F.O.) cable, PVC insulation and jacket.
 - Max 3/C No. 2/0 AWG (or smaller) aluminum or copper conductor cable with XLPE insulation and PVC jacket.
 - Max No. 18 AWG RG 6/U coaxial cable with PVC insulation and jacket.
 - Max 3/C with ground No. 12 AWG (or smaller) NM cable with PVC insulation and jacket.
 - Max 3/C No. 2/0 aluminum or copper SER cable with PVC insulation and jacket.
 - Max 3/C No. 2/0 AWG (or smaller) copper conductor PVC jacketed aluminum clad or steel clad TEK cable.
- Fill, Void or Cavity Materials* – Caulk or Sealant** – Min 5/8 in. (16 mm) thickness of fill material applied within annulus, flush with both surfaces of the wall. Min 1/2 in. (13 mm) diam bead of caulk applied at the cable/wallboard interface at point contact location on both sides of wall.

3M COMPANY – FireDam 150+, CP 25WB+, IC 15WB+ caulk or FB-3000 WT sealant

*Bearing the UL Classification Marking

Reprinted from the Online Certifications Directory with permission from Underwriters Laboratories Inc.
Copyright © 2010 Underwriters Laboratories Inc.®



System No. W-L-3194

May 19, 2005

F Ratings – 1 & 2 Hr (See Item 1)

T Ratings – 0 & 1/2 Hr (See Item 1)

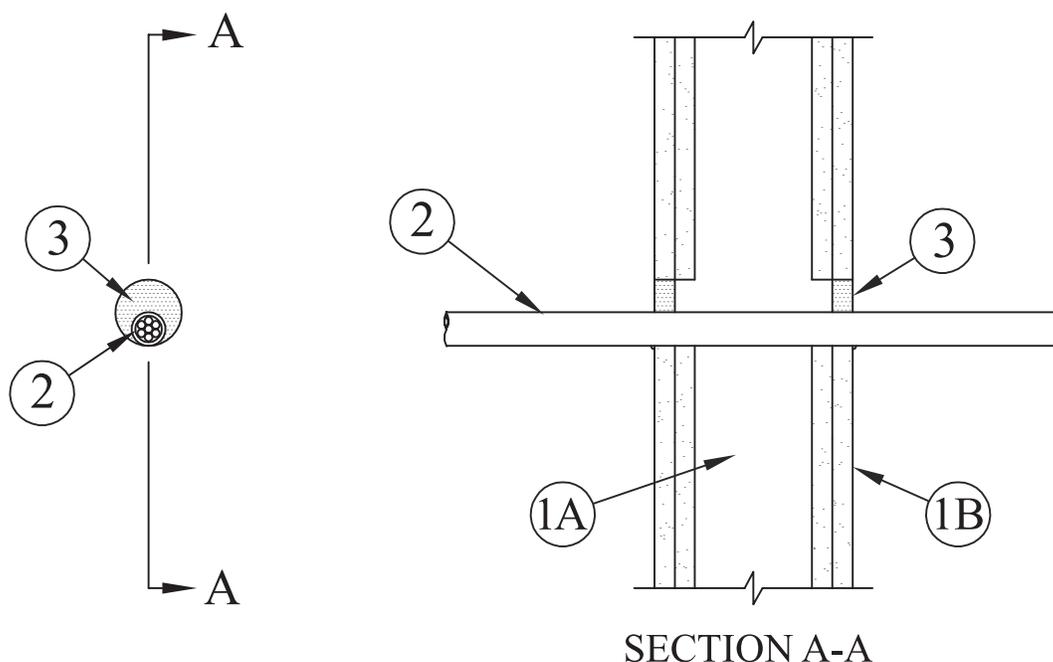

1. **Wall Assembly** – The 1 or 2 hr fire rated gypsum board/stud wall assembly shall be constructed of the materials and in the manner described in the individual U300, U400 or V400 Series Wall or Partition Design in the UL Fire Resistance Directory and shall include the following construction features:

A. **Studs** – Wall framing may consist of either wood studs or steel channel studs. Wood studs to consist of nom 2 in. by 4 in. (51 mm by 102 mm) lumber spaced 16 in. (406 mm) OC. Steel studs to be min 3-1/2 in. (89 mm) wide spaced max 24 in. (610 mm) OC.

B. **Gypsum Board*** – The gypsum board type, thickness, number of layers, fastener type and sheet orientation shall be as specified in the individual U300 or U400 Series Design in the UL Fire Resistance Directory. Max diam of opening is 2-1/2 in. (64 mm).

The hourly F Rating of the firestop system is equal to the hourly fire rating of the wall assembly in which it is installed. The hourly T Rating is 0 and 1/2 Hr for 1 and 2 Hr rated assemblies, respectively.

2. **Cable** – One cable installed eccentrically or concentrically within opening. Annular space between cable and periphery of opening to be min 0 in. (point contact) to max 1 in. (0 mm to max 25 mm). Cable to be rigidly supported on both sides of the wall. The following types and sizes of cable may be used:

A. Max 200 pair No. 22 AWG (or smaller) copper conductor with polyvinyl chloride (PVC) insulation and jacketing material.

B. Max 1/C No. 350 kcmil (or smaller) copper conductor cable with cross-linked polyethylene (XLPE) or PVC jacket.

C. Max 7/C No. 12 AWG (or smaller) copper conductor power and control cables with XLPE or PVC insulation with XLPE or PVC jacket.

D. Max 3/C No. 2/0 AWG (or smaller) copper or aluminum conductor SER cables with XLPE or PVC insulation and jacket.

E. Max 4/C No. 2/0 AWG (or smaller) copper conductor, aluminum clad or steel clad TECK 90 cable with or without PVC jacketed.

F. Max 110/125 fiber optic (F.O.) cable with PVC insulation and jacket.

G. Max 3/C with ground No. 8 AWG (or smaller) copper conductor NM cable with PVC insulation and jacket.

H. Max RG/U coaxial cable with fluorinated ethylene insulation and jacket.

I. Max 4 pair No. 24 AWG (or smaller) copper conductor data cable with Hylar jacket and insulation.

J. **Through Penetrating Product*** – Any cables, **Armored Cable+** or **Metal Clad Cable+** currently Classified under the **Through Penetrating Product** category.

See **Through Penetrating Product** (XHLY) category in the Fire Resistance Directory for names of manufacturers

3. **Fill, Void or Cavity Material*** – **Caulk or Sealant** – Min 5/8 in. (16 mm) thickness of caulk applied within annulus, flush with both surfaces of wall. Min 1/4 in. (6 mm) diam bead of caulk applied to gypsum board/cable interface at point contact location on both sides of wall.

3M COMPANY – IC 15WB+, CP 25WB+ caulk or FB-3000 WT sealant

*Bearing the UL Classification Marking

Reprinted from the Online Certifications Directory with permission from Underwriters Laboratories Inc.

Copyright © 2010 Underwriters Laboratories Inc.®



System No. W-L-3195

October 01, 2008

F Ratings – 1 and 2 Hr (See Item 1)

T Ratings – 0 and 1/2 Hr (See Item 1)

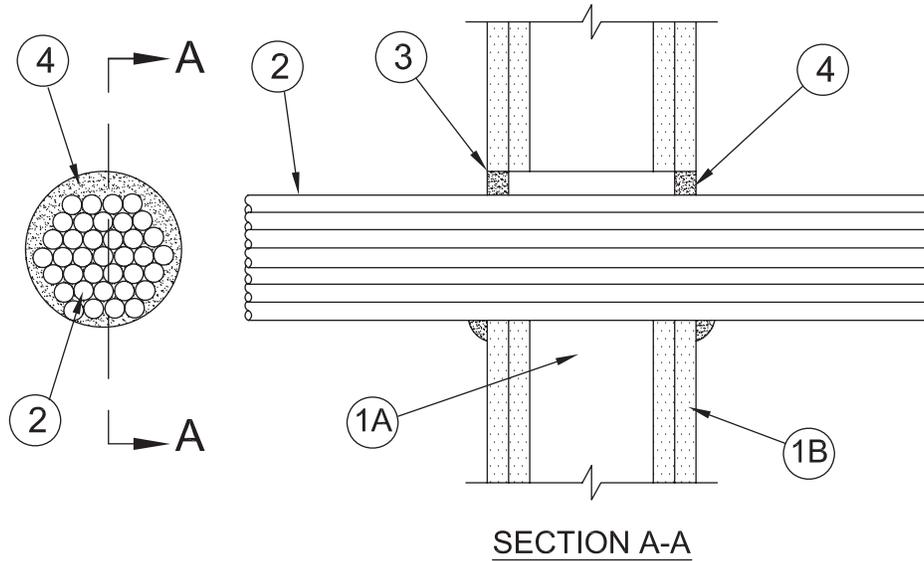

1. **Wall Assembly** – The 1 or 2 hr fire rated gypsum board/stud wall assembly shall be constructed of the materials and in the manner described in the individual U300, U400 or V400 Series Wall and Partition Design in the UL Fire Resistance Directory and shall include the following construction features:
 - A. **Studs** – Wall framing may consist of either wood studs or steel channel studs. Wood studs to consist of nom 2 by 4 in. (51 by 102 mm) lumber spaced 16 in. (406 mm) OC. Steel studs to be min 3-1/2 in. (89 mm) wide spaced max 24 in. (610 mm) OC.
 - B. **Gypsum Board*** – The gypsum board type, thickness, number of layers, fastener type and sheet orientation shall be as specified in the individual Design in the UL Fire Resistance Directory. Max diam of opening is 5 in. (127 mm).

The hourly F Rating of the firestop system is equal to the hourly fire rating of the wall assembly in which it is installed. The hourly T Rating is 0 and 1/2 Hr for 1 and 2 Hr fire rated assemblies, respectively.
2. **Steel Sleeve** – (Optional) - Cylindrical sleeve fabricated from min 0.018 in. (0.46 mm) thick (No. 28 gauge) galv sheet steel and having a min 1 in. (25 mm) lap along the longitudinal seam. Length of sleeve to be equal to or max 2 in. (51 mm) greater than the thickness of wall. Ends of sleeve to be flush with or extend a max 1 in. (25 mm) beyond each surface of wall.
3. **Cable** – Max 4 in. (102 mm) diam cable bundle installed eccentrically or concentrically within opening. Annular space between cable bundle and periphery of opening or sleeve to be min 0 in. (0 mm, point contact) to max 1 in. (25 mm). Cable bundle to be rigidly supported on both sides of wall. The following types and sizes of cables may be used:
 - A. Max 200 pair No. 22 AWG (or smaller) copper conductor with polyvinyl chloride (PVC) insulation and jacketing material.
 - B. Max 1/C No. 350 kcmil (or smaller) copper conductor cable with cross-linked polyethylene (XLPE) or PVC jacket.
 - C. Max 7/C No. 12 AWG (or smaller) copper conductor power and control cables with XLPE or PVC insulation with XLPE or PVC jacket.
 - D. Max 3/C No. 4/0 AWG (or smaller) copper or aluminum conductor SER cables with XLPE or PVC insulation and jacket.
 - E. Max 4/C No. 2/0 AWG (or smaller) copper conductor, aluminum clad or steel clad TECK 90 cable with or without PVC jacketed.
 - F. Max 110/125 fiber optic (F.O.) cable with PVC insulation and jacket.
 - G. Max 3/C with ground No. 8 AWG (or smaller) copper conductor NM cable with PVC insulation and jacket.
 - H. Max RG/U coaxial cable with fluorinated ethylene insulation and jacket.
 - I. Max 4 pair No. 24 AWG (or smaller) copper conductor data cable with Hylar jacket and insulation.
 - J. **Through Penetrating Product*** – Any cables, **Armored Cable+** or **Metal Clad Cable+** currently Classified under the **Through Penetrating Product** category.
See **Through Penetrating Product** (XHLY) category in the Fire Resistance Directory for names of manufacturers.
4. **Fill, Void or Cavity Material* – Caulk or Sealant** – Min 5/8 in. (16 mm) thickness of caulk applied within annulus, flush with both surfaces of wall. Min 1/4 in. (6 mm) diam bead of caulk applied to gypsum board/cable bundle interface at point contact location on both sides of wall.

3M COMPANY – IC 15WB+, CP 25WB+ caulk or FB-3000 WT sealant

*Bearing the UL Classification Mark

Reprinted from the Online Certifications Directory with permission from Underwriters Laboratories Inc.
Copyright © 2010 Underwriters Laboratories Inc.®



System No. W-L-3289

August 18, 2011

F Ratings – 1, 2, 3 and 4 Hr (See Item 1)

T Rating – 0 Hr

L Rating At Ambient - 4 to 7 CFM/sq ft (See Item 3B)

L Rating At 400 F - Less Than 1 CFM/sq ft (See Item 3B)

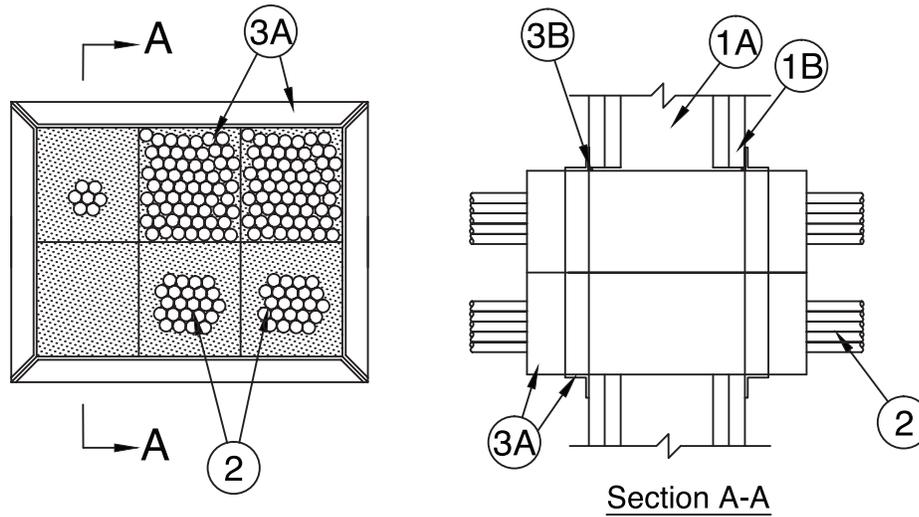

1. **Wall Assembly** – The 1, 2, 3 or 4 hr fire rated gypsum board/stud wall assembly shall be constructed of the materials and in the manner described in the individual U300, U400 or V400 Series Wall and Partition Design in the UL Fire Resistance Directory and shall include the following construction features:

- A. **Studs** – Wall framing may consist of either wood or steel channel studs. Wood studs to consist of nom 2 by 4 in. (51 by 102 mm) lumber spaced 16 in. (406 mm) OC. Steel studs to be min 3-1/2 in. (89 mm) wide spaced max 24 in. (610 mm) OC.
- B. **Gypsum Board*** – The gypsum board type, thickness, number of layers, fastener type and sheet orientation shall be as specified in the individual Wall and Partition Design in the UL Fire Resistance Directory. Max area of opening is 98.5 in.2 (635 cm2) with a max dimension of 12-1/8 in. (308 mm) for square devices. Max diam of opening is 2-1/4 in. (57 mm) for nom 2 in. (51 mm) round devices and 4-1/4 in. (108 mm) for 4 in. (102 mm) round devices.

The hourly F Rating of the firestop system is equal to the hourly fire rating of the wall assembly in which it is installed.

2. **Cables** – Within the loading area of each firestop device module the cables may represent a 0 to 100 percent visual fill. Cable bundles to be rigidly supported on both sides of wall assembly. Any combination of the following types and sizes of cables may be used:

- A. Max 2/C No. 18 AWG copper conductor thermostat cable with polyvinyl chloride (PVC) insulation and jacket materials.
- B. Max 4 pair No. 24 AWG copper conductor Cat5e or Cat 6 telephone cable with PVC insulation and jacket materials.
- C. Max RG/U (or smaller) coaxial cable with foam high density polyethylene insulation and PVC jacket materials.
- D. Max 3/C (with ground) No. 14 AWG (or smaller) nonmetallic sheathed (Romex) cable with PVC insulation and jacket materials.
- E. Max 1/C No. 8 AWG copper conductor cable with PVC insulation and nylon jacket materials.
- F. Max 12 core No. 26 AWG shielded multi coax cable with foam high density polyethylene insulation and PVC jacket.
- G. Max 48MM62.5 micron fiber optic cables with having a min FT-6 rating.
- H. Max 62.5/125 micron micron fiber optic cables with having a min Riser rating.
- I. Max 1/C 3/0 AWG copper conductor cable with PVC insulation and jacket materials.
- J. Max three copper conductors (with ground) No. 12 AWG **Metal Clad Cable+**.
- K. Max four copper conductors No. 2 AWG **Metal Clad Cable+**.

AFC CABLE SYSTEMS INC

- L. Max 1/C 2/0 AWG non halogen copper conductor cable.
- M. Max 300 pair No. 24 AWG copper conductor telephone cable with PVC insulation and jacket materials.
- N. Max 30 pair No. 22 copper conductor shielded switchboard cable with PVC insulation and jacket materials.
- O. Max RG/6 (or smaller) coaxial cable with fluorinated ethylene (FE) or PVC insulation and jacket materials.
- P. Max RG/U (or smaller) coaxial cable with fluorinated ethylene (FE) or PVC insulation and jacket materials.
- Q. Max 7/C No. 12 AWG copper conductors with PVC insulation and jacket materials.
- R. Max 4 pair No. 23 AWG copper conductor Cat 6 telephone cable with PVC insulation and jacket materials.
- S. Max three copper conductors (with ground) No. 12 AWG steel **Armored Cable+**.
- T. Max 04-02 2.5M fiber optic cables having a max diameter of 0.450 in. (11.4 mm).
- U. Max 1/C No. 750 kcmil copper conductors with PVC insulation and fabric jacket materials.
- V. Max 3/C with ground No. 4/0 AWG copper or aluminum conductor SER cable with cross linked polyethylene (XLPE) or PVC insulation and jacket.

Through Penetrations

Cables

3000 Series

Gypsum

WL

System No. W-L-3289 continued

Through Penetrations

Cables

3000 Series

Gypsum

W-L

3. **Firestop System** – The firestop system shall consist of the following:

A. **Firestop Device*** – A max of six square firestop devices may be ganged together for 1 and 2 hr rated assemblies. A max of three square firestop devices may be ganged together for 3 and 4 hr rated assemblies. As an alternate, one round device may be centered within a round opening. Each device consists of a nom 2-1/2 by 2-1/2 by 10 in. (64 by 64 by 254 mm), a nom 4 by 4 by 10 in. (102 by 102 by 254 mm) long, a nom 2 in. (51 mm) diam by 10 in. (254 mm) or a nom 4 in. (102 mm) diam by 10 in. (254 mm) long powder coated steel transit incorporating internal intumescent material, foam plugs and mounting flanges. Firestop device(s) to be installed within opening with ends projecting an equal distance beyond each surface of wall assembly in accordance with the accompanying installation instructions. The annular space between device(s) and periphery of opening shall be min 0 in. (0 mm, point contact) to max 1/8 in. (3 mm). Firestop device(s) secured in place by means of steel split mounting flanges sized to accommodate the firestop device. Steel split mounting flanges installed on both sides of wall and secured together with supplied steel set screws. Nom 1 in. (25 mm) thick pre-cut foam plugs sized to accommodate the cables and installed flush with each end of device on both sides of wall assembly. The foam plug in one or both ends of the device is optional except when L Rating is required (See Item 3B).

3M COMPANY – 3M Fire Barrier Pass-Through Device

B. **Fill, Void or Cavity Materials* – Putty or Caulk** – Min 1/8 in. (3 mm) bead of fill material shall be applied at interface of gypsum board and firestop devices immediately prior to the installation of the mounting flanges. If three or less devices (Item 3A) are ganged together, the fill material may be optional. As an option to attain L Ratings, foam plugs of firestop device modules shall be recessed into device to accommodate the required thickness of fill material. When annulus around firestop device module(s) is filled with putty or caulk and when both ends of each firestop device module are filled with a min 1/8 in. (3.2 mm) depth of putty or caulk flush with both ends of the devices, the following L Ratings apply:

| Max Percent Cable Fill In Device | L Rating At Ambient, CFM/sq ft (CFM/firestop device module) | L Rating At 400 F, CFM/sq ft (CFM/firestop device module) |
|----------------------------------|---|---|
| 0 | 4 (Less Than 1) | Less Than 1 (Less Than 1) |
| 50 | 7 (1) | Less Than 1 (Less Than 1) |

3M COMPANY – Moldable Putty+, CP 25WB+, IC 15WB+, 3000 WT

+ Bearing the UL Listing Mark

*Bearing the UL Classification Mark

Reprinted from the Online Certifications Directory with permission from UL
© 2012 UL LLC



System No. W-L-3321

October 01, 2008

F Ratings – 1 and 2 Hr (See Item 1)

T Rating – 0 Hr

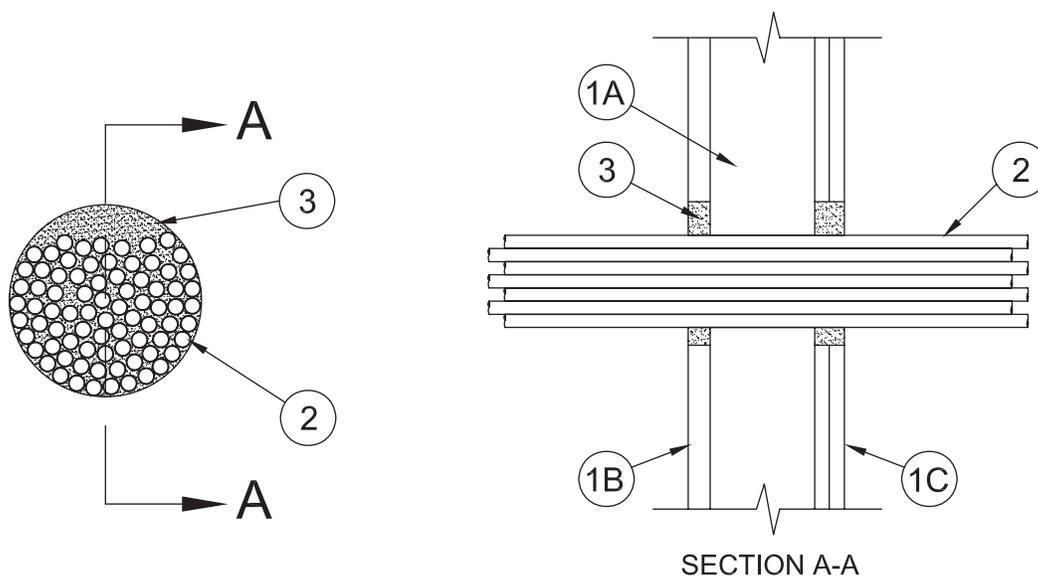

- Wall Assembly** – The 1 or 2 hr fire-rated gypsum board/stud shaft wall assembly shall be constructed of the materials and in the manner specified in the individual U400 or V400 Series Wall and Partition Designs in the UL Fire Resistance Directory and shall incorporate the following construction features:
 - Steel Studs** – “C-H” or “C-T” shaped studs, min 2-1/2 in. (64 mm) wide by 1-1/2 in. (38 mm) deep, fabricated from min No. 25 gauge (0.6 mm thick) galv steel, spaced max 24 in. (610 mm) OC.
 - Gypsum Board*** – 1 in. (25 mm) thick, 24 in. (610 mm) wide gypsum liner panels installed vertically. Max diam of circular cutout in gypsum liner panel is 4-1/2 in. (114 mm).
 - Gypsum Board*** – 1/2 in. or 5/8 in. (13 or 16 mm) thick, 48 in. (1.2 m) wide gypsum boards. The gypsum board type, thickness, number of layers, fastener type and sheet orientation shall be as specified in the individual Wall and Partition Design. Max diam of circular cutout in gypsum board is 4-1/2 in. (114 mm).

The hourly F Rating of the firestop system is equal to the hourly fire rating of the wall assembly in which it is installed.

- Cables** – Max 4 in. diam tight bundle of cables installed eccentrically or concentrically in opening. The annular space between the bundled cables and the periphery of the opening to be min 0 in. (point contact) to max 1/2 in. (13 mm). Cables may or may not be routed through flexible steel conduit with or without vinyl coating. Cables to be rigidly supported on both sides of wall assembly. Any combination of the following types and sizes of cables may be used:
 - Max 150 pair No. 24 AWG (or smaller) copper conductor with polyvinyl chloride (PVC) insulation and jacket.
 - Max 1/C 350 kcmil (or smaller) copper conductor cable with cross-linked polyethylene (XLPE) jacket.
 - Max 3/C No. 4/0 AWG (or smaller) aluminum or copper conductor SER cable with XLPE or PVC insulation and jacket.
 - Max 7/C No. 12 AWG (or smaller) copper conductor cable with PVC insulation and jacket.
 - Max No. 18 AWG RG 6//U coaxial cable with PVC insulation and jacket.
 - Max 3/C with ground No. 12 AWG (or smaller) NM cable with PVC insulation and jacket.
 - Through Penetrating Product*** – Max 3/C No. 2 AWG (or smaller) aluminum or steel clad Armored Cable* or aluminum or steel clad Metal Clad Cable* with copper conductors.

ALFLEX CORP

- Fill, Void or Cavity Materials* – Caulk or Sealant** – Caulk or sealant applied within annulus at a thickness equal to the total thickness of the gypsum board on both sides of the wall. Fill material forced into grouped cable interstices to max extent possible. At the point contact location, a min 1/4 in. (6 mm) diam bead of fill material shall be applied at the cable bundle/sleeve interface

3M COMPANY – CP 25WB+ caulk or FB-3000 WT sealant

*Bearing the UL Classification Mark

Reprinted from the Online Certifications Directory with permission from Underwriters Laboratories Inc.
Copyright © 2010 Underwriters Laboratories Inc.®



Through Penetrations

Cables

3000 Series

Gypsum

WL

System No. W-L-3336

September 20, 2011

ANSI/UL1479 (ASTM E814)

F Ratings – 1 and 2 Hr (See Item 1)

T Rating – 0 Hr

CAN/ULC S115

F Ratings – 1 and 2 Hr (See Item 1)Hr

FT Rating – 0 Hr

FH Ratings – 1 and 2 Hr (See Item 1)Hr

FTH Rating – 0 Hr

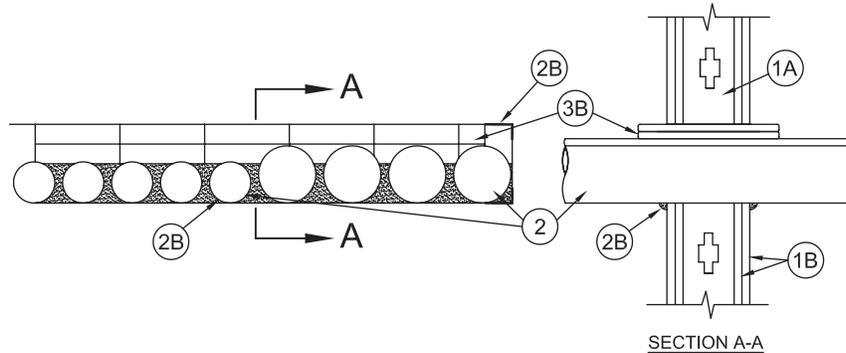

- Wall Assembly** – The 1 or 2 hr fire-rated gypsum board/stud wall assembly shall be constructed of the materials and in the manner specified in the individual U300 or U400 Series Wall or Partition Designs in the UL Fire Resistance Directory and shall include the following construction features:

- Studs** – Wall framing may consist of either wood studs or steel channel studs. Wood studs to consist of nom 2 by 4 in. (51 by 102 mm) lumber spaced 16 in. (406 mm) OC. Steel studs to be min 3-5/8 in. (92 mm) wide spaced max 24 in. (610 mm) OC. Additional framing members shall be used to completely frame around opening.
- Gypsum Board*** – Thickness, type, number of layers and fasteners as required in the individual Wall and Partition Design. Max area of opening is 225 sq in. (1452 sq cm) with a max dimension of 22-1/2 in. (572 mm).

The hourly F and FH Ratings for the firestop system are equal to the hourly fire rating of the wall assembly in which it is installed.

- Cable** – Aggregate cross-sectional area of cables in opening to be max 49 percent of the cross-sectional area inside the opening installed either concentrically or eccentrically within the firestop system. The annular space between cable and periphery of opening shall be min 0 in. (0 mm) (point contact) to max 4 in. (102 mm). The horizontal space between cable shall be min 1/4 in. (6 mm) to max 4 in. (102 mm). The vertical space between cable shall be min 1-1/2 in. (38 mm) to max 4 in. (102 mm). Cable to be rigidly supported on both sides of wall assembly. Any combination of the following types and sizes of cable may be used:
 - Max 200 pair No. 22 AWG (or smaller) copper conductor with polyvinyl chloride (PVC) insulation and jacketing material.
 - Max 1/C No. 750 kcmil (or smaller) copper conductor cable with cross-linked polyethylene (XLPE) jacket.
 - Max 7/C No. 12 AWG (or smaller) copper conductor power and control cables with XLPE or PVC insulation with XLPE or PVC jacket.
 - Max 3/C No. 3/0 AWG (or smaller) copper or aluminum conductor SER cables with PVC insulation and jacket.
 - Max 3/C No. 2/0 AWG (or smaller) copper conductor PVC jacketed aluminum clad or steel clad TECK 90 cable.
 - Max 110/125 fiber optic (F.O.) cable with PVC insulation and jacket.
 - Max 3/C with ground No. 8 AWG (or smaller) copper conductor NM cable with PVC insulation and jacket.
 - RG/U coaxial cable with fluorinated ethylene (FE) or PVC insulation and jacket.
 - Max 4 pair No. 24 AWG (or smaller) copper conductor data cable with Hylar jacket and insulation.
 - Max three conductor No. 12 AWG (or smaller) MC (BX) copper cable with polyvinyl chloride insulation and jacket materials.
 - Through Penetrating Product*** – Any cables, **Armored Cable+** or **Metal Clad Cable+** currently Classified under the Through Penetrating Product category.
See **Through Penetrating Product** (XHLY) category in the Fire Resistance Directory for names of manufacturers.

- Firestop System** – The firestop system shall consist of the following:
 - Fill Void or Cavity Material* – Caulk, Sealant or Putty** – Min 1/2 in. (13 mm) thickness of caulk or putty formed to a min 1 in. (25 mm) width and applied within annulus at all corners of opening and extending a min 1 in. (25 mm) in both directions from each corner, flush with both surfaces of wall. Min 1/4 in. (6 mm) thickness, min 2 in. (51 mm) width of caulk or putty wrapped applied around each penetrant such that caulk or putty extends approximately 1/2 in. (51 mm) beyond both surfaces of wall. After installation of pillows (Item 4B) all voids within the opening shall be filled with a min 1 in. (25 mm) thickness of caulk or putty.

3M COMPANY**3M FIRE PROTECTION PRODUCTS** – MPS-2+ or CP 25 WB+ or FB-3000 WT

- Fill Void or Cavity Material* – Pillows** – Max 9 in. (229 mm) long by 6 in. (152 mm) wide by 2 and 3 in. (51 and 76 mm) thick plastic covered pillows tightly-packed to fill annular space between penetrants and periphery of opening. Pillows installed with 9 in. (229 mm) dimension projecting through wall and centered within the opening.

3M COMPANY**3M FIRE PROTECTION PRODUCTS** – Fire Barrier Pillow or Fire Barrier Self-Locking Pillows

*Bearing the UL Classification Mark

Reprinted from the Online Certifications Directory with permission from Underwriters Laboratories Inc.

Copyright © 2011 Underwriters Laboratories Inc.®



System No. W-L-3337

June 28, 2010

F Ratings – 1 and 2 Hr (See Item 1)

T Rating – 0 Hr

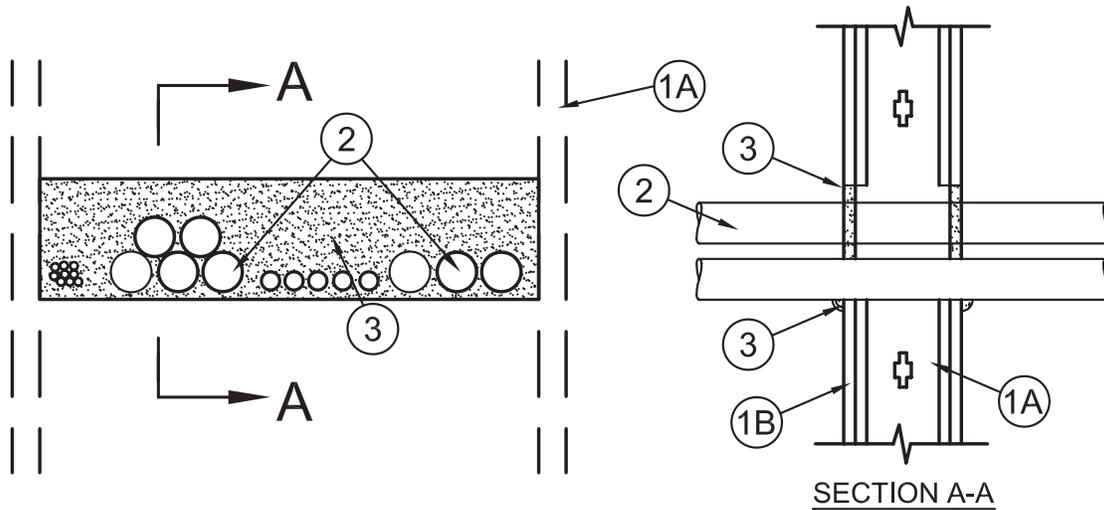

- Wall Assembly** – The 1 or 2 hr fire rated gypsum board/stud wall assembly shall be constructed of the materials and in the manner described in the individual U400 or V400 series Wall and Partition Design in the UL Fire Resistance Directory and shall include the following construction features:

- Studs** – Wall framing shall consist of min 3-5/8 in. (92 mm) wide steel channel studs spaced max 24 in. (610 mm) OC.
- Gypsum Board*** – Thickness, type, number of layers and fasteners shall be as specified in the individual U400 or V400 series Wall and Partition Design in the UL Fire Resistance Directory. Max area of opening is 67-1/2 sq. in. (435 sq cm) with max dimension of 22-1/2 in. (572 mm).

The hourly F Rating of the firestop system is equal to the hourly fire rating of the wall assembly in which it is installed.

- Cable** – Aggregate cross-sectional area of cables in opening to be max 49 percent of the cross-sectional area inside the opening installed either concentrically or eccentrically within the firestop system. The annular space between cable and periphery of opening shall be min 0 in. (0 mm, point contact) to max 1-1/4 in. (32 mm). The horizontal space between cable shall be min 1/4 in. (6 mm) to max 1 in. (25 mm). Cable to be rigidly supported on both sides of wall assembly. Any combination of the following types and sizes of cable may be used:

- Max 200 pair No. 22 AWG (or smaller) copper conductor with polyvinyl chloride (PVC) insulation and jacketing material.
- Max 1/C No. 750 kcmil (or smaller) copper conductor cable with cross-linked polyethylene (XLPE) jacket.
- Max 7/C No. 12 AWG (or smaller) copper conductor power and control cables with XLPE or PVC insulation with XLPE or PVC jacket.
- Max 3/C No. 3/0 AWG (or smaller) copper or aluminum conductor SER cables with PVC insulation and jacket.
- Max 3/C No. 2/0 AWG (or smaller) copper conductor PVC jacketed aluminum clad or steel clad TECK 90 cable.
- Max 110/125 fiber optic (F.O.) cable with PVC insulation and jacket.
- Max 3/C with ground No. 8 AWG (or smaller) copper conductor NM cable with PVC insulation and jacket.
- RG/U coaxial cable with fluorinated ethylene (FE) or PVC insulation and jacket.
- Max 4 pair No. 24 AWG (or smaller) copper conductor data cable with Hylar jacket and insulation.
- Max three conductor No. 12 AWG (or smaller) MC (BX) copper cable with polyvinyl chloride insulation and jacket materials.
- Through Penetrating Product*** – Any cables, **Armored Cable+** or **Metal Clad Cable+** currently Classified under the Through Penetrating Product category.

See **Through Penetrating Product** (XHLY) category in the Fire Resistance Directory for names of manufacturers.

- Fill, Void or Cavity Material* – Caulk or Sealant** – Min 5/8 in. (16 mm) thickness of fill material applied within the annulus, flush with both surfaces of wall. Min 1/2 in. (13 mm) diam bead of caulk applied to the penetrant/gypsum board interface at the point contact location on both sides of wall.

3M COMPANY

3M FIRE PROTECTION PRODUCTS – CP 25WB+, FireDam 150+, IC 15WB+ caulk or FB-3000 WT sealant

*Bearing the UL Classification Mark

Reprinted from the Online Certifications Directory with permission from Underwriters Laboratories Inc.
Copyright © 2011 Underwriters Laboratories Inc.®



Through Penetrations

Cables

3000 Series

Gypsum

WL

System No. W-L-3338

September 12, 2007

F Ratings – 1 and 2 Hr (See Item 1)

T Rating – 0 Hr

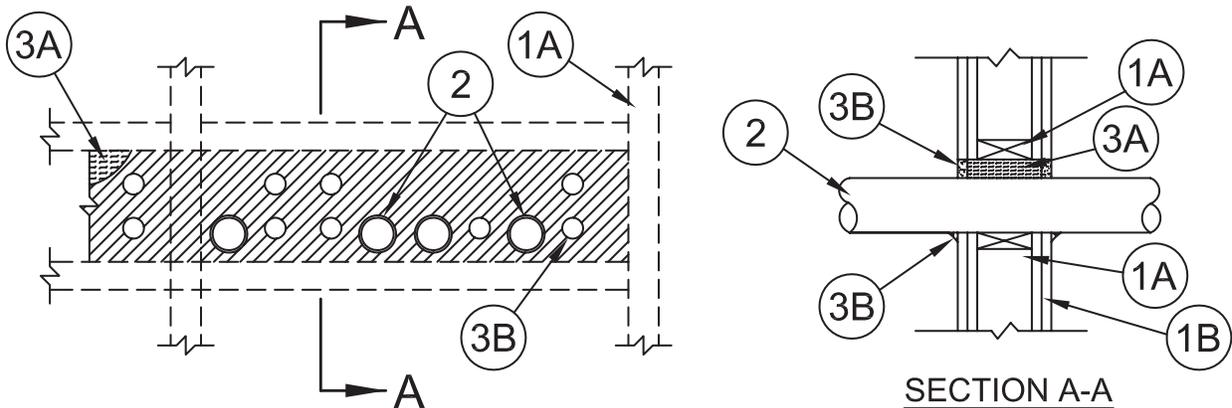

1. **Wall Assembly** – The 1 or 2 hr fire rated gypsum board/stud wall assembly shall be constructed of the materials and in the manner described in the individual U400 or V400 Series Wall and Partition Design in the UL Fire Resistance Directory and shall include the following construction features:

- A. **Studs** – Wall framing shall consist of min 3-1/2 in. (89 mm) wide steel channel studs spaced max 24 in. (610 mm) OC. Additional min 3-1/2 in. (89 mm) wide steel studs shall be used to completely frame opening.
- B. **Gypsum Board*** – The gypsum board type, thickness, number of layers, fastener type and sheet orientation shall be as specified in the individual U400 or V400 Series Design in the UL Fire Resistance Directory. Max area of opening to be 182 in.² (1174 cm²) with a max dimension of 45-1/2 in. (156 mm). All vertical studs in opening to remain intact.

The hourly F Rating of the firestop system is equal to the hourly fire rating of the wall assembly in which it is installed.

2. **Cable** – Aggregate cross-sectional area of cables in opening to be max 49 percent of the cross-sectional area inside the opening installed either concentrically or eccentrically within the firestop system. The annular space between cable and periphery of opening shall be min 0 in. (0 mm) (point contact) to max 2 in. (51 mm). The horizontal space between cable shall be min 1/4 in. (6 mm) to max 2 in. (51 mm). Cable to be rigidly supported on both sides of wall assembly. Any combination of the following types and sizes of cable may be used:

- A. Max 200 pair No. 22 AWG (or smaller) copper conductor with polyvinyl chloride (PVC) insulation and jacketing material.
- B. Max 1/C No. 750 kcmil (or smaller) copper conductor cable with cross-linked polyethylene (XLPE) jacket.
- C. Max 7/C No. 12 AWG (or smaller) copper conductor power and control cables with XLPE or PVC insulation with XLPE or PVC jacket.
- D. Max 3/C No. 3/0 AWG (or smaller) copper or aluminum conductor SER cables with PVC insulation and jacket.
- E. Max 3/C No. 2/0 AWG (or smaller) copper conductor PVC jacketed aluminum clad or steel clad TECK 90 cable.
- F. Max 110/125 fiber optic (F.O.) cable with PVC insulation and jacket.
- G. Max 3/C with ground No. 8 AWG (or smaller) copper conductor NM cable with PVC insulation and jacket.
- H. RG/U coaxial cable with fluorinated ethylene (FE) or PVC insulation and jacket.
- I. Max 4 pair No. 24 AWG (or smaller) copper conductor data cable with Hylar jacket and insulation.
- J. Max three conductor No. 12 AWG (or smaller) MC (BX) copper cable with polyvinyl chloride insulation and jacket materials.

- K. **Through Penetrating Product*** – Any cables, **Armored Cable**+ or **Metal Clad Cable**+ currently Classified under the Through Penetrating Product category.

See **Through Penetrating Product** (XHLY) category in the Fire Resistance Directory for names of manufacturers.

3. **Firestop System** – The firestop system shall consist of the following:

- A. **Packing Material** – Min 3-3/4 in. (95 mm) or 5 in. (127 mm) thickness of min 4 pcf (64 kg/m³) mineral wool batt insulation firmly packed into opening for 1 and 2 hr rated assemblies, respectively. Packing material to be recessed from both sides of wall assembly to accommodate the required thickness of fill material.
- B. **Fill, Void or Cavity Material* – Caulk or Sealant** – Min 1/2 in. (13 mm) thickness of caulk applied within annulus, flush with both surfaces of wall. Min 1/4 in. (6 mm) diam bead of caulk applied to gypsum board/penetrant interface at point contact location on both sides of wall.

3M COMPANY – IC 15WB+, CP 25WB+ caulk or FB-3000 WT sealant

*Bearing the UL Classification Mark

Reprinted from the Online Certifications Directory with permission from Underwriters Laboratories Inc.
Copyright © 2010 Underwriters Laboratories Inc.®



System No. W-L-3347
 September 30, 2013
 F Ratings – 1 and 2 Hr (See Item 1)
 T Rating – 0 Hr

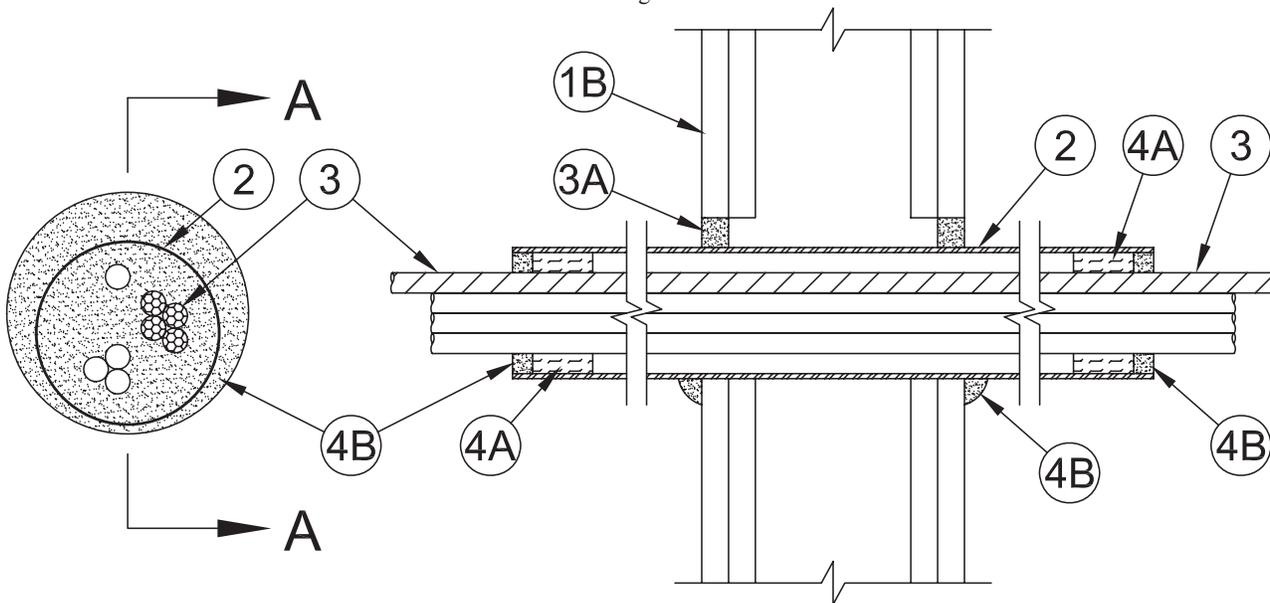

SECTION A-A

1. **Wall Assembly** – The 1 or 2 hr fire rated gypsum board/stud wall assembly shall be constructed of the materials and in the manner specified in the individual U300 or U400 Series Wall and Partition Designs in the UL Fire Resistance Directory and shall include the following construction features:

- A. **Studs** – Wall framing may consist of either wood studs or steel channel studs. Wood studs to consist of nom 2 by 4 in. (51 by 102 mm) lumber spaced 16 in. (406 mm) OC. Steel studs to be min 2-1/2 in. (64 mm) wide and spaced max 24 in. (610 mm) OC.
- B. **Gypsum Board*** – 5/8 in. (16 mm) thick, The gypsum board type, thickness, number of layers, fastener type and sheet orientation shall be as specified in the individual U300 or U400 Series Design in the UL Fire Resistance Directory. Max diam of opening is 6-1/2 in. (165 mm)

The hourly F Rating of the firestop system is equal to the hourly fire rating of the wall assembly in which it is installed.

2. **Steel Sleeve** – Nom 6 in. (152 mm) diam (or smaller) steel electrical metallic tubing (EMT) or Schedule 5 steel pipe. The annular space between steel sleeve and periphery of opening shall be min 0 in. (point contact) to max 1/2 in. (13mm) Sleeve may extend up to 18 in. (457 mm) beyond each surface of the wall.

3. **Cables** – Aggregate cross-sectional area of cables in steel sleeve to be max 50 percent of the aggregate cross-sectional area of the sleeve. Cables to be rigidly supported on both sides of wall assembly. The annular space between cables and periphery of sleeve shall be min 0 in. (point contact) to max 1/2 in. (13mm) The annular space between cables shall be min 0 in. (point contact) to max 1 in. (25mm). Any combination of the following types and sizes of cables may be used:

- A. Max 300 pair No. 24 AWG (or smaller) copper conductor with polyvinyl chloride (PVC) insulation and jacket.
- B. Max 1-10/125 Fiber Optic (F.O.) cable, PVC insulation and jacket.
- C. Max 3/C No. 2/0 AWG (or smaller) aluminum or copper conductor cable with XLPE insulation and PVC jacket.
- D. Max 7/C No. 12 AWG (or smaller) copper conductor cable with PVC insulation and jacket.
- E. Max No. 18 AWG RG 6/U coaxial cable with PVC insulation and jacket.
- F. Max 4 Pair No 22 AWG (or smaller) Cat 6 copper conductor with PVC insulation and jacket
- G. Max 3/C No. 2/0 aluminum or copper SE cable with PVC insulation and jacket.
- H. Max four aluminum conductor No. 10 AWG (or smaller) aluminum or steel, Armored cable# or Metal-Clad Cable+.

AFC CABLE SYSTEMS INC – MC Lite

4. **Firestop System** – The firestop system shall consist of the following:

- A. **Packing Material** – Min 2 in. (51 mm) thickness of min 4 pcf (64 kg/m³) mineral wool batt insulation firmly packed into each end of sleeve as a permanent form. Packing material to be recessed from each end of sleeve to accommodate the required thickness of fill material.
- B. **Fill, Void or Cavity Material* – Sealant or Putty** – Sealant or Putty – Min 5/8 in. (16 mm) thickness of fill material applied within the annulus, flush with both sides of wall. At point contact, a min 1/2 in. (13mm) bead of fill material shall be applied at sleeve/wall interface on both sides of wall when sleeve extends beyond surface of wall. Min 1/2 in. (13 mm) thickness of fill material applied within the sleeve, flush with both ends. Min 1/2 in. (13 mm) thickness of fill material applied within the interstices of the cable bundles.

3M COMPANY

3M FIRE PROTECTION PRODUCTS – IC 15WB+, CP 25WB+ or FB-3000 WT

System No. W-L-3347 *continued*

- C. **Fill, Void or Cavity Material*** – (Not Shown) - As an alternate to Item 4B above, min 5/8 in. (16 mm) thickness of fill material applied within the annulus, flush with both sides of the wall. At point contact, a min. 1/2 in. (13 mm) bead of fill material at sleeve/wall interface on both sides of both sides of wall when sleeve extends beyond surface of the wall. Min. 2-1/2 in. (63 mm) thickness of fill material applied within the sleeve, flush with both ends. Foam to be injected into the interstices between all cables. When this fill material is used, item 4A is not required.

3M COMPANY – Fire Barrier rated Foam, FIP 1 - Step

*Bearing the UL Classification Mark

+Bearing the UL Listing Mark

Reprinted from the Online Certifications Directory with permission from UL
© 2013 UL LLC



Through Penetrations

Cables

3000 Series

Gypsum

W-L

System No. W-L-3371

October 11, 2011

ANSI/UL1479 (ASTM E814)

F Ratings – 1 and 2 Hr (See Item 1)

T Rating – 1/2 Hr

CAN/ULC S115

F Ratings – 1 and 2 Hr (See Item 1)

FT Rating – 1/2 Hr

FH Ratings – 1 and 2 Hr (See Item 1)

FTH Rating – 1/2 Hr

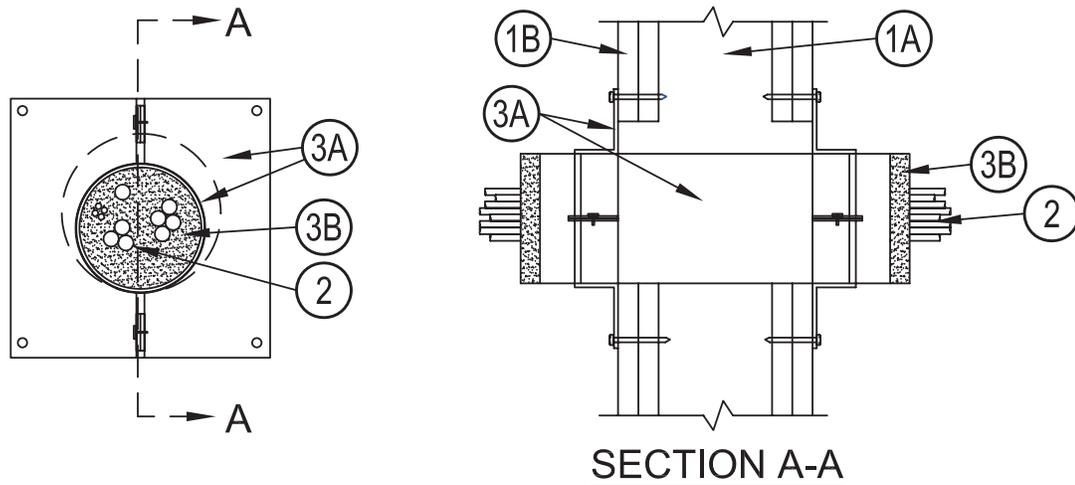

1. **Wall Assembly** – The 1 or 2 hr fire rated gypsum board/stud wall assembly shall be constructed of the materials and in the manner specified in the individual U300, U400, V400 or W400 Series Wall and Partition Designs in the UL Fire Resistance Directory and shall include the following construction features:
 - A. **Studs** – Wall framing may consist of either wood studs or steel channel studs. Wood studs to consist of nom 2 by 4 in. (51 by 102 mm) lumber spaced 16 in. (406 mm) OC. Steel studs to be min 3-1/2 in. (89 mm) wide and spaced max 24 in. (610 mm) OC.
 - B. **Gypsum Board*** – 5/8 in. (16 mm) thick, The gypsum board type, thickness, number of layers, fastener type and sheet orientation shall be as specified in the individual U300, U400, V400 or W400 Series Design in the UL Fire Resistance Directory. Max diam of opening is 6-1/2 in. (165 mm)

The hourly F and FH Ratings of the firestop system are equal to the hourly fire rating of the wall assembly in which it is installed.
2. **Cables** – Aggregate cross-sectional area of cables in steel sleeve to be max 48 percent of the aggregate cross-sectional area of the sleeve. The annular space between cables and periphery of sleeve and the annular space between cables shall be min 0 in. (point contact) to max 2 in. (51mm). Cables to be rigidly supported on both sides of wall assembly. Any combination of the following types and sizes of cables may be used:
 - A. Max 400 pair No. 24 AWG (or smaller) copper conductor with polyvinyl chloride (PVC) insulation and jacketing material.
 - B. Max 1/C No. 750 kcmil (or smaller) copper conductor cable with cross-linked polyethylene (XLPE) jacket.
 - C. Max 7/C No. 12 AWG (or smaller) copper conductor power and control cables with XLPE or PVC insulation with XLPE or PVC jacket.
 - D. Max 3/C No. 4/0 AWG (or smaller) copper or aluminum conductor SER cables with PVC insulation and jacket.
 - E. Max 110/125 fiber optic (F.O.) cable with PVC insulation and jacket.
 - F. Max 3/C with ground No. 8 AWG (or smaller) copper conductor NM cable with PVC insulation and jacket.
 - G. Max No. 18 AWG RG/U coaxial cable with fluorinated ethylene (FE) or PVC insulation and jacket.
 - H. Max 4 pair No. 24 AWG (or smaller) copper conductor data cable with Hylar jacket and insulation.
 - I. Max 4 Pair No 22 AWG (or smaller) Cat 6 copper conductor with PVC insulation and jacket.
 - J. Max 3/C No. 2/0 AWG (or smaller) aluminum or copper conductor cable with XLPE insulation and PVC jacket.
 - K. Max 3/C No. 2/0 aluminum or copper SE cable with PVC insulation and jacket.
 - L. Max three conductor No. 12 AWG (or smaller) MC (BX) copper cable with polyvinyl chloride insulation and jacket materials.
 - M. **Through Penetrating Product*** – Any cables, **Armored Cable+** or **Metal Clad Cable+** currently Classified under the **Through Penetrating Product** category.

See **Through Penetrating Product** (XHLY) category in the Fire Resistance Directory for names of manufacturers.
3. **Firestop System** – The firestop system shall consist of the following:
 - A. **Firestop Device*** – One firestop device module centered within the opening. The firestop device module consists of a 12 in. (305 mm) long galv steel split sleeve with galv steel flange plates. Firestop device module to be installed in accordance with the accompanying installation instructions. The space between the firestop device module and the periphery of the opening shall be min 0 in. (point contact) to max 1 in. (25 mm). Firestop device module secured in place by means of steel flange plates sized to accommodate the firestop device

System No. W-L-3371 *continued*

module.. Steel flange plate installed on both sides of wall and secured around firestop device module with steel screws. The steel flange plate is then secured to the wall with the supplied drywall screws. The firestop device module is to be installed with its ends projecting an equal distance beyond each surface of the wall assembly.

3M COMPANY

3M FIRE PROTECTION PRODUCTS – 3M Fire Barrier Putty Sleeve Kit DT 100, DT 200 or DT 400

- B. **Fill, Void or Cavity Material*** – After the installation of the cables (Item 2) the supplied putty material is to be packed into each end of the firestop device with care taken to fill the interstices between the cables. A minimum 1 in. (25mm) depth of the putty material is required at each end of device.

3M COMPANY

3M FIRE PROTECTION PRODUCTS – 3M Fire Barrier MP+ Putty Stix

- C. **Packing Material** – (Not Shown. Required for installation only on DT 400 with cable fill of less than 28 percent. Optional on DT 100 and DT200 assemblies.) – Min 2 in. (51 mm) thickness of min 4 pcf (64 kg/m³) mineral wool batt insulation firmly packed into each end of sleeve (Item 3A) as a permanent form. Packing material to be recessed from each end of sleeve to accommodate the required thickness of fill material.

*Bearing the UL Classification Mark

+Bearing the UL Listing Mark

Reprinted from the Online Certifications Directory with permission from UL
© 2012 UL LLC



Through Penetrations

Cables

3000 Series

Gypsum

WL

System No. W-L-3372

October 11, 2011

ANSI/UL1479 (ASTM E814)

F Ratings – 3 and 4 Hr (See Item 1)

T Rating – 1/2 Hr

CAN/ULC S115

F Ratings – 3 and 4 Hr (See Item 1)

FT Rating – 1/2 Hr

FH Ratings – 3 and 4 Hr (See Item 1)

FTH Rating – 1/2 Hr

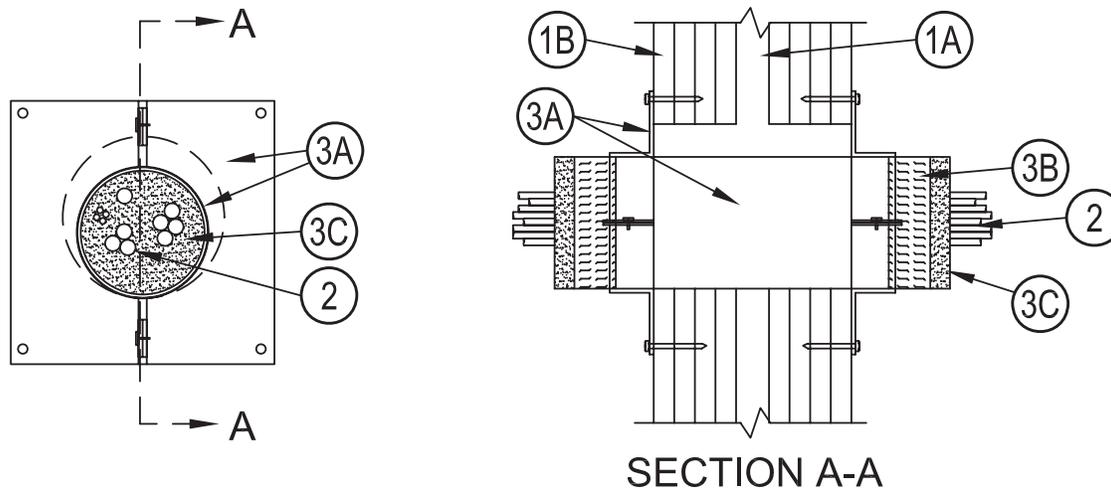

- Wall Assembly** – The 3 or 4 hr fire rated gypsum board/stud wall assembly shall be constructed of the materials and in the manner specified in the individual U400, V400 or W400 Series Wall and Partition Designs in the UL Fire Resistance Directory and shall include the following construction features:

- Studs** – Wall framing shall consist of steel channel studs. Steel studs to be min 3-1/2 in. (89 mm) wide and spaced max 24 in. (610 mm) OC.
- Gypsum Board*** – 5/8 in. (16 mm) thick, The gypsum board type, thickness, number of layers, fastener type and sheet orientation shall be as specified in the individual U400, V400 or W400 Series Design in the UL Fire Resistance Directory. Max diam of opening is 6-1/2 in. (165 mm)

The hourly F and FH Ratings of the firestop system are equal to the hourly fire rating of the wall assembly in which it is installed.

- Cables** – Aggregate cross-sectional area of cables in steel sleeve to be max 48 percent of the aggregate cross-sectional area of the sleeve. The annular space between cables and periphery of sleeve and the annular space between cables shall be min 0 in. (point contact) to max 2 in. (51mm). Cables to be rigidly supported on both sides of wall assembly. Any combination of the following types and sizes of cables may be used:
 - Max 400 pair No. 24 AWG (or smaller) copper conductor with polyvinyl chloride (PVC) insulation and jacketing material.
 - Max 1/C No. 750 kcmil (or smaller) copper conductor cable with cross-linked polyethylene (XLPE) jacket.
 - Max 7/C No. 12 AWG (or smaller) copper conductor power and control cables with XLPE or PVC insulation with XLPE or PVC jacket.
 - Max 3/C No. 4/0 AWG (or smaller) copper or aluminum conductor SER cables with PVC insulation and jacket.
 - Max 110/125 fiber optic (F.O.) cable with PVC insulation and jacket.
 - Max 3/C with ground No. 8 AWG (or smaller) copper conductor NM cable with PVC insulation and jacket.
 - Max No. 18 AWG RG/U coaxial cable with fluorinated ethylene (FE) or PVC insulation and jacket.
 - Max 4 pair No. 24 AWG (or smaller) copper conductor data cable with Hylar jacket and insulation.
 - Max 4 Pair No 22 AWG (or smaller) Cat 6 copper conductor with PVC insulation and jacket
 - Max 3/C No. 2/0 AWG (or smaller) aluminum or copper conductor cable with XLPE insulation and PVC jacket.
 - Max 3/C No. 2/0 aluminum or copper SE cable with PVC insulation and jacket.
 - Max three conductor No. 12 AWG (or smaller) MC (BX) copper cable with polyvinyl chloride insulation and jacket materials.
- Through Penetrating Product*** – Any cables, **Armored Cable+** or **Metal Clad Cable+** currently Classified under the **Through Penetrating Product** category.
See **Through Penetrating Product** (XHLY) category in the Fire Resistance Directory for names of manufacturers.
- Firestop system** – The firestop system shall consist of the following:
 - Firestop Device*** – One firestop device module centered within the opening. The firestop device module consists of a 12 in. (305 mm) long galv steelsplit sleeve with galv steel flange plates. Firestop device module to be installed in accordance with the accompanying installation instructions. The space between the firestop device module and the periphery of the opening shall be min 0 in. (0 mm, point contact) to max 1 in. (25 mm). Firestop device module secured in place by means of steel flange plates sized to accommodate the firestop device module. Steel flange plates installed on both sides of wall and secured around firestop device module with steel screws. The steel

System No. W-L-3372 *continued*

flange plate is then secured to the gypsum board on both sides of the wall assembly with the supplied screws. The firestop device module is to be installed with its ends projecting an equal distance beyond each surface of the wall assembly.

3M COMPANY

3M FIRE PROTECTION PRODUCTS – 3M Fire Barrier Putty Sleeve Kit DT 100, DT 200 or DT 400

- B. **Packing Material** – (Not Shown. Required for installation only on DT 400 with cable fill of less than 28 percent. Optional on DT 100 and DT200 assemblies.) – Min 2 in. (51 mm) thickness of min 4 pcf (64 kg/m³) mineral wool batt insulation firmly packed into each end of sleeve (Item 2A) as a permanent form. Packing material to be recessed from end of sleeve to accommodate the required thickness of fill material.
- C. **Fill, Void or Cavity Material*** – After the installation of the cables (Item 2) the supplied putty material is to be packed into each end of the firestop device with care taken to fill the interstices between the cables. A min 1 in. (25mm) depth of the putty fill material is required at each end of device.

3M COMPANY

3M FIRE PROTECTION PRODUCTS – 3M Fire Barrier MP+ Putty Stix

*Bearing the UL Classification Mark

+Bearing the UL Listing Mark

Reprinted from the Online Certifications Directory with permission from UL
© 2012 UL LLC



Through Penetrations

Cables

3000 Series

Gypsum

WL

System No. W-L-3423

November 02, 2015

| ANSI/UL1479 (ASTM E814) | CAN/ULC S115 |
|-------------------------------------|--------------------------------------|
| F Ratings — 1 and 2 Hr (See Item 1) | F Ratings — 1 and 2 Hr (See Item 1) |
| T Rating —Hr | FT Rating — 0 Hr |
| | FH Ratings — 1 and 2 Hr (See Item 1) |
| | FTH Rating — 0 Hr |

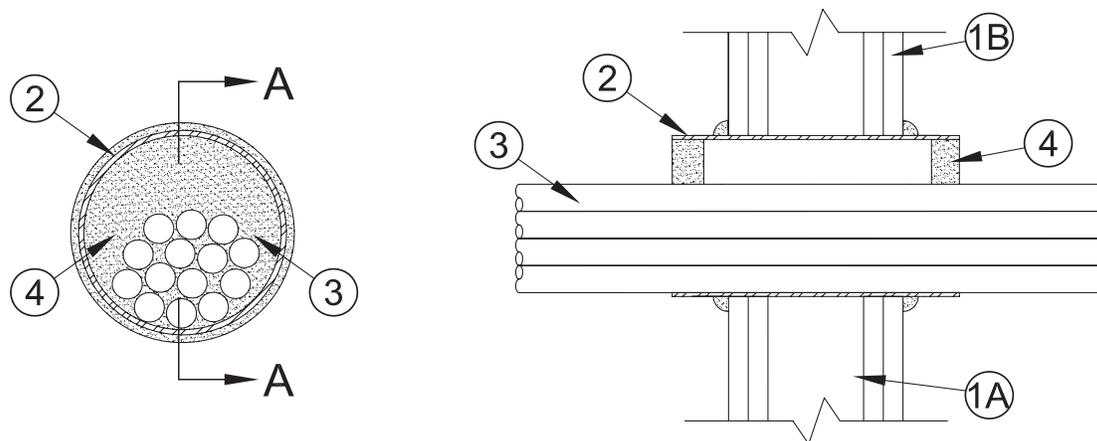

SECTION A-A

1. **Wall Assembly** — The 1 or 2 hr fire rated gypsum board/stud wall assembly shall be constructed of the materials and in the manner specified in the individual U300, U400, V400 or W400 Series Wall and Partition Designs in the UL Fire Resistance Directory and shall include the following construction features:

A. **Studs** — Wall framing may consist of either wood studs or steel channel studs. Wood studs to consist of nom 2 by 4 in. (51 by 102 mm) lumber spaced 16 in. (406 mm) OC. Steel studs to be min 3-1/2 in. (89 mm) wide and spaced max 24 in. (610 mm) OC.

B. **Gypsum Board*** — 5/8 in. (16 mm) thick. The gypsum board type, thickness, number of layers, fastener type and sheet orientation shall be as specified in the individual U300, U400, V400 or W400 Series Design in the UL Fire Resistance Directory. Diam of opening to be equal to the OD of the steel sleeve (Item 2). Max diam of opening is 6-1/2 in. (165 mm).

The hourly F and FH Ratings of the firestop system are equal to the hourly fire rating of the wall assembly in which it is installed.

2. **Steel Sleeve** — Nom 6 in. (152 mm) diam (or smaller) steel electrical metallic tubing (EMT) or Schedule 5 (or heavier) steel pipe. The annular space between steel sleeve and periphery of opening shall be min 0 in. (continuous point contact). Sleeve may extend up to 3 in. (76 mm) beyond each surface of the wall.

2A. **Alternate Steel Sleeve** — (Not Shown) — Cylindrical sleeve fabricated from min 0.019 in. (0.48 mm) thick (28 gauge) galv sheet steel and having a min 2 in. (51 mm) lap along the longitudinal seam. Min length of steel sleeve to be equal to thickness of wall. Max length of sleeve to be such that, when installed, the ends of the sleeve will project not more than 1 in. (25 mm) beyond the surface of the wall on each side of the wall assembly. Sleeve installed by coiling the sheet steel to a diam smaller than the diam opening, inserting the coil through the opening and releasing the coil to let it uncoil against the circular cutouts in the gypsum wallboard layers.

3. **Cables** — Aggregate cross-sectional area of cables in steel sleeve to be max 48 percent of the aggregate cross-sectional area of the sleeve. The annular space between cables and periphery of sleeve and the annular space between cables shall be min 0 in. (point contact) to max 2 in. (51 mm). Cables to be rigidly supported on both sides of wall assembly. Any combination of the following types and sizes of cables may be used:

- A. Max 400 pair No. 24 AWG (or smaller) copper conductor with polyvinyl chloride (PVC) insulation and jacketing material.
- B. Max 1/C No. 750 kcmil (or smaller) copper conductor cable with cross-linked polyethylene (XLPE) jacket.
- C. Max 7/C No. 12 AWG (or smaller) copper conductor power and control cables with XLPE or PVC insulation with XLPE or PVC jacket.
- D. Max 3/C No. 4/0 AWG (or smaller) copper or aluminum conductor SER cables with PVC insulation and jacket.
- E. Max 110/125 fiber optic (F.O.) cable with PVC insulation and jacket.
- F. Max 3/C with ground No. 8 AWG (or smaller) copper conductor NM cable with PVC insulation and jacket.
- G. Max No. 18 AWG RG/U coaxial cable with fluorinated ethylene (FE) or PVC insulation and jacket.
- H. Max 4 pair No. 24 AWG (or smaller) copper conductor data cable with Hylar jacket and insulation.
- I. Max 4 Pair No 22 AWG (or smaller) Cat 6 copper conductor with PVC insulation and jacket.
- J. Max 3/C No. 2/0 AWG (or smaller) aluminum or copper conductor cable with XLPE insulation and PVC jacket.
- K. Max 3/C No. 2/0 aluminum or copper SE cable with PVC insulation and jacket.
- L. Max three conductor No. 12 AWG (or smaller) MC (BX) copper cable with polyvinyl chloride insulation and jacket materials.
- M. **Through Penetrating Product*** — Any cables, **Armored Cable+** or **Metal Clad Cable+** currently Classified under the **Through Penetrating Product** category.

See **Through Penetrating Product** (XHLY) category in the Fire Resistance Directory for names of manufacturers.

4. **Fill, Void or Cavity Material*** — Sealant or Putty — Min 5/8 in. (16 mm) thickness of sealant or min 1 in. (25 mm) thickness of putty applied within the sleeve, flush with both sides of wall. At point contact, a min 1/2 in. (13mm) bead of fill material shall be applied at sleeve/wall interface on both sides of wall when sleeve extends beyond surface of wall. Min 1/2 in. (13 mm) thickness of sealant or a 1/4 in. (6 mm) rope of putty applied point contact locations of the cables/sleeve interface on both sides of wall.

3M COMPANY 3M FIRE PROTECTION PRODUCTS — IC 15WB+, CP25WB+, FB-3000 WT or MP+

System No. W-L-3423 *continued*

*** Indicates such products shall bear the UL or cUL Certification Mark for jurisdictions employing the UL or cUL Certification (such as Canada), respectively.**

Reprinted from the Online Certifications Directory with permission from UL

© 2015 UL LLC



Through Penetrations

Cables

3000 Series

Gypsum

W/L

System No. W-L-3426

July 01, 2016

| | |
|---------------------------------------|---|
| ANSI/UL1479 (ASTM E814) | CAN/ULC S115 |
| F Ratings — 1 and 2 Hr (See Item 1) | F Ratings — 1 and 2 Hr (See Item 1) |
| T Ratings — 0 and 1/2 Hr (See Item 1) | FT Ratings — 0 and 1/2 Hr (See Item 1) |
| | FH Ratings — 1 and 2 Hr (See Item 1) |
| | FTH Ratings — 0 and 1/2 Hr (See Item 1) |

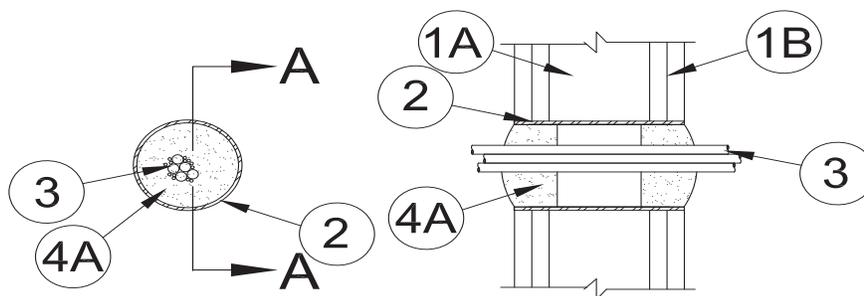

SECTION A-A

1. **Wall Assembly** — The 1 or 2 hr fire-rated gypsum board/stud wall assembly shall be constructed of the materials and in the manner specified if the individual U300, U400 or V400 Series Wall and Partition Designs in the Fire Resistance Directory and shall include the following construction features:

- A. **Studs** — Wall framing shall consist of either wood studs or channel shaped steel studs. Wood studs to consist of 2 by 4 in. (51 by 102 mm) lumber spaced max 16 in. (406 mm) OC. Steel studs to be min 3-1/2 in. (89 mm) wide, fabricated from min 25 MSG galvanized steel, spaced max 24 in. (610 mm) OC.
- B. **Gypsum Board*** — Nom 5/8 in. (16 mm) thick with square or tapered edges. The gypsum board type, number of layers and sheet orientation shall be as specified in the individual Wall and Partition Design Number. Max diam of opening is 2 in. (51 mm) or 4-1/2 in. (114 mm).

The hourly F and FH Ratings of the firestop system are equal to the hourly fire rating of the wall assembly in which it is installed. The hourly T, FT and FTH Ratings of the firestop system are 1/2 hr when installed in 2 hr fire rated walls and 0 hr when installed in 1 hr fire rated walls.

2. **Steel Sleeve** — Cylindrical sleeve fabricated from min 0.016 in. (0.41 mm) thick (No. 28 MSG) galv sheet steel and having a min 1 in. (25 mm) lap along the longitudinal seam. Sleeve installed by coiling the sheet steel to a diam smaller than the through opening, inserting the coil through the openings and releasing the coil to let it uncoil against the circular cutouts in the gypsum board layers. The ends of the steel sleeve shall be flush with each surface of the wall.

3. **Cables** — Aggregate cross-sectional area of bundled cables in opening to be max 60 percent of the cross-sectional area of the opening. Cables to be tightly bundled together and rigidly supported on both sides of the wall assembly. The annular space between cable bundle and periphery of opening shall be min 1/2 in. (13 mm). Any combination of the following types and sizes of cables may be used:

- A. Max 300 pair No. 22 AWG (or smaller) copper conductor telecommunication cables with polyvinyl chloride (PVC) insulation and jacket.
- B. Max 1/C 750 kcmil (or smaller) copper conductor cable with cross-linked polyethylene (XLPE) insulation and jacket.
- C. Max 3/C No. 3/0 AWG aluminum conductor SER cable with PVC insulation and jacket.
- D. Max 7/C No. 12 AWG copper conductor power and control cables with PVC or cross-linked polyethylene (XLPE) insulation and jacket and PVC jacket.
- E. 110/125 fiber optic communication cable with PVC insulation and jacket.
- F. Max 3/C copper conductor No. 10 AWG (or smaller) with bare aluminum ground, PVC insulated steel or aluminum Metal-Clad cable.

4. **Firestop System** — The firestop system shall consist of the following:

- A. **Fill, Void or Cavity Material*** — Plug sized for the steel sleeved opening per Table below friction-fitted within the sleeve at each side of wall such that the outer circumference of the dome-shaped plug is flush with both surfaces of the wall. Plug cut to fit around the cable bundle and installed tightly within the opening.

| Max. Sleeve/Opening Diam in. (mm) | Plug |
|---|--------|
| 2 (51) | PLG2** |
| 4.5 (114) | PLG4** |
| ** Cut wedge from plug to fit smaller sleeve/opening size. See 3M Installation Instructions for specific size of wedge cuts required. | |

3M COMPANY 3M FIRE PROTECTION PRODUCTS — 3M™ Fire Barrier Plug PLG2, 3M™ Fire Barrier Plug PLG4

- B. **Fill, Void or Cavity Material*** — **Foam** — (Not Shown) — Fill material to be injected into all voids and interstices of cables to full depth of plugs to max extent possible.

3M COMPANY 3M FIRE PROTECTION PRODUCTS — Fire Barrier Rated Foam, FIP 1-Step

* Indicates such products shall bear the UL or cUL Certification Mark for jurisdictions employing the UL or cUL Certification (such as Canada), respectively.



Through Penetrations
Cables
3000 Series
Gypsum
WL



UL System No. W-L-3436
XHEZ – Through-penetration Firestop Systems
XHEZ7 – Through-penetration Firestop Systems Certified for Canada

March 17, 2017

| ANSI/UL1479 (ASTM E814) | CAN/ULC S115 |
|-------------------------------------|--------------------------------------|
| F Ratings – 1 and 2 Hr (See Item 1) | F Ratings – 1 and 2 Hr (See Item 1) |
| T Rating – 0 Hr | FT Rating – 0 Hr |
| | FH Ratings – 1 and 2 Hr (See Item 1) |
| | FTH Rating – 0 Hr |

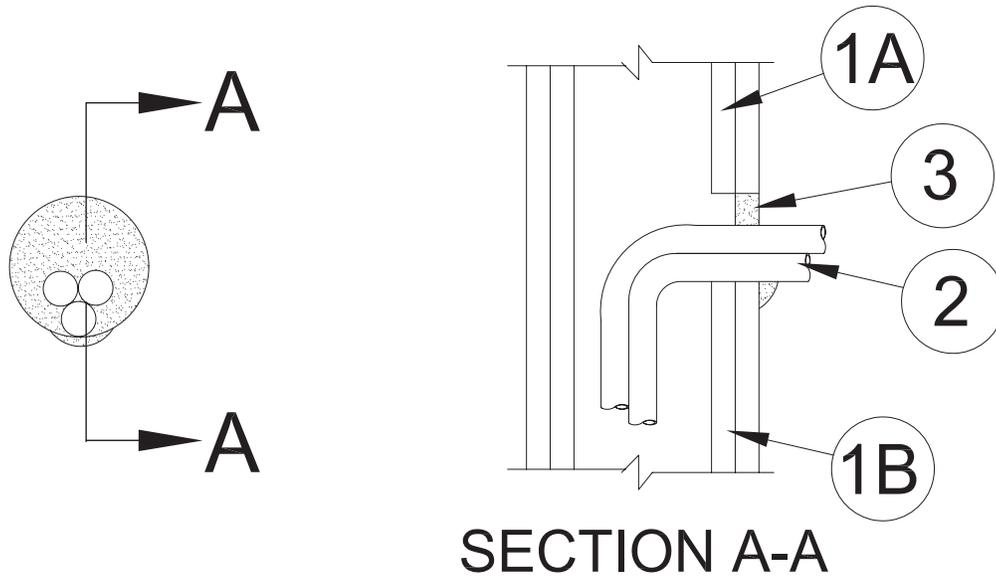

SECTION A-A

1. Wall Assembly – The 1 or 2 hr fire-rated gypsum board/stud wall assembly shall be constructed of the materials and in the manner specified in the individual U300, U400, V400 or W400 Series Wall and Partition Designs in the UL Fire Resistance Directory and shall include the following construction features:

- A. Studs** – Wall framing may consist of either wood studs or steel channel studs. Wood studs to consist of nom 2 by 4 in. (51 by 102 mm) lumber spaced 16 in. (406 mm) OC. Steel studs to be min 3-1/2 in. (89 mm) wide and spaced max 24 in. (610 mm) OC.
- B. Gypsum Board*** – One or two layers of nom 5/8 in. (16 mm) thick gypsum board as specified in the individual Wall and Partition Design. Max diam of opening is 3 in. (76 mm).

The hourly F Rating of the firestop system is equal to the hourly fire rating of the wall assembly.

2. Cables – Max 2 in. (51 mm) diam tight bundle of cables to be installed either concentrically or eccentrically within the opening. The annular space between the cable bundle and the periphery of the opening to be min 0 in. (point contact) to max 1 in. (25 mm). Any combination of the following types and sizes of cables may be used:

- A.** Max 150 pair No. 24 AWG (or smaller) copper conductor with polyvinyl chloride (PVC) insulation and jacket.
- B.** Max 1/C 350 kcmil (or smaller) copper conductor cable with cross-linked polyethylene (XLPE) jacket.
- C.** Max 3/C No. 2/0 AWG (or smaller) aluminum or copper conductor cable with XLPE insulation and PVC jacket.
- D.** Max 7/C No. 12 AWG (or smaller) copper conductor cable with PVC insulation and jacket.
- E.** Max No. 18 AWG RG 6/U coaxial cable with PVC insulation and jacket.
- F.** Max 3/C with ground No. 12 AWG (or smaller) NM cable with PVC insulation and jacket.
- G.** Max 3/C No. 2/0 aluminum or copper SE cable with PVC insulation and jacket.
- H.** Max 3/C No. 2/0 (or smaller) copper conductor PVC jacketed aluminum clad or steel clad TEK cable.

3. Fill, Void or Cavity Material* – Sealant – Min 5/8 in. (16 mm) thickness of fill material applied within annulus, flush with surface of wall. Min 1/2 in. (13 mm) diam bead of sealant applied at point contact location.

3M COMPANY – IC 15WB+, CP 25WB+, FB-3000 WT or FD 150+

*Indicates such products shall bear the UL or cUL Certification Mark for jurisdictions employing the UL or cUL Certification (such as Canada), respectively.

Reprinted from the Online Certifications Directory with permission from UL©

Through Penetrations
Cables
3000 Series
WL



Cables • Wood Frame Floor/Ceiling

| 3M UL Systems | "F" Rating | 3M Product | Through Penetrant Details |
|---------------|------------|--|---|
| F-C-3001 | 1, 2 | 3M™ Fire Barrier Sealant CP 25WB+ 3M™ Fire Barrier Water Tight Sealant 3000 WT | Max 25 pair No. 24 AWG telephone cables, max two conductor with No. 12 ground, No. 14 AWG copper conductor cable. Opening nom 1/2" diam. Chase wall optional. 1 & 2 hour F Rating. Also known as FC3001. |
| F-C-3002 | 2 | 3M™ Fire Barrier Silicone Sealant 2000+ 3M™ Fire Barrier Water Tight Sealant 1000 NS 3M™ Fire Barrier Water Tight Sealant 1003 SL 3M™ Fire Barrier Water Tight Sealant 1003 SL | L505,L511,or L536 assembly. One max 25 pair 24 AWG cable. Max diam of opening 1 in. 2 hour F & T rating. Also known as FC3002. |
| F-C-3007 | 1 | 3M™ Fire Barrier Sealant CP 25WB+ 3M™ Fire Barrier Sealant FD 150+ 3M™ Fire Barrier Moldable Putty Stix MP+ 3M™ Fire Barrier Water Tight Sealant 3000 WT | 7/C 12 AWG power control, 100 pair 22 AWG telecommunication cables, 4/C with ground No. 2/0 AWG SER. Max diam of opening 1-1/4". Concentric or eccentric installation. Point contact to max 1-1/4" annular. Chase wall optional. 1 hour F Rating. Also known as FC3007. |
| F-C-3008 | 1 | 3M™ Fire Barrier Sealant CP 25WB+ 3M™ Fire Barrier Sealant IC 15WB+ 3M™ Fire Barrier Sealant FD 150+ 3M™ Fire Barrier Wrap Strips FS-195+ 3M™ Fire Barrier Moldable Putty Stix MP+ 3M™ Fire Barrier Water Tight Sealant 3000 WT | 7/C 12 AWG power control cable, 2/0 AWG SER. Max 3" bundle. Max diam of opening 3-1/2". Concentric installation. Min 1/4" to max 3/8" annular. 1 hour F Rating. Also known as FC3008. |
| F-C-3017 | 1, 2 | 3M™ Fire Barrier Sealant CP 25WB+ 3M™ Fire Barrier Moldable Putty Stix MP+ | 3/C with ground No. 12 AWG NM. Max diam of opening 1-1/2". Min 1 to max 7 cables tightly bundled. Bundle installed concentrically or eccentrically. Point contact to max 1-1/4" annular. Chase wall optional. 1 & 2 hour F Rating. Also known as FC3017. |
| F-C-3047 | 1 | 3M™ Fire Barrier Sealant CP 25WB+ 3M™ Fire Barrier Sealant IC 15WB+ 3M™ Fire Barrier Sealant FD 150+ 3M™ Fire Barrier Water Tight Sealant 3000 WT | 100 pair No. 22 AWG telecommunication cables, 3/C with ground No. 2 AWG SER, 3/C No. 12 AWG MC, coaxial cable, armored cable, metal clad cable. Max diam of opening 1-1/2". Concentric or eccentric installation. Point contact to max 7/8" annular. Chase wall optional. 1 hour F Rating. Also known as FC3047. |
| F-C-3048 | 1 | 3M™ Fire Barrier Sealant CP 25WB+ 3M™ Fire Barrier Sealant IC 15WB+ 3M™ Fire Barrier Water Tight Sealant 3000 WT | 3/C with ground No. 12 AWG NM, No. 20 AWG RG coaxial cable. Max diam of opening 1-1/2". Min 1 to max 7 cables tightly bundled. Bundle installed concentrically or eccentrically. Point contact to max 1-1/4" annular. Chase wall optional. 1 hour F Rating. Also known as FC3048. |
| F-C-3070 | 1 | 3M™ Fire Barrier Sealant CP 25WB+ 3M™ Fire Barrier Sealant IC 15WB+ 3M™ Fire Barrier Water Tight Sealant 3000 WT | 2" cable bundle. 200 pair No. 22 AWG copper conductor, 1/C 350 kcmil, 7/C No. 12 AWG, 3/C No. 2/0 AWG SER, , 4/C No. 2/0 TECK, 110/125 fiber optic, 3/C with ground No. 8 AWG NM, RG/U coaxial cable, 4 pair No. 24 AWG data cable. Max diam of opening 3". Concentric or eccentric installation. Point contact to max 1" annular. Chase wall optional. 1 hour F Rating. Also referred as FC3070. |
| F-C-3091 | 1 | 3M™ Fire Barrier Pass-Through Products 3M™ Fire Barrier Water Tight Sealant 3000 WT 3M™ Fire Barrier Sealant CP 25WB+ 3M™ Fire Barrier Sealant IC 15WB+ 3M™ Fire Barrier Moldable Putty Stix MP+ | Max area of opening 20-1/4 sq. in. with max dimension of 4-1/2 in. Percent visual fill: 0 to 25%. Concentric installation. Max 2/C No. 18 AWG, max 4 pair No. 24 AWG phone cable, max RG/U coaxial, max 3/C No. 14 AWG Romex, max 1/C No. 4AWG copper conductor. 1 hour F. Also known as FC3091. |
| F-E-3001 | 1 | 3M™ Fire Barrier Sealant CP 25WB+ 3M™ Fire Barrier Sealant IC 15WB+ 3M™ Fire Barrier Moldable Putty Stix MP+ | 7/C 12 AWG, 100 pair 22 AWG, 12 AWG, coaxial cable, metal clad cable aluminum or steel. Also referred as FE3001. |
| F-E-3002 | 1 | 3M™ Fire Barrier Sealant CP 25WB+ 3M™ Fire Barrier Sealant IC 15WB+ 3M™ Fire Barrier Moldable Putty Stix MP+ 3M™ Fire Barrier Water Tight Sealant 3000 WT | Bundle of min 1 to max 7 cables: 3/C with ground No. 12 NM. Max diam of opening 1-1/2". Bundle installed concentrically or eccentrically. Point contact to max 1-1/4" annular. 1 hour F Rating. Also known as FE3002. |
| F-E-3003 | 1 | 3M™ Fire Barrier Sealant CP 25WB+ 3M™ Fire Barrier Sealant IC 15WB+ 3M™ Fire Barrier Sealant FD 150+ 3M™ Fire Barrier Water Tight Sealant 3000 WT | Bundle of min 1 to max 7 cables: 3/C with ground No. 12 NM. Max diam of opening 1-1/2". Bundle installed concentrically or eccentrically. Point contact to max 1-1/4" annular. 1 hour F Rating. Also known as FE3003. |
| F-E-3008 | 1 | 3M™ Fire Barrier Sealant CP 25WB+ 3M™ Fire Barrier Sealant IC 15WB+ 3M™ Fire Barrier Water Tight Sealant 3000 WT | Max 2" bundle: 200 pair No. 22 AWG, 1/C 350 kcmil, 7/C No. 12 AWG, 3/C No. 2/0 AWG SER, 4/C No. 2/0 TECK 90, 110/125 fiber optic, 3/C with ground No. 8 AWG NM, RG/U coaxial, 4 pair No. 24 AWG data cable, armored cable, metal clad cable. Max diam of opening 3". Concentric or eccentric installation. Point contact to max 1" annular. 1 hour F Rating. Also known as FE3008. |

System No. F-C-3001

September 03, 2004

(Formerly System No. 168)

F Ratings – 1 and 2 Hr (See Item 1)

T Ratings – 1 and 2 Hr (See Item 1)

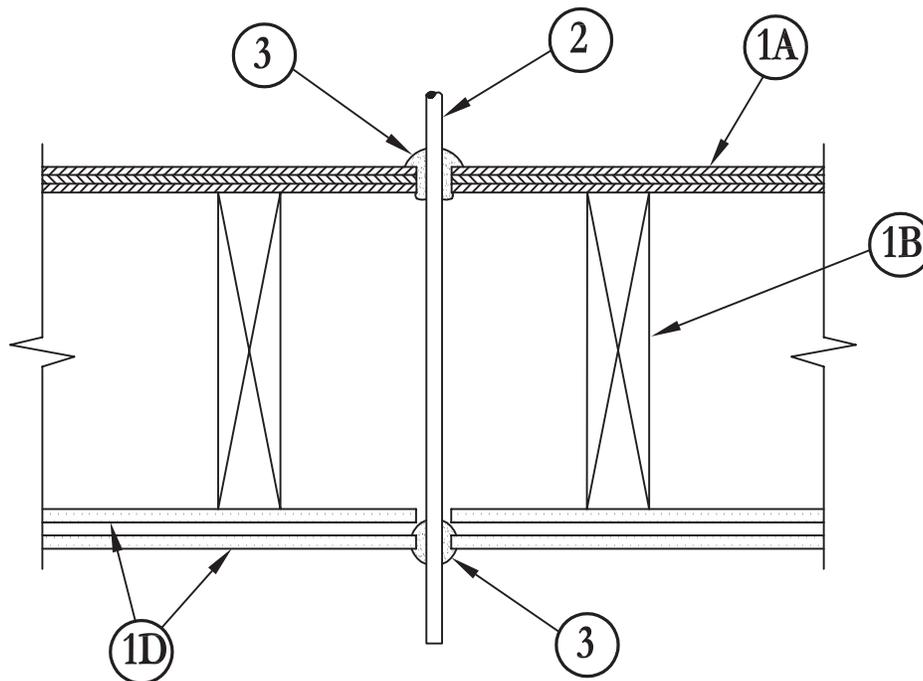

1. **Floor-Ceiling Assembly** – The 1 or 2 hr fire-rated wood joist floor-ceiling assembly shall be constructed of the materials and in the manner specified in the UL Fire Resistance Directory. The 1 hr fire rated assembly shall be constructed as specified in Design No. L501, L512 or L537. The 2 hr fire rated assembly shall be constructed as specified in Design No. L505, L511 or L536. **The F and T Ratings of the firestop system are equal to the fire rating of the floor-ceiling assembly.** The general construction details of the floor-ceiling assembly are summarized below:
 - A. **Flooring System** – Lumber or plywood subfloor with finish floor of lumber, plywood or **Floor Topping Mixture*** as specified in the individual Floor-Ceiling Design. Max diam of opening is 1/2 in.
 - B. **Wood Joists** – Nom 2 by 10 in. lumber joists spaced 16 in. O.C. with nom 1 by 3 in. lumber bridging and with ends firestopped.
 - C. **Furring Channels (Not Shown)** – Resilient galv steel furring channels installed perpendicular to wood joists between first and second layers of wallboard (Item 1D) in 2 hr fire rated assembly. Furring channels spaced max 24 in. O.C.
 - D. **Gypsum Board*** – Nom 4 ft wide by 5/8 in. thick as specified in the individual Floor-Ceiling Design. First layer of wallboard nailed to wood joists. Second layer of wallboard (2 hr fire rated assembly only) screw-attached to furring channels. Max diam of opening is 1/2 in.
- 1.1 **Chase Wall (Optional, not shown)** – The through penetrants (Item No. 2) may be routed through a fire-rated single, double or staggered wood stud/gypsum wallboard chase wall having a fire rating consistent with that of the floor-ceiling assembly. The chase wall shall be constructed of the materials and in the manner specified in the individual U300 Series Wall and Partition Designs in the UL Fire Resistance Directory and shall include the following construction features:
 - A. **Studs** – Nom 2 by 6 in. or double nom 2 by 4 in. lumber studs.
 - B. **Sole Plate** – Nom 2 by 6 in. or parallel 2 by 4 in. lumber plates, tightly butted.
 - C. **Top Plate** The double top plate shall consist of two nom 2 by 6 in. or two sets of parallel 2 by 4 in. lumber plates, tightly butted. Max diam of opening is 1/2 in.
 - D. **Gypsum Board*** – Thickness, type, number of layers and fasteners shall be as specified in individual Wall and Partition Design.
2. **Cable** – Max 25 pair No. 24 AWG copper conductor telephone cable or max two-conductor with ground No. 12 or No. 14 AWG Type NM nonmetallic sheath copper conductor cable. Cable insulation and jacket material to be polyvinyl chloride (PVC). Max one cable to be installed in nom 1/2 in. diam opening. Cable to be rigidly supported on both sides of floor assembly.
3. **Fill, Void or Cavity Materials* – Caulk or Sealant** – Min 3/4 in. thickness of fill material applied within the annulus, flush with top surface of floor or sole plate. Min 5/8 in. or 1-1/4 in. thickness of fill material, for 1 and 2 hr rated assemblies, respectively, applied within the annulus, flush with bottom surface of ceiling or top plate. An additional min 1/4 in. crown of fill material applied to perimeter of penetrant at its egress from the top of flooring and underside of ceiling or from top of sole plate and underside of top plate.

3M COMPANY – CP 25WB+ caulk or FB-3000 WT sealant

*Bearing the UL Classification Marking

Reprinted from the Online Certifications Directory with permission from Underwriters Laboratories Inc.

Copyright © 2010 Underwriters Laboratories Inc.®

System No. F-C-3002

May 09, 2013
 F Rating – 2 Hr
 T Rating – 2 Hr

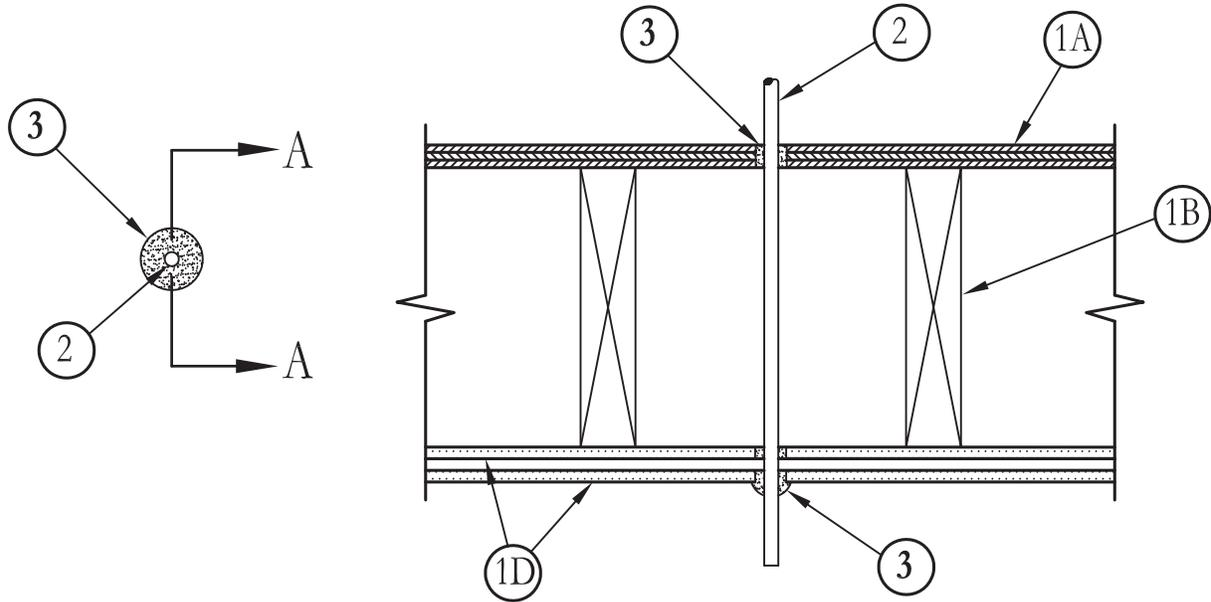
**SECTION A-A**

1. **Floor-Ceiling Assembly** – The fire rated wood joist floor-ceiling assembly shall be constructed of the materials and in the manner specified in Design No. L505, L511 or L536 in the UL Fire Resistance Directory, as summarized below:
 - A. **Flooring System** – Lumber or plywood subfloor with finish floor of lumber, plywood or **Floor Topping Mixture*** as specified in the individual Floor-Ceiling Design.
 - B. **Wood Joists** – Nom 2 by 10 in. (51 by 254 mm) lumber joists spaced 16 in. (406 mm) OC. with nom 1 by 3 in. (25 by 76 mm)
 - C. **Furring Channels** – (Not shown) – Resilient galv steel furring channels installed perpendicular to wood joists between first and second layers of wallboard (Item 1D) and spaced max 24 in. (610 mm) OC.
 - D. **Gypsum Board*** – Nom 4 ft (1219 mm) wide by 5/8 in. (16 mm) thick as specified in the individual Floor-Ceiling Design. First layer of wallboard nailed to wood joists. Second layer of wallboard screw-attached to furring channels. Max diam of ceiling opening is 1 in. (25 mm).
2. **Cable** – One max 25 pair No. 24 AWG telephone cable with polyvinyl chloride (PVC) insulation and jacket. Cable to be rigidly supported on both sides of floor assembly.
3. **Fill, Void or Cavity Material* – Sealant** – Fill material forced into annular space to fill space to max extent possible. Sealant shall be installed flush with the floor and ceiling.

3M COMPANY – Types FB-1000 NS, FB-1003SL, FB-2000 or FB-2000+.

*Bearing the UL Classification Mark

Reprinted from the Online Certifications Directory with permission from UL
 © 2013 UL LLC



System No. F-C-3007

August 18, 2011

F Rating – 1 Hr

T Rating – 1 Hr

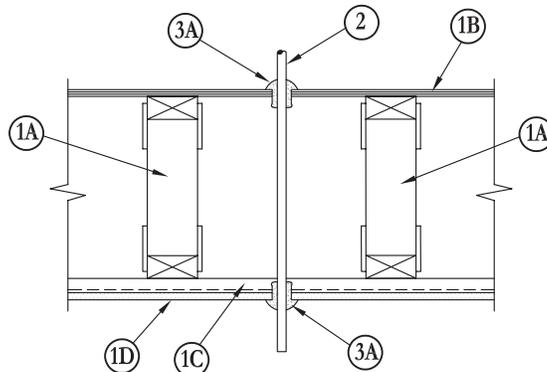

1. **Floor Assembly** – The 1 hr fire rated wood truss or combination wood and steel truss Floor-Ceiling assembly shall be constructed of the materials and in the manner described in the individual L500 Series Design in the UL Fire Resistance Directory, as summarized below:
 - A. **Trusses** – Min 12 in. (305 mm) deep parallel chord trusses fabricated from nom 2 by 4 in. (51 by 102 mm) lumber in conjunction with galv steel truss plates or Structural Wood Members* with bridging as required.
 - B. **Flooring** – Nom 3/4 in. (19 mm) thick plywood flooring with or without **Floor Topping Mixture***. Max diam of opening is 1-1/4 in. (32 mm).
 - C. **Furring Channels** – Rigid or resilient galv steel furring channels installed perpendicular to bottom chord of trusses.
 - D. **Gypsum Board*** – Nom 4 ft (1.22 m) wide by 5/8 in. (16 mm) thick, screw-attached to furring channels. Max diam of opening is 1-1/4 in. (32 mm).
- 1.1 **Chase Wall** – (Optional, Not Shown) – The through penetrants (Item No. 2) may be routed through a 1 hr fire-rated single, double or staggered wood stud/gypsum board chase wall constructed of the materials and in the manner specified in the individual U300 Series Wall and Partition Designs in the UL Fire Resistance Directory and shall include the following construction features:
 - A. **Studs** – Nom 2 by 6 in. (51 by 152 mm) or double nom 2 by 4 in. (51 by 102 mm) lumber studs.
 - B. **Sole Plate** – Nom 2 by 6 in. (51 by 152 mm) or parallel 2 by 4 in. (51 by 102 mm) lumber plates, tightly butted.
 - C. **Top Plate** – The double top plate shall consist of two nom 2 by 6 in. (51 by 152 mm) or two sets of parallel 2 by 4 in. (51 by 102 mm) lumber plates, tightly butted. Max diam of opening is 1-1/2 in. (38 mm)
 - D. **Gypsum Board*** – Thickness, type, number of layers and fasteners shall be as specified in individual Wall and Partition Design.
2. **Cables** – One cable to be installed eccentrically or concentrically in opening with annular space between the cable and the periphery of the opening of min 0 in. (0 mm, point contact) to max 1-1/4 in. (32 mm). Cable to be rigidly supported on both sides of Floor-Ceiling assembly. The following types of cables may be used.
 - A. Max seven conductor No. 12 AWG (or smaller) power/control cables with polyvinyl chloride insulation and jacket materials.
 - B. Max 100 pair No. 22 AWG (or smaller) telecommunication cables with polyvinyl chloride insulation and jacket materials.
 - C. Max four conductor with ground No. 2/0 AWG (or smaller) aluminum SER cables with polyvinyl chloride insulation and jacket materials.
- 2A. **Through Penetrating Product*** – Max one through-penetrating product to be installed eccentrically or concentrically in opening with annular space between the through-penetrating product and the periphery of the opening of min 0 in. (0 mm, point contact) to max 1-1/4 in. (32 mm). Through-penetrating product to be rigidly supported on both sides of floor or wall assembly. The following types of through-penetrating products may be used:
 - A. Max four copper conductors No. 2/0 AWG (or smaller) aluminum or steel Armored Cable# or Metal-Clad Cable+.
AFC CABLE SYSTEMS INC
 - B. Two or more twisted copper conductor No. 6 AWG (or smaller) Power Limited Circuit Cable+ with or without a jacket under a metal armor.
AFC CABLE SYSTEMS INC
 - C. Two or more twisted copper conductor No. 10 AWG (or smaller) Power Limited Fire Alarm Cable+ with or without a jacket under a metal armor.
AFC CABLE SYSTEMS INC
 - D. Two or more twisted copper conductor No. 12 AWG (or smaller) Non Power Limited Fire Alarm Cable+ with or without a jacket under a metal armor.
AFC CABLE SYSTEMS INC
3. **Fill, Void or Cavity Materials* – Caulk, Sealant or Putty** – Min 3/4 in. (19 mm) thickness of fill material applied within the annulus, flush with top surface of floor or sole plate. Min 5/8 in. (16 mm) thickness of fill material applied within the annulus, flush with bottom surface of ceiling or top plate. An additional min 1/4 in. (6 mm) crown of fill material applied to perimeter of penetrant at its egress from the top of flooring and underside of ceiling or from top of sole plate and underside of top plate.
3M COMPANY – CP 25WB+ caulk, MP+ Stix putty or FB-3000 WT sealant

*Bearing the UL Classification Mark

+Bearing the UL Listing Mark

Reprinted from the Online Certifications Directory with permission from UL

© 2012 UL LLC



System No. F-C-3008

October 01, 2008

F Rating – 1 Hr

T Rating – 1 Hr

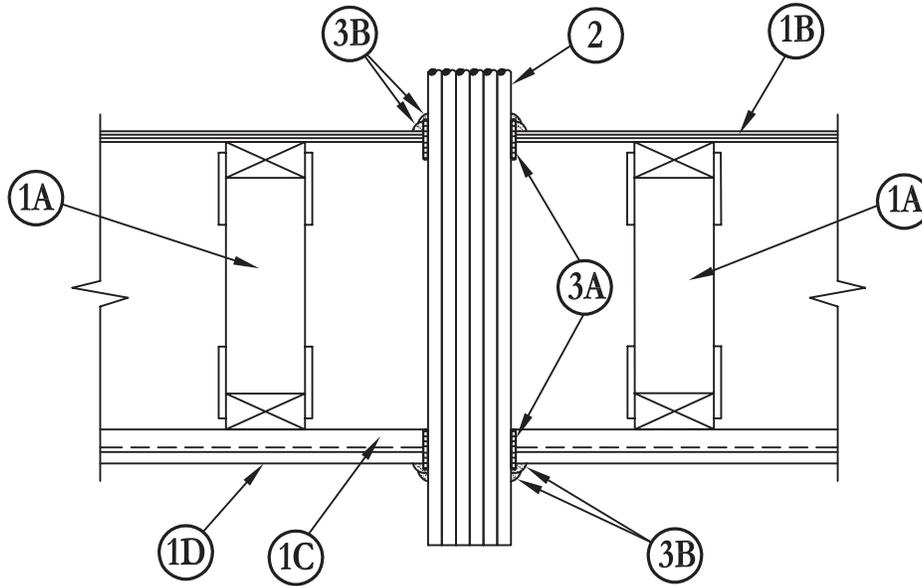

1. **Floor Assembly** – The 1 hr fire rated wood truss or combination wood and steel truss Floor-Ceiling assembly shall be constructed of the materials and in the manner described in the individual L500 Series Design in the UL Fire Resistance Directory, as summarized below:
 - A. **Trusses** – Min 12 in. (305 mm) deep parallel chord trusses fabricated from nom 2 by 4 in. (51 by 102 mm) lumber in conjunction with galv steel truss plates or **Structural Wood Members*** with bridging as required.
 - B. **Flooring** – Nom 3/4 in. (19 mm) thick plywood flooring with or without **Floor Topping Mixture***. Max diam of opening is 3-1/2 in. (89 mm).
 - C. **Furring Channels** – Rigid or resilient galv steel furring channels installed perpendicular to bottom chord of trusses.
 - D. **Gypsum Board*** – Nom 4 ft (122 cm) wide by 5/8 in. (16 mm) thick, screw-attached to furring channels.
- 1.1 **Chase Wall** – (Optional, not shown) – The through penetrants (Item No. 2) may be routed through a 1 hr fire-rated single, double or staggered wood stud/gypsum board chase wall constructed of the materials and in the manner specified in the individual U300 Series Wall and Partition Designs in the UL Fire Resistance Directory and shall include the following construction features:
 - A. **Studs** – Nom 2 by 6 in. (51 by 152 mm) or double nom 2 by 4 in. (51 by 102 mm) lumber studs.
 - B. **Sole Plate** – Nom 2 by 6 in. (51 by 152 mm) or parallel 2 by 4 in. (51 by 102 mm) lumber plates, tightly butted.
 - C. **Top Plate** – The double top plate shall consist of two nom 2 by 6 in. (51 by 152 mm) or two sets of parallel 2 by 4 in. (51 by 102 mm) lumber plates, tightly butted.
 - D. **Gypsum Board*** – Thickness, type, number of layers and fasteners shall be as specified in individual Wall and Partition Design.
2. **Cables** – Max seven conductor No. 12 AWG (or smaller) power/control cables or max 100 pair No. 22 AWG (or smaller) telecommunication cables or max four conductor with ground No. 4/0 AWG (or smaller) copper or aluminum SER cables with polyvinyl chloride (PVC) or cross-linked polyethylene (XLPE) insulation and jacket materials. Max 3 in. (76 mm) diam tightly bundled cables centered in circular cutouts. Circular cutouts to have a diam 1/2 in. to 3/4 in. (13 to 19 mm) larger than diam of cable bundle such that a 1/4 in. to 3/8 in. (6 to 10 mm) annular space is present between the cable bundle and the perimeter of the circular cutout. Cables to be rigidly supported on both sides of Floor-Ceiling assembly.
3. **Firestop System** – The details of the firestop system shall be as follows:
 - A. **Fill, Void or Cavity Materials* – Wrap Strip** – Nom 1/4 in. (6 mm) thick intumescent elastomeric material faced on one side with aluminum foil, supplied in 2 in. (51 mm) wide strips. Nom 2 in. (51 mm) wide strip tightly wrapped around cable bundle (foil side exposed), secured with two steel tie wires and slid into hole-sawed opening in flooring (Item 1B) and in gypsum board ceiling (Item 1D) or the sole plate (Item 1.B) and top plate (Item 1.C) of the chase wall. Bottom edge of wrap strip to project 9/16 to 11/16 in. (14 to 17.5 mm) below bottom surface of flooring and below bottom (ceiling) surface of gypsum board or the bottom edge of the top plate.
3M COMPANY – FS-195+.
 - B. **Fill, Void or Cavity Materials* – Caulk, Sealant or Putty** – Applied to fill interstices between cables, to the max extent possible, within confines of wrap strip at both the floor and ceiling elevations. Nom 1/4 in. (6 mm) thickness of caulk or putty to be applied to the exposed edge of the wrap strip layer (top of flooring or sole plate and bottom of gypsum board ceiling or top plate). Generous application of caulk or putty to be applied to fill all gaps at the wrap strip/flooring and wrap strip/gypsum board ceiling or wrap strip/top plate interfaces.
3M COMPANY – CP 25WB+ caulk, MP+ Stix putty, IC 15WB+ caulk, FireDam 150+ caulk or FB-3000 WT Sealant

*Bearing the UL Classification Mark

Reprinted from the Online Certifications Directory with permission from Underwriters Laboratories Inc.
Copyright © 2010 Underwriters Laboratories Inc.®



System No. F-C-3017

September 03, 2004

F Rating – 1 and 2 Hr (See Item No. 1)
T Rating – 1 and 1-1/2 Hr (See Item No. 1)

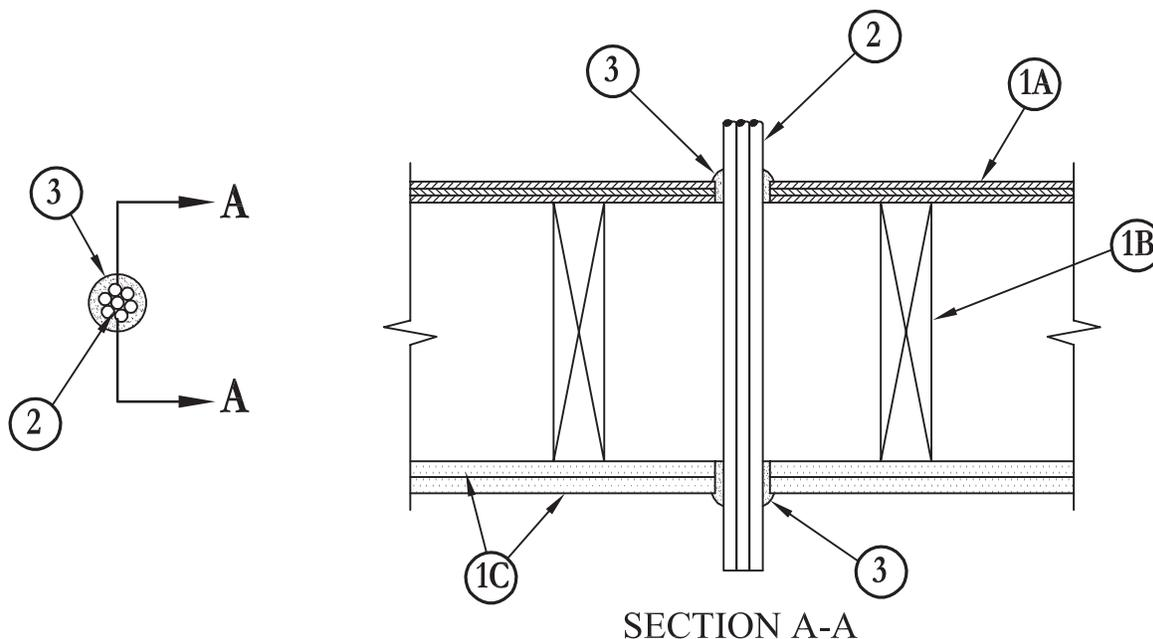

1. **Floor-Ceiling Assembly** – The 1 hr fire-rated solid or trussed lumber joist floor-ceiling assembly shall be constructed of the materials and in the manner specified in the individual L500 Series Floor-Ceiling Designs in the UL Fire Resistance Directory. The 2 hr fire-rated wood joist floor-ceiling assembly shall be constructed of the materials and in the manner specified in Design Nos. L505, L511 or L536 in the UL Fire Resistance Directory. **The F Rating of the firestop system is equal to the rating of the floor-ceiling assembly. The T Rating of the firestop system is 1 and 1-1/2 hr for 1 and 2 hr rated floor-ceiling assemblies, respectively.** The general construction features of the floor-ceiling assembly are summarized below:
 - A. **Flooring System** – Lumber or plywood subfloor with finish floor of lumber, plywood or **Floor Topping Mixture*** as specified in the individual Floor-Ceiling Design. Max diam of opening is 1-1/2 in.
 - B. **Wood Joists*** – For 1 hr fire-rated floor-ceiling assemblies, nom 10 in. deep (or deeper) lumber, steel or combination lumber and steel joists, trusses or **Structural Wood Members*** with bridging as required and with ends firestopped. For 2 hr fire-rated floor-ceiling assemblies, nom 2 by 10 in. lumber joists spaced 16 in. OC with nom 1 by 3 in. lumber bridging and with ends firestopped.
 - C. **Gypsum Board*** – Nom 4 ft wide by 5/8 in. thick as specified in the individual Floor-Ceiling Design. First layer of wallboard nailed to wood joists. Second layer of wallboard (2 hr fire-rated assembly) screw-attached to furring channels. Max diam of opening is 1-1/2 in.
- 1.1 **Chase Wall** (Optional not shown) – The through penetrants (Item No. 2) may be routed through a fire-rated single, double or staggered wood stud/gypsum wallboard chase wall having a fire rating consistent with that of the floor-ceiling assembly. The chase wall shall be constructed of the materials and in the manner specified in the individual U300 Series Wall and Partition Designs in the UL Fire Resistance Directory and shall include the following construction features:
 - A. **Studs** – Nom 2 by 6 in. or double nom 2 by 4 in. lumber studs.
 - B. **Sole Plate** – Nom 2 by 6 in. or parallel 2 by 4 in. lumber plates, tightly butted.
 - C. **Top Plate** – The double top plate shall consist of two nom 2 by 6 in. or two sets of parallel 2 by 4 in. lumber plates, tightly butted. Max diam of opening is 1-1/2 in.
 - D. **Gypsum Board*** – Thickness, type, number of layers and fasteners shall be as specified in individual Wall and Partition Design.
2. **Cables** – Max three conductor with ground No. 12 AWG (or smaller) NM cables with polyvinyl chloride insulation and jacket materials. Min one cable to max seven cables tightly bundled to be installed eccentrically or concentrically in opening with annular space between the cables and the periphery of the opening of min 0 in. (point contact) to max 1-1/4 in. Cables to be rigidly supported on both sides of Floor-Ceiling assembly.
3. **Fill, Void or Cavity Materials*** – **Caulk, Sealant or Putty** – Min 3/4 in. thickness of fill material applied within the annulus, flush with top surface of floor or sole plate. Min 5/8 in. or 1-1/4 in. thickness of fill material, for 1 and 2 hr rated assemblies, respectively, applied within the annulus, flush with bottom surface of ceiling or top plate. An additional min 1/4 in. crown of fill material applied to perimeter of penetrant at its egress from the top of flooring and underside of ceiling or from top of sole plate and underside of top plate.

3M COMPANY – CP 25WB+ Caulk, FB-3000 WT sealant or MP+ Stix Putty

*Bearing the UL Classification Mark

Reprinted from the Online Certifications Directory with permission from Underwriters Laboratories Inc.
Copyright © 2010 Underwriters Laboratories Inc.®



System No. F-C-3047

May 18, 2005
 F Rating – 1 Hr
 T Rating – 1 Hr

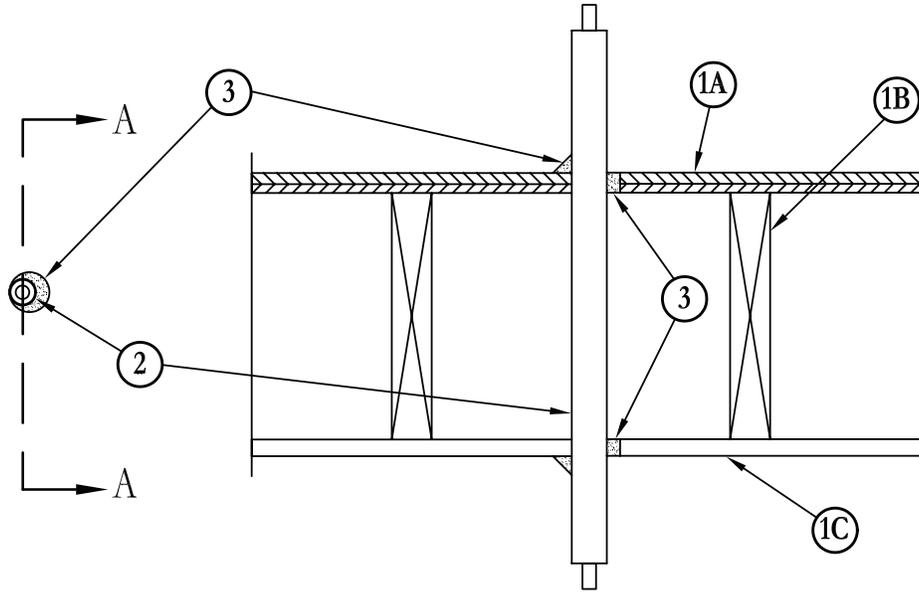

SECTION A-A

1. **Floor-Ceiling Assembly** – The 1 hr fire-rated solid or trussed lumber joist floor-ceiling assembly shall be constructed of the materials and in the manner specified in the individual L500 Series Floor-Ceiling Designs in the UL Fire Resistance Directory. The general construction details of the floor-ceiling assembly are summarized below:
 - A. **Flooring System** – Lumber or plywood subfloor with finish floor of lumber, plywood or **Floor Topping Mixture*** as specified in the individual Floor-Ceiling Design. Max diam of opening is 1-1/2 in. (38 mm).
 - B. **Wood Joists** – Nom 10 in. (254 mm) deep (or deeper) lumber, steel or combination lumber and steel joists, trusses or **Structural Wood Members*** with bridging as required and with ends firestopped.
 - C. **Gypsum Board*** – Nom 4 ft (122 cm) wide by 5/8 in. (16 mm) thick as specified in the individual Floor-Ceiling Design. Max diam of opening is 1-1/2 in. (38 mm).
- 1.1 **Chase Wall** (Optional, not shown) – The cables (Item No. 2) may be routed through a fire-rated single, double or staggered wood stud/ gypsum wallboard chase wall having a fire rating consistent with that of the floor-ceiling assembly. The chase wall shall be constructed of the materials and in the manner specified in the individual U300 Series Wall and Partition Designs in the UL Fire Resistance Directory and shall include the following construction features:
 - A. **Studs** – Nom 2 in. by 6 in. (51 mm by 152 mm) or double nom 2 in. by 4 in. (51 mm by 102 mm) lumber studs.
 - B. **Sole Plate** – Nom 2 in. by 6 in. (51 mm by 152 mm) or parallel 2 in. by 4 in. (51 mm by 102 mm) lumber plates, tightly butted.
 - C. **Top Plate** – The double top plate shall consist of two nom 2 in. by 6 in. (51 mm by 152 mm) or two sets of parallel 2 in. by 4 in. (51 mm by 102 mm) lumber plates, tightly butted. Max diam of opening is 1-1/2 in. (38 mm).
 - D. **Gypsum Board*** – Thickness, type, number of layers and fasteners shall be as specified in individual Wall and Partition Design.
2. **Cables** – One cable to be installed eccentrically or concentrically in opening with annular space between the cable and the periphery of the opening of min 0 in. (point contact) to max 7/8 in. (0 mm to max 22 mm). Cable to be rigidly supported on both sides of the Floor-Ceiling assembly. The following types of cables may be used:
 - A. Max 100 pair No. 22 AWG (or smaller) telecommunication cables with polyvinyl chloride insulation and jacket materials.
 - B. Max three conductor with ground No. 2 AWG (or smaller) aluminum SER cable with polyvinyl chloride insulation and jacket material.
 - C. Max three conductor No. 12 AWG (or smaller) MC (BX) copper cable with polyvinyl chloride insulation and jacket materials.
 - D. Coaxial cable with polyvinyl chloride jacket.
 - E. **Through Penetrating Product*** – Any cables, **Armored Cable+** or **Metal Clad Cable+** currently Classified under the Through Penetrating Product category.
 See **Through Penetrating Product** (XHLY) category in the Fire Resistance Directory for names of manufacturers
3. **Fill, Void or Cavity Materials*** – **Caulk or Sealant** – Min 3/4 in. (19 mm) thickness of caulk applied within the annulus, flush with top surface of floor or sole plate. Min 5/8 in. (16 mm) thickness of fill material applied within the annulus, flush with bottom surface of ceiling or top plate. Min 1/2 in. (13 mm) diam bead of caulk applied at the cable/floor or sole plate interface at point contact location on the top surface of floor or sole plate and at the cable/ceiling or top plate interface at point contact location.

3M COMPANY – FireDam 150+, CP 25WB+, IC 15WB+ caulk or FB-3000 WT sealant

*Bearing the UL Classification Marking

Reprinted from the Online Certifications Directory with permission from Underwriters Laboratories Inc.
 Copyright © 2010 Underwriters Laboratories Inc.®



System No. F-C-3048

May 18, 2005

F Rating – 1 Hr

T Rating – 1 Hr

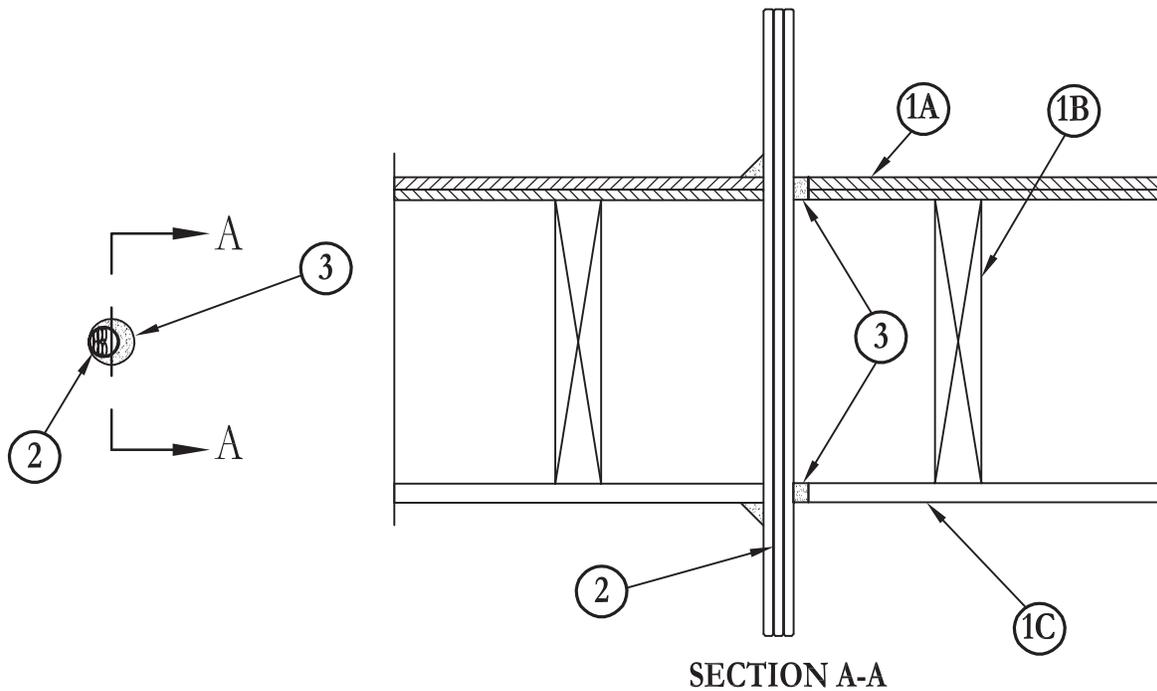

- Floor-Ceiling Assembly** – The 1 hr fire-rated solid or trussed lumber joist floor-ceiling assembly shall be constructed of the materials and in the manner specified in the individual L500 Series Floor-Ceiling Designs in the UL Fire Resistance Directory. The general construction details of the floor-ceiling assembly are summarized below:
 - Flooring System** – Lumber or plywood subfloor with finish floor of lumber, plywood or **Floor Topping Mixture*** as specified in the individual Floor-Ceiling Design. Max diam of opening is 1-1/2 in. (38 mm).
 - Wood Joists** – Nom 10 in. (254 mm) deep (or deeper) lumber, steel or combination lumber and steel joists, trusses or **Structural Wood Members*** with bridging as required and with ends firestopped.
 - Gypsum Board*** – Nom 4 ft (122 cm) wide by 5/8 in. (16 mm) thick as specified in the individual Floor-Ceiling Design. Max diam of opening is 1-1/2 in. (38 mm).
- Chase Wall** – (Optional, not shown) - The cables (Item No. 2) may be routed through a fire-rated single, double or staggered wood stud/ gypsum wallboard chase wall having a fire rating consistent with that of the floor-ceiling assembly. The chase wall shall be constructed of the materials and in the manner specified in the individual U300 Series Wall and Partition Designs in the UL Fire Resistance Directory and shall include the following construction features:
 - Studs** – Nom 2 in. by 6 in. (51 mm by 152 mm) or double nom 2 in. by 4 in. (51 mm by 102 mm) lumber studs.
 - Sole Plate** – Nom 2 in. by 6 in. (51 mm by 152 mm) or parallel 2 by 4 in. (51 mm by 102 mm) lumber plates, tightly butted.
 - Top Plate** – The double top plate shall consist of two nom 2 in. by 6 in. (51 mm by 152 mm) or two sets of parallel 2 by 4 in. (51 mm by 102 mm) lumber plates, tightly butted. Max diam of opening is 1-1/2 in. (38 mm).
 - Wallboard, Gypsum*** – Thickness, type, number of layers and fasteners shall be as specified in individual Wall and Partition Design.
- Cables** – Max three conductor with ground No. 12 AWG (or smaller) NM copper cable with polyvinyl chloride insulation and jacket materials or No. 20 A WG (or smaller) Type RG coaxial cable with polyvinyl chloride insulation. Min one cable to max seven cables tightly bundled to be installed eccentrically or concentrically in opening with annular space between the cables and the periphery of the opening of min 0 in. (point contact) to max 1-1/4 in. (0 mm to 32 mm). Cables to be rigidly supported on both sides of Floor-Ceiling assembly.
- Fill, Void or Cavity Materials* – Caulk or Sealant** – Min 3/4 in. (19 mm) thickness of caulk applied within the annulus, flush with top surface of floor or sole plate. Min 5/8 in. (16 mm) thickness of fill material applied within the annulus, flush with bottom surface of ceiling or top plate. Min 1/2 in. (13 mm) diam bead of caulk applied at the cable/floor or sole plate interface at point contact location on the top surface of floor or sole plate and at the cable/ceiling or top plate interface at point contact location.

3M COMPANY – FireDam 150+, CP 25WB+, IC 15WB+ caulk or FB-3000 WT sealant

*Bearing the UL Classification Mark

Reprinted from the Online Certifications Directory with permission from Underwriters Laboratories Inc.
Copyright © 2010 Underwriters Laboratories Inc.®



System No. F-C-3070

October 01, 2008

F Rating – 1 Hr

T Rating – 1 Hr

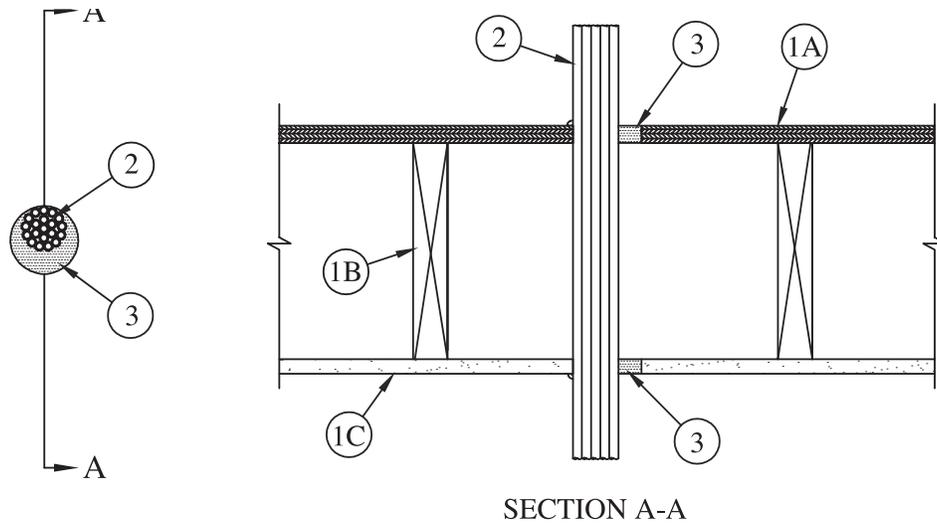

1. **Floor-Ceiling Assembly** – The 1 hr fire-rated solid or trussed lumber joist floor-ceiling assembly shall be constructed of the materials and in the manner specified in the individual L500 Series Floor-Ceiling Designs in the UL Fire Resistance Directory. The general construction details of the floor-ceiling assembly are summarized below:
 - A. **Flooring System** – Lumber or plywood subfloor with finish floor of lumber, plywood or **Floor Topping Mixture*** as specified in the individual Floor-Ceiling Design. Max diam of opening is 3 in. (76 mm).
 - B. **Wood Joists** – Nom 10 in. (254 mm) deep (or deeper) lumber, steel or combination lumber and steel joists, trusses or **Structural Wood Members*** with bridging as required and with ends firestopped.
 - C. **Gypsum Board*** – Nom 4 ft (122 cm) wide by 5/8 in. (16 mm) thick as specified in the individual Floor-Ceiling Design. Max diam of opening is 3 in. (76 mm).
- 1.1 **Chase Wall** – (Optional, not shown) - The through penetrants (Item No. 2) may be routed through a fire-rated single, double or staggered wood stud/gypsum board chase wall having a fire rating consistent with that of the floor-ceiling assembly. The chase wall shall be constructed of the materials and in the manner specified in the individual U300 Series Wall and Partition Designs in the UL Fire Resistance Directory and shall include the following construction features:
 - A. **Studs** – Nom 2 by 6 in. (51 by 152 mm) or double nom 2 by 4 in. (51 by 102 mm) lumber studs.
 - B. **Sole Plate** – Nom 2 by 6 in. (51 by 152 mm) or parallel 2 by 4 in. (51 by 102 mm) lumber plates, tightly butted. Max diam of opening is 3 in. (76 mm).
 - C. **Top Plate** – The double top plate shall consist of two nom 2 by 6 in. (51 by 152 mm) or two sets of parallel 2 by 4 in. (51 by 102 mm) lumber plates, tightly butted. Max diam of opening is 3 in. (76 mm).
 - D. **Gypsum Board*** – Thickness, type, number of layers and fasteners shall be as specified in individual Wall and Partition Design.
2. **Cables** – Max 2 in. (52 mm) diam cable bundle installed eccentrically or concentrically within opening. Annular space between cable bundle and periphery of opening to be min 0 in. (point contact) to max 1 in. Cable bundle to be rigidly supported on both sides of wall. The following types and sizes of cables may be used:
 - A. Max 200 pair No. 22 AWG (or smaller) copper conductor with polyvinyl chloride (PVC) insulation and jacketing material.
 - B. Max 1/C No. 350 kcmil (or smaller) copper conductor cable with cross-linked polyethylene (XLPE) or PVC jacket.
 - C. Max 7/C No. 12 AWG (or smaller) copper conductor power and control cables with XLPE or PVC insulation with XLPE or PVC jacket.
 - D. Max 3/C No. 4/0 AWG (or smaller) copper or aluminum conductor SER cables with XLPE or PVC insulation and jacket.
 - E. Max 4/C No. 2/0 AWG (or smaller) copper conductor, aluminum clad or steel clad TECK 90 cable with or without PVC jacketed.
 - F. Max 110/125 fiber optic (F.O.) cable with PVC insulation and jacket.
 - G. Max 3/C with ground No. 8 AWG (or smaller) copper conductor NM cable with PVC insulation and jacket.
 - H. Max RG/U coaxial cable with fluorinated ethylene insulation and jacket.
 - I. Max 4 pair No. 24 AWG (or smaller) copper conductor data cable with Hylar jacket and insulation.
 - J. **Through Penetrating Product*** – Any cables, **Armored Cable+** or **Metal Clad Cable+** currently Classified under the Through Penetrating Product category.
See **Through Penetrating Product** (XHLY) category in the Fire Resistance Directory for names of manufacturers
3. **Fill, Void or Cavity Materials* – Caulk or Sealant** – Min 3/4 in. (19 mm) thickness of caulk applied within annulus, flush with top surface of floor or sole plate. Min 5/8 in. (16 mm) thickness of caulk applied within annulus, flush with bottom surface of ceiling or top plate. Min 1/4 in. (6 mm) diam bead of caulk applied at point contact locations at cable bundle/floor or sole plate interface on top surface of floor or sole plate and at cable bundle/ceiling or top plate interface.

3M COMPANY – IC 15WB+, CP 25WB+ caulk or FB-3000 WT sealant

*Bearing the UL Classification Mark

Reprinted from the Online Certifications Directory with permission from Underwriters Laboratories Inc.
Copyright © 2010 Underwriters Laboratories Inc.®



System No. F-C-3091

March 27, 2007

F Rating – 1 Hr

T Rating – 1 Hr

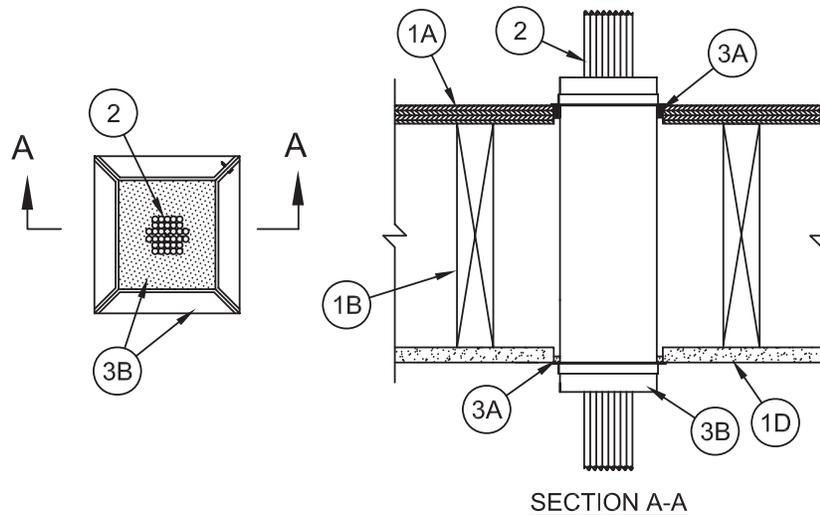

1. **Floor Assembly** – The 1 hr fire-rated wood joist Floor-Ceiling assembly shall be constructed of the materials and in the manner described in the individual L500 Series Design in the UL Fire Resistance Directory and shall include the following construction features:
 - A. **Flooring System** – Lumber or plywood subfloor with finish floor of lumber, plywood or **Floor Topping Mixture*** as specified in the individual Floor-Ceiling Design. Max area of opening is 20-1/4 in.² (130.6 cm²) with a max dimension of 4-1/2 in. (114 mm).
 - B. **Joists** – Nom 2 by 10 in. (51 by 254 mm) deep lumber joists spaced 16 in. (406 mm) OC with nom 1 by 3 in. (25 by 76 mm) lumber bridging and with ends firestopped.
 - C. **Furring Channels** – (Not Shown) - Resilient galv steel furring channels installed perpendicular to wood joists (Item 1B) as required in the individual Floor-Ceiling Design.
 - D. **Gypsum Board*** – Nom 5/8 in. (16 mm) thick as specified in the individual Floor-Ceiling Design. Max area of opening is 20-1/4 in.² (130.6 cm²) with a max dimension of 4-1/2 in. (114 mm).
- 1.1 **Chase Wall** – (Optional, Not Shown) - The through penetrant (Item 2) may be routed through a 1 hr fire rated single, double or staggered wood stud/gypsum board chase wall constructed of the materials and in the manner specified in the individual U300 Series Wall and Partition Designs in the UL Fire Resistance Directory and shall include the following construction features:
 - A. **Studs** – Nom 2 by 6 in. (51 by 152 mm), or double nom 2 by 4 in. (51 by 102 mm) lumber studs.
 - B. **Sole Plate** – Nom 2 by 6 in. (51 by 152 mm) or parallel 2 by 4 in. (51 by 102 mm) lumber plates, tightly butted. Max area of opening is 20-1/4 in.² (130.6 cm²) with a max dimension of 4-1/2 in. (114 mm).
 - C. **Top Plate** – The double top plate shall consist of two nom 2 by 6 in. (51 by 152 mm) or two sets of parallel 2 by 4 in. (51 by 102 mm) lumber plates, tightly butted. Max area of opening is 20-1/4 in.² (130.6 cm²) with a max dimension of 4-1/2 in. (114 mm).
 - D. **Gypsum Board*** – Thickness, type, number of layers and fasteners shall be as specified in the individual Wall and Partition Design.
2. **Cables** – The loading area within the firestop device shall be a min of 0 percent (empty) to a max of 25 percent visual fill. Cable bundle to be centered within opening and rigidly supported on both sides of floor-ceiling assembly. Any combination of the following types and sizes of cables may be used:
 - A. Max 2/C No. 18 AWG with polyvinyl chloride (PVC) insulation and jacket materials.
 - B. Max 4 pair No. 24 AWG telephone cable with PVC insulation and jacket materials.
 - C. Max RG/U (or smaller) coaxial cable with fluorinated ethylene insulation and jacket materials.
 - D. Max 3/C (with ground) No. 14 AWG (or smaller) nonmetallic sheathed (Romex) cable with PVC insulation and jacket materials.
 - E. Max 1/C No. 4 AWG copper conductor cable with insulation and jacket materials.
3. **Firestop System** – The details of the firestop system shall be as follows:
 - A. **Fill, Void or Cavity Material* – Sealant** – Min 1/2 in. (13 mm) thickness of fill material within the annulus, flush with top surface of floor or top of chase wall sole plate. Min 1/4 in. (6 mm) thickness of fill material within the annulus, flush with bottom surface of ceiling. Additional 1/4 in. (6 mm) thickness of fill material applied under mounting flange of firestop device (Item 3B) and lapping a min 1 in. (25 mm) on bottom surface of ceiling.
3M COMPANY – Moldable Putty+, CP 25WB+, IC 15WB+, 3000
 - B. **Firestop Device*** – Firestop device consists of a nominal 4 by 4 by 13 in. (102 by 102 by 330 mm) long galv hinged powder coated steel sleeve with an intumescent material lining and foam plugs. Firestop device to be centered within opening and installed in accordance with the accompanying installation instructions. The space between the firestop device and the periphery of the opening shall be nom 1/4 in. (6 mm). Firestop device secured in place by means of steel split mounting flanges sized to accommodate the firestop device. Steel split mounting flanges installed on both sides of floor-ceiling and secured together with steel set screws. The firestop device is to be installed with its ends projecting an equal distance beyond each surface of the floor -ceiling assembly. Nom 1 in. (25 mm) thick pre-cut foam plugs sized to accommodate the cable bundle and installed flush with each end of device on both sides of floor-ceiling assembly.
3M COMPANY – 3M Fire Barrier Pass-Through Device

*Bearing the UL Classification Mark

Reprinted from the Online Certifications Directory with permission from Underwriters Laboratories Inc.

Copyright © 2010 Underwriters Laboratories Inc.®



System No. F-E-3001

May 20, 2005
 F Rating – 1 Hr
 T Rating – 1 Hr

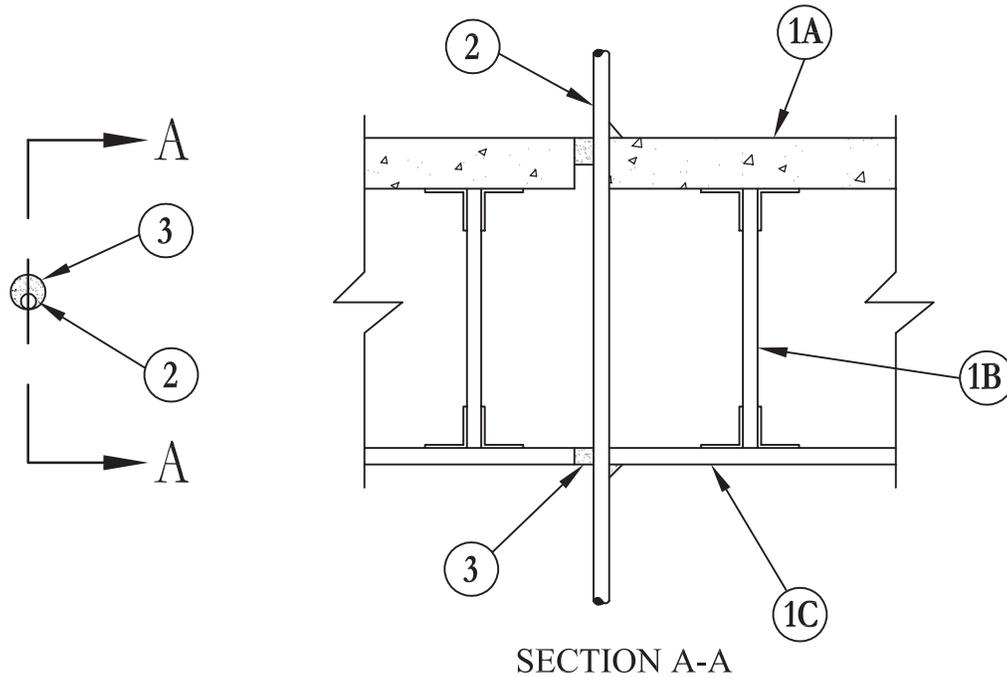

- Floor-Ceiling Assembly** – The 1 hr fire rated concrete and steel joist Floor-Ceiling assembly shall be constructed of the materials and in the manner described in the individual G500 Series Design in the UL Fire Resistance Directory, as summarized below:
 - Flooring** – Normal or Lightweight concrete as specified in the individual G500 Series Design. Max diam of opening is 1-1/2 in. (38 mm).
 - Joists** – Steel joists or **Structural Steel Members*** as specified in the individual G500 Series Design.
 - Gypsum Board*** – Min 5/8 in. (16 mm) thick, screw-attached to furring channels as specified in the individual G500 Series Design. Max diam of opening is 1-1/2 in. (38 mm).
- Cables** – One cable to be installed eccentrically or concentrically in opening with annular space between the cable and the periphery of the opening of min 0 in. (point contact) to max 1-1/4 in. (0 mm to max 32 mm). Cable to be rigidly supported on both sides of floor-ceiling assembly. The following types of cables may be used:
 - Max seven conductor No. 12 AWG (or smaller) power/control cables with polyvinyl chloride insulation and jacket materials.
 - Max 100 pair No. 22 AWG (or smaller) telecommunication cables with polyvinyl chloride insulation and jacket materials.
 - Max four conductor with ground No. 2/0 AWG (or smaller) aluminum SER cables with polyvinyl chloride insulation and jacket materials.
 - Max three conductor No. 12 AWG (or smaller) MC (BX) copper cable with polyvinyl chloride insulation and jacket materials.
 - Nom 1/4 in. (6 mm) diam coaxial cable with polyvinyl chloride jacket.
 - Through Penetrating Product*** – Max four conductor No. 2/0 AWG copper conductor **Metal Clad Cable**++ with aluminum or steel armor.
- Fill, Void or Cavity Materials*** – **Caulk or Putty** – Min 3/4 in. (19 mm) thickness of fill material applied within the annulus, flush with top surface. Min 5/8 in. (16 mm) thickness of fill material applied within the annulus, flush with bottom surface of ceiling. Min 1/2 in. (13 mm) diam bead of fill material applied at the cable/floor interface at point contact location on the top of surface of floor and at the cable/ceiling interface at point contact location on lower surface of ceiling.

AFC CABLE SYSTEMS INC

3M COMPANY – CP 25WB+, IC 15WB+ caulk, or MP+ Stix putty.

*Bearing the UL Classification Marking

++Bearing the UL Listing Mark

Reprinted from the Online Certifications Directory with permission from Underwriters Laboratories Inc.
 Copyright © 2010 Underwriters Laboratories Inc.®



System No. F-E-3002

May 20, 2005

F Rating – 1 Hr

T Rating – 1 Hr

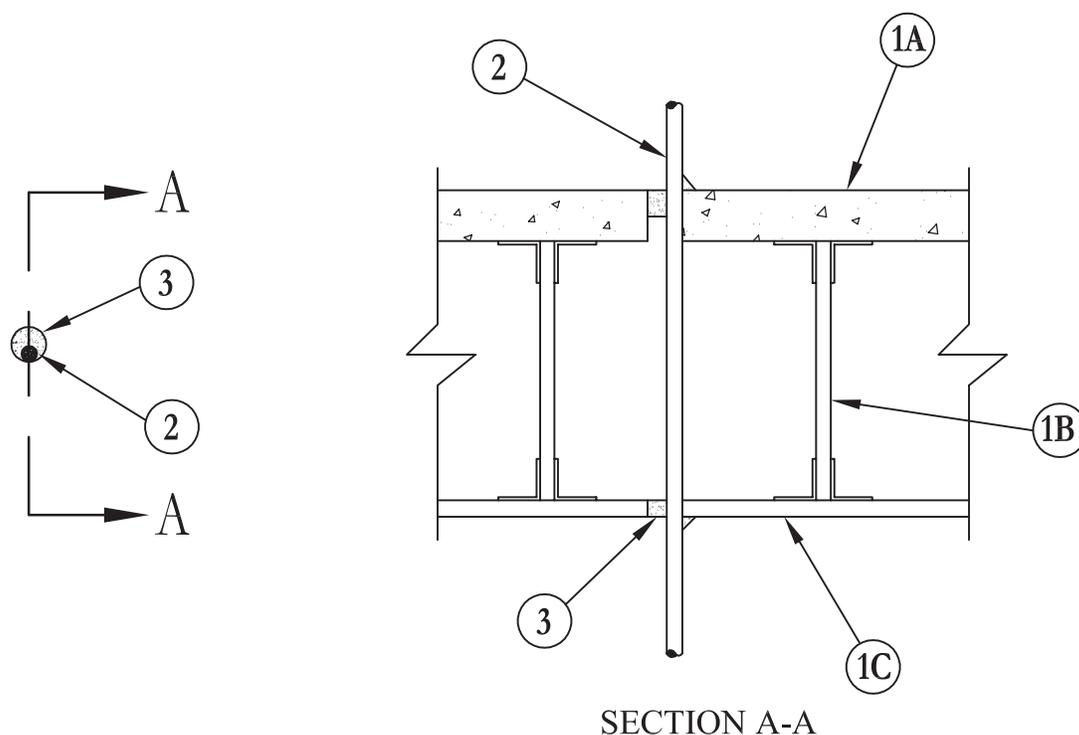

SECTION A-A

1. **Floor-Ceiling Assembly** – The 1 hr fire rated concrete and steel joist Floor-Ceiling assembly shall be constructed of the materials and in the manner described in the individual G500 Series Design in the UL Fire Resistance Directory, as summarized below:
 - A. **Flooring** – Normal or lightweight concrete as specified in the individual G500 Series Design. Max diam of opening is 1-1/2 in. (38 mm).
 - B. **Joists** – Steel joists or **Structural Steel Members*** as specified in the individual G500 Series Design.
 - C. **Gypsum Board*** – Min 5/8 in. (16 mm) thick, screw-attached to furring channels as specified in the individual G500 Series Design. Max diam of opening is 1-1/2 in. (38 mm).
2. **Cables** – Max three conductor with ground No. 12 AWG (or smaller) NM cables with polyvinyl chloride insulation and jacket materials. Min one cable to max seven cables tightly bundled to be installed eccentrically or concentrically in opening with annular space between the cables and the periphery of the opening of min 0 in. (point contact) to max 1-1/4 in. (0 mm to max 32 mm), Cables to be rigidly supported on both sides of floor-ceiling assembly.
3. **Fill, Void or Cavity Materials* – Caulk, Sealant or Putty**– Min 3/4 in. (19 mm) thickness of fill material applied within the annulus, flush with top surface of floor. Min 5/8 in. (16 mm) thickness of fill material applied within the annulus, flush with bottom surface of ceiling. Min 1/2 in. (13 mm) diam bead of fill material applied at the cable/floor interface at point contact location on the top surface of floor and at the cable/ceiling interface at point contact location on lower surface of ceiling.

3M COMPANY – CP 25WB+, IC 15WB+ caulk, FB-3000 WT sealant or MP+ Stix putty

*Bearing the UL Classification Marking

Reprinted from the Online Certifications Directory with permission from Underwriters Laboratories Inc.
Copyright © 2010 Underwriters Laboratories Inc.®



System No. F-E-3003

May 20, 2005
 F Rating – 1 Hr
 T Rating – 1 Hr

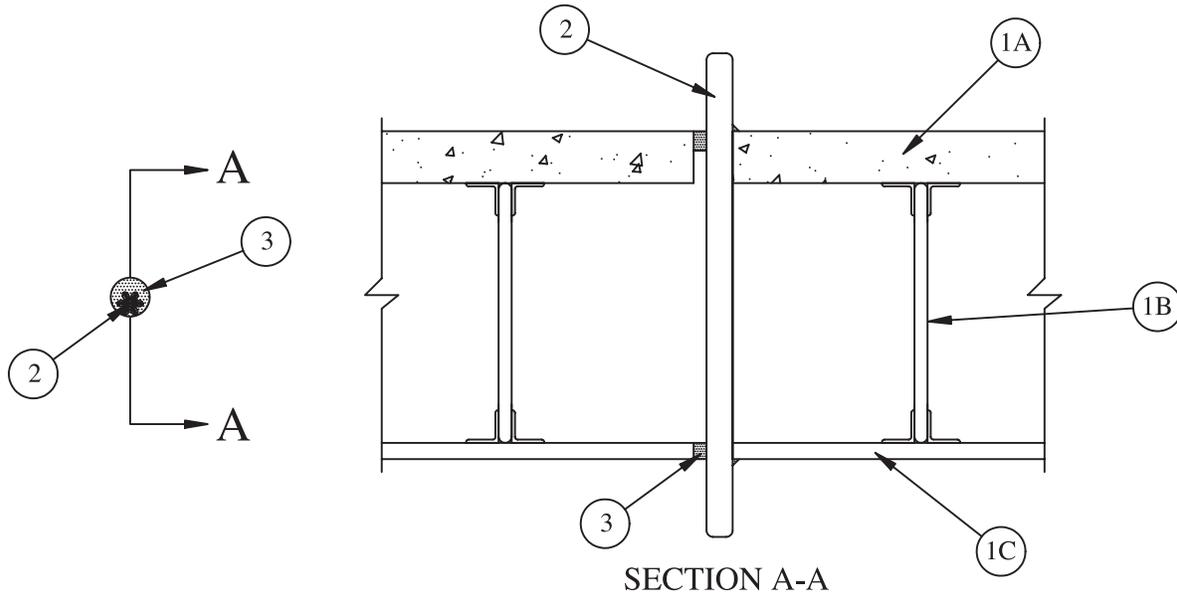

- Floor-Ceiling Assembly** – The 1 hr fire rated concrete and steel joist Floor-Ceiling assembly shall be constructed of the materials and in the manner described in the individual G500 Series Design in the UL Fire Resistance Directory, as summarized below:
 - Flooring** – Normal or lightweight concrete as specified in the individual G500 Series Design. Max diam of opening is 1-1/2 in. (38 mm).
 - Joists** – Steel joists or **Structural Steel Members*** as specified in the individual G500 Series Design.
 - Gypsum Board*** – Min 5/8 in. (16 mm) thick, screw-attached to furring channels as specified in the individual G500 Series Design. Max diam of opening is 1-1/2 in. (38 mm).
- Cables** – Max three conductor with ground No. 12 AWG (or smaller) NM cables with polyvinyl chloride insulation and jacket materials. Min one cable to max seven cables tightly bundled to be installed eccentrically or concentrically in opening with annular space between the cables and the periphery of the opening of min 0 in. (point contact) to max 1-1/4 in. (0 mm to max 32 mm). Cables to be rigidly supported on both sides of floor-ceiling assembly.
- Fill, Void or Cavity Materials* – Caulk or Sealant** – Min 3/4 in. (19 mm) thickness of fill material applied within the annulus, flush with top surface of floor. Min 5/8 in. (16 mm) thickness of fill material applied within the annulus, flush with bottom surface of ceiling. Min 1/2 in. (13 mm) diam bead of fill material applied at the cable/floor interface at point contact location on the top surface of floor and at the cable/ceiling interface at point contact location on lower surface of ceiling.

3M COMPANY – FireDam 150+, CP 25WB+, IC 15WB+ caulk or FB-3000 WT sealant

*Bearing the UL Classification Marking

Reprinted from the Online Certifications Directory with permission from Underwriters Laboratories Inc.
 Copyright © 2010 Underwriters Laboratories Inc.®



System No. F-E-3008

May 20, 2005

F Rating – 1 Hr

T Rating – 1 Hr

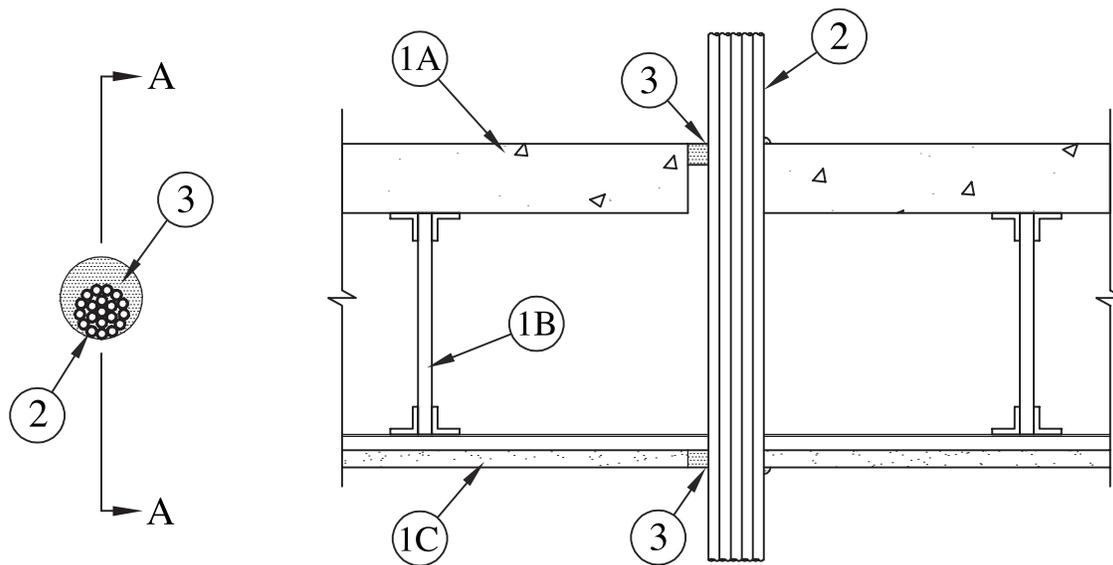

SECTION A-A

1. **Floor-Ceiling Assembly** – The 1 hr fire rated concrete and steel joist Floor-Ceiling assembly shall be constructed of the materials and in the manner described in the individual G500 Series Design in the UL Fire Resistance Directory, as summarized below:
 - A. **Flooring** – Normal or Lightweight concrete as specified in the individual G500 Series Design. Max diam of opening is 3 in. (76 mm).
 - B. **Joists** – Steel joists or **Structural Steel Members*** as specified in the individual G500 Series Design.
 - C. **Gypsum Board*** – Min 5/8 in. (16 mm) thick, screw-attached to furring channels as specified in the individual G500 Series Design. Max diam of opening is 3 in. (76 mm).
2. **Cables** – Max 2 in. (51 mm) diam cable bundle installed eccentrically or concentrically within opening. Annular space between cable bundle and periphery of opening to be min 0 in. (point contact) to max 1 in. (0 mm to max 25 mm). Cable bundle to be rigidly supported on both sides of wall. The following types and sizes of cables may be used:
 - A. Max 200 pair No. 22 AWG (or smaller) copper conductor with polyvinyl chloride (PVC) insulation and jacketing material.
 - B. Max 1/C No. 350 kcmil (or smaller) copper conductor cable with cross-linked polyethylene (XLPE) or PVC jacket.
 - C. Max 7/C No. 12 AWG (or smaller) copper conductor power and control cables with XLPE or PVC insulation with XLPE or PVC jacket.
 - D. Max 3/C No. 2/0 AWG (or smaller) copper or aluminum conductor SER cables with XLPE or PVC insulation and jacket.
 - E. Max 4/C No. 2/0 AWG (or smaller) copper conductor, aluminum clad or steel clad TECK 90 cable with or without PVC jacketed.
 - F. Max 110/125 fiber optic (F.O.) cable with PVC insulation and jacket.
 - G. Max 3/C with ground No. 8 AWG (or smaller) copper conductor NM cable with PVC insulation and jacket.
 - H. Max RG/U coaxial cable with fluorinated ethylene insulation and jacket.
 - I. Max 4 pair No. 24 AWG (or smaller) copper conductor data cable with Hylar jacket and insulation.
 - J. **Through Penetrating Product*** – Any cables, **Armored Cable+** or **Metal Clad Cable+** currently Classified under the Through Penetrating Product category.
See **Through Penetrating Product** (XHLY) category in the Fire Resistance Directory for names of manufacturers
3. **Fill, Void or Cavity Materials*** – **Caulk or Sealant** – Min 3/4 in. (19 mm) thickness of caulk applied within annulus, flush with top surface of floor. Min 5/8 in. (16 mm) thickness of caulk applied within annulus, flush with bottom surface of ceiling. Min 1/4 in. (6 mm) diam bead of caulk applied at point contact locations at cable bundle/floor interface on top surface of floor and at cable bundle/ceiling interface.

3M COMPANY – CP 25WB+, IC 15WB+ caulk or FB-3000 WT sealant

*Bearing the UL Classification Marking

Reprinted from the Online Certifications Directory with permission from Underwriters Laboratories Inc.

Copyright © 2010 Underwriters Laboratories Inc.®



Through Penetrations

Cables

3000 Series

Floor/Ceiling

FE

Cable Trays

CAJ

Concrete floors with a minimum thickness less than or equal to 5 inches (127 mm)

Concrete or masonry walls with a minimum thickness less than or equal to 8 inches (203 mm)

WJ

Floor assemblies

Concrete or masonry walls with a minimum thickness less than or equal to 8 inches (203 mm)

WL

Wall assemblies

Framed walls

Cable Trays • Concrete

| 3M UL Systems | "F" Rating | 3M Product | Through Penetrant Details |
|---------------|------------|---|---|
| C-AJ-4003 | 2, 3 | 3M™ Fire Barrier Sealant CP 25WB+ 3M™ Fire Barrier Sealant IC 15WB+ 3M™ Fire Barrier Composite Sheet CS-195+ 3M™ Fire Barrier Wrap Strips FS-195+ 3M™ Fire Barrier Moldable Putty Stix MP+ 3M™ Expantral™ Flexible Intumescent Strip E-FIS 3M™ Fire Barrier Water Tight Sealant 3000 WT 3M™ Fire Barrier Wrap Ultra GS | One or more max. 36 in. wide by 6 in. deep cable tray penetrating a max. 36 square foot opening in a concrete floor or wall. Utilizing CS 195+ Composite Sheet. |
| C-AJ-4056 | 2, 3 | 3M™ Fire Barrier Moldable Putty Pads MPP+ 3M™ Fire Barrier Moldable Putty Stix MP+ 3M™ Fire Barrier Pillows 3M™ Fire Barrier Self-Locking Pillows | Max. 40 in. wide x 4 in. deep cable tray penetrating a concrete floor or wall. Utilizing Fire Barrier Pillows. |
| C-AJ-4070 | 2 | 3M™ Fire Barrier Water Tight Sealant 1000 NS 3M™ Fire Barrier Water Tight Sealant 1003 SL 3M™ Fire Barrier Water Tight Sealant 3000 WT | Max. two max. 36 in. wide x 4 in. deep cable trays penetrating a concrete floor or wall. Utilizing packing material and Sealant. |
| C-AJ-4078 | 2 | 3M™ Fire Barrier Pillows 3M™ Fire Barrier Self-Locking Pillows 3M™ Fire Barrier Moldable Putty Stix MP+ 3M™ Fire Barrier Moldable Putty Pads MPP+ 3M™ Fire Barrier Composite Sheet CS-195+ | Max. 40 in. wide x 4 in. deep cable tray penetrating a concrete floor or wall. Utilizing CS 195+ Composite Sheet and Fire Barrier Pillows. |
| C-AJ-4082 | 2, 3 | 3M™ Fire Barrier Pass-Through Devices Square 3M™ Fire Barrier MP+ Moldable Putty Stix 3M™ Fire Barrier Sealant IC 15WB+ 3M™ Fire Barrier Sealant CP 25WB+ 3M™ Fire Barrier Water Tight Sealant 3000 WT | 2 in. x 2 in. cable tray penetrating a concrete floor or wall through a Fire Barrier Pass-Through Device. |
| C-AJ-4098 | 2 | 3M™ Fire Barrier Rated Foam FIP 1-Step | Max. two max. 24 in. wide x 6 in. deep cable trays penetrating a concrete floor or wall. Utilizing Fire Barrier Rated Foam, FIP 1-Step. |
| C-AJ-4109 | 2 | 3M™ Fire Barrier Block 3M™ Fire Barrier Plank 3M™ Fire Barrier Rated Foam FIP 1-Step | Max. two max. 24 in. wide x 6 in. deep cable trays penetrating a concrete floor or wall. Utilizing Fire Barrier Blocks/Planks and Fire Barrier Rated Foam, FIP 1-Step. |
| W-J-4044 | 1, 2 | 3M™ Fire Barrier Sealant CP 25WB+ 3M™ Fire Barrier Composite Sheet CS-195+ 3M™ Fire Barrier Moldable Putty Stix MP+ 3M™ Expantral™ Flexible Intumescent Strip E-FIS | Max. 24" x 4" steel or aluminum open ladder cable tray, 0-40% cable fill, max. 750 Kcmil, 300 pair no. 22 AWG, 7/C no. 12 AWG, 4/C No. 2/0 AWG, 1-10/125 fiber optic, 180 sq. in., 30" maximum, intumescent sliding sheet. Also referred to as WJ4044. |
| W-J-4055 | 1, 2 | 3M™ Fire Barrier Moldable Putty Stix MP+ 3M™ Fire Barrier Self-Locking Pillows 3M™ Fire Barrier Pillows 3M™ Fire Barrier Composite Sheet CS-195+ | Max 24 in. x 4 in. cable tray. Max 2 cable trays. Max cable fill 40%. Max area of opening 720 sq. in. with max dimension of 30 in. Space between trays min 6 in. to max 18 in. Annular space point contact to max 18 in. 2 hour F rating. 1/2 hour T rating. Also known as WJ4055. |
| W-J-4062 | 1, 2 | 3M™ Fire Barrier Moldable Putty Stix MP+ 3M™ Fire Barrier Self-Locking Pillows 3M™ Fire Barrier Pillows 3M™ Fire Barrier Composite Sheet CS-195+ | Max 12 in. x 1-1/2 in. open ladder cable tray, max 8-3/4 in. x 2-1/2 in. wire basket cable tray. Max 2 cable trays. Max cable fill 40% ladder cable tray, max cable fill 23% wire basket cable tray. Max area of opening 720 sq. in. with max dimension of 30 in. Space between trays min 6 in. to max 12 in. Annular space min 1-1/2 in. to max 20 in. 2 hour F rating. 3/4 hour T rating. Also known as WJ4062. |
| W-J-4063 | 1, 2 | 3M™ Fire Barrier Pillows 3M™ Fire Barrier Self-Locking Pillows 3M™ Fire Barrier Moldable Putty Stix MP+ 3M™ Fire Barrier Composite Sheet CS-195+ | 2 cable trays. Max area of opening 720 sq. in. with max dimension 30 in. Annular between cable trays min 6 in. to max 10 in. Annular between cable trays and opening point contact to max 10 in. Max 24 in. by 4 in. galv. steel or aluminum open ladder with 40% fill. Max 8-3/4 by 2-1/2 wire basket with 23% fill. 2 hour F. Also known as WJ4063. |
| W-J-4069 | 1, 2 | 3M™ Fire Barrier Pillows 3M™ Fire Barrier Self-Locking Pillows 3M™ Fire Barrier Moldable Putty Stix MP+ | Max area of opening 1080 sq. in. with max dimension of 36 in. Max 20 in. x 2 in. steel cable rack or max 24 in. x 4 in. steel open ladder cable tray or max 8-3/4 in. x 2-1/2 in. steel wire cable basket. Cable fill dependent on type of rack. Side annular min 2 in. to max 13 in. Point contact at bottom. 1 & 2 hour F. 1/2 hour T. Also known as WJ4069. |
| W-J-4073 | 1, 2 | 3M™ Fire Barrier Rated Foam FIP 1-Step | Max two: max 24 in. x max 6 in. open ladder aluminum or steel cable tray. Max 45% cable fill including armored cable, metal clad cable. Min 6 in. concrete. Block wall. Max 512 sq. in. opening with max 32 in. dimension. Point contact to max 2 in. annular space. Cable trays min 2 in. apart. 2 hour F rating. 1/2 hour T rating. Also known as WJ4073. |
| W-J-4074 | 1, 2 | 3M™ Fire Barrier Rated Foam FIP 1-Step | Min 4-3/4 in. and 6 in. concrete wall or concrete block wall. 560 sq in. opening, with max 28 in. dimension. Max 20 in. by 2 in. steel cable rack, max 24 in. x 4 in. steel or aluminum open cable ladder tray, max 8-3/4 in. x 2-1/2 in. steel wire basket cable tray. 1 & 2 hr F rating. Also known as WJ4074 |

System No. C-AJ-4003

January 02, 2009

F Ratings – 2 and 3 Hr (See Item 4)

T Rating – 0 Hr

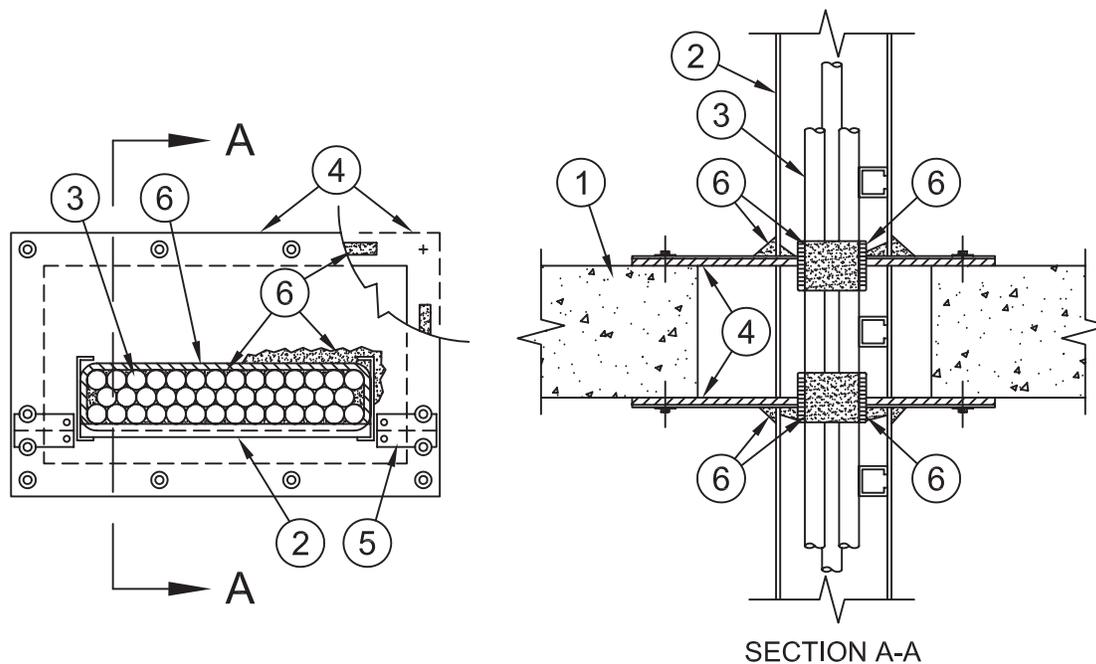

1. **Floor or Wall Assembly** – Min 4-1/2 in. (114 mm) thick lightweight or normal weight (100-150 pcf or 1600 - 2400 kg/m³) concrete. Wall may also be constructed of any UL Classified **Concrete Blocks***. Max area of opening 36 sq ft (3.3 m²) with one dimension of opening being 36 in. (914 mm) or less.

See **Concrete Blocks*** (CAZT) category in the Fire Resistance Directory for names of manufacturers.

2. **Cable Tray** – Max 36 in. (914 mm) wide by max 6 in. (152 mm) deep steel or aluminum open ladder cable tray. Cable tray to consist of channel-shaped side-rails with boxed channel rungs spaced 9 in. (229 mm) OC. Cable tray side-rails to be formed of min 0.056 in. (1.4 mm) thick (16 ga) galv steel or min 0.125 in. (3.2 mm) thick aluminum. Cable tray rungs to be formed of min 0.029 in. (.8 mm) thick (22 ga) galv steel or min 0.080 in. (2 mm) thick aluminum. When more than one cable tray is installed in opening, min distance between cable trays is 26 in. (660 mm). Min annular space between cable tray and edge of opening is zero in. (point contact). When annular space between cable tray and edge of opening or between multiple cable trays exceeds 6 in., (152 mm), a support channel (Item 7) shall be installed between the cable tray and the edge of the opening to support the edge of the intumescent sheet (Item 4) parallel with the width dimension of the cable tray. Cable trays rigidly supported on both sides of floor or wall assembly.
3. **Cables** – Aggregate cross-sectional area of cables in cable tray not to exceed 39 percent of the cross-sectional area of the cable tray based on a max 3 in. (76 mm) cable loading depth within the cable tray. Any combination of the following types and sizes of cables may be used:
 - A. Max 1000 kcmil single-conductor power cables; cross-linked polyethylene insulation.
 - B. Max No.2 AWG multiconductor power and control cables; cross-linked polyethylene insulation, polyvinyl chloride jacket.
 - C. Max 300 pair No. 22 AWG (or smaller) copper conductor communication cable with polyvinyl chloride insulation and jacket material.
 - D. Multiple fiber optical communication cable jacketed with polyvinyl chloride and having a max outside diam of 5/8 in. (16 mm).
 - E. Max 22 AWG coaxial data cable with polyethylene insulation and polyvinyl chloride jacket.
 - F. Max 7C No. 12 AWG (or smaller) multi conductor power and control cables; XLPE insulation, XLPE or polyvinyl chloride (PVC) jacket.
 - G. Max No. 18 AWG RG 6/U coaxial cable with PVC insulation and jacket.
 - H. Max 4/C No. 2/0 AWG (or smaller) copper or aluminum conductor cables with XLPE or PVC insulation and jacket.
4. **Fill, Void or Cavity Materials* – Intumescent Sheet** – Rigid aluminum foil-faced sheet with galv steel sheet backer. Sheets cut to tightly follow the contours of the cable tray and the cables. Sheets cut to lap a min of 2 in. (51 mm) on the floor or wall surface on all sides of the opening. Sheet is required to be installed on both sides of the floor or wall assembly to attain the 3 hr F Rating. As an option for steel cable tray in floors, the sheet may be installed on only the top surface of the floor to attain a max 2 hr F Rating. When sheet is installed on only the top surface of the floor, the caulk (Item 6) fill materials are also required to be installed on only the top surface of the floor. Sheet to be installed with the galv steel sheet backer exposed (aluminum foil facing against floor or wall surface) and secured to floor or wall surface with min 3/16 in. (5 mm) diam by 1-1/4 in. (32 mm) long steel anchor screws, or equivalent, in conjunction with min 1-1/4 in. (32 mm) diam steel fender washers. Max spacing of fasteners not to exceed 6 in. (152 mm) with additional fasteners located on each side of butted seams or slits made to permit installation of the sheet around the cable tray.

3M COMPANY – Type CS-195+
5. **Steel Cover Strip** – Min 2 in. (51 mm) wide strip of min 0.020 in. (.51 mm) thick galv steel centered over entire length of each butted seam or slit made in the intumescent sheet (Item 4). Prior to installation of the steel strip, the seam or slit in the intumescent sheet shall be covered with a nom 1/4 in. (6 mm) diam bead of caulk (Item 6). Steel cover strip secured to galv steel sheet backer of intumescent sheet with steel sheet metal screws or steel rivets spaced max 3 in. (76 mm) OC on each side of seam or slit.

System No. C-AJ-4003 *continued*

Through Penetrations

Cable Trays

4000 Series

Concrete

CAJ

6. **Fill, Void or Cavity Materials*** – **Graphite Seal, Caulk, Sealant or Putty** – One layer of 1/2 in. x 1/16 in. (13 mm by 1.6 mm) adhesive backed graphite intumescent seal positioned under intumescent sheet around entire perimeter of through opening or min 1/4 in. (6 mm) diam continuous bead of caulk or putty applied to edge of intumescent sheet at its interface with surface of floor or wall around entire perimeter of through opening. Generous application of caulk or putty to be applied to fill all interstices between cables. Generous application of caulk or putty to be applied around the base of the cable tray side-rails and contour of cables at their egress from the intumescent sheet on both sides of the floor or wall assembly.

3M COMPANY – E-FIS or Ultra GS seals, CP 25WB+ caulk, FB-3000 WT sealant, MP+ putty or IC 15WB+ caulk

7. **Support Channel** – (Not Shown) – When area of through opening exceeds 1440 sq in. (9290 cm²), an intermediate support channel shall be installed flush with top surface of floor or both surfaces of wall. Support channels to be min 1-5/8 by 1-5/8 in. (41 by 41 mm) and formed of min 0.093 in. (2.4 mm) thick (No. 12 gauge) painted or galv steel. Ends of steel channel bolted or welded to steel angles anchored to inside walls of through opening. When width of cable tray exceed 24 in. (610 mm) and/or when more than one cable tray is installed in the opening, additional support channels are to be installed such that intumescent sheet is supported within 6 in. (152 mm) of each side of the cable tray(s). When steel support channels are centered beneath butted seams of intumescent sheets, no steel cover strip (Item 5) is required over butted seam. Intumescent sheet secured to steel support channels with steel sheet metal screws in conjunction with min 1-1/4 in. (32 mm) diam steel fender washers.

When support channel is used beneath butted seam of intumescent sheets, fasteners spaced max 3 in. (76 mm) OC on each side of butted seam. When support channel is located away from intumescent sheet seam, fasteners spaced max 6 in. (152 mm) OC. Prior to installation of the intumescent sheet(s), a nom 1/4 in. (6 mm) diam continuous bead of caulk (Item 6) shall be applied as gasket over the steel support channel.

*Bearing the UL Classification Mark

Reprinted from the Online Certifications Directory with permission from Underwriters Laboratories Inc.
Copyright © 2010 Underwriters Laboratories Inc.®



System No. C-AJ-4056

September 20, 2011

ANSI/UL1479 (ASTM E814)

F Rating – 3 Hr

T Rating – 3/4 Hr

L Rating At Ambient – 7 and 22 CFM/sq ft (See Item 4)

L Rating At 400 F – 4 and 21 CFM/sq ft (See Item 4)r

CAN/ULC S115

F Rating – 3 Hr

FT Rating – 3/4 Hr

FH Rating – 3 Hr

FTH Rating – 3/4 Hr

L Rating At Ambient – 7 and 22 CFM/sq ft (See Item 4)

L Rating At 400 F – 4 and 21 CFM/sq ft (See Item 4)

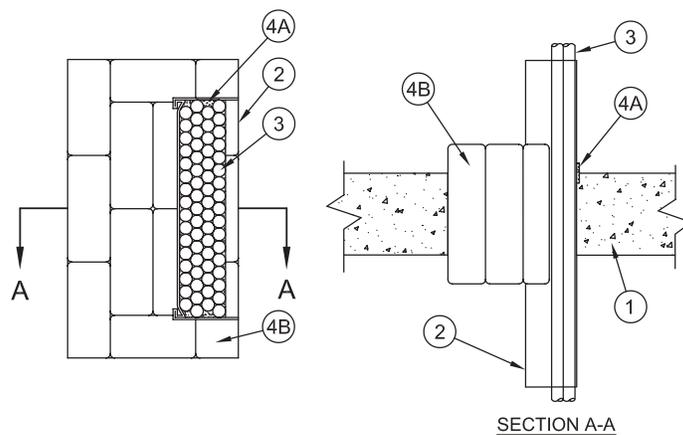

- Floor or Wall Assembly** – Min 4-1/2 in. (114 mm) thick reinforced lightweight or normal weight (100-150 pcf or 1600-2400 kg/m³) concrete. Wall may also be constructed of any UL Classified **Concrete Blocks***. Max area of opening is 528 in.² (0.34 m²) with a max dimension of 44 in. (1.2 m).
See **Concrete Blocks** (CAZT) category in the Fire Resistance Directory for names of manufacturers.
- Cable Tray** – Max 40 in. (1 m) wide by max 4 in. (102 mm) deep open ladder cable tray with channel-shaped side rails formed of min 0.058 in. (1.5 mm) thick (16 gauge) galv steel with nom 1 in. (25 mm) diam rungs spaced 9 in. (229 mm) OC or max 40 in. wide by max 4 in. (102 mm) deep open ladder cable tray with channel-shaped side rails formed from 0.060 in. (1.5 mm) thick aluminum with nom 1 in. (25 mm) diam rungs spaced 9 in. (229 mm) OC. Max one cable tray per opening. The annular space between the cable tray and the periphery of the opening will be min 0 in. (0 mm, point contact) to max 8 in. (203 mm). Cable tray to be rigidly supported on both sides of floor or wall assembly.
- Cables** – Aggregate cross-sectional area of cables in cable tray not to exceed 40 percent of the cross-sectional area of the cable tray based on a max 3 in. (76 mm) cable loading depth within the tray. Any combination of the following types and sizes of cables may be used:
 - Max 1/C 750 kcmil (or smaller) copper conductor cable with cross-linked polyethylene (XLPE) jacket.
 - Max 300 pair No. 22 AWG (or smaller) copper conductor telecommunication cables with polyvinyl chloride (PVC) insulation and jacket.
 - Max 7/C No. 12 AWG copper conductor power and control cables with XLPE or PVC insulation with XLPE or PVC jacket.
 - Max 4/C No. 2/0 AWG copper or aluminum conductor cables with PVC insulation and jacket..
 - Max 1-10/125 Fiber Optic (F.O) cable with PVC insulation and jacket.
 - Max No. 18 AWG Type RG coaxial cable with polyvinyl chloride insulation.
- Firestop System** – The firestop system shall consist of the following:
 - Fill Void or Cavity Material* – Putty** – Min 1/4 in. (6 mm) thick by min 2 in. (51 mm) width of putty wrapped around each cable such that putty extends approximately 1/2 in. (13 mm) above floor or beyond both surfaces of wall. Additional putty installed inside cable tray side rails to completely fill side rails within the opening and extending approximately 1/2 in. (13 mm) beyond both surfaces of floor or wall. After installation of pillows (Item 4B) all voids within the opening shall be filled with a min 1 in. (25 mm) thickness of putty. The individual cables may be wrapped with a min 1/4 in. (6 mm) thickness, min 2 in. (51 mm) width of putty such that the putty extends approximately 1/2 in. (13 mm) above top surface of floor or beyond both surfaces of wall.
3M COMPANY – MP+ or Cable Wrap
L Ratings are 7 and 4 CFM/sq ft. at ambient and 400° F, respectively, when individual cables are wrapped with 3M Cable Wrap or MP+ putty in accordance with the installation instructions. L Ratings are 22 and 21 CFM/sq ft. at ambient and 400° F, respectively, when individual cables are not wrapped with 3M Cable Wrap or MP+ putty.
 - Fill Void or Cavity Material* – Pillows** – Max 9 in. (229 mm) long by 6 in. (152 mm) wide by 2 and 3 in. (51 and 76 mm) thick plastic covered pillows tightly-packed into the opening to fill annular space between cable tray and periphery of opening. Pillows installed with 9 in. (229 mm) dimension projecting through floor or wall and centered within the opening.
3M COMPANY – Fire Barrier Pillow or Fire Barrier Self-Locking Pillows

*Bearing the UL Classification Mark

Reprinted from the Online Certifications Directory with permission from Underwriters Laboratories Inc.
Copyright © 2011 Underwriters Laboratories Inc.®



System No. C-AJ-4070

September 03, 2004

F Rating – 2 Hr

T Rating – 0 Hr

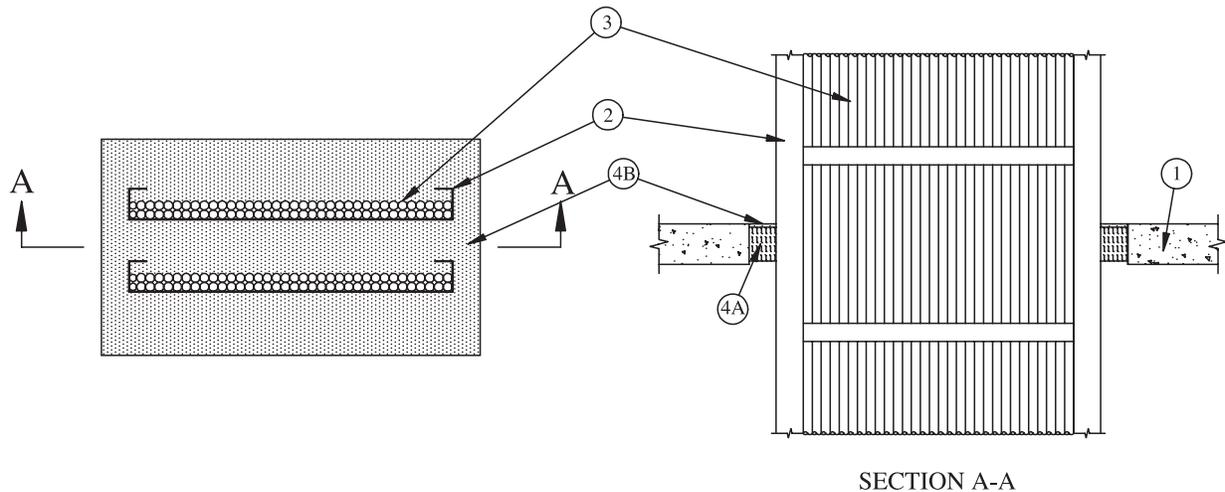

1. **Floor or Wall Assembly** – Min 4-1/2 in. (114 mm) thick reinforced lightweight or normal weight (100-150 pcf or 1600-2400 kg/m³) concrete. Wall may also be constructed of any UL Classified **Concrete Blocks***. Max area of opening is 1008 sq in. (697 cm²) with max dimension of 42 in. (1067 mm).
See **Concrete Blocks** (CAZT) category in the Fire Resistance Directory for names of manufacturers.
2. **Cable Trays** – A max of two cable trays are permitted per opening. Max 36 in. (914 mm) wide by max 4 in. (102 mm) deep open-ladder or solid-back cable trays with channel-shaped side rails formed of min 0.050 in. (1.27 mm) thick steel. Cable trays are provided with min 0.050 in. (1.27 mm) thick steel rungs spaced a max of 12 in. (305 mm) apart, or a min 0.050 in. (1.27 mm) thick steel solid back. The annular space between cable trays shall be a min of 2 in. to a max 7 in. (51 mm to max 178 mm). The annular space between cable trays and edge of opening shall be a min of 0 in. (point contact) to a max 7 in. (0 mm to max 178 mm).
3. **Cables** – Aggregate cross-sectional area of cables in cable trays to be max 40 percent of the cross-sectional area of the cable tray based on a max 3 in. (76 mm) cable loading depth within the cable tray. Any combination of the following types and sizes of cables may be used;
 - A. Max 200 pair No. 22 AWG (or smaller) copper conductor with polyvinyl chloride (PVC) insulation and jacketing material.
 - B. Max 1/C No. 750 kcmil (or smaller) copper conductor cable with cross-linked polyethylene (XLPE) jacket.
 - C. Max 7/C No. 12 AWG (or smaller) copper conductor power and control cables with XLPE or PVC insulation with XLPE or PVC jacket.
 - D. Max 3/C No. 3/0 AWG (or smaller) copper or aluminum conductor SER cables with PVC insulation and jacket.
 - E. Max 3/C No. 2/0 AWG (or smaller) copper conductor PVC jacketed aluminum clad or steel clad TECK 90 cable.
 - F. Max 110/125 fiber optic (F.O.) cable with PVC insulation and jacket.
 - G. Max 3/C with ground No. 8 AWG (or smaller) copper conductor NM cable with PVC insulation and jacket.
 - H. RG/U coaxial cable with fluorinated ethylene (FE) or PVC insulation and jacket.
 - I. Max 4 pair No. 24 AWG (or smaller) copper conductor data cable with Hylar jacket and insulation.
 - J. Max three conductor No. 12 AWG (or smaller) MC (BX) copper cable with polyvinyl chloride insulation and jacket materials.
 - K. **Through Penetrating Product*** - Any cables, **Armored Cable+** or **Metal Clad Cable+** currently Classified under the **Through Penetrating Product** category.
See **Through Penetrating Product** (XHLY) category in the Fire Resistance Directory for names of manufacturers.
4. **Packing Material** – Min 3-3/4 in. (95 mm) thickness of min 4pcf (64 kg/m³) mineral wool batt insulation firmly packed into the opening as a permanent form so that the thickness of the wool is compressed at least 50 percent. Packing material to be recessed from top surface of floor or from both surfaces of wall to accommodate the required thickness of fill material.
5. **Fill, Void or Cavity Material* – Sealant** – Min 3/8 in. (10 mm) thickness of sealant applied within the annulus, flush with top surface of floor or with both surfaces of wall. Min 3/8 in. (10 mm) bead of sealant applied at cable tray/concrete interface at point contact locations on top surface of floor or both surfaces of wall.

3M COMPANY— FB-1000 NS, FB-3000 WT or FB-1003 SL (floors only)

*Bearing the UL Classification Mark

+Bearing the UL Listing Mark

Reprinted from the Online Certifications Directory with permission from Underwriters Laboratories Inc.

Copyright © 2010 Underwriters Laboratories Inc.®



System No. C-AJ-4078

September 20, 2011

ANSI/UL1479 (ASTM E814)

F Rating – 2 Hr

T Rating – 3/4 Hr

CAN/ULC S115

F Rating – 2 Hr

FT Rating – 3/4 Hr

FH Rating – 2 Hr

FTH Rating – 3/4 Hr

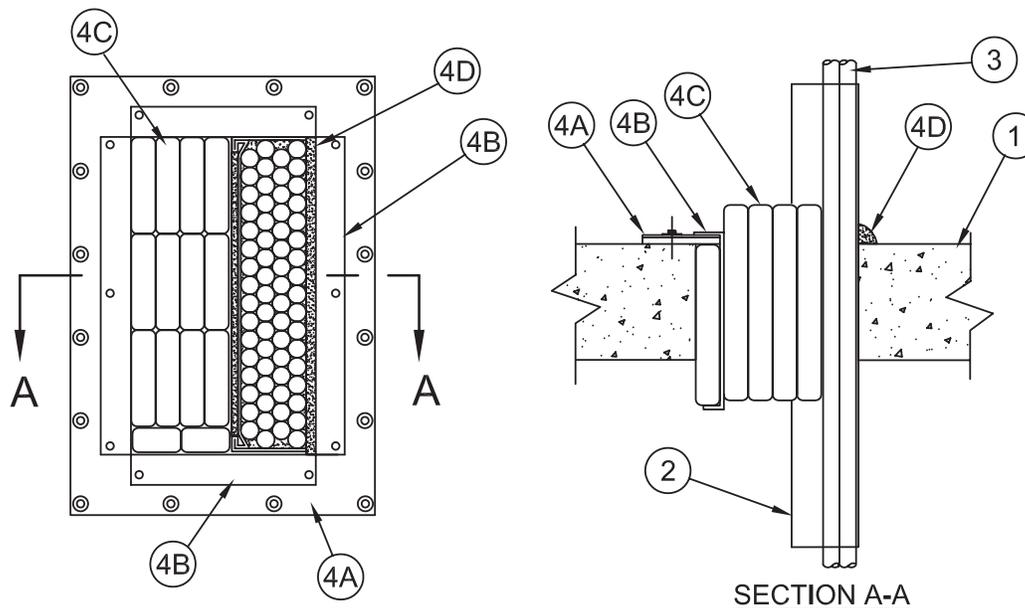

- Floor or Wall Assembly** – Min 4-1/2 in. (114 mm) thick reinforced lightweight or normal weight (100-150 pcf or 1600-2400 kg/m³) concrete. Wall may also be constructed of any UL Classified **Concrete Blocks***. Max area of opening is 528 in². (0.34 m²) with a max dimension of 44 in. (1.2 m).
See **Concrete Blocks** (CAZT) category in the Fire Resistance Directory for names of manufacturers.
- Cable Tray** – Max 40 in. (1 m) wide by max 4 in. (102 mm) deep open ladder cable tray with channel-shaped side rails formed of min 0.058 in. thick (1.5 mm) galv steel with nom 1 in. (25 mm) diam rungs spaced 9 in. (229 mm) OC or max 40 in. (1 m) wide by max 4 in. (102 mm) deep open ladder cable tray with channel-shaped side rails formed from 0.060 in. (1.5 mm) thick aluminum with nom 1 in. (25 mm) diam rungs spaced 9 in. (229 mm) OC. Max one cable tray per opening. The annular space between the cable tray and the periphery of the opening will be min 0 in. (0 mm, point contact) to max 8 in. (203 mm). Cable tray to be rigidly supported on both sides of floor or wall assembly.
- Cables** – Aggregate cross-sectional area of cables in cable tray not to exceed 40 percent of the cross-sectional area of the cable tray based on a max 3 in. (76 mm) cable loading depth within the tray. Any combination of the following types and sizes of cables may be used:
 - Max 1/C 750 kcmil (or smaller) copper conductor cable with cross-linked polyethylene (XLPE) jacket.
 - Max 300 pair No. 22 AWG (or smaller) copper conductor telecommunication cables with polyvinyl chloride (PVC) insulation and jacket.
 - Max 7/C No. 12 AWG copper conductor power and control cables with XLPE or PVC insulation with XLPE or PVC jacket.
 - Max 4/C No. 2/0 AWG copper or aluminum conductor cables with PVC insulation and jacket..
 - Max 1-10/125 Fiber Optic (F.O) cable with PVC insulation and jacket.
 - Max No. 18 AWG Type RG coaxial cable with polyvinyl chloride insulation.
- Firestop System** – The firestop system shall consist of the following:
 - Fill, Void or Cavity Material* – Intumescent Sheet** – Rigid aluminum foil faced sheet with galv steel sheet backer. Intumescent sheet cut to size and extending 2 in. (51 mm) beyond the periphery of the opening. Intumescent sheet with galv sheet face down and secured with nom 1/4 in. (6 mm) diam by 1 in. (25 mm) steel bolts with nuts and washers spaced max 6 in. (152 mm) OC on top surface of floor and both surfaces of wall.
3M COMPANY – Type CS-195+
 - Steel Angles** – Nom 9 by 0.028 in. (229 by 0.71 mm) thick channel shaped steel angles formed into a three sided steel sleeve within opening to retain pillows within opening. Top leg of steel angle extends a min 2 in. (51 mm) over composite sheet (Item 4B) and secured by means of No. 10 by 3/4 in. (19 mm) long sheet metal screws spaced 8 in. (203 mm) OC on top surface of floor or both surfaces of wall.
 - Fill Void or Cavity Material* – Pillows** – Nom 9 in. (229 mm) long by 6 in. (152 mm) wide by 2 and 3 in. (51 and 76 mm) thick plastic covered pillows tightly-packed into the opening to fill annular space between the cables and the steel angle enclosure (Item 4B). Pillows installed with 9 in. (229 mm) dimension projecting through the floor or wall and centered within the opening. Prior to the installation of the steel angle enclosure (Item 4A), additional pillows installed within the space between the inside surface of the steel angle enclosure and periphery of the opening.
3M COMPANY – Fire Barrier Pillow or Fire Barrier Self-Locking Pillows

Through Penetrations

Cable Trays

4000 Series

Concrete

CAJ

System No. C-AJ-4078 continued

- D. **Fill Void or Cavity Material* – Putty** – Min 1/4 in. (6 mm) thick by min 2 in. (51 mm) width of putty wrapped around each cable such that putty extends approximately 1/2 in. (13 mm) above floor or beyond both surfaces of wall. Additional putty installed inside cable tray side rails to completely fill side rails within the opening and extending approximately 1/2 in. (13 mm) beyond both surfaces of floor or wall. After installation of pillows (Item 4B) all voids within the opening shall be filled with a min 1 in. (25 mm) thickness of putty. The individual cables may be wrapped with a min 1/4 in. (6 mm) thickness, min 2 in. (51 mm) width of putty such that the putty extends approximately 1/2 in. (13 mm) above top surface of floor or beyond both surfaces of wall. At point contact location, min 1/2 in. (13 mm) thickness of putty applied at the concrete/cable tray interface on top surface of floor or both surfaces of wall.

3M COMPANY – MP+ or Cable Wrap

*Bearing the UL Classification Mark

Reprinted from the Online Certifications Directory with permission from Underwriters Laboratories Inc.
Copyright © 2011 Underwriters Laboratories Inc.®



Through Penetrations

Cable Trays

4000 Series

Concrete

CAJ

System No. C-AJ-4082

March 27, 2007

F Ratings — 2 and 3 Hr (See Item 1)

T Rating — 0 Hr

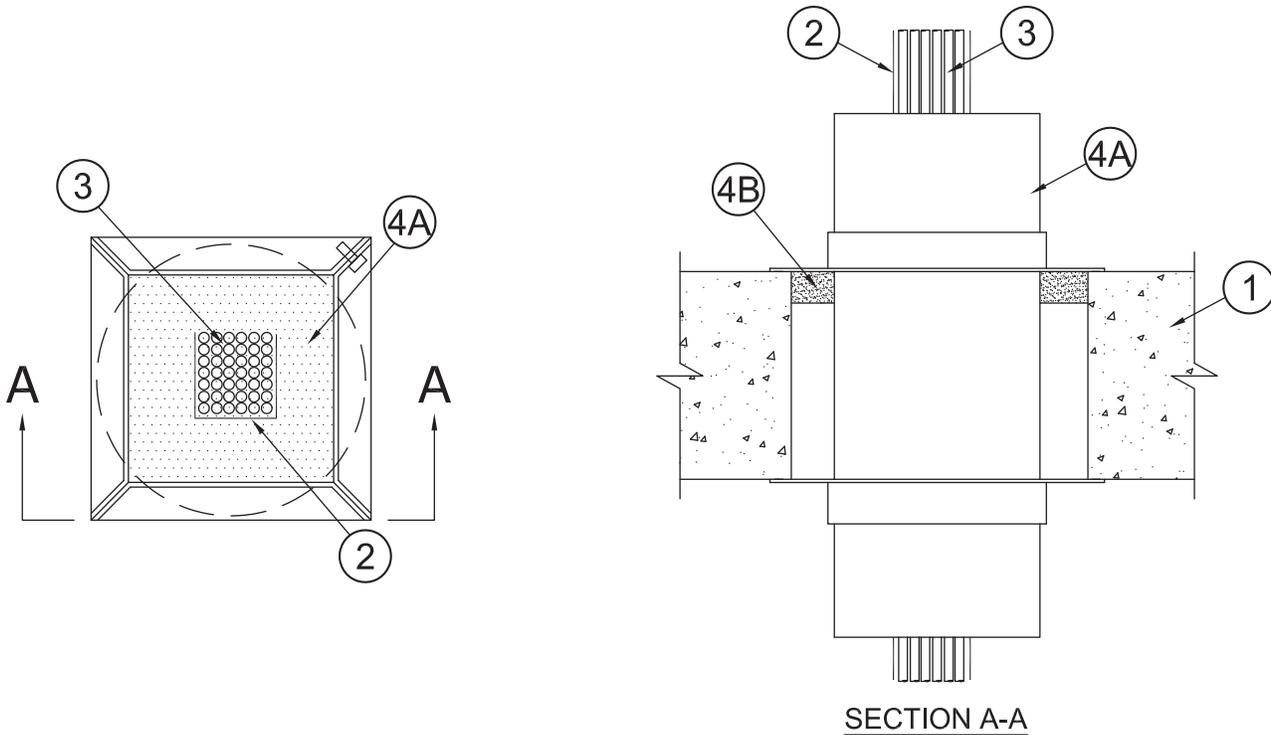

- 1. Floor or Wall Assembly** — Min 2-1/2 in. (64 mm) thick reinforced lightweight or normal weight (100-150 pcf or 1600-2400 kg/m³) concrete. Wall may also be constructed of any UL Classified **Concrete Blocks***. Max diam of opening is 6 in. (152 mm). **When thickness of floor or wall assembly is less than 4-1/2 in. (114 mm), F Rating is 2 hr.**

See **Concrete Blocks (CAZT)** category in Fire Resistance Directory for names of manufacturers.

- 2. Cable Tray*** — Nom 2 in. (51 mm) wide by 2 in. (51 mm) high welded wire basket cable tray formed from min 0.23 in. (5.8 mm) thick steel wires in the longitudinal direction and 0.19 in. (4.8 mm) wires in the transverse direction. Transverse wires shall be spaced max 4 in. OC. One cable tray shall be centered within the firestop device (Item 4A). The annular space between the cable tray and the periphery of the device shall be a nom 1 in. (25 mm). Cable tray to be rigidly supported on both sides of floor or wall assembly.
- 3. Cables** — Cable fill within cable tray shall be a min 0 in. (0 mm, 0% visual fill) to a max 2 in. (51 mm, 100% visual fill). Cable bundle to be rigidly supported on both sides of floor or wall assembly. Any combination of the following types and sizes of cables may be used:
 - Max 2/C No. 18 AWG copper conductor thermostat cable with polyvinyl chloride (PVC) insulation and jacket materials.
 - Max 4 pair No. 24 AWG copper conductor Cat5e or Cat 6 telephone cable with PVC insulation and jacket materials.
 - Max RG/U (or smaller) coaxial cable with foam high density polyethylene insulation and PVC jacket materials.
 - Max 3/C (with ground) No. 14 AWG (or smaller) nonmetallic sheathed (Romex) cable with PVC insulation and jacket materials.
 - Max 1/C No. 8 AWG copper conductor cable with PVC insulation and nylon jacket materials.
 - Max 12 core No. 26 AWG shielded multi coax cable with foam high density polyethylene insulation and PVC jacket.
 - Max 48MM62.5 micron fiber optic cables with having a min FT-6 rating.
 - Max 62.5/125 micron fiber optic cables with having a min Riser rating.
 - Max 1/C 3/0 AWG copper conductor cable with PVC insulation and jacket materials.
 - Max three copper conductors (with ground) No. 12 AWG **Metal Clad Cable+**.
 - Max four copper conductors No. 2 AWG **Metal Clad Cable+**.

AFC CABLE SYSTEMS INC

- Max 1/C 2/0 AWG non halogen copper conductor cable.
 - Max 300 pair No. 24 AWG copper conductor telephone cable with PVC insulation and jacket materials.
 - Max 30 pair No. 22 copper conductor shielded switchboard cable with PVC insulation and jacket materials.
 - Max RG/6 (or smaller) coaxial cable with fluorinated ethylene (FE) or PVC insulation and jacket materials.
 - Max RG/U (or smaller) coaxial cable with fluorinated ethylene (FE) or PVC insulation and jacket materials.
 - Max 7/C No. 12 AWG copper conductors with PVC insulation and jacket materials.
 - Max 4 pair No. 23 AWG copper conductor Cat 6 telephone cable with PVC insulation and jacket materials.
 - Max three copper conductors (with ground) No. 12 AWG steel **Armored Cable+**.
 - Max 04-02 2 5M fiber optic cables having a max diameter of 0.450 in. (11.4 mm).
 - Max 1/C No. 750 kcmil copper conductors with PVC insulation and fabric jacket materials.
 - Max 3/C with ground No. 2/0 AWG aluminum conductor SER cable with cross linked polyethylene (XLPE) insulation and PVC jacket.
- 4. Firestop System** — The firestop system shall consist of the following:
 - Firestop Device*** — The firestop device consists of a nom 4 by 4 by 10 in. (102 by 102 by 254 mm) powder coated steel transit incorporating internal intumescent material, foam plugs and mounting flanges. Firestop device to be centered within opening and installed with ends projecting an equal distance beyond each surface of the floor or wall assembly in accordance with the accompanying

System No. C-AJ-4082 *continued*

installation instructions. The annular space between the firestop device and the periphery of the opening shall be nom 1 in. (25 mm). Firestop devices secured in place by means of fill material (Item 4B) and steel split mounting flanges sized to accommodate the firestop device. Steel split mounting flanges installed on both sides of floor or wall after installation of fill material and secured to together with supplied steel set screws. Nom 1 in. (25 mm) thick pre-cut foam plugs sized to accommodate the cable bundle and installed flush with each end of device on both sides of floor or wall assembly.

3M COMPANY — 3M Fire Barrier Pass-Through Device

B. Fill, Void or Cavity Materials* - Caulk or Putty — Min 1 in. (25 mm) thickness of fill material applied within the annulus, flush with top surface of floor or with both surfaces of wall prior to the installation of the mounting flanges. Also as an option, foam plugs may be recessed into device and the recess filled with putty or caulk flush with the ends of the device.

3M COMPANY — Moldable Putty+, CP 25WB+, IC 15WB+, 3000 WT

* Indicates such products shall bear the UL or cUL Certification Mark for jurisdictions employing the UL or cUL Certification (such as Canada), respectively.

+Bearing the UL Listing Mark



Through Penetrations

Cable Trays

4000 Series

Concrete

CAJ

System No. C-AJ-4098

August 01, 2013

ANSI/UL1479 (ASTM E814)

F Ratings – 2 Hr

T Rating – 1/4 Hr

L Rating at Ambient - Less than 1 CFM/sq ft

L Rating at 400 F - Less than 1 CFM/sq ft

CAN/ULC S115

F Ratings – 2 Hr

FT Rating – 1/4 Hr

FH Ratings – 2 Hr

FTH Rating – 1/4 Hr

L Rating at Ambient - Less than 1 CFM/sq ft

L Rating at 400 F - Less than 1 CFM/sq ft

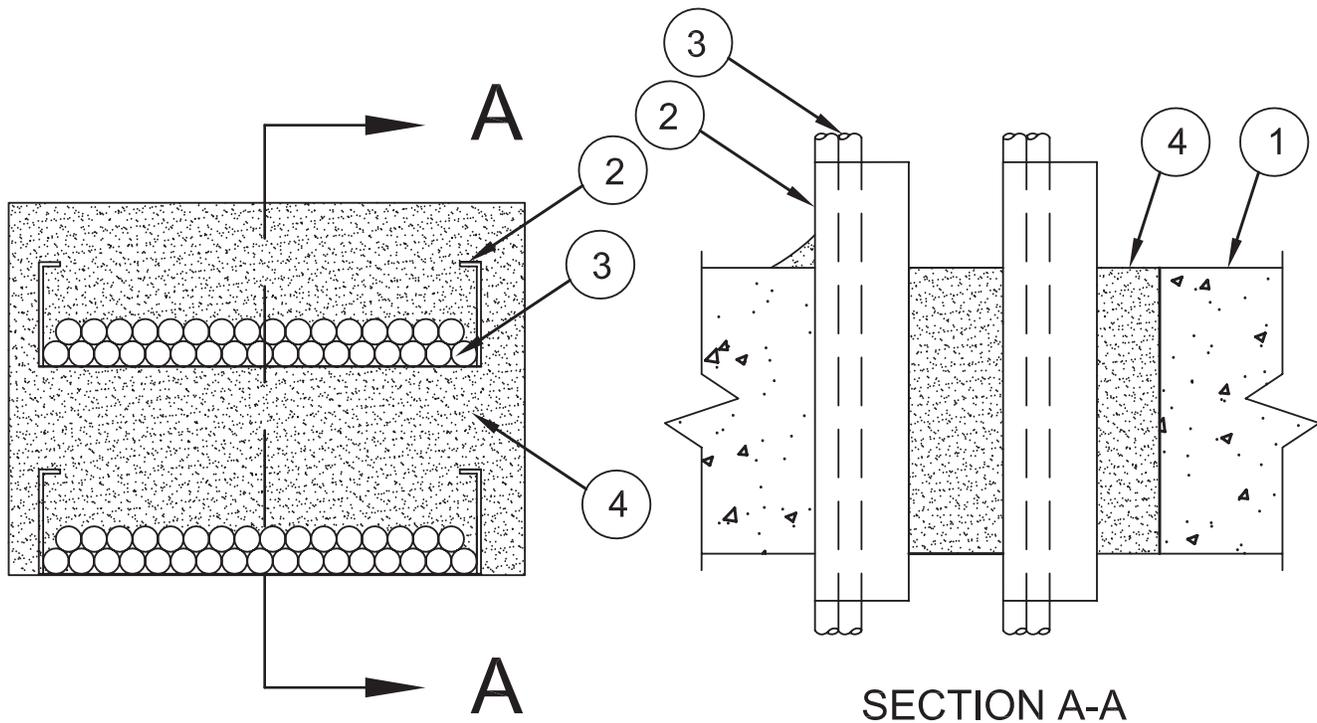

- Floor or Wall Assembly** – Min 2-1/2 in. (64 mm) thick lightweight or normal weight (100-150 pcf or 1600-2400 kg/m³) concrete. The area of the opening shall be max 512 in.2 (3303 cm²) with a max dimension of 32 in. (813 mm).
- Cable Tray*** – Max two 24 in. (610 mm) wide by max 6 in. (151 mm) deep open-ladder cable tray with channel-shaped side rails formed of 0.065 in. (1.651 mm) to 0.10 in. (2.54 mm) thick aluminum or min 0.060 in. (1.65 mm) thick galv steel. The annular space between the cable trays shall be min 2 in. (51 mm). The annular space between the cable tray and the periphery of the opening shall be min 0 in. (point contact) to max 2 in. (51 mm). Cable tray to be rigidly supported on both sides of floor or wall assembly.
- Cables** – Aggregate cross-sectional area of cables in cable tray to be max 45 percent of the cross-sectional area of the cable tray based on a max 5 in. (127 mm) cable loading depth within the cable tray. Any combination of the following types and sizes of copper conductor or fiber optic cables may be used:
 - Max 7/C No. 12 AWG with polyvinyl chloride (PVC) insulation and PVC jacket.
 - Max 300 pair - No. 24 AWG cable with PVC insulation and jacket.
 - 1/C, max 500 kcmil with cross-linked polyethylene (XLPE) insulation and jacket.
- Fill, Void or Cavity Material* – Foam** – Min 2-1/2 in. (64 mm) thickness of fill material applied within the annulus, flush with top surface of floor or both surfaces of wall. Foam to be injected into the interstices between all cables. An additional 1/2 in. (13 mm) bead of foam shall be applied at the point contact locations.

3M COMPANY – Fire Barrier Rated Foam, FIP 1-Step

*Bearing the UL Classification Mark

Reprinted from the Online Certifications Directory with permission from UL

© 2013 UL LLC



System No. C-AJ-4109

July 01, 2016

| ANSI/UL1479 (ASTM E814) | CAN/ULC S115 |
|---|--|
| F Rating — 2 Hr | F Rating — 2 Hr |
| T Rating — 3/4 Hr | FT Rating — 3/4 Hr |
| L Rating At Ambient — Less Than 1 CFM/sq ft | FH Rating — 2 Hr |
| L Rating At 400 F — Less Than 1 CFM/sq ft | FTH Rating — 3/4 Hr |
| | L Rating At Ambient — Less Than 5.1 L/s/m ² |
| | L Rating At 400 F — Less Than 5.1 L/s/m ² |

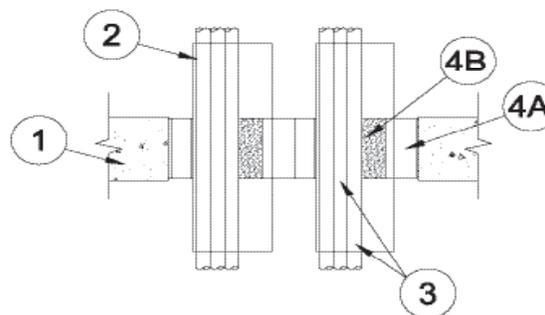
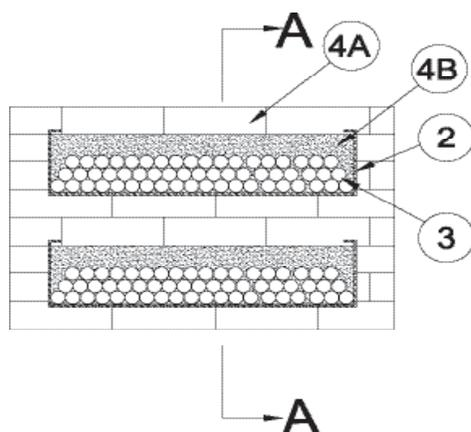

- Floor or Wall Assembly** — Min 4-1/2 in. (114 mm) thick reinforced lightweight or normal weight (100-150 pcf or 1600-2400 kg/m³) concrete. Wall may also be constructed of any UL Classified **Concrete Blocks***. Max area of opening is 600 in² (3871 cm²) with max dimension of 30 in. (762 mm).
See **Concrete Blocks (CAZT)** category in the Fire Resistance Directory for names of manufacturers.
- Cable Trays*** — A maximum of two 24 in. (610 mm) wide by 6 in. (31 mm) deep (or smaller) open-ladder cable tray with channel-shaped side rails formed of min 0.047 in. (1.2 mm) thick aluminum or galv steel and with 1-1/2 in. (38 mm) wide by 1 in. (25 mm) channel shape rungs spaced 9 in. (229 mm) OC. The annular space between the cable trays shall be min 2 in. (51 mm) to max 7 in. (178 mm). The annular space between the cable tray and the periphery of the opening shall be min 2 in. (51 mm) at rails and min 1/2 in. (13 mm) at rungs. Cable trays to be rigidly supported on both sides of floor or wall assembly.
- Cables** — Aggregate cross-sectional area of cables in each cable tray to be max 45 percent of the cross-sectional area of the cable tray. Any combination of the following types and sizes of copper conductor or fiber optic cables may be used:
 - Max 1/C, 750 kcmil (or smaller) copper conductor cable with cross-linked polyethylene (XLPE) insulation and polyvinyl chloride (PVC) jacket.
 - Max 7/C No. 12 AWG (or smaller) copper conductor power and control cables with cross-linked polyethylene (XLPE) insulation or polyvinyl chloride (PVC) jacket.
 - Max 3/C No. 2/0 AWG (or smaller) copper conductor SER cable with polyvinyl chloride (PVC) insulation and jacket.
 - Max 3/C No. 2/0 AWG (or smaller) copper conductor PVC jacketed aluminum clad or steel clad TECK 90 cable.
 - Max 300 pair, 200 pair, and 150 pair (or smaller) No. 22 AWG copper conductor telephone cable with PVC insulation and jacket materials.
 - Max 110/125 fiber optic (F.O.) cable with PVC insulation and jacket.
 - Max 3/C (with ground) No. 14 AWG (or smaller) nonmetallic sheathed (Romex) cable with PVC insulation and jacket materials.
 - Max RG/U (or smaller) coaxial cable with fluorinated ethylene (FE) or PVC insulation and jacket material.
 - Max 4 pair No. 24 AWG (or smaller) copper conductor Cat 5e or Cat 6 telephone cable with PVC insulation and jacket materials.
- Through Penetrating Product*** — Any cables, **Armored Cable+** or **Metal Clad Cable+** currently Classified under the Through Penetrating Product category. See **Through Penetrating Product (XHLY)** category in the Fire Resistance Directory for names of manufacturers.
- Max three conductor No. 12 AWG (or smaller) MC (BX) copper cable with polyvinyl chloride insulation and jacket materials..
- Firestop System** — The firestop system shall consist of the following:
 - Fill, Void or Cavity Material*** — Blocks installed with 5 in. (127 mm) dimension projecting through opening flush with bottom surface of floor or centered in wall. In solid concrete floors or walls thicker than 5 in. (127 mm), the fire block can be installed flush with top or bottom surface of floor or flush with one side of wall. In concrete block walls, fire block to fill the entire thickness of wall opening unless concrete block is solid filled. Blocks to be firmly packed to fill the opening area between and around the penetrants. Blocks can be cut to fit around penetrants and within smaller annular spaces.
3M COMPANY 3M FIRE PROTECTION PRODUCTS — 3M™ Fire Barrier Block B258, 3M™ Fire Barrier Plank PK39
 - Fill, Void or Cavity Material*** — **Foam** — Fill material to be forced between blocks and periphery of opening to the max extent possible. Fill material to be injected in-between blocks and penetrants to the full depth of the blocks, as well as in any visible voids/openings between blocks (Item 4B). In addition, foam shall be injected to the maximum extent possible within the interstices between all cables in the cable tray.
3M COMPANY 3M FIRE PROTECTION PRODUCTS — Fire Barrier Rated Foam, FIP 1-Step

Through Penetrations
Cable Trays
4000 Series
Concrete
CAJ

System No. C-AJ-4109 *continued*

* Indicates such products shall bear the UL or cUL Certification Mark for jurisdictions employing the UL or cUL Certification (such as Canada), respectively.



Through Penetrations

Cable Trays

4000 Series

Concrete

CAJ

System No. W-J-4044

September 08, 2004

F Rating – 2 Hr

T Rating – 1/2 Hr

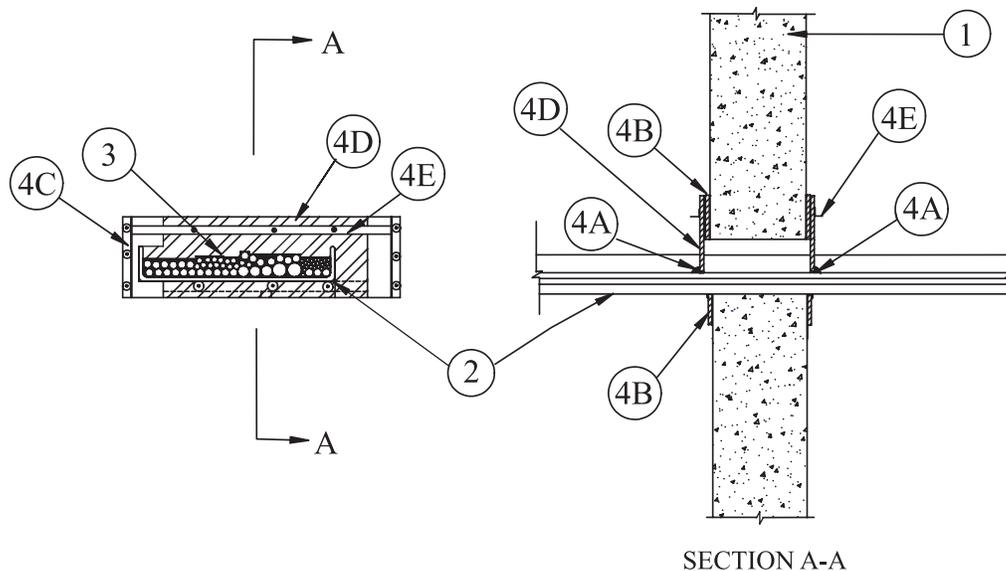

1. **Wall Assembly** – Min 6 in. (152 mm) thick reinforced lightweight or normal weight (100-150 pcf or 1200-6400 kg/m³) concrete wall. Wall may also be constructed of any UL Classified **Concrete Blocks***. Max area of opening is 180 in.² (1161 cm²) with a max dimension of 30 in. (762 mm).
See **Concrete Blocks** (CAZT) category in the Fire Resistance Directory for names of manufacturers.
2. **Cable Tray** – Max 24 in. (610 mm) wide by max 4 in. (102 mm) deep open-ladder cable tray with channel-shaped side rails formed of min 0.058 in. thick (16 gauge) galv steel with nom 1 in. (25 mm) diam rungs spaced 9 in. (229 mm) OC or max 24 in. (610 mm) wide by max 4 in. (102 mm) deep open ladder cable tray with channel-shaped side rails formed from 0.060 in. thick aluminum with nom 1 in. (25 mm) diam rungs spaced 9 in. (229 mm) OC. The min annular space between the cable tray and the periphery of opening shall be 0 in. (point contact). The max annular space between the cable tray and the periphery of the opening shall be 2 in. (51 mm) to top of opening and 6 in. to side of opening. Cable tray to be rigidly supported on both sides of wall assembly.
3. **Cables** – Aggregate cross-sectional area of cables in cable tray to be min 0 percent to max 40 percent of the cross-sectional area of the cable tray based on a max 3 in. (76 mm) cable loading depth within the tray. Any combination of the following types and sizes of cables may be used:
 - A. Max 750 kcmil single-conductor power cables; cross-linked polyethylene (XLPE) insulation.
 - B. Max 7C No. 12 AWG (or smaller) multi conductor power and control cables; XLPE insulation, XLPE or polyvinyl chloride (PVC) jacket.
 - C. Max 300 pair No. 22 AWG (or smaller) copper conductor with PVC insulation and jacket.
 - D. Max No. 18 AWG RG 6/U coaxial cable with PVC insulation and jacket.
 - E. Max 4/C No. 2/0 AWG (or smaller) copper or aluminum conductor cables with XLPE or PVC insulation and jacket.
 - F. Max 1-10/125 Fiber Optic (F.O) cable with PVC insulation and jacket.
4. **Firestop System** – The firestop system shall consist of the following:
 - A. **Fill, Void or Cavity Materials* – Caulk, Sealant or Putty** – A nom 1 in. thick by 1 in. (25 mm by 25 mm) wide strip of moldable putty or caulk shall be applied to follow the contours of the cable fill on bottom of cable tray and project approx 1/2 in. to 7/8 in. (13 mm to 22 mm) beyond surface of wall on both sides of wall. A min 5/8 in (16 mm) width of caulk or putty shall be applied to fill the channel of the cable tray side-rails and positioned flush with to projecting a max of 1/2 in. (13 mm) beyond the outside surface of both sides of wall. A min 1/8 in. (3.2 mm) thickness by 2 in. (51 mm) wide strip of putty shall be applied over each layer or row of cables and project approx 1/2 in. to 7/8 in. (12 mm to 22 mm) beyond the outside surface of the intumescent slide sheet on each side of wall assembly. After installation of the intumescent slide sheet, putty pressed into cable fill and against intumescent sheet to fill all openings. Nom 1/2 in. (13 mm) diam “ropes” of putty applied around cable tray side-rail members at their egress from the intumescent sheet (Item 4B) and pressed into the intersections.
3M COMPANY – CP 25WB+ caulk, FB-3000 WT sealant or MP+ Stix putty
 - B. **Fill, Void or Cavity Materials* – Intumescent Sheet** – Rigid aluminum foil-faced sheet with galv steel sheet backer. Min 2 in. (51 mm) wide sheets cut to frame opening on all sides and overlap a min 2 in. (51 mm) onto wall surface. Side pieces of sheets shall be cut to cover annular space to side rails. Sheet to be installed with the galv steel sheet backer exposed (aluminum foil facing against wall surface) and secured to wall with min 2-1/4 in. (57 mm) long bugle-head steel masonry anchors in conjunction with min 3/4 in. (19 mm) steel washers. Fasteners spaced a max 1 in. (25 mm) from each end and each seam of sheets and not to exceed 6 in. (152 mm) OC.
3M COMPANY – CS-195+
 - C. **Steel Z Angle Retainer Plates** – Min 16 gauge galv steel retaining plates 4 in. (102 mm) wide overall, 3 in. by 1 in. (76 mm by 25 mm) with 3/8 in. (10 mm) deep break. Plate to be height of opening plus 4 in. (102 mm). Plate to be installed over previously installed intumescent sheet on both sides of opening with min 2-1/4 in. (57 mm) long steel masonry anchors in conjunction with min 3/4 in. (19 mm) diam steel washers. Fasteners spaced a max 1 in. (25 mm) from top and bottom of plates and not to exceed 6 in. (152 mm) OC. Plates to extend 2 in. (51 mm) above and below opening. The 3 in. (76 mm) dimension of the plates installed such that the outside edges of plates are flush with intumescent sheet outside edges.

System No. W-J-4044 continued

- D. **Fill, Void or Cavity Materials* – Intumescent Sheet** – (Slide Sheet) – Slide sheet cut to width of opening to allow installation into Z retaining angle brackets. Bottom of sheet cut to closely follow the contours of the cable fill within the cable tray. Slide sheet to be of sufficient height to overlap top of opening min 2 in. (51 mm). Sheet to be installed with the galv steel sheet backer exposed.
 - E. **Steel Reinforcement Angle** – Min 1/8 in. (3.2 mm) thick 1 in. by 1 in. (25 mm by 25 mm) steel angle. Angle to be placed midway across width of slide sheet. Angle attached to sheet with 1/4 in. (6 mm) long steel sheet metal TEK screws spaced max 4 in. (102 mm) from each end and a max 9 in. (229 mm) O.C. Screws not used on ends over angle retainer plate.
 - F. **Fill, Void or Cavity Materials* – Graphite Seal** – (Not Shown) – One layer of 1/2 in. (13 mm) wide by 1/16 in. (1.6 mm) thick adhesive backed graphite intumescent seal positioned under intumescent slide sheet 1/2 in (13 mm) from top edge of slide sheet.
- 3M COMPANY** – E-FIS or Ultra GS seals

*Bearing the UL Classification Mark

Reprinted from the Online Certifications Directory with permission from Underwriters Laboratories Inc.
Copyright © 2010 Underwriters Laboratories Inc.®



Through Penetrations

Cable Trays

4000 Series

Concrete

WJ

System No. W-J-4055

September 20, 2011

ANSI/UL1479 (ASTM E814)

F Rating – 2 Hr

T Rating – 1/2 Hr

CAN/ULC S115

F Rating – 2 Hr

FT Rating – 1/2 Hr

FH Rating – 2 Hr

FTH Rating – 1/2 Hr

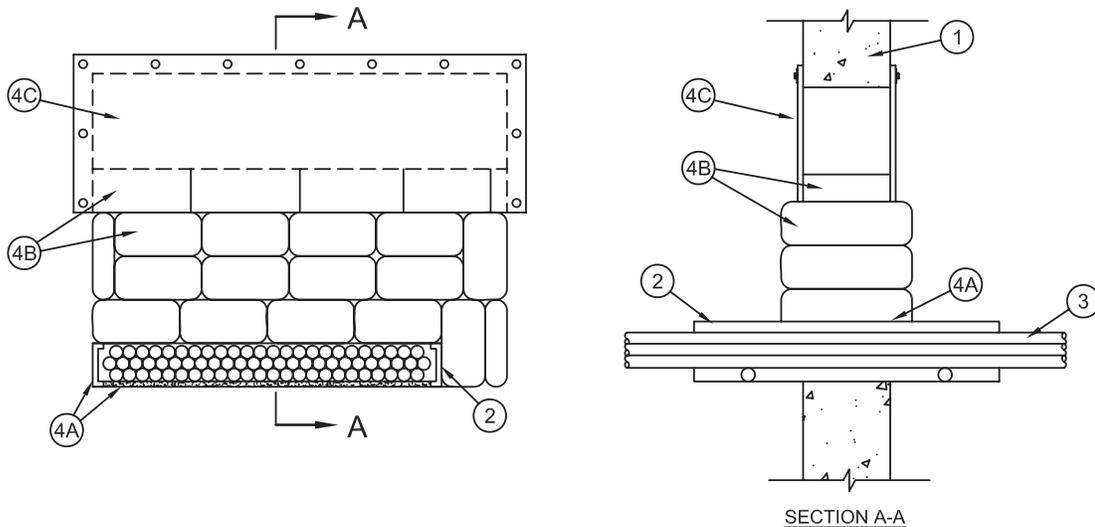

1. **Wall Assembly** – Min 6 in. (152 mm) thick reinforced lightweight or normal weight (100-150 pcf or 1600-2400 kg/m³) concrete wall. Wall may also be constructed of any UL Classified **Concrete Blocks***. Max area of opening is 720 in.² (0.46 m²) with a max dimension of 30 in. (762 mm).
See **Concrete Blocks (CAZT)** category in the Fire Resistance Directory for names of manufacturers.
2. **Cable Tray** – Max 24 in. (610 mm) wide by max 4 in. (102 mm) deep open ladder cable tray with channel-shaped side rails formed of min 0.058 in. thick (1.47 mm) galv steel with nom 1 in. (25 mm) diam rungs spaced 9 in. (229 mm) OC or max 24 in. (610 mm) wide by max 4 in. (102 mm) deep open ladder cable tray with channel-shaped side rails formed from 0.060 in. (1.52 mm) thick aluminum with nom 1 in. (25 mm) diam rungs spaced 9 in. (229 mm) OC. Max two cable trays per opening. The annular space between the cable trays to be min 6 in. (152 mm) to max 18 in. (457 mm). The annular space between the cable trays and the periphery of the opening to be min 0 in. (0 mm, point contact) to max 18 in. (457 mm). Cable trays to be rigidly supported on both sides of wall assembly.
3. **Cables** – Aggregate cross-sectional area of cables in cable tray not to exceed 40 percent of the cross-sectional area of the cable tray based on a max 3 in. (76 mm) cable loading depth within the tray. Any combination of the following types and sizes of cables may be used:
 - A. Max 1/C 750 kcmil (or smaller) copper conductor cable with cross-linked polyethylene (XLPE) jacket.
 - B. Max 300 pair No. 22 AWG (or smaller) copper conductor telecommunication cables with polyvinyl chloride (PVC) insulation and jacket.
 - C. Max 7/C No. 12 AWG copper conductor power and control cables with XLPE or PVC insulation with XLPE or PVC jacket.
 - D. Max 4/C No. 2/0 AWG copper or aluminum conductor cables with PVC insulation and jacket.
 - E. Max 10/125 Fiber Optic (F.O) cable with PVC insulation and jacket.
 - F. Max No. 18 AWG Type RG coaxial cable with polyvinyl chloride insulation.
4. **Firestop System** – The firestop system shall consist of the following:
 - A. **Fill Void or Cavity Material* – Putty** – Min 1/2 in. (13 mm) thickness of putty formed to a min 1 in. (25 mm) width and applied within annulus at the bottom corners of opening and extending a min 1 in. (25 mm) in both directions from each corners, flush with both surfaces of wall. Min 5/8 in. (16 mm) thickness of putty installed between bottom of cable tray and bottom of opening on both surfaces of wall. As an option, the putty between the bottom of the cable tray and the bottom of the opening may be replaced by pillows (Item 4B), provided the annular space is such that the pillows can be tightly fitted into the annular space. After installation of pillows and intumescent sheet (Items 4B and 4C), all voids within the opening shall be filled with a min 1 in. (25 mm) thickness of putty on both sides of wall.
3M COMPANY – MP+ Putty
 - B. **Fill Void or Cavity Material* – Pillows** – Max 9 in. (229 mm) long by 6 in. (152 mm) wide by 2 and 3 in. (51 and 76 mm) thick plastic covered pillows tightly-packed to fill annular space between the cable trays and periphery of opening and the annular space between the cable trays when two trays are installed within the opening. A min of two rows of pillows to be installed above the top cable tray in opening. Pillows installed with 9 in. (229 mm) dimension projecting through wall and centered within the opening except that the top row of pillows in the opening shall be installed with the 6 in. (152 mm) dimension centered in the wall such that the top row is completely covered by the intumescent sheet (Item 4C).
3M COMPANY – Fire Barrier Pillow or Fire Barrier Self-Locking Pillows

System No. W-J-4055 continued

- C. **Fill, Void or Cavity Materials* – Intumescent Sheet** – Rigid aluminum foil-faced sheet with galv steel sheet backer. The one piece sheet shall be cut to lap a min of 2 in. (51 mm) onto the wall at the top and sides of the opening on both sides of the wall. Sheet shall be cut to completely lap the top row of pillows above the top cable tray on both sides of the wall. Sheet to be installed with the galv steel sheet backer exposed (aluminum foil facing against wall surface) and secured to wall with min 1/4 in. (6 mm) diam by 2-1/4 in. (57 mm) long steel masonry anchors in conjunction with min 1-1/4 in. (32 mm) diam steel washers. Max spacing of anchors not to exceed 6 in. (152 mm) with fasteners located a max 1 in. (25 mm) from each corner of the sheet.

3M COMPANY – Type CS-195+ Sheet

*Bearing the UL Classification Mark

Reprinted from the Online Certifications Directory with permission from Underwriters Laboratories Inc.
Copyright © 2011 Underwriters Laboratories Inc.®



Through Penetrations

Cable Trays

4000 Series

Concrete

WJ

System No. W-J-4062

September 20, 2011

ANSI/UL1479 (ASTM E814)

F Rating – 2 Hr

T Rating – 3/4 Hr

CAN/ULC S115

F Rating – 2 Hr

FT Rating – 3/4 Hr

FH Rating – 2 Hr

FTH Rating – 3/4 Hr

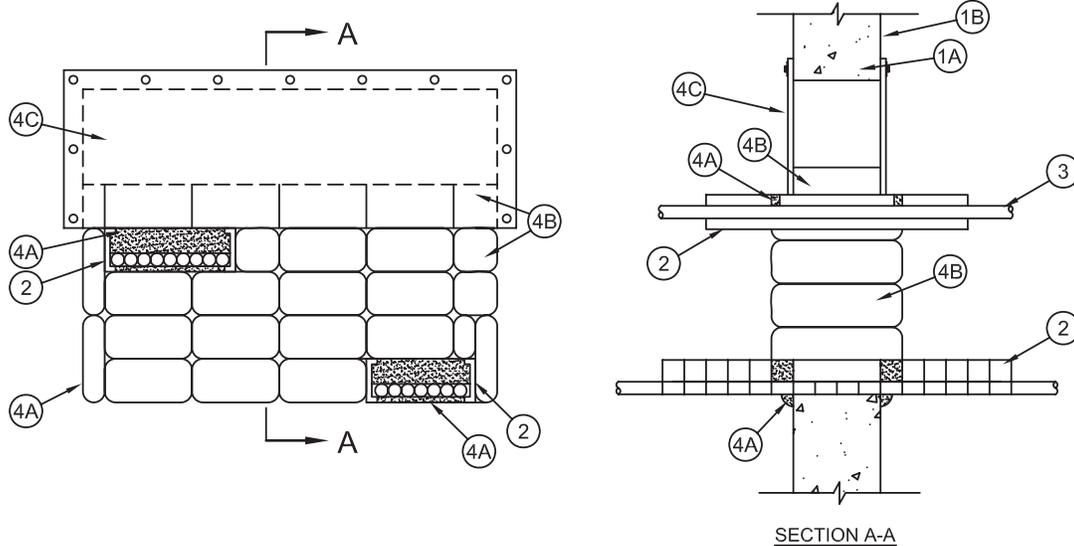

1. **Wall Assembly** – Min 6 in. thick reinforced lightweight or normal weight (100-150 pcf or 1600-2400 kg/m³) concrete wall. Wall may also be constructed of any UL Classified **Concrete Blocks***. Max area of opening is 720 in.² (0.46 m²) with a max dimension of 30 in. (762 mm). See **Concrete Blocks (CAZT)** category in the Fire Resistance Directory for names of manufacturers.
2. **Cable Tray** – Max 12 in. (305 mm) wide by max 1-1/2 in. (38 mm) deep open ladder cable tray with channel-shaped side rails formed of min 0.062 in. thick (1.6 mm) aluminum with nom 1 in. (25 mm) wide by 1 in. (13 mm) high rungs spaced 9 in. (229 mm) OC or max 8-3/4 in. (222 mm) wide by max 2-1/2 in. (64 mm) deep welded wire basket cable tray formed from min 0.198 in. (5 mm) thick steel and having a max 2 by 4 in. (51 by 102 mm) grid. Max two cable trays per opening. The annular space between the cable trays shall be min 6 in. (152 mm) to max 12 in. (305 mm). The annular space between the cable trays and the periphery of the opening shall be min 1-1/2 in. (38 mm) to max 20 in. (508 mm). Cable trays to be rigidly supported on both sides of wall assembly.
3. **Cables** – Aggregate cross-sectional area of cables in cable tray not to exceed 40 percent of the cross-sectional area of the open ladder aluminum cable tray based on a max 1-1/2 in. (38 mm) cable loading depth. Aggregate cross-sectional area of cables in welded wire basket cable tray not to exceed 23 percent of the cross-sectional area of the welded wire basket cable tray based on a max 1-1/2 in. (38 mm) cable loading depth. Any combination of the following types and sizes of cables may be used:
 - A. Max 1/C 750 kcmil (or smaller) copper conductor cable with cross-linked polyethylene (XLPE) jacket.
 - B. Max 300 pair No. 22 AWG (or smaller) copper conductor telecommunication cables with polyvinyl chloride (PVC) insulation and jacket.
 - C. Max 7/C No. 12 AWG copper conductor power and control cables with XLPE or PVC insulation with XLPE or PVC jacket.
 - D. Max 4/C No. 2/0 AWG copper or aluminum conductor cables with PVC insulation and jacket.
 - E. Max 1-10/125 Fiber Optic (FO) cable with PVC insulation and jacket.
 - F. Max No. 18 AWG Type RG coaxial cable with polyvinyl chloride insulation.
4. **Firestop System** – The firestop system shall consist of the following:
 - A. **Fill Void or Cavity Material* – Putty** – Min 1/2 in. (13 mm) thickness of putty formed to a min 1 in. (25 mm) width and applied within annulus at the bottom corners of opening and extending a min 1 in. (25 mm) in both directions from each corner, flush with both surfaces of wall. Min 5/8 in. (16 mm) thickness of putty installed between bottom of cable tray and bottom of opening and between top of cable tray and bottom of composite sheet on both surfaces of wall. As an option, the putty between the bottom of the cable tray and the bottom of the opening may be replaced by pillows (Item 4B), provided the annular space is such that the pillows can be tightly fitted into the annular space. After installation of pillows and intumescent sheet (Items 4B and 4C), all voids within the opening shall be filled with a min 1 in. (25 mm) thickness of putty on both sides of wall.
3M COMPANY – MP+
 - B. **Fill Void or Cavity Material* – Pillows** – Max 9 in. (229 mm) long by 6 in. (152 mm) wide by 2 and 3 in. (51 and 76 mm) thick plastic covered pillows tightly-packed to fill annular space between the cable trays and periphery of opening and the annular space between the cable trays when two trays are installed within the opening. Pillows installed with 9 in. (229 mm) dimension projecting through wall and centered within the opening except that the top row of pillows in the opening shall be installed with the 6 in. (152 mm) dimension centered in the wall such that the top row is completely covered by the intumescent sheet (Item 4C).
3M COMPANY – Fire Barrier Pillow or Fire Barrier Self-Locking Pillows

System No. W-J-4062 continued

- C. **Fill, Void or Cavity Materials* – Intumescent Sheet** – Rigid aluminum foil-faced sheet with galv steel sheet backer. The one piece sheet shall be cut to lap a min of 2 in. (51 mm) onto the wall at the top and sides of the opening on both sides of the wall. Sheet shall be cut to completely lap the top row of pillows above the top cable tray on both sides of the wall. Sheet to be installed with the galv steel sheet backer exposed (aluminum foil facing against wall surface) and secured to steel framing, through gypsum board layers, with min 1/4 in. (6 mm) diam by 2-1/4 in. (57 mm) long steel screws in conjunction with nom 1/4 by 1-1/4 in. (6 by 32 mm) diam steel washers. Max spacing of fasteners not to exceed 6 in. (152 mm) with fasteners located a max 1 in. (25 mm) from each corner of the sheet.

3M COMPANY – Type CS-195+

*Bearing the UL Classification Mark

Reprinted from the Online Certifications Directory with permission from Underwriters Laboratories Inc.
Copyright © 2011 Underwriters Laboratories Inc.®



Through Penetrations

Cable Trays

4000 Series

Concrete

WJ

System No. W-J-4063

September 20, 2011

ANSI/UL1479 (ASTM E814)

F Rating – 2 Hr

T Rating – 0 Hr

CAN/ULC S115

F Rating – 2 Hr

FT Rating – 0 Hr

FH Rating – 2 Hr

FTH Rating – 0 Hr

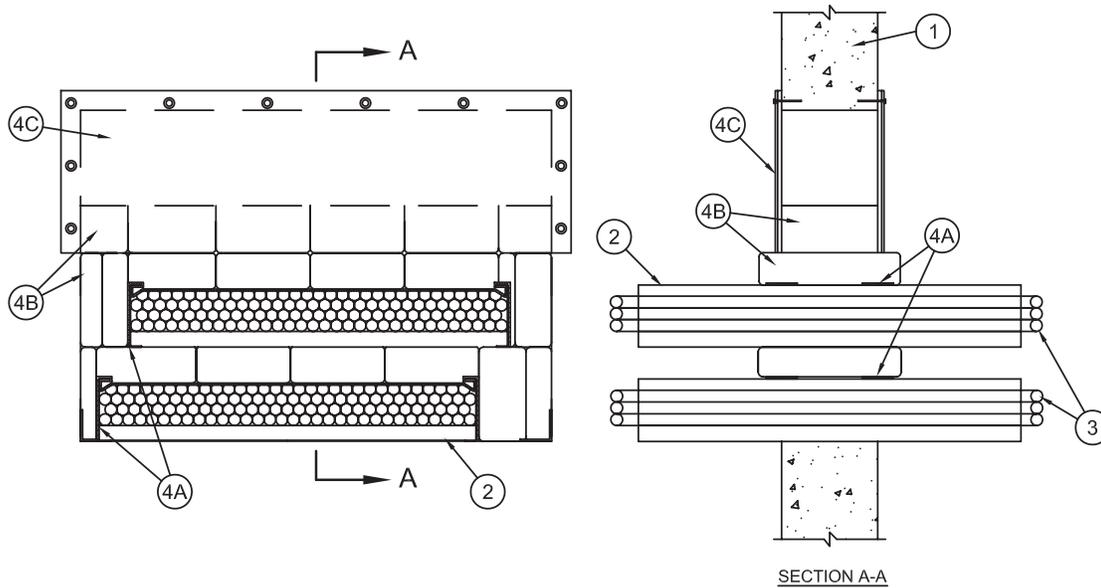

1. **Wall Assembly** – Min 6 in. thick reinforced lightweight or normal weight (100-150 pcf or 1600-2400 kg/m³) concrete wall. Wall may also be constructed of any UL Classified **Concrete Blocks***. Max area of opening is 720 in.² (0.46 m²) with a max dimension of 30 in. (762 mm). See **Concrete Blocks (CAZT)** category in the Fire Resistance Directory for names of manufacturers.
2. **Cable Tray** – Max two cable trays to be installed within the opening. The annular space between the cable trays shall be min 6 in. (152 mm) to max 10 in. (254 mm). The annular space between the cable trays and the periphery of the opening shall be min 0 in. (0 mm, point contact) to max 10 in. (254 mm). Cable trays to be rigidly supported on both sides of wall assembly. The following types of the cable trays may be used:
 - A. Max 24 in. (610 mm) wide by max 4 in. (102 mm) deep open ladder cable tray with channel-shaped side rails formed of min 0.058 in. thick (1.5 mm) galv steel with nom 1 in. (25 mm) diam rung spaced 9 in. (229 mm) OC
 - B. Max 24 in. (610 mm) wide by max 4 in. (102 mm) deep open ladder cable tray with channel-shaped side rails formed of min 0.060 in. thick (1.5 mm) aluminum with nom 1 in. (25 mm) diam rung spaced 9 in. (229 mm) OC.
 - C. Max 8-3/4 in. (222 mm) wide by max 2-1/2 in. (64 mm) deep welded wire basket cable tray formed from min 0.198 in. (5 mm) thick steel and having a max 2 by 4 in. (51 by 102 mm) grid.
3. **Cables** – Aggregate cross-sectional area of cables in cable tray not to exceed 40 percent of the cross-sectional area based on a max 3 in. (76 mm) cable loading depth within the open ladder cable tray. Aggregate cross-sectional area of cables in welded wire basket cable tray not to exceed 23 percent of the cross-sectional area of the welded wire basket cable tray based on a max 1-1/2 in. (38 mm) cable loading depth. Any combination of the following types and sizes of cables may be used:
 - A. Max 1/C 750 kcmil (or smaller) copper conductor cable with cross-linked polyethylene (XLPE) jacket.
 - B. Max 300 pair No. 22 AWG (or smaller) copper conductor telecommunication cables with polyvinyl chloride (PVC) insulation and jacket.
 - C. Max 7/C No. 12 AWG copper conductor power and control cables with XLPE or PVC insulation with XLPE or PVC jacket.
 - D. Max 4/C No. 2/0 AWG copper or aluminum conductor cables with PVC insulation and jacket.
 - E. Max 1-10/125 Fiber Optic (FO) cable with PVC insulation and jacket.
 - F. Max No. 18 AWG Type RG coaxial cable with polyvinyl chloride insulation.
4. **Firestop System** – The firestop system shall consist of the following:
 - A. **Fill Void or Cavity Material* – Putty** – Min 1/2 in. (13 mm) thickness of putty formed to a min 1 in. (25 mm) width and applied within annulus at the bottom corners of opening and extending a min 1 in. (25 mm) in both directions from each corners, flush with both surfaces of wall. Min 5/8 in. (16 mm) thickness of putty installed between bottom of cable tray and bottom of opening and between top of cable tray and bottom of composite sheet on both surfaces of wall. As an option, the putty between the bottom of the cable tray and the bottom of the opening may be replaced by pillows (Item 4B), provided the annular space is such that the pillows can be tightly fitted into the annular space. After installation of pillows and intumescent sheet (Items 4B and 4C), all voids within the opening shall be filled with a min 1 in. (25 mm) thickness of putty on both sides of wall.

3M COMPANY – MP+

System No. W-J-4063 continued

- B. **Fill Void or Cavity Material* – Pillows** – Max 9 in. (229 mm) long by 6 in. (152 mm) wide by 2 and 3 in. (51 and 76 mm) thick plastic covered pillows tightly-packed to fill annular space between the cable trays and periphery of opening and the annular space between the cable trays when two trays are installed within the opening. Pillows installed with 9 in. (229 mm) dimension projecting through wall and centered within the opening except that the top row of pillows in the opening shall be installed with the 6 in. (152 mm) dimension centered in the wall such that the top row is completely covered by the intumescent sheet (Item 4C).

3M COMPANY – Fire Barrier Pillow or Fire Barrier Self-Locking Pillows

- C. **Fill, Void or Cavity Materials* – Intumescent Sheet** – Rigid aluminum foil-faced sheet with galv steel sheet backer. The one piece sheet shall be cut to lap a min of 2 in. (51 mm) onto the wall at the top and sides of the opening on both sides of the wall. Sheet shall be cut to completely lap the top row of pillows above the top cable tray on both sides of the wall. Sheet to be installed with the galv steel sheet backer exposed (aluminum foil facing against wall surface) and secured to concrete, with min 1/4 in. (6 mm) diam by 1-1/4 in. (mm) long steel concrete anchors in conjunction with nom 1/4 by 1-1/4 in. (6 by 32 mm) diam steel washers. Max spacing of fasteners not to exceed 6 in. (152 mm) with fasteners located a max 1 in. (25 mm) from each corner of the sheet.

3M COMPANY – Type CS-195+

*Bearing the UL Classification Mark

Reprinted from the Online Certifications Directory with permission from Underwriters Laboratories Inc.
Copyright © 2011 Underwriters Laboratories Inc.®



System No. W-J-4069

September 20, 2011

ANSI/UL1479 (ASTM E814)

F Ratings – 1 and 2 Hr (See Item 1)

T Rating – 1/2 Hr

CAN/ULC S115

F Ratings – 1 and 2 Hr (See Item 1)

FT Rating – 1/2 Hr

FH Ratings – 1 and 2 Hr (See Item 1)

FTH Rating – 1/2 Hr

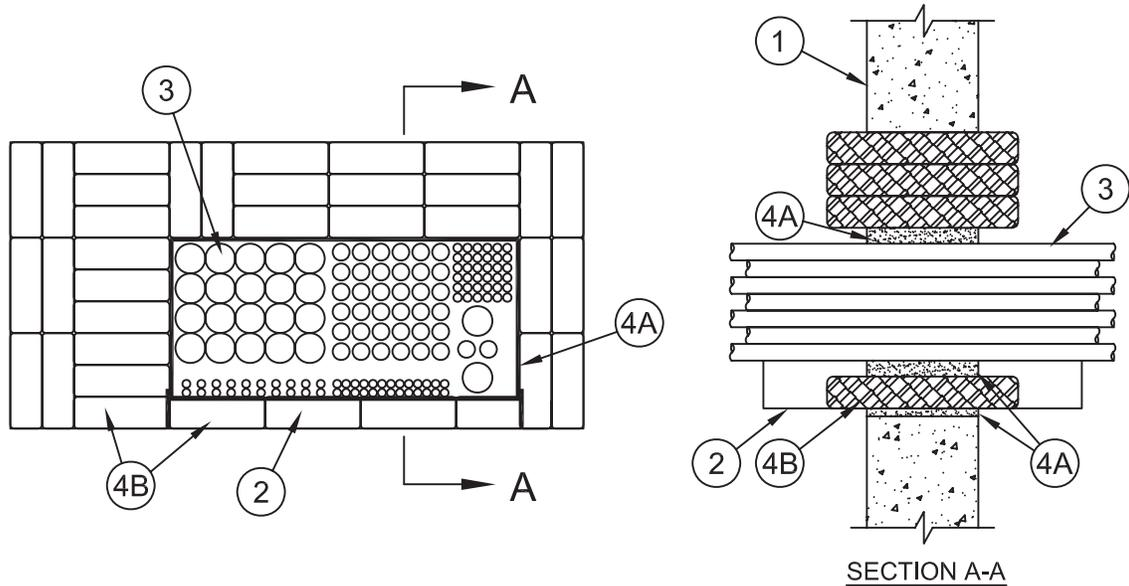

1. **Wall Assembly** – Min. 4-3/4 in. (121 mm) and 6 in. (152 mm) thick reinforced lightweight or normal weight (100-150 pcf or 1600-2400 kg/m³) concrete for 1 hr and 2 hr F Ratings, respectively. Wall may also be constructed of any UL classified **Concrete Blocks***. Max area of opening is 1080 sq in. (0.7 m²) with a max dimension of 36 in. (914 mm).
See **Concrete Blocks (CAZT)** in the Fire Resistance Directory for names of manufacturers.
2. **Cable Rack** – Max 20 in. (508mm) wide by 2 in. (51 mm) deep steel cable rack formed from 1/4 in. (6 mm) thick steel with min 1 in. (25 mm) wide rungs spaced max 9 in. (229 mm) OC. Width of cable rack to be at least 4 in. (102 mm) less than width of wall opening. The annular space between the cable rack and the bottom of the opening shall be min 0 in. (point contact). Side rails of cable rack to be min 2 in. (51 mm) to max 13 in. (330 mm) from side edges of wall opening. Cable rack to be rigidly supported on both sides of wall assembly.
- 2A. **Cable Tray** – (Not Shown) - As an alternate to the steel cable rack (Item 2), one of the following types of cable tray may be used:
 - A. Max 24 in. (610 mm) wide by max 4 in. (102 mm) deep open ladder cable tray with channel-shaped side rails formed of min 0.058 in. thick (1.5 mm) galv steel with nom 1 in. (25 mm) diam rung spaced 9 in. (229 mm) OC.
 - B. Max 24 in. (610 mm) wide by max 4 in. (102 mm) deep open ladder cable tray with channel-shaped side rails formed of min 0.060 in. thick (1.5 mm) aluminum with nom 1 in. (25 mm) diam rung spaced 9 in. (229 mm) OC.
 - C. Max 8-3/4 in. (222 mm) wide by max 2-1/2 in. (64 mm) deep welded wire basket cable tray formed from min 0.198 in. (5 mm) thick steel and having a max 2 by 4 in. (51 by 102 mm) grid.
Width of cable tray to be at least 4 in. (102 mm) less than width of wall opening. The annular space between the cable tray and the bottom of the opening shall be min 2 in. (51 mm). Side rails of cable tray to be min 2 in. (51 mm) to max 13 in. (330 mm) from side edges of wall opening. Cable tray to be rigidly supported on both sides of wall assembly.
3. **Cables** – When cable rack (Item 2) is used, aggregate cross-sectional area of cables in opening to be max 25 percent of the cross-sectional area of the opening based on a max 15 in. (381 mm) deep cable loading depth on the cable tray. When cable tray (Item 2A) is used, the aggregate cross-sectional area of cables in cable tray not to exceed 40 percent of the cross-sectional area of the cable tray based on a max 3 in. (76 mm) cable loading depth in the cable tray. Any combination of the following types and sizes of cables may be used:
 - A. Max 300 pair No. 24 AWG (or smaller) copper conductor telecommunication cable with PVC insulation and jacket materials.
 - B. Max 1/C No. 3/0 AWG copper conductor cable with PVC insulation and jacket materials.
 - C. Max three copper conductors (with ground) No. 12 AWG steel Armored Cable+.
 - D. Max three copper conductor (with ground) No. 2 AWG Metal Clad Cable+.
 - E. Max 1/C No. 750 kcmil (or smaller) copper conductor power cable with cross-linked polyethylene (XLPE) insulation and fabric jacket materials.
 - F. Max 3/C (with ground) No. 4/0 AWG (or smaller) copper or aluminum conductor SER cable with XLPE or PVC insulation and jacket.
 - G. Max 4/C No. 18 AWG (or smaller) copper conductor thermostat cable with polyvinyl chloride (PVC) insulation and jacket materials.
 - H. Max four pair No. 22 AWG (or smaller) copper conductor Category 5 or Category 6 data cable with PVC insulation and jacket materials.
 - I. Max 3/C (with ground) No. 10 AWG (or smaller) nonmetallic sheathed (Romex) cable with PVC insulation and jacket materials.

System No. W-J-4069 continued

- J. Max twelve core No. 24 AWG shielded coaxial cable with high density polyethylene foam insulation and fluorinated ethylene (FE) or PVC jacket.
 - K. Max 62.5/125 micron fiber optic cable with having a min Riser rating.
 - L. Max 7/C No. 12 AWG (or smaller) copper conductor control cable with PVC insulation and jacket materials.
4. **Firestop System** – The firestop system shall consist of the following:
- A. **Fill, Void or Cavity Material* – Putty** – Nom 1/8 in. (3 mm) thick by 4 in. (102 mm) band of putty installed around cable bundle at mid-depth of wall. Nom 1/2 in. (13 mm) rope of putty used to fill any gaps or voids around perimeter of opening and around cable fill.
3M COMPANY
3M FIRE PROTECTION PRODUCTS – MP+ or Cable Wrap Putty
 - B. **Fill, Void or Cavity Material* – Pillows** – Pillows installed length-wise through wall and tightly-packed to fill opening between the penetrants and the periphery of the opening. The pillows may be cut to decrease their width and repaired with min 0.002 in. (0.05mm) thick polyester tape with acrylic adhesive. The tape must overlap onto the existing pillow a min of 1/2 in. (13mm).
3M COMPANY
3M FIRE PROTECTION PRODUCTS – Fire Barrier Pillows or Fire Barrier Self-Locking Pillows

*Bearing the UL Classification Mark

Reprinted from the Online Certifications Directory with permission from Underwriters Laboratories Inc.
Copyright © 2011 Underwriters Laboratories Inc.®



| |
|----------------------|
| Through Penetrations |
| Cable Trays |
| 4000 Series |
| Concrete |
| WJ |

System No. W-J-4073

August 01, 2013

ANSI/UL1479 (ASTM E814)
 F Ratings – 2 Hr
 T Rating – 1/2 Hr
 L Rating at Ambient - Less than 1 CFM/sq ft
 L Rating at 400 F - Less than 1 CFM/sq ft

CAN/ULC S115
 F Ratings – 2 Hr
 FT Rating – 1/2 Hr
 FH Ratings – 2 Hr
 FTH Rating – 1/2 Hr
 L Rating at Ambient - Less than 1 CFM/sq ft
 L Rating at 400 F - Less than 1 CFM/sq ft

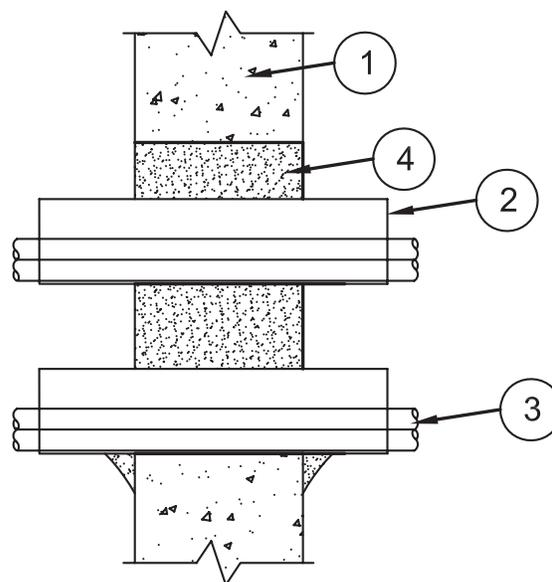
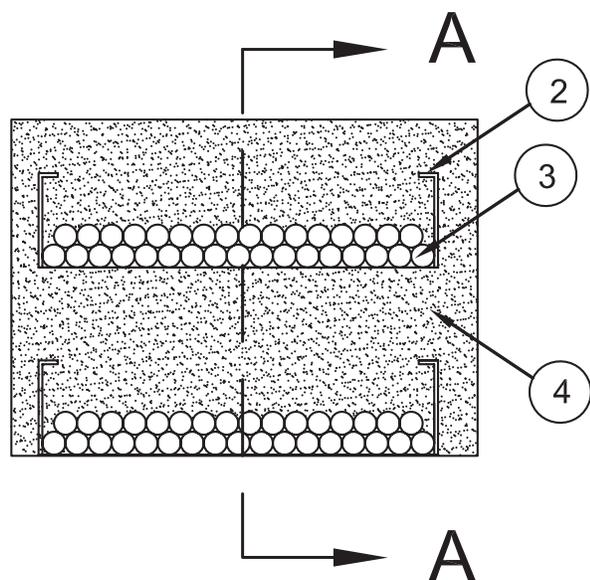

SECTION A-A

1. **Wall Assembly** – Min 6 in. (152 mm) thick reinforced lightweight or normal weight (100-150 pcf or 1600 - 2400 kg/m³) concrete wall. The area of the opening shall be max 512 in.² (3303 cm²) with a max dimension of 32 in. (813 mm).
2. **Cable Tray*** – Max two 24 in. (610 mm) wide by max 6 in. (151 mm) deep open-ladder cable tray with channel-shaped side rails formed of 0.065 in. (1.651 mm) to 0.10 in. (2.54 mm) thick aluminum or min 0.060 in. (1.65 mm) thick galv steel. The annular space between the cable trays shall be min 2 in. (51 mm). The annular space between the cable tray and the periphery of the opening shall be min 0 in. (point contact) to max 2 in. (51 mm). Cable tray to be rigidly supported on both sides of wall assembly.
3. **Cables** – Aggregate cross-sectional area of cables in cable tray to be max 45 percent of the cross-sectional area of the cable tray based on a max 5 in. (127 mm) cable loading depth within the cable tray. Any combination of the following types and sizes of copper conductor or fiber optic cables may be used:
 - A. Max 200 pair No. 22 AWG (or smaller) copper conductor with polyvinyl chloride (PVC) insulation and jacketing material.
 - B. Max 1/C No. 750 kcmil (or smaller) copper conductor cable with cross-linked polyethylene (XLPE) jacket.
 - C. Max 7/C No. 12 AWG (or smaller) copper conductor power and control cables with XLPE or PVC insulation with XLPE or PVC jacket.
 - D. Max 3/C No. 4/0 AWG (or smaller) copper or aluminum conductor SER cables with PVC or XLPE insulation and jacket.
 - E. Max 3/C No. 2/0 AWG (or smaller) copper conductor PVC jacketed aluminum clad or steel clad TECK 90 cable.
 - F. Max 110/125 fiber optic (F.O.) cable with PVC insulation and jacket.
 - G. Max 3/C with ground No. 8 AWG (or smaller) copper conductor NM cable with PVC insulation and jacket.
 - H. RG/U coaxial cable with fluorinated ethylene (FE) or PVC insulation and jacket.
 - I. Max 4 pair No. 24 AWG (or smaller) copper conductor data cable with Hylar jacket and insulation.
 - J. Max three conductor No. 12 AWG (or smaller) MC (BX) copper cable with polyvinyl chloride insulation and jacket materials.
 - K. **Through Penetrating Product*** – Any cables, **Armored Cable+** or **Metal Clad Cable+** currently Classified under the Through Penetrating Product category. See **Through Penetrating Product** (XHLY) category in the Fire Resistance Directory for names of manufacturers.
4. **Fill, Void or Cavity Material*** – **Foam** – Min 6 in. (152 mm) thickness of fill material applied within the annulus, flush with both surfaces of wall. Foam to be injected into the interstices between all cables. An additional 1/2 in. (13 mm) bead of foam shall be applied at the point contact locations.

3M COMPANY – Fire Barrier Rated Foam, FIP 1-Step

*Bearing the UL Classification Mark

Reprinted from the Online Certifications Directory with permission from UL
 © 2013 UL LLC



System No. W-J-4074

June 26, 2014

ANSI/UL1479 (ASTM E814)
 F Ratings — 1 and 2 Hr (See Item 1)
 T Ratings — 0 and 1/2 Hr (See Item 1)

CAN/ULC S115
 F Ratings — 1 and 2 Hr (See Item 1)
 FT Ratings — 0 and 1/2 Hr (See Item 1)
 FH Ratings — 1 and 2 Hr (See Item 1)
 FTH Ratings — 0 and 1/2 Hr (See Item 1)

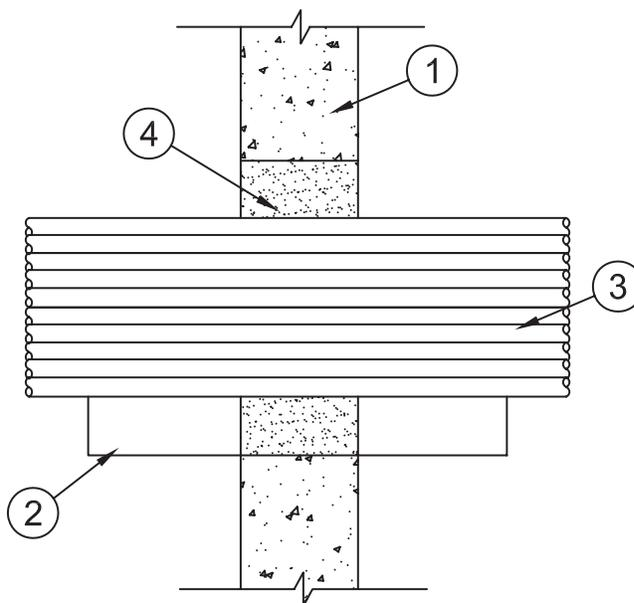
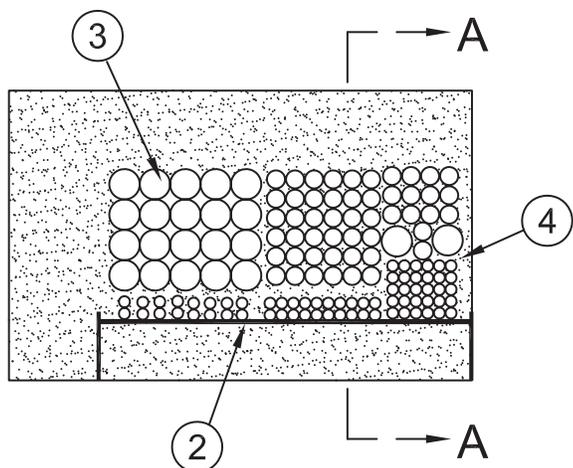

SECTION A-A

- Wall Assembly** — Min. 4-3/4 in. (121 mm) and 6 in. (152 mm) thick reinforced lightweight or normal weight (100-150 pcf or 1600-2400 kg/m³) concrete for 1 hr and 2 hr F and FH Ratings, respectively. Wall may also be constructed of any UL Classified **Concrete Blocks***. Max area of opening is 560 sq in. (0.36 m²) with a max dimension of 28 in. (711 mm). The hourly T, FT and FTH Ratings are 0 and 1/2 hr for 1 and 2 hr rated assemblies, respectively.

See **Concrete Blocks (CAZT)** in the Fire Resistance Directory for names of manufacturers.

- Cable Rack** — Max 20 in. (508mm) wide by 2 in. (51 mm) deep steel cable rack formed from 1/4 in. (6 mm) thick steel with min 1 in. (25 m) wide rungs spaced max 9 in. (229 mm) OC. The annular space between the cable rack and the bottom of the opening shall be min 0 in. (point contact) to max 4 in. (102 mm). Side rails of cable rack to be min 0 in. (point contact) to max 4 in. (102 mm) from side edges of wall opening. Cable rack to be rigidly supported on both sides of wall assembly.

2A. **Cable Tray** — (Not Shown) - As an alternate to the steel cable rack (Item 2), one of the following types of cable tray may be used:

- Max 24 in. (610 mm) wide by max 4 in. (102 mm) deep open ladder cable tray with channel-shaped side rails formed of min 0.058 in. thick (1.5 mm) galv steel with nom 1 in. (25 mm) diam rung spaced 9 in. (229 mm) OC.
- Max 24 in. (610 mm) wide by max 4 in. (102 mm) deep open ladder cable tray with channel-shaped side rails formed of min 0.060 in. thick (1.5 mm) aluminum with nom 1 in. (25 mm) diam rung spaced 9 in. (229 mm) OC.
- Max 8-3/4 in. (222 mm) wide by max 2-1/2 in. (64 mm) deep welded wire basket cable tray formed from min 0.198 in. (5 mm) thick steel and having a max 2 by 4 in. (51 by 102 mm) grid.

The annular space between the cable tray and the bottom of the opening shall be min 0 in. (point contact). Side rails of cable tray to be min 0 in. (point contact) to max 4 in. (102 mm) from side edges of wall opening. Cable tray to be rigidly supported on both sides of wall assembly.

- Cables** — When cable rack (Item 2) is used, aggregate cross-sectional area of cables in opening to be max 40 percent of the cross-sectional area of the opening based on a max 15 in. (381 mm) deep cable loading depth on the cable tray. When cable tray (Item 2A) is used, the aggregate cross-sectional area of cables in cable tray not to exceed 40 percent of the cross-sectional area of the cable tray based on a max 3 in. (76 mm) cable loading depth in the cable tray. Any combination of the following types and sizes of cables may be used:

- Max 300 pair No. 24 AWG (or smaller) copper conductor telecommunication cable with PVC insulation and jacket materials.
- Max 1/C No. 3/0 AWG copper conductor cable with PVC insulation and jacket materials.
- Max three copper conductors (with ground) No. 12 AWG steel Armored Cable+.
- Max three copper conductor (with ground) No. 2 AWG Metal Clad Cable+.
- Max 1/C No. 750 kcmil (or smaller) copper conductor power cable with cross-linked polyethylene (XLPE) insulation and fabric jacket materials.
- Max 3/C (with ground) No. 4/0 AWG (or smaller) copper or aluminum conductor SER cable with XLPE or PVC insulation and jacket.
- Max 4/C No. 18 AWG (or smaller) copper conductor thermostat cable with polyvinyl chloride (PVC) insulation and jacket materials.
- Max four pair No. 22 AWG (or smaller) copper conductor Category 5 or Category 6 data cable with PVC insulation and jacket materials.
- Max 3/C (with ground) No. 10 AWG (or smaller) nonmetallic sheathed (Romex) cable with PVC insulation and jacket materials.
- Max twelve core No. 24 AWG shielded coaxial cable with high density polyethylene foam insulation and fluorinated ethylene (FE) or PVC jacket.
- Max 62.5/125 micron fiber optic cable with having a min Riser rating.
- Max 7/C No. 12 AWG (or smaller) copper conductor control cable with PVC insulation and jacket materials.

Through Penetrations
Cable Trays
4000 Series
Concrete
WJ

System No. W-J-4074 *continued*

4. **Fill, Void or Cavity Material*** — **Foam** — Min 4-3/4 in. (121 mm) or min 6 in. (152 mm) thickness of fill material for 1 and 2 hr rated walls, respectively, applied within the annulus, flush with both surfaces of wall. Foam to be injected into the interstices between all cables. An additional 1/2 in. (13 mm) bead of foam shall be applied at the point contact locations.

3M COMPANY 3M FIRE PROTECTION PRODUCTS — Fire Barrier Rated Foam, FIP 1-Step

*Bearing the UL Classification Mark

+ Bearing the UL Listing Mark

Reprinted from the Online Certifications Directory with permission from UL
© 2014 UL LLC



Through Penetrations

Cable Trays

4000 Series

Concrete

WJ

Cable Trays • Gypsum

| 3M UL Systems | "F" Rating | 3M Product | Through Penetrant Details |
|---------------|------------|--|--|
| W-L-4004 | 2 | 3M™ Fire Barrier Sealant CP 25WB+ 3M™ Fire Barrier Sealant IC 15WB+ 3M™ Fire Barrier Composite Sheet CS-195+ 3M™ Fire Barrier Wrap Strips FS-195+ 3M™ Fire Barrier Moldable Putty Stix MP+ 3M™ Expanrol™ Flexible Intumescent Strip E-FIS | 24" x 4" steel or aluminum cable tray, 32% fill. Also referred as WL4004. |
| W-L-4018 | 1 | 3M™ Fire Barrier Sealant CP 25WB+ 3M™ Fire Barrier Sealant IC 15WB+ 3M™ Fire Barrier Composite Sheet CS-195+ 3M™ Fire Barrier Moldable Putty Stix MP+ 3M™ Expanrol™ Flexible Intumescent Strip E-FIS | 14-1/2" width opening, 18"x4" steel or aluminum cable tray, 43% fill maximum, copper, aluminum cables, telephone cables, coaxial. Also referred as WL4018. |
| W-L-4037 | 1, 2 | 3M™ Fire Barrier Moldable Putty Stix MP+ 3M™ Fire Barrier Moldable Putty Pads MPP+ 3M™ Fire Barrier Pillows 3M™ Fire Barrier Self-Locking Pillows | 24" x 4" steel cable tray, 40% fill, 540 sq. in., 30" maximum. Also referred as WL4037. |
| W-L-4044 | 1, 2 | 3M™ Fire Barrier Sealant CP 25WB+ 3M™ Fire Barrier Composite Sheet CS-195+ 3M™ Fire Barrier Moldable Putty Stix MP+ 3M™ Expanrol™ Flexible Intumescent Strip E-FIS | Max. 24" x 4" steel or aluminum open ladder cable tray, 0-40% cable fill, max. 750 Kcmil, 300 pair no. 22 AWG, 7/C no. 12 AWG, 4/C No. 2/0 AWG, 1-10/125 fiber optic, 180 sq. in., 30" maximum, intumescent sliding sheet. Also referred to as WL4044. |
| W-L-4052 | 1, 2 | 3M™ Fire Barrier Pillows 3M™ Fire Barrier Self-Locking Pillows 3M™ Fire Barrier Moldable Putty Stix MP+ 3M™ Fire Barrier Composite Sheet CS-195+ | 24" x 4" steel or aluminum open ladder cable tray, 0-40% cable fill. Max: 750 kcmil, 300 pair No. 22 AWG, 7/C No. 12/ AWG, 4/C No. 2/0 AWG, 1-0/125 fiber optic, No. 18 AWG Type RG coaxial cable. Max 720 sq. in, 30 inch maximum. 1 & 2 hour F. Also referred as WL4052. |
| W-L-4062 | 1, 2 | 3M™ Fire Barrier Moldable Putty Stix MP+ 3M™ Fire Barrier Self-Locking Pillows 3M™ Fire Barrier Pillows 3M™ Fire Barrier Composite Sheet CS-195+ | Max 12 in.x1-1/2 in. open ladder tray,max 8-3/4 in.x2-1/2 in. wire basket tray.Max 2 cable trays.Max cable fill 40% ladder ray,max cable fill 23% wire basket tray.Max area of opening 720 sq. in. with max dimension of 30 in. U400, V400 series wall.Space between trays min 6 in. to max 12 in. Annular space min 1-1/2 in. to max 20 in. 1 & 2 hour F rating. See system for T rating. Also known as WL4062. |
| W-L-4066 | 1, 2 | 3M™ Fire Barrier Pillows 3M™ Fire Barrier Self-Locking Pillows 3M™ Fire Barrier Moldable Putty Stix MP+ 3M™ Fire Barrier Composite Sheet CS-195+ | 2 cable trays. Max area of opening 720 sq. in. with max dimension 30 in. Annular between cable trays min 6 in. to max 10 in. Annular between cable trays and opening point contact to max 10 in. Max 24 in. by 4 in. galv. steel or aluminum open ladder with 40% fill. Max 8-3/4 by 2-1/2 wire basket with 23% fill. 1 and 2 hour F. Also known as WL4066. |
| W-L-4067 | 1, 2 | 3M™ Fire Barrier Pass-Through Products 3M™ Fire Barrier Water Tight Sealant 3000 WT 3M™ Fire Barrier Sealant CP 25WB+ 3M™ Fire Barrier Sealant IC 15WB+ 3M™ Fire Barrier Moldable Putty Stix MP+ | Square device: max area 98.5 sq. in. with max dimension of 12-1/8 in. Round device: max diam of opening 4-1/2 in. Max 2 in. by 2 in. welded wire basket cable tray. One per device. 100% cable fill. Max 4 pair No. 24 AWG copper Cat 5e or Cat 6 phone cable, Max 4 pair No. 23 AWG Cat 6 phone cable. Max 6 square devices ganged or 1 round. 1 and 2 hour F. Also known as WL4067. |
| W-L-4075 | 1, 2 | 3M™ Fire Barrier Moldable Putty Stix MP+ 3M™ Fire Barrier Moldable Putty Pads MPP+ 3M™ Fire Barrier Self-Locking Pillows 3M™ Fire Barrier Pillows | Nom 20 in. x 2 in. cable rack. Max cable fill 13% based on 15 in. loading depth. Max area of opening 1080 sq. in. with max dimension of 36 in. U300, U400 or V400 series wall. Annular space point contact to max 13 in. 1 & 2 hour F rating. 1/2 hour T rating. Also known as WL4075. |
| W-L-4080 | 1, 2 | 3M™ Fire Barrier Pillows 3M™ Fire Barrier Self-Locking Pillows 3M™ Fire Barrier MP+ Moldable Putty Stix 3M™ Fire Barrier Moldable Putty Pads MPP+ | Max. 18 in. wide x 2 in. deep cable rack with max. 35% aggregate cable fill penetrating a 1 or 2 hour rated gypsum wallboard assembly. |
| W-L-4082 | 2 | 3M™ Fire Barrier Rated Foam FIP 1-Step | Max two: max 24 in. x max 6 in. open ladder aluminum or steel cable tray. Max 45% cable fill including armored cable, metal clad cable. U400, V400 or W400 gypsum wallboard assemblies with steel studs. Max 512 sq. in. opening with max 32 in. dimension. Point contact to max 2 in. annular space. Cable trays min 2 in. apart. 2 hour F rating. 1/2 hour T rating. Also known as WL4082. |
| W-L-4084 | 1, 2 | 3M™ Fire Barrier Rated Foam FIP 1-Step | U300, U400. V400 or W400 gypsum wallboard. Max 20 in. x 2 in. steel cable rack, max 24 in. x 4 in. steel or aluminum open cable ladder tray, max 83/4 in. x 2-1/2 in. steel wire basket cable tray. Max 40% cable fill. 560 sq. in. opening with max 28 in. dimension. Wall assembly determines annular space. Opening must be framed. 1 & 2 hour F rating. Also known as WL4084. |
| W-L-4088 | 1, 2 | 3M™ Fire Barrier Pillows 3M™ Fire Barrier Self-Locking Pillows 3M™ Fire Barrier Rated Foam FIP 1-Step | Max. 24 in. wide by 4 in. deep steel cable tray with cables up to 1/C No. 750 kcmil copper penetrating a gypsum wallboard assembly. Max. 540 sq. in. opening with max. 30 in. dimension. Max. 5 in. annular space. |
| W-L-4090 | 1, 2 | 3M™ Fire Barrier Block 3M™ Fire Barrier Plank 3M™ Fire Barrier Rated Foam FIP 1-Step 3M™ Fire Barrier Sealant CP 25WB+ 3M™ Fire Barrier Water Tight Sealant 3000 WT | Max two 24 in. wide x 6 in. deep open-ladder cable trays penetrating gypsum wall through max 1080 in^2 opening, max dim. 36 in. |

System No. W-L-4004

May 19, 2005

F Rating – 2 Hr

T Ratings – 0, 1/2 and 1 Hr (See Items 1A and 3)

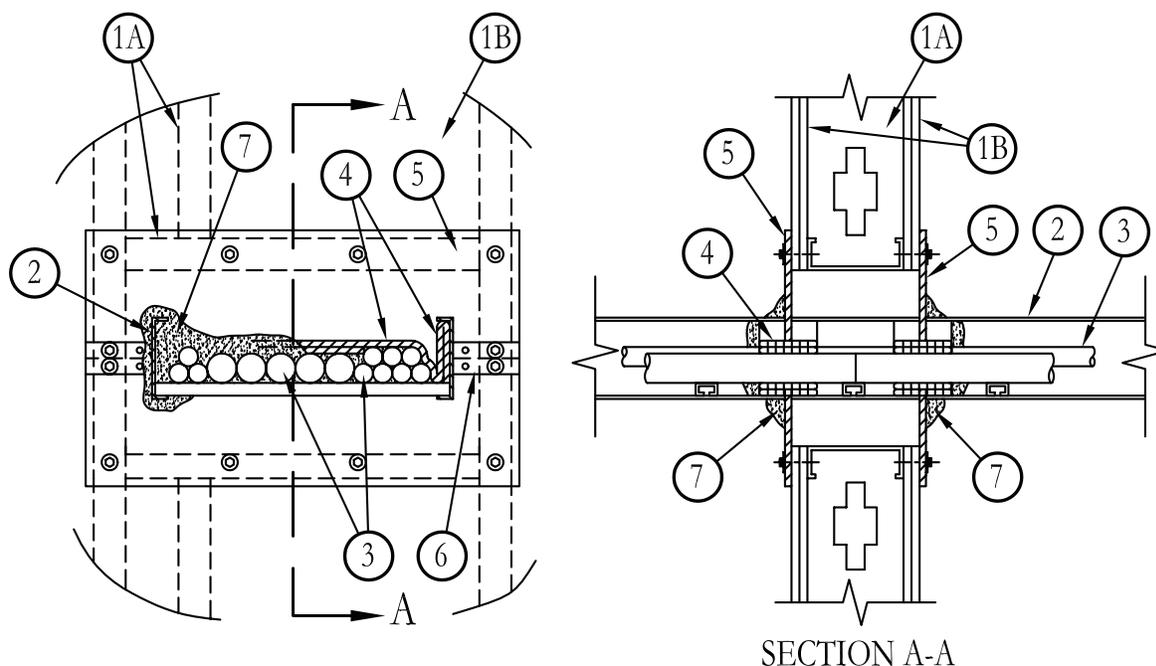

- Wall Assembly** – The fire-rated gypsum board/steel stud wall assembly shall be constructed of the materials and in the manner described in the individual U400 or V400 Series Wall and Partition Design in the UL Fire Resistance Directory and shall include the following construction features:
 - Steel Studs** – Steel studs to be min 3-5/8 in. (92 mm) wide and spaced max 24 in. (610 mm) OC. The opening in the wall to accommodate the cable tray (Item 2) shall be framed on all sides using lengths of steel stud installed between the vertical studs and screw-attached to the steel studs at each end. The framed opening in the wall shall be min 1/2 in. (13 mm) to max 6 in. (152 mm) wider and higher than the width and height of the cable tray such that, when the cable tray is centered in the opening, a 1/4 to 3 in. (6 to 76 mm) clearance is present between the cable tray and the framing on all four sides.

When the clearance between the cable tray and the framing is less than 2 in. (51 mm), the T Rating is 0 hr.
 - Gypsum Board*** – Two layers of nom 5/8 in. (16 mm) thick gypsum board, as specified in the individual Wall and Partition Design.
- Cable Tray** – Max 24 in. (610 mm) wide by max 4 in. (102 mm) deep open ladder steel or aluminum cable tray. Cable tray to consist of channel-shaped side-rails with boxed channel rungs spaced 9 in. (229 mm) OC. Cable tray centered in framed opening and rigidly supported on both sides of wall assembly.
- Cables** – Aggregate cross-sectional area of cables in cable tray not to exceed 32 percent of the cross-sectional area of the cable tray based on a max 3 in. (76 mm) cable loading depth within the cable tray. Any combination of the following types and sizes of copper conductor cables may be used:
 - Max 350 kcmil single-conductor power cables; cross-linked polyethylene (XLPE) insulation.
 - Max No. 2/0 AWG multiconductor power and control cables; XLPE insulation, XLPE or polyvinyl chloride (PVC) jacket.
 - Max No. 12 AWG multiconductor power and control cables; XLPE insulation, XLPE or PVC jacket.
 - Max 7C No. 12 AWG (or smaller) multi conductor power and control cables; XLPE insulation, XLPE or polyvinyl chloride (PVC) jacket.
 - Max No. 18 AWG RG 6/U coaxial cable with PVC insulation and jacket.
 - Max 1-10/125 Fiber Optic (F.O.) cable with PVC insulation and jacket.

When cables A and B are used in steel cable tray, T Rating is 0 hr.
When cables A and B are used in aluminum cable tray, T Rating is 1/2 hr.
When cables C, D, E and F are used in steel cable tray, T Rating is 1/2 hr.
When cables C, D, E and F are used in aluminum cable tray, T Rating is 1 hr.
- Fill, Void or Cavity Materials* – Intumescent Sheet** – Rigid aluminum foil-faced sheet with galv steel sheet backer. Sheets cut to tightly follow the contours of the cables around the entire perimeter of the cable tray and cable fill. Sheets cut to lap a min of 2 in. (51 mm) on the wall on all sides of the opening on both sides of the wall. Prior to installation, a min 1/4 in. (6 mm) diam bead of caulk (Item 7) or a nom 1/8 by 1/2 in. (3.2 by 13 mm) ribbon of putty (Item 7A) shall be applied as a gasket approx 1 in. (25 mm) from and on all sides of the through opening. Sheet to be installed with the galv steel sheet backer exposed (aluminum foil facing against wall surface) and secured to steel framing, through gypsum board layers, with min 1/4 in. (6 mm) diam by 2-1/4 in. (57 mm) long steel screws in conjunction with min 1-1/4 in. (32 mm) diam steel fender washers. Max spacing of fasteners not to exceed 6 in. (152 mm) with additional fasteners located on each side of batted seams or slits made to permit installation of the sheet around the cable tray.

3M COMPANY – Type CS-195+

Through Penetrations

Cable Trays

4000 Series

Gypsum

WL

System No. W-L-4004 *continued*

Through Penetrations

5. **Steel Cover Strip** – Min 2 in. (51 mm) wide strip of min 0.020 in. (.51 mm) thick (26 gauge) galv steel centered over entire length of each butted seam or slit made in the intumescent sheet (Item 5). Prior to installation of the steel strip, the seam or slit in the intumescent sheet shall be covered with a nom 1/4 in. (6 mm) diam bead of caulk (Item 7) or a nom 1/8 by 1/2 in. (3.2 by 13 mm) ribbon of putty (Item 7A). Steel cover strip secured to galv steel sheet backer of intumescent sheet with steel sheet metal screws or steel rivets spaced max 3 in. (76 mm) OC on each side of seam or slit.
6. **Fill, Void or Cavity Materials* – Graphite Seal, Caulk, Sealant or Putty** – One layer of 1/2 in. x 1/16 in. (13 mm by 1.6 mm) adhesive backed graphite intumescent seal positioned under intumescent sheet around entire perimeter of through opening or min 1/4 in. (6 mm) diam continuous bead of caulk or putty applied to edge of intumescent sheet at its interface with surface of floor or wall around entire perimeter of through opening. Caulk applied to fill all interstices between cables and between cables and wrap strip (Item 4). Caulk depth to be min 2 in. (51 mm) within confines of wrap strip on both sides of floor or wall assembly. Generous application of caulk to be applied around the base of the cable tray side-rails and contour applied wrap strips at their egress from the intumescent sheet on both sides of the wall assembly. Caulk also applied to cover all exposed edges of wrap strips to a min thickness of 1/8 in. (3.2 mm).

3M COMPANY – E-FIS or Ultra GS seal, CP 25WB+ caulk, MP+ Stix putty, IC 15WB+ caulk or FB-3000 WT sealant

- 6A. **Fill, Void or Cavity Materials* – Putty** – As an alternate to the caulk (Item 6) when steel cable tray is used, nom 1/4 in. (6 mm) thick by 2 in. (51 mm) wide strips of moldable putty shall be applied to follow the contours of the cable fill on the top and bottom of the cable tray prior to installation of the intumescent sheets (Item 5). Moldable putty strips installed to project approx 7/8 in. (22 mm) beyond each face of the intumescent sheet on each side of the wall assembly. After installation of the intumescent sheets, putty pressed into cable fill and against intumescent sheet to fill all openings. Nom 1/2 in. (13 mm) diam "ropes" of putty applied around cable tray side-rail members at their egress from the intumescent sheet and pressed into the intersections. A min 1/8 in. (3.2 mm) thickness of putty shall be applied to cover the short lengths of wrap strip installed to fill the channel of the steel cable tray side-rails.

3M COMPANY – MP+ Stix

*Bearing the UL Classification Mark

Reprinted from the Online Certifications Directory with permission from Underwriters Laboratories Inc.
Copyright © 2010 Underwriters Laboratories Inc.®



Cable Trays

4000 Series

Gypsum

W-L

System No. W-L-4018

May 19, 2005
F Rating – 1 Hr
T Rating – 1/4 Hr

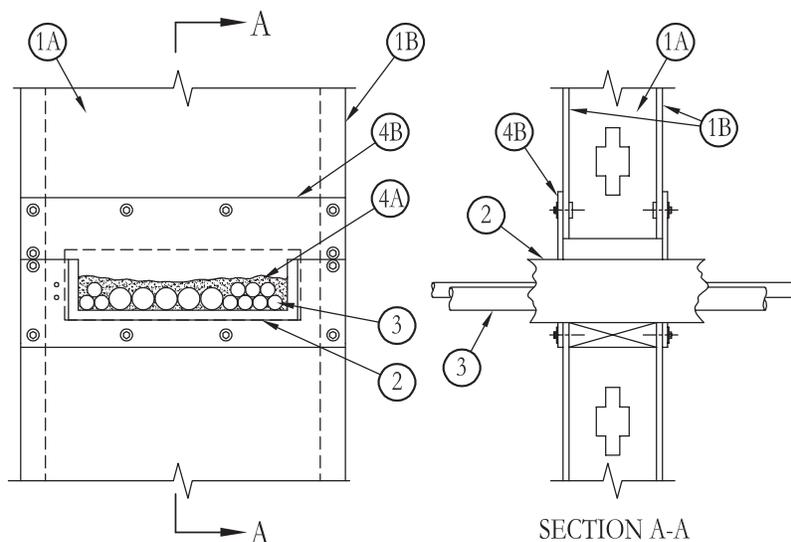

1. **Wall Assembly** – The 1 hr fire-rated gypsum board/stud wall assembly shall be constructed of the materials and in the manner specified in the individual U300, U400 or V400 Series Wall and Partition Designs in the UL Fire Resistance Directory and shall include the following construction features:
 - A. **Studs** – Wall framing may consist of either wood studs or steel channel studs. Wood studs to consist of nom 2 in. by 4 in. (51 mm by 102 mm) lumber spaced 16 in. (406 mm) OC. Steel studs to be min 3-5/8 in. (92 mm) wide and spaced max 24 in. (610 mm) OC. Additional framing member shall be installed in stud cavity at the bottom of the opening to support cable tray (Item 2).
 - B. **Gypsum Board*** – One layers of nom 5/8 in. (16 mm) thick gypsum board, as specified in the individual Wall and Partition Design. The opening shall be sized to be 1 in. (25 mm) wider and 2 in. (51 mm) higher than the width and depth of the cable tray. If cable tray is installed in a wood stud/gypsum board assembly, max width of opening is 14-1/2 in. (368 mm).
2. **Cable Tray+** – Max 18 in. (457 mm) wide by max 4 in. (102 mm) deep aluminum or steel open-ladder cable tray. One cable tray to be installed in the opening. The annular space between the cable tray and the periphery of the opening shall be min 0 in. (0 mm) (point contact) to max 2 in. (51 mm). Cable tray to be rigidly supported on both sides of wall assembly.
3. **Cables** – Aggregate cross-sectional area of cables in cable tray to be max 43 percent of the cross-sectional area of the cable tray based on a max 3 in. (76 mm) cable loading depth within the cable tray. Any combination of the following types and sizes of cables may be used:
 - A. Max 200 pair No. 24 AWG (or smaller) copper conductor with polyvinyl chloride (PVC) insulation and jacket.
 - B. Max 1/C 1000 kcmil (or smaller) copper conductor cable with cross-linked polyethylene (XLPE) jacket.
 - C. Max 3/C No. 2/0 AWG (or smaller) aluminum or copper conductor cable with XLPE insulation and PVC jacket.
 - D. Max 7/C No. 12 AWG (or smaller) copper conductor cable with PVC insulation and jacket.
 - E. Max No. 18 AWG RG 6/U coaxial cable with PVC insulation and jacket.
 - F. Max 3/C with ground No. 12 AWG (or smaller) NM cable with PVC insulation and jacket.
4. **Firestop System** – The firestop system shall consist of the following:
 - A. **Fill, Void or Cavity Materials* – Caulk, Sealant or Putty** – Min 5/8 in. (16 mm) thickness of caulk or putty installed within annular space between sides of cable tray and periphery of opening flush with each side of wall surfaces. Nom 1/2 in. (13 mm) thick by 1 in. (25 mm) wide strips of caulk or putty shall be applied to follow the contours of top of cables prior to installation of intumescent sheets (Item 4B). Caulk or putty strips installed to project approx 1/2 in. (13 mm) beyond each face of the intumescent sheet on each side of the wall assembly. After installation of the intumescent sheets, min 5/8 in. (16 mm) thickness of caulk or putty applied within all openings between the intumescent sheet and the cables and cable tray, on each side of wall, flush with each face of intumescent sheet or extending a max of 3/8 in. (10 mm) beyond each face of intumescent sheet.
3M COMPANY – CP 25WB+, IC 15WB+ caulk, FB-3000 WT sealant or MP+ Stix putty
 - B. **Fill, Void or Cavity Materials* – Intumescent Sheet** – Foil-faced sheet with galv steel sheet backer. Sheets cut in two pieces (top and bottom). Bottom piece cut to tightly follow the contours of cable tray with a 0 in. (point contact) to max 3/8 in. (0 mm to max 10 mm) space between sheet and cable tray on each side of wall. Top piece cut to tightly-follow the contours of cable tray and cable fill on each side of wall with a 0 in. (point contact) to max 3/8 in. (0 mm to max 10 mm) space between sheet and cable tray and a min 1/4 in. to max 3/8 in. (6 mm to max 10 mm) space between sheet and cables. Sheets cut to lap a min of 2 in. (51 mm) on the wall on top and bottom of opening and to extend a min of 1 in. (25 mm) onto vertical studs on both sides of opening. Sheets to be installed on each side of wall with the galv steel sheet backer exposed (foil facing against wall surface) and secured to steel framing, through gypsum board layers, with min 1-1/2 in (38 mm) long steel drywall screws in conjunction with min 1-1/4 in. (32 mm) diam steel fender washers. Max spacing of fasteners not to exceed 6 in. (152 mm) with additional fasteners located on each side of batted seams of top and bottom pieces. Sheets to be fastened to gypsum board with min 1/4 in. (6 mm) diam steel toggle bolts in conjunction with min 1-1/4 in. (32 mm) diam steel fender washers in any areas when no stud is present.
3M COMPANY – CS-195+

*Bearing the UL Classification Marking

+Bearing the UL Listing Mark

Reprinted from the Online Certifications Directory with permission from Underwriters Laboratories Inc.
Copyright © 2010 Underwriters Laboratories Inc.®



W-L-4037

September 20, 2011

ANSI/UL1479 (ASTM E814)

F Ratings – 1 and 2 Hr (See Item 1)

T Ratings – 0 and 1/2 Hr (See Item 1)

L Ratings At Ambient – 7 and 22 CFM/sq ft (See Item 4)

L Ratings At 400 F – 4 and 21 CFM/sq ft (See Item 4)

CAN/ULC S115

F Ratings – 1 and 2 Hr (See Item 1)

FT Ratings – 0 and 1/2 Hr (See Item 1)

FH Ratings – 1 and 2 Hr (See Item 1)

FTH Ratings – 0 and 1/2 Hr (See Item 1)

L Ratings At Ambient – 7 and 22 CFM/sq ft (See Item 4)

L Ratings At 400 F – 4 and 21 CFM/sq ft (See Item 4)

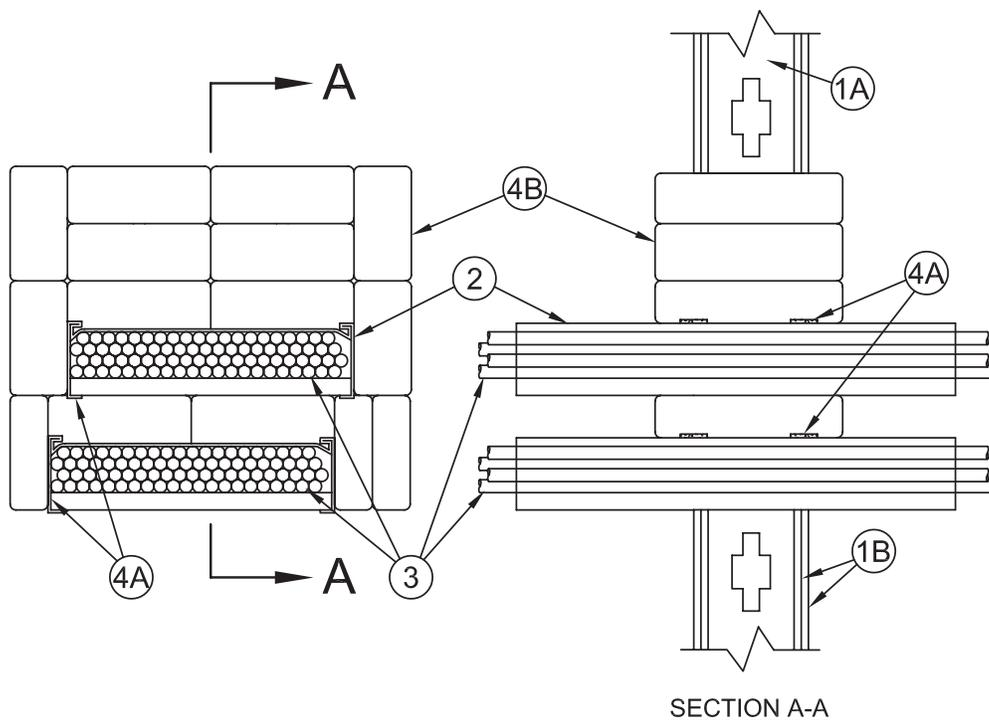

1. **Wall Assembly** – The 1 or 2 hr fire-rated gypsum board/stud wall assembly shall be constructed of the materials and in the manner specified in the individual U300, U400, V400 or W400 Series Wall and Partition Designs in the UL Fire Resistance Directory and shall include the following construction features:

- A. **Studs** – Wall framing may consist of either wood studs or steel channel studs. Wood studs to consist of nom 2 by 4 in. (51 by 102 mm) lumber spaced 16 in. (406 mm) OC. Steel studs to be min 3-5/8 in. (92 mm) wide and spaced max 24 in. (610 mm) OC. Additional framing members shall be used to completely frame around opening.
- B. **Gypsum Board*** – Thickness, type, number of layers and fasteners as required in the individual Wall and Partition Design. Max area of opening is 540 sq. in. (0.35 m²) with a max dimension of 30 in. (762 mm).

The hourly F and FT Ratings for the firestop system are equal to the hourly fire rating of the wall assembly in which it is installed. The hourly T, FT and FTH Ratings for the firestop system are 0 and 1/2 hr for 1 and 2 hr rated assemblies, respectively.

2. **Cable Tray** – Max 24 in. (610 mm) wide by max 4 in. (102 mm) deep open ladder cable tray with channel-shaped side rails formed of min 0.058 in. (1.5 mm) thick (16 gauge) galv steel with nom 1 in. (25 mm) diam rungs spaced 9 in. (229 mm) OC or max 24 in. (610 mm) wide by max 4 in. (102 mm) deep open ladder cable tray with channel-shaped side rails formed from 0.060 in. (1.5 mm) thick aluminum with nom 1 in. (25 mm) diam rungs spaced 9 in. (229 mm) OC. Max two cable trays per opening. The annular space between the cable trays is a min 6 in. (152 mm) to max 10 in. (254 mm) The annular space between the cable trays and the periphery of the opening will be min 0 in. (0 mm, point contact) to max 5 in. (127 mm). Cable trays to be rigidly supported on both sides of wall assembly.
3. **Cables** – Aggregate cross-sectional area of cables in cable tray not to exceed 40 percent of the cross-sectional area of the cable tray based on a max 3 in. (76 mm) cable loading depth within the tray. Any combination of the following types and sizes of cables may be used:
 - A. Max 1/C 750 kcmil (or smaller) copper conductor cable with cross-linked polyethylene (XLPE) jacket.
 - B. Max 300 pair No. 22 AWG (or smaller) copper conductor telecommunication cables with polyvinyl chloride (PVC) insulation and jacket.
 - C. Max 7/C No. 12 AWG copper conductor power and control cables with XLPE or PVC insulation with XLPE or PVC jacket.
 - D. Max 4/C No. 2/0 AWG copper or aluminum conductor cables with PVC insulation and jacket..
 - E. Max 1-10/125 Fiber Optic (F.O) cable with PVC insulation and jacket.
 - F. Max No. 18 AWG Type RG coaxial cable with polyvinyl chloride insulation.

System No. W-L-4037 continued

Through Penetrations

Cable Trays

4000 Series

Gypsum

W-L

4. **Firestop System** – The firestop system shall consist of the following:

A. **Fill Void or Cavity Material* – Putty** – Min 1/2 in. (13 mm) thickness of putty formed to a min 1 in. (25 mm) width and applied within annulus at all corners of opening and extending a min 1 in. (25 mm) in both directions from each corner, flush with both surfaces of wall. Additional putty installed inside cable tray side rails to completely fill side rails within the opening and extending approximately 1/2 in. (13 mm) beyond both surfaces of wall. After installation of pillows (Item 4B) all voids within the opening shall be filled with a min 1 in. (13 mm) thickness of putty. The individual cables may be wrapped with a min 1/4 in. (6 mm) thickness, min 2 in. (51 mm) width of putty such that the putty extends approximately 1/2 in. (13 mm) beyond both surfaces of wall.

3M COMPANY – MP+ or Cable Wrap

L Ratings are 7 and 4 CFM/sq ft. at ambient and 400° F, respectively, when individual cables are wrapped with 3M Cable Wrap or MP+ putty in accordance with the installation instructions. L Ratings are 22 and 21 CFM/sq ft. at ambient and 400° F, respectively, when individual cables are not wrapped with 3M Cable Wrap or MP+ putty.

B. **Fill Void or Cavity Material* – Pillows** – Max 9 in. (229 mm) long by 6 in. (152 mm) wide by 2 and 3 in. (51 and 76 mm) thick plastic covered pillows tightly-packed to fill annular space between cable tray and periphery of opening. Pillows installed with 9 in. (229 mm) dimension projecting through wall and centered within the opening.

3M COMPANY – Fire Barrier Pillow or Fire Barrier Self-Locking Pillows

*Bearing the UL Classification Mark

Reprinted from the Online Certifications Directory with permission from Underwriters Laboratories Inc.
Copyright © 2011 Underwriters Laboratories Inc.®



System No. W-L-4044

September 07, 2004

F Ratings – 1 & 2 Hr (See Item 1)
T Ratings – 1/4 & 1/2 Hr (See Item 1)

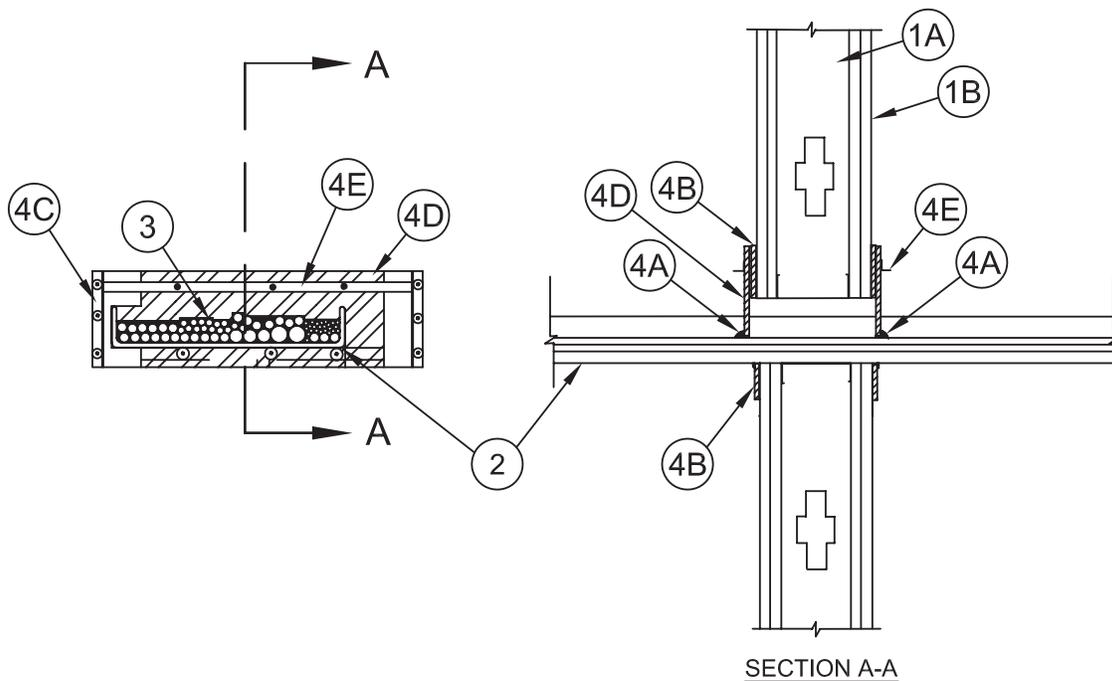

- Wall Assembly** – The 1 or 2 hr fire-rated gypsum board/stud wall assembly shall be constructed of the materials and in the manner specified in the individual U400 Series Wall or Partition Designs in the UL Fire Resistance Directory and shall include the following construction features:

- Studs** – Wall framing shall consist of steel channel studs. Steel studs to be min 3-5/8 in. (92 mm) wide and spaced max 24 in. (610 mm) OC. Additional framing members shall be used to completely frame around opening.
- Gypsum Board*** – Thickness, type, number of layers and fasteners as required in the individual Wall and Partition Design. Max area of opening is 180 in.² (1161 cm²) with a max dimension of 30 in. (762 mm).

The hourly F Rating for the firestop system is equal to the hourly fire rating of the wall assembly in which it is installed. The hourly T Rating for the firestop system is 1/4 and 1/2 hr for 1 and 2 hr rated assemblies, respectively.

- Cable Tray** – Max 24 in. (610 mm) wide by max 4 in. (610 mm) deep open-ladder cable tray with channel-shaped side rails formed of min 0.058 in. thick (16 gauge) galv steel with nom 1 in. (25 mm) diam rungs spaced 9 in. (229 mm) OC or max 24 in. (610 mm) wide by max 4 in. (102 mm) deep open ladder cable tray with channel-shaped side rails formed from 0.060 in. thick aluminum with nom 1 in. (25 mm) diam rungs spaced 9 in. (229 mm) OC. The min annular space between the cable tray and the periphery of opening shall be 0 in. (point contact). The max annular space between the cable tray and the periphery of the opening shall be 2 in. (51 mm) to top of opening and 6 in. (152 mm) to side of opening. Cable tray to be rigidly supported on both sides of wall assembly.
- Cables** – Aggregate cross-sectional area of cables in cable tray to be min 0 percent to max 40 percent of the cross-sectional area of the cable tray based on a max 3 in. (76 mm) cable loading depth within the tray. Any combination of the following ss and sizes of cables may be used:
 - Max 750 kcmil single-conductor power cables; cross-linked polyethylene (XLPE) insulation.
 - Max 7C No. 12 AWG (or smaller) multi conductor power and control cables; XLPE insulation, XLPE or polyvinyl chloride (PVC) jacket.
 - Max 300 pair No. 22 AWG (or smaller) copper conductor with PVC insulation and jacket.
 - Max No. 18 AWG RG 6/U coaxial cable with PVC insulation and jacket.
 - Max 4/C No. 2/0 AWG (or smaller) copper or aluminum conductor cables with XLPE or PVC insulation and jacket.
 - Max 1-10/125 Fiber Optic (F.O) cable with PVC insulation and jacket.
- Firestop System** – The firestop system shall consist of the following:
 - Fill, Void or Cavity Materials* - Caulk, Sealant or Putty — A nom 1 in. (25 mm) thick by 1 in. (25 mm) wide strip of moldable putty or caulk shall be applied to follow the contours of the cable fill on bottom of cable tray and project approx 1/2 in. to 7/8 in. (13 mm to 22 mm) beyond surface of wall on both sides of wall. A min 5/8 in (16 mm) width of caulk or putty shall be applied to fill the channel of the cable tray side-rails and positioned flush with to projecting a max of 1/2 in. (13 mm) beyond the outside surface of both sides of wall. A min 1/8 in. (3.2 mm) thickness by 2 in. (51 mm) wide strip of putty shall be applied over each layer or row of cables and project approx 1/2 in. to 7/8 in. (13 mm to 22 mm) beyond the outside surface of the intumescent slide sheet on each side of wall assembly. After installation of the intumescent slide sheet, putty pressed into cable fill and against intumescent sheet to fill all openings. Nom 1/2 in. (13 mm) diam “ropes” of putty applied around cable tray side-rail members at their egress from the intumescent sheet (Item 4B) and pressed into the intersections.

3M COMPANY – CP 25WB+ caulk, FB-3000 WT sealant or MP+ Stix putty

System No. W-L-4044 *continued*

- B. Fill, Void or Cavity Materials* – Intumescent Sheet** – Rigid aluminum foil-faced sheet with galv steel sheet backer. Min 2 in. (51 mm) wide sheets cut to frame opening on all sides and overlap a min 2 in. (51 mm) onto gypsum surface. Side pieces of sheets shall be cut to cover annular space to side rails. Sheet to be installed with the galv steel sheet backer exposed (aluminum foil facing against wall surface) and secured to steel framing, through gypsum board layers, with min 2-1/4 in. (57 mm) long bugle-head steel screws in conjunction with min 3/4 in. (19 mm) steel washers. Fasteners spaced a max 1 in. from each end and each seam of sheets and not to exceed 6 in. (152 mm) OC.
- 3M COMPANY** – CS-195+
- C. Steel Z Angle Retainer Plates** – Min 16 gauge galv steel retaining plates 4 in. (102 mm) wide overall, 3 in. by 1 in. (76 mm by 25 mm) with 3/8 in. (10 mm) deep break. Plate to be height of opening plus 4 in. Plate to be installed over previously installed intumescent sheet on both sides of opening with min 2-1/4 in. (57 mm) long steel screws in conjunction with min 3/4 in. (19 mm) diam steel washers. Fasteners spaced a max 1 in. (25 mm) from top and bottom of plates and not to exceed 6 in. (152 mm) OC. Plates to extend 2 in. (51 mm) above and below opening. The 3 in. (76 mm) dimension of the plates installed such that the outside edges of plates are flush with intumescent sheet outside edges.
- D. Fill, Void or Cavity Materials* – Intumescent Sheet** – (Slide Sheet) – Slide sheet cut to width of opening to allow installation into Z retaining angle brackets. Bottom of sheet cut to closely follow the contours of the cable fill within the cable tray. Slide sheet to be of sufficient height to overlap top of opening min 2 in. (51 mm). Sheet to be installed with the galv steel sheet backer exposed.
- E. Steel Reinforcement Angle** – Min 1/8 in. (3.2 mm) thick 1 in. by 1 in. (25 mm by 25 mm) steel angle. Angle to be placed midway across width of slide sheet. Angle attached to sheet with 1/4 in. (6 mm) long steel sheet metal TEK screws spaced max 4 in. from each end and a max 9 in. (229 mm) O.C. Screws not used on ends over angle retainer plate.
- F. Fill, Void or Cavity Materials* – Graphite Seal** – (Not Shown) – One layer of 1/2 in. (13 mm) wide by 1/16 in. (1.6 mm) thick adhesive backed graphite intumescent seal positioned under intumescent slide sheet 1/2 in. (13 mm) from top edge of slide sheet.
- 3M COMPANY** – E-FIS or Ultra GS seal

*Bearing the UL Classification Mark

Reprinted from the Online Certifications Directory with permission from Underwriters Laboratories Inc.
Copyright © 2010 Underwriters Laboratories Inc.®



Through Penetrations

Cable Trays

4000 Series

Gypsum

W-L

System No. W-L-4052

June 09, 2004

F Ratings – 1 and 2 Hr (See Item 1)

T Ratings – 0 and 1/2 Hr (See Item 1)

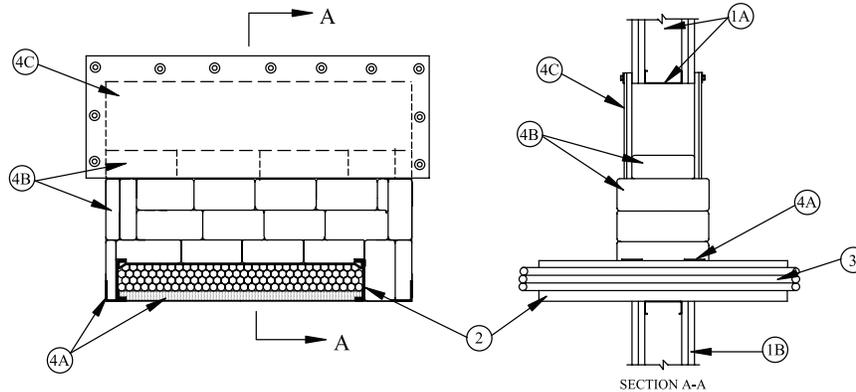

1. **Wall Assembly** – The 1 or 2 hr fire-rated gypsum board/stud wall assembly shall be constructed of the materials and in the manner specified in the individual U400 or V400 Series Wall or Partition Designs in the UL Fire Resistance Directory and shall include the following construction features:

- A. **Studs** – Min 3-1/2 in. (89 mm) wide steel studs spaced max 24 in. (610 mm) OC. Additional framing members shall be used to completely frame around opening.
- B. **Gypsum Board*** – Thickness, type, number of layers and fasteners as required in the individual Wall and Partition Design. Max area of opening is 720 in.2 (4645 cm2) with a max dimension of 30 in. (762 mm).

The hourly F Rating for the firestop system is equal to the hourly fire rating of the wall assembly in which it is installed. The hourly T Rating for the firestop system is 0 and 1/2 hr for 1 and 2 hr rated assemblies, respectively.

2. **Cable Tray** – Max 24 in. (610 mm) wide by max 4 in. (102 mm) deep open ladder cable tray with channel-shaped side rails formed of min 0.058 in. thick (1.47 mm) galv steel with nom 1 in. (25 mm) diam rungs spaced 9 in. (229 mm) OC or max 24 in. (610 mm) wide by max 4 in. (102 mm) deep open ladder cable tray with channel-shaped side rails formed from 0.060 in. (1.52 mm) thick aluminum with nom 1 in. (25 mm) diam rungs spaced 9 in. (229 mm) OC. Max two cable trays per opening. The annular space between the cable trays is a min 6 in. (152 mm) to max 18 in. (457 mm). The annular space between the cable trays and the periphery of the opening will be min 0 in. (point contact) to max 18 in. (457 mm). Cable trays to be rigidly supported on both sides of wall assembly.
3. **Cables** – Aggregate cross-sectional area of cables in cable tray not to exceed 40 percent of the cross-sectional area of the cable tray based on a max 3 in. (76 mm) cable loading depth within the tray. Any combination of the following types and sizes of cables may be used:
 - A. Max 1/C 750 kcmil (or smaller) copper conductor cable with cross-linked polyethylene (XLPE) jacket.
 - B. Max 300 pair No. 22 AWG (or smaller) copper conductor telecommunication cables with polyvinyl chloride (PVC) insulation and jacket.
 - C. Max 7/C No. 12 AWG copper conductor power and control cables with XLPE or PVC insulation with XLPE or PVC jacket.
 - D. Max 4/C No. 2/0 AWG copper or aluminum conductor cables with PVC insulation and jacket.
 - E. Max 1-10/125 Fiber Optic (F.O) cable with PVC insulation and jacket..
 - F. Max No. 18 AWG Type RG coaxial cable with polyvinyl chloride insulation.
4. **Firestop System** – The firestop system shall consist of the following:

- A. **Fill, Void or Cavity Materials* – Putty** – Min 1/2 in. (13 mm) thickness of putty formed to a min 1 in. (25 mm) width and applied within annulus at the bottom corners of opening and extending a min 1 in. (25 mm) in both directions from each corner, flush with both surfaces of wall. Min 5/8 in. (16 mm) thickness of putty installed between bottom of cable tray and bottom of opening on both surfaces of wall. As an option, the putty between the bottom of the cable tray and the bottom of the opening may be replaced by pillows (Item 4B), provided the annular space is such that the pillows can be tightly fitted into the annular space. After installation of pillows and intumescent sheet (Items 4B and 4C), all voids within the opening shall be filled with a min 1 in. (25 mm) thickness of putty on both sides of wall.

3M COMPANY – MP+

- B. **Fill, Void or Cavity Materials* – Pillow** – Max 9 in. (229 mm) long by 6 in. (152 mm) wide by 2 and 3 in. (51 and 76 mm) thick plastic covered pillows tightly packed to fill annular space between the cable trays and periphery of opening and the annular space between the cable trays when two trays are installed within the opening. A min of two rows of pillows to be installed above the top cable tray in opening. Pillows installed with 9 in. (229 mm) dimension projecting through wall and centered within the opening except that the top row of pillows in the opening shall be installed with the 6 in. (152 mm) dimension centered in the wall such that the top row is completely covered by the intumescent sheet (Item 4C).

3M COMPANY – Fire Barrier Pillow or Fire Barrier Self-Locking Pillows

- C. **Fill, Void or Cavity Materials* – Intumescent Sheet** – Rigid aluminum foil-faced sheet with galv steel sheet backer. The one piece sheet shall be cut to lap a min of 2 in. (51 mm) onto the wall at the top and sides of the opening on both sides of the wall. Sheet shall be cut to completely lap the top row of pillows above the top cable tray on both sides of the wall. Sheet to be installed with the galv steel sheet backer exposed (aluminum foil facing against wall surface) and secured to steel framing, through gypsum wallboard layers, with min 1/4 in. (6 mm) diam by 2-1/4 in. (57 mm) long steel screws in conjunction with min 1-1/4 in. (32 mm) diam steel washers. Max spacing of fasteners not to exceed 6 in. (152 mm) with fasteners located a max 1 in. (25 mm) from each corner of the sheet.

3M COMPANY – Type CS-195+

*Bearing the UL Classification Mark

Reprinted from the Online Certifications Directory with permission from Underwriters Laboratories Inc.

Copyright © 2010 Underwriters Laboratories Inc.®

System No. W-L-4062

September 20, 2011

ANSI/UL1479 (ASTM E814)

F Ratings – 1 and 2 Hr (See Item 1)

T Ratings – 0 and 3/4 Hr (See Item 1)

CAN/ULC S115

F Ratings – 1 and 2 Hr (See Item 1)

FT Ratings – 0 and 3/4 Hr (See Item 1)

FH Ratings – 1 and 2 Hr (See Item 1)

FTH Ratings – 0 and 3/4 Hr (See Item 1)

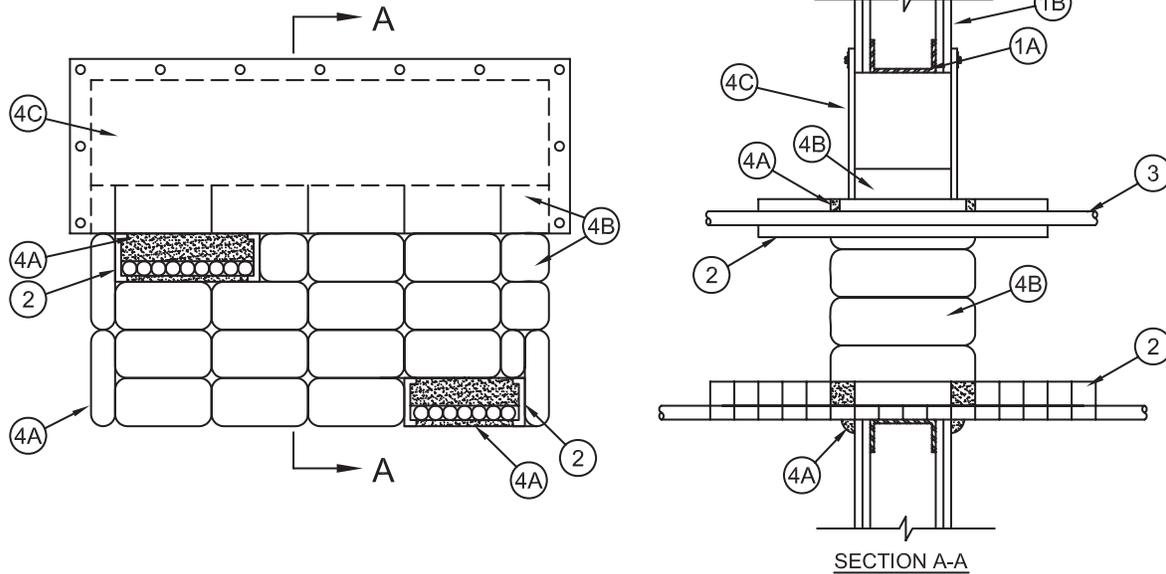

1. **Wall Assembly** – The 1 or 2 hr fire-rated gypsum board/stud wall assembly shall be constructed of the materials and in the manner specified in the individual U400, V400 or W400 Series Wall and Partition Designs in the UL Fire Resistance Directory and shall include the following construction features:

- A. **Studs** – Min 3-1/2 in. (89 mm) wide steel studs spaced max 24 in. (610 mm) OC. Additional framing members shall be used to completely frame around opening.
- B. **Gypsum Board*** – Thickness, type, number of layers and fasteners as required in the individual Wall and Partition Design. Max area of opening is 720 in.² (0.47 m²) with a max dimension of 30 in. (762 mm).

The hourly F and FH Ratings for the firestop system are equal to the hourly fire rating of the wall assembly in which it is installed.

The hourly T, FT and FTH Ratings for the firestop system are 0 hr and 3/4 hr for 1 hr and 2 hr fire rated assemblies, respectively.

2. **Cable Tray** – Max 12 in. (305 mm) wide by max 1-1/2 in. (38 mm) deep open ladder cable tray with channel-shaped side rails formed of min 0.062 in. thick (1.6 mm) aluminum with nom 1 in. (25 mm) wide by 1 in. (25 mm) high rungs spaced 9 in. (229 mm) OC or max 8-3/4 in. (222 mm) wide by max 2-1/2 in. (64 mm) deep welded wire basket cable tray formed from min 0.198 in. (5 mm) thick steel and having a max 2 by 4 in. (51 by 102 mm) grid. Max two cable trays per opening. The annular space between the cable trays shall be min 6 in. (152 mm) to max 12 in. (305 mm). The annular space between the cable trays and the periphery of the opening shall be min 1-1/2 in. (38 mm) to max 20 in. (508 mm). Cable trays to be rigidly supported on both sides of wall assembly.
3. **Cables** – Aggregate cross-sectional area of cables in cable tray not to exceed 40 percent of the cross-sectional area of the open ladder aluminum cable tray based on a max 1-1/2 in. (38 mm) cable loading depth. Aggregate cross-sectional area of cables in welded wire basket cable tray not to exceed 23 percent of the cross-sectional area of the welded wire basket cable tray based on a max 1-1/2 in. (38 mm) cable loading depth. Any combination of the following types and sizes of cables may be used:
 - A. Max 1/C 750 kcmil (or smaller) copper conductor cable with cross-linked polyethylene (XLPE) jacket.
 - B. Max 300 pair No. 22 AWG (or smaller) copper conductor telecommunication cables with polyvinyl chloride (PVC) insulation and jacket.
 - C. Max 7/C No. 12 AWG copper conductor power and control cables with XLPE or PVC insulation with XLPE or PVC jacket.
 - D. Max 4/C No. 2/0 AWG copper or aluminum conductor cables with PVC insulation and jacket.
 - E. Max 1-10/125 Fiber Optic (FO) cable with PVC insulation and jacket.
 - F. Max No. 18 AWG Type RG coaxial cable with polyvinyl chloride insulation.
4. **Firestop System** – The firestop system shall consist of the following:
 - A. **Fill Void or Cavity Material* – Putty** – Min 1/2 in. (13 mm) thickness of putty formed to a min 1 in. (25 mm) width and applied within annulus at the bottom corners of opening and extending a min 1 in. (25 mm) in both directions from each corner, flush with both surfaces of wall. Min 5/8 in. (16 mm) thickness of putty installed between bottom of cable tray and bottom of opening and between top of cable tray and bottom of composite sheet on both surfaces of wall. As an option, the putty between the bottom of the cable tray and the

System No. W-L-4062 *continued*

bottom of the opening may be replaced by pillows (Item 4B), provided the annular space is such that the pillows can be tightly fitted into the annular space. After installation of pillows and intumescent sheet (Items 4B and 4C), all voids within the opening shall be filled with a min 1 in. (25 mm) thickness of putty on both sides of wall.

3M COMPANY – MP+

- B. **Fill Void or Cavity Material*** – **Pillows** – Max 9 in. (229 mm) long by 6 in. (152 mm) wide by 2 and 3 in. (51 and 76 mm) thick plastic covered pillows tightly-packed to fill annular space between the cable trays and periphery of opening and the annular space between the cable trays when two trays are installed within the opening. Pillows installed with 9 in. (229 mm) dimension projecting through wall and centered within the opening except that the top row of pillows in the opening shall be installed with the 6 in. (152 mm) dimension centered in the wall such that the top row is completely covered by the intumescent sheet (Item 4C).

3M COMPANY – Fire Barrier Pillow or Fire Barrier Self-Locking Pillows

- C. **Fill, Void or Cavity Materials*** – **Intumescent Sheet** – Rigid aluminum foil-faced sheet with galv steel sheet backer. The one piece sheet shall be cut to lap a min of 2 in. (51 mm) onto the wall at the top and sides of the opening on both sides of the wall. Sheet shall be cut to completely lap the top row of pillows above the top cable tray on both sides of the wall. Sheet to be installed with the galv steel sheet backer exposed (aluminum foil facing against wall surface) and secured to steel framing, through gypsum board layers, with min 1/4 in. (6 mm) diam by 2-1/4 in. (57 mm) long steel screws in conjunction with nom 1/4 by 1-1/4 in. (6 by 32 mm) diam steel washers. Max spacing of fasteners not to exceed 6 in. (152 mm) with fasteners located a max 1 in. (25 mm) from each corner of the sheet.

3M COMPANY – Type CS-195+

*Bearing the UL Classification Mark

Reprinted from the Online Certifications Directory with permission from Underwriters Laboratories Inc.
Copyright © 2011 Underwriters Laboratories Inc.®



Through Penetrations

Cable Trays

4000 Series

Gypsum

WL

System No. W-L-4066

September 20, 2011

ANSI/UL1479 (ASTM E814)

F Ratings – 1 and 2Hr (See Item 1)

T Rating – 0 Hr

CAN/ULC S115

F Ratings – 1 and 2Hr (See Item 1)

FT Rating – 0 Hr

FH Ratings – 1 and 2Hr (See Item 1)

FTH Rating – 0 Hr

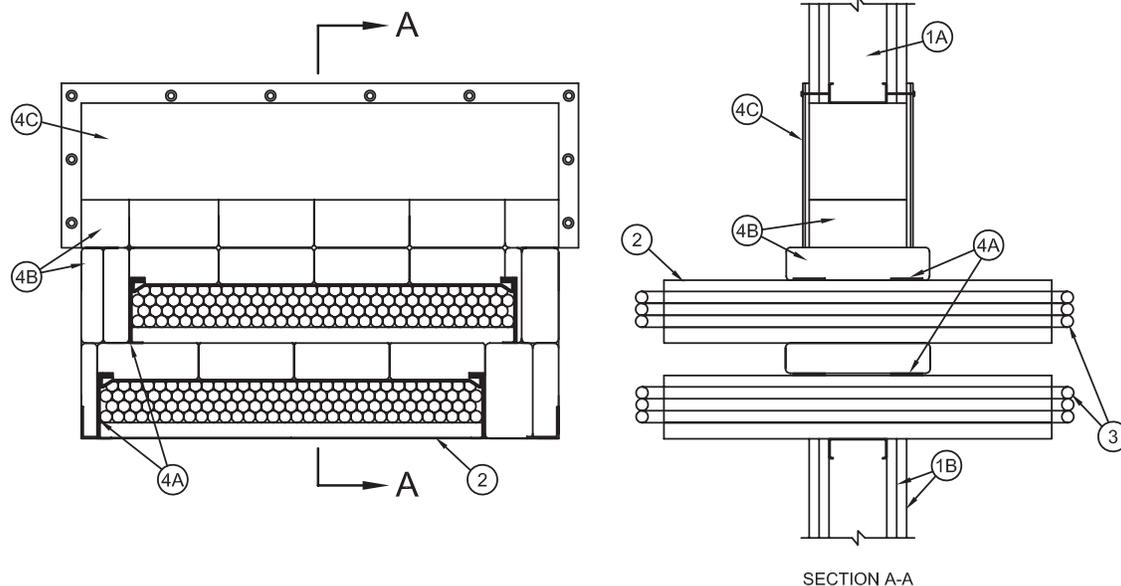

1. **Wall Assembly** – The 1 or 2 hr fire-rated gypsum board/stud wall assembly shall be constructed of the materials and in the manner specified in the individual U400, V400 or W400 Series Wall and Partition Designs in the UL Fire Resistance Directory and shall include the following construction features:
 - A. **Studs** – Min 3-1/2 in. (89 mm) wide steel studs spaced max 24 in. (610 mm) OC. Additional framing members shall be used to completely frame around opening.
 - B. **Gypsum Board*** – Thickness, type, number of layers and fasteners as required in the individual Wall and Partition Design. Max area of opening is 720 in.2 (0.47 m2) with a max dimension of 30 in. (762 mm).

The hourly F and FH Ratings for the firestop system are equal to the hourly fire rating of the wall assembly in which it is installed.
2. **Cable Tray** – Max two cable trays to be installed within the opening. The annular space between the cable trays shall be min 6 in. (152 mm) to max 10 in. (254 mm). The annular space between the cable trays and the periphery of the opening shall be min 0 in. (0 mm, point contact) to max 10 in. (254 mm). Cable trays to be rigidly supported on both sides of wall assembly. The following types of the cable trays may be used:
 - A. Max 24 in. (610 mm) wide by max 4 in. (102 mm) deep open ladder cable tray with channel-shaped side rails formed of min 0.058 in. thick (1.5 mm) galv steel with nom 1 in. (25 mm) diam rung spaced 9 in. (229 mm) OC
 - B. Max 24 in. (610 mm) wide by max 4 in. (102 mm) deep open ladder cable tray with channel-shaped side rails formed of min 0.060 in. thick (1.5 mm) aluminum with nom 1 in. (25 mm) diam rung spaced 9 in. (229 mm) OC.
 - C. Max 8-3/4 in. (222 mm) wide by max 2-1/2 in. (64 mm) deep welded wire basket cable tray formed from min 0.198 in. (5 mm) thick steel and having a max 2 by 4 in. (51 by 102 mm) grid.
3. **Cables** – Aggregate cross-sectional area of cables in cable tray not to exceed 40 percent of the cross-sectional area based on a max 3 in. (76 mm) cable loading depth within the open ladder cable tray. Aggregate cross-sectional area of cables in welded wire basket cable tray not to exceed 23 percent of the cross-sectional area of the welded wire basket cable tray based on a max 1-1/2 in. (38 mm) cable loading depth. Any combination of the following types and sizes of cables may be used:
 - A. Max 1/C 750 kcmil (or smaller) copper conductor cable with cross-linked polyethylene (XLPE) jacket.
 - B. Max 300 pair No. 22 AWG (or smaller) copper conductor telecommunication cables with polyvinyl chloride (PVC) insulation and jacket.
 - C. Max 7/C No. 12 AWG copper conductor power and control cables with XLPE or PVC insulation with XLPE or PVC jacket.
 - D. Max 4/C No. 2/0 AWG copper or aluminum conductor cables with PVC insulation and jacket.
 - E. Max 1-10/125 Fiber Optic (FO) cable with PVC insulation and jacket.
 - F. Max No. 18 AWG Type RG coaxial cable with polyvinyl chloride insulation.
4. **Firestop System** – The firestop system shall consist of the following:
 - A. **Fill Void or Cavity Material* – Putty** – Min 1/2 in. (13 mm) thickness of putty formed to a min 1 in. (25 mm) width and applied within annulus at the bottom corners of opening and extending a min 1 in. (25 mm) in both directions from each corners, flush with both surfaces of wall. Min 5/8 in. (16 mm) thickness of putty installed between bottom of cable tray and bottom of opening and between top

System No. W-L-4066 *continued*

of cable tray and bottom of composite sheet on both surfaces of wall. As an option, the putty between the bottom of the cable tray and the bottom of the opening may be replaced by pillows (Item 4B), provided the annular space is such that the pillows can be tightly fitted into the annular space. After installation of pillows and intumescent sheet (Items 4B and 4C), all voids within the opening shall be filled with a min 1 in. (25 mm) thickness of putty on both sides of wall.

3M COMPANY – MP+

- B. **Fill Void or Cavity Material* – Pillows** – Max 9 in. (229 mm) long by 6 in. (152 mm) wide by 2 and 3 in. (51 and 76 mm) thick plastic covered pillows tightly-packed to fill annular space between the cable trays and periphery of opening and the annular space between the cable trays when two trays are installed within the opening. Pillows installed with 9 in. (229 mm) dimension projecting through wall and centered within the opening except that the top row of pillows in the opening shall be installed with the 6 in. (152 mm) dimension centered in the wall such that the top row is completely covered by the intumescent sheet (Item 4C).

3M COMPANY – Fire Barrier Pillow or Fire Barrier Self-Locking Pillows

- C. **Fill, Void or Cavity Materials* – Intumescent Sheet** – Rigid aluminum foil-faced sheet with galv steel sheet backer. The one piece sheet shall be cut to lap a min of 2 in. (51 mm) onto the wall at the top and sides of the opening on both sides of the wall. Sheet shall be cut to completely lap the top row of pillows above the top cable tray on both sides of the wall. Sheet to be installed with the galv steel sheet backer exposed (aluminum foil facing against wall surface) and secured to steel framing, through gypsum board layers, with min 1/4 in. (6 mm) diam by 2-1/4 in. (57 mm) long steel screws in conjunction with nom 1/4 by 1-1/4 in. (6 by 32 mm) diam steel washers. Max spacing of fasteners not to exceed 6 in. (152 mm) with fasteners located a max 1 in. (25 mm) from each corner of the sheet.

3M COMPANY – Type CS-195+

*Bearing the UL Classification Mark

Reprinted from the Online Certifications Directory with permission from Underwriters Laboratories Inc.
Copyright © 2011 Underwriters Laboratories Inc.®



Through Penetrations

Cable Trays

4000 Series

Gypsum

WL

System No. W-L-4067

May 23, 2011

F Ratings – 1 and 2 Hr (See Item 1)

T Rating – 0 Hr

Rating At Ambient – 4 to 7 CFM/sq ft (See Item 4B)

L Rating At 400 F – Less Than 1 CFM/sq ft (See Item 4B)

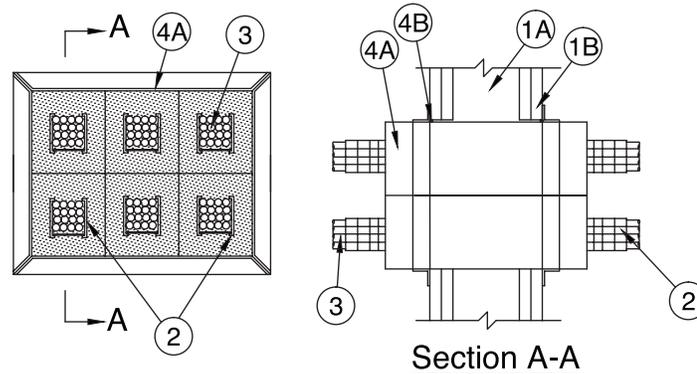

1. **Wall Assembly** – The 1 or 2 hr fire rated gypsum board/stud wall assembly shall be constructed of the materials and in the manner described in the individual U300, U400 or V400 Series Wall and Partition Design in the UL Fire Resistance Directory and shall include the following construction features:

- A. **Studs** – Wall framing may consist of either wood or steel channel studs. Wood studs to consist of nom 2 by 4 in. (51 by 102 mm) lumber spaced 16 in. (406 mm) OC. Steel studs to be min 3-1/2 in. (89 mm) wide spaced max 24 in. (610 mm) OC.
- B. **Gypsum Board*** – Min 5/8 in. thick gypsum board. Max area of opening is 98-1/2 in.² (635 cm²) with a max dimension of 12-1/8 in. (308 mm) for square devices. Diam of opening is 4-1/2 in. (114 mm) for round devices.

The hourly F Rating of the firestop system is equal to the hourly fire rating of the wall assembly in which it is installed.

2. **Cable Tray*** – Nom 2 in. (51 mm) wide by 2 in. (51 mm) high welded wire basket cable tray formed from min 0.23 in. (5.8 mm) thick steel wires in the longitudinal direction and 0.19 in. (4.8 mm) wires in the transverse direction. Transverse wires shall be spaced max 4 in. OC. Max one cable tray shall be installed within each firestop device module (Item 4A). The annular space between the cable tray and the periphery of the device shall be min 1/2 in. (13 mm) to max 1-1/2 in. (38 mm). Cable tray to be rigidly supported on both sides of wall assembly.
3. **Cables** – Cable fill within cable tray shall be a nom 2 in. (100% visual fill). If three or more firestop devices (Item 4A) are ganged together, the cable fill may be less than 2 in. Any combination of the following types and sizes of cables may be used:
- A. Max 4 pair No. 24 AWG copper conductor Cat5e or Cat 6 telephone cable with polyvinyl chloride (PVC) insulation and jacket materials.
- B. Max 4 pair No. 23 AWG copper conductor Cat 6 telephone cable with PVC insulation and jacket materials.
4. **Firestop System** – The firestop system shall consist of the following:

- A. **Firestop Device*** – A max of six square firestop devices may be ganged together. As an alternate, one round device may be centered in a round opening. Each device consists of a nom 4 by 4 by 10 in. (102 by 102 by 254 mm) or 4 in. (102 mm) diam by 10 in. (254 mm) powder coated steel transit incorporating internal intumescent material, foam plugs and mounting flanges. Firestop device(s) to be installed within opening with ends projecting an equal distance beyond each surface of wall assembly in accordance with the accompanying installation instructions. The annular space between device(s) and periphery of opening shall be a nom 1/16 in. (1.6 mm). Firestop device(s) secured in place by means of fill material (Item 3B) and steel split mounting flanges sized to accommodate the firestop device. Steel split mounting flanges installed on both sides of wall after installation of fill material, and secured together with supplied steel set screws. Nom 1 in. (25 mm) thick pre-cut foam plugs sized to accommodate the through penetrant and installed flush with each end of device on both sides of wall assembly. The foam plug in one or both ends of the device is optional except when L Rating is required (See Item 3B).

3M COMPANY – 3M Fire Barrier Pass-Through Device

- B. **Fill, Void or Cavity Materials* – Putty or Caulk** – Min 1/8 in. (3 mm) bead of fill material shall be applied at interface of gypsum board and firestop devices immediately prior to the installation of the mounting flanges. If three or less devices (Item 3A) are ganged together, the fill material may be optional. As an option, foam plugs may be recessed into device and the recess filled with putty or caulk flush with the ends of the device. As an option to attain L Ratings, foam plugs of firestop device modules may be recessed 1 in. (25 mm) into device and the recess filled with putty or caulk flush with the ends of the device. When annulus around firestop device module(s) is filled with putty or caulk and when both ends of each firestop device module are filled with a nominal 1/8 in. (3.2 mm) depth of putty or caulk the following L Ratings apply:

| Max Percent Cable Fill In Device | L Rating At Ambient, CFM/sq ft (CFM/firestop device module) | L Rating At 400 F, CFM/sq ft (CFM/firestop device module) |
|----------------------------------|---|---|
| 0 | 4 (Less Than 1) | Less Than 1 (Less Than 1) |
| 50 | 7 (1) | Less Than 1 (Less Than 1) |

3M COMPANY – Moldable Putty+, CP 25WB+, IC 15WB+, 3000 WT

*Bearing the UL Classification Mark

Reprinted from the Online Certifications Directory with permission from Underwriters Laboratories Inc.

Copyright © 2011 Underwriters Laboratories Inc.®



System No. W-L-4075

September 20, 2011

ANSI/UL1479 (ASTM E814)

F Ratings – 1 and 2 Hr (See Item 1)

T Rating – 1/2 Hr

CAN/ULC S115

F Ratings – 1 and 2 Hr (See Item 1)

FT Rating – 1/2 Hr

FH Ratings – 1 and 2 Hr (See Item 1)

FTH Rating – 1/2 Hr

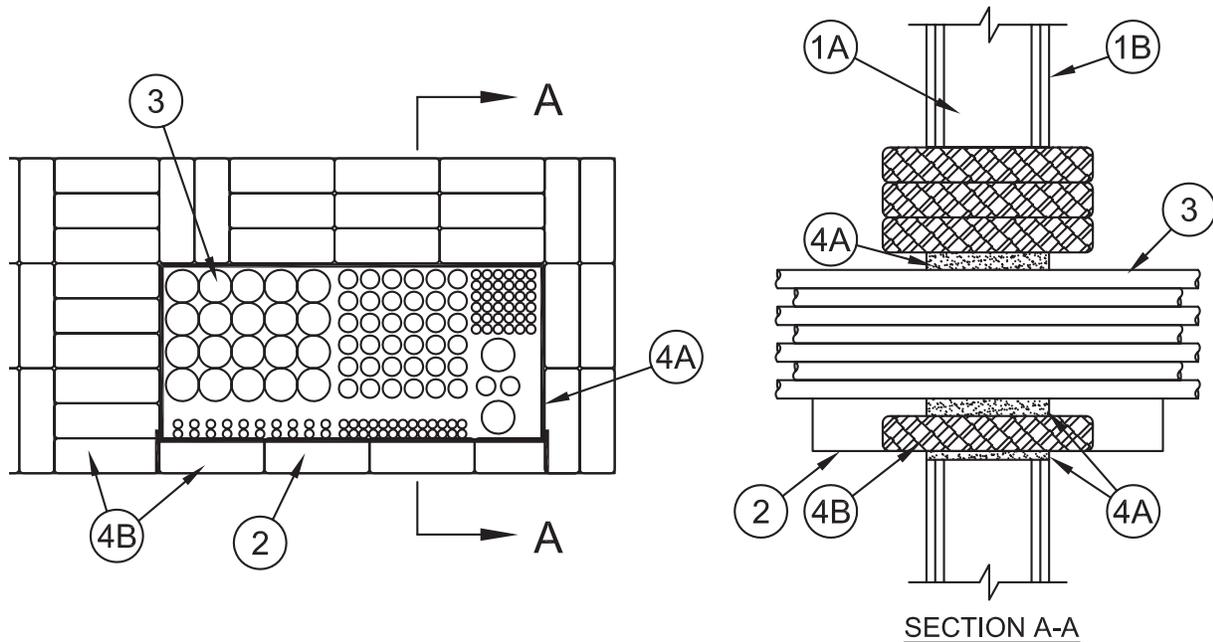

- Wall Assembly** – The 1 or 2 hr fire-rated gypsum board/stud wall assembly shall be constructed of the materials and in the manner specified in the individual U300, U400, V400 or W400 Series Wall and Partition Designs in the UL Fire Resistance Directory and shall include the following construction features:

- Studs** – Wall framing may consist of either wood studs or steel channel studs. Wood studs to consist of nom 2 by 4 in. (51 by 102 mm) lumber spaced max 16 in. (406 mm) OC. Steel studs to be min 3-1/2 in. (89 mm) wide and spaced max 24 in. (610 mm) OC. Additional framing members to be installed in stud cavity containing cable tray to form a rectangular box around the opening.
- Gypsum Board*** – One or two layers of nom 5/8 in. (16 mm) thick gypsum board, as specified in the individual Wall and Partition Design. Max area of opening is 1080 sq in. (0.7 m²) with a max dimension of 36 in. (914 mm).

The hourly F Rating of the firestop system is equal to the hourly fire rating of the wall assembly in which it is installed.

- Cable Rack** – Max 20 in. (508mm) wide by 2 in. (51 mm) deep steel cable rack formed from min 1/4 in. (6 mm) thick steel with min 1 in. (25 mm) wide rungs spaced max 9 in. (229 mm) OC. Width of cable rack to be at least 4 in. (102 mm) less than width of wall opening. When installed in a U300 Series (wood stud) wall assembly, the annular space between the cable rack and the bottom of the opening shall be min 1 in. (25 mm). When installed in a U400 or V400 Series (steel stud) wall assembly, the annular space between the cable rack and the bottom of the opening shall be min 0 in. (point contact). Side rails of cable rack to be min 2 in. (51 mm) to max 13 in. (330 mm) from side edges of wall opening. Cable rack to be rigidly supported on both sides of wall assembly.
- Cable Tray** – (Not Shown) – As an alternate to the steel cable rack (Item 2), one of the following types of cable tray may be used:
 - Max 24 in. (610 mm) wide by max 4 in. (102 mm) deep open ladder cable tray with channel-shaped side rails formed of min 0.058 in. thick (1.5 mm) galv steel with nom 1 in. (25 mm) diam rung spaced 9 in. (229 mm) OC.
 - Max 24 in. (610 mm) wide by max 4 in. (102 mm) deep open ladder cable tray with channel-shaped side rails formed of min 0.060 in. thick (1.5 mm) aluminum with nom 1 in. (25 mm) diam rung spaced 9 in. (229 mm) OC.
 - Max 8-3/4 in. (222 mm) wide by max 2-1/2 in. (64 mm) deep welded wire basket cable tray formed from min 0.198 in. (5 mm) thick steel and having a max 2 by 4 in. (51 by 102 mm) grid.

Width of cable tray to be at least 4 in. (102 mm) less than width of wall opening. The annular space between the cable tray and the bottom of the opening shall be min 2 in. (51 mm). Side rails of cable tray to be min 2 in. (51 mm) to max 13 in. (330 mm) from side edges of wall opening. Cable tray to be rigidly supported on both sides of wall assembly.

- Cables** – When cable rack (Item 2) is used, aggregate cross-sectional area of cables in opening to be max 25 percent of the cross-sectional area of the opening based on a max 15 in. (381 mm) deep cable loading depth on the cable rack. When cable tray (Item 2A) is used, the aggregate cross-sectional area of cables in cable tray not to exceed 40 percent of the cross-sectional area of the cable tray based on a max 3 in. (76 mm) cable loading depth in the cable tray. Any combination of the following types and sizes of cables may be used:
 - Max 300 pair No. 24 AWG (or smaller) copper conductor telecommunication cable with PVC insulation and jacket materials.
 - Max 1/C No. 3/0 AWG copper conductor cable with PVC insulation and jacket materials.

Through Penetrations

Cable Trays

4000 Series

Gypsum

WL

System No. W-L-4075 *continued*

- C. Max three copper conductors (with ground) No. 12 AWG steel Armored Cable+.
 - D. Max three copper conductor (with ground) No. 2 AWG Metal Clad Cable+.
 - E. Max 1/C No. 750 kcmil (or smaller) copper conductor power cable with cross-linked polyethylene (XLPE) insulation and fabric jacket materials.
 - F. Max 3/C (with ground) No. 4/0 AWG (or smaller) copper or aluminum conductor SER cable with XLPE or PVC insulation and jacket.
 - G. Max 4/C No. 18 AWG (or smaller) copper conductor thermostat cable with polyvinyl chloride (PVC) insulation and jacket materials.
 - H. Max four pair No. 22 AWG (or smaller) copper conductor Category 5 or Category 6 data cable with PVC insulation and jacket materials.
 - I. Max 3/C (with ground) No. 10 AWG (or smaller) nonmetallic sheathed (Romex) cable with PVC insulation and jacket materials.
 - J. Max twelve core No. 24 AWG shielded coaxial cable with high density polyethylene foam insulation and fluorinated ethylene (FE) or PVC jacket.
 - K. Max 62.5/125 micron fiber optic cable with having a min Riser rating.
 - L. Max 7/C No. 12 AWG (or smaller) copper conductor control cable with PVC insulation and jacket materials.
4. **Firestop System** – The firestop system shall consist of the following:
- A. **Fill, Void or Cavity Material* – Putty** – Nom 1/8 in. (3 mm) thick by 4 in. (102 mm) band of putty installed around cable bundle at mid-depth of wall. Nom 1/2 in. (13 mm) rope of putty used to fill any gaps or voids around perimeter of opening and around cable fill
3M COMPANY
3M FIRE PROTECTION PRODUCTS – MP+ or Cable Wrap Putty
 - B. **Fill, Void or Cavity Material* – Pillows** – Pillows installed length-wise through wall and tightly-packed to fill opening between the penetrants and the periphery of the opening. The pillows may be cut to decrease their width and repaired with min 0.002 in. (0.05mm) thick polyester tape with acrylic adhesive. The tape must overlap onto the existing pillow a min of 1/2 in. (13mm).
3M COMPANY
3M FIRE PROTECTION PRODUCTS – Fire Barrier Pillows or Fire Barrier Self-Locking Pillows

*Bearing the UL Classification Mark

Reprinted from the Online Certifications Directory with permission from Underwriters Laboratories Inc.
Copyright © 2011 Underwriters Laboratories Inc.®



Through Penetrations

Cable Trays

4000 Series

Gypsum

WL

System No. W-L-4080

September 20, 2011

ANSI/UL1479 (ASTM E814)

F Ratings – 1 and 2 Hr (See Item 1)

T Rating – 1/4 Hr

CAN/ULC S115

F Ratings – 1 and 2 Hr (See Item 1)

FT Rating – 1/4 Hr

FH Ratings – 1 and 2 Hr (See Item 1)

FTH Rating – 1/4 Hr

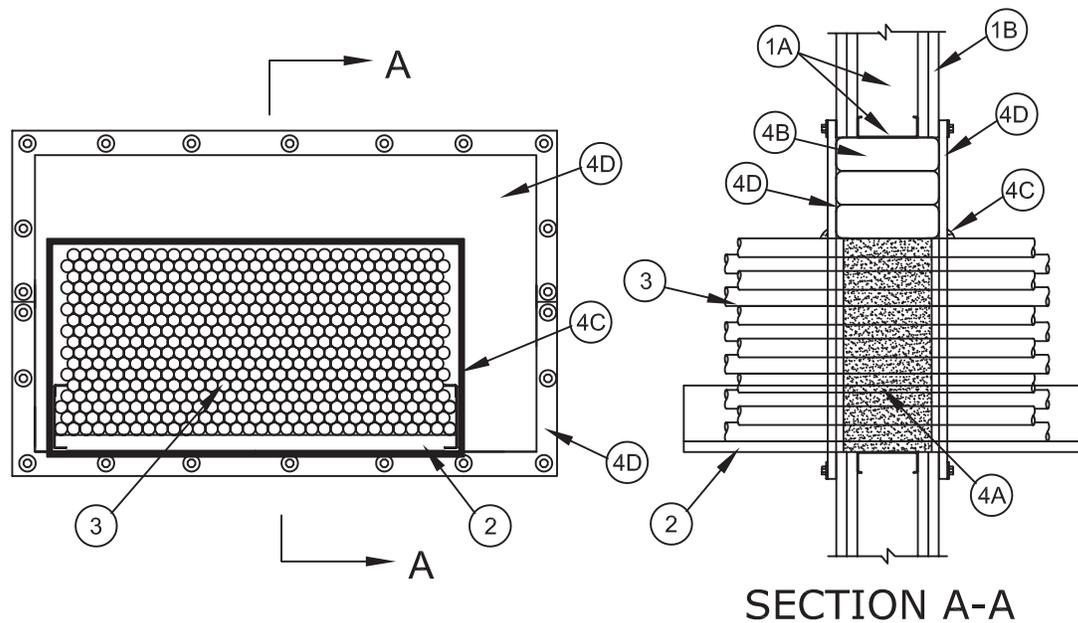

1. **Wall Assembly** – The 1 or 2 hr fire-rated gypsum board/stud wall assembly shall be constructed of the materials and in the manner specified in the individual U300, U400, V400 or W400 Series Wall and Partition Designs in the UL Fire Resistance Directory and shall include the following construction features:

- A. **Studs** – Wall framing may consist of either wood studs or steel channel studs. Wood studs to consist of nom 2 by 4 in. (51 by 102 mm) lumber spaced max 16 in. (406 mm) OC. Steel studs to be min 3-1/2 in. (89 mm) wide and spaced max 24 in. (610 mm) OC. Additional framing members to be installed in stud cavity containing cable tray to form a rectangular box around the opening.
- B. **Gypsum Board*** – One or two layers of nom 5/8 in. (16 mm) thick gypsum board, as specified in the individual Wall and Partition Design. Max area of opening is 720 sq in. (4645 cm²) with a max dimension of 30 in. (762 mm).

The hourly F and FH Ratings of the firestop system are equal to the hourly fire rating of the wall assembly in which it is installed.

2. **Cable Rack** – Max 18 in. (457 mm) wide by 2 in. (51 mm) deep steel cable rack formed from min 1/4 in. (6 mm) thick steel with min 1 in. (25 mm) wide rungs spaced max 9 in. (229 mm) OC. When installed in a U300 Series (wood stud) wall assembly, the annular space between the cable rack and the bottom of the opening shall be min 1 in. (25 mm). When installed in a U400, V400 or W400 Series (steel stud) wall assembly, the annular space between the cable rack and the bottom of the opening shall be min 0 in. (point contact). Side rails of cable rack to be min 3 in. (76 mm) to max 9 in. (229 mm) from side edges of wall opening. Cable rack to be rigidly supported on both sides of wall assembly.
3. **Cables** – Aggregate cross-sectional area of cables in opening to be max 35 percent of the cross-sectional area of the opening based on a max 14 in. (356 mm) deep cable loading depth on the cable rack. Any combination of the following types and sizes of cables may be used:
 - A. Max 300 pair No. 24 AWG (or smaller) copper conductor telecommunication cable with PVC insulation and jacket materials.
 - B. Max 1/C No. 3/0 AWG copper conductor cable with PVC insulation and jacket materials.
 - C. Max three copper conductors (with ground) No. 12 AWG steel Armored Cable+.
 - D. Max three copper conductor (with ground) No. 2 AWG Metal Clad Cable+.
 - E. Max 1/C No. 750 kcmil (or smaller) copper conductor power cable with cross-linked polyethylene (XLPE) insulation and fabric jacket materials.
 - F. Max 3/C (with ground) No. 4/0 AWG (or smaller) copper or aluminum conductor SER cable with XLPE or PVC insulation and jacket.
 - G. Max 4/C No. 18 AWG (or smaller) copper conductor thermostat cable with polyvinyl chloride (PVC) insulation and jacket materials.
 - H. Max four pair No. 22 AWG (or smaller) copper conductor Category 5 or Category 6 data cable with PVC insulation and jacket materials.
 - I. Max 3/C (with ground) No. 10 AWG (or smaller) nonmetallic sheathed (Romex) cable with PVC insulation and jacket materials.
 - J. Max twelve core No. 24 AWG shielded coaxial cable with high density polyethylene foam insulation and fluorinated ethylene (FE) or PVC jacket.
 - K. Max 62.5/125 micron fiber optic cable with having a min Riser rating.
 - L. Max 7/C No. 12 AWG (or smaller) copper conductor control cable with PVC insulation and jacket materials.

System No. W-L-4080 *continued*

4. **Firestop System** – The firestop system shall consist of the following:
- A. **Fill, Void or Cavity Material* – Putty** – Nom 1/8 in. (3 mm) thick by 4 in. (102 mm) putty pads forming a band of putty installed around cable bundle at mid-depth of wall.
3M COMPANY
3M FIRE PROTECTION PRODUCTS – MPP+ Moldable Putty Pads
 - B. **Fill, Void or Cavity Material* – Pillows** – Pillows installed within annular space with long dimension parallel to plane of wall. Pillow tightly-packed to fill opening between the penetrants and the periphery of the opening. The pillows may be cut to decrease their width and repaired with min 0.002 in. (0.05mm) thick polyester tape with acrylic adhesive. The tape must overlap onto the existing pillow a min of 1/2 in. (13 mm).
3M COMPANY
3M FIRE PROTECTION PRODUCTS – Fire Barrier Pillows or Fire Barrier Self-Locking Pillows
 - C. **Fill, Void or Cavity Material* – Putty** – Nom 1 in. (25 mm) rope of putty applied around periphery of cable bundle/cable rack to fill any gaps or voids, at both sides of wall. In addition, nom 1 in. (25 mm) thickness of putty installed to the maximum extent possible to fill any voids between and around pillows and cables on both sides of wall.
3M COMPANY
3M FIRE PROTECTION PRODUCTS – MP+ Moldable Putty
 - D. **Steel Cover Plate** – Each plate consists of nom 0.034 in. (1 mm, 22 gauge) thick steel sheet. Plate cut to an overall rectangular size such that it overlaps the wall around the periphery of the opening by min 2 in. (51 mm). Inside dimensions of plate are cut to fit the contour of the penetrants within the opening with a max clearance between penetrant and plate of 1 in. (25 mm). Two halves of plate are installed over the penetrant and opening and secured to wall framing with No. 12 by 2 in. (51 mm) long S type steel screws and min 3/4 in. (19 mm) diam washers with one fastener at each corner and butt joint and intermediate fasteners spaced max 7 in. (178 mm) OC around periphery of sheet. Additional 2 in. (51 mm) wide strips of steel installed over seam of steel cover plate and secured to steel cover plate by means of nom 1/8 in. (3 mm) diam by 1/2 in. (13 mm) long steel sheet metal screws spaced a max 3 in. (76 mm) OC. Sheet applied to both sides of wall.

*Bearing the UL Classification Mark

Reprinted from the Online Certifications Directory with permission from UL
© 2012 UL LLC



Through Penetrations

Cable Trays

4000 Series

Gypsum

WL

System No. W-L-4082

August 01, 2013

ANSI/UL1479 (ASTM E814)

F Ratings – 2 Hr
T Rating – 1/2 Hr
L Rating at Ambient - Less than 1 CFM/sq ft
L Rating at 400 F - Less than 1 CFM/sq ft

CAN/ULC S115

F Ratings – 2 Hr
FT Rating – 1/2 Hr
FH Ratings – 2 Hr
FTH Rating – 1/2 Hr
L Rating at Ambient - Less than 1 CFM/sq ft
L Rating at 400 F - Less than 1 CFM/sq ft

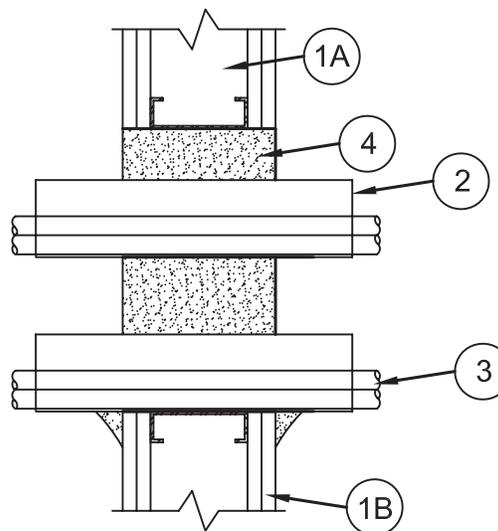
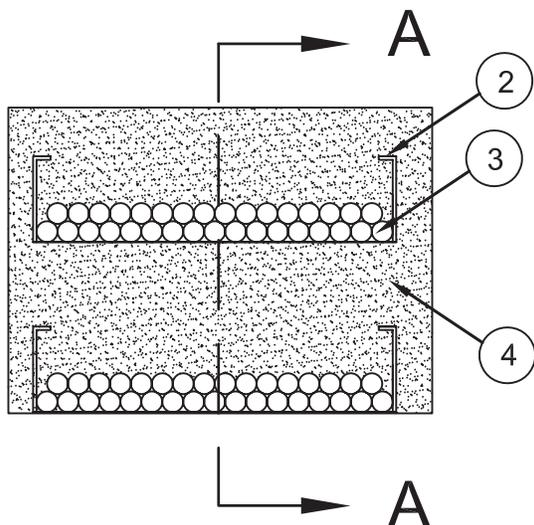

SECTION A-A

1. **Wall Assembly** – The 2 hr fire-rated gypsum board/stud wall assembly shall be constructed of the materials and in the manner described in the individual U400, V400 or W400 Series Wall or Partition Designs in the UL Fire Resistance Directory and shall include the following construction features:
 - A. **Studs** – Wall framing shall consist of min 3-1/2 in. (89 mm) wide steel studs spaced max 24 in. (610 mm) OC. Opening is to be completely framed with additional studs.
 - B. **Gypsum Board*** – Min two layers of 5/8 in. gypsum board attached to studs with fasteners, as specified in the individual U400, V400 or W400 Series design. The area of the opening shall be max 512 in.2 (3303 cm²) with a max dimension of 32 in. (813 mm).
2. **Cable Tray*** – Max two 24 in. (610 mm) wide by max 6 in. (151 mm) deep open-ladder cable tray with channel-shaped side rails formed of 0.065 in. (1.651 mm) to 0.10 in. (2.54 mm) thick aluminum or min 0.060 in. (1.65 mm) thick galv steel. The annular space between the cable trays shall be min 2 in. (51 mm). The annular space between the cable tray and the periphery of the opening shall be min 0 in. (point contact) to max 2 in. (51 mm). Cable tray to be rigidly supported on both sides of wall assembly.
3. **Cables** – Aggregate cross-sectional area of cables in cable tray to be max 45 percent of the cross-sectional area of the cable tray based on a max 5 in. (127 mm) cable loading depth within the cable tray. Any combination of the following types and sizes of copper conductor or fiber optic cables may be used:
 - A. Max 200 pair No. 22 AWG (or smaller) copper conductor with polyvinyl chloride (PVC) insulation and jacketing material.
 - B. Max 1/C No. 750 kcmil (or smaller) copper conductor cable with cross-linked polyethylene (XLPE) jacket.
 - C. Max 7/C No. 12 AWG (or smaller) copper conductor power and control cables with XLPE or PVC insulation with XLPE or PVC jacket.
 - D. Max 3/C No. 4/0 AWG (or smaller) copper or aluminum conductor SER cables with PVC or XLPE insulation and jacket.
 - E. Max 3/C No. 2/0 AWG (or smaller) copper conductor PVC jacketed aluminum clad or steel clad TECK 90 cable.
 - F. Max 110/125 fiber optic (F.O.) cable with PVC insulation and jacket.
 - G. Max 3/C with ground No. 8 AWG (or smaller) copper conductor NM cable with PVC insulation and jacket.
 - H. RG/U coaxial cable with fluorinated ethylene (FE) or PVC insulation and jacket.
 - I. Max 4 pair No. 24 AWG (or smaller) copper conductor data cable with Hylar jacket and insulation.
 - J. Max three conductor No. 12 AWG (or smaller) MC (BX) copper cable with polyvinyl chloride insulation and jacket materials.
 - K. **Through Penetrating Product*** – Any cables, **Armored Cable+** or **Metal Clad Cable+** currently Classified under the Through Penetrating Product category. See **Through Penetrating Product** (XHLY) category in the Fire Resistance Directory for names of manufacturers.
4. **Fill, Void or Cavity Material*** – **Foam** – Min 6 in. (152 mm) thickness of fill material applied within the annulus, flush with both surfaces of wall. Foam to be injected into the interstices between all cables. An additional 1/2 in. (13 mm) bead of foam shall be applied at the point contact locations.

3M COMPANY – Fire Barrier Rated Foam, FIP 1-Step

*Bearing the UL Classification Mark

Reprinted from the Online Certifications Directory with permission from UL
© 2013 UL LLC



System No. W-L-4084

June 26, 2014

ANSI/UL1479 (ASTM E814)
 F Ratings – 1 and 2 Hr (See Item 1)
 T Ratings – 0 and 1/2 Hr (See Item 1)

CAN/ULC S115
 F Ratings – 1 and 2 Hr (See Item 1)
 FT Ratings – 0 and 1/2 Hr (See Item 1)
 FH Ratings – 1 and 2 Hr (See Item 1)
 FTH Ratings – 0 and 1/2 Hr (See Item 1)

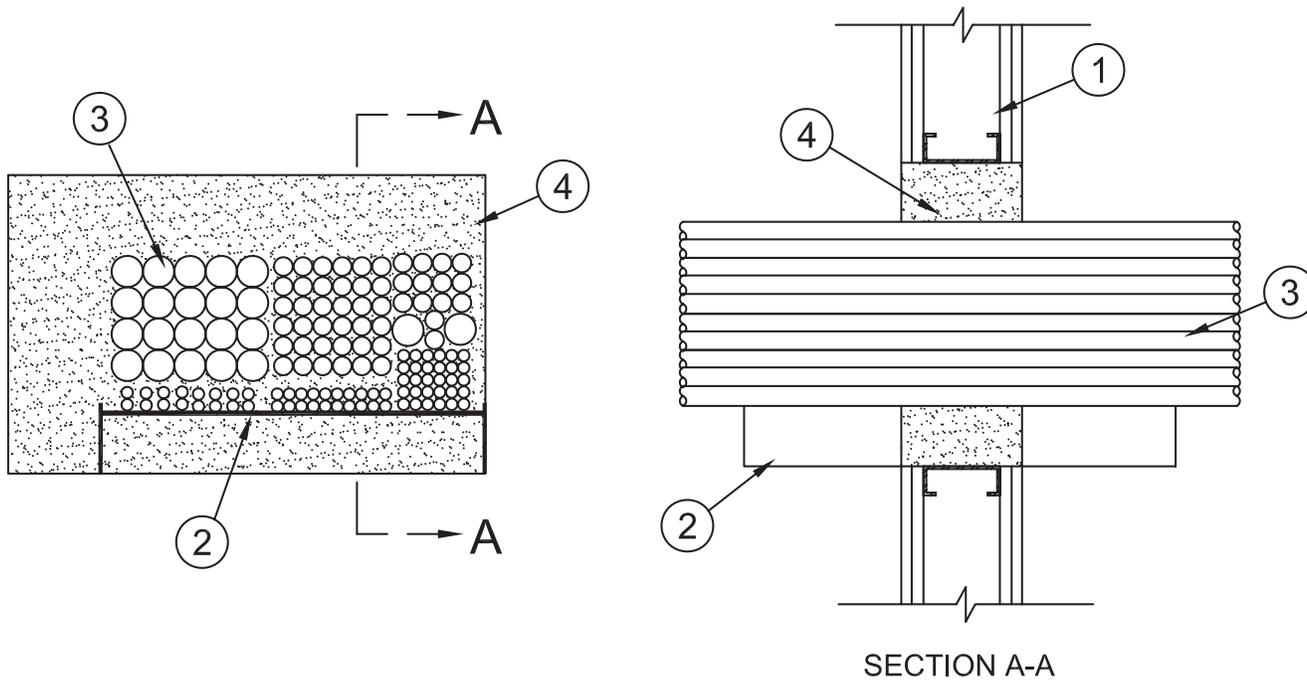

1. **Wall Assembly** – The 1 or 2 hr fire-rated gypsum board/stud wall assembly shall be constructed of the materials and in the manner specified in the individual U300, U400, V400 or W400 Series Wall and Partition Designs in the UL Fire Resistance Directory and shall include the following construction features:

- A. **Studs** – Wall framing may consist of either wood studs or steel channel studs. Wood studs to consist of nom 2 by 4 in. (51 by 102 mm) lumber spaced max 16 in. (406 mm) OC. Steel studs to be min 3-1/2 in. (89 mm) wide and spaced max 24 in. (610 mm) OC. Additional framing members to be installed in stud cavity containing cable tray to form a rectangular box around the opening.
- B. **Gypsum Board*** – One or two layers of nom 5/8 in. (16 mm) thick gypsum board, as specified in the individual Wall and Partition Design. Max area of opening is 560 sq in. (0.36 m²) with a max dimension of 28 in. (711 mm).

The hourly F and FH Ratings of the firestop system are equal to the hourly fire rating of the wall assembly in which it is installed. The hourly T, FT and FTH Ratings are 0 and 1/2 hr for 1 and 2 hr rated assemblies, respectively.

2. **Cable Rack** – Max 20 in. (508mm) wide by 2 in. (51 mm) deep steel cable rack formed from min 1/4 in. (6 mm) thick steel with min 1 in. (25 mm) wide rungs spaced max 9 in. (229 mm) OC. When installed in a U300 Series (wood stud) wall assembly, the annular space between the cable rack and the bottom of the opening shall be min 1 in. (25 mm). When installed in a U400, V400 or W400 Series (steel stud) wall assembly, the annular space between the cable rack and the bottom of the opening shall be min 0 in. (point contact) to max 4 in. (102 mm). Side rails of cable rack to be min 0 in. (point contact) to max 4 in. (102 mm) from side edges of wall opening. Cable rack to be rigidly supported on both sides of wall assembly.

2A. **Cable Tray** – (Not Shown) - As an alternate to the steel cable rack (Item 2), one of the following types of cable tray may be used:

- A. Max 24 in. (610 mm) wide by max 4 in. (102 mm) deep open ladder cable tray with channel-shaped side rails formed of min 0.058 in. thick (1.5 mm) galv steel with nom 1 in. (25 mm) diam rung spaced 9 in. (229 mm) OC.
- B. Max 24 in. (610 mm) wide by max 4 in. (102 mm) deep open ladder cable tray with channel-shaped side rails formed of min 0.060 in. thick (1.5 mm) aluminum with nom 1 in. (25 mm) diam rung spaced 9 in. (229 mm) OC.
- C. Max 8-3/4 in. (222 mm) wide by max 2-1/2 in. (64 mm) deep welded wire basket cable tray formed from min 0.198 in. (5 mm) thick steel and having a max 2 by 4 in. (51 by 102 mm) grid.

The annular space between the cable tray and the bottom of the opening shall be min 0 in. (point contact) to max 4 in. (102 mm). Side rails of cable tray to be min 0 in. (point contact) to max 4 in. (102 mm) from side edges of wall opening. Cable tray to be rigidly supported on both sides of wall assembly.

3. **Cables** – When cable rack (Item 2) is used, aggregate cross-sectional area of cables in opening to be max 40 percent of the cross-sectional area of the opening based on a max 15 in. (381 mm) deep cable loading depth on the cable rack. When cable tray (Item 2A) is used, the aggregate cross-sectional area of cables in cable tray not to exceed 40 percent of the cross-sectional area of the cable tray based on a max 3 in. (76 mm) cable loading depth in the cable tray. Any combination of the following types and sizes of cables may be used:

- A. Max 300 pair No. 24 AWG (or smaller) copper conductor telecommunication cable with PVC insulation and jacket materials.
- B. Max 1/C No. 3/0 AWG copper conductor cable with PVC insulation and jacket materials.
- C. Max three copper conductors (with ground) No. 12 AWG steel Armored Cable+.
- D. Max three copper conductor (with ground) No. 2 AWG Metal Clad Cable+.

Through Penetrations
Cable Trays
4000 Series
Gypsum
WL

System No. W-L-4084 *continued*

- E. Max 1/C No. 750 kcmil (or smaller) copper conductor power cable with cross-linked polyethylene (XLPE) insulation and fabric jacket materials.
 - F. Max 3/C (with ground) No. 4/0 AWG (or smaller) copper or aluminum conductor SER cable with XLPE or PVC insulation and jacket.
 - G. Max 4/C No. 18 AWG (or smaller) copper conductor thermostat cable with polyvinyl chloride (PVC) insulation and jacket materials.
 - H. Max four pair No. 22 AWG (or smaller) copper conductor Category 5 or Category 6 data cable with PVC insulation and jacket materials.
 - I. Max 3/C (with ground) No. 10 AWG (or smaller) nonmetallic sheathed (Romex) cable with PVC insulation and jacket materials.
 - J. Max twelve core No. 24 AWG shielded coaxial cable with high density polyethylene foam insulation and fluorinated ethylene (FE) or PVC jacket.
 - K. Max 62.5/125 micron fiber optic cable with having a min Riser rating
 - L. Max 7/C No. 12 AWG (or smaller) copper conductor control cable with PVC insulation and jacket materials.
4. **Fill, Void or Cavity Material* – Foam** – Min 4-3/4 in. (121 mm) or min 6 in. (152 mm) thickness of fill material for 1 and 2 hr rated walls ,respectively, applied within the annulus, flush with both surfaces of wall. Foam to be injected into the interstices between all cables. An additional 1/2 in. (13 mm) bead of foam shall be applied at the point contact locations.

3M COMPANY

3M FIRE PROTECTION PRODUCTS – Fire Barrier Rated Foam, FIP 1-Step

*Bearing the UL Classification Mark

+Bearing the UL Listing Mark

Reprinted from the Online Certifications Directory with permission from UL
© 2014 UL LLC



Through Penetrations

Cable Trays

4000 Series

Gypsum

W-L



System No. W-L-4088
XHEZ - Through-penetration Firestop Systems
XHEZ7 - Through-penetration Firestop Systems Certified for Canada

February 16, 2016

| ANSI/UL1479 (ASTM E814) | CAN/ULC S115 |
|-------------------------------------|--------------------------------------|
| F Ratings — 1 and 2 Hr (See Item 1) | F Ratings — 1 and 2 Hr (See Item 1) |
| T Rating — 0 Hr | FT Rating — 0 Hr |
| | FH Ratings — 1 and 2 Hr (See Item 1) |
| | FTH Rating — 0 Hr |

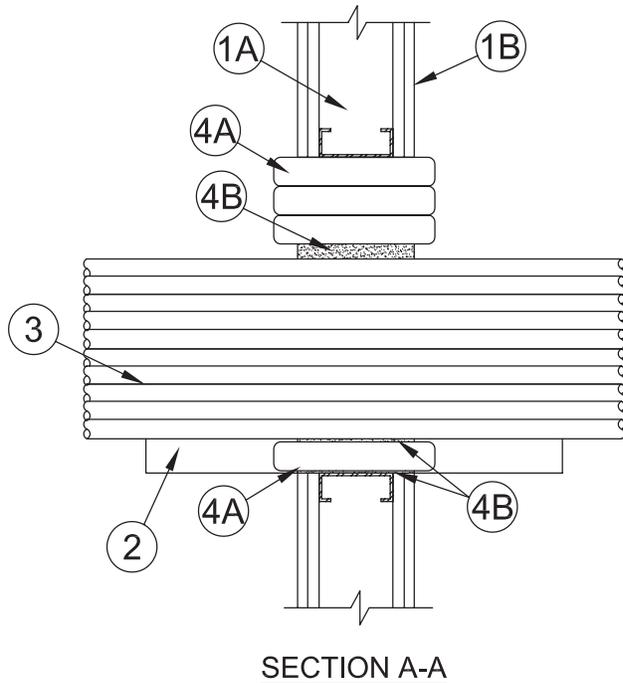
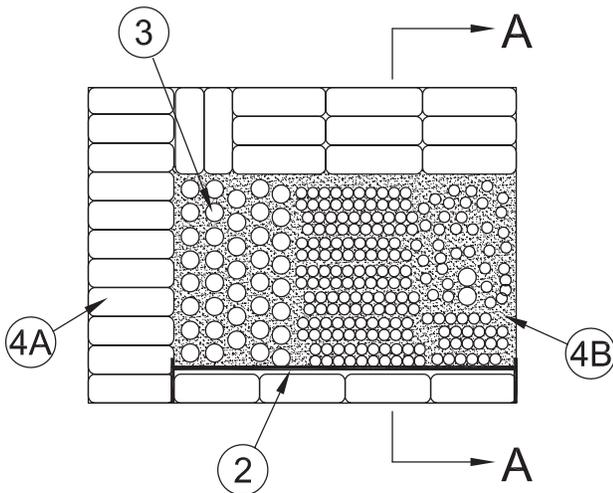

1. **Wall Assembly** – The 1 or 2 hr fire-rated gypsum board/stud wall assembly shall be constructed of the materials and in the manner specified in the individual U300, U400, V400 or W400 Series Wall and Partition Designs in the UL Fire Resistance Directory and shall include the following construction features:
 - A. **Studs** – Wall framing to consist of steel channel studs. Steel studs to be min 3-1/2 in. (89 mm) wide and spaced max 24 in. (610 mm) OC. Additional framing members to be installed in stud cavity to form a rectangular box around the opening.
 - B. **Gypsum Board*** – One or two layers of nom 5/8 in. (16 mm) thick gypsum board, as specified in the individual Wall and Partition Design. Max area of opening is 540 sq in. (0.35 m²) with a max dimension of 30 in. (762 mm).

The hourly F and FH Ratings of the firestop system are equal to the hourly fire rating of the wall assembly in which it is installed.
2. **Cable Rack** – Max 20 in. (508 mm) wide by 2 in. (51 mm) deep steel cable rack formed from min 1/4 in. (6 mm) thick steel with min 1 in. (25 mm) wide rungs spaced max 9 in. (229 mm) OC. The annular space between the cable rack and the bottom of the opening shall be min 0 in. (point contact) to max 5 in. (127 mm). Side rails of cable rack to be min 0 in. (point contact) to max 5 in. (127 mm) from side edges of wall opening. Cable rack to be rigidly supported on both sides of wall assembly.

*Indicates such products shall bear the UL or cUL Certification Mark for jurisdictions employing the UL or cUL Certification (such as Canada), respectively.

Reprinted from the Online Certifications Directory with permission from UL©

Through Penetrations
 Cable Trays
 4000 Series
 Gypsum
WL

2A. Cable Tray – (Not Shown) — As an alternate to the steel cable rack (Item 2), one of the following types of cable tray may be used:

- A. Max 24 in. (610 mm) wide by max 4 in. (102 mm) deep open ladder cable tray with channel-shaped side rails formed of min 0.058 in. thick (1.5 mm) galv steel with nom 1 in. (25 mm) diam rung spaced 9 in. (229 mm) OC.
- B. Max 24 in. (610 mm) wide by max 4 in. (102 mm) deep open ladder cable tray with channel-shaped side rails formed of min 0.060 in. thick (1.5 mm) aluminum with nom 1 in. (25 mm) diam rung spaced 9 in. (229 mm) OC.
- C. Max 8-3/4 in. (222 mm) wide by max 2-1/2 in. (64 mm) deep welded wire basket cable tray formed from min 0.198 in. (5 mm) thick steel and having a max 2 by 4 in. (51 by 102 mm) grid.

The annular space between the cable tray and the bottom of the opening shall be min 0 in. (point contact) to max 4 in. (102 mm). Side rails of cable tray to be min 0 in. (point contact) to max 4 in. (102 mm) from side edges of wall opening. Cable tray to be rigidly supported on both sides of wall assembly.

3. Cables – When cable rack (Item 2) is used, aggregate cross-sectional area of cables in opening to be max 40 percent of the cross-sectional area of the opening based on a max 15 in. (381 mm) deep cable loading depth on the cable rack. When cable tray (Item 2A) is used, the aggregate cross-sectional area of cables in cable tray not to exceed 40 percent of the cross-sectional area of the cable tray based on a max 3 in. (76 mm) cable loading depth in the cable tray. Any combination of the following types and sizes of cables may be used:

- A. Max 300 pair No. 24 AWG (or smaller) copper conductor telecommunication cable with PVC insulation and jacket materials.
- B. Max 1/C No. 3/0 AWG copper conductor cable with PVC insulation and jacket materials.
- C. Max three copper conductors (with ground) No. 12 AWG steel Armored Cable+.
- D. Max three copper conductor (with ground) No. 2 AWG Metal Clad Cable+.
- E. Max 1/C No. 750 kcmil (or smaller) copper conductor power cable with cross-linked polyethylene (XLPE) insulation and fabric jacket materials.
- F. Max 3/C (with ground) No. 4/0 AWG (or smaller) copper or aluminum conductor SER cable with XLPE or PVC insulation and jacket.
- G. Max 4/C No. 18 AWG (or smaller) copper conductor thermostat cable with polyvinyl chloride (PVC) insulation and jacket materials.
- H. Max four pair No. 22 AWG (or smaller) copper conductor Category 5 or Category 6 data cable with PVC insulation and jacket materials.
- I. Max 3/C (with ground) No. 10 AWG (or smaller) nonmetallic sheathed (Romex) cable with PVC insulation and jacket materials.
- J. Max twelve core No. 24 AWG shielded coaxial cable with high density polyethylene foam insulation and fluorinated ethylene (FE) or PVC jacket.
- K. Max 62.5/125 micron fiber optic cable with having a min Riser rating.
- L. Max 7/C No. 12 AWG (or smaller) copper conductor control cable with PVC insulation and jacket materials.

4. Firestop System – The firestop system shall consist of the following:

- A. **Fill, Void or Cavity Material* – Pillows** – Max 9 in. (229 mm) long by 6 in. (152 mm) wide by 2 and 3 in. (51 and 76 mm) thick plastic covered pillows tightly-packed to fill annular space between penetrants and periphery of opening. Pillows installed with 9 in. (229 mm) dimension projecting through wall and centered within the opening. The pillows may be cut to decrease their width and repaired with min 0.002 in. (0.05 mm) thick polyester tape with acrylic adhesive. The tape must overlap onto the existing pillow a min of 1/2 in. (13 mm).

3M COMPANY 3M FIRE PROTECTION PRODUCTS – Fire Barrier Pillows or Fire Barrier Self-Locking Pillows

- B. **Fill, Void or Cavity Material* – Foam** – Foam to be injected into the interstices between and around the periphery of all cables. After installation of pillows (Item 4A), all voids within the opening shall be filled with a min 1 in. (25 mm) thickness of foam. In addition, a 1/2 in. (13 mm) bead of foam shall be applied at all point contact locations at both sides of wall.

3M COMPANY 3M FIRE PROTECTION PRODUCTS – Fire Barrier Rated Foam, FIP 1-Step

Through Penetrations
Cable Trays
4000 Series
Gypsum
WL

* Indicates such products shall bear the UL or cUL Certification Mark for jurisdictions employing the UL or cUL Certification (such as Canada), respectively.



System No. W-L-4090

August 01, 2016

| ANSI/UL1479 (ASTM E814) | CAN/ULC S115 |
|--|---|
| F Ratings — 1 and 2 Hr (See Item 1) | F Ratings — 1 and 2 Hr (See Item 1) |
| T Rating — 0 Hr | FT Rating — 0 Hr |
| L Rating At Ambient — Less Than 1 CFM/sq ft (See Item 4) | FH Ratings — 1 and 2 Hr (See Item 1) |
| L Rating At 400 F — Less Than 1 CFM/sq ft (See Item 4) | FTH Rating — 0 Hr |
| | L Rating At Ambient — Less Than 5.1 L/s/m ² (See Item 4) |
| | L Rating At 400 F — Less Than 5.1 L/s/m ² (See Item 4) |

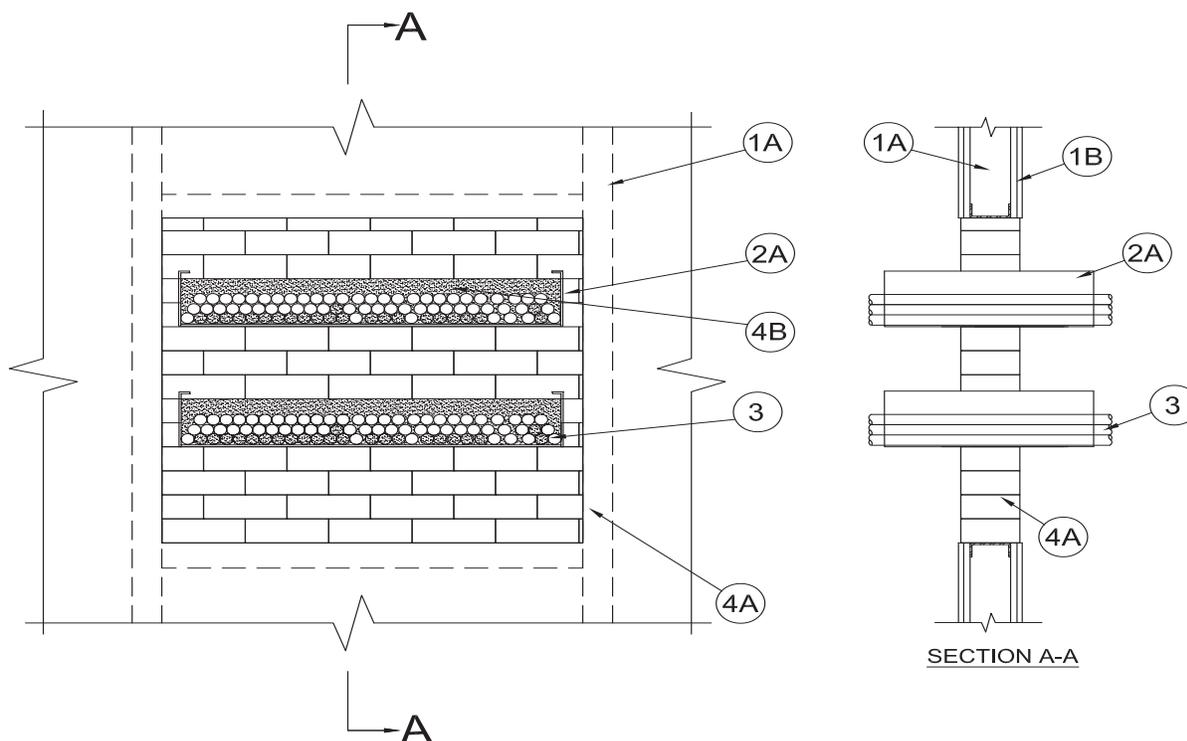

- Wall Assembly** — The 1 or 2 hr fire-rated gypsum board/stud wall assembly shall be constructed of the materials and in the manner described in the individual U300, U400, V400 or W400 Series Wall or Partition Designs in the UL Fire Resistance Directory and shall include the following construction features:
 - Studs** — Wall framing to consist of wood studs or channel shaped steel studs. Wood studs to consist of nom 2 by 4 in. (51 by 102 mm) lumber spaced 16 in. (406 mm) OC. Steel studs to be min 3-1/2 in. (89 mm) wide and spaced max 24 in. (610 mm) OC. Additional studs shall be used to completely frame the opening.
 - Gypsum Board*** — Min two layers of 5/8 in. (16 mm) gypsum board attached to studs with fasteners, as specified in the individual Wall or Partition Series design. Max area of opening is 1080 in² (6968 cm²) with a max dimension of 36 in. (914 mm).

The hourly F and FH Ratings of the firestop system are equal to the hourly fire rating of the wall assembly in which it is installed.
- Cable Trays*** — Max two 24 in. (610 mm) wide by max 6 in. (151 mm) deep open-ladder cable tray with channel-shaped side rails formed of 0.065 in. (1.651 mm) to 0.10 in. (2.54 mm) thick aluminum or min 0.060 in. (1.65 mm) thick galv steel. The annular space between the cable trays shall be min 2 in. (51 mm). The annular space between the cable tray and the periphery of the opening shall be min 2 in. (51 mm). Cable trays to be rigidly supported on both sides of wall assembly.
- Cables** — Aggregate cross-sectional area of cables in cable tray to be max 45 percent of the cross-sectional area of the cable tray based on a max 5 in. (127 mm) cable loading depth within the cable tray. Any combination of the following types and sizes of copper conductor or fiber optic cables may be used:
 - Max 200 pair No. 22 AWG (or smaller) copper conductor with polyvinyl chloride (PVC) insulation and jacketing material.
 - Max 1/C No. 750 kcmil (or smaller) copper conductor cable with cross-linked polyethylene (XLPE) jacket.
 - Max 7/C No. 12 AWG (or smaller) copper conductor power and control cables with XLPE or PVC insulation with XLPE or PVC jacket.
 - Max 3/C No. 4/0 AWG (or smaller) copper or aluminum conductor SER cables with PVC or XLPE insulation and jacket.
 - Max 3/C No. 2/0 AWG (or smaller) copper conductor PVC jacketed aluminum clad or steel clad TECK 90 cable.
 - Max 110/125 fiber optic (F.O.) cable with PVC insulation and jacket.
 - Max 3/C with ground No. 8 AWG (or smaller) copper conductor NM cable with PVC insulation and jacket.
 - RG/U coaxial cable with fluorinated ethylene (FE) or PVC insulation and jacket.
 - Max 4 pair No. 24 AWG (or smaller) copper conductor data cable with Hylar jacket and insulation.
 - Max three conductor No. 12 AWG (or smaller) MC (BX) copper cable with polyvinyl chloride insulation and jacket materials.
- Through Penetrating Product*** — Any cables, **Armored Cable+** or **Metal Clad Cable+** currently Classified under the **Through Penetrating Product** category. See **Through Penetrating Product** (XHLY) category in the Fire Resistance Directory for names of manufacturers.

Through Penetrations
Cable Trays
4000 Series
Gypsum
WL

System No. W-L-4090 *continued*

4. **Firestop System** — The firestop system shall consist of the following:

A. **Fill, Void or Cavity Material*** — Blocks installed with 5 in. (127 mm) dimension projecting through opening and centered in wall. Blocks to be firmly packed to fill the opening area between and around the penetrants. Blocks can be cut to fit around penetrants and within smaller annular spaces.

3M COMPANY 3M FIRE PROTECTION PRODUCTS — 3M™ Fire Barrier Block B258, 3M™ Fire Barrier Plank PK39

B. **Fill, Void or Cavity Material*** — **Foam** — Fill material to be forced between blocks and periphery of opening to the max extent possible. Fill material to be injected in-between blocks and penetrants to the full depth of the blocks, as well as in any visible voids/openings between blocks (Item 4A). In addition, foam shall be injected to the maximum extent possible within the interstices between all cables in the cable trays.

3M COMPANY 3M FIRE PROTECTION PRODUCTS — Fire Barrier Rated Foam, FIP 1-Step

B1. **Fill, Void or Cavity Material*** — **Sealant or Caulk** — (Not Shown) — As an alternate to Item 4B, sealant to be forced between blocks and periphery of opening to the max extent possible. In addition, sealant shall be forced to the maximum extent possible within the interstices between all cables in the cable trays. Sealant to be applied into all voids within the annular space between blocks to the full depth of the blocks (Item 4A).

3M COMPANY 3M FIRE PROTECTION PRODUCTS — CP 25WB+ Caulk or FB-3000 WT Sealant

The L Ratings of the firestop system apply only when Item 4B Foam is used.

* Indicates such products shall bear the UL or cUL Certification Mark for jurisdictions employing the UL or cUL Certification (such as Canada), respectively.



Through Penetrations

Cable Trays

4000 Series

Gypsum

WL

Insulated Pipes

CAJ

Concrete floors with a minimum thickness less than or equal to 5 inches (127 mm)

Concrete or masonry walls with a minimum thickness less than or equal to 8 inches (203 mm)

CBJ

Concrete floors with a minimum thickness greater than 5 inches (127 mm)

Concrete or masonry walls with a minimum thickness less than or equal to 8 inches (203 mm)

FA

Concrete floors/Steel decks

Concrete or masonry walls with a minimum thickness less than or equal to 8 inches (203 mm)

FC

Floor assemblies

Framed floors

FE

Truss floor assemblies

WJ

Floor assemblies

Concrete or masonry walls with a minimum thickness less than or equal to 8 inches (203 mm)

WL

Wall assemblies

Framed walls

Insulated Pipes • Concrete

| 3M UL Systems | "F" Rating | 3M Product | Through Penetrant Details |
|---------------|------------|--|---|
| C-AJ-5001 | 1.5, 2, 3 | 3M™ Fire Barrier Sealant CP 25WB+ 3M™ Fire Barrier Water Tight Sealant 3000 WT | Fiberglass insulated metallic pipe penetrating a min. 2.5 in. thick concrete floor or wall. Steel sleeve optional. |
| C-AJ-5002 | 2, 3 | 3M™ Fire Barrier Sealant CP 25WB+ 3M™ Fire Barrier Wrap Strips FS-195+ 3M™ Fire Barrier Water Tight Sealant 3000 WT | Fiberglass insulated metallic pipe penetrating a min. 2.5 in. thick concrete floor or wall. Steel sleeve optional. |
| C-AJ-5003 | 2 | 3M™ Fire Barrier Sealant CP 25WB+ 3M™ Fire Barrier Sealant IC 15WB+ 3M™ Fire Barrier Wrap Strips FS-195+ 3M™ Fire Barrier RC-1 Restricting Collar 3M™ Fire Barrier Water Tight Sealant 3000 WT | Fiberglass insulated metallic pipe penetrating a min. 2.5 in. thick concrete floor or wall. |
| C-AJ-5005 | 2 | 3M™ Fire Barrier Moldable Putty Stix MP+ | Fiberglass insulated copper pipe penetrating a min. 4.5 in. thick concrete floor or wall. Utilizing MP+ Moldable Putty. |
| C-AJ-5009 | 2 | 3M™ Fire Barrier Silicone Sealant 2000+ 3M™ Fire Barrier Water Tight Sealant 1000 NS 3M™ Fire Barrier Water Tight Sealant 1003 SL | Max. four max. 1.5 in. copper tubes with fiberglass insulation penetrating the same max. 12 in. wide opening in a concrete floor or wall. |
| C-AJ-5017 | 2, 3 | 3M™ Fire Barrier Sealant CP 25WB+ 3M™ Fire Barrier Wrap Strips FS-195+ 3M™ Fire Barrier Water Tight Sealant 3000 WT | One or more AB/PVC insulated copper pipes penetrating a min. 4.5 in. thick concrete floor or wall. |
| C-AJ-5022 | 2 | 3M™ Fire Barrier Sealant CP 25WB+ 3M™ Fire Barrier Sealant IC 15WB+ 3M™ Fire Barrier Wrap Strips FS-195+ 3M™ Fire Barrier RC-1 Restricting Collar | Fiberglass or AB/PVC insulated PVC pipe penetrating a concrete floor or wall. |
| C-AJ-5024 | 2, 3 | 3M™ Fire Barrier Sealant CP 25WB+ 3M™ Fire Barrier Wrap Strips FS-195+ 3M™ Fire Barrier Sealant IC 15WB+ 3M™ Fire Barrier Water Tight Sealant 3000 WT | Fiberglass insulated metallic pipe penetrating a min. 4.5 in. thick concrete floor or wall. Steel sleeve optional. |
| C-AJ-5030 | 1, 2 | 3M™ Fire Barrier Sealant CP 25WB+ 3M™ Fire Barrier Sealant IC 15WB+ 3M™ Fire Barrier Composite Sheet CS-195+ 3M™ Fire Barrier Wrap Strips FS-195+ 3M™ Fire Barrier Moldable Putty Stix MP+ 3M™ Expanrol™ Flexible Intumescent Strip E-FIS 3M™ Fire Barrier Water Tight Sealant 3000 WT 3M™ Fire Barrier Wrap Ultra GS | Fiberglass or AB/PVC insulated metallic pipe penetrating a min. 2.5 in. thick concrete floor or wall through a max. 36 square foot opening. Utilizing CS 195+ Composite Sheet and FS 195+ Wrap Strip. |
| C-AJ-5041 | 2 | 3M™ Fire Barrier Silicone Sealant 2000+ 3M™ Fire Barrier Water Tight Sealant 1000 NS 3M™ Fire Barrier Water Tight Sealant 1003 SL | Fiberglass or mineral wool insulated metallic pipe penetrating a min. 4.5 in. thick concrete floor or wall. |
| C-AJ-5060 | 2, 3 | 3M™ Fire Barrier Sealant CP 25WB+ 3M™ Fire Barrier Sealant IC 15WB+ 3M™ Fire Barrier Water Tight Sealant 3000 WT | Cellular glass insulated pipe with metallic jacketing penetrating a min. 2.5 in. thick concrete floor or wall. Steel sleeve optional. |
| C-AJ-5074 | 2, 3 | 3M™ Fire Barrier Silicone Sealant 2000+ | Fiberglass insulated max. 6 in. steel pipe penetrating a concrete floor or wall. |
| C-AJ-5080 | 2 | 3M™ Fire Barrier Sealant CP 25WB+ 3M™ Fire Barrier Wrap Strips FS-195+ 3M™ Fire Barrier Water Tight Sealant 3000 WT | AB/PVC insulated metallic pipe penetrating a min. 2.5 in. thick concrete floor or wall. |
| C-AJ-5119 | 2 | 3M™ Fire Barrier Sealant CP 25WB+ 3M™ Fire Barrier Water Tight Sealant 3000 WT | AB/PVC insulated metallic pipe penetrating a min. 4.5 in. thick concrete floor or wall. Steel sleeve optional. |
| C-AJ-5125 | 2, 3 | 3M™ Fire Barrier Water Tight Sealant 1000 NS 3M™ Fire Barrier Water Tight Sealant 1003 SL 3M™ Fire Barrier Water Tight Sealant 3000 WT | Fiberglass insulated steel or copper pipe penetrating a concrete floor or wall. Steel or PVC sleeve optional. |
| C-AJ-5156 | 1, 2 | 3M™ Fire Barrier Sealant CP 25WB+ 3M™ Fire Barrier Moldable Putty Stix MP+ 3M™ Fire Barrier Water Tight Sealant 3000 WT | AB/PVC insulated metallic pipe penetrating a min. 4.5 in. thick concrete floor or wall. Steel sleeve optional. |
| C-AJ-5172 | 2, 3 | 3M™ Fire Barrier Sealant CP 25WB+ 3M™ Fire Barrier Sealant IC 15WB+ 3M™ Fire Barrier Sealant FD 150+ | Fiberglass insulated metallic pipe penetrating a min. 4.5 in. thick concrete floor or wall. Steel sleeve optional. |
| C-AJ-5183 | 2 | 3M™ Fire Barrier Sealant CP 25WB+ 3M™ Fire Barrier Sealant IC 15WB+ 3M™ Fire Barrier Sealant FD 150+ 3M™ Fire Barrier Water Tight Sealant 3000 WT 3M™ Fire Barrier Packing Material PM4 | Fiberglass insulated metallic pipe penetrating a min. 2.5 in. thick concrete floor or wall. Steel sleeve optional. |
| C-AJ-5194 | 1.5, 2 | 3M™ Fire Barrier Sealant FD 150+ | Fiberglass insulated steel pipe penetrating a min. 2.5 in. thick concrete floor or wall. |

Insulated Pipes • Concrete

Through Penetrations • Insulated Pipes • Concrete

| 3M UL Systems | "F" Rating | 3M Product | Through Penetrant Details |
|------------------|------------|--|---|
| C-AJ-5209 | 1, 2 | 3M™ Fire Barrier Sealant CP 25WB+ 3M™ Fire Barrier Sealant IC 15WB+ 3M™ Fire Barrier Water Tight Sealant 3000 WT | Fiberglass insulated metallic pipe penetrating a min. 2.5 in. thick concrete floor or wall. Steel sleeve optional. |
| C-AJ-5210 | 1.5, 2 | 3M™ Fire Barrier Sealant CP 25WB+ 3M™ Fire Barrier Sealant IC 15WB+ 3M™ Fire Barrier Water Tight Sealant 3000 WT | Fiberglass insulated metallic pipe penetrating a min. 4.5 in. thick concrete floor or wall. Steel sleeve optional. |
| C-AJ-5211 | 2 | 3M™ Fire Barrier Sealant CP 25WB+ 3M™ Fire Barrier Sealant IC 15WB+ 3M™ Fire Barrier Water Tight Sealant 3000 WT 3M™ Fire Barrier Packing Material PM4 | AB/PVC insulated metallic pipe penetrating a min. 4.5 in. thick concrete floor or wall. Steel sleeve optional. |
| C-AJ-5292 | 2 | 3M™ Fire Barrier Pass-Through Products 3M™ Fire Barrier Water Tight Sealant 3000 WT 3M™ Fire Barrier Sealant CP 25WB+ 3M™ Fire Barrier Sealant IC 15WB+ 3M™ Fire Barrier Moldable Putty Stix MP+ | Pass-Through device system for AB/PVC insulated pipes penetrating a concrete floor or wall. |
| C-AJ-5310 | 2 | 3M™ Fire Barrier Packing Material PM4 3M™ Fire Barrier Water Tight Sealant 3000 WT | Max. 3 in. thick fiberglass insulated metallic pipe penetrating a concrete floor or wall. |
| C-AJ-5330 | 2 | 3M™ Fire Barrier Water Tight Sealant 3000 WT | Fiberglass insulated steel pipe penetrating a min. 4.5 in. thick concrete floor. Sleeve optional. All service or PVC jacketing optional. |
| C-AJ-5347 | 2 | 3M™ Fire Barrier Rated Foam FIP 1-Step | Fiberglass insulated metallic pipe penetrating a min. 2.5 in. thick concrete floor or wall. Utilizing Fire Barrier Rated Foam, FIP 1-Step |
| C-BJ-5002 | 4 | 3M™ Fire Barrier Sealant CP 25WB+ 3M™ Fire Barrier Water Tight Sealant 3000 WT | Single max. 4 in. metallic pipe having 1 or 2 in. thick fiberglass insulation penetrating a 4 hour rated concrete floor or wall. Utilizing packing material and sealant. |
| C-BJ-5003 | 4 | 3M™ Fire Barrier Sealant CP 25WB+ 3M™ Fire Barrier Wrap Strips FS-195+ 3M™ Fire Barrier Water Tight Sealant 3000 WT | Single max. 4 in. metallic pipe having 1 or 2 in. thick fiberglass insulation penetrating a 4 hour rated concrete floor or wall. Utilizing FS 195+ Wrap Strip, packing material and sealant. |
| F-A-5001 | 1, 2 | 3M™ Fire Barrier Sealant CP 25WB+ 3M™ Fire Barrier Wrap Strips FS-195+ 3M™ Fire Barrier Water Tight Sealant 3000 WT 3M™ Fire Barrier Sealant IC 15WB+ | 4" steel, 4" EMT, 4" copper tubing, 4" steel conduit. 1/2" to 1" glass fiber insulation, 3/4" AB/PVC insulation. Max area of opening 192 sq. in. Max length 24" and max width 8". Pipes min 1" apart. Min 1" to max 2" annular. 2 hour F Rating. Mineral wool required. Also known as FA5001. |
| F-A-5013 | 1, 2, 3 | 3M™ Fire Barrier Sealant CP 25WB+ 3M™ Fire Barrier Sealant IC 15WB+ 3M™ Fire Barrier Wrap Ultra GS 3M™ Fire Barrier Water Tight Sealant 3000 WT | 10" steel, 10" iron, 4" copper tubing, 4" copper pipe. 1" glass fiber insulation. MK-6/HY. Max diam of opening 14". Concentric installation. 1/2" annular. Mineral wool required. 3 hour F Rating. Also known as FA5013. |
| F-A-5028 | 1, 2, 3 | 3M™ Fire Barrier Cast-In Devices for Metal Pipes 3M™ Fire Barrier Water Tight Sealant 1000 NS 3M™ Fire Barrier Water Tight Sealant 1003 SL 3M™ Fire Barrier Sealant CP 25WB+ 3M™ Fire Barrier Sealant FD 150+ 3M™ Fire Barrier Sealant IC 15WB+ 3M™ Fire Barrier Moldable Putty Stix MP+ 3M™ Fire Barrier Water Tight Sealant 3000 WT | 2" steel, 2" iron, 2" copper tubing, 2" copper pipe. 1-1/2" glass fiber insulation, max 1" AB/PVC insulation. Concentric or eccentric installation. Point contact to max 1" annular. Mineral wool required only when annular exceeds 1/4". 3 hour F Rating. Also known as FA5028. |
| F-A-5029 | 1, 2 | 3M™ Fire Barrier Cast-In Devices for Metal Pipes 3M™ Fire Barrier Water Tight Sealant 1000 NS 3M™ Fire Barrier Water Tight Sealant 1003 SL 3M™ Fire Barrier Water Tight Sealant 3000 WT | Max 2 in. steel, max 2 in. iron, max 2 in. copper tubing, max 2 in. copper pipe. 1/2 in. glass fiber insulation with all-service jacket. Minimum 2-1/2 in. concrete over fluted metal deck. 3MCID only. PVC jacket required for Class I W rating. Packing material required. 2 hour F rating. Class I W rating. Also known as FA5029. |
| F-A-5033 | 1, 2, 3 | 3M™ Fire Barrier Water Tight Sealant 3000 WT | 12" steel, 12" iron, 4" copper tubing or pipe. 1/2" to 2" glass fiber insulation. Additional PVC jacket required over all service jacket. Optional steel sleeve. Max opening 18". See chart for annular. 1-1/2, 2, & 3 hr. F Rating. Class I W Rating. Also known as FA5033. |
| W-J-5013 | 1, 2 | 3M™ Fire Barrier Sealant CP 25WB+ | 4" steel, copper, 1-1/2" glass fiber. Also referred as WJ5013. |
| W-J-5014 | 1, 2 | 3M™ Fire Barrier Sealant CP 25WB+ 3M™ Fire Barrier Sealant IC 15WB+ | 4" steel, copper, 3/4" AB/PVC. Also referred as WJ5014. |
| W-J-5015 | 1, 2 | 3M™ Fire Barrier Sealant CP 25WB+ 3M™ Fire Barrier Sealant IC 15WB+ | 12" steel, 6" copper, 3" cellular glass. Also referred as WJ5015. |
| W-J-5077 | 1, 2 | 3M™ Fire Barrier Sealant CP 25WB+ 3M™ Fire Barrier Sealant IC 15WB+ | 8" steel, iron, cast, 4" copper tubing or pipe, 1" fiberglass, 12" maximum diameter opening. Also referred as WJ5077. |

Insulated Pipes • Concrete

| 3M UL Systems | "F" Rating | 3M Product | Through Penetrant Details |
|---------------|------------|--|--|
| W-J-5078 | 1, 2 | 3M™ Fire Barrier Sealant CP 25WB+ 3M™ Fire Barrier Sealant IC 15WB+ | 4" steel, iron, cast, 2" copper tubing or pipe, 3/4" AB/PVC flexible foam, 7-1/2" maximum diameter opening. Also referred as WJ5078. |
| W-J-5138 | 1, 2 | 3M™ Fire Barrier Water Tight Sealant 3000 WT | Min 6 in. Concrete wall. Concrete block wall. Opening nom 2 in. larger than OD of pipe covering. Max 6 in. steel, max 6 in. iron, max 6 in. min type L copper tubing, max 6 in. copper pipe. 3 in. fiberglass insulation. Point contact to max 2 in. annular. Eccentric or concentric installation. 2 hour F & T. Caulk only system. Also known as WJ5138. |
| W-J-5146 | 1, 2 | 3M™ Fire Barrier Sealant IC 15WB+ 3M™ Fire Barrier Sealant CP 25WB+ 3M™ Fire Barrier Water Tight Sealant 3000 WT 3M™ Fire Barrier Wrap Ultra GS | Max 2 in. PVC (vented or closed), max 2 in. CPVC (vented or closed). Nominal 1 in. AB/PVC insulation. Min 6 in. concrete. Max 4 in. opening. Continuous point contact. 2 hour F & T rating. Ultra GS Wrap Strip and collar required. Also known as WJ5146. |
| W-J-5147 | 1, 2 | 3M™ Fire Barrier Sealant IC 15WB+ 3M™ Fire Barrier Sealant CP 25WB+ 3M™ Fire Barrier Water Tight Sealant 3000 WT | Max 3 in. steel, max 3 in. iron, max 2 in. copper pipe, max 2 in. copper tubing. Min 6 in. concrete. Diam of opening min 1 in. to max 1-1/2 in. larger than OD of penetrant. 1 in. polyisocyanurate insulation. Concentric or eccentric installation. 2 hour F. 1-1/2 hour T. Band clamp required on each side of wall. No mineral wool required-sealant only. Also known as WJ5147. |
| W-J-5149 | 1, 2 | 3M™ Fire Barrier Sealant CP 25WB+ 3M™ Fire Barrier Water Tight Sealant 3000 WT | Max 2 in. steel, max 2 in. iron, max 2 in. copper tubing, max 2 in. copper pipe. 1-1/2 in. glass fiber insulation with all-service jacket. Minimum 6 in. concrete wall or concrete block wall. Max diam of opening must equal OD of penetrant. Continuous point contact. 2 hour F & T rating. Also known as WJ5149. |

System No. C-AJ-5001

March 05, 2007

F Ratings – 1-1/2, 2 and 3 Hr (See Item 4)

T Ratings – 0, 1/2, 3/4 and 1 Hr (See Items 1A and 4)

L Rating At Ambient – 2 CFM per sq ft

L Rating At 400 F – less than 1 CFM per sq ft

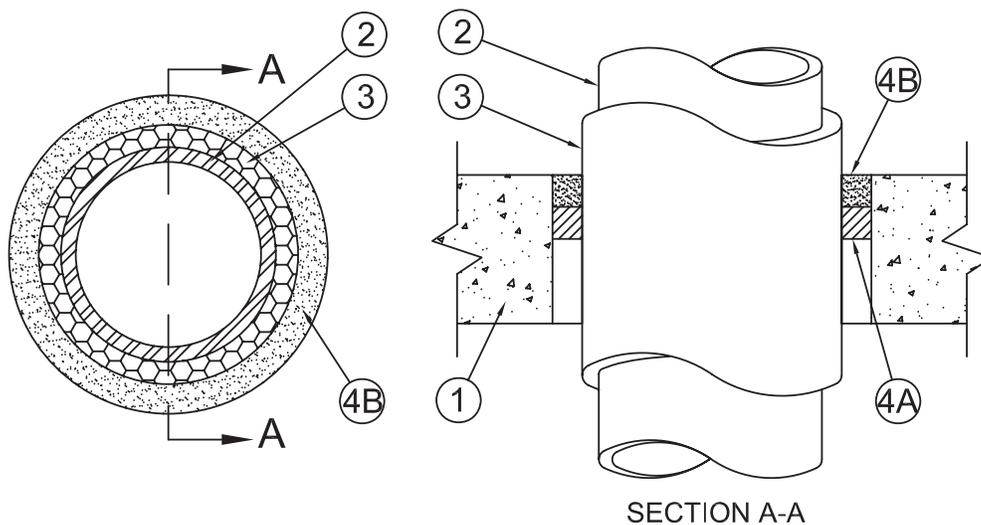

- Floor or Wall Assembly** – Min 2-1/2 in. (64 mm) thick reinforced lightweight or normal weight (100-150 pcf or 1600-2400 kg/m³) concrete. Wall may also be constructed of any UL Classified **Concrete Blocks***. Max diam of opening is 18 in. (457 mm)

See **Concrete Blocks** (CAZT) category in the Fire Resistance Directory for names of manufacturers.

- Steel Sleeve** – (Optional, not shown) – Nom 10 in. (254 mm) (or smaller) Schedule 10 (or heavier) steel sleeve cast or grouted into floor or wall assembly. Sleeve may extend a max of 2 in. (51 mm) above top of floor or beyond either surface of wall. As an alternate, nom 10 in. (254 mm) diam (or smaller) sleeve fabricated from nom 0.019 in. (0.48 mm) thick galv steel cast or grouted into floor or wall assembly flush with floor or wall surfaces. **T Rating is 0 Hr when sleeve is used.**

- Through Penetrant** – Nom 4 in. (102 mm) diam (or smaller) Type L (or heavier) copper pipe, nom 12 in. (305 mm) diam (or smaller) service weight (or heavier) cast iron soil pipe, nom 12 in. (305 mm) diam (or smaller) Class 50 (or heavier) ductile iron pressure pipe or nom 12 in. (305 mm) diam (or smaller) Schedule 10 (or heavier) steel pipe centered in the opening and rigidly supported on both sides of the floor or wall assembly.

- Pipe Covering*** – Nom 1/2 to 2 in. (13 to 51 mm) thick hollow cylindrical heavy density (min. 3.5 pcf or 56 kg/m³) glass fiber units jacketed on the outside with an all service jacket. Longitudinal joints sealed with metal fasteners or factory-applied self-sealing lap tape. Transverse joints secured with metal fasteners or with butt strip tape supplied with the product.

See **Pipe and Equipment Covering – Materials*** (BRGU) category in Building Materials Directory for names of manufacturers. Any pipe covering material meeting the above specifications and bearing the UL Classification Marking with a Flame Spread Index of 25 or less and a Smoke Developed Index of 50 or less may be used.

- Firestop System** – The details of the firestop system shall be as follows:

- Packing Material** – Min 1 in. (25 mm) thickness of firmly packed mineral wool batt insulation used as a permanent form. Packing material to be recessed from top surface of floor or sleeve or from both surfaces of wall as required to accommodate the required thickness of caulk fill material (Item B).

- Fill, Void or Cavity Material* – Caulk or Sealant** – Applied to fill the annular space flush with the top surface of the floor or sleeve or flush with both surfaces of wall. When nom pipe covering thickness is 2 in. (51 mm), min thickness of caulk fill material is 2 in. (51 mm). When nom pipe covering thickness is 1-1/2 in. (38 mm) or less, min thickness of caulk fill material is 1 in. (25 mm). The hourly F and T Ratings of the firestop system are dependent upon the thickness of the floor or wall, the size of pipe, the thickness of pipe covering material and the size of the annular space (between the pipe covering material and the edge of the circular through opening), as shown in the following table:

| Min Floor or Wall Thkns In. (mm) | Max Pipe Diam In. (mm) | Nom Pipe Covering Thkns In. (mm) | Annular Space In. (mm) | F Rating Hr | T Rating Hr |
|----------------------------------|------------------------|----------------------------------|-------------------------|-------------|-------------|
| 2-1/2 (64) | 4 (102) | 1 or 1-1/2 (25 or 38) | 1/2 to 2-3/8 (13 to 60) | 2 | 1 |
| 4-1/2 (114) | 4 (102) | 2 (51) | 1/4 to 3-5/8 (6 to 92) | 2 | 1-1/2 |
| 2-1/2 (64) | 12 (305) | 1 (25) | 1/2 to 1-1/2 (13 to 38) | 2 | 1/2 |
| 4-1/2 (114) | 12 (305) | 1 (25) | 1/2 to 2-3/8 (13 to 60) | 3 | 1 |
| 2-1/2 (64) | 12 (305) | 1/2 (13) | 1/2 to 2-3/8 (13 to 60) | 2 | 0 |

3M COMPANY – CP 25WB+ or FB-3000 WT

*Bearing the UL Classification Marking

Reprinted from the Online Certifications Directory with permission from Underwriters Laboratories Inc.

Copyright © 2010 Underwriters Laboratories Inc.®



System No. C-AJ-5002

September 03, 2004

(Formerly System No. 91-B)

F Ratings – 2 and 3 Hr (See Items 1A and 4)

T Ratings – 0, 1/2 and 1 Hr (See Items 1A and 4)

L Rating At Ambient – 2 CFM/sq ft

L Rating At 400 F – less than 1 CFM/sq ft

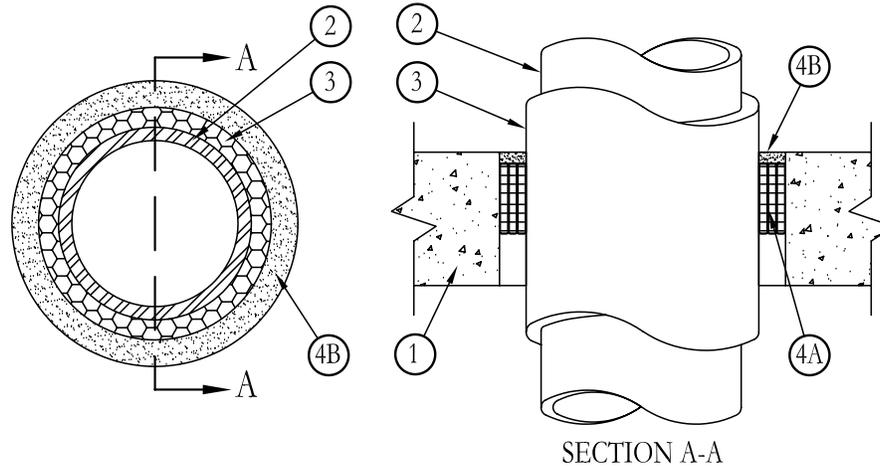

- Floor or Wall Assembly** – Min 2-1/2 in. thick reinforced lightweight or normal weight (100-150 pcf) concrete. Wall may also be constructed of any UL Classified **Concrete Blocks***. Max diam of opening is 36 in.
See **Concrete Blocks** (CAZT) category in the Fire Resistance Directory for names of manufacturers.

- Steel Sleeve** (Optional, not shown) – Nom 36 in. diam (or smaller) Schedule 10 (or heavier) steel pipe sleeve cast into min 4-1/2 in. thick concrete floor or wall. Sleeve to be flush with or project max 2 in. from top surface of floor or from both surfaces of wall. **When steel sleeve is used, F Rating is 2 hr and T Rating is 0 hr.**
- Pipe** – Nom 4 in. diam (or smaller) Type L (or heavier) copper pipe, nom 15 in. diam (or smaller) service weight (or heavier) cast iron soil pipe, nom 30 in. diam (or smaller) Class 50 (or heavier) ductile iron pressure pipe or nom 30 in. diam (or smaller) Schedule 10 (or heavier) steel pipe centered in the opening and rigidly supported on both sides of the floor or wall assembly.
- Pipe Covering*** – Nom 1, 2 or 3 in. thick hollow cylindrical heavy density glass fiber units jacketed on the outside with an all service jacket. Longitudinal joints sealed with metal fasteners or factory-applied self-sealing lap tape. Transverse joints secured with metal fasteners or with butt strip tape supplied with the product.

See Pipe and Equipment Covering – Materials* (BRGU) category in Building Materials Directory for names of manufacturers. Any pipe covering material meeting the above specifications and bearing the UL Classification Marking with a Flame Spread Index of 25 or less and a Smoke Developed Index of 50 or less may be used.

- Firestop System** – The details of the firestop system shall be as follows:
 - Fill, Void or Cavity Materials* – Wrap Strip** – Nom 1/4 in. thick intumescent elastomeric material faced on one side with aluminum foil, supplied in 2 in. wide by 24 in. long strips. Nom 2 in. wide strips tightly-wrapped around pipe covering (foil side exposed) to fill annular space. Each layer of wrap strip is to be installed with a butted seam, with the butted seams in successive layers staggered. Wrap strip layers securely bound with steel wire or aluminum foil tape and slide into annular space such that the top edges are recessed min 1/2 in. from top surface of floor. In wall assemblies, the wrap strip layers shall be installed in the same manner used for floor assemblies but shall be installed symmetrically on both sides of the wall. The min number of wrap strip layers required is dependent upon the max pipe size and the pipe covering thickness, as shown in the following table:

| Min Floor or Wall Thkns In. | Max Pipe Diam In. | Nom Pipe Covering Thkns In. | Annular Space In. | Min No. of Wrap Strip Layers | F Rating Hr | T Rating Hr |
|-----------------------------|-------------------|-----------------------------|-------------------|------------------------------|-------------|-------------|
| 2-1/2 | 6 | 1 | 1/4 to 3/8 | 1 | 2 | 1 |
| 2-1/2 | 6 | 2 | 1/2 to 5/8 | 2 | 2 | 1 |
| 2-1/2 | 12 | 1 | 1/4 to 3/8 | 1 | 2 | 1/2 |
| 4-1/2 | 12 | 1 | 1/4 to 3/8 | 1 | 2 | 1 |
| 4-1/2 | 12 | 2 | 1/2 to 5/8 | 2 | 2 | 1 |
| 4-1/2 | 20 | 1 | 1/2 to 1 | 2 | 3 | 1 |
| 4-1/2 | 30 | 2 | 3/4 to 1-1/4 | 3 | 2 | 1 |
| 4-1/2 | 20 | 3 | 1 to 1-1/2 | 4 | 2 | 1 |

3M COMPANY – FS-195+

- Fill, Void or Cavity Materials* – Caulk or Sealant** – Applied to fill the annular space (over edges of wrap strip layers) to a min depth of 1/2 in., flush with top surface of floor or both surfaces of wall.

3M COMPANY – CP 25WB+ caulk or FB-3000 WT sealant.

*Bearing the UL Classification Marking

Reprinted from the Online Certifications Directory with permission from Underwriters Laboratories Inc.

Copyright © 2010 Underwriters Laboratories Inc.®



System No. C-AJ-5003

May 19, 2005

F Rating – 2 Hr

T Ratings – 1/2 and 1 Hr (See Item 4)

L Rating At Ambient – 2 CFM/sq ft.

L Rating At 400 F – less than 1 CFM/sq ft.

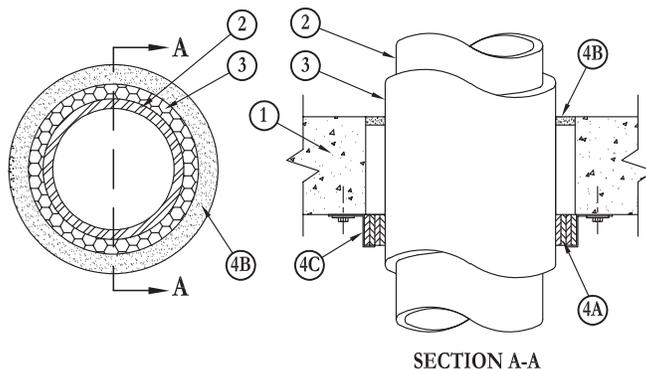

1. **Floor or Wall Assembly** – Min 2-1/2 in. (64 mm) thick reinforced lightweight or normal weight (100-150 pcf or 1600-2400 kg/m³) concrete. Wall may also be constructed of any UL Classified **Concrete Blocks***. Max diam of opening is 27 in. (686 mm).
See **Concrete Blocks (CAZT)** category in the Fire Resistance Directory for names of manufacturers.
2. **Pipe** – Nom 4 in. (102 mm) diam (or smaller) Type L (or heavier) copper pipe, nom 15 in. (381 mm) diam (or smaller) service weight (or heavier) cast iron soil pipe, nom 20 in. (508 mm) diam (or smaller) Class 50 (or heavier) ductile iron pressure pipe or nom 20 in. (508 mm) diam (or smaller) Schedule 10 (or heavier) steel pipe centered in the opening and rigidly supported on both sides of the floor or wall assembly.
3. **Pipe Covering*** – Nom 1, 2 or 3 in. (25, 51 or 76 mm) thick hollow cylindrical heavy density glass fiber units jacketed on the outside with an all service jacket. Longitudinal joints sealed with metal fasteners or factory-applied self-sealing lap tape. Transverse joints secured with metal fasteners or with butt strip tape supplied with the product.
See **Pipe and Equipment Covering – Materials*** (BRGU) category in Building Materials Directory for names of manufacturers. Any pipe covering material meeting the above specifications and bearing the UL Classification Marking with a Flame Spread Index of 25 or less and a Smoke Developed Index of 50 or less may be used.
4. **Firestop System** – The details of the firestop system shall be as follows:

- A. **Fill, Void or Cavity Materials* – Wrap Strip** – Nom 1/4 in. (6 mm) thick intumescent elastomeric material faced on one side with aluminum foil, supplied in 2 in. (51 mm) wide by 24 in. (610 mm) long strips. Nom 2 in. (51 mm) wide strips tightly-wrapped around pipe covering material (foil side exposed) with the top edges butted against the underside of the concrete floor. Sufficient layers of wrap strip shall be installed to lap a min of 3/16 in. (5 mm) on the concrete around the entire perimeter of the through opening. Each layer of wrap strip to be installed with a butted seam, with the butted seams in successive layers staggered. Wrap strip layers temporarily held in position using aluminum foil tape, steel wire, or equivalent. In wall assemblies, the wrap strip is to be installed in the same manner used for floor assemblies but shall be installed symmetrically on both sides of the wall. The min number of wrap strip layers required is dependent upon the max pipe size and the pipe covering thickness, as shown in the following table:

| Min Floor or Wall Thkns In. (mm) | Max Pipe Diam In. (mm) | Nom Pipe Covering Thkns In. (mm) | Annular Space In. (mm) | Min No. of Wrap Strip Layers | F Rating Hr | T Rating Hr |
|----------------------------------|------------------------|----------------------------------|------------------------|------------------------------|-------------|-------------|
| 2-1/2 (64) | 6 (152) | 1 (25) | 0 to 1/2 (0 to 13) | 1 | 2 | 1 |
| 2-1/2 (64) | 6 (152) | 2 (51) | 0 to 1/2 (0 to 13) | 2 | 2 | 1 |
| 2-1/2 (64) | 12 (305) | 1 (25) | 1/4 to 3/8 (6 to 10) | 1 | 2 | 1/2 |
| 4-1/2 (114) | 12 (305) | 1 (25) | 0 to 1/2 (0 to 13) | 1 | 2 | 1 |
| 4-1/2 (114) | 12 (305) | 2 (51) | 0 to 1/2 (0 to 13) | 2 | 2 | 1 |
| 4-1/2 (114) | 20 (508) | 1 (25) | 0 to 1/2 (0 to 13) | 2 | 2 | 1 |
| 4-1/2 (114) | 20 (508) | 2 (51) | 0 to 1/2 (0 to 13) | 3 | 2 | 1 |
| 4-1/2 (114) | 20 (508) | 3 (76) | 0 to 1/2 (0 to 13) | 4 | 2 | 1 |

3M COMPANY – FS-195+

- B. **Fill, Void or Cavity Materials* – Caulk or Sealant** – Generous bead of caulk to be applied to outer perimeter of wrap strip at interface with floor or wall surface(s). In floor assemblies, a min 1/2 in. (13 mm) depth of caulk shall be installed in annular space (if present) flush with top surface of floor. Packing material in annular space, if needed, to be polyethylene backer rod, mineral wool batt or glass fiber insulation.

3M COMPANY – CP 25WB+, IC 15WB+ caulk or FB-3000 WT sealant.

- C. **Steel Collar** – Nom 2 in. (51 mm) deep collar with 1-1/4 in. (32 mm) wide by 2 in. (51 mm) long anchor tabs and 1/4 in. to 3/4 in. (6 mm to 19 mm) long tabs to retain wrap strip layers. Coils of precut 0.016 in. (0.41 mm) thick (No. 30 gauge) galv sheet steel available from wrap strip manufacturer. Steel collar, with anchor tabs bent outward 90 degrees, wrapped tightly around wrap strip layers with min 1 in. (25 mm) overlap at seam. With steel anchor tabs pressed tightly against floor or wall surface, compress collar around wrap strip layers using a min 1/2 in. (13 mm) wide by 0.028 in. (0.71 mm) thick stainless steel band clamp with worm drive tightening mechanism at the collar midheight. Secure collar to floor or wall surface(s) with min 3/16 in. diam by 1-1/4 in. (5 mm by 32 mm) long steel anchor bolts, or equivalent, in conjunction with min 1-1/4 in. (32 mm) diam steel washers. One anchor bolt required in each anchor tab. As a final step, bend retainer tabs 90 deg toward pipe covering to lock wrap strip layers in position.

*Bearing the UL Classification Marking



System No. C-AJ-5005

November 11, 1994
 (Formerly System No. 203)
 F Rating – 2 Hr
 T Rating – 3/4 Hr

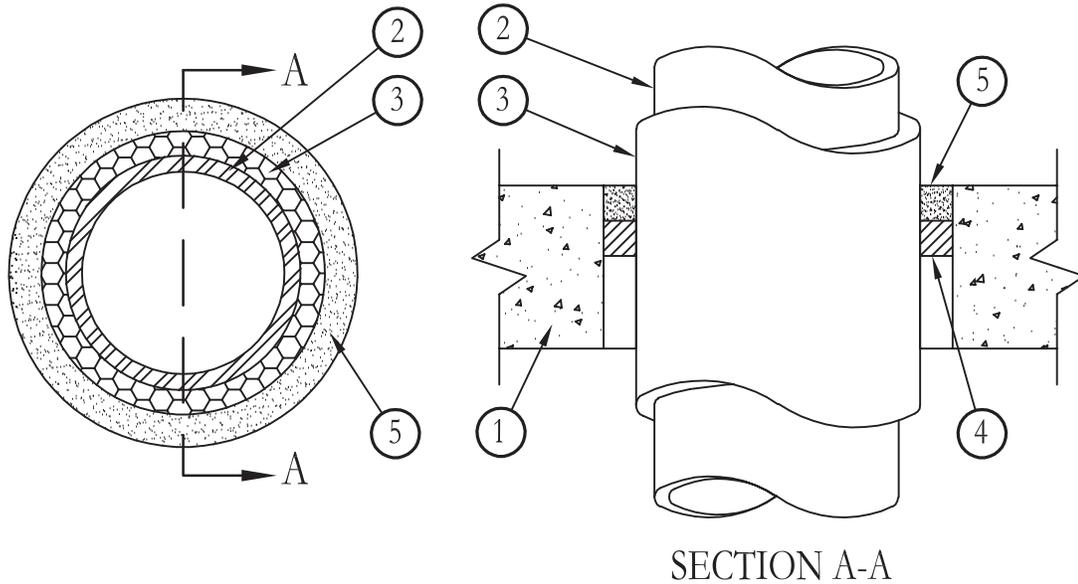

- Floor or Wall Assembly** – Min 4-1/2 in. thick lightweight or normal weight (100-150 pcf) concrete. Wall may also be constructed of any UL Classified **Concrete Blocks***. Max diam of opening is 6-1/4 in.
See **Concrete Blocks (CAZT)** category in Fire Resistance Directory for names of manufacturers.
- Copper Pipe** – Nom 3 in. diam (or smaller) Type L (or heavier) copper tubing or Regular (or heavier) copper pipe centered in the opening.
- Pipe Covering*** – Nom 1 in. thick hollow cylindrical heavy density glass fiber units jacketed on the outside with an all service jacket. Longitudinal joints sealed with metal fasteners or factory-applied self-sealing lap tape. Transverse joints secured with metal fasteners or with butt strip tape supplied with the product. Min clearance between pipe covering and sides of through opening is 1/2 in.
See **Pipe and Equipment Covering – Materials*** (BRGU) category in Building Materials Directory for names of manufacturers. Any pipe covering material meeting the above specifications and bearing the UL Classification Marking with a Flame Spread Index of 25 or less and a Smoke Developed Index of 50 or less may be used.
- Packing Material** – Min 1 in. thickness of ceramic (alumina silica) fiber blanket or mineral wool batt insulation firmly packed into opening as a permanent form. In floors, packing material to be recessed min 1 in. from the top surface of the floor. In walls, packing material to be recessed min 1 in. from both surfaces of the wall.
- Fill, Void or Cavity Material* – Putty** – Moldable putty material kneaded by hand and packed tightly into annular space, flush with top surface of floor, to a min depth of 1 in. In wall assemblies, min 1 in. thickness of putty to be installed symmetrically on both sides of wall.

3M COMPANY – MP+ Stix

*Bearing the UL Classification Marking

Reprinted from the Online Certifications Directory with permission from Underwriters Laboratories Inc.
 Copyright © 2010 Underwriters Laboratories Inc.®



System No. C-AJ-5009

May 09, 2013

F Rating – 2 Hr

T Rating – 1 Hr

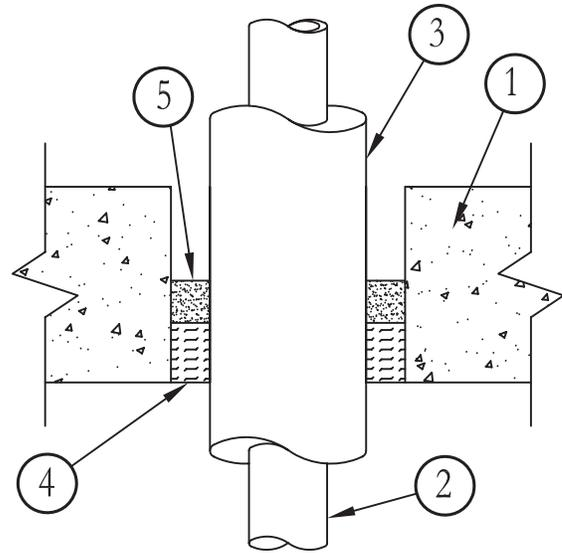
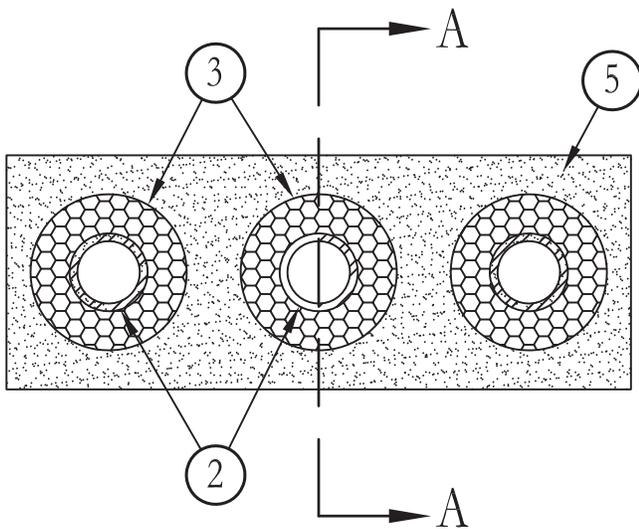

SECTION A-A

1. **Floor or Wall Assembly** – Min 4-1/2 in. (114 mm) thick reinforced lightweight or normal weight (100-150 pcf or 1600-2400 kg/m³) concrete or min 5-1/2 in. (140 mm) thick reinforced lightweight or normal weight concrete wall. Wall may also be constructed of any UL Classified **Concrete Blocks***. Max area of opening is 96 in. with max dimension of 12 in. (305 mm).
See **Concrete Blocks (CAZT)** category in the Fire Resistance Directory for names of manufacturers.
2. **Copper Tube** – A max of four nom 1-1/2 in. (38 mm) diam (or smaller) Type L (or heavier) copper tubing, symmetrically spaced within opening. Tubing to be rigidly supported on both sides of floor or wall assembly.
3. **Pipe Covering*** – Nom 1 in. (25 mm) thick hollow cylindrical heavy density (min 3.5 pcf or 56 kg/m³) glass fiber units jacketed on the outside with an all service jacket. Longitudinal joints sealed with metal fasteners or factory-applied self-sealing lap tape. Transverse joints secured with metal fasteners or with butt tape supplied with the product. The annular space between adjacent insulated tubes shall be min 2-1/4 in. (57 mm). The annular space between insulated tubes and periphery of opening shall be min 2-1/8 in. (54 mm).
See **Pipe and Equipment Covering – Materials*** (BRGU) category in Building Materials Directory for names of manufacturers. Any pipe covering material meeting the above specifications and bearing the UL Classification Marking with a Flame Spread Index of 25 or less and a Smoke Developed Index of 50 or less may be used.
4. **Packing Material** – Min 3-1/2 in. (89 mm) thickness of min 4 pcf (64 kg/m³) mineral wool batt insulation firmly packed into opening as a permanent form. Packing material to be recessed from top surface of floor or from both surfaces of wall as required to accommodate the required thickness of fill material.
5. **Fill, Void or Cavity Material* – Caulk** – Min 1 in. (25 mm) thickness of fill material applied within the annulus, flush with top surface of floor or with both surfaces of wall.

3M COMPANY – Type FB-1000 NS, FB-1003SL (floors only), FB-2000 or FB-2000+.

*Bearing the UL Classification Mark

Reprinted from the Online Certifications Directory with permission from UL

© 2013 UL LLC



Through Penetrations

Insulated Pipes

5000 Series

Concrete

CAJ

System No. C-AJ-5017

August 23, 2004

(Formerly System No. 395)

F Rating – 3 Hr

T Ratings – 1/2 and 1 Hr (See Item 3)

L Rating At Ambient – less than 1 CFM/sq ft

L Rating At 400 F – less than 1 CFM/sq ft

W Rating – Class I (See Item 6)

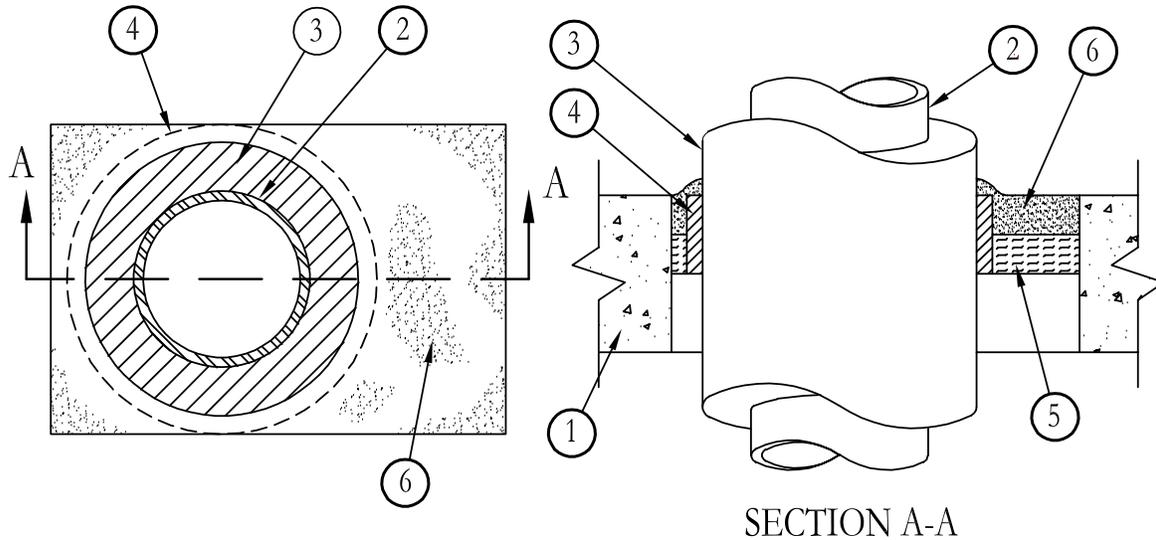

- Floor or Wall Assembly** – Min 4-1/2 in. thick lightweight or normal weight (100-150 pcf) concrete. Wall may also be constructed of any UL Classified **Concrete Blocks*** Max area of square, rectangular or circular opening is 45 sq in. with max dimension of 9 in. See **Concrete Blocks (CAZT)** category in the Fire Resistance Directory for names of manufacturers.
- Pipe** – Nom 3 in. diam (or smaller) Type L (or heavier) copper pipe or nom 2-1/2 in. diam (or smaller) Schedule 10 (or heavier) steel pipe. One or more insulated pipes may be installed with a min clearance of 1/2 in. maintained between insulated pipes and with a min clearance of 1/4 in. maintained between insulated pipe and sides of through opening. Pipes to be rigidly supported on both sides of floor or wall assembly.
- Pipe Insulation – Plastics#** – Nom 3/4 in. thick acrylonitrile butadiene/polyvinyl chloride (AB/PVC) flexible foam furnished in the form of tubing with skin. **When nom 2-1/2 or 3 in. diam insulated steel or copper pipe is used, T Rating is 1/2 hr. When max 2 in. diam insulated steel or copper pipe is used, T rating is 1 hr.**
See **Plastics# (QMFZ2)** category in the Recognized Component Directory for names of manufacturers. Any Recognized Component tube insulation material meeting the above specifications and having a UL94 Flammability Classification of 94-5VA may be used.
- Fill, Void or Cavity Materials* – Wrap Strip** – Nom 1/4 in. thick intumescent elastomeric material faced on one side with aluminum foil, supplied in 2 in. wide strips. One nom 2 in. wide strip tightly-wrapped around pipe insulation (Item 3) with the foil side exposed and slid into through opening such that the top edge is flush with top surface of floor. When a single insulated pipe is installed in a circular through opening and when the max annular space between the insulated pipe and the sides of the through opening is 3/8 in., the wrap strip layer may be secured in place with pressure-sensitive tape. In all other situations, the wrap strip layer shall be secured in place with min No. 18 gauge galv steel tie wire. In wall assemblies, the wrap strip layer is to be installed on the insulated pipe in the same manner used for floor assemblies but shall be installed symmetrically on both sides of the wall.
3M COMPANY – Type FS-195+
- Packing Material** – Min 1 in. thick mineral wool batt insulation firmly packed into opening with its top surface recessed min 1 in. from top surface of the floor. In wall assemblies, packing material to be firmly packed into opening on both sides of wall and recessed min 1 in. from wall surface. When a single insulated pipe (with wrap strip layer) is installed in a circular through opening and when the max annular space between the wrap strip layer and the sides of the through opening is 1/8 in., no forming material is required.
- Fill, Void or Cavity Materials* – Caulk, Sealant or Sealant** – Applied to fill through opening to a min depth of 1 in. In floor assemblies, fill material to be installed flush with top surface of floor. In wall assemblies, fill material to be installed flush with wall surface on both sides of wall.
3M COMPANY – CP 25WB+ caulk or FB-3000 WT sealant.
(Note: W Rating applies only when FB-3000 WT sealant is used.)

*Bearing the UL Classification Marking

Reprinted from the Online Certifications Directory with permission from Underwriters Laboratories Inc.
Copyright © 2010 Underwriters Laboratories Inc.®



System No. C-AJ-5022

January 02, 2009

F Rating – 2 Hr

T Rating – 2 Hr

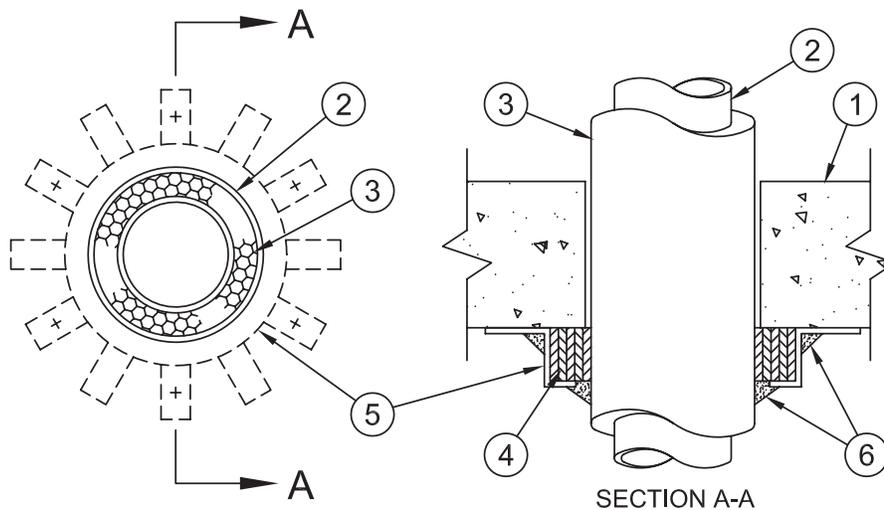

- 1. Floor or Wall Assembly** – Min 4-1/2 in. (114 mm) thick lightweight or normal weight (100-150 pcf or 1600 - 2400 kg/m³) concrete. Wall may also be constructed of any UL Classified **Concrete Blocks***. Diam of circular opening to be max 3/4 in. (19 mm) larger than outside diam of insulated pipe such that max annular space between insulated pipe and edge of opening is 3/8 in. (10 mm) Max diam of opening is 7 in. (178 mm).

See **Concrete Blocks** (CAZT) category in Fire Resistance Directory for names of manufacturers.

- 2. Nonmetallic Pipe** – Nom 4 in. (102 mm) diam (or smaller) Schedule 40 polyvinyl chloride (PVC) pipe centered in circular through opening. Nom 2-1/2 in. (64 mm) to nom 4 in. (102 mm) diam pipes may be used only in closed (process or supply) piping systems. Nom 2 in. (51 mm) diam (or smaller) pipes may be used in closed or vented (drain, waste and vent) piping systems. Pipe rigidly supported on both sides of floor or wall assembly.

- 3. Pipe Covering*** – Nom 1 in. (51 mm) thick hollow cylindrical heavy density (min 3.5 pcf or 56 kg/m³) glass fiber units jacketed on the outside with an all service jacket. Longitudinal joints sealed with metal fasteners or factory-applied self-sealing lap tape. Transverse joints sealed with metal fasteners or with butt strip tape supplied with the product.

See **Pipe and Equipment Covering** – Materials (BRGU) category in Building Materials Directory for names of manufacturers. Any pipe covering materials meeting the above specifications and bearing the UL Classification Marking with a Flame Spread Index of 25 or less and a Smoke Developed Index of 50 or less may be used.

- 3A. Pipe Insulation – Plastics** – As an alternate to Item 3, nom 5/8 in. (16 mm) thick acrylonitrile butadiene/polyvinyl chloride (AB/PVC) flexible foam furnished in the form of tubing with skin may be used on nom 2 in. (51 mm) diam (or smaller) pipes.

See **Plastics** (QMFZ2) category in the Recognized Component directory for names of manufacturers. Any Recognized Component tube insulation material meeting the above specifications and having a UL94 Flammability Classification of 94-5VA may be used.

- 4. Fill, Void or Cavity Materials* – Wrap Strip** – Nom 1/4 in. (6 mm) thick intumescent elastomeric material faced on one side with aluminum foil, supplied in 2 in. (51 mm) wide strips. Nom 2 in. (51 mm) wide strips tightly-wrapped around insulated pipe (foil side exposed) with the top edges butted against the underside of the concrete floor. A min of three layers of wrap strip is required for nom 1/2 in and 2 in. (13 mm to 51 mm) diam pipes. A min of four layers of wrap strip is required for nom 2-1/2 in. and 3 in. (64 mm and 76 mm) diam pipes. A min of five layers of wrap strip is required for nom 3-1/2 in. and 4 in. (89 mm and 102 mm) diam pipes. Each layer of wrap strip to be installed with butted seams in successive layers staggered. Wrap strip layers temporarily held in position with tape. In wall assemblies, the wrap strip layers are to be installed in the same manner used for floor assemblies but shall be installed symmetrically on both sides of the wall.

3M COMPANY – Type FS-195+

- 5. Steel Collar** – Nom 2 in. (51 mm) deep collar with 1-1/4 in. (32 mm) wide by 2 in. (51 mm) long anchor tabs and min 3/4 in. (19 mm) long tabs to retain wrap strip layers. Coils of precut 0.016 in. (.41 mm) thick (30 gauge) galv sheet available from wrap strip manufacturer. As an alternate, collar may be field-fabricated from min 0.016 in. thick (30 gauge) galv sheet steel in accordance with instruction sheet supplied by wrap strip manufacturer. Steel collar, with anchor tabs bent outward 90 degrees, wrapped tightly around wrap strip layers with min 1 in. (25 mm) overlap at seam. With steel collar anchor tabs pressed tightly against floor or wall surface, compress collar around wrap strip layers using a min 1/2 in. (13 mm) wide by 0.028 in. (.71 mm) thick stainless steel band clamp with worm drive tightening mechanism at the collar midheight. Secure collar to floor or wall surface with 1/4 in. (6 mm) diam by min 1-1/2 in. (38 mm) long steel anchor bolts, or equivalent, in conjunction with min 1-1/4 in. (32 mm) diam steel fender washers. Four anchor bolts, symmetrically located, required for nom 2 in. (51 mm) diam pipes. Five anchor bolts, symmetrically located, required for nom 2-1/2 and 3 in. (64 mm and 76 mm) diam pipes. Six anchor bolts, symmetrically located, required for nom 3-1/2 and 4 in. (89 mm and 102 mm) diam pipes. As a final step, bend retainer tabs 90 deg toward pipe to lock wrap strip layers in position.

- 6. Fill, Void or Cavity Materials* – Caulk or Sealant** – Generous bead of caulk applied to outer perimeter of wrap strip at interface with floor or wall surface and to perimeter of pipe insulation at its egress from the wrap strip layers.

3M COMPANY – CP 25WB+, IC 15WB+, FireDam 150+ caulk

*Bearing the UL Classification Mark

Reprinted from the Online Certifications Directory with permission from Underwriters Laboratories Inc.

Copyright © 2010 Underwriters Laboratories Inc.®



System No. C-AJ-5024

January 02, 2009

F Ratings – 2 and 3 Hr (See Item 4A)

T Ratings – 1 and 1-1/2 Hr (See Item 4A)

L Rating At Ambient – 2 CFM/sq ft.

L Rating At 400 F – less than 1 CFM/sq ft.

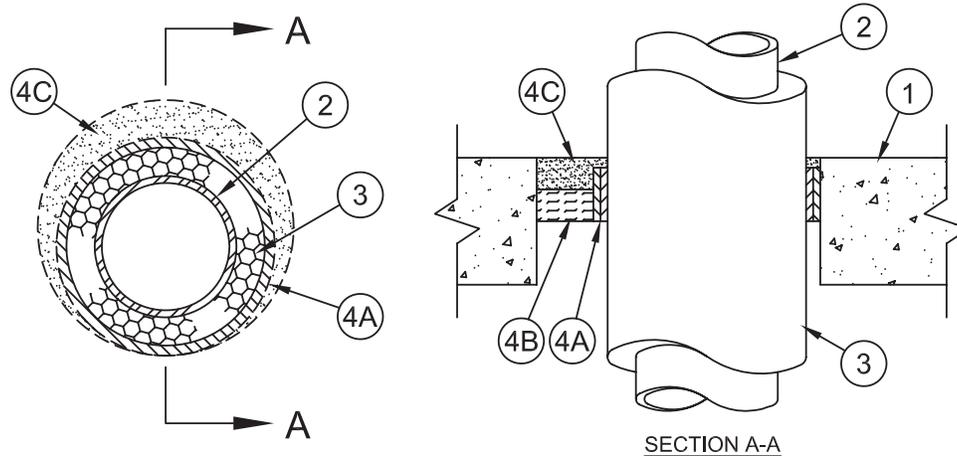

1. **Floor or Wall Assembly** – Min 4-1/2 in. (114 mm) thick lightweight or normal weight (100-150 pcf or 1600 - 2400 kg/m³) concrete. Wall may also be constructed of any UL Classified **Concrete Blocks***. Max diam of circular through opening is 21 in. (533 mm).
See **Concrete Blocks (CAZT)** category in the Fire Resistance Directory for names of manufacturers.
- 1A. **Steel Sleeve** – (Optional, not shown) – Nom 21 in. (533 mm) (or smaller) Schedule 10 (or heavier) steel sleeve cast or grouted into floor or wall assembly. Sleeve may extend a max of 2 in. (51 mm) above top of floor or beyond either surface of wall. Sleeve may be used only when floor or wall assembly is min 4-1/2 in. (114 mm) thick. **F Rating is 2 hr when steel sleeve is used. T Rating is 1/2 Hr when nom 10 in. (254 mm) diam and smaller sleeve is used. T Rating is 0 when sleeves larger than nom 10 in. (254 mm) diam are used.**
2. **Through Penetrants** – One metallic pipe or tubing to be installed either concentrically or eccentrically within the firestop. Pipe or tubing to be rigidly supported on both sides of wall assembly. The following types and sizes of metallic pipes or tubing may be used:
 - A. **Steel Pipe** – Nom 10 in. (254 mm) diam (or smaller) Schedule 10 (or heavier) steel pipe.
 - B. **Copper Tubing** – Nom 4 in. (102 mm) diam (or smaller) Type L (or heavier) copper tubing.
 - C. **Copper Pipe** – Nom 4 in. (102 mm) diam (or smaller) Regular (or heavier) copper pipe.
3. **Pipe Covering*** – Nom 1, 2 or 3 in. (25, 51 or 76, mm) thick hollow cylindrical heavy density (min 3.5 pcf or 56 kg/m³) glass fiber units jacketed on the outside with an all service jacket. Longitudinal joints sealed with metal fasteners or factory-applied self-sealing lap tape. Transverse joints secured with metal fasteners or with butt strip tape supplied with the product.
See **Pipe and Equipment Covering – Materials*** (BRGU) category in Building Materials Directory for names of manufacturers. Any pipe covering material meeting the above specifications and bearing the UL Classification Marking with a Flame Spread Index of 25 or less and a Smoke Developed Index of 50 or less may be used.
4. **Firestop System** – The details of the firestop system shall be as follows:
 - 4A. **Fill, Void or Cavity Materials* – Wrap Strip** – Nom 1/4 in. (6 mm) thick intumescent elastomeric material faced on one side with aluminum foil, supplied in nom 2 in. (51 mm) wide strips. Nom 2 in. (51 mm) wide strip tightly-wrapped around pipe covering material (foil side exposed), secured with a steel wire tie and slid into annular space. In floors, the wrap strip layer is to be installed with its top edge recessed 1/8 to 1/2 in. (3.2 to mm to 13 mm) from the top surface of the floor. In walls, the wrap strip layer is to be installed in the same manner used for floors but it shall be installed symmetrically on both sides of the wall assembly. The min number of wrap strip layers required is dependent upon the pipe covering material thickness, as shown in the following table:

3M COMPANY – Type FS-195+.

| Pipe or Tubing Type | Max Pipe or Tubing Diam In. (mm) | Nom Pipe Covering Thkns In. (mm) | Annular Space In. (mm) | Min No. of Wrap Strip Layers | F Rating Hr | T Rating Hr |
|---------------------|----------------------------------|----------------------------------|-------------------------|------------------------------|-------------|-------------|
| Steel | 6 (152) | 1 (25) | 1/4 to 3-1/2 (6 to 89) | 1 | 3 | 1-1/2 |
| Steel | 10 (254) | 2 (51) | 1/2 to 3-1/2 (13 to 89) | 2 | 3 | 1 |
| Steel | 10 (254) | 3 (76) | 3/4 to 3-1/2 (19 to 89) | 3 | 2 | 1 |
| Copper | 4 (102) | 1 (25) | 1/4 to 2-3/8 (6 to 60) | 1 | 2 | 1/2 |

- 4B. **Packing Material** – When an annular space is present between the wrap strip and the periphery, mineral wool batt insulation shall be tightly-packed into the annular space. In floors, the top surface of the packing material is to be recessed min 1 in. (25 mm) from the top surface of the floor. In walls, the packing material is to be installed in the same manner used for floors but it shall be installed symmetrically on both sides of the wall assembly.
- 4C. **Fill, Void or Cavity Materials* – Caulk or Sealant** – Installed to fill annular space to a min depth of 1 in. (25 mm), flush with top surface of floor or both surfaces of wall, such that exposed edge of wrap strip layer is covered with a 1/8 to 1/2 in. (3.2 mm to 13 mm) thickness.

3M COMPANY – CP 25WB+, IC 15WB+ caulk or FB-3000 WT sealant.

*Bearing the UL Classification Marking

Reprinted from the Online Certifications Directory with permission from Underwriters Laboratories Inc.

Copyright © 2010 Underwriters Laboratories Inc.®



System No. C-AJ-5030

January 02, 2009

F Rating – 1 and 2 Hr (See Item 1)

T Rating – 0 Hr

L Rating At Ambient – 2 CFM/sq ft

L Rating At 400 F – less than 1 CFM/sq ft

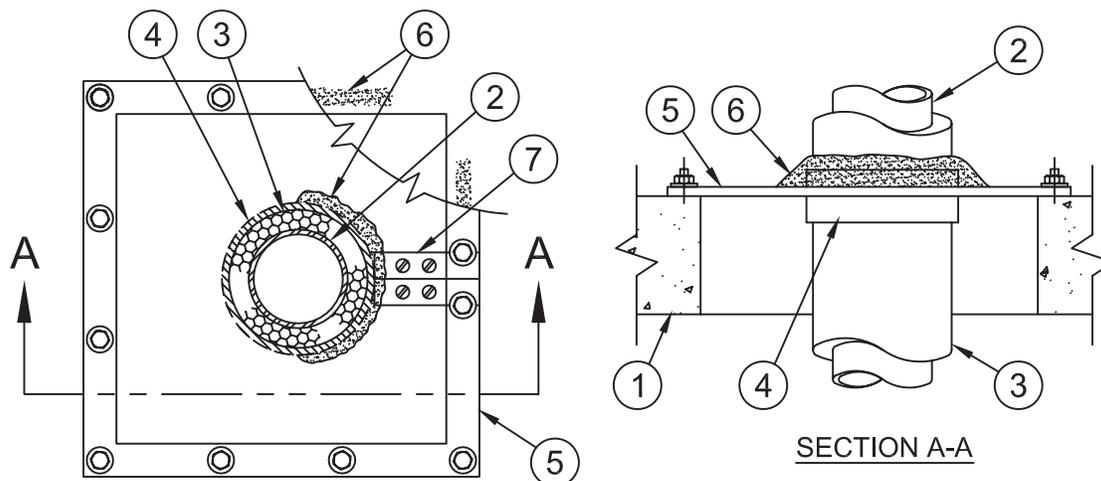

- 1. Floor or Wall Assembly** – Lightweight or normal weight (100-150 pcf or 1600 - 2400 kg/m³) concrete. Min thickness of concrete floor or wall is 2-1/2 in. (64 mm) for 1 hr F Rating and 4-1/2 in. (114 mm) for 2 hr F Rating. Wall may also be constructed of any UL Classified **Concrete Blocks***. Max area of opening 36 sq ft (3.4 m²) with one dimension of opening being 36 in. (914 mm) or less.
See **Concrete Blocks (CAZT)** category in the Fire Resistance Directory for names of manufacturers.
- 2. Metallic Pipe** – Nom 12 in. (305 mm) diam (or smaller) Schedule 10 (or heavier) steel pipe or nom 6 in. (152 mm) diam (or smaller) Type L (or heavier) copper tubing. Min clearance between insulated pipes 1 in. (25 mm) Min clearance between insulated pipe and wall of through opening 1/4 in. (6 mm) Pipes rigidly supported on both sides of floor or wall assembly.
- 3. Pipe Covering** – Nom 1 in. to 2 in. (25 mm to 51 mm) thick hollow cylindrical heavy density (min 3.5 pcf or 56 kg/m³) glass fiber units jacketed on the outside with an all service jacket. Longitudinal joints sealed with metal fasteners or with factory-applied self-sealing lap tape. Transverse joints secured with metal fasteners or with butt strip tape supplied with the product.
See **Pipe and Equipment Covering – Materials*** (BRGU) category in Building Materials Directory for names of manufacturers. Any pipe covering material meeting the above specifications and bearing the UL Classification Marking with a Flame Spread Index of 25 or less and a Smoke Developed Index of 50 or less may be used.
- 3A. Pipe Insulation – Plastics** – As an alternate to Item 3, nom 1 in. (25 mm) thick acrylonitrile butadiene/polyvinyl chloride (AB/PVC) flexible foam furnished in the form of tubing with skin may be used with nom 4 in. (102 mm) diam (or smaller) pipes.
See **Plastics (QMFZ2)** category in the Recognized Component Directory for names of manufacturers. Any Recognized Component tube insulation material meeting the above specifications and having a UL94 Flammability Classification of 94-5VA may be used.
- 4. Fill, Void or Cavity Materials* – Wrap Strip** – Nom 1/4 in. (6 mm) thick intumescent elastomeric material faced on one side with aluminum foil, supplied in strips. Min 2 in. (51 mm) wide strip wrapped around pipe insulation (foil side exposed) and secured in place with steel wire or aluminum foil tape. One layer of wrap strip is required when max 1 in. (25 mm) thick pipe covering is used. Two layers of wrap strip are required when nom 2 in. (51 mm) thick pipe covering is used. Wrap strip to extend approx 7/8 in. (22 mm) beyond each face of the intumescent sheet (Item 5).
3M COMPANY – Type FS-195+
- 5. Fill, Void Or Cavity Materials* – Intumescent Sheet** – Rigid aluminum foil-faced sheet with galv steel sheet backer. Sheet cut to tightly follow the contours of the wrap strip on the pipe insulation and with a min lap of 2 in. (51 mm) on all sides of the through opening. Sheet to be installed with the galv steel sheet backer exposed (aluminum foil facing against floor or wall surface). Sheet secured to top surface of floor and both sides of wall using min 3/16 in. (5 mm) diam by 1-1/4 in. (32 mm) long steel masonry fasteners with min 1-1/4 in. (32 mm) diam steel washers. Max spacing of fasteners not to exceed 6 in. (152 mm) OC.
3M COMPANY – Type CS-195+
- 6. Fill, Void Or Cavity Materials* – Graphite Seal, Caulk or Sealant** – One layer of 1/2 in. x 1/16 in. (13 mm by 1.6 mm) (13 mm by 1.6 mm) adhesive backed graphite intumescent seal positioned under intumescent sheet around entire perimeter of through opening or min 1/4 in. (6 mm) diam continuous bead of caulk or putty applied to edge of intumescent sheet at its interface with surface of floor or wall around entire perimeter of through opening. Generous application of caulk to be applied around the base of the wrap strip at its egress from the intumescent sheet(s) in addition to completely covering the wrap strip up to the interface(s) with the pipe insulation.
3M COMPANY – E-FIS or Ultra GS seals, CP 25WB+ caulk, FB-3000 WT Sealant, MP+ Stix putty or IC 15WB+ caulk
- 7. Steel Cover Strip** – Min 2 in. (51 mm) wide strip of min 0.015 in. (.4 mm) thick (30 gauge) galv steel centered over entire length of slit made in intumescent sheet (Item 5) to permit installation about the insulated pipe. Prior to installation of the steel strip, slit in intumescent sheet covered with nom 1/4 in. (6 mm) diam bead of caulk (Item 6). Steel cover strip secured to galv steel backer of intumescent sheet with steel sheet-metal screws or steel rivets spaced max 2 in. (51 mm) OC on each side of slit.

Through Penetrations

Insulated Pipes

5000 Series

Concrete

CAJ

System No. C-AJ-5030 *continued*

8. **Support Channel** – (Not Shown) – When area of through opening exceeds 1440 sq in., (9290 cm²) an intermediate support channel shall be installed flush with top surface of floor or both surfaces of wall. Support channels to be min 1-5/8 by 1-5/8 in. (41 mm by 41 mm) and formed of min 0.093 in. (2.4 mm) thick (No. 12 gauge) painted or galv steel. Ends of steel channel bolted or welded to steel angles anchored to inside walls of through opening. When steel support channels are centered beneath butted seams of intumescent sheets, no steel cover strip (Item 6) is required over butted seam. Intumescent sheet secured to steel support channels with steel sheet metal screws in conjunction with min 1-1/4 in. (32 mm) diam steel fender washers.

When support channel is used beneath butted seam of intumescent sheets, fasteners spaced max 3 in. (76 mm) OC on each side of butted seam. When support channel is located away from intumescent sheet seam, fasteners spaced max 6 in. (152 mm) OC. Prior to installation of the intumescent sheet(s), a nom 1/4 in. (6 mm) diam continuous bead of caulk, (Item 5) shall be applied as gasket over the steel support channel.

*Bearing the UL Classification Mark

Reprinted from the Online Certifications Directory with permission from Underwriters Laboratories Inc.
Copyright © 2010 Underwriters Laboratories Inc.®



Through Penetrations

Insulated Pipes

5000 Series

Concrete

CAJ

System No. C-AJ-5041

May 09, 2013

ANSI/UL2079
F Rating – 2 Hr
T Rating – 1 and 2 Hr (See Items 3 and 3A)

CAN/ULC S115
F Rating – 2 Hr
FT Rating – 1 and 2 Hr (See Items 3 and 3A)
FH Rating – 2 Hr
FTH Rating – 1 and 2 Hr (See Items 3 and 3A)

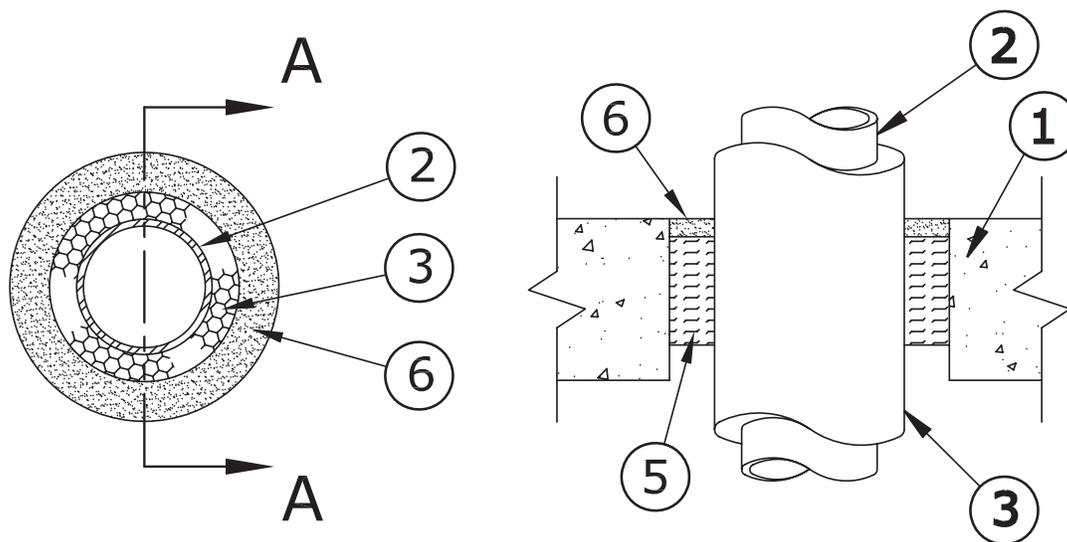

1. **Floor or Wall Assembly** – Min 4-1/2 in. (114 mm) thick reinforced lightweight or normal weight (100-150 pcf or 1600-2400 kg/m³) concrete. Wall may also be constructed of any UL Classified **Concrete Blocks** *. Max diam of opening is 32 in. (813 mm).
See **Concrete Block (CAZT)** category in the Fire Resistance Directory for names of manufacturers.
2. **Through-Penetrants** – One metallic pipe or tubing to be installed either concentrically or eccentrically within the firestop system. Pipe or tubing to be rigidly supported on both sides of floor or wall assembly. The following types and sizes of metallic pipes or tubing may be used:
 - A. **Steel Pipe** – Nom 24 in. diam (or smaller) Schedule 10 (or heavier) steel pipe. When Type FB-1000 NS or FB-1003 SL sealant (see Item 6) is used, pipe diam shall not exceed nom 8 in. (203 mm).
 - B. **Copper Tubing** – Nom 6 in. diam (or smaller) Type L (or heavier) copper tubing.
 - C. **Copper Pipe** – Nom 6 in. diam (or smaller) Regular (or heavier) copper pipe. When Type FB-1000 NS or FB-1003 SL sealant (see Item 6) is used, pipe diam shall not exceed nom 4 in. (102 mm).
3. **Pipe Covering Materials*** – Used in conjunction with Item 4. Nom 3 in. (76 mm) thick unfaced mineral fiber pipe insulation sized to the outside diam of pipe or tube. Pipe insulation secured with min 8 AWG steel wire spaced max 12 in. (305 mm) OC. An annular space of min 1/2 in. (13 mm) to max 1-1/2 in. (38 mm) is required within the firestop system. **When mineral wool pipe covering is used, the T, FT and FTH Rating is 2 hr.**
IIG MINWOOL LLC – High Temperature Pipe Insulation 1200, High Temperature Pipe Insulation BWT or High Temperature Pipe Insulation Thermaloc
- 3A. **Pipe Covering*** – Used as an alternate to Items 3 and 4. Nom 1 in. (25 mm) thick hollow cylindrical heavy density (min 3.5 pcf or 56 kg/m³) glass fiber units jacketed on the outside with an all service jacket. Longitudinal joints tightly butted and sealed with metal fasteners or factory applied self-sealing lap tape. Transverse joints secured with metal fasteners or with butt tape supplied with the product. An annular space of min 1/2 in. (13 mm) to max 1-1/2 in. (38 mm) is required within the firestop system. **When glass fiber pipe covering is used, the T, FT and FTH Rating is 1 hr.**
See **Pipe and Equipment Covering – Materials (BRGU)** category in the Building Materials Directory for names of manufacturers. Any pipe covering material meeting the above specification and bearing the UL Classification Marking with a Flame Spread Index of 25 or less and a Smoke Developed Index of 50 or less may be used.
4. **Sheathing Material** – (Not shown) – Optionally, used in conjunction with Item 3. Foil-scrim-kraft or all service jacket material shall be wrapped around the outer circumference of the pipe covering material (Item 3) with the kraft side exposed. Longitudinal joints sealed with metal fasteners.
See **Sheathing Materials (BVDV)** category in the Building Materials Directory for names of manufacturers. Any sheathing material meeting the above specifications and bearing the UL Classification Marking with a Flame Spread Index of 25 or less and a Smoke Developed Index of 50 or less may be used.
5. **Packing Material** – Min 3 in. (76 mm) thickness of min 4 pcf (64 kg/m³) mineral wool batt insulation firmly packed into opening as a permanent form. Packing material to be recessed from top surface of floor or from both surfaces of wall as required to accommodate the required thickness of fill material.
6. **Fill, Void or Cavity Material* – Sealant** – Min 1/2 in. (13 mm) thickness of fill material applied within annulus, flush with top surface of floor or with both surfaces of wall.

3M COMPANY – Type FB-1000 NS, FB-1003SL (floors only), FB-2000 or FB-2000+.

*Bearing the UL Classification Mark

Reprinted from the Online Certifications Directory with permission from UL
© 2013 UL LLC



3M Fire Protection Products
Through Penetrations Applicators and Specifiers Guide

System No. C-AJ-5060

March 23, 2016

F Ratings — 2 and 3 Hr (See Item 3)

T Ratings — 1/2, 3/4, 1 and 1-1/2 Hr (See Item 3)

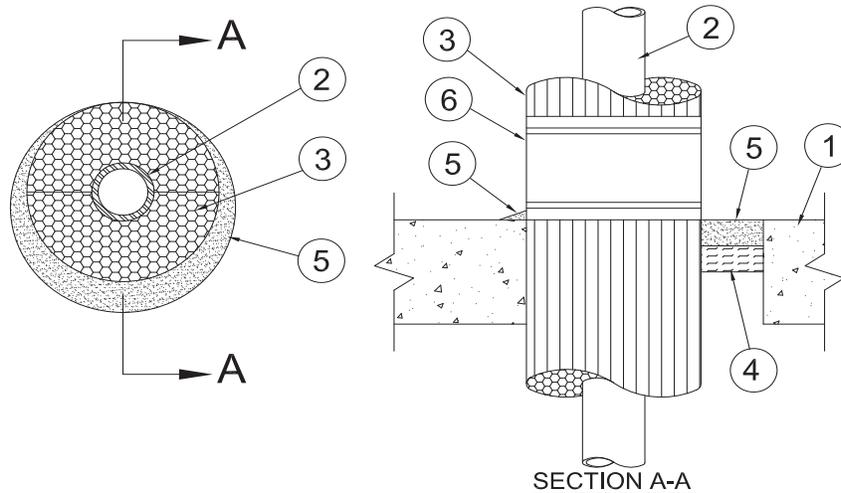

1. **Floor or Wall Assembly** — Min 2-1/2 in. (64 mm) thick lightweight or normal weight (100-150 pcf or 1600 - 2400 kg/m³) concrete. Wall may also be constructed of any UL Classified **Concrete Blocks***. F Ratings and T ratings are dependent on the min thickness of floor or wall, as well as the max size of the pipe and the nom thickness of the cellular glass insulation, as noted in Item 3. Max diam of through opening is 38 in. (965 mm).

See **Concrete Blocks** (CAZT) category in the Fire Resistance Directory for names of manufacturers.

1A. **Steel Sleeve** — (Optional, Not Shown) — Nom 16 in. (406 mm) diam (or smaller) Schedule 10 (or heavier) steel sleeve cast or grouted into floor or wall assembly. Sleeve may extend a max of 2 in. (51 mm) above top of floor or beyond either surface of wall. As an alternate, nom 16 in. (406 mm) diam (or smaller) sleeve fabricated from nom 0.028 in. (0.71 mm) thick galv steel cast or grouted into floor or wall assembly flush with floor or wall surfaces. **T Rating is 0 Hr when sleeve is used.**

2. **Through Penetrants** — One metallic pipe or tubing to be positioned within the firestop system. Pipe or tubing to be rigidly supported on both sides of floor or wall assembly. The following types and sizes of metallic pipes or tubing may be used:
- A. **Steel Pipe** — Nom 30 in. (762 mm) diam (or smaller) Schedule 10 (or heavier) steel pipe.
 - B. **Copper Tubing** — Nom 6 in. (152 mm) diam (or smaller) Type L (or heavier) copper tubing.
 - C. **Copper Pipe** — Nom 6 in. (152 mm) diam (or smaller) Regular (or heavier) copper pipe.
3. **Pipe Covering Materials*** — **Cellular Glass Insulation** — Nom 1-1/2 to 3 in. (38 to 76 mm) thick cellular glass units sized to the outside diam of the steel pipe and supplied in nom 24 in. (610 mm) long half sections or nom 18 in. (457 mm) long segments. Pipe insulation installed on pipe in accordance with the manufacturer's instructions. The annular space between pipe insulation and sleeve or edge of opening shall be min 0 in. (point contact) to max 2-7/8 in. (0 mm to max 73 mm). The F and T Ratings are dependent on the items noted in the following table:

| Min Floor or Wall Thkns, In. (mm) | Max Pipe Diam, In. (mm) | Nom Glass Insul Thkns, In. (mm) | F Rating Hr | T Rating Hr |
|-----------------------------------|-------------------------|---------------------------------|-------------|-------------|
| 2-1/2 (64 mm) | 6 (152 mm) | 1-1/2 and 3 (38 mm, 76 mm) | 2 | 3/4 |
| 4-1/2 (114 mm) | 6 (152 mm) | 1-1/2 (38 mm) | 3 | 1 |
| 4-1/2 (114 mm) | 6 (152 mm) | 3 (76 mm) | 3 | 1-1/2 |
| 4-1/2 (114 mm) | 30 (762 mm) | 1-1/2 (38 mm) | 2 | 1/2 |
| 4-1/2 (114 mm) | 30 (762 mm) | (76 mm) | 2 | 1 |

4. **Packing Material** — Min 1 in. (25 mm) thickness of tightly-packed mineral wool batt insulation material used as a permanent form. Packing material to be recessed min 1 in. (25 mm) from top surface of floor or from both surfaces of wall to accommodate the caulk fill material (Item 5).
5. **Fill, Void or Cavity Materials*** — **Caulk or Sealant** — Installed to fill annular space to a min depth of 1 in., (25 mm) flush with top surface of floor or both surfaces of wall. A min 1/2 in. (13 mm) diam bead of caulk shall be applied to the pipe insulation/concrete interface at the point contact location on the top surface of the floor and on both sides of walls.
- 3M COMPANY** — CP 25WB+, IC 15WB+ caulk or FB-3000 WT sealant
6. **Metal Jacket** — Min 12 in. (305 mm) long jacket formed of min 0.010 in. (.25 mm) thick steel or aluminum sheet cut to wrap tightly around the pipe insulation with a min 2 in. (51 mm) lap and secured using bands and seals of similar material. Bands to be located within 2 in. (51 mm) of each end of the jacket and spaced max 10 in. (254 mm) OC. Jacket to be installed with edge abutting surface of caulk fill material (Item 5) on top surface of floor or both surfaces of wall. Metal jacket to be used in addition to any other jacketing material which may be required or desired on the pipe insulation.

* Indicates such products shall bear the UL or cUL Certification Mark for jurisdictions employing the UL or cUL Certification (such as Canada), respectively.



System No. C-AJ-5074

August 03, 1995

F Rating – 3 Hr

T Rating – 1 Hr

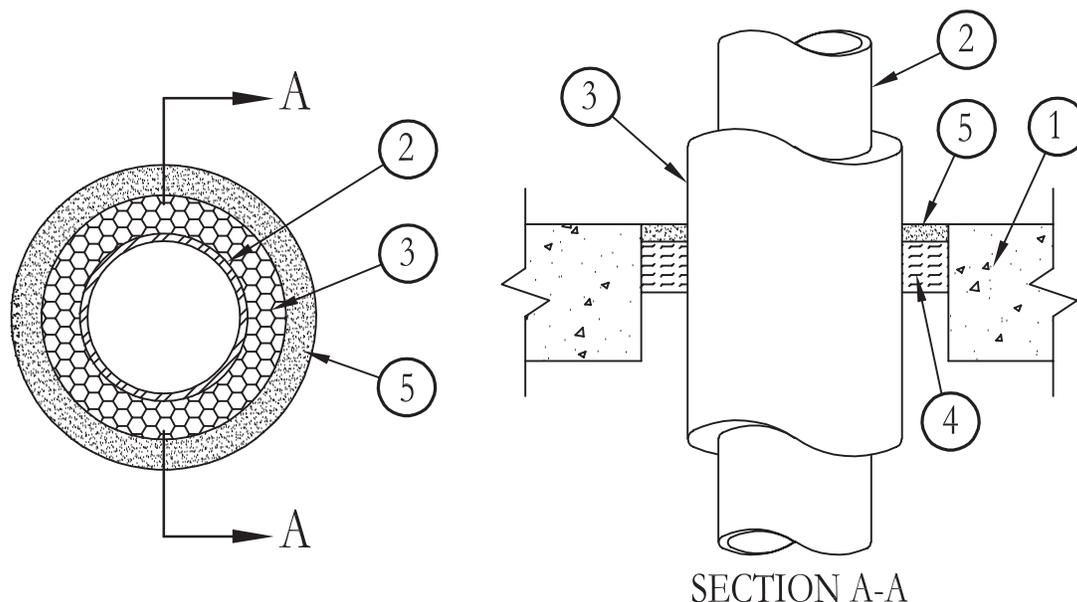

1. **Floor or Wall Assembly** – Min 4-1/2 in. thick reinforced lightweight or normal weight (100-150 pcf) concrete. Wall may also be constructed of any UL Classified **Concrete Blocks***. Max diam of opening is 11 in.
See **Concrete Blocks** (CAZT) category in the Fire Resistance Directory for names of manufacturers.
2. **Steel Pipe** – Nom 6 in. diam (or smaller) Schedule 10 (or heavier) 6 steel pipe to be installed either concentrically or eccentrically within the firestop system. Pipe to be rigidly supported on both sides of floor or wall assembly.
3. **Pipe Covering*** – Nom 1 in. thick hollow cylindrical heavy density glass fiber units jacketed on the outside with an all service jacket. Longitudinal joints tightly butted and sealed with metal fasteners or factory applied self-sealing lap tape. Transverse joints secured with metal fasteners or with butt tape supplied with the product. An annular space of min 3/4 in. to max 1-5/8 in. is required within the firestop system.
See **Pipe and Equipment Covering – Materials** (BRGU) category in the Building Materials Directory for names of manufacturers. Any pipe covering material meeting the above specification and bearing the UL Classification Marking with a Flame Spread Index of 25 or less and a Smoke Developed Index of 50 or less may be used.
4. **Packing Material** – Min 3 in. thickness of min 4 pcf mineral wool batt insulation tightly packed into opening as a permanent form. Packing material to be recessed from top surface of floor or from both surfaces of wall as required to accommodate the required thickness of fill material.
5. **Fill, Void or Cavity Material* – Sealant** – Min 1/4 in. thickness of fill material applied within annulus, flush with top surface of floor or both surfaces of wall assembly. At the point contact location between pipe and concrete, a min 1/2 in. diam bead of sealant shall be applied at the concrete/pipe interface on the top surface of floor and on both surfaces of wall assembly.

3M COMPANY – FB-2000+

*Bearing the UL Classification Marking

Reprinted from the Online Certifications Directory with permission from Underwriters Laboratories Inc.
Copyright © 2010 Underwriters Laboratories Inc.®



System No. C-AJ-5080

August 23, 2004

F Rating – 2 Hr

T Rating – 0 Hr

W Rating – Class I (See Item 4)

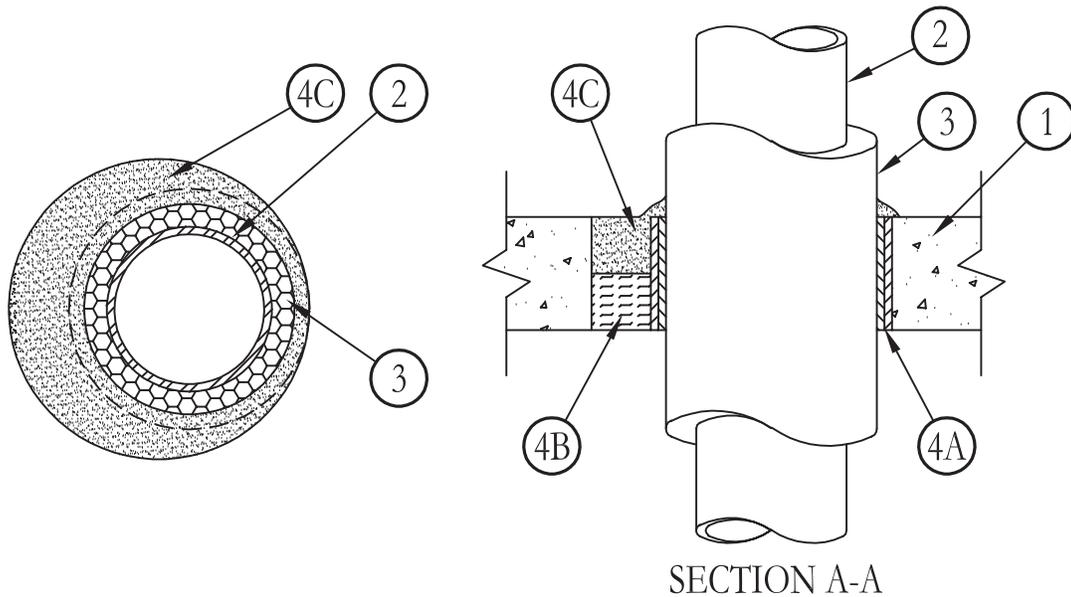

1. **Floor or Wall Assembly** – Min 2-1/2 in. thick reinforced lightweight or normal weight (100-150 pcf) concrete. Wall may also be constructed of any UL Classified **Concrete Blocks***. Max diam of opening is 7-1/2 in.
See **Concrete Blocks (CAZT)** category in the Fire Resistance Directory for names of manufacturers.
2. **Through Penetrants** – One metallic pipe or tubing to be installed either concentrically or eccentrically within the firestop system. Pipe or tubing to be rigidly supported on both sides of floor or wall assembly. The following types and sizes of metallic pipes or tubing may be used:
 - A. **Steel Pipe** – Nom 4 in. diam (or smaller) Schedule 10 (or heavier) steel pipe.
 - B. **Copper Tubing** – Nom 3 in. diam (or smaller) Type L (or heavier) copper tubing.
 - C. **Copper Pipe** – Nom 3 in. diam (or smaller) Regular (or heavier) copper pipe.
3. **Pipe Insulation – Plastics#** – Nom 1/2 to 3/4 in. thick acrylonitrile butadiene/polyvinyl chloride (AB/PVC) flexible foam furnished in the form of tubing. An annular space of min 1/4 in. to max 1-1/4 in. is required within the firestop system.
See **Plastics (QMFZ2)** category in the Plastics Recognized Component Directory for names of manufacturers. Any Recognized Component pipe insulation material meeting the above specifications and having a UL 94 Flammability Classification of 94-5VA may be used.
4. **Firestop System** – The firestop system shall consist of the following:
 - A. **Fill, Void or Cavity Materials* – Wrap Strip** – Nom 1/4 in. thick intumescent elastomeric material faced on one side with aluminum foil, supplied in 2 in. wide strips. One nom 2 in. wide strip tightly-wrapped around pipe insulation with the foil side exposed and slid into through opening such that the top edge is flush with top surface of floor or extending a max of 1 in. above the top surface of floor. When insulated pipe is installed in through openings with a max annular space between the insulated pipe and the periphery of the opening of 1/4 to 3/8 in., the wrap strip layer may be secured in place with pressure-sensitive foil tape. In all other situations, the wrap strip layer shall be secured in place with min No. 18 gauge galv steel tie wire. In wall assemblies, the wrap strip layer is to be installed on the insulated pipe in the same manner used for floor assemblies but shall be installed symmetrically on both sides of the wall.
3M COMPANY – Type FS-195+
 - B. **Packing Material** – Min 1 in. thickness of min 4 pcf mineral wool batt insulation tightly packed into opening as a permanent form. Packing material to be recessed from top surface of floor or from both surfaces of wall as required to accommodate the required thickness of fill material.
 - C. **Fill, Void or Cavity Material* – Caulk or Sealant** – Min 1 in. thickness of fill material applied within annulus, flush with top surface of floor or both surfaces of wall assembly. A min 1/4 in. diam bead of caulk shall be applied to edge of wrap strip on the top surface of floor and on both surfaces of wall assembly.
3M COMPANY – CP 25WB+ caulk or FB-3000 WT sealant.
(Note: W Rating applies only when FB-3000 WT sealant is used.)

*Bearing the UL Classification Marking

#Bearing the UL Recognition Marking

Reprinted from the Online Certifications Directory with permission from Underwriters Laboratories Inc.

Copyright © 2010 Underwriters Laboratories Inc.®



System No. C-AJ-5119

March 05, 2007

F Rating – 2 Hr

T Rating – 1/2 Hr

W Rating – Class 1 (See Item 5)

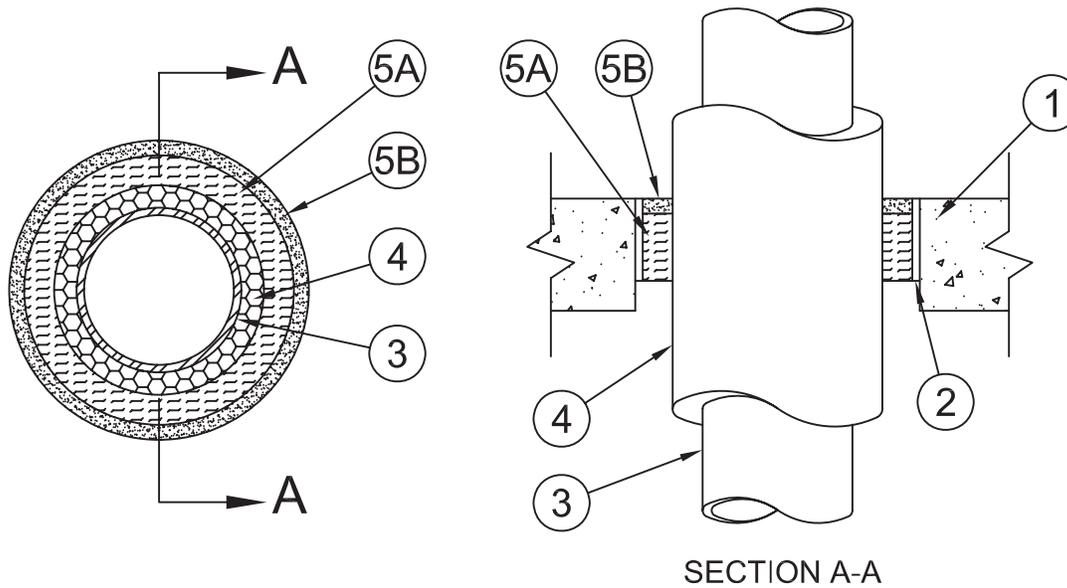

- Floor or Wall Assembly** – Min 4-1/2 in. (114 mm) thick reinforced lightweight or normal weight (100-150 pcf or 1600-2400 kg/m³) concrete. Wall may also be constructed of any UL Classified **Concrete Blocks***. Max diam of opening 8 in. (203 mm).
See **Concrete Block (CAZT)** category in the Fire Resistance Directory for names of manufacturers.
- Steel Sleeve** – (Optional) – Nom 8 in. (203 mm) diam (or smaller) Schedule 10 (or heavier) steel sleeve cast or grouted into floor or wall assembly. As an alternate, nom 8 in. (203 mm) diam (or smaller) sleeve fabricated from nom 0.019 in. (0.48 mm) thick galv steel cast or grouted into floor or wall assembly flush with floor or wall surfaces.
- Through Penetrants** – One metallic pipe or tubing to be installed either concentrically or eccentrically within the firestop system. Penetrants rigidly supported on both sides of floor or wall assembly. The following types and sizes of metallic pipes or tubings may be used:
 - Steel Pipe** – Nom 4 in. (102 mm) diam (or smaller) Schedule 5 (or heavier) steel pipe.
 - Iron Pipe** – Nom 4 in. (102 mm) diam (or smaller) cast or ductile iron pipe.
 - Copper Tubing** – Nom 2 in. (51 mm) diam (or smaller) Type L (or heavier) copper tube.
 - Copper Pipe** – Nom 2 in. (51 mm) diam (or smaller) Regular (or heavier) copper pipe.
- Tube Insulation – Plastics++** – Nom 3/4 in. (19 mm) thick (or thinner) acrylonitrile butadiene/polyvinyl chloride (AB/PVC) flexible foam furnished in the form of tubing. The annular space between the insulated pipe or tube and the edge of the through opening shall be min 3/4 in. (19 mm) to max 1-5/8 in. (41 mm).
See **Plastics (QMFZ2)** category in the Plastics Recognized Component Directory for names of manufacturers. Any Recognized Component tube insulation material meeting the above specifications and having a UL 94 Flammability Classification of 94-5VA may be used.
- Firestop System** – The details of the firestop system shall be as follows:
 - Packing Material** – Min 4 in. (102 mm) thickness of min 4 pcf (64 kg/m³) mineral wool batt insulation firmly packed into opening as a permanent form. Packing material to be recessed from top surface of floor or from both surfaces of wall as required to accommodate the required thickness of fill material.
 - Fill, Void or Cavity Materials* – Caulk or Sealant** – Min 1/4 in. (6 mm) thickness of fill material applied within the annulus, flush with top surface of floor or with both surfaces of wall.
3M COMPANY – CP 25 WB+ or FB-3000 WT.
(Note: W Rating applies only when FB-3000 WT is used.)

*Bearing the UL Classification Marking

++Bearing the UL Recognized Component Marking

Reprinted from the Online Certifications Directory with permission from Underwriters Laboratories Inc.

Copyright © 2010 Underwriters Laboratories Inc.®



Through Penetrations

Insulated Pipes

5000 Series

Concrete

CAJ

System No. C-AJ-5125

March 05, 2007

F Rating – 3 Hr

T Ratings – 1 and 1-1/2 Hr (See Item 2)

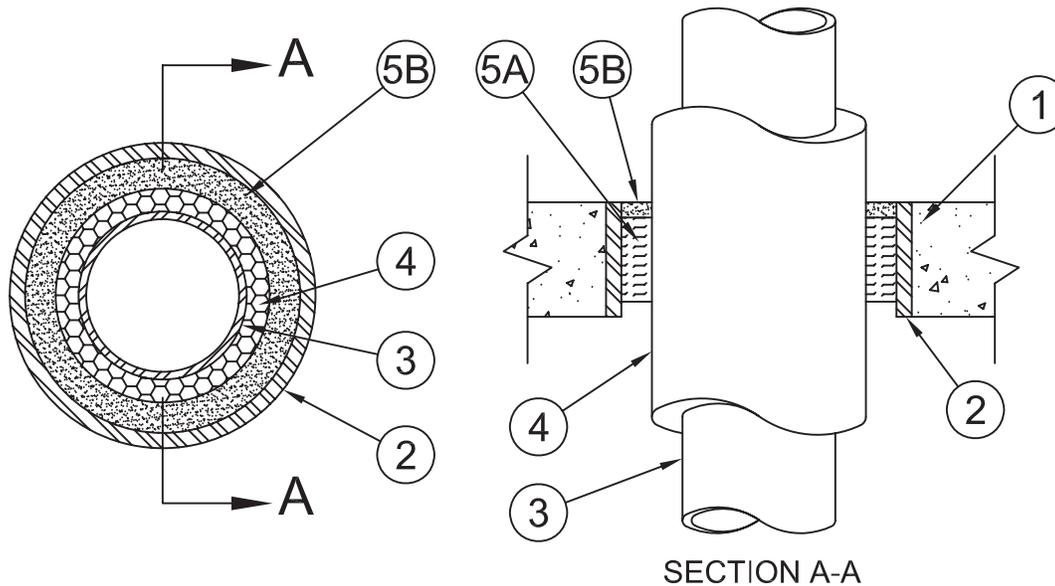

1. **Floor or wall Assembly** – Min 4-1/2 in. (114 mm) thick reinforced lightweight or normal weight (100-150 pcf or 1600-2400 kg/m³) concrete. Wall may also be constructed of any UL Classified **Concrete Blocks***. Max diam of opening is 6 in. (152 mm).
See **Concrete Blocks (CAZT)** category in the Fire Resistance Directory for names of manufacturers.
2. **Sleeves** – (Optional) – The following sleeves may be used:
 - A. **Metallic Sleeve** – Nom 6 in. (152 mm) diam (or smaller) steel Schedule 10 (or heavier) steel pipe cast or grouted into floor or wall assembly, flush with floor or wall surfaces. As an alternate, nom 6 in. (152 mm) diam (or smaller) sleeve fabricated from nom 0.019 in. (0.48 mm) thick galv steel cast or grouted into floor or wall assembly flush with floor or wall surfaces. **T Rating is 1 Hr when metallic sleeve is used.**
 - B. **Nonmetallic Sleeve** – Nom 6 in. diam (or smaller) Schedule 40 polyvinyl chloride (PVC) pipe cast or grouted into floor or wall assembly, flush with floor or wall surfaces. **T Rating is 1-1/2 Hr when PVC sleeve or no sleeve is used.**
3. **Through Penetrants** – One metallic pipe or tubing to be centered within the firestop system. Pipe or tubing to be rigidly supported on both sides of floor or wall assembly. The following types of pipe or tubing may be used:
 - A. **Steel Pipe** – Nom 4 in. (102 mm) diam (or smaller) Schedule 10 (or heavier) steel pipe.
 - B. **Copper Tubing** – Nom 3 in. (76 mm) diam (or smaller) Type M (or heavier) copper tubing.
4. **Pipe Covering*** – Nom 1 in. (25 mm) thick hollow cylindrical heavy density (min 7 pcf or 112 kg/m³) mineral fiber units with an all service jacket. Longitudinal joints sealed with metal fasteners or factory-applied self-sealing lap tape. Transverse joints secured with metal fasteners or with butt tape supplied with the product. A min annular space of 3/8 in. (10 mm) is required within the firestop system.
See **Pipe and Equipment Covering – Materials (BRGU)** category in the Building Materials Directory for names of manufacturers. Any pipe covering meeting the above specifications and bearing the UL Classification Marking with a Flame Spread Index of 25 or less and a Smoke Developed Index of 50 or less may be used.
5. **Firestop System** – The firestop system shall consist of the following:
 - A. **Packing Material** – Min 3-3/4 in. (95 mm) thickness of min 4 pcf (64 kg/m³) mineral wool batt insulation firmly packed into opening as a permanent form so that the width of the wool is compressed at least 50 percent. Packing material to be recessed from top surface of floor or from both surfaces of wall as required to accommodate the required thickness of fill material.
 - B. **Fill, Void or Cavity Material* – Sealant** – Min 1/4 in. (6 mm) thickness of sealant applied within the annulus, flush with the top surface of floor or with both surfaces of wall.
3M COMPANY – FB-1000 NS, FB-3000 WT or FB-1003 SL (floors only)

*Bearing the UL Classification Mark

Reprinted from the Online Certifications Directory with permission from Underwriters Laboratories Inc.
Copyright © 2010 Underwriters Laboratories Inc.®



System No. C-AJ-5156

March 05, 2007

F Rating – 2 Hr

T Rating – 1 Hr

W Rating – Class 1 (See Item 4)

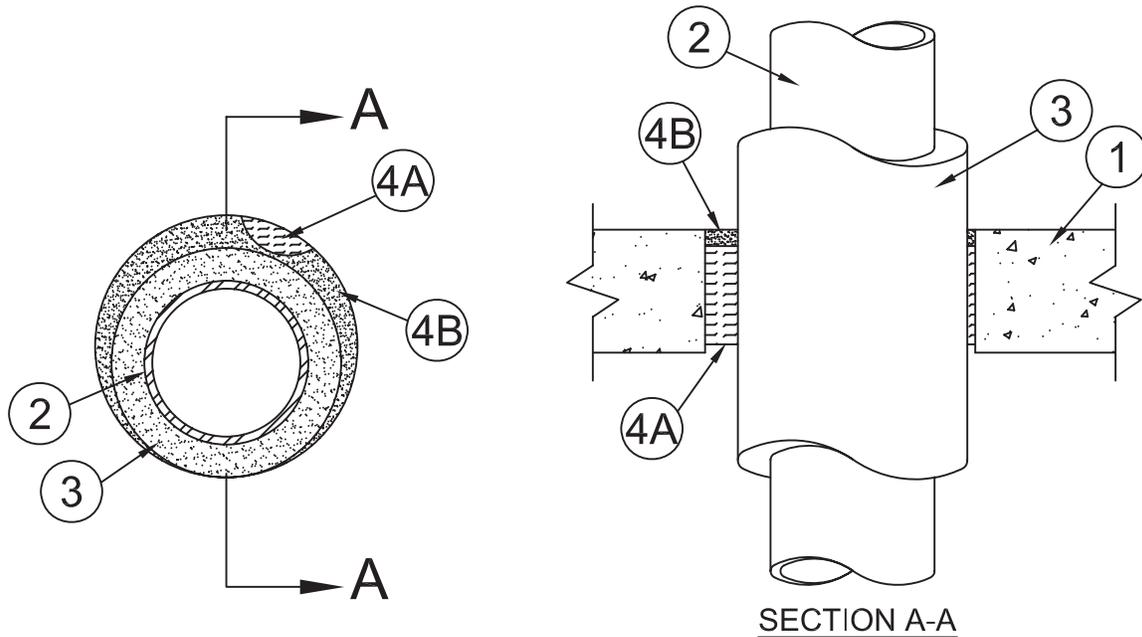

- Floor or Wall Assembly** – Min 4-1/2 in. (114 mm) thick reinforced lightweight or normal weight (100-150 pcf or 1600-2400 kg/m³) concrete. Wall may also be constructed of any UL Classified **Concrete Blocks***. Max diam of opening is 7 in. (178 mm).
See **Concrete Blocks** (CAZT) category in the Fire Resistance Directory for names of manufacturers.
- 1A. Steel Sleeve** – (Optional, Not Shown) - Nom 7 in. (178 mm) diam (or smaller) sleeve fabricated from nom 0.019 in. (0.48 mm) thick galv steel cast or grouted into floor or wall assembly flush with floor or wall surfaces.
- Through Penetrants** – One metallic pipe or tubing to be installed either concentrically or eccentrically within the firestop system. Penetrant to be rigidly supported on both sides of floor or wall assembly. The following types and sizes of pipes or tubing may be used:
 - Steel Pipe** – Nom 3 in. (76 mm) diam (or smaller) Schedule 10 (or heavier) steel pipe.
 - Iron Pipe** – Nom 3 in. (76 mm) diam (or smaller) cast or ductile iron pipe.
 - Copper Tubing** – Nom 3 in. (76 mm) diam (or smaller) Type M (or heavier) copper tube.
 - Copper Pipe** – Nom 3 in. (76 mm) diam (or smaller) Regular (or heavier) copper pipe.
- Tube Insulation – Plastics+** – Nom 1 in. (25 mm) thick acrylonitrile butadiene/polyvinyl chloride (AB/PVC) flexible foam furnished in the form of tubing. The annular space between the insulated penetrating item and the periphery of the opening shall be min 0 in. (point contact) to max 1-7/8 in. (48 mm).
See **Plastics** (QMFZ2) category in the Recognized Component Directory for names of manufacturers. Any Recognized Component tube insulation material meeting the above specifications and having a UL 94 Flammability Classification of 94-5A may be used.
- Firestop System** – The details of the firestop system shall be as follows:
 - Packing Material** – Min 3-1/2 in. (89 mm) thickness of min 4 pcf (64 kg/m³) mineral wool batt insulation firmly packed into opening as a permanent form. Packing material to be recessed from top surface of floor to accommodate the required thickness of fill material.
 - Fill, Void or Cavity Materials*** – **Putty, Sealant or Caulk** – Min 1/2 in. (13 mm) thickness of fill material applied within the annulus, flush with top surface of floor. Min 1/2 in. (13 mm) diam bead of fill material applied to the concrete/tube insulation interface at the point contact location on the top surface of floor.
3M COMPANY – MPS-2+, CP 25WB+ or FB-3000 WT.
(Note: W Rating applies only when FB-3000 WT is used.)

*Bearing the UL Classification Mark

Reprinted from the Online Certifications Directory with permission from Underwriters Laboratories Inc.

Copyright © 2010 Underwriters Laboratories Inc.®

System No. C-AJ-5172

January 02, 2009

F Rating – 3 Hr

T Rating – 0 and 1/2 Hr (See Item 3)

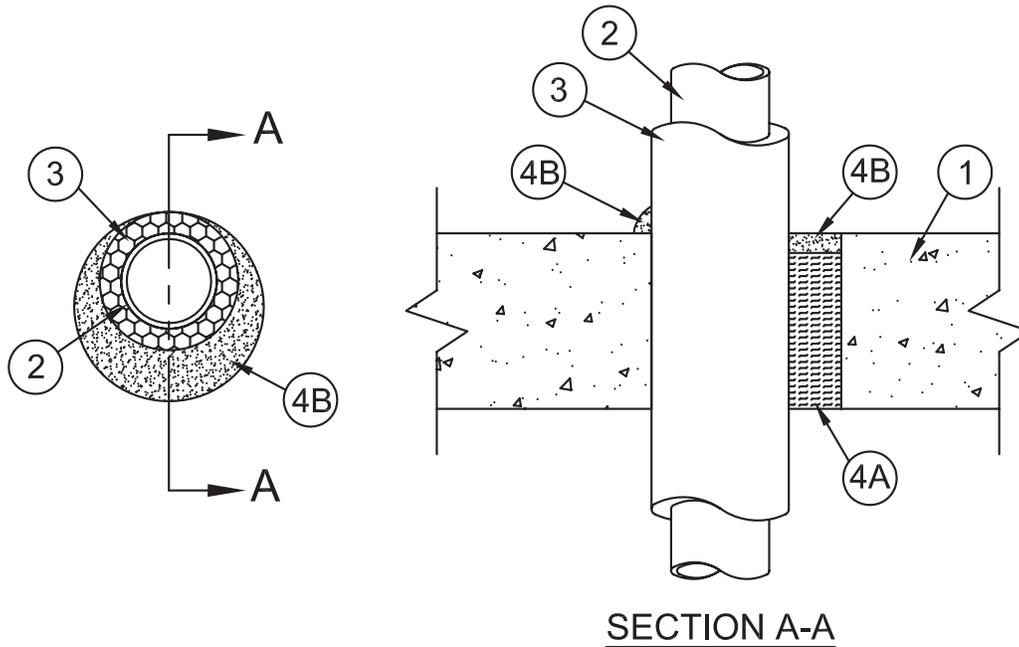

1. **Floor or Wall Assembly** – Min 4-1/2 in. (114 mm) thick reinforced lightweight or normal weight (100-150 pcf or 1600 - 2400 kg/m³) concrete floors or min 5 in. (127 mm) thick reinforcement lightweight or normal weight concrete walls. Wall may also be constructed of any UL Classified **Concrete Blocks***. Max diam of opening 10 in. (254 mm).
See **Concrete Blocks (CAZT)** category in the Fire Resistance Directory for names of manufacturers.
- 1A. **Steel Sleeve** – (Optional, Not Shown) - Nom 10 in. (254 mm) diam (or smaller) sleeve fabricated from nom 0.019 in. (0.48 mm) thick galv steel cast or grouted into floor or wall assembly flush with floor or wall surfaces.
2. **Through Penetrants** – One metallic pipe or tubing to be installed either concentrically or eccentrically within the firestop system. Penetrants rigidly supported on both sides of floor or wall assembly. The following types and sizes of metallic pipes or tubing may be used:
 - A. **Steel Pipe** – Nom 6 in. (152 mm) diam (or smaller) Schedule 10 (or heavier) steel pipe.
 - B. **Iron Pipe** – Nom 6 in. (152 mm) diam (or smaller) cast or ductile iron pipe.
 - C. **Copper Tubing** – Nom 6 in. (152 mm) diam (or smaller) Type M (or heavier) copper tube.
 - D. **Copper Pipe** – Nom 6 in. (152 mm) diam (or smaller) Regular (or heavier) copper pipe.
3. **Pipe Covering** – Nom 1/2 in. to 1 in. (13 to 25 mm) thick hollow cylindrical heavy density (min 3.5 pcf or 56 kg/m³) glass fiber units jacketed on the outside with an all service jacket. Longitudinal joints sealed with metal fasteners or factory-applied self-sealing lap tape. Transverse joints secured with metal fasteners or with butt tape supplied with product. Annular space between pipe covering and periphery of opening shall be min 0 in. (point contact) to max 1-7/8 in. (0 mm to max 48 mm).
See **Pipe and Equipment Covering** - Materials (BRGU) category in the Building Materials Directory for names of manufacturers. Any pipe covering material meeting the above specifications and bearing the UL Classification Marking with a Flame Spread Index of 25 or **T Rating is 1/2 hr when nominal 1 in. (25 mm) thick pipe insulation is used. T Rating is 0 hr when pipe insulation thickness is less than nom 1 in. (25 mm).**
4. **Firestop System** – The details of the firestop system shall be as follows:
 - A. **Packing Material** – Min 4 in. (102 mm) thickness of min 4 pcf (64 kg/m³) mineral wool batt insulation firmly packed into opening as a permanent form. Packing material to be recessed from top surface of floor or from both surfaces of wall as required to accommodate the required thickness of fill material.
 - B. **Fill, Void or Cavity Materials* – Caulk** – Min 1/2 in. (13 mm) thickness of fill material applied within the annulus, flush with top surface of floor or with both surfaces of wall. At point contact location between pipe covering and concrete, a min 1/4 in. (6 mm) diam bead of fill material shall be applied at the concrete/pipe covering interface on the top surface of floor or on both sides of wall.
3M COMPANY – FireDam-150+, CP 25WB+ or IC 15WB+

*Bearing the UL Classification Mark

Reprinted from the Online Certifications Directory with permission from Underwriters Laboratories Inc.
Copyright © 2010 Underwriters Laboratories Inc.®



System No. C-AJ-5183

March 28, 2012

ANSI/UL1479 (ASTM E814)
 F Rating – 2 Hr
 T Ratings – 0 and 1/2 Hr (See Item 3)

CAN/ULC S115
 F Rating – 2 Hr
 FT Ratings – 0 and 1/2 Hr (See Item 3)
 FH Rating – 2 Hr
 FTH Ratings – 0 and 1/2 Hr (See Item 3)

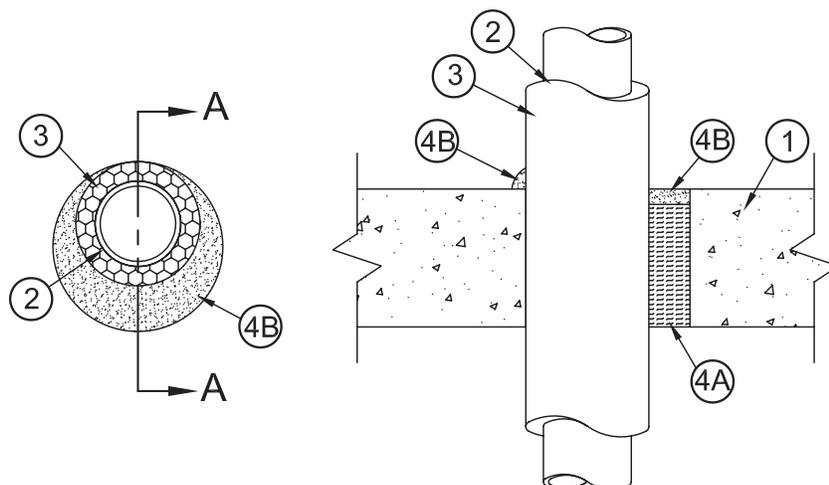

SECTION A-A

- Floor or Wall Assembly** – Min 2-1/2 in. (64 mm) thick reinforced lightweight or normal weight (100-150 pcf or 1600 - 2400 kg/m³) concrete floors or min 3 in. (76 mm) thick reinforced lightweight or normal weight concrete walls. Wall may also be constructed of any UL Classified **Concrete Blocks***. Max diam of opening is 6 in. (152 mm).

See **Concrete Blocks (CAZT)** category in the Fire Resistance Directory for names of manufacturers.

- Steel Sleeve** – (Optional, Not Shown) - Nom 10 in. (254 mm) diam (or smaller) sleeve fabricated from nom 0.019 in. (0.48 mm) thick galv steel cast or grouted into floor or wall assembly flush with floor or wall surfaces.
- Through Penetrants** – One metallic pipe or tubing to be installed either concentrically or eccentrically within the firestop system. Penetrants rigidly supported on both sides of floor or wall assembly. The following types and sizes of metallic pipes or tubing may be used:
 - Steel Pipe** – Nom 3 in. (76 mm) diam (or smaller) Schedule 10 (or heavier) steel pipe.
 - Iron Pipe** – Nom 3 in. (76 mm) diam (or smaller) cast or ductile iron pipe.
 - Copper Tubing** – Nom 3 in. (76 mm) diam (or smaller) Type M (or heavier) copper tube.
 - Copper Pipe** – Nom 3 in. (76 mm) diam (or smaller) Regular (or heavier) copper pipe.

- Pipe Covering** – Nom 1/2 in. to 1 in. (13 mm to 25 mm) thick hollow cylindrical heavy density (min 3.5 pcf or 56 kg/m³) glass fiber units jacketed on the outside with an all service jacket. Longitudinal joints sealed with metal fasteners or factory-applied self-sealing lap tape. Transverse joints secured with metal fasteners or with butt tape supplied with product. Annular space between the pipe covering and periphery of opening shall be min 0 in. (point contact) to max 7/8 in. (0 mm to max 22 mm).

See **Pipe and Equipment Covering – Materials** – (BRGU) category in the Building Materials Directory for names of manufacturers. Any pipe covering material meeting the above specifications and bearing the UL Classification Marking with a Flame Spread Index of 25 or less and a smoke Developed Index of 50 or less may be used.

The T, FT and FTH Ratings are 1/2 hr when nominal 1 in. (25 mm) thick pipe insulation is used. The T, FT and FTH Ratings are 0 hr when pipe insulation thickness is less than nom 1 in. (25 mm).

- Firestop System** – The details of the firestop system shall be as follows:
 - Packing Material** – Min 2 in. (51 mm) thickness of min 4 pcf (64 kg/m³) mineral wool batt insulation firmly packed into opening as a permanent form. Packing material to be recessed from top surface of floor or from both surfaces of wall as required to accommodate the required thickness of fill material.
 - Forming Material*** – As an alternate to the packing material in Item 4A, nom 4 in. (102 mm) wide strips of min 1/2 in (13 mm) thick compressible mat folded in half, lengthwise, and stacked to a thickness greater than the width of the annular space and compression-fitted, edge-first, to fill the annular space to a min 2 in. (51 mm) depth. Top of forming material to be recessed from top surface of floor or from both surfaces of wall as necessary to accommodate the required thickness of caulk fill material.

3M COMPANY

3M FIRE PROTECTION PRODUCTS – Fire Barrier Packing Material

- Fill, Void or Cavity Materials* – Caulk or Sealant** – Min 1/2 in. (13 mm) thickness of fill material applied within the annulus, flush with top surface of floor or with both surfaces of wall. At point contact location between pipe covering and concrete, a min 1/4 in. (6 mm) diam bead of fill material shall be applied at the concrete/pipe covering interface on the top surface of floor or on both sides of wall.

3M COMPANY

3M FIRE PROTECTION PRODUCTS – FireDam-150+ Caulk, CP 25WB+ Caulk, IC 15WB+ Caulk or FB-3000 WT Sealant

*Bearing the UL Classification Mark

Reprinted from the Online Certifications Directory with permission from UL

© 2013 UL LLC



System No. C-AJ-5194

December 10, 2001

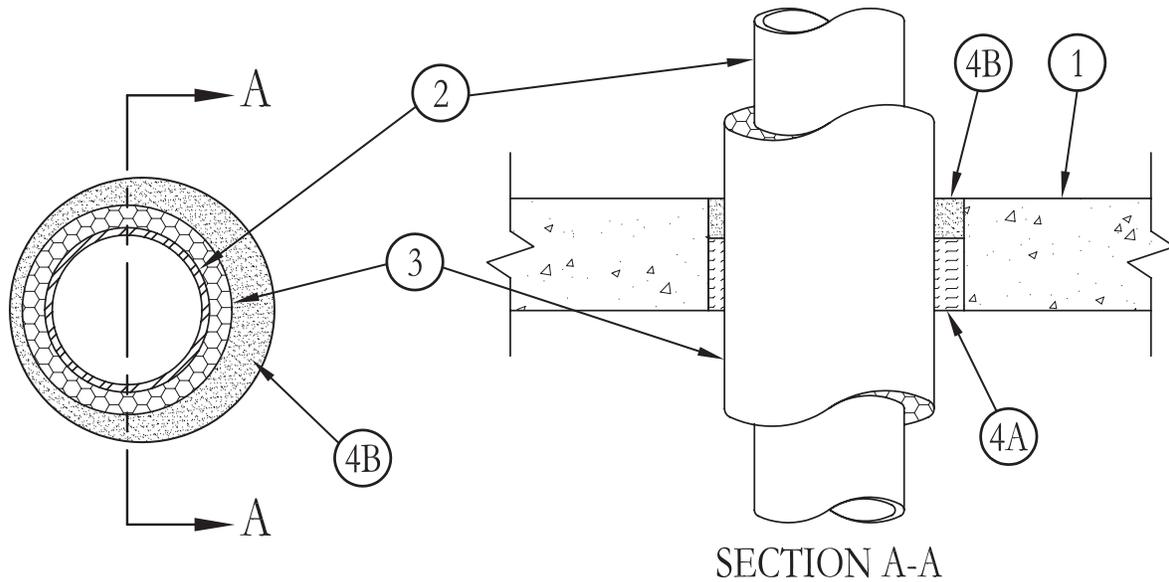
F Ratings – 1-1/2 and 2 Hr (See Item 2)
T Ratings – 1/2, 1 and 1-1/4 Hr (See Item 2)

- Floor or Wall Assembly** – Min 2-1/2 in. thick reinforced lightweight or normal weight (100-150 pcf) concrete floors or min 3-1/4 in. thick reinforced lightweight or normal weight concrete walls. Wall may also be constructed of any UL Classified **Concrete Blocks***. Max diam of opening 11 in.
See **Concrete Blocks (CAZT)** category in the Fire Resistance Directory for names of manufacturers.
- Through Penetrants** – One metallic pipe or tubing to be installed either concentrically or eccentrically within the firestop system. Penetrant to be rigidly supported on both sides of floor or wall assembly. The following types and sizes of metallic pipes or tubings may be used:
 - Steel Pipe** – Nom 6 in. diam (or smaller) Schedule 10 (or heavier) steel pipe.
 - Iron Pipe** – Nom 6 in. diam (or smaller) cast or ductile iron pipe.
 - Copper Tubing** – Nom 2 in. diam (or smaller) Type M (or heavier) copper tube.
 - Copper Pipe** – Nom 2 in. diam (or smaller) Regular (or heavier) copper pipe. **F Rating is 2 hr for 6 in. (or smaller) steel and iron pipes with 1 in. thick pipe covering, 1-1/2 hr for 6 in. (or smaller) steel and iron pipes with 1-1/2 in. thick pipe covering and 1-1/2 hr for 2 in. (or smaller) copper tubing and pipes with 1 in. thick pipe covering. The hourly T Rating is 1/2 hr for 2 in. (or smaller) copper tubing and pipes with 1 in. pipe covering, 1 hr for 6 in. (or smaller) steel and iron pipes with 1 in. pipe covering and 1-1/4 hr for 6 in. (or smaller) steel and iron pipes with 1-1/2 in. pipe covering.**
- Pipe Covering** – Nom 1 in. to 1-1/2 in. thick hollow cylindrical heavy density glass fiber units jacketed on the outside with an all service jacket. Longitudinal joints sealed with metal fasteners or factory-applied self-sealing lap tape. Transverse joints secured with metal fasteners or with butt tape supplied with product. Annular space between the pipe covering and periphery of opening shall be min 1/4 in. to max 1-1/4 in. Steel and iron pipes (Items 2A and 2B) are to be insulated with nom 1 or 1-1/2 in. thick pipe covering. Copper tubing and pipes (Items 2C and 2D) are to be insulated with nom 1 in. thick pipe covering only.
See **Pipe and Equipment Covering – Materials (BRGU)** category in the Building Materials Directory for names of manufacturers. Any pipe covering material meeting the above specifications and bearing the UL Classification Marking with a Flame Spread Index of 25 or less and a smoke Developed Index of 50 or less may be used.
- Firestop System** – The details of the firestop system shall be as follows:
 - Packing Material** – Min thickness of packing material is 2 in. when nom 1 in. thick pipe covering is used. Min thickness of packing material is 1-3/4 in. when nom 1-1/2 in. thick pipe covering is used. Packing material to be min 4 pcf mineral wool batt insulation firmly packed into opening as a permanent form. Packing material to be recessed from top surface of floor or from both surfaces of wall as required to accommodate the required thickness of fill material.
 - Fill, Void or Cavity Materials* – Caulk** – Min 1/2 in. thickness of caulk applied within the annulus, flush with top surface of floor or both surfaces of wall when nom 1 in. thick pipe covering is used. Min 3/4 in. of caulk applied within the annulus, flush with top surface of floor or both surfaces of wall when nom 1-1/2 in. thick pipe covering is used.

3M COMPANY – FireDam 150+

*Bearing the UL Classification Mark

Reprinted from the Online Certifications Directory with permission from Underwriters Laboratories Inc.
Copyright © 2010 Underwriters Laboratories Inc.®

System No. C-AJ-5209

March 05, 2007

F Ratings – 1 and 2 Hr (See Item 3)

T Ratings – 0, 3/4 and 1Hr (See Item 4)

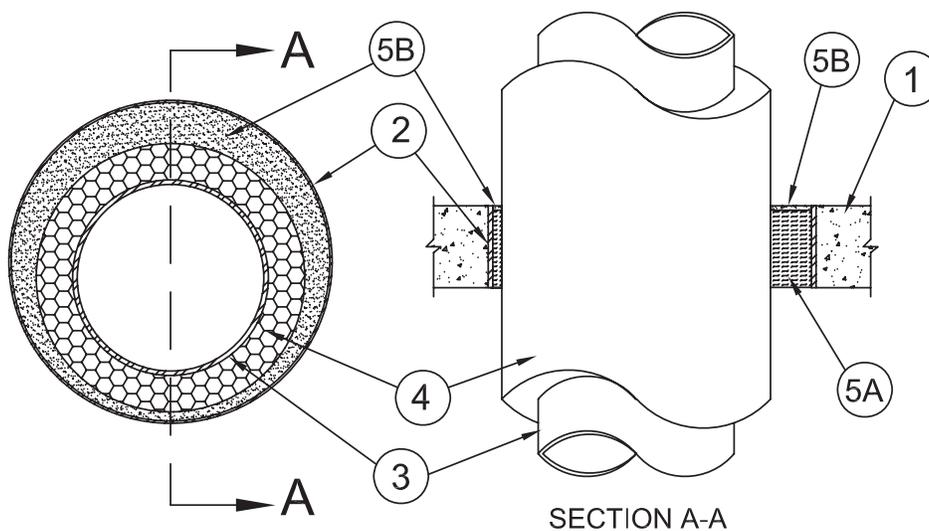

- Floor or Wall Assembly** – Min 2-1/2 in. (64 mm) thick reinforced lightweight or normal weight (100-150 pcf or 1600 - 2400 kg/m³) concrete floors or min 3 in. (76 mm) thick reinforced lightweight or normal weight concrete walls. Wall may also be constructed of any UL Classified **Concrete Blocks***. Max diam of opening 9 in. (229 mm).

See **Concrete Blocks (CAZT)** category in the Fire Resistance Directory for names of manufacturers.

- Steel Sleeve** – (Optional) - Nom 9 in. (229 mm) diam (or smaller) Schedule 10 (or heavier) steel sleeve cast or grouted into floor or wall assembly. Steel sleeve may be installed flush or may project max 2 in. (51mm) beyond the floor or wall surfaces. As an alternate, nom 9 in. (229 mm) diam (or smaller) sleeve fabricated from nom 0.019 in. (0.48 mm) thick galv steel cast or grouted into floor or wall assembly flush with floor or wall surfaces.
- Through Penetrants** – One metallic pipe to be installed concentrically or eccentrically within opening. Penetrant to be rigidly supported on both sides of floor or wall assembly. The following types and sizes of metallic pipes may be used:
 - Steel Pipe** – Nom 4 in. (102 mm) diam (or smaller) Schedule 10 (or heavier) steel pipe.
 - Iron Pipe** – Nom 4 in. (102 mm) diam (or smaller) cast or ductile iron pipe.
 - Copper Tubing** – Nom 2 in. (51 mm) diam (or smaller) Type L (or heavier) copper tubing.
 - Copper Pipe** – Nom 2 in. (51 mm) diam (or smaller) Regular (or heavier) copper pipe.

F Rating is 2 Hr for Penetrants A and B. F Rating is 1 Hr for Penetrants C and D.

- Pipe Covering** – Nom 1-1/2 in. (38 mm) thick (or less) hollow cylindrical heavy density glass fiber units jacketed on the outside with an all service jacket. Longitudinal joints sealed with metal fasteners or factory-applied self-sealing lap tape. Transverse joints secured with metal fasteners or with butt tape supplied with product. Annular space between the pipe covering and periphery of opening or sleeve shall be min 1/2 in. to max 1 in. (13 mm to 25 mm).

See **Pipe and Equipment Covering – Materials** – (BRGU) category in the Building Materials Directory for names of manufacturers. Any pipe covering material meeting the above specifications and bearing the UL Classification Marking with a Flame Spread Index of 25 or less and a smoke Developed Index of 50 or less may be used.

T Rating is 3/4 Hr for nom 1-1/2 in. (38 mm) thick pipe covering for penetrants A and B. T Rating is 1 Hr for nom 1-1/2 in. (38 mm) thick pipe covering for Penetrants C and D. T Rating is 0 Hr for all Penetrants when pipe coverings less than nom 1-1/2 in. (38 mm) thick.

- Firestop System** – The details of the firestop system shall be as follows:
 - Packing Material** – Min 2 in. (51 mm) thickness of min 4 pcf (64 kg/m³) mineral wool batt insulation firmly packed into opening as a permanent form. Packing material to be recessed from top surface of floor or top edge of sleeve or from both surfaces of wall or both ends of sleeve as required to accommodate the required thickness of fill material. In floors constructed of hollow-core concrete, packing material to be recessed from top and bottom surfaces of floor or sleeve as required to accommodate the required thickness of fill material.
 - Fill, Void or Cavity Materials* – Caulk or Sealant** – Min 1/2 in. (13 mm) thickness of caulk applied within the annulus, flush with top surface of floor or top edge of sleeve or with both surfaces of wall or both ends of sleeves. In floors constructed of hollow-core concrete, min 1/2 in. (13 mm) thickness of caulk applied within the annulus, flush with top and bottom surfaces of floor or sleeve. Min 1/4 in. (6 mm) diam bead of caulk applied to the pipe covering/concrete or pipe covering/sleeve interface at the point contact location on the top surface of floor or both surfaces of wall or hollow-core concrete.

3M COMPANY – IC 15WB+, CP 25WB+ Caulk, or FB-3000 WT Sealant

*Bearing the UL Classification Mark

Reprinted from the Online Certifications Directory with permission from Underwriters Laboratories Inc.

Copyright © 2010 Underwriters Laboratories Inc.®



System No. C-AJ-5210

March 15, 2007

F Ratings – 1-1/2 & 2 Hr (See Item 4)

T Ratings – 1/2, 3/4, 1 & 1-1/4 Hr (See Item 4)

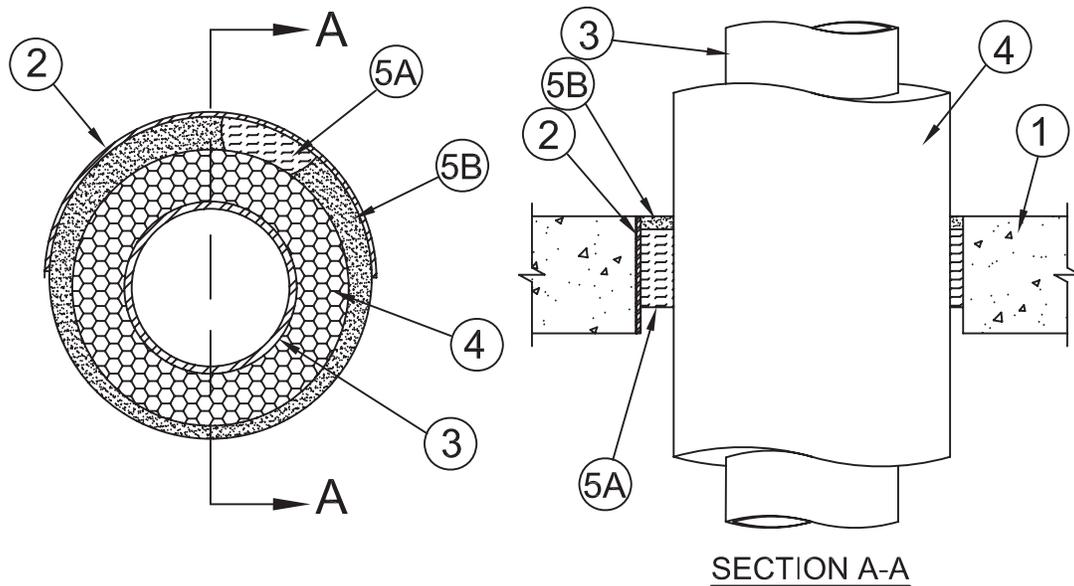

- Floor or Wall Assembly** – Min 4-1/2 in. (114 mm) thick reinforced lightweight or normal weight (100-150 pcf or 1600-2400 kg/m³) concrete. Floor assembly may also be constructed of any min 6 in. (152 mm) thick UL Classified hollow-core **Precast Concrete Units***. Wall may also be constructed of any UL Classified **Concrete Blocks***. Max diam of opening 14 in. (356 mm). Max diam of opening in floors constructed of hollow-core concrete is 7 in. (178 mm).

See **Concrete Blocks (CAZT)** and **Precast Concrete Units (CFTV)** categories in Fire Resistance Directory for names of manufacturers.

- Steel Sleeve** – (Optional) – Nom 14 in. (356 mm) diam (or smaller) Schedule 10 (or heavier) steel sleeve cast or grouted into floor or wall assembly. Steel sleeve may be installed flush or may project max 2 in. (51 mm) beyond the floor or wall surfaces. As an alternate, nom 14 in. (356 mm) diam (or smaller) sleeve fabricated from nom 0.028 in. (0.71 mm) thick galv steel cast or grouted into floor or wall assembly flush with floor or wall surfaces.
- Through Penetrants** – One metallic pipe or tubing to be installed concentrically or eccentrically within opening. Penetrant to be rigidly supported on both sides of floor or wall assembly. The following types and sizes of metallic pipes or tubes may be used:
 - Steel Pipe** – Nom 8 in. (203 mm) diam (or smaller) Schedule 10 (or heavier) steel pipe.
 - Iron Pipe** – Nom 8 in. (203 mm) diam (or smaller) cast or ductile iron pipe.
 - Copper Tubing** – Nom 4 in. (102 mm) diam (or smaller) Type M (or heavier) copper tube.
 - Copper Pipe** – Nom 4 in. (102 mm) diam (or smaller) Regular (or heavier) copper pipe.
- Pipe Covering** – Nom 2 in. (51 mm) thick (or less) hollow cylindrical heavy density glass fiber units jacketed on the outside with an all service jacket. Longitudinal joints sealed with metal fasteners or factory-applied self-sealing lap tape. Transverse joints secured with metal fasteners or with butt tape supplied with product. Annular space between the pipe covering and periphery of opening or sleeve shall be min 1/2 in. to max 1 in. (13 mm to max 25 mm).

See **Pipe and Equipment Covering – Materials – (BRGU)** category in the Building Materials Directory for names of manufacturers. Any pipe covering material meeting the above specifications and bearing the UL Classification Marking with a Flame Spread Index of 25 or less and a smoke Developed Index of 50 or less may be used.

The hourly F and T Ratings are dependent on the type of pipe or tube and the nom thickness of the pipe covering, as shown below:

| Penetrant | Pipe Covering Nom Thickness, in. (mm) | F Rating, Hr | T Rating, Hr |
|-------------|--|--------------|--------------|
| A & B | 2 (51) | 2 | 1-1/4 |
| C & D | 2 (51) | 1-1/2 | 1 |
| A, B, C & D | 1 (25) | 2 | 3/4 |
| A, B, C & D | 1/2 (13) | 2 | 1/2 |

- Firestop System** – The details of the firestop system shall be as follows:
 - Packing Material** – Min 3 in. (76 mm) thickness of min 4 pcf or (64 kg/m³) mineral wool batt insulation firmly packed into opening as a permanent form. Packing material to be recessed from top surface of floor or top edge of sleeve or from both surfaces of wall or both ends of sleeve as required to accommodate the required thickness of fill material. In floors constructed of hollow-core concrete, packing material to be recessed from top and bottom surfaces of floor or sleeve as required to accommodate the required thickness of fill material.

System No. C-AJ-5210 *continued*

A1. **Forming Material*** – As an alternate to the packing material in Item 5A, nom 4 in. (102 mm) wide strips of min 1/2 in (13 mm) thick compressible mat to be stacked to a thickness greater than the width of the annular space and compression-fitted, edge-first, to fill the annular space to a min 4 in. (102 mm) depth. Top of forming material to be recessed from top surface of floor or from both surfaces of wall as necessary to accommodate the required thickness of caulk fill material. In floors constructed of hollow-core concrete, forming material to be recessed from top and bottom surfaces of floor or sleeve as required to accommodate the required thickness of fill material.

3M COMPANY – Fire Barrier Packing Material

B. **Fill, Void or Cavity Materials* – Caulk or Sealant** – Min 1/2 in. (13 mm) thickness of caulk applied within the annulus, flush with top surface of floor or top edge of sleeve or with both surfaces of wall or both ends of sleeves. In floors constructed of hollow-core concrete, min 1/2 in. (13 mm) thickness of caulk applied within the annulus, flush with top and bottom surfaces of floor or sleeve.

3M COMPANY – IC 15WB+, CP 25WB+ caulk or FB-3000 WT sealant

*Bearing the UL Classification Mark

Reprinted from the Online Certifications Directory with permission from Underwriters Laboratories Inc.
Copyright © 2010 Underwriters Laboratories Inc.®



System No. C-AJ-5211

March 28, 2012

ANSI/UL1479 (ASTM E814)
F Rating – 2 Hr
T Ratings – 0 and 1/2 Hr (See Item 4)
W Rating – Class I (See Item 5)

CAN/ULC S115
F Rating – 2 Hr
FT Ratings – 0 and 1/2 Hr (See Item 4)
FH Rating – 2 Hr
FTH Ratings – 0 and 1/2 Hr (See Item 4)

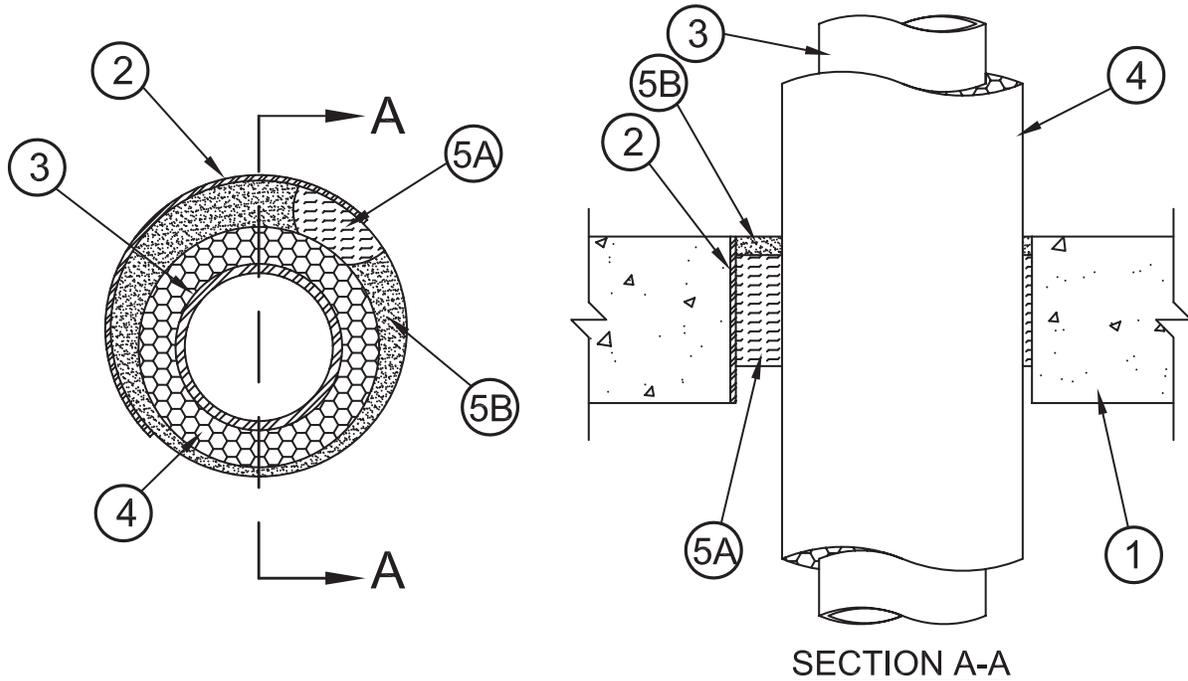

SECTION A-A

- Floor or Wall Assembly** – Min 4-1/2 in. (114 mm) thick reinforced lightweight or normal weight (100-150 pcf or 1600 - 2400 kg/m³) concrete. Floor assembly may also be constructed of any min 6 in. (152 mm) thick UL Classified hollow-core **Precast Concrete Units***. Wall may also be constructed of any UL Classified **Concrete Blocks***. Max diam of opening 8 in. (203 mm) Max diam of opening in floors constructed of hollow-core concrete is 7 in. (178 mm).
See **Concrete Blocks (CAZT)** and **Precast Concrete Units (CFTV)** categories in Fire Resistance Directory for names of manufacturers.
- Steel Sleeve** – (Optional) - Nom 8 in. (203 mm) diam (or smaller) Schedule 10 (or heavier) steel sleeve cast or grouted into floor or wall assembly. Steel sleeve may be installed flush or may project max 2 in. (51 mm) beyond the floor or wall surfaces. As an alternate, nom 8 in. (203 mm) diam (or smaller) sleeve fabricated from nom 0.019 in. (0.48 mm) thick galv steel cast or grouted into floor or wall assembly flush with floor or wall surfaces.
- Through Penetrants** – One metallic pipe to be installed concentrically or eccentrically within opening. Penetrant to be rigidly supported on both sides of floor or wall assembly. The following types and sizes of metallic pipes may be used:
 - Steel Pipe** – Nom 4 in. (102 mm) diam (or smaller) Schedule 10 (or heavier) steel pipe.
 - Iron Pipe** – Nom 4 in. (102 mm) diam (or smaller) cast or ductile iron pipe.
 - Copper Tubing** – Nom 2 in. (51 mm) diam (or smaller) Type L (or heavier) copper tubing.
 - Copper Pipe** – Nom 2 in. (51 mm) diam (or smaller) Regular (or heavier) copper pipe.
- Tube Insulation-Plastics** – Nom 3/4 in. (19 mm) thick (or less) acrylonitrile butadiene/polyvinyl chloride (AB/PVC) flexible foam furnished in the form of tubing. Annular space between the insulated penetrating item and the periphery of the opening shall be min 1/2 in. to max 1-1/2 in. (13 mm to max 38 mm).
See **Plastics (QMFZ2)** category in the Recognized Component Directory for names of manufacturers. Any Recognized Component tube insulation material meeting the above specifications and having a UL 94 Flammability Classification of 94-5A may be used.
The T, FT and FTH Ratings are 1/2 Hr for nom 3/4 in. (19 mm) thick tube insulation. The T, FT and FTH Ratings are 0 Hr for tube insulations less than nom 3/4 in. (19 mm) thick.
- Firestop System** – The details of the firestop system shall be as follows:
 - Packing Material** – Min 3 in. (76 mm) thickness of min 4 pcf or 64 kg/m³ mineral wool batt insulation firmly packed into opening as a permanent form. Packing material to be recessed from top surface of floor or top edge of sleeve or from both surfaces of wall or both ends of sleeve as required to accommodate the required thickness of fill material. In floors constructed of hollow-core concrete, packing material to be recessed from top and bottom surfaces of floor or sleeve as required to accommodate the required thickness of fill material.
 - Forming Material*** – As an alternate to the packing material in Item 5A, nom 4 in. (102 mm) wide strips of min 1/2 in (13 mm) thick compressible mat to be stacked to a thickness greater than the width of the annular space and compression-fitted, edge-first, to fill the annular space to a min 4 in. (102 mm) depth. Top of forming material to be recessed from top surface of floor or from both surfaces of wall as necessary to accommodate the required thickness of caulk fill material. In floors constructed of hollow-core concrete, packing material to be recessed from top and bottom surfaces of floor or sleeve as required to accommodate the required thickness of fill material.

3M COMPANY

3M FIRE PROTECTION PRODUCTS – Fire Barrier Packing Material

System No. C-AJ-5211 *continued*

- B. **Fill, Void or Cavity Materials* – Caulk or Sealant** – Min 1/2 in. (13 mm) thickness of caulk applied within the annulus, flush with top surface of floor or top edge of sleeve or with both surfaces of wall or both ends of sleeves. In floors constructed of hollow-core concrete, min 1/2 in. (13 mm) thickness of caulk applied within the annulus, flush with top and bottom surfaces of floor or sleeve.

3M COMPANY

3M FIRE PROTECTION PRODUCTS – IC 15WB+ Caulk, CP 25WB+ Caulk or FB-3000 WT Sealant

(Note: W Rating applies only when FB-3000 WT is used.)

*Bearing the UL Classification Mark

+ Bearing the UL Recognized Component Mark

Reprinted from the Online Certifications Directory with permission from UL

© 2013 UL LLC



Through Penetrations

Insulated Pipes

5000 Series

Concrete

CAJ

System No. C-AJ-5292

February 26, 2008

F Rating – 2 Hr

T Ratings – 1/2 and 3/4 Hr (See Item 1)

L Rating At Ambient – 4 CFM/sq ft. (See Item 4B)

L Rating At 400 F – Less Than 1 CFM/sq ft. (See Item 4B)

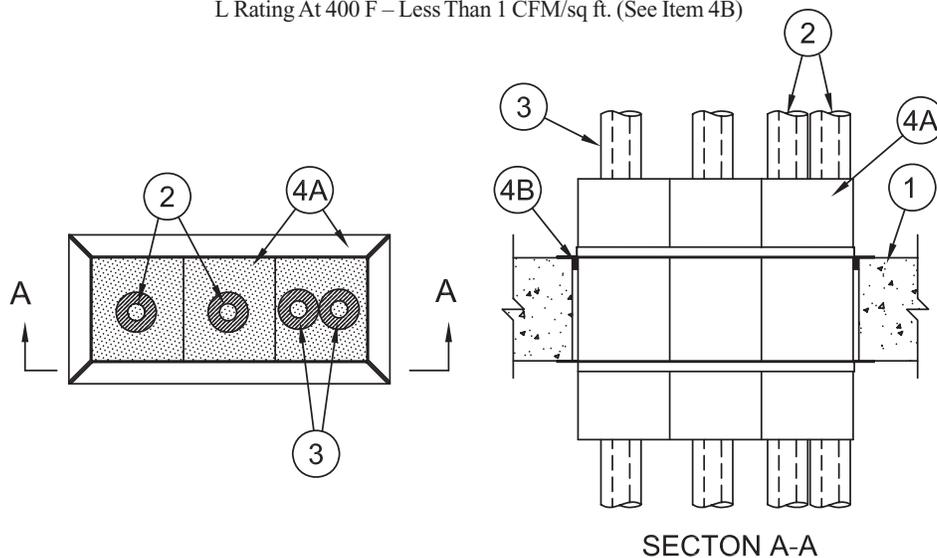

- 1. Floor or Wall Assembly** – Min 2-1/2 in. (64 mm) thick reinforced lightweight or normal weight (100-150 pcf or 1600-2400 kg/m³) concrete. Wall may also be constructed of any UL Classified **Concrete Blocks***. Max area of opening is 56 in.² (363 cm²) with a max dimension of 12-1/2 in. (318 mm) for square devices. Max diam of opening is 2-1/2 in. (64 mm) for 2 in. round devices. Max diam of opening is 4-1/2 in. (114 mm) for 4 in. round devices. **When thickness of floor or wall assembly is less than 4-1/2 in. (114 mm), T Rating is 1/2 Hr. When thickness of floor or wall assembly is 4-1/2 in. (114 mm) or greater, T Rating is 3/4 hr.**

See **Concrete Blocks** (CAZT) category in Fire Resistance Directory for names of manufacturers.

- 2. Through Penetrant** – One or more metallic pipe or tubing with tube insulation may be installed concentrically or eccentrically within each firestop device (Item 4A). Through penetrant to be rigidly supported on both sides of floor or wall assembly. The following types and sizes of through penetrants may be used:
 - A. Steel Pipe** – Nom 3/4 in. (19 mm) diam (or smaller) Schedule 10 (or heavier) steel pipe.
 - B. Iron Pipe** – Nom 3/4 in. (19 mm) diam (or smaller) cast or ductile iron pipe.
 - C. Copper Tubing** – Nom 3/4 in. (19 mm) diam (or smaller) Type L (or heavier) copper tube.
 - D. Copper Pipe** – Nom 3/4 in. (19 mm) diam (or smaller) Regular (or heavier) copper pipe.
- 3. Tube Insulation – Plastic+** – Nom 1/2 in (13 mm) thick or smaller acrylonitrile butadiene/polyvinyl chloride (AB/PVC) flexible foam furnished in the form of tubing with skin may be used on the copper tubes. If multiple insulated through penetrants are installed within the firestop device, the insulated through penetrants may be bundled together.

See **Plastics+** (QMFZ2) category in the Plastics Recognized Component Directory for names of manufacturers. Any Recognized Component tube insulation material meeting the above specifications and having a UL 94 Flammability Classification of 94-5VA may be used.

- 4. Firestop System** – The firestop system shall consist of the following:
 - A. Firestop Device*** – A max of three square firestop devices may be ganged together. As an alternate, one round device may be centered within a round opening. Each device consists of a nom 2-1/2 by 2-1/2 by 10 in. (64 by 64 by 254 mm), a nom 4 by 4 by 10 in. (102 by 102 by 254 mm), a nom 2 in. (51 mm) diam by 10 in. (254 mm) or a nom 4 in. (102 mm) diam by 10 in. (254 mm) powder coated steel transit incorporating internal intumescent material, foam gaskets and mounting flanges. Firestop device to be centered within opening and installed with ends projecting an equal distance beyond each surface of the floor or wall assembly in accordance with the accompanying installation instructions. The annular space between the firestop device(s) and the periphery of the opening shall be nom 1/4 in. (6 mm). Firestop devices secured in place by means of fill material (Item 4B) and steel split mounting flanges sized to accommodate the firestop device. Steel split mounting flanges installed on both sides of floor or wall after installation of fill material and secured to together with supplied steel set screws. Nom 1 in. (25 mm) thick pre-cut foam plugs sized to accommodate the insulated through penetrant(s) and installed flush with each end of device on both sides of floor or wall assembly.
 - B. Fill, Void or Cavity Materials* – Caulk or Putty** – Min 1 in. (25 mm) thickness of fill material applied within the annulus, flush with top surface of floor or with both surfaces of wall prior to the installation of the mounting flanges. When the annular space is 1/8 in. (3.2 mm) or less, the fill material in the annulus is optional. Also, as an option, the foam plugs may be recessed into device and the recess filled with putty or caulk flush with the ends of the device. L Rating applies only when fill material is applied at interface of floor or both sides of wall and device(s) prior to mounting flanges and with both ends of firestop device(s) filled with nominal 1/8 in. (3.2 mm) of Moldable Putty+.

3M COMPANY – 3M Fire Barrier Pass-Through Device

*Bearing the UL Classification Mark

Reprinted from the Online Certifications Directory with permission from Underwriters Laboratories Inc.

Copyright © 2010 Underwriters Laboratories Inc.®



System No. C-AJ-5310

June 14, 2007

F Rating – 2 Hr

T Ratings – 0 and 1 Hr (See Item 3)

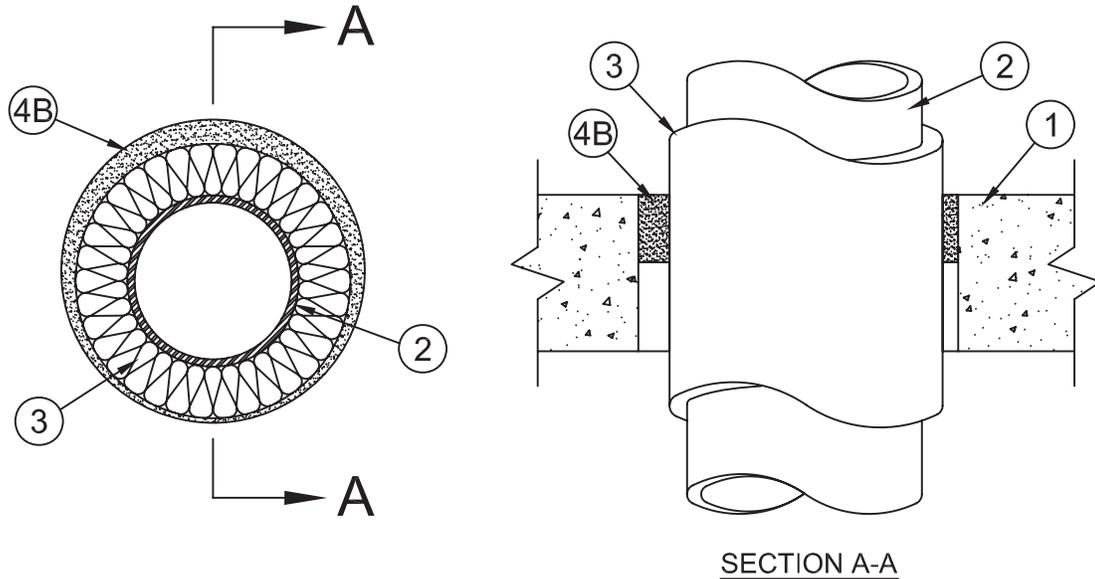

- Floor or Wall Assembly** – Min 4-1/2 in. (114 mm) thick reinforced lightweight or normal weight (100-150 pcf or 1600-2400 kg/m³) concrete. Floor assembly may also be constructed of any min 6 in. (152 mm) thick UL Classified hollow-core **Precast Concrete Units***. Wall may also be constructed of any UL Classified **Concrete Blocks***. Diam of opening to be nom 2 in. (51 mm) larger than outside diam of pipe covering material (Item 3). Max diam of opening 12 in. (305 mm). Max diam of opening in floors constructed of hollow-core concrete is 7 in. (178 mm).

See **Concrete Blocks (CAZT)** and **Precast Concrete Units (CFTV)** categories in Fire Resistance Directory for names of manufacturers.

- Through Penetrants** – One metallic pipe or tubing to be installed concentrically or eccentrically within opening. Penetrant to be rigidly supported on both sides of floor or wall assembly. The following types and sizes of metallic pipes or tubes may be used:
 - Steel Pipe** – Nom 4 in. (102 mm) diam (or smaller) Schedule 10 (or heavier) steel pipe.
 - Iron Pipe** – Nom 4 in. (102 mm) diam (or smaller) cast or ductile iron pipe.
 - Copper Tubing** – Nom 4 in. (102 mm) diam (or smaller) Type M (or heavier) copper tube.
 - Copper Pipe** – Nom 4 in. (102 mm) diam (or smaller) Regular (or heavier) copper pipe.
- Pipe Covering** – Nom 3 in. (76 mm) thick (or less) hollow cylindrical heavy density glass fiber units jacketed on the outside with an all service jacket. Longitudinal joints sealed with metal fasteners or factory-applied self-sealing lap tape. Transverse joints secured with metal fasteners or with butt tape supplied with product. Annular space between the pipe covering and periphery of opening or sleeve shall be min 3/8 in. (10 mm) to max 1-1/2 in. (38 mm). **When pipe covering material thickness is less than 3 in. (76 mm), T Rating is 0 Hr.**

See **Pipe and Equipment Covering – Materials (BRGU)** category in the Building Materials Directory for names of manufacturers. Any pipe covering material meeting the above specifications and bearing the UL Classification Marking with a Flame Spread Index of 25 or less and a smoke Developed Index of 50 or less may be used.

- Firestop System** – The details of the firestop system shall be as follows:
 - Packing Material** – (Optional, Not Shown) - Polyethylene backer rod or nom 1 in. (25 mm) thickness of tightly-packed mineral wool batt or glass fiber insulation firmly packed into opening as a permanent form. Packing material to be recessed from top surface of floor or from both surfaces of wall as required to accommodate the required thickness of fill material. In floors constructed of hollow-core concrete, packing material to be recessed from top and bottom surfaces of floor or sleeve as required to accommodate the required thickness of fill material.
 - Forming Material*** – As an alternate to the packing material in Item 5A, nom 4 in. (102 mm) wide strips of min 1/2 in (13 mm) thick compressible mat folded in half lengthwise and stacked to a thickness greater than the width of the annular space and compression-fitted, edge-first, to fill the annular space to a min 2 in. (51 mm) depth. Top of forming material to be recessed from top surface of floor or from both surfaces of wall as necessary to accommodate the required thickness of caulk fill material. In floors constructed of hollow-core concrete, forming material to be recessed from top and bottom surfaces of floor or sleeve as required to accommodate the required thickness of fill material.

3M COMPANY – Fire Barrier Packing Material

- Fill, Void or Cavity Materials* – Sealant** – Min 2 in. (51 mm) thickness of sealant applied within the annulus, flush with top surface of floor or with both surfaces of wall. In floors constructed of hollow-core concrete, min 2 in. (51 mm) thickness of sealant applied within the annulus, flush with top and bottom surfaces of floor or sleeve.

3M COMPANY – FB-3000 WT

*Bearing the UL Classification Mark

Reprinted from the Online Certifications Directory with permission from Underwriters Laboratories Inc.

Copyright © 2010 Underwriters Laboratories Inc.®





UL System No. C-AJ-5330
XHEZ - Through-penetration Firestop Systems

March 27, 2009

F Rating — 2 Hr

T Rating — 1-1/4 and 1-1/2 Hr (See Item 2)

L Rating at Ambient — Less Than 1 CFM/sq ft

L Rating at 400 F— 3 CFM/sq ft

W Rating - Class 1 (See Item 4A)

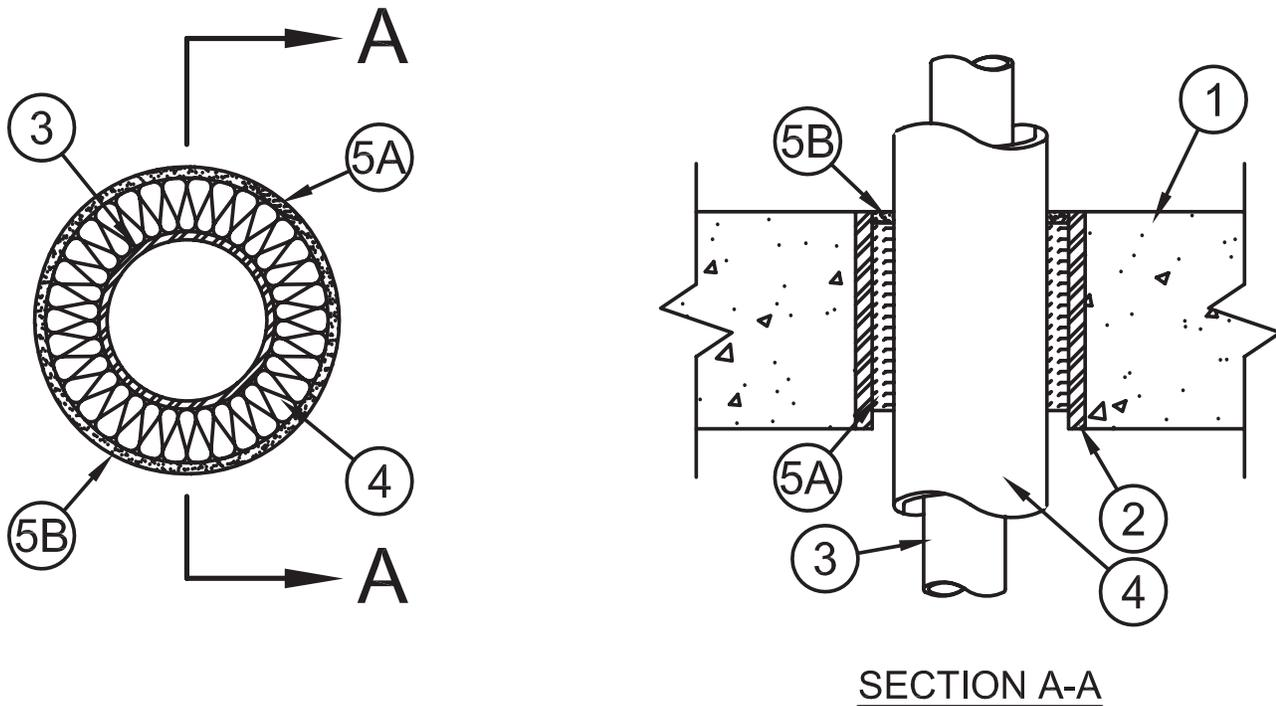

- 1. Floor or Wall Assembly** – Min 4-1/2 in. (114 mm) thick reinforced lightweight or normal weight (100-150 pcf or 1600-2400 kg/m³) concrete. Wall may also be constructed of any UL Classified **Concrete Blocks***. Max diam of opening is 6 in. (152 mm).

See **Concrete Blocks (CAZT)** category in the Fire Resistance Directory for names of manufacturers.

- 2. Steel Sleeve** – (Optional)-Nom 6 in. (152 mm) diam (or smaller) Schedule 40 (or heavier) steel sleeve cast or grouted into floor or wall assembly. **The T Rating is 1-1/4 Hr when sleeve is used, 1-1/2 Hr when no sleeve is used.**

- 3. Through-Penetrant** – One metallic pipe, or tubing to be centered within the firestop system. Pipe, or tubing to be rigidly supported on both sides of floor or wall assembly. The following types and sizes of metallic pipes, or tubing may be used:

- A. Steel Pipe** – Nom 3 in. (76 mm) diam (or smaller) Schedule 10 (or heavier) steel pipe.
- B. Iron Pipe** – Nom 3 in. (76 mm) diam (or smaller) service weight (or heavier) cast iron soil pipe or Class 50 (or heavier) ductile iron pressure pipe.
- C. Copper Tubing** – Nom 3 in. (76 mm) diam (or smaller) Type M (or heavier) copper tubing.
- D. Copper Pipe** – Nom 3 in. (76 mm) diam (or smaller) Regular (or heavier) copper pipe.

- 4. Pipe Covering*** – Max 1 in. (25 mm) thick hollow cylindrical heavy density (min 3.5 pcf or 56 kg/m³) glass fiber units jacketed on the outside with an all service jacket. Longitudinal joints sealed with metal fasteners or factory-applied self-sealing lap tape. Transverse joints secured with metal fasteners or with butt tape supplied with the product. A nom annular space of 7/16 in. (11 mm) is required within the firestop system.

See **Pipe and Equipment Covering - Materials (BRGU)** category in the Building Materials Directory for names of manufacturers. Any pipe covering material meeting the above specifications and bearing the UL Classification Marking with a Flame Spread Index of 25 or less and a Smoke Developed Index of 50 or less may be used.

UL System No. C-AJ-5330 (cont.)

4A. PVC Jacket+ – (Optional, Not Shown) - An additional PVC jacket, supplied in sheet form, shall be tightly wrapped around the all service jacket on the pipe covering with the longitudinal seam continuously sealed using the adhesive supplied with the jacket. The jacket is to be nom 48 in. (1.22 m) wide by nom 20 or 30 mil (0.5 or 0.8 mm) thick. The jacket shall extend downward into and/or through the opening from a point 36 to 40 in. (0.91 to 1.02 m) above the top surface of the floor assembly. **The PVC jacket must be used for the W Rating to apply. The W Rating applies only with floor assemblies.**

See **Plastics** (QMFZ2) category in the Plastics Recognized Component Directory for names of manufacturers. Any Recognized Component plastic material meeting the above specifications and having a UL 94 Flammability Classification of 94-5VA may be used.

5. Firestop System – The details of the firestop system shall be as follows:

- A. Packing Material** – Min 3-3/4 in. (95 mm) thickness of min 4 pcf (64 kg/m³) mineral wool batt insulation firmly packed into opening as a permanent form. Packing material to be recessed from top surface of floor or from both surfaces of wall as required to accommodate the required thickness of fill material.
- B. Fill, Void or Cavity Materials*-Sealant** – Min 1/4 in. (6 mm) thickness of fill material applied within the annulus, flush with top surface of floor or with both surfaces of wall. I.

3M COMPANY 3M FIRE PROTECTION PRODUCTS — FB-3000 WT sealant

Through Penetrations

Insulated Pipes

5000 Series

Concrete

CAJ



*Indicates such products shall bear the UL or cUL Certification Mark for jurisdictions employing the UL or cUL Certification (such as Canada), respectively.

3M Industrial Adhesive and Tapes
Fire Protection Products
3M Center, Building 230-B-S-37
St. Paul, MN 55144-1000

System No. C-AJ-5347

August 01, 2013

ANSI/UL1479 (ASTM E814)

F Ratings – 2 Hr

T Rating – 3/4 Hr

L Rating at Ambient - Less than 1 CFM/sq ft

L Rating at 400 F - Less than 1 CFM/sq ft

CAN/ULC S115

F Ratings – 2 Hr

FT Rating – 3/4 Hr

FH Ratings – 2 Hr

FTH Rating – 3/4 Hr

L Rating at Ambient - Less than 1 CFM/sq ft

L Rating at 400 F - Less than 1 CFM/sq ft

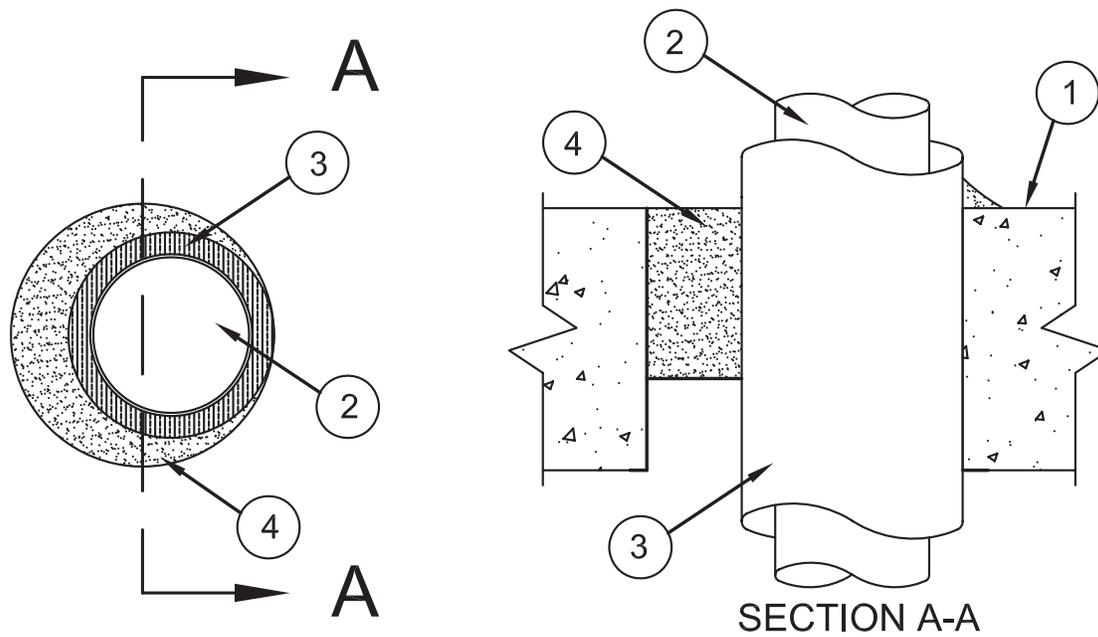

- Floor or Wall Assembly** – Min 2-1/2 in. (64 mm) thick lightweight or normal weight (100-150 pcf or 1600-2400 kg/m³) concrete. Max diam of opening is 12-1/2 in. (318 mm).
- Through-Penetrant** – One metallic pipe, conduit or tubing installed either concentrically or eccentrically within the firestop system. Pipe, conduit or tubing to be rigidly supported on both sides of floor. The following types and sizes of metallic pipes, conduits or tubing may be used:
 - Steel Pipe** – Nom 8 in. (203 mm) diam (or smaller) Schedule 10 (or heavier) steel pipe.
 - Iron Pipe** – Nom 8 in. (203 mm) diam (or smaller) service weight (or heavier) cast iron soil pipe, nom 12 in. diam (or smaller) or Class 50 (or heavier) ductile iron pressure pipe.
 - Conduit** – Nom 6 in. (152 mm) diam (or smaller) steel conduit or nom 4 in. (102 mm) diam (or smaller) steel electrical metallic tubing.
 - Copper Tubing** – Nom 4 in. (102 mm) diam (or smaller) Type L (or heavier) copper tubing.
 - Copper Pipe** – Nom 4 in. (102 mm) diam (or smaller) Regular (or heavier) copper pipe.
- Pipe and Equipment Covering Materials*** – Nom 1 in. (25 mm) thick hollow cylindrical heavy density (nom 3.5 pcf or 56 kg/m³) glass fiber units jacketed on the outside with an all service jacket. Longitudinal joints sealed with metal fasteners or factory-applied self-sealing lap tape. Transverse joints secured with metal fasteners or butt tape supplied with the product. Annular space between the insulated through penetrant and periphery of opening shall be min 0 in. (point contact) to max 1-7/8 in. (48 mm).

See **Pipe and Equipment Covering Materials** (BRGU) category in the Building Materials Directory for names of manufacturers. Any pipe covering material meeting the above specifications and bearing the UL Classification Marking with a Flame Spread Index of 25 or less and a Smoke Developed Index of 50 or less may be used.
- Fill, Void or Cavity Material*** – **Foam** – Min 2-1/2 in. (64 mm) thickness of fill material applied within the annulus, flush with top surface of floor or both surfaces of wall.

3M COMPANY – Fire Barrier Rated Foam, FIP 1-Step

*Bearing the UL Classification Mark

Reprinted from the Online Certifications Directory with permission from UL
© 2013 UL LLC



System No. C-BJ-5002

September 07, 2004

(Formerly System No. 91)

F Rating – 4 Hr

T Rating – 1/2 Hr

L Rating At Ambient – 2 CFM/sq ft

L Rating At 400 F – Less Than 1 CFM/sq ft

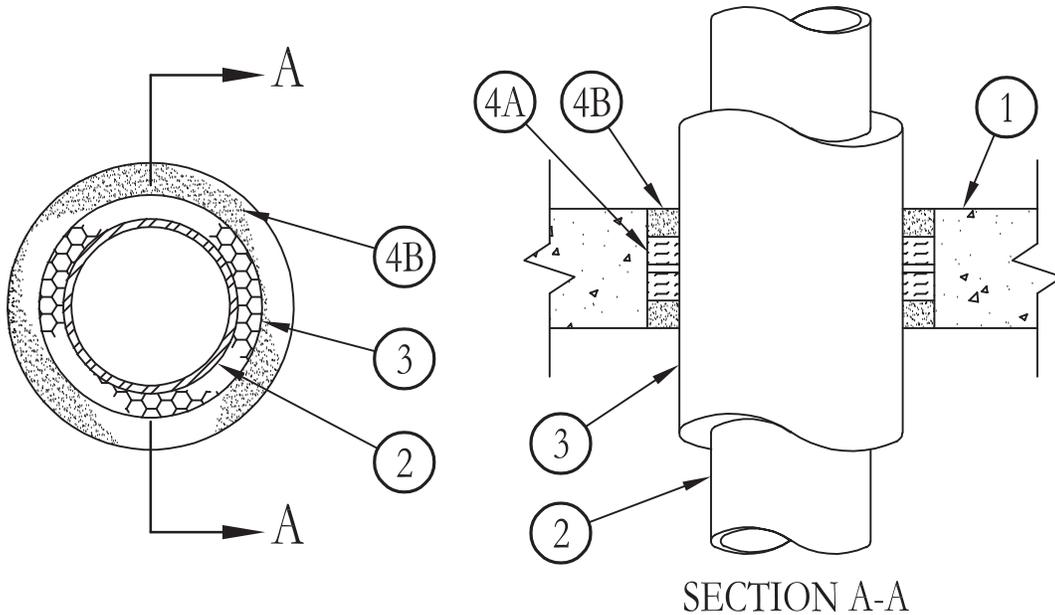

1. **Floor or Wall Assembly** – Min 5-1/2 in. thick reinforced lightweight or normal weight (100-150 pcf) concrete. Wall may also be constructed of any UL Classified **Concrete Blocks***. Diam of opening to be 1-1/4 in. to 1-3/4 in. larger than outside diam of insulated pipe. Max diam of opening is 12 in.

See **Concrete Blocks (CAZT)** category in the Fire Resistance Directory for names of manufacturers.

2. **Pipe** – Nom 4 in. diam (or smaller) Type L (or heavier) copper pipe or nom 6 in. diam (or smaller) Schedule 10 (or heavier) steel pipe centered in the opening and rigidly supported on both sides of the floor or wall assembly.
3. **Pipe Covering*** – Nom 1 or 2 in. thick hollow cylindrical heavy density glass fiber units jacketed on the outside with an all service jacket. Longitudinal joints sealed with metal fasteners or factory-applied self-sealing lap tape. Transverse joints secured with metal fasteners or with butt strip tape supplied with the product.

See **Pipe and Equipment Covering – Materials*** (BRGU) category in Building Materials Directory for names of manufacturers. Any pipe covering material meeting the above specifications and bearing the UL Classification Marking with a Flame Spread Index of 25 or less and a Smoke Developed Index of 50 or less may be used.

4. **Firestop System** – The details of the firestop system shall be as follows:

A. **Packing Material** – Min 1 in. thickness of tightly-packed mineral wool batt insulation firmly packed into opening as a permanent form on both sides of floor or wall assembly. Packing material to be recessed min 1 in. from both surfaces of floor or wall assembly.

B. **Fill, Void or Cavity Materials* – Caulk or Sealant** – Applied to fill the annular space to a min depth of 1 in., flush with both surfaces of floor or wall assembly.

3M COMPANY – CP 25WB+ caulk or FB-3000 WT sealant.

*Bearing the UL Classification Marking

Reprinted from the Online Certifications Directory with permission from Underwriters Laboratories Inc.

Copyright © 2010 Underwriters Laboratories Inc.®



System No. C-BJ-5003

September 07, 2004

(Formerly System No. 91-E)

F Rating – 4 Hr

T Ratings – 1 and 2 Hr (See Item 2)

L Rating At Ambient – 2 CFM/sq ft

L Rating At 400 F – Less Than 1 CFM/sq ft

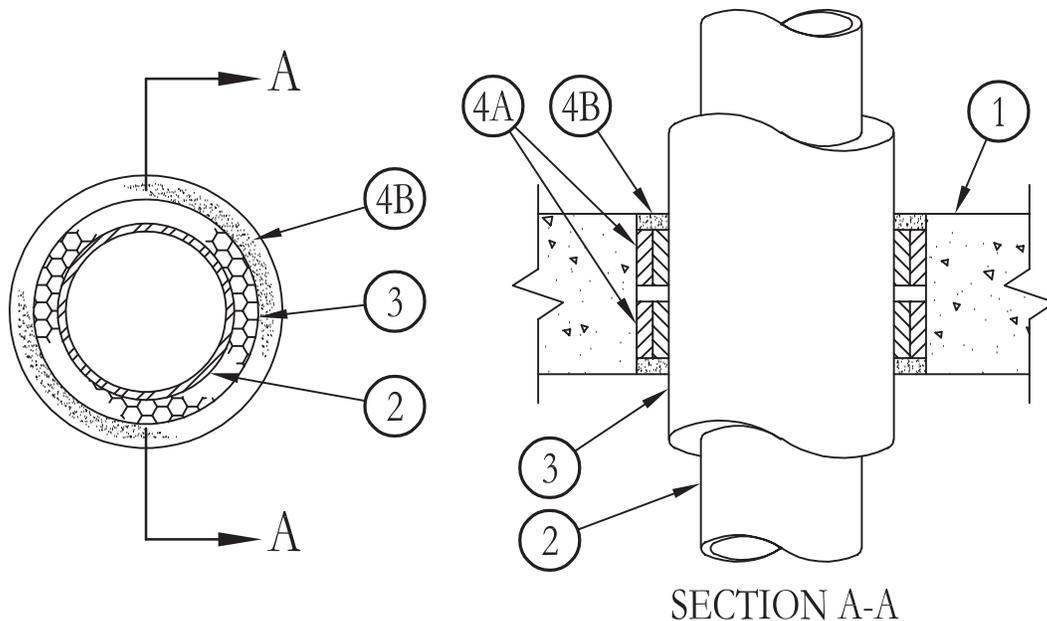

- Floor or Wall Assembly** – Min 5-1/2 in. thick reinforced lightweight or normal weight (100-150 pcf) concrete. Wall may also be constructed of any UL Classified **Concrete Blocks***. Diam of opening to be 1 in. to 1-1/4 in. larger than outside diam of insulated pipe. Max diam of opening is 18 in.
See **Concrete Blocks (CAZT)** category in the Fire Resistance Directory for names of manufacturers.
- Pipe** – Nom 4 in. diam (or smaller) Type L (or heavier) copper pipe or nom 12 in. diam (or smaller) Schedule 10 (or heavier) steel pipe centered in the opening and rigidly supported on both sides of the floor or wall assembly. **When max 6 in. diam pipe is used, T Rating is 2 hr. When pipe is larger than 6 in. diam, T Rating is 1 hr.**
- Pipe Covering*** – Nom 1 or 2 in. thick hollow cylindrical heavy density glass fiber units jacketed on the outside with an all service jacket. Longitudinal joints sealed with metal fasteners or factory-applied self-sealing lap tape. Transverse joints secured with metal fasteners or with butt strip tape supplied with the product.
See **Pipe and Equipment Covering – Materials*** (BRGU) category in Building Materials Directory for names of manufacturers. Any pipe covering material meeting the above specifications and bearing the UL Classification Marking with a Flame Spread Index of 25 or less and a Smoke Developed Index of 50 or less may be used.
- Firestop System** – The details of the firestop system shall be as follows:
 - Fill, Void or Cavity Materials* – Wrap Strip** – Nom 1/4 in. thick intumescent elastomeric material faced on one side with aluminum foil, supplied in 2 in. wide by 24 in. long strips. Two layers of the nom 2 in. wide strips tightly-wrapped around pipe covering (foil side exposed) and slid into annular space on each side of the floor or wall assembly such that the exposed edges are recessed 1/4 to 1/2 in. from the floor or wall surfaces. Each layer is to be installed with a butted seam secured with aluminum foil tape.
3M COMPANY – FS-195+
 - Fill, Void or Cavity Materials* – Caulk or Sealant** – Applied to fill the annular space (over edges of wrap strip layers) to a depth of 1/4 to 1/2 in., flush with both surfaces of floor or wall.
3M COMPANY – CP 25WB+ caulk or FB-3000 WT sealant.

*Bearing the UL Classification Marking

Reprinted from the Online Certifications Directory with permission from Underwriters Laboratories Inc.
Copyright © 2010 Underwriters Laboratories Inc.®



System No. F-A-5001

May 18, 2005

F Rating – 2 Hr

T Rating – 0 Hr

L Rating At Ambient – 2 CFM/sq ft

L Rating At 400 F – Less Than 1 CFM/sq ft

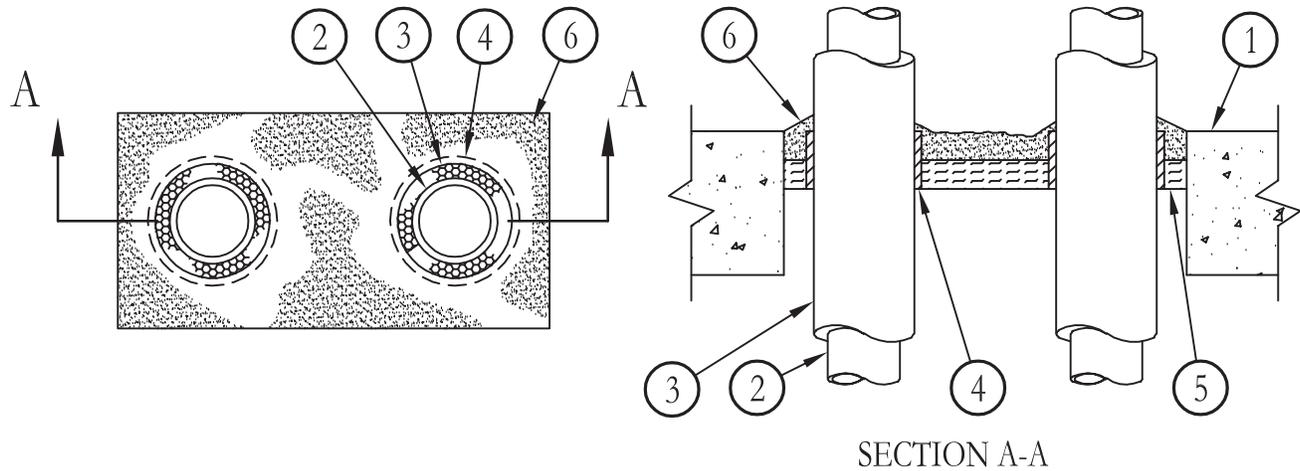

1. **Floor Assembly** – Min 4-1/2 in. (114 mm) thick lightweight or normal weight (100-150 pcf or 1600-2400 kg/m³) concrete. Max area of opening 192 sq in. (1239 cm²) with max length of 24 in. (610 mm) and max width of 8 in. (203 mm).
2. **Pipe** – Nom 4 in. (102 mm) diam (or smaller) Type L (or heavier) copper tubing, Schedule 10 (or heavier) steel pipe, steel conduit or steel EMT to be installed with a min clearance of 1 in. (25 mm) and a max clearance of 2 in. (51 mm) from the sides of the through opening. A min separation of 1 in. (25 mm) shall be maintained between adjacent pipes. Pipes to be rigidly supported on both sides of floor assembly.
3. **Pipe Covering** – Nom 1/2 in. to 1 in. (13 mm to 25 mm) thick hollow cylindrical heavy density glass fiber units jacketed on the outside with an all service jacket. Longitudinal joints sealed with metal fasteners or factory-applied self-sealing lap tape. Transverse joints secured with metal fasteners or with butt strip tape supplied with the product.
See **Pipe and Equipment Covering – Materials*** (BRGU) category in Building Materials Directory for names of manufacturers. Any pipe covering material meeting the above specifications and bearing the UL Classification Marking with a Flame Spread Index of 25 or less and a Smoke Developed Index of 50 or less may be used.
- 3A. **Pipe Insulation – Plastics** – As an alternate to Item 3, nom 3/4 in. (19 mm) thick acrylonitrile butadiene/polyvinyl chloride (AB/PVC) flexible foam furnished in the form of tubing with skin may be used on steel pipes.
See **Plastics (QMFZ2)** category in the Recognized Component Directory for names of manufacturers. Any Recognized Component tube insulation material meeting the above specifications and having a UL94 Flammability Classification of 94-5VA may be used.
4. **Fill, Void or Cavity Materials* – Wrap Strip** – Nom 1/4 in. (6 mm) thick intumescent elastomeric material faced on one side with aluminum foil, supplied in 2 in. (51 mm) wide strips. Nom 2 in. (51 mm) wide strip tightly-wrapped around pipe insulation (Item 3 or 3A) with the foil side exposed and slid into through opening such that the top edge is flush with the top surface of the floor. The wrap strip layer shall be secured in place with min No. 18 gauge galv steel tie wire.
3M COMPANY – FS-195+
5. **Packing Material** – Min 1 in. (25 mm) thick mineral wool batt material insulation firmly packed into opening as a permanent form with its top surface recessed min 1 in. (25 mm) from top surface of floor.
6. **Fill, Void or Cavity Materials* – Caulk or Sealant** – Applied to fill through opening to a min depth of 1 in. (25 mm), flush with top surface of floor, with a min 1/8 in. (3.2 mm) thickness of caulk applied over top edge of wrap strip layer (Item 4) on insulated pipe.
3M COMPANY – IC 15WB+, CP 25WB+ caulk or FB-3000 WT sealant.

*Bearing the UL Classification Marking

Reprinted from the Online Certifications Directory with permission from Underwriters Laboratories Inc.
Copyright © 2010 Underwriters Laboratories Inc.®



System No. F-A-5013

December 14, 2012

F Rating – 3 Hr

T Rating – 1/2 Hr

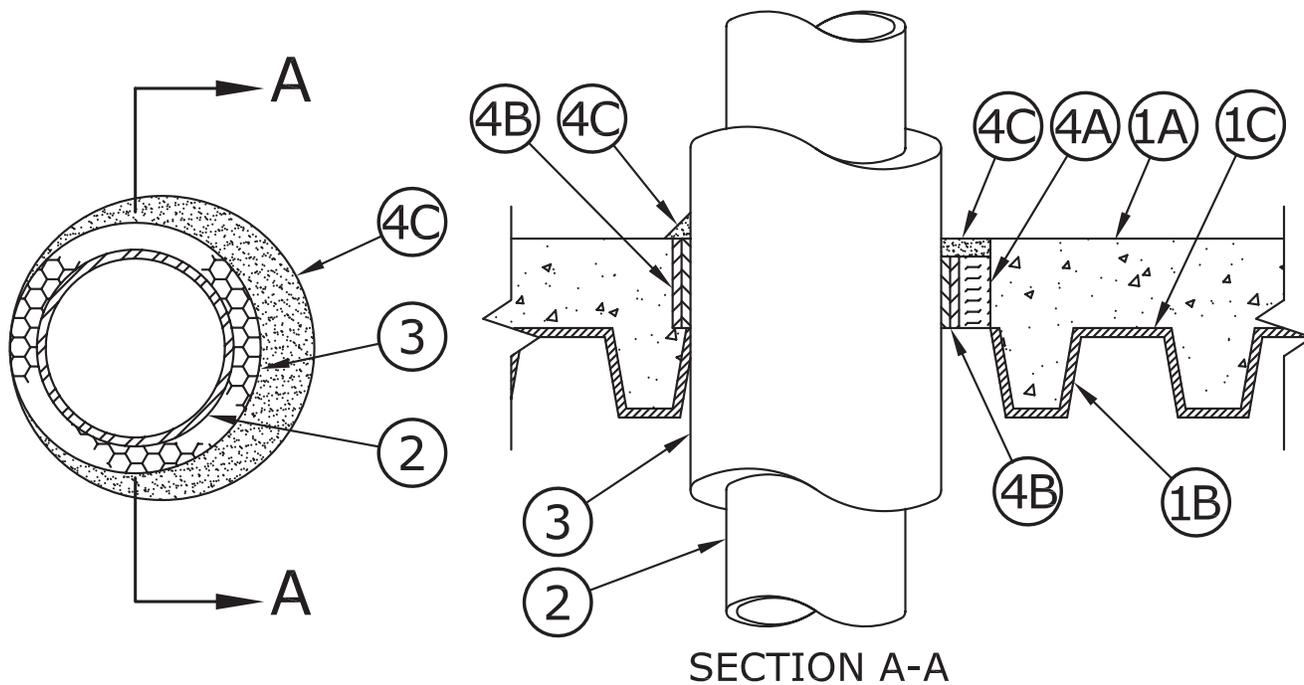

- Floor Assembly** – The 3 Hr fire-rated concrete and steel floor assembly shall be constructed of the materials and in the manner specified in the individual D700 Series designs in the UL Fire Resistance Directory and as summarized below:

A. **Concrete** – Min 3 in. (76 mm) thick reinforced lightweight or normal weight (100-150 pcf or 1600 -2400 kg/m³) concrete.

B. **Steel Floor and Form Units*** – Composite or non composite 3 in. (76 mm) deep fluted galv units as specified in the individual floor-ceiling design. Max size of opening is 14 in. (356 mm).

C. **Spray-Applied Fire Resistive Materials*** – Min 11/16 in. (17.5 mm) thickness spray-applied fire resistive material applied to all surfaces of steel floor units.

W R GRACE & CO - CONN – Type MK-6/HY

- Through Penetrants** – One metallic pipe to be centered within the opening. The pipe to be rigidly supported on both sides of the floor assembly. The following types and sizes of nonmetallic pipe or conduit may be used:

A. **Steel Pipe** – Nom 10 in. (254 mm) diam (or smaller) Schedule 10 steel pipe.

B. **Iron Pipe** – Nom 10 in. (254 mm) diam (or smaller) cast or ductile iron pipe.

C. **Copper Tubing** – Nom 4 in. (102 mm) diam (or smaller) Type L (or heavier) copper tubing.

D. **Copper Pipe** – Nom 4 in. (102 mm) diam (or smaller) Regular (or heavier) copper pipe.

- Pipe Covering*** – Nom 1 in. (25 mm) thick hollow cylindrical heavy density (min 3.5 pcf or 56 kg/m³) glass fiber units jacketed on the outside with an all-service jacket. Longitudinal joints sealed with metal fasteners or factory-applied self-sealing lap tape. Transverse joints secured with metal fasteners or with butt tape supplied with the product. A nom annular space of 1/2 in. (13 mm) is required within the firestop system.

See **Pipe and Equipment Covering Materials (BRGU)** category in the Building Materials Directory for names of manufacturers. Any pipe covering material meeting the above specifications and bearing the UL Classification Marking with a Flame Spread Index of 25 or less and a Smoke Developed Index of 50 or less may be used.

- Firestop System** – The firestop system shall consist of the following:

A. **Packing Material** – Min 2-1/2 in. (38 mm) thickness of min 4 pcf or 64 kg/m³ density mineral wool batt insulation firmly packed into the annular space and recessed to accommodate the required thickness of fill material.

B. **Fill, Void or Cavity Materials*–Wrap Strip** – Nom 1/8 in. (3.2 mm) thick intumescent material supplied in 2 in. (51 mm) wide strips. Wrap strip tightly wrapped around pipe and secure with one layer of aluminum foil tape. Wrap strip to be recessed into opening 1/2 in. (13 mm) from top surface of floor.

3M COMPANY – Ultra GS

C. **Fill, Void or Cavity Materials* – Caulk or Sealant** – Min 1/2 in. (13 mm) thickness of caulk applied within the annulus, flush with the top surface of the floor.

3M COMPANY – CP 25WB+, IC 15WB+ caulk or FB-3000 WT sealant

*Bearing the UL Classification Mark

Reprinted from the Online Certifications Directory with permission from UL

© 2013 UL LLC





UL System No. F-A-5028
XHEZ – Through-penetration Firestop Systems

April 12, 2017

F Rating – 3 Hr

T Ratings – 1/2, 3/4, 1-3/4, 2-3/4 and 3 Hr (See Item 4)

L Rating at Ambient – Less Than 1 CFM/sq ft (See Item 5A)

L Rating at 400° F – Less Than 1 CFM/sq ft (See Item 5A)

W Rating – Class 1 (See Items 4B and 5A)

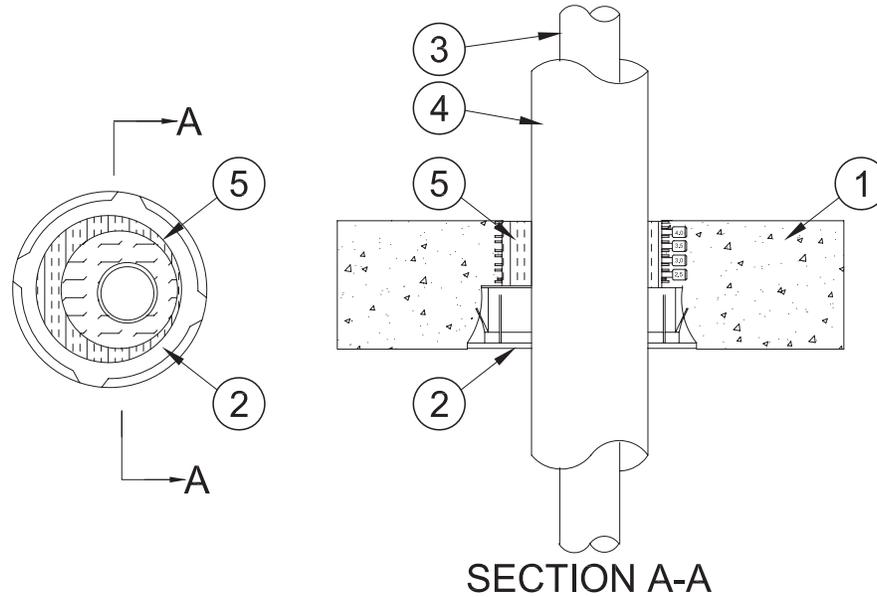

- 1. Floor Assembly** – Min 4-1/2 in. (114 mm) thick reinforced lightweight or normal weight (100-150 pcf or 1600 - 2400 kg/m³) concrete.
- 2. Firestop Device*** – Cast in place firestop device permanently embedded during concrete placement or grouted in concrete assembly in accordance with accompanying installation instructions. The device may be trimmed flush with top surface of floor or may project up to a max 3-1/2 in. (89 mm) above top surface of floor.
3M COMPANY – 3M Fire Barrier Cast-In Device 2MCID, 3MCID, 4MCID
- 2A. Firestop Device - Height Adapter*** – (Not Shown) - For use in floors greater than 8 in. (203 mm) thick. Adapter snaps onto top of firestop device (Item 2).
3M COMPANY – 3M Fire Barrier Cast-In Device Height Adapter, 2HA, 3HA, 4HA
- 3. Through Penetrants** – One metallic pipe or tubing to be installed concentrically or eccentrically within opening. Penetrant to be rigidly supported on both sides of floor or wall assembly. The following types and sizes of metallic pipes or tubes may be used:
 - A. Steel Pipe** – Nom 2 in. (51 mm) diam (or smaller) Schedule 5 (or heavier) steel pipe.
 - B. Iron Pipe** – Nom 2 in. (51 mm) diam (or smaller) cast or ductile iron pipe.
 - C. Copper Tubing** – Nom 2 in. (51 mm) diam (or smaller) Type L (or heavier) copper tubing.
 - D. Copper Pipe** – Nom 2 in. (51 mm) diam (or smaller) Regular (or heavier) copper pipe.
- 4. Pipe Covering** – The following types and sizes of pipe coverings may be used with the metallic pipes:
 - A. Pipe Covering** – Nom 1-1/2 in. (38 mm) thick (or less) hollow cylindrical heavy density glass fiber units jacketed on the outside with an all service jacket. Longitudinal joints sealed with metal fasteners or factory-applied self-sealing lap tape. Transverse joints secured with metal fasteners or with butt tape supplied with product. Annular space between the pipe covering and periphery of opening or sleeve shall be min 0 in. (0 mm, point contact) to max 1 in. (25 mm).
 See **Pipe and Equipment Covering - Materials**(BRGU) category in the Building Materials Directory for names of manufacturers. Any pipe covering material meeting the above specifications and bearing the UL Classification Marking with a Flame Spread Index of 25 or less and a smoke Developed Index of 50 or less may be used.
 - B. PVC Jacket++ – (Optional, Not Shown)** – An additional PVC jacket, supplied in sheet form, shall be tightly wrapped around the all service jacket on the pipe covering (Item 4A) with the longitudinal seam continuously sealed using the self-sealing lap tape or adhesive

UL System No. F-A-5028 (cont.)

supplied with the jacket. The jacket is to be nom 48 in. (1.22 m) wide by nom 20 or 30 mil (0.5 or 0.8 mm) thick. The jacket shall extend downward into and/or through the opening from a point 36 to 40 in. (0.91 to 1.02 m) above the top surface of the floor assembly. **The PVC jacket must be used for the W Rating to apply.**

See **Plastics** (QMFZ2) category in the Plastics Recognized Component Directory for names of manufacturers. Any Recognized Component plastic material meeting the above specifications and having a UL 94 Flammability Classification of 94-5VA may be used.

- C. Tube Insulation-Plastics++** – Nom 1 in. (25 mm) thick (or less) acrylonitrile butadiene/polyvinyl chloride (AB/PVC) flexible foam furnished in the form of tubing. Annular space between the insulated penetrating item and the periphery of the opening shall be min 0 in. (0 mm) (point contact) to max 1 in. (25 mm).

See **Plastics** (QMFZ2) category in the Plastics Recognized Component Directory for names of manufacturers. Any Recognized Component tube insulation material meeting the above specifications and having a UL 94 Flammability Classification of 94-5A may be used.

The hourly T Ratings are dependent on the size of pipe or tube and the nom thickness of the pipe covering, as shown below:

| Nom Penetrant Size, in. (mm) | Nom Pipe Covering Thickness, in. (mm) | T Rating, Hr |
|------------------------------|---------------------------------------|--------------|
| 1/2 & 3/4 (13 & 19) | 1/2 & 3/4 (13 & 19) | 1-3/4 |
| 1/2 & 3/4 (13 & 19) | 1 & 1-1/2 (25 & 38) | 3 |
| 1 (25) | 1/2 & 3/4 (13 & 19) | 1/2 |
| 1 (25) | 1(25) | 2-3/4 |
| 1 (25) | 1-1/2 (38) | 3 |
| 1-1/4 to 2 (32 to 51) | 1/2 (13) | 1/4 |
| 1-1/4 to 2 (32 to 51) | 3/4, 1 & 1-1/2 (19, 25 & 38) | 1/2 |

- 5. Packing Material** – Not required if annular space is 1/4 in. (6 mm) or less. If annular space is greater than 1/4 in. (6 mm), min 2 in. (51 mm) thickness of min 4 pcf (64 kg/m³) mineral wool batt insulation firmly packed within annulus, flush with the top surface of floor.

- 5A. Fill, Void or Cavity Materials - Sealant, Caulk or Putty*** – (Optional, Not Shown) - As an option, the packing material (Item 5) may be reduced in thickness by 1/4 to 1/2 in. (6 mm to 13 mm) and recessed from the top surface of floor to accommodate a 1/4 to 1/2 in. (6 mm to 13 mm) thickness of sealant, caulk or putty, installed within annulus, flush with the top surface of floor. If annular spaces are less than 1/4 in. (6 mm) and packing material is not used, sealant, caulk or putty may be installed within annulus, flush with the top surface of floor, but is not required. For W and L Ratings, a min 1/4 in. (6 mm) bead of sealant is required at the device/concrete interface on the top surface of the floor and a min 1/4 in. (6 mm) depth of sealant is required atop a min 1-3/4 in. (44 mm) thickness of mineral wool packing material in the annular space between the pipe and the inside of the device.

3M COMPANY – FB-1000 NS sealant, FB-1003 SL sealant, FB-3000 WT sealant, CP 25WB+ caulk, FireDam 150+ caulk, IC 15WB+ caulk or MP+ Stix putty

(Note - W and L Ratings apply only when FB-1000 NS, FB-1003 SL or FB-3000 WT sealants are used.

++- Bearing the UL Recognized Component Mark.

*Indicates such products shall bear the UL or cUL Certification Mark for jurisdictions employing the UL or cUL Certification (such as Canada), respectively.
 Reprinted from the Online Certifications Directory with permission from UL©



System No. F-A-5029

January 09, 2007

F Rating – 2 Hr

T Rating – 1/2 Hr

L Rating at Ambient – Less Than 1 CFM/sq ft (See Item 6)

L Rating at 400° F – Less Than 1 CFM/sq ft (See Item 6)

W Rating – Class 1 (See Items 4A and 6)

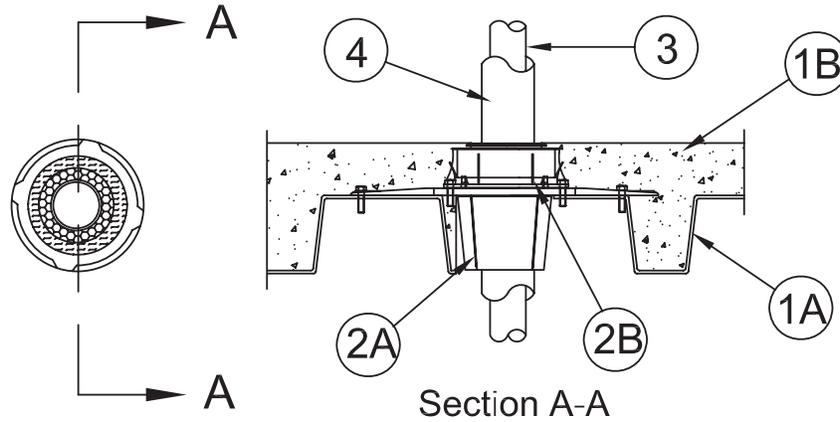

1. **Floor Assembly** – The fire-rated unprotected concrete and steel floor assembly shall be constructed of the materials and in the manner specified in the individual D900 Series designs in the UL Fire Resistance Directory and as summarized below:
 - A. **Concrete** – Min 2-1/2 in. (64 mm) thick reinforced lightweight or normal weight (100-150 pcf or 1600-2400 kg/m³) concrete.
 - B. **Steel Floor and Form Units*** – Composite or noncomposite max 3 in. (76 mm) deep fluted galv units as specified in the individual Floor-Ceiling design.
2. **Firestop Devices*** – The firestop devices are cast in place and permanently embedded during concrete placement or grouted in concrete assembly in accordance with accompanying installation instructions.
 - A. **Firestop Device* – Metal Deck Adapter** – Nom 3 in. (76 mm) adapter, installed through opening in deck and secured to deck with four sheet metal screws in accordance with installation instructions.
3M COMPANY – 3M Fire Barrier Cast-In Device Metal Deck Adapter 3MDA
 - B. **Firestop Device*** – Snapped into top of metal deck adapter in accordance with accompanying installation instructions. The device may be trimmed flush with top surface of floor or may project up to a max 5-1/2 in. (140 mm) above top surface of floor.
3M COMPANY – 3M Fire Barrier Cast-In Device 3MCID
3. **Through Penetrants** – One metallic pipe or tubing installed within the firestop system. Pipe or tubing to be rigidly supported on both sides of floor assembly. The following types of metallic pipes or tubes may be used:
 - A. **Steel Pipe** – Nom 2 in. (51 mm) Schedule 5 (or heavier) steel pipe.
 - B. **Iron Pipe** – Nom 2 in. (51 mm) cast or ductile iron pipe.
 - C. **Copper Tubing** – Nom 2 in. (51 mm) Type L (or heavier) copper tubing.
 - D. **Copper Pipe** – Nom 2 in. (51 mm) Regular (or heavier) copper pipe.
4. **Pipe Covering** – Nom 1/2 in. (13 mm) thick hollow cylindrical heavy density glass fiber units jacketed on the outside with an all service jacket. Longitudinal joints sealed with metal fasteners or factory-applied self-sealing lap tape. Transverse joints secured with metal fasteners or with butt tape supplied with product. Annular space between the pipe covering and periphery of opening or sleeve shall be min 0 in. (point contact) to max 1 in. (25 mm).
 See **Pipe and Equipment Covering – Materials (BRGU)** category in the Building Materials Directory for names of manufacturers. Any pipe covering material meeting the above specifications and bearing the UL Classification Marking with a Flame Spread Index of 25 or less and a smoke Developed Index of 50 or less may be used.
 - 4A. **PVC Jacket++** – (Optional, Not Shown) – An additional PVC jacket, supplied in sheet form, shall be tightly wrapped around the all service jacket on the pipe covering (Item 4) with the longitudinal seam continuously sealed using the self-sealing lap tape or adhesive supplied with the jacket. The jacket is to be nom 48 in. (1.22 m) wide by nom 20 or 30 mil (0.5 or 0.8 mm) thick. The jacket shall extend downward into and/or through the opening from a point 36 to 40 in. (0.91 to 1.02 m) above the top surface of the floor assembly. The PVC jacket must be used for the W Rating to apply.
 See **Plastics (QMFZ2)** category in the Plastics Recognized Component Directory for names of manufacturers. Any Recognized Component plastic material meeting the above specifications and having a UL 94 Flammability Classification of 94-5VA may be used.
5. **Packing Material** – (Not Shown) – Min 2 in. (51 mm) thickness of min 4 pcf (64 kg/m³) mineral wool batt insulation firmly packed into the top of the firestop device (Item 2B) a permanent form, flush with the top surface of the floor.
6. **Fill, Void or Cavity Materials – Sealant** – (Optional, Not Shown) – For W and L Ratings, a min 1/4 in. (6 mm) bead of sealant is required at the device/concrete interface on the top surface of the floor and a min 1/4 in. (6 mm) depth of sealant is required atop a min 1-3/4 in. (44 mm) thickness of mineral wool packing material in the annular space between the pipe and the inside of the device.
3M COMPANY – FB-1000 NS Sealant, FB-1003 SL Sealant or FB-3000 WT Sealant

*Bearing the UL Classification Mark

Reprinted from the Online Certifications Directory with permission from Underwriters Laboratories Inc.

Copyright © 2010 Underwriters Laboratories Inc.®



System No. F-A-5033

March 05, 2007

F Ratings – 1-1/2, 2 and 3 Hr (See Item 5)

T Ratings – 0, 1/2, 3/4 and 1 Hr (See Items 1A and 5)

L Rating At Ambient – 2 CFM / sq ft

L Rating At 400 F – Less Than 1 CFM / sq ft

W Rating – Class 1

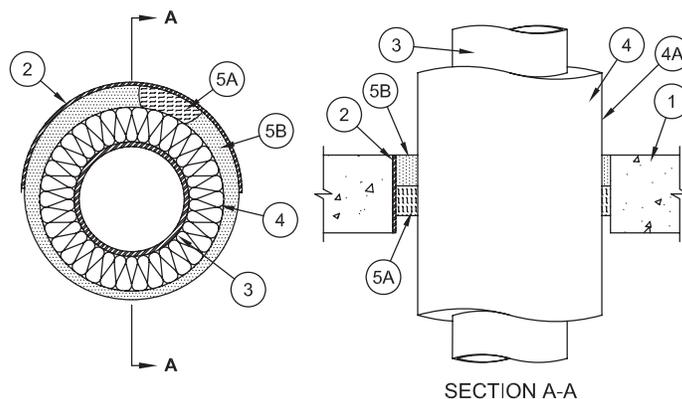

1. **Floor Assembly** – Min 2-1/2 in. (64 mm) thick reinforced lightweight or normal weight (100-150 pcf or 1600-2400 kg/m³) concrete. Max diam of opening is 18 in. (457 mm).
2. **Steel Sleeve** – (Optional) – Nom 10 in. (254 mm) diam (or smaller) Schedule 10 (or heavier) steel sleeve cast or grouted into floor assembly. Sleeve may extend a max of 2 in. (51 mm) above top of floor. As an alternate, nom 10 in. (254 mm) diam (or smaller) sleeve fabricated from nom 0.019 in. (0.48 mm) thick galv steel cast or grouted into floor assembly flush with floor surfaces. **T Rating is 0 Hr when sleeve is used.**
3. **Through Penetrants** – One metallic pipe or tubing to be installed concentrically or eccentrically within opening. Penetrant to be rigidly supported on both sides of floor. The following types and sizes of metallic pipes or tubes may be used:
 - A. **Steel Pipe** – Nom 12 in. (305 mm) diam (or smaller) Schedule 10 (or heavier) steel pipe.
 - B. **Iron Pipe** – Nom 12 in. (305 mm) diam (or smaller) cast or ductile iron pipe.
 - C. **Copper Tubing** – Nom 4 in. (102 mm) diam (or smaller) Type M (or heavier) copper tube.
 - D. **Copper Pipe** – Nom 4 in. (102 mm) diam (or smaller) Regular (or heavier) copper pipe.

4. **Pipe Covering*** – Nom 1/2 to 2 in. (13 to 51 mm) thick hollow cylindrical heavy density glass fiber units jacketed on the outside with an all service jacket. Longitudinal joints sealed with metal fasteners or factory-applied self-sealing lap tape. Transverse joints secured with metal fasteners or with butt strip tape supplied with the product.

See **Pipe and Equipment Covering – Materials*** (BRGU) category in Building Materials Directory for names of manufacturers. Any pipe covering material meeting the above specifications and bearing the UL Classification Marking with a Flame Spread Index of 25 or less and a Smoke Developed Index of 50 or less may be used.

- 4A. **PVC Jacket+** – An additional PVC jacketing, supplied in sheet form, shall be tightly wrapped around the all service jacket on the pipe covering with the longitudinal seam continuously sealed using the adhesive supplied with the jacket. The jacket is to be nom 48 in. (1219 mm) wide by nom 20 or 30 mil (0.5 or 0.8 mm) thick. The jacket shall be installed at a point 36 in. (914 mm) to 40 in. (1016 mm) above the top surface of the floor assembly and shall extend downward into and/or through the opening.

See **Plastics (QMFZ2)** category in the Plastics Recognized Component Directory for names of manufacturers. Any Recognized Component tube insulation material meeting the above specifications and having a UL 94 Flammability Classification of 94-5VA may be used.

5. **Firestop System** – The details of the firestop system shall be as follows:
 - A. **Packing Material** – Min 1 in. (25 mm) thickness of firmly packed mineral wool batt insulation used as a permanent form. Packing material to be recessed from top surface of floor or sleeve to accommodate the required thickness of fill material (Item 5B).
 - B. **Fill, Void or Cavity Material* – Sealant** – Applied to fill the annular space flush with the top surface of the floor or sleeve. When nom pipe covering thickness is 2 in., (51 mm) min thickness of sealant is 2 in. (51 mm). When nom pipe covering thickness is 1-1/2 in. (38 mm) or less, min thickness of sealant is 1 in. (25 mm). The hourly F and T Ratings of the firestop system are dependent upon the thickness of the floor, the size of pipe, the thickness of pipe covering material and the size of the annular space between the pipe covering material and the periphery of the opening, as shown in the following table:

| Min Floor Thickness, in. (mm) | Max Pipe Diam in. (mm) | Nom Pipe Covering Thickness, in. (mm) | Annular Space, in. (mm) | F Rating Hr | T Rating Hr |
|-------------------------------|------------------------|---------------------------------------|----------------------------|-------------|-------------|
| 2-1/2 (64) | 4 (102) | 1 or 1-1/2 (25 or 38) | 1/2 to 2-3/8 (13 to 60 mm) | 2 | 1 |
| 4-1/2 (114) | 4 (102) | 2 (51) | 1/4 to 3-5/8 (6 to 92 mm) | 2 | 1-1/2 |
| 2-1/2 (64) | 12 (305) | 1 (25) | 1/2 to 1-1/2 (13 to 38 mm) | 2 | 1/2 |
| 4-1/2 (114) | 12 (305) | 1 (25) | 1/2 to 2-3/8 (13 to 60 mm) | 3 | 1 |
| 2-1/2 (64) | 12 (305) | 1/2 (13) | 1/2 to 2-3/8 (13 to 60 mm) | 2 | 0 |

3M COMPANY – FB-3000 WT

*Bearing the UL Classification Mark

+Bearing the UL Recognized Component Marking

Reprinted from the Online Certifications Directory with permission from Underwriters Laboratories Inc.

Copyright © 2010 Underwriters Laboratories Inc.®

System No. W-J-5013

September 08, 2004

F Ratings – 1 and 2 Hr (See Item 4)

T Ratings – 1 and 1-1/2 Hr (See Item 4)

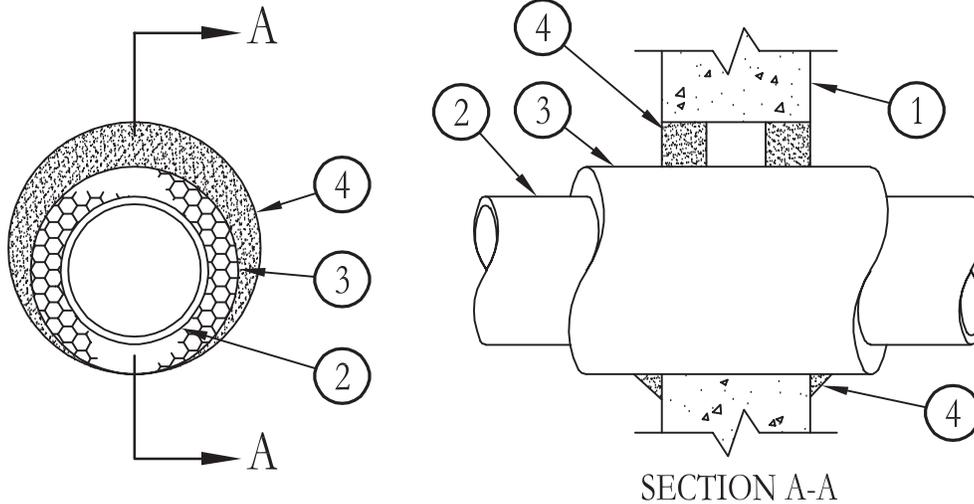

- Wall Assembly** – Min 4-1/2 in. thick lightweight or normal weight (100-150 pcf) concrete. Wall may also be constructed of any UL Classified **Concrete Blocks***. Max diam of opening is 8-1/2 in.
See **Concrete Blocks (CAZT)** category in the Fire Resistance Directory for names of manufacturers.
- Through Penetrants** – One metallic pipe or tubing installed either concentrically or eccentrically within the firestop system. Pipe, conduit or tubing to be rigidly supported on both sides of wall assembly. The following types and sizes of metallic pipes, conduits or tubing may be used:
 - Steel Pipe** – Nom 4 in. diam (or smaller) Schedule 10 (or heavier) steel pipe.
 - Copper Tubing** – Nom 4 in. diam (or smaller) Type L (or heavier) copper tubing.
 - Copper Pipe** – Nom 4 in. diam (or smaller) Regular (or heavier) copper pipe.
- Pipe Covering*** – Nom 1-1/2 in. thick hollow cylindrical heavy density glass fiber units jacketed on the outside with an all service jacket. Longitudinal joints sealed with metal fasteners or factory-applied SSL tape. Transverse joints secured with metal fasteners or with butt tape supplied with the product. The annular space between the insulated pipe and the edge of the through opening shall be min zero in. (continuous point contact) to max 1-1/4 in.
See **Pipe and Equipment Covering – Materials*** (BRGU) category in the Building Materials Directory for names of manufacturers. Any pipe covering material meeting the above specifications and bearing the UL Classification Marking with a Flame Spread Index of 25 or less and a Smoke Developed Index of 50 or less may be used.
- Fill, Void or Cavity Materials* – Caulk or Sealant** – Min thickness of 5/8 in. and 1-1/4 in. of caulk or putty for 1 and 2 hr rated wall assemblies, respectively, applied within annulus between pipe covering and periphery of the opening, flush with both surfaces of wall assembly. A min 1/2 in. diam bead of caulk shall be applied to the pipe covering/wall interface at the point contact location on both sides of wall. **The hourly F and T Ratings of the firestop system are 1 hr when installed in 1 hr fire rated wall assemblies. The hourly F Rating of the firestop system is 2 hr when installed in 2 hr fire rated wall assemblies. When installed in 2 hr fire rated wall assemblies, T Rating is 1 hr when copper tube is used and 1-1/2 hr when steel pipe is used.**
3M COMPANY – CP 25WB+ caulk or FB-3000 WT sealant
- Packing Material (Optional)** – Mineral wool or fiberglass insulation or polyethylene backer rod firmly packed into opening as a permanent form. Packing material to be recessed from both surfaces of wall as required to accommodate the required thickness of caulk fill material.

*Bearing the UL Classification Marking

Reprinted from the Online Certifications Directory with permission from Underwriters Laboratories Inc.

Copyright © 2010 Underwriters Laboratories Inc.®



System No. W-J-5014

May 19, 2005

F Ratings – 1 and 2 Hr (See Item 4)

T Rating – 3/4 Hr

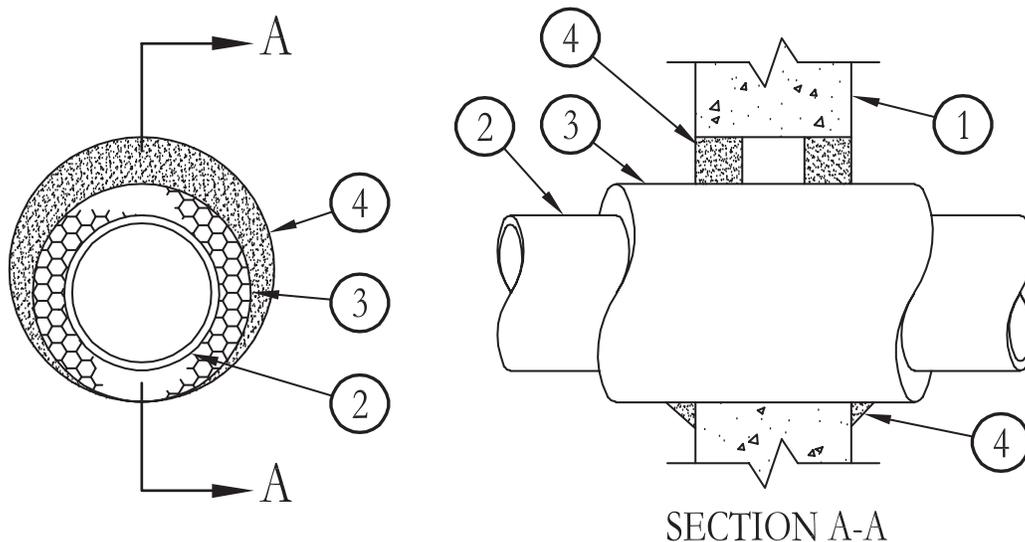

- Wall Assembly** – Min 4-1/2 in. (114 mm) thick lightweight or normal weight (100-150 pcf or 1600-2400 kg/m³) concrete. Wall may also be constructed of any UL Classified **Concrete Blocks***. Max diam of opening is 7 in. (178 mm).
See **Concrete Blocks** (CAZT) category in the Fire Resistance Directory for names of manufacturers.
- Through Penetrants** – One metallic pipe or tubing installed either concentrically or eccentrically within the firestop system. Pipe, conduit or tubing to be rigidly supported on both sides of wall assembly. The following types and sizes of metallic pipes, conduits or tubing may be used:
 - Steel Pipe** – Nom 4 in. (102 mm) diam (or smaller) Schedule 10 (or heavier) steel pipe.
 - Copper Tubing** – Nom 4 in. (102 mm) diam (or smaller) Type L (or heavier) copper tubing.
 - Copper Pipe** – Nom 4 in. (102 mm) diam (or smaller) Regular (or heavier) copper pipe.
- Pipe Insulation – Plastics#** – Nom 3/4 in. (19 mm) thick acrylonitrile butadiene/polyvinyl chloride (AB/PVC) flexible foam furnished in the form of tubing. The annular space between the insulated pipe and the edge of the through opening shall be min 0 in. (point contact) to max 1-1/4 in. (0 mm to 32 mm).
See **Plastics#** (QMFZ2) category in the Recognized Component Directory for names of manufacturers. Any Recognized Component tube insulation material meeting the above specifications and having a UL94 Flammability Classification of 94-5VA may be used.
- Fill, Void or Cavity Materials* – Caulk or Sealant** – Min thickness of 5/8 in. and 1-1/4 in. (16 mm and 32 mm) of caulk or putty for 1 and 2 hr rated wall assemblies, respectively, applied within annulus between pipe covering and periphery of the opening, flush with both surfaces of wall assembly. A min 1/2 in. (13 mm) diam bead of caulk shall be applied to the pipe covering/wall interface at the point contact location on both sides of wall.
3M COMPANY – IC 15WB+, CP 25WB+ caulk or FB-3000 WT sealant
- Packing Material** (Optional, not shown) – Mineral wool or fiberglass insulation or polyethylene backer rod firmly packed into opening as a permanent form. Packing material to be recessed from both surfaces of wall as required to accommodate the required thickness of caulk fill material.

*Bearing the UL Classification Marking

Reprinted from the Online Certifications Directory with permission from Underwriters Laboratories Inc.
Copyright © 2010 Underwriters Laboratories Inc.®



Through Penetrations

Insulated Pipes

5000 Series

Concrete

WJ

System No. W-J-5015

May 19, 2005

F Ratings – 1 and 2 Hr (See Item 5)

T Ratings – 1/2, 1 and 1-1/2 Hr (See Item 3)

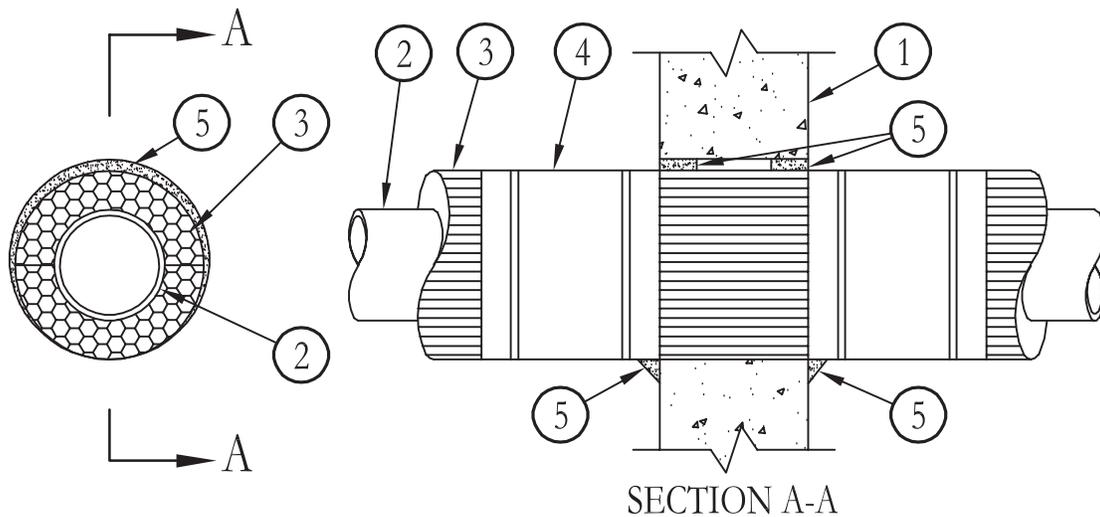

- Wall Assembly** – Min 4-1/2 in. (114 mm) thick lightweight or normal weight (100-150 pcf or 1600-2400 kg/m³) concrete. Wall may also be constructed of any UL Classified **Concrete Blocks***. Max diam of opening is 20 in. (508 mm).
See **Concrete Blocks** (CAZT) category in the Fire Resistance Directory for names of manufacturers.

- Through Penetrants** – One metallic pipe or tubing installed either concentrically or eccentrically within the firestop system. Pipe, conduit or tubing to be rigidly supported on both sides of wall assembly. The following types and sizes of metallic pipes, conduits or tubing may be used:

- Steel Pipe** – Nom 12 in. (305 mm) diam (or smaller) Schedule 10 (or heavier) steel pipe.
- Copper Tubing** – Nom 6 in. (152 mm) diam (or smaller) Type L (or heavier) copper tubing.
- Copper Pipe** – Nom 6 in. (152 mm) diam (or smaller) Regular (or heavier) copper pipe.

- Pipe Covering Materials*** – **Cellular Glass Insulation** – Nom 1-1/2 in. or 3 in. (38 mm by 76 mm) thick cellular glass units supplied in nom 24 in. (610 mm) long half sections or nom 18 in. (457 mm) long segments. Pipe insulation installed on pipe in accordance with the manufacturer's instructions. **T Rating is 1/2 hr when nom 1-1/2 in. (38 mm) thick pipe insulation is used in 1 hr and 2 hr fire-rated wall assemblies. T Rating is 1 hr when nom 3 in. (76 mm) thick pipe insulation is used in 1 hr fire-rated wall assemblies. T Rating is 1-1/2 hr when nom 3 in. (76 mm) thick pipe insulation is used in 2 hr fire-rated wall assemblies.**

PITTSBURGH CORNING CORP – FOAMGLAS

- Metal Jacket** – Min 12 in. (305 mm) long jacket formed of min 0.010 in. (0.25 mm) thick steel or aluminum sheet cut to wrap tightly around the pipe insulation with a min 2 in. (51 mm) lap. Jacket secured with min 1/2 in. (13 mm) wide stainless steel hose clamps or bands located within 2 in. (51 mm) of each end of the jacket and spaced a max of 10 in. (254 mm) OC. Jacket to be installed with edges abutting surface of fill material (Item 5) on both surfaces of wall.
- Fill, Void or Cavity Materials* – Caulk or Sealant** – Min thickness of 5/8 in. and 1-1/4 in. (16 mm and 32 mm) of caulk or putty for 1 and 2 hr rated wall assemblies, respectively, applied within annulus between pipe covering and periphery of the opening, flush with both surfaces of wall assembly. A min 1/2 in. (13 mm) diam bead of caulk shall be applied to the pipe covering/wall interface at the point contact location on both sides of wall.

3M COMPANY – IC 15WB+, CP 25WB+ caulk or FB-3000 WT sealant

- Packing Material** (Optional, not shown) – Mineral wool or fiberglass insulation or polyethylene backer rod firmly packed into opening as a permanent form. Packing material to be recessed from both surfaces of wall as required to accommodate the required thickness of caulk fill material.

*Bearing the UL Classification Marking

Reprinted from the Online Certifications Directory with permission from Underwriters Laboratories Inc.

Copyright © 2010 Underwriters Laboratories Inc.®



System No. W-J-5077

May 19, 2005
F Rating – 2 Hr
T Rating – 1-1/4 Hr

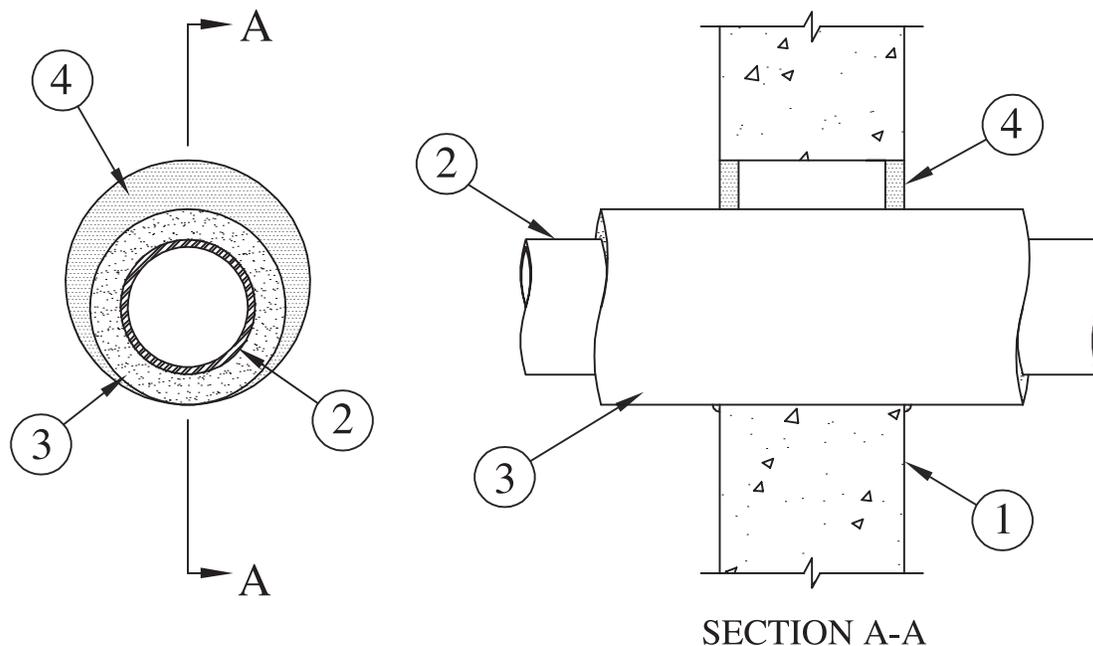

- Wall Assembly** – Min 6 in. (152 mm) thick reinforced lightweight or normal weight (100-150 pcf or 1600-2400 kg/m³) concrete wall. Wall may also be constructed of any UL Classified **Concrete Blocks***. Max diam of opening is 12-1/2 in. (318 mm).
See **Concrete Blocks (CAZT)** category in the Fire Resistance Directory for names of manufacturers.
- Through Penetrants** – One metallic pipe, conduit or tubing installed concentrically or eccentrically within opening. Penetrant to be rigidly supported on both sides of wall. The following types and sizes of penetrants may be used:
 - Steel Pipe** – Nom 8 in. (203 mm) diam (or smaller) Schedule 10 (or heavier) steel pipe.
 - Iron Pipe** – Nom 8 in. (203 mm) diam (or smaller) cast or ductile iron pipe.
 - Copper Tubing** – Nom 4 in. (102 mm) diam (or smaller) Type L (or heavier) copper tubing.
 - Copper Pipe** – Nom 4 in. (102 mm) diam (or smaller) Regular (or heavier) copper pipe.
- Pipe Covering*** – Nom 1 in. (25 mm) thick hollow cylindrical heavy density glass fiber units jacketed on the outside with an all service jacket. Longitudinal joints sealed with metal fasteners or factory-applied SSL tape. Transverse joints secured with metal fasteners or with butt tape supplied with the product. Annular space between pipe covering and periphery of opening to be min 0 in. (point contact) to max 1-7/8 in. (0 mm to max 48 mm).
See **Pipe and Equipment Covering-Materials (BRGU)** category in the Building Materials Directory for names of manufacturers. Any pipe covering material meeting the above specifications and bearing the UL Classification Marking with a Flame Spread Index of 25 or less and a Smoke Developed Index of 50 or less may be used.
- Fill, Void or Cavity Material* – Caulk or Sealant** – Min 5/8 in. (16 mm) thickness of caulk applied within annulus, flush with both surfaces of wall. Min 1/4 in. (6 mm) diam bead of caulk applied to pipe covering/wall interface at point contact location on both sides of wall.
3M COMPANY – IC 15WB+, CP 25WB+ caulk or FB-3000 WT sealant

*Bearing the UL Classification Marking

Reprinted from the Online Certifications Directory with permission from Underwriters Laboratories Inc.
Copyright © 2010 Underwriters Laboratories Inc.®



System No. W-J-5078

May 19, 2005

F Rating – 2 Hr

T Ratings – 0 & 1 Hr (See Item 3)

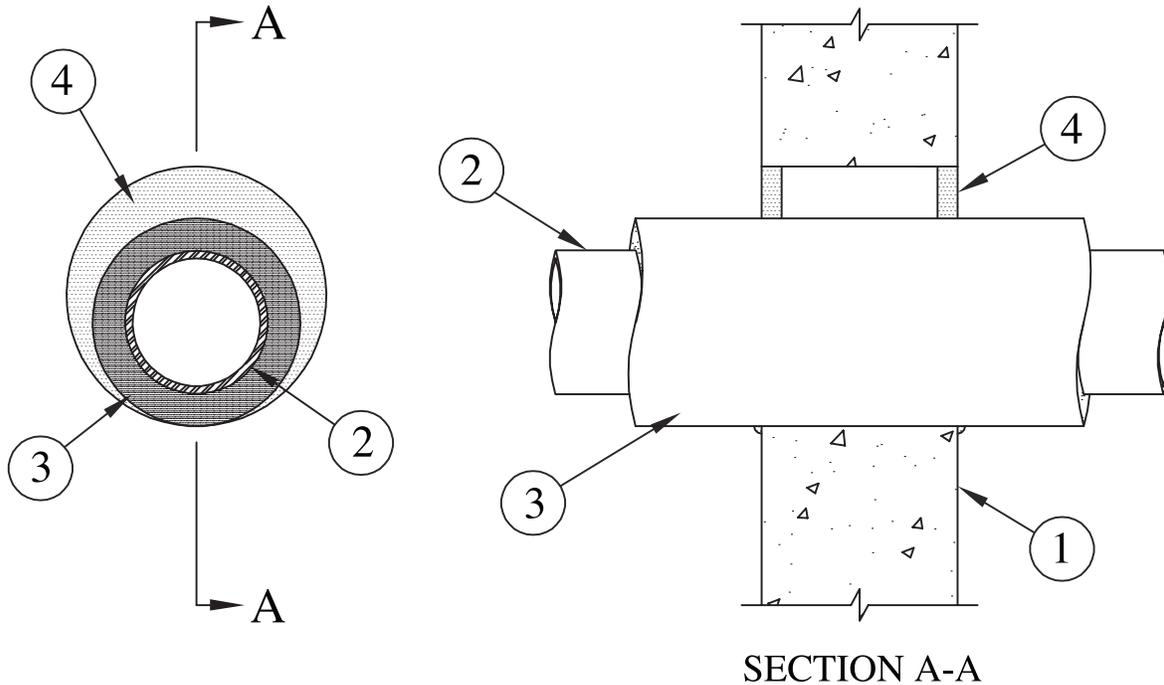

- Wall Assembly** – Min 6 in. (152 mm) thick reinforced lightweight or normal weight (100-150 pcf or 1600-2400 kg/m³) concrete wall. Wall may also be constructed of any UL Classified **Concrete Blocks***. Max diam of opening is 7-1/2 in. (191 mm).
See **Concrete Blocks (CAZT)** category in the Fire Resistance Directory for names of manufacturers.
- Through Penetrants** – One metallic pipe or tubing installed concentrically or eccentrically within opening. Penetrant to be rigidly supported on both sides of wall assembly. The following types and sizes of metallic pipes or tubing may be used:
 - Steel Pipe** – Nom 4 in. (102 mm) diam (or smaller) Schedule 10 (or heavier) steel pipe.
 - Iron Pipe** – Nom 4 in. (102 mm) diam (or smaller) cast or ductile iron pipe.
 - Copper Tubing** – Nom 2 in. (51 mm) diam (or smaller) Type L (or heavier) copper tubing.
 - Copper Pipe** – Nom 2 in. (51 mm) diam (or smaller) Regular (or heavier) copper pipe.
- Tube Insulation-Plastics+** – Nom 3/4 in. (19 mm) thick (or less) acrylonitrile butadiene/polyvinyl chloride (AB/PVC) flexible foam furnished in the form of tubing. Annular space between tube insulation and periphery of opening to be min 0 in. (point contact) to max 1-1/2 in. (0 mm to max 38 mm).
See **Plastics (QMFZ2)** category in the Plastics Recognized Component Directory for names of manufacturers. Any Recognized Component tube insulation material meeting the above specifications and having a UL 94 Flammability Classification of 94-5A may be used.
T Rating is 1 Hr for nom 3/4 in. (19 mm) thick tube insulation. T Rating is 0 Hr for tube insulations less than nom 3/4 in. (19 mm) thick.
- Fill, Void or Cavity Material* – Caulk or Sealant** – Min 5/8 in. (16 mm) thickness of caulk applied within annulus, flush with both surfaces of wall. Min 1/4 in. (6 mm) diam bead of caulk applied to pipe covering/wall interface at point contact location on both sides of wall.
3M COMPANY – IC 15WB+, CP 25WB+ caulk or FB-3000 WT sealant

*Bearing the UL Classification Marking

Reprinted from the Online Certifications Directory with permission from Underwriters Laboratories Inc.
Copyright © 2010 Underwriters Laboratories Inc.®



System No. W-J-5138

April 19, 2007

F Rating – 2 Hr

T Rating – 2 Hr

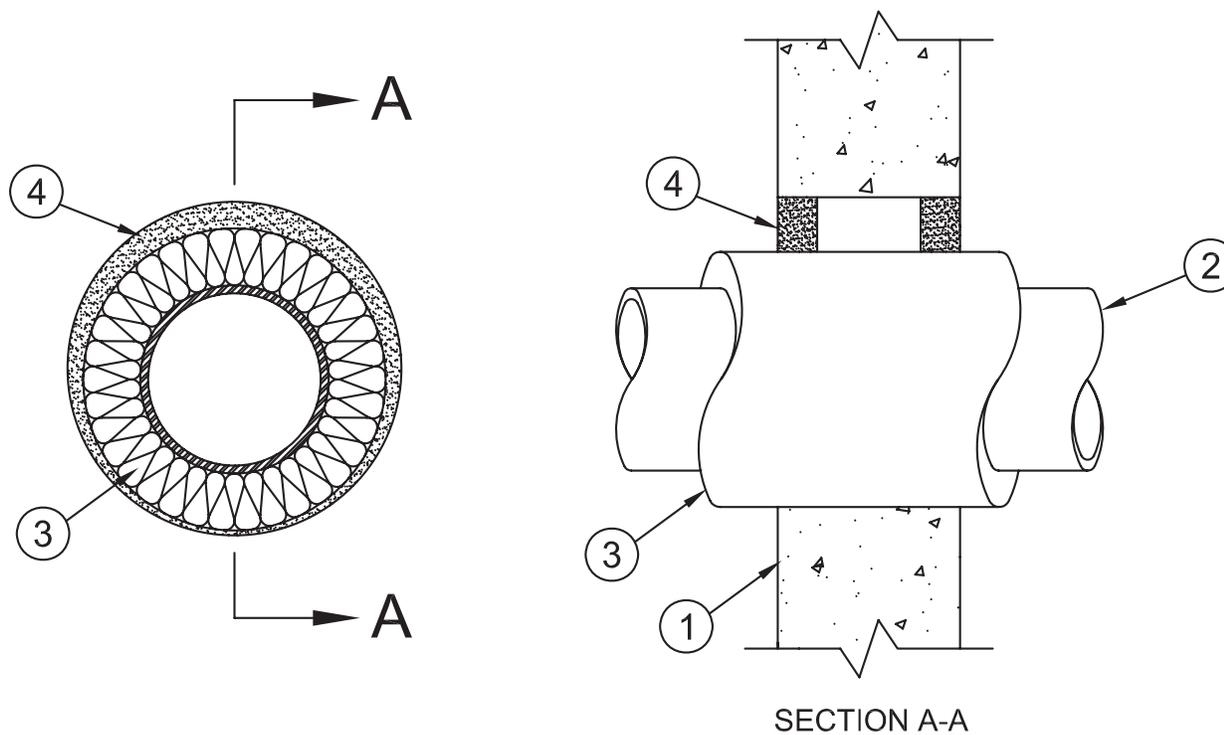

1. **Wall Assembly** – Min 6 in. (152 mm) thick reinforced lightweight or normal weight (100-150 pcf or 1600 - 2400 kg/m³) concrete wall. Wall may also be constructed of any UL Classified **Concrete Blocks***. Opening shall be sized to be nom. 2 in. (51 mm) larger than outside diameter of pipe covering (Item 3).
See **Concrete Blocks** (CAZT) category in the Fire Resistance Directory for names of manufacturers.
2. **Through Penetrants** – One metallic pipe or tubing to be installed either concentrically or eccentrically within the firestop system. Pipe or tubing to be rigidly supported on both sides of wall assembly. The following types and sizes of metallic pipes of tubing may be used:
 - A. **Steel Pipe** – Nom 6 in. (152 mm) diam (or smaller) Schedule 40 (or heavier) steel pipe.
 - B. **Iron Pipe** – Nom 6 in. (152 mm) diam (or smaller) cast or ductile iron pipe.
 - C. **Copper Tubing** – Nom 6 in. (152 mm) diam (or smaller) Type L (or heavier) copper tubing.
 - D. **Copper Pipe** – Nom 6 in. (152 mm) diam (or smaller) Regular (or heavier) copper pipe.
3. **Pipe Covering*** – Nom. 3 in. (76 mm) thick hollow cylindrical heavy density glass fiber units jacketed on the outside with an all service jacket. Longitudinal joints sealed with metal fasteners or factory applied self-sealing lap tape. Transverse joints secured with metal fasteners or with butt tape supplied with the product. The annular spacing between pipe covering and steel sleeve shall be min. 0 in. (point contact) to max. 2 in. (51 mm).
See **Pipe and Equipment Covering – Materials** (BRGU) category in the Building Materials Directory for names of manufacturers. Any pipe covering material meeting the above specifications and bearing the UL Classification Marking with a Flame Spread Index of 25 or less and a Smoke Developed Index of 50 or less may be used.
4. **Fill, Void or Cavity Material* – Sealant** – Min 1-1/4 in. (32 mm) thickness of sealant applied within the gypsum board annulus, flush with the finished side of the wall. Min 1/2 in. (13 mm) diameter bead of sealant applied to the penetrant/gypsum board interface at the point contact location on the finished side of the wall.

3M COMPANY – FB-3000 WT

*Bearing the UL Classification Mark

Reprinted from the Online Certifications Directory with permission from Underwriters Laboratories Inc.
Copyright © 2010 Underwriters Laboratories Inc.®



Through Penetrations

Insulated Pipes

5000 Series

Concrete

WJ

System No. W-J-5146

July 10, 2009
 F Rating – 2 Hr
 T Rating – 2 Hr

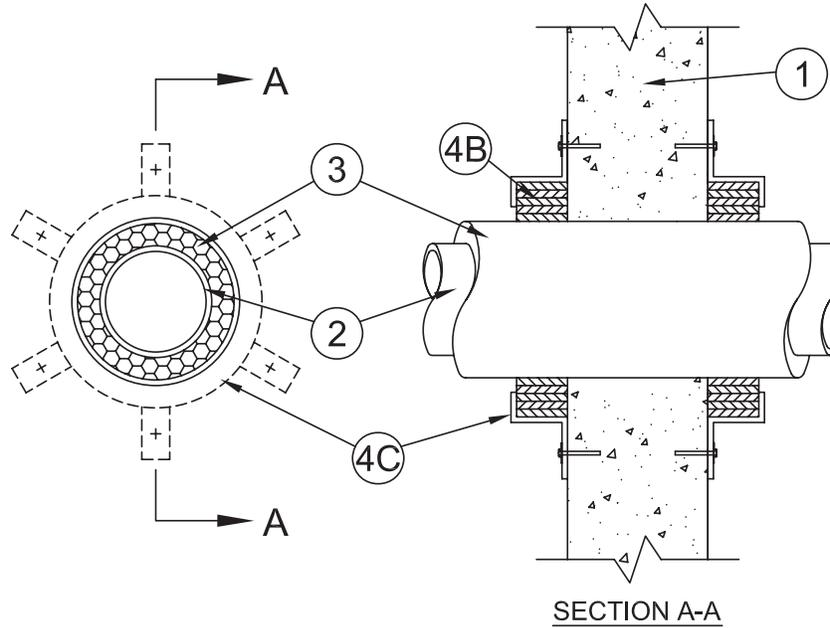

1. **Wall Assembly** – Min 6 in. (152 mm) thick reinforced lightweight or normal weight (100-150 pcf or 1600-2400 kg/m³) concrete. Wall may also be constructed of any UL Classified **Concrete Blocks***. Max diam of opening is 4 in. (102 mm).
 See **Concrete Blocks (CAZT)** category in the Fire Resistance Directory for names of manufacturers.
2. **Through Penetrants** – One nonmetallic pipe to be installed either concentrically or eccentrically within the firestop system. Pipe to be rigidly supported on both sides of wall assembly. The following types and sizes of nonmetallic pipes or tubing may be used:
 - A. **Polyvinyl Chloride (PVC) Pipe** – Nom 2 in. (51 mm) diam (or smaller) Schedule 40 solid core PVC pipe for use in closed (process or supply) or vented (drain, waste or vent) piping systems.
 - B. **Chlorinated Polyvinyl Chloride (CPVC) Pipe** – Nom 2 in. (51 mm) diam (or smaller) SDR13.5 CPVC pipe for use in closed (process or supply) or vented (drain, waste or vent) piping systems.
3. **Tube Insulation – Plastics+** – Nom 1 in. (25 mm) thick acrylonitrile butadiene/polyvinyl chloride (AB/PVC) flexible foam furnished in the form of tubing. The annular space shall be min 0 in. (continuous point contact).
 See **Plastics+** (QMFZ2) category in the Plastics Recognized Component Directory for names of manufacturers. Any Recognized Component tube insulation material meeting the above specifications and having a UL 94 Flammability Classification of 94-5VA may be used.
4. **Firestop System** – The firestop system shall consist of the following:
 - A. **Fill, Void or Cavity Material – Caulk or Sealant** – (Not Shown) – Min 1/4 in. (6 mm) bead of fill material applied around the outer circumference of the insulated through penetrant at the concrete interface on each surface of the wall assembly.
3M COMPANY
3M FIRE PROTECTION PRODUCTS – IC 15WB+, CP 25WB+ or FB-3000 WT
 - B. **Fill, Void or Cavity Materials* – Wrap Strip** – Nom 2 in. (51 mm) wide, nom 1/4 in. (6 mm) thick intumescent elastomeric material faced on one side with aluminum foil. Two layers of wrap strip tightly wrapped around insulated through penetrant (foil side exposed) and butted against the wall surface on both sides of the wall assembly. Each layer of wrap strip to be installed with butted seams with butted seams in successive layers staggered. Wrap strips temporarily held in position using aluminum foil tape, steel wire tie, or equivalent.
3M COMPANY
3M FIRE PROTECTION PRODUCTS – Ultra GS Wrap Strip
 - C. **Steel Collar** – Nom 2 in. (51 mm) deep collar with 1-1/4 in. (32 mm) wide by 2 in. (51 mm) long anchor tabs and min 1/2 in. (13 mm) long tabs to retain wrap strip. Coils of precut min 0.016 in. (0.41 mm) in thick (30 gauge) galv sheet steel available from wrap strip manufacturer. As an alternate, collar may be field-fabricated from min 0.016 in. (0.41 mm) thick (30 gauge) galv sheet steel in accordance with instruction sheet supplied by wrap strip manufacturer. Collar, with anchor tabs bent outward 90 degrees, wrapped tightly around wrap strip with min 1 in. (25 mm) overlap at seam and compressed around wrap strip(s) using a min 1/2 in. (13 mm) wide by min 0.028 in. (0.71 mm) thick stainless steel band at the collar midheight. As an alternate to the band clamps, collars may be secured by means of No. 10 by 3/8 in. (10 mm) long steel sheet metal screws installed in the vertical axis at the center of the 1 in. (25 mm) overlap along the perimeter joint of the collar. A min of three screws is required. Collar anchor tabs pressed tightly against wall surfaces and secured to wall surfaces with nom 3/16 in. (5 mm) diam steel concrete anchors, or equivalent, in conjunction with min 1-1/4 in. (32 mm) diam steel fender washers.

+Bearing the UL Recognized Component Mark

*Bearing the UL Classification Mark

Reprinted from the Online Certifications Directory with permission from Underwriters Laboratories Inc.

Copyright © 2010 Underwriters Laboratories Inc.®



System No. W-J-5147

July 20, 2009
F Rating – 2 Hr
T Rating – 1-1/2 Hr

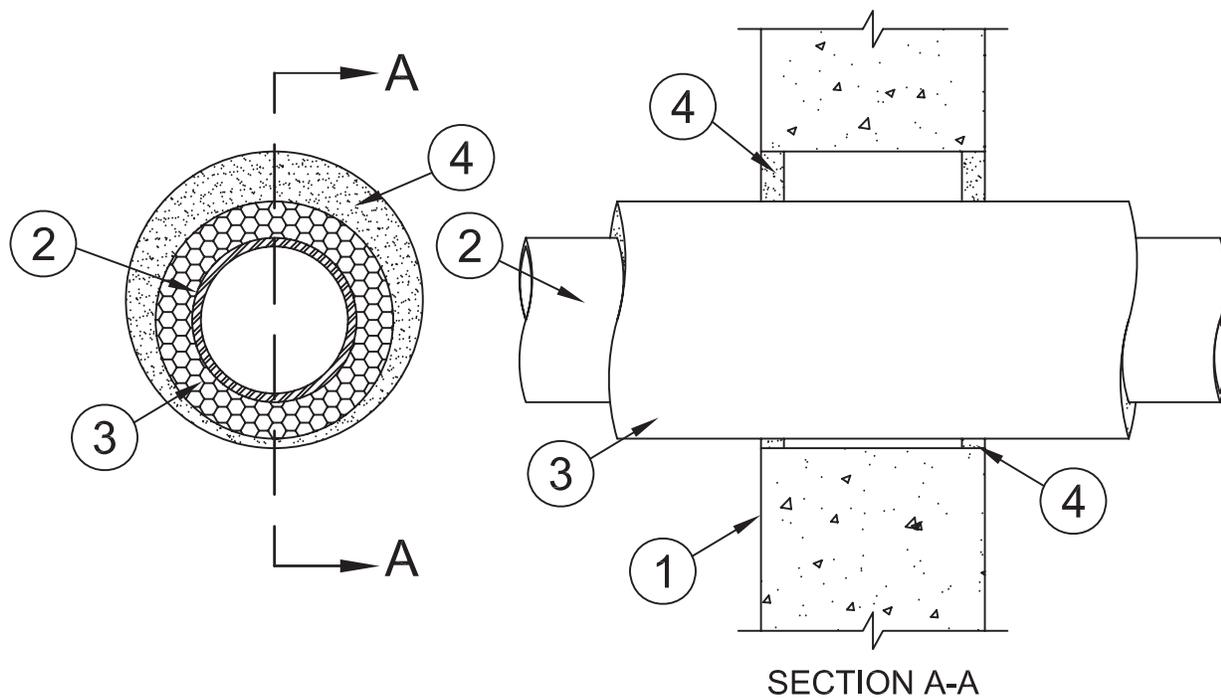

- Wall Assembly** – Min 6 in. (152 mm) thick reinforced lightweight or normal weight (100-150 pcf or 1600-2400 kg/m³) concrete wall. Wall may also be constructed of any UL Classified **Concrete Blocks***. Diam of wall opening to be min 1 in. (25 mm) to max 1-1/2 in. (38 mm) larger than outside diam of insulated pipe or tube.
See **Concrete Blocks (CAZT)** category in the Fire Resistance Directory for names of manufacturers.
- Through Penetrant** – One metallic pipe or tube to be installed eccentrically or concentrically within the firestop system. Pipe or tube to be rigidly supported on both sides of the floor or wall assembly. The following types and sizes of metallic pipes and tubes may be used:
 - Steel Pipe** – Nom 3 in. (76 mm) diam (or smaller) Schedule 5 (or heavier) steel pipe.
 - Iron Pipe** – Nom 3 in. (76 mm) diam (or smaller) cast or ductile iron pipe.
 - Copper Pipe** – Nom 2 in. (51 mm) diam (or smaller) Regular (or heavier) copper pipe.
 - Copper Tube** – Nom 2 in. (51 mm) diam (or smaller) Type L (or heavier) copper tube.
- Pipe Insulation – Foamed Plastic*** – Nom 1 in. (25 mm) thick polyisocyanurate foamed plastic units jacketed with an all service jacket. Longitudinal joints sealed with self-sealing lap tape. Transverse joints secured with butt tape. Annular space shall be min 1/4 in. (6 mm) to max 3/4 in. (19 mm).
See **Foamed Plastic (BRYX)** category in the Building Materials Directory for names of manufacturers. Any foamed plastic pipe covering material meeting the above specifications and bearing the UL Classification Marking with a Flame Spread Index of 25 or less may be used.
- Band Clamp** – Nom 1/2 (13 mm) wide stainless steel band clamp with worm gear tightening mechanism. Band clamp to be secured around pipe insulation 1 in. (25 mm) from both surfaces of wall.
- Fill, Void or Cavity Material* – Sealant** – Min 5/8 in. (16 mm) thickness of fill material* applied within annulus, flush with both surfaces of wall, with a nominal 1/2 in. (13 mm) lap onto the wall surfaces.

3M COMPANY

3M FIRE PROTECTION PRODUCTS – Type CP-25WB+ Caulk, FB-3000WT Sealant

*Bearing the UL Classification Mark

Reprinted from the Online Certifications Directory with permission from Underwriters Laboratories Inc.
Copyright © 2010 Underwriters Laboratories Inc.®



Through Penetrations

Insulated Pipes

5000 Series

Concrete

WJ

System No. W-J-5149

February 18, 2010

F Rating – 2 Hr

T Rating – 2 Hr

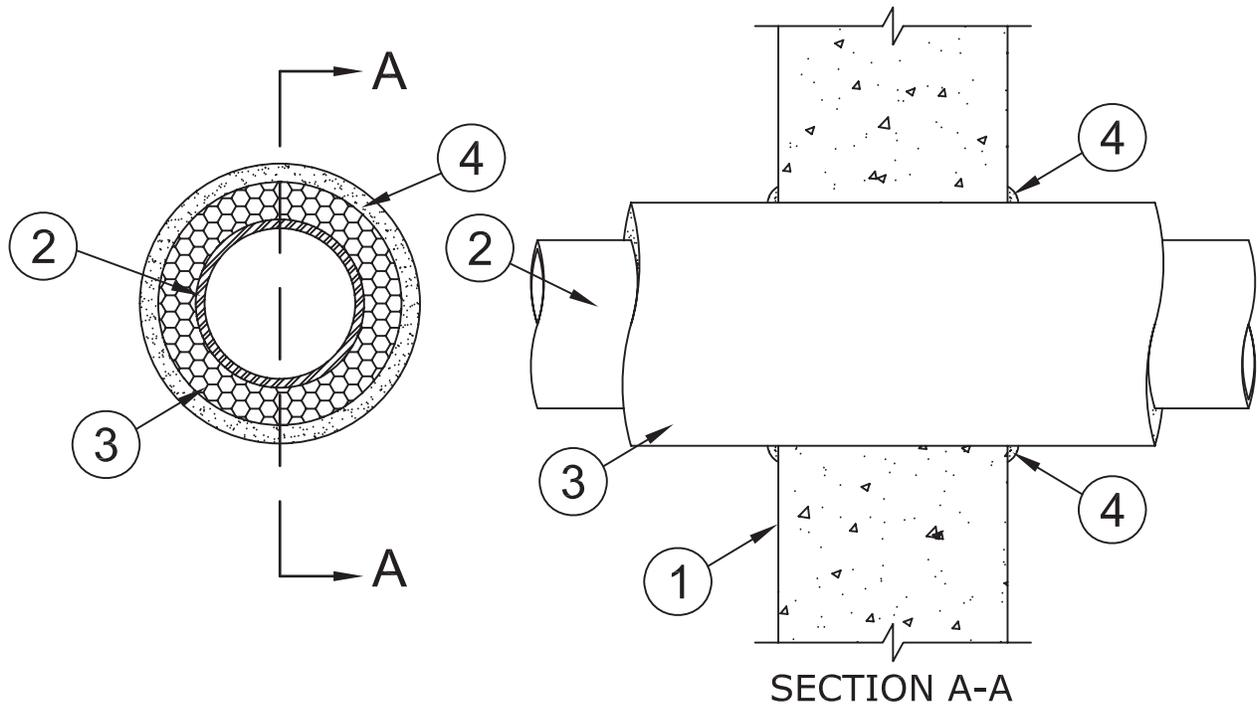

- Wall Assembly** – Min 6 in. (152 mm) thick reinforced lightweight or normal weight (100-150 pcf or 1600 - 2400 kg/m³) concrete wall. Wall may also be constructed of any UL Classified **Concrete Blocks***. Diam of wall opening to be equal to the outside diam of insulated pipe or tube.

See **Concrete Blocks** (CAZT) category in the Fire Resistance Directory for names of manufacturers.

- Through Penetrant** – One metallic pipe or tube to be installed eccentrically or concentrically within the firestop system. Pipe or tube to be rigidly supported on both sides of the wall assembly. The following types and sizes of metallic pipes and tubes may be used:
 - Steel Pipe** – Nom 2 in. (51 mm) diam (or smaller) Schedule 5 (or heavier) steel pipe.
 - Iron Pipe** – Nom 2 in. (51 mm) diam (or smaller) cast or ductile iron pipe.
 - Copper Pipe** – Nom 2 in. (51 mm) diam (or smaller) Regular (or heavier) copper pipe.
 - Copper Tube** – Nom 2 in. (51 mm) diam (or smaller) Type L (or heavier) copper tube.
- Pipe Covering*** – Nom. 1-1/2 in. (38 mm) thick hollow cylindrical heavy density glass fiber units jacketed on the outside with an all service jacket. Longitudinal joints sealed with metal fasteners or factory applied self-sealing lap tape. Transverse joints secured with metal fasteners or with butt tape supplied with the product. The annular spacing between pipe covering and periphery of opening shall be min. 0 in. (continuous point contact).

See **Pipe and Equipment Covering-Materials** (BRGU) category in the Building Materials Directory for names of manufacturers. Any pipe covering material meeting the above specifications and bearing the UL Classification Marking with a Flame Spread Index of 25 or less and a Smoke Developed Index of 50 or less may be used.

- Fill, Void or Cavity Material*** – Min 1/2 in. (13 mm) thickness of fill material applied at the pipe covering/gypsum board interface to lap onto the wall surfaces on both sides of wall.

3M COMPANY

3M FIRE PROTECTION PRODUCTS – Type CP-25WB+ Caulk, FB-3000WT Sealant

*Bearing the UL Classification Mark

Reprinted from the Online Certifications Directory with permission from Underwriters Laboratories Inc.

Copyright © 2010 Underwriters Laboratories Inc.®



Insulated Pipes • Gypsum

| 3M UL Systems | "F" Rating | 3M Product | Through Penetrant Details |
|---------------|------------|--|---|
| W-L-5001 | 1, 2 | 3M™ Fire Barrier Sealant CP 25WB+ 3M™ Fire Barrier Sealant IC 15WB+ 3M™ Fire Barrier Sealant FD 150+ 3M™ Fire Barrier Wrap Strips FS-195+ | 12" steel, 6" copper: 2" fiberglass. Also referred as WL5001. |
| W-L-5002 | 1, 2 | 3M™ Fire Barrier Sealant CP 25WB+ 3M™ Fire Barrier Sealant IC 15WB+ 3M™ Fire Barrier Sealant FD 150+ 3M™ Fire Barrier Wrap Strips FS-195+ 3M™ Fire Barrier RC-1 Restricting Collar | 4" steel or copper: 1" fiberglass, steel collar. Also referred as WL5002. |
| W-L-5009 | 2 | 3M™ Fire Barrier Sealant CP 25WB+ 3M™ Fire Barrier Sealant IC 15WB+ 3M™ Fire Barrier Sealant FD 150+ 3M™ Fire Barrier Wrap Strips FS-195+ | 2" copper: 5/8" AB/PVC flexible foam. Also referred as WL5009. |
| W-L-5010 | 2 | 3M™ Fire Barrier Sealant CP 25WB+ 3M™ Fire Barrier Sealant IC 15WB+ 3M™ Fire Barrier Sealant FD 150+ 3M™ Fire Barrier Wrap Strips FS-195+ | 12" steel, 2" glass fiber: 28 gauge steel sleeve. Also referred as WL5010. |
| W-L-5011 | 1, 2 | 3M™ Fire Barrier Sealant CP 25WB+ | 12" steel, 6" copper, 1-1/2" fiberglass: 28 gauge steel sleeve. Also referred as WL5011. |
| W-L-5032 | 2 | 3M™ Fire Barrier Silicone Sealant 2000+ 3M™ Fire Barrier Water Tight Sealant 1000 NS | U300 or U400 Series gypsum wall. Max 24 in. steel, max 6 in. copper tubing, max 6 in. copper pipe. Nom 3 in. mineral fiber insulation or nom 1 in. fiberglass insulation. Max diam of opening dependent on stud type. Framed opening. Concentric/eccentric installation. 2 hour F rating. Also known as WL5032. |
| W-L-5038 | 2 | 3M™ Fire Barrier Sealant CP 25WB+ 3M™ Fire Barrier Sealant IC 15WB+ 3M™ Fire Barrier Water Tight Sealant 3000 WT | "4" steel: 3" cellular glass FOAMGLAS*. Also referred as WL5038. *Pittsburgh Corning Corp. - FOAMGLAS |
| W-L-5039 | 1, 2 | 3M™ Fire Barrier Sealant CP 25WB+ 3M™ Fire Barrier Water Tight Sealant 3000 WT | Max. 8 in. steel or max. 4 in. copper pipe having 1/2 in. to 2 in. thick fiberglass insulation penetrating a gypsum wallboard assembly. |
| W-L-5040 | 1, 2 | 3M™ Fire Barrier Sealant CP 25WB+ | 4" steel or copper, 3/4" AB/PVC flexible foam. Also referred as WL5040. |
| W-L-5045 | 1, 2 | 3M™ Fire Barrier Sealant CP 25WB+ 3M™ Fire Barrier Sealant IC 15WB+ 3M™ Fire Barrier Water Tight Sealant 3000 WT | "12" steel: 6" copper, 3" cellular glass FOAMGLAS*. Also referred as WL5045. *Pittsburgh Corning Corp. - FOAMGLAS |
| W-L-5053 | 2 | 3M™ Fire Barrier Silicone Sealant 2000+ | 6" steel, 1" glass fiber. Also referred as WL5053. |
| W-L-5089 | 2 | 3M™ Fire Barrier Water Tight Sealant 1000 NS | 16" steel pipe, 6" copper tubing or pipe, 4" steel EMT or conduit, 1-1/2" mineral fiber insulation, 28 gauge steel sleeve. Also referred as WL5089. |
| W-L-5111 | 4 | 3M™ Fire Barrier Sealant CP 25WB+ 3M™ Fire Barrier Moldable Putty Stix MP+ 3M™ Fire Barrier Wrap Ultra GS | 24" steel, 4" copper: 2" fiberglass insulation. Also referred as WL5111. |
| W-L-5124 | 1 | 3M™ Fire Barrier Water Tight Sealant 1000 NS | 16" steel, cast, iron, 6" copper tubing or pipe: 1-1/2" fiberglass insulation. Also referred as WL5124. |
| W-L-5147 | 1, 2 | 3M™ Fire Barrier Sealant IC 15WB+ 3M™ Fire Barrier Sealant FD 150+ 3M™ Fire Barrier Water Tight Sealant 3000 WT | 6" steel, 6" cast or ductile iron, 6" steel conduit, 4" EMT, 2" copper tubing or pipe. Max diameter of opening 10-1/2". Concentric or eccentric installation. Point contact to max 1-1/2" annular. 1" to 1-1/2" fiberglass insulation. 1 & 2 hour F Rating. Also known as WL5147. |
| W-L-5168 | 1, 2 | 3M™ Fire Barrier Sealant CP 25WB+ 3M™ Fire Barrier Sealant IC 15WB+ | Max. 8" steel, cast iron, 4" copper tubing or pipe, max. 2" glass fiber insulation. Also referred as WL5168. |
| W-L-5169 | 1, 2 | 3M™ Fire Barrier Sealant CP 25WB+ 3M™ Fire Barrier Sealant IC 15WB+ | 4" steel, cast, iron, 2" copper tubing or pipe, 3/4" AB/PVC flexible foam. Also referred as WL5169. |
| W-L-5196 | 2 | 3M™ Fire Barrier Sealant CP 25WB+ 3M™ Fire Barrier Sealant IC 15WB+ | Max 2" steel, 2" cast iron, 2" copper pipe or tubing. Max diam of opening 6". Steel sleeve required with 1" max projection from wall. Max 3/4" AB/PVC tube insulation. Min 1/8" to max 3/4" annular. Also referred as WL5196. |
| W-L-5246 | 1, 2 | 3M™ Fire Barrier Pass-Through Products 3M™ Fire Barrier Water Tight Sealant 3000 WT 3M™ Fire Barrier Sealant CP 25WB+ 3M™ Fire Barrier Sealant IC 15WB+ 3M™ Fire Barrier Moldable Putty Stix MP+ | Square device: max area 98.5 sq. in. with max dimension of 12-1/2 in. Round device: max diam of opening 4-1/2 in. One or more penetrants through each device with concentric or eccentric installation. Max 3/4 in. steel, max 3/4 in. iron, max 3/4 in. copper tubing, max 3/4 in. copper pipe. Max 1/2 in. AB/PVC insulation. Max 6 square devices ganged or 1 round. 1 and 2 hour F. Also known as WL5246. |

Insulated Pipes • Gypsum

| 3M UL Systems | "F" Rating | 3M Product | Through Penetrant Details |
|---------------|------------|--|--|
| W-L-5264 | 1, 2 | 3M™ Fire Barrier Sealant CP 25WB+ 3M™ Fire Barrier Water Tight Sealant 3000 WT | Max 8 in. steel, max 8 in. iron, max 8 in. ductile iron pressure, max 6 in. copper tubing, max 6 in. copper pipe. 1 or 1-1/2 in. glass fiber insulation with all service jacket. Max diameter of opening 13 in. U400 or V400 series gypsum shaft wall assembly. Concentric or eccentric installation. Min 1/4 in. to max 1 in. annular. 1 & 2 hour F rating. Also known as WL5264. |
| W-L-5268 | 2 | 3M™ Fire Barrier Water Tight Sealant 3000 WT | U300, U400, V400 series wall. Opening nom 2 in. larger than OD of pipe covering. Max 6 in. steel, max 6 in. iron, max 6 in. min type L copper tubing, max 6 in. copper pipe. 3 in. fiberglass insulation. Point contact to max 2 in. annular. Eccentric or concentric installation. 2 hour F & T. Caulk only system. Also known as WL5268. |
| W-L-5288 | 1, 2 | 3M™ Fire Barrier Sealant IC 15WB+ 3M™ Fire Barrier Sealant CP 25WB+ 3M™ Fire Barrier Water Tight Sealant 3000 WT 3M™ Fire Barrier Wrap Ultra GS | Max. 2 in. PVC or CPVC pipe having 1 in. thick AB/PVC insulation penetrating a 1 or 2 hour rated gypsum wallboard assembly. |
| W-L-5289 | 1, 2 | 3M™ Fire Barrier Water Tight Sealant 3000 WT 3M™ Fire Barrier Sealant CP 25WB+ | Max 3 in. steel, max 3 in. iron, max 2 in. copper pipe, max 2 in. copper tubing. Min 6 in. concrete. Diam of opening min 1 in. to max 1-1/2 in. larger than OD of penetrant. 1 in. polyisocyanurate insulation. Concentric or eccentric installation. Band clamp with worm gear required around insulation on both sides of wall. 1 & 2 hour F. Also known as WL5289. |
| W-L-5291 | 1, 2 | 3M™ Fire Barrier Sealant CP 25WB+ 3M™ Fire Barrier Water Tight Sealant 3000 WT | Max 2 in. steel, max 2 in. iron, max 2 in. copper tubing, max 2 in. copper pipe. 1-1/2 in. glass fiber insulation with all-service jacket. U300, U400 or V400 series wall assemblies with wood or steel studs. Max diam of opening must equal OD of penetrant. Continuous point contact. 1 & 2 hour F & T rating. Also known as WL5291. |

System No. W-L-5001

May 19, 2005

F Ratings – 1 and 2 Hr (See Item 1)
T Ratings – 3/4, 1 and 1-1/2 Hr (See Item 3)
L Rating At Ambient – 2 CFM/sq ft
L Rating At 400 F – less than 1 CFM/sq ft

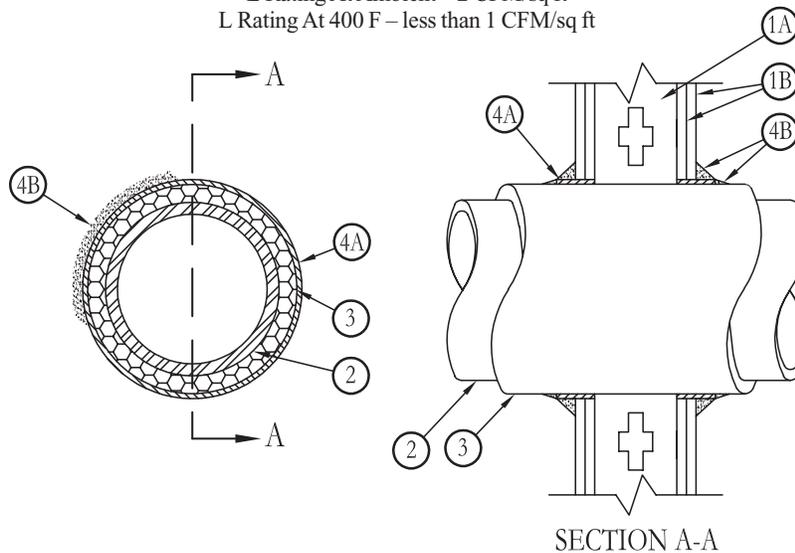

- Wall Assembly** – The 1 or 2 hr fire-rated gypsum board/stud wall assembly shall be constructed of the materials and in the manner described in the individual U300, U400 or V400 Series Wall or Partition Design in the UL Fire Resistance Directory and shall include the following construction features:
 - Studs** – Wall framing may consist of either wood studs or steel channel studs. Wood studs to consist of nom 2 in. by 4 in. (25 mm by 102 mm) lumber spaced 16 in. (406 mm) OC with nom 2 by 4 in. lumber end plates and cross braces. Steel studs to be min 3-5/8 in. (92 mm) wide by 1-3/8 in. (35 mm) deep channels spaced max 24 in. (610 mm) OC.
 - Gypsum Board*** – Nom 5/8 in. (16 mm) thick, 4 ft (122 cm) wide with square or tapered edges. The gypsum board type, thickness, number of layers, fastener type and sheet orientation shall be as specified in the individual U300 or U400 Series Design in the UL Fire Resistance Directory. Max diam of opening is 14-1/2 in (368 mm) for wood stud walls and 18 in. (457 mm) for steel stud walls.

The hourly F Rating of the firestop system is 1 hr when installed in a 1 hr fire rated wall and 2 hr when installed in a 2 hr fire rated wall.

- Through Penetrants** – One metallic pipe or tubing to be centered within the firestop system. Pipe or tubing to be rigidly supported on both sides of wall assembly. The following types and sizes of metallic pipes or tubing may be used:
 - Steel Pipe** – Nom 12 in. (305 mm) diam (or smaller) Schedule 10 (or heavier) steel pipe.
 - Copper Tubing** – Nom 6 in. (152 mm) diam (or smaller) Type L (or heavier) copper tubing.
 - Copper Pipe** – Nom 6 in. (152 mm) diam (or smaller) Regular (or heavier) copper pipe.
- Pipe Covering*** – Nom 1 in. or 2 in. (25 mm or 51 mm) thick hollow cylindrical heavy density glass fiber units jacketed on the outside with an all service jacket. Longitudinal joints sealed with metal fasteners or factory-applied self-sealing lap tape. Transverse joints sealed with metal fasteners or with butt strip tape supplied with the product. When nom 1 in. (25 mm) thick pipe covering is used, the annular space between the pipe covering and the circular cutout in the gypsum board layers on each side of the wall shall be min 1/4 in. to max 3/8 in. (6 mm to max 10 mm). When nom 2 in. (51 mm) thick pipe covering is used, the annular space between the pipe covering and the circular cutout in the gypsum board layers on each side of the wall shall be min 1/2 in. to max 3/4 in. (13 mm to max 19 mm).

See **Pipe and Equipment Covering – Materials (BRGU)** category in Building Materials Directory for names of manufacturers. Any pipe covering material meeting the above specifications and bearing the UL Classification Marking with a Flame Spread Index of 25 or less and a Smoke Developed Index of 50 or less may be used.

The hourly T Rating of the firestop system is 3/4 hr when nom 1 in. (25 mm) thick pipe covering is used. The hourly T Rating of the firestop system is 1 hr and 1-1/2 hr when nom 2 in. (51 mm) thick pipe covering is used with 1 hr and 2 hr fire rated walls, respectively.

- Firestop System** – Installed symmetrically on both sides of wall assembly. The details of the firestop system shall be as follows:
 - Fill, Void or Cavity Materials* – Wrap Strip** – Nom 1/4 in. (6 mm) thick intumescent elastomeric material faced on one side with aluminum foil, supplied in 2 in. (51 mm) wide strips. Nom 2 in. (51 mm) wide strip tightly wrapped around pipe covering (foil side out) with seam butted. Wrap strip layer securely bound with steel wire or aluminum foil tape and slid into annular space approx 1-1/4 in. (32 mm) such that approx 3/4 in. (19 mm) of the wrap strip width protrudes from the wall surface. One layer of wrap strip is required when nom 1 in. (25 mm) thick pipe covering is used. Two layers of wrap strip are required when nom 2 in. (51 mm) thick pipe covering is used.
3M COMPANY – FS-195+
 - Fill, Void or Cavity Materials* – Caulk or Sealant** – Min 1/4 in. (6 mm) diam continuous bead applied to the wrap strip/wall interface and to the exposed edge of the wrap strip layer approx 3/4 in. (19 mm) from the wall surface.
3M COMPANY – CP 25WB+, IC 15WB+, FireDam 150+ caulk or FB-3000 WT sealant

*Bearing the UL Classification Marking

Reprinted from the Online Certifications Directory with permission from Underwriters Laboratories Inc.
Copyright © 2010 Underwriters Laboratories Inc.®



System No. W-L-5002

May 19, 2005

F Ratings – 1 and 2 Hr (See Item 4)

T Ratings – 1 and 2 Hr (See Item 4)

L Rating At Ambient – 2 CFM/sq ft (See Item 4B)

L Rating At 400 F – less than 1 CFM/sq ft (See Item 4B)

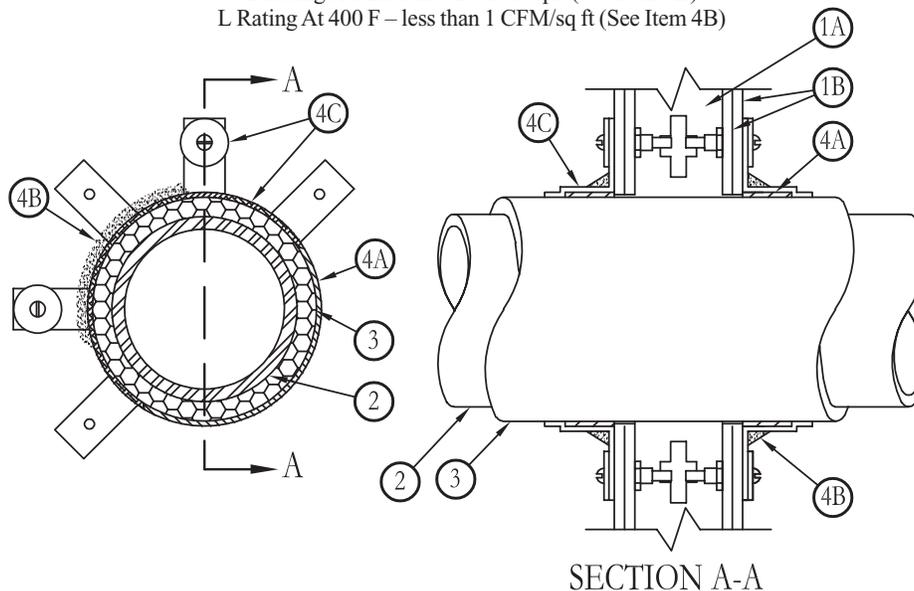

- Wall Assembly** – The 1 or 2 hr fire-rated gypsum board/stud wall assembly shall be constructed of the materials and in the manner described in the individual U300, U400 or V400 Series Wall or Partition Design in the UL Fire Resistance Directory and shall include the following construction features:

- Studs** – Wall framing may consist of either wood studs (max 2 hr fire rated assemblies) or steel channel studs. Wood studs to consist of nom 2 in. by 4 in. (51 mm by 102 mm) lumber spaced 16 in. (406 mm) OC with nom 2 in. by 4 in. (51 mm by 102 mm) lumber end plates and cross braces. Steel studs to be min 3-5/8 in. (92 mm) wide by 1-3/8 in. (35 mm) deep channels spaced max 24 in. (610 mm) OC.
- Gypsum Board*** – Nom 5/8 in. (16 mm) thick, 4 ft (122 cm) wide with squared or tapered edges. The gypsum board type, thickness, number of layers, fastener type and sheet orientation shall be as specified in the individual U300 or U400 Series Design in the UL Fire Resistance Directory.

- Pipe** – Nom 4 in. (102 mm) diam (or smaller) Schedule 10 (or heavier) steel pipe or Type L (or heavier) copper pipe. A max of one pipe is permitted in the firestop system. Pipe to be installed near center of stud cavity width and to be rigidly supported on both sides of wall assembly.
- Pipe Covering*** (Optional) – Nom 1 in. (25 mm) thick hollow cylindrical heavy density glass fiber units jacketed on the outside with an all service jacket. Longitudinal joints sealed with metal fasteners or factory-applied self-sealing lap tape. Transverse joints sealed with metal fasteners or with butt strip tape supplied with the product. The max annular space between the pipe covering and the circular cutout in the gypsum board layers on each side of the wall shall be 3/16 in. (5 mm)

See **Pipe and Equipment Covering – Materials** (BRGU) category in Building Materials Directory for names of manufacturers. Any pipe covering material meeting the above specifications and bearing the UL Classification Marking with a Flame Spread Index of 25 or less and a Smoke Developed Index of 50 or less may be used.

- Firestop System** – Installed symmetrically on both sides of wall assembly. The hourly F and T Ratings of the firestop system are 1 hr when used in a 1 hr fire rated wall and are 2 hr when used in a 2 hr fire rated wall. The details of the firestop system shall be as follows.
 - Fill, Void or Cavity Materials* – Wrap Strip** – Nom 1/4 in. (6 mm) thick intumescent elastomeric material faced on one side with aluminum foil, supplied in 2 in. (51 mm) wide strips. Nom 2 in. (51 mm) wide strip, tightly wrapped around pipe covering (foil side out) with seam butted and with edge of wrap strip abutting wall surface. Wrap strip temporarily held in position with aluminum foil tape, steel wire tie or equivalent.
3M COMPANY – FS-195+
 - Fill, Void or Cavity Materials* – Caulk or Sealant** – Generous bead of caulk applied to outer perimeter of wrap strip at interface with wall surface.
3M COMPANY – CP 25WB+, IC 15WB+, FireDam 150+ caulk or FB-3000 WT sealant
 - Steel Collar** – Nom 2 in. (51 mm) deep collar with 1-1/4 in. (32 mm) wide by 2 in. (51 mm) long anchor tabs and min 1/4 in. (6 mm) long tabs to retain wrap strip layer. Coils of precut 0.016 in. (0.41 mm) thick (No. 30 gauge) galv sheet steel available from wrap strip manufacturer. As an alternate, collar may be field-fabricated from min 0.016 in. (0.41 mm) thick (No. 30 gauge) galv sheet steel in accordance with instruction sheet supplied by wrap strip manufacturer. Steel collar, with anchor tabs bent outward 90 deg, wrapped tightly around wrap strip layer with min 1 in. (25 mm) overlap at seam. With steel anchor tabs pressed tightly against wall surface, compress collar around wrap strip layer using a min 1/2 in. (13 mm) wide by 0.028 in. (0.71 mm) thick stainless steel band clamp with worm drive tightening mechanism at the collar midheight. Secure collar to gypsum board with 3/16 in. (5 mm) diam steel toggle bolts (5/8 in. or 1-1/4 in. (16 mm or 32 mm) grip) in conjunction with min 1-1/4 in. (32 mm) diam steel washers. Four toggle bolts required, symmetrically located. As a final step, bend retainer tabs 90 deg toward pipe covering to lock wrap strip layer in position.

*Bearing the UL Classification Mark

Reprinted from the Online Certifications Directory with permission from Underwriters Laboratories Inc.
Copyright © 2010 Underwriters Laboratories Inc.®



System No. W-L-5009

May 19, 2005

F Rating – 2 Hr

T Rating – 1/2 Hr

L Rating At Ambient – less than 1 CFM/sq ft

L Rating At 400 F – less than 1 CFM/sq ft

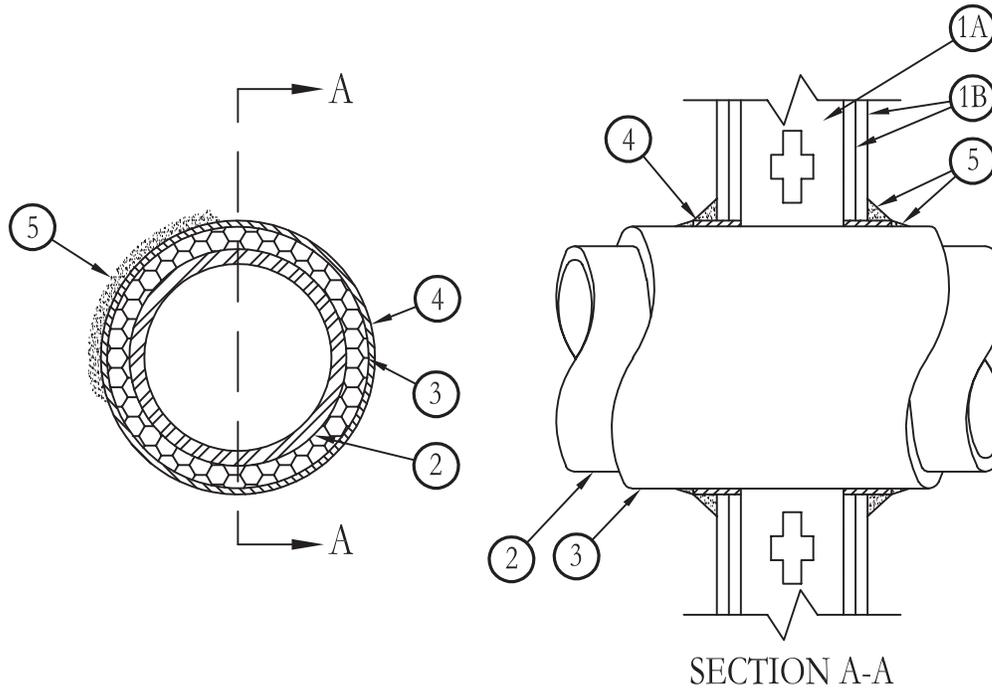

- Wall Assembly** – The fire-rated gypsum board/stud wall assembly shall be constructed of the materials and in the manner described in the individual U300, U400 or V400 Series Wall and Partition Design in the UL Fire Resistance Directory and shall include the following construction features:
 - Studs** – Wall framing may consist of either wood studs or steel channel studs. Wood studs to consist of nom 2 in. by 4 in. (51 mm by 102 mm) lumber spaced 16 in. (406 mm) OC. Steel studs to be min 3-5/8 in. (92 mm) wide and spaced max 24 in. (610 mm) OC.
 - Gypsum Board*** – Two layers of nom 5/8 in. (16 mm) thick gypsum board, as specified in the individual Wall and Partition Design. Diam of opening cut in gypsum board layers on each side of wall assembly (concentric with pipe, Item 2) to be 1/2 in. to 3/4 in. (13 mm to 19 mm) larger than outside diam of pipe insulation (Item 3) such that, when installed, a 1/4 in. to 3/8 in. (6 mm to 10 mm) annular space will be present between the pipe insulation and the gypsum board around the entire circumference of the opening. Max diam of opening is 4 in. (102 mm).
- Copper Pipe** – Nom 2 in. (51 mm) diam (or smaller) Type L (or heavier) copper pipe. A max of one pipe is permitted in the firestop system. Pipe to be installed near center of stud cavity width and is to be rigidly supported on both sides of wall assembly.
- Pipe Insulation – Plastic#** – Nom 5/8 in. (16 mm) thick acrylonitrile butadiene/polyvinyl chloride (AB/PVC) flexible foam supplied in the form of tubes with skin. Pipe insulation to be sized to outside diam of copper pipe.
See **Plastics** (QMFZ2) category in the Recognized Component Directory for names of manufacturers. Any Recognized Component pipe insulation material meeting the above specifications and having a UL94 Flammability Classification of 94-5VA may be used.
- Fill, Void or Cavity Materials* – Wrap Strip** – Nom 1/4 in. (6 mm) thick intumescent elastomeric material faced on one side with aluminum foil, supplied in 2 in. (51 mm) wide strips. Nom 2 in (51 mm) wide strip tightly wrapped around pipe insulation (foil side out) with seam butted. Wrap strip layer securely bound with steel wire or aluminum foil tape and slid into annular space approx 1-1/4 in. (32 mm) such that approx 3/4 in. (19 mm) of the wrap strip width protrudes from the wall surface. Wrap strip installed symmetrically on both sides of wall.
3M COMPANY – FS-195+
- Fill, Void or Cavity Materials* – Caulk or Sealant** – Min 1/4 in. (6 mm) diam continuous bead applied to leading edge of wrap strip layer (Item 4) prior to insertion of wrap strip layer into annular space. After insertion of wrap strip layer in annular space, a nom 1/4 in. (6 mm) diam continuous bead is to be applied to the wrap strip/wall interface and to the exposed edge of the wrap strip layer approx 3/4 in. (19 mm) from the wall surface.
3M COMPANY – CP 25WB+, IC 15WB+, FireDam 150+ caulk or FB-3000 WT sealant

#Bearing the UL Recognized Component Marking.

*Bearing the UL Classification Marking

Reprinted from the Online Certifications Directory with permission from Underwriters Laboratories Inc.
Copyright © 2010 Underwriters Laboratories Inc.®



System No. W-L-5010

May 19, 2005

F Rating – 2 Hr.

T Rating – 1-1/2 Hr.

L Rating At Ambient – 2 CFM/sq ft

L Rating At 400 F – less than 1 CFM/sq ft

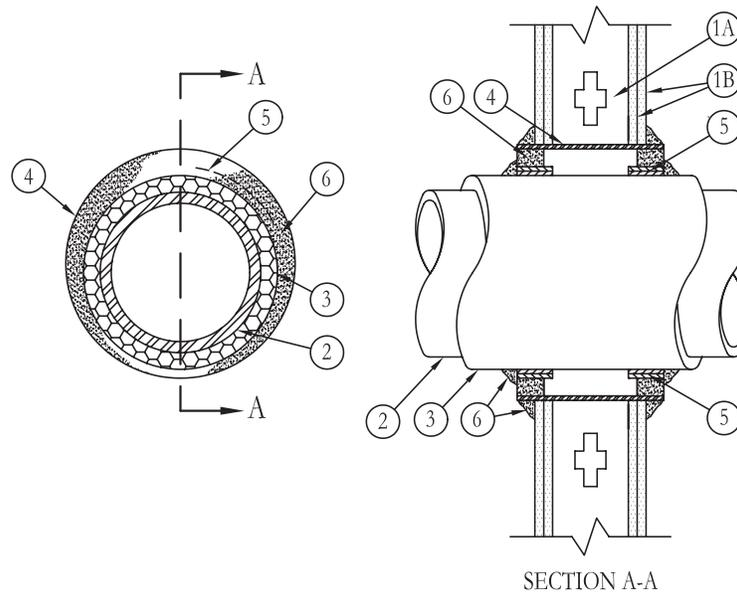

- Wall Assembly** – The fire-rated gypsum board/stud wall assembly shall be constructed of the materials and in the manner described in the individual U300, U400 or V400 Series Wall or Partition Design in the UL Fire Resistance Directory and shall include the following construction features:
 - Studs** – Wall framing may consist of either wood studs or steel channel studs. Wood studs to consist of nom 2 in. by 4 in. (51 mm by 102 mm) lumber spaced 16 in. (406 mm) OC. Steel studs to be min 3-5/8 in. (92 mm) wide and spaced max 24 in. (610 mm) OC.
 - Gypsum Board*** – Two layers of nom 5/8 in. (16 mm) thick gypsum board, as specified in the individual Wall and Partition Design. Max diam of opening is 14-1/2 in. (368 mm) for wood stud walls and 18 in. (457 mm) for steel stud walls.
- Steel Pipe** – Nom 12 in. (305 mm) diam (or smaller) Schedule 10 (or heavier) steel pipe. Pipes larger than nom 4 in. (102 mm) diam may only be used in walls constructed using steel channel studs. A max of one pipe is permitted in the firestop system. Pipe to be installed near center of stud cavity width and to be rigidly supported on both sides of wall assembly.
- Pipe Covering*** – Nom 1 in. or 2 in. (25 mm or 51 mm) thick hollow cylindrical heavy density glass fiber units jacketed on the outside with an all service jacket. Longitudinal joints sealed with metal fasteners or factory-applied self-sealing lap tape. Transverse joints sealed with metal fasteners or with butt strip tape supplied with the product.
See **Pipe and Equipment Covering – Materials (BRGU)** category in Building Materials Directory for names of manufacturers. Any pipe covering material meeting the above specifications and bearing the UL Classification Marking with a Flame Spread Index of 25 or less and a Smoke Developed Index of 50 or less may be used.
- Steel Sleeve** – Cylindrical sleeve fabricated from min 0.019 in. (0.48 mm) thick (No. 28 gauge) galv sheet steel and having a min 2 in. (51 mm) lap along the longitudinal seam. Length of steel sleeve to be equal to thickness of wall plus 1 in. (25 mm) such that, when installed, the ends of the sleeve will project approx 1/2 in. (13 mm) beyond the surface of the wall on both sides of the wall assembly. The diam of the openings cut in the gypsum board layers on each side of the wall assembly to be 1 to 2 in. (25 mm to 51 mm) larger than outside diam of pipe insulation such that, when the steel sleeve is installed, a min 1/2 in. to max 1-1/2 in. (13 mm to 38 mm) annular space will be present between the steel sleeve and the pipe insulation around the entire circumference of the pipe. Sleeve installed by coiling the sheet steel to a diam smaller than the through opening, inserting the coil through the openings and releasing the coil to let it uncoil against the circular cutouts in the gypsum board layers.
- Fill, Void or Cavity Materials* – Wrap Strip** – Nom 1/4 in. (6 mm) thick intumescent elastomeric material faced on one side with aluminum foil, supplied in 2 in. (51 mm) wide strips. Nom 2 in. (51 mm) wide strips tightly wrapped around pipe insulation (foil side exposed) and slid into steel sleeve on both sides of wall assembly. Two layers of wrap strip are required. Each layer of wrap strip to be installed with butted seam, with butted seams in successive layers staggered. Wrap strip layers on each side of wall to be installed flush with edge of steel sleeve.
3M COMPANY – FS-195+
- Fill, Void or Cavity Materials* – Caulk or Sealant** – Generous application of caulk to be applied to exposed edges of wrap strip layers and around perimeter of steel sleeve at its egress from the wall on both sides of wall assembly. When an annular space is present between the wrap strip layers and the steel sleeve, the annular space shall be filled with a min 1 in. (25 mm) depth of caulk on each side of the wall. When the annular space exceeds 1/4 in. (6 mm), packing material (polyethylene backer rod or mineral wool batt insulation) should be inserted in annular space and recessed 1 in. (25 mm) from edge of sleeve to ensure a full 1 in. (25 mm) depth of caulk is installed.
3M COMPANY – CP 25WB+, IC 15WB+, FireDam 150+ caulk or FB-3000 WT sealant

*Bearing the UL Classification Marking

Reprinted from the Online Certifications Directory with permission from Underwriters Laboratories Inc.

Copyright © 2010 Underwriters Laboratories Inc.®



System No. W-L-5011

September 07, 2004

(Formerly System No. 568)

F Ratings – 1 and 2 Hr(See Item 1)

T Ratings – 1/2 and 1 Hr(See Item 2)

L Rating At Ambient – 2 CFM/sq ft

L Rating At 400 F – less than 1 CFM/sq ft

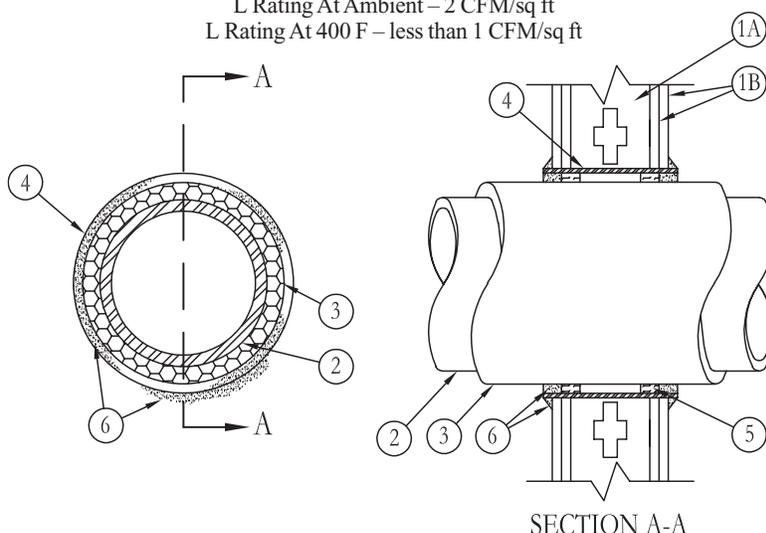

- Wall Assembly** – The 1 or 2 hr fire-rated gypsum wallboard/stud wall assembly shall be constructed of the materials and in the manner described in the individual U300 or U400 Series Wall and Partition Design in the UL Fire Resistance Directory and shall include the following construction features:

- Studs** – Wall framing may consist of either wood studs or steel channel studs. Wood studs to consist of nom 2 by 4 in. lumber spaced 16 in. OC with nom 2 by 4 in. lumber end plates and cross braces. Steel studs to be min 3-5/8 in. wide by 1-3/8 deep channels spaced max 24 in. OC.
- Gypsum Board*** – Nom 5/8 in. thick, 4 ft wide with square or tapered edges. The gypsum wallboard type, thickness, number of layers, fastener type and sheet orientation shall be as specified in the individual U300 or U400 Series Design in the UL Fire Resistance Directory. Max diam of opening is 14-1/2 in. for wood stud walls and 17 in. for steel stud walls.

The hourly F Rating of the firestop system is 1 hr when installed in a 1 hr fire rated wall and 2 hr when installed in a 2 hr fire rated wall.

- Through Penetrants** – One metallic pipe or tubing to be centered within the firestop system. Pipe or tubing to be rigidly supported on both sides of wall assembly. The following types and sizes of metallic pipes or tubing may be used:
 - Steel Pipe** – Nom 12 in. diam (or smaller) Schedule 10 (or heavier) steel pipe. When steel pipe is used, T Rating is 1 hr.
 - Copper Tubing** – Nom 6 in. diam (or smaller) Type L (or heavier) copper tubing. When copper tubing is used, T Rating is 1/2 and 1 hr when installed in 1 and 2 hr rated walls, respectively.
 - Copper Pipe** – Nom 6 in. diam (or smaller) Regular (or heavier) copper pipe. When copper pipe is used, T Rating is 1/2 and 1 hr when installed in 1 and 2 hr rated walls, respectively.
- Pipe Covering*** – Nom 1 or 1-1/2 in. thick hollow cylindrical heavy density (min 3.5 pcf) glass fiber units jacketed on the outside with an all service jacket. Longitudinal joints sealed with metal fasteners or factory-applied self-sealing lap tape. Transverse joints sealed with metal fastener strip tape supplied with the product.

See **Pipe and Equipment Coverings – Materials** – (BRGU) category in Building Materials Directory for names of manufacturers. Any pipe covering material meeting the above specifications and bearing the UL Classification Marking with a Flame Spread Index of 25 or less and a Smoke Developed Index of 50 or less may be used.

- Steel Sleeve** – Cylindrical sleeve fabricated from min 0.019 in. thick (No. 28 gauge) galv sheet steel and having a min 2 in. lap along the longitudinal seam. Length of steel sleeve to be equal to thickness of wall plus 1 in. such that, when installed, the ends of the sleeve will project approx 1/2 in. beyond the surface of the wall on both sides of the wall assembly. The diam of the openings cut in the gypsum wallboard layers on each side of the wall assembly (concentric with pipe) to be 2 to 2-1/2 in. larger than outside diam of pipe insulation such that, when the steel sleeve is installed, a 1 to 1-1/4 in. annular space will be present between the steel sleeve and the pipe insulation around the entire circumference of the pipe. Sleeve installed by coiling the sheet steel to a diam smaller than the through opening, inserting the coil through the openings and releasing the coil to let it uncoil against the circular cutouts in the gypsum wallboard layers.
- Packing Material** – Polyethylene backer rod or min 1 in. thickness of mineral wool batt insulation firmly packed into steel sleeve on both sides of the wall assembly as permanent forms. Packing material to be recessed min 1 in. from end of steel sleeve (recessed min 1/2 in. into gypsum wallboard surface) on both sides of wall assembly.
- Fill, Void or Cavity Materials*** – **Caulk or Sealant** – Min 1 in. thickness of fill material applied within annulus on both sides of wall assembly. Thickness for fill material for nom 3 in. diam (or smaller) steel pipes or conduits may be reduced to a min 1/2 in. A nom 1/4 in. diam continuous bead of caulk shall be applied around the circumference of the steel sleeve at its egress from the gypsum wallboard layers on both sides of the wall assembly.

3M COMPANY – CP 25WB+ caulk or FB-3000 WT sealant

*Bearing the UL Classification Mark

Reprinted from the Online Certifications Directory with permission from Underwriters Laboratories Inc.

Copyright © 2010 Underwriters Laboratories Inc.®



System No. W-L-5032

May 09, 2013

ANSI/UL2079
F Rating – 2 Hr
T Ratings – 1 and 2 Hr (See Items 3 and 3A)

CAN/ULC S115
F Rating – 2 Hr
FT Ratings – 1 and 2 Hr (See Items 3 and 3A)
FH Rating – 2 Hr
FTH Ratings – 1 and 2 Hr (See Items 3 and 3A)

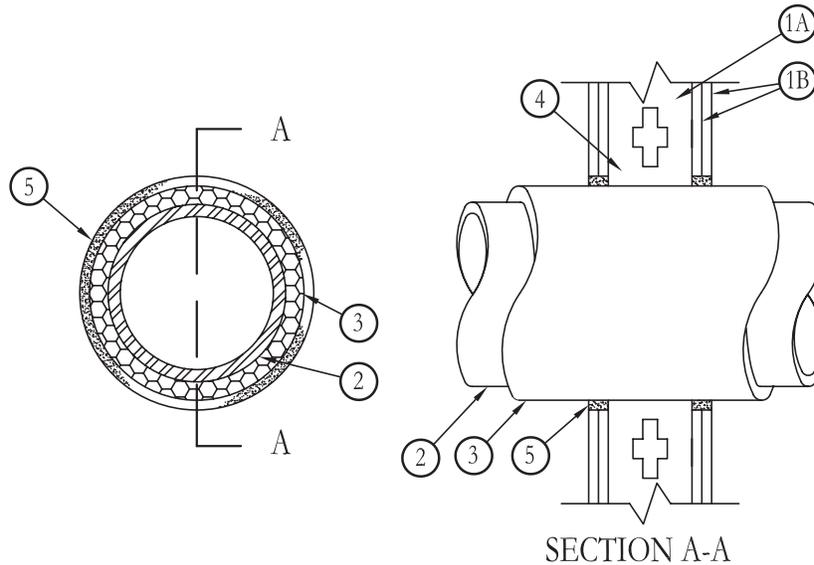

- Wall Assembly** – The fire-rated gypsum wallboard/stud wall assembly shall be constructed of the materials and in the manner specified in the individual U300 or U400 Series Wall and Partition Designs in the UL Fire Resistance Directory and shall include the following construction features:
 - Studs** – Wall framing may consist of either wood studs or steel channel studs. Wood studs to consist of nom 2 by 4 in. (51 by 102 mm) lumber spaced 16 in. (406 mm) OC. Steel studs to be min 2-1/2 in. (64 mm) wide and spaced max 24 in. (610 mm) OC. When steel studs are used and the diam at the opening exceeds the width of stud cavity, the opening shall be framed on all sides using lengths of steel stud installed between the vertical studs and screw-attached to the steel studs at each end. The framed opening in the wall shall be 7-1/2 in. (191 mm) wider and 7-1/2 in. (191 mm) higher than the diam of the penetrating item such that, when the penetrating item is centered in the opening, a 3-3/4 in. (95 mm) clearance is present between the penetrating item and the framing in all four sides.
 - Gypsum Board*** – Two layers of 5/8 in. (16 mm) thick gypsum wallboard, as specified in the individual Wall and partition Design. Max diam of opening is 14-1/2 in. (368 mm) for wood stud walls and 31-1/2 in. (800 mm) for steel stud walls.
- Through-Penetrants** – One metallic pipe or tubing to be installed either concentrically or eccentrically within the firestop system. Pipe or tubing to be rigidly supported on both sides of floor or wall assembly. The following types and sizes of metallic pipes or tubing may be used:
 - Steel Pipe** – Nom 24 in. (610 mm) diam (or smaller) Schedule 10 (or heavier) steel pipe.
 - Copper Tubing** – Nom 6 in. (152 mm) diam (or smaller) Type L (or heavier) copper tubing.
 - Copper Pipe** – Nom 6 in. (152 mm) diam (or smaller) Regular (or heavier) copper pipe.
- Pipe Covering Materials*** – Used in conjunction with Item 4. Nom 3 in. (76 mm) thick unfaced mineral fiber pipe insulation sized to the outside diam of pipe or tube. Pipe insulation secured with min 8 AWG steel wire spaced max 12 in. (305 mm) OC. An nom annular space of 3/4 in. (19 mm) is required within the firestop system. **When mineral wool pipe covering is used, the T, FT and FTH Rating is 2 hr.**

HIG MINWOOL L L C – High Temperature Pipe Insulation 1200, High Temperature Pipe Insulation BWT or High Temperature Pipe Insulation Thermaloc
- Pipe Covering*** – Used as an alternate to Item 3 and 4. Nom 1 in. (25 mm) thick hollow cylindrical heavy density (min 3.5 pcf or 56 kg/m³) glass fiber units jacketed on the outside with an all service jacket. Longitudinal joints tightly butted and sealed with metal fasteners or factory applied self-sealing lap tape. Transverse joints secured with metal fasteners or with butt tape supplied with the product. A nom annular space of 3/4 in. (19 mm) is required within the firestop system. **When glass fiber pipe covering is used, the T, FT and FTH Rating is 1 hr.**

See **Pipe and Equipment Covering – Materials (BRGU)** category in the Building Materials Directory for the names of manufacturers. Any pipe covering material meeting the above specifications and bearing the UL Classification Marking with a Flame Spread Index of 25 or less and a Smoke Developed Index of 50 or less may be used.
- Sheathing Material** – (Not shown) – Used in conjunction with Item 3. Foil-scrim-kraft or all service jacket material shall be wrapped around the outer circumference of the pipe covering material (Item 3) with the kraft side exposed. Longitudinal joints sealed with metal fasteners.

See **Sheathing Materials (BVDV)** category in the Building Materials Directory for names of manufacturers. **Any sheathing material meeting the above specifications and bearing the UL Classification Marking with a Flame Spread Index of 25 or less and a Smoke Developed Index of 50 or less may be used.**
- Fill, Void or Cavity Material* – Sealant** – Min 1-1/4 in. (32 mm) thickness of fill material applied within the annulus on both surfaces of wall. Additional fill material to be installed such that a min 1/4 in. (6 mm) crown is formed around the penetrating item.

3M COMPANY – Types FB-1000 NS, FB-2000, FB-2000+.

*Bearing the UL Classification Mark

Reprinted from the Online Certifications Directory with permission from UL
© 2013 UL LLC



System No. W-L-5038

March 23, 2016

F Rating — 2 Hr

T Rating — 2 Hr

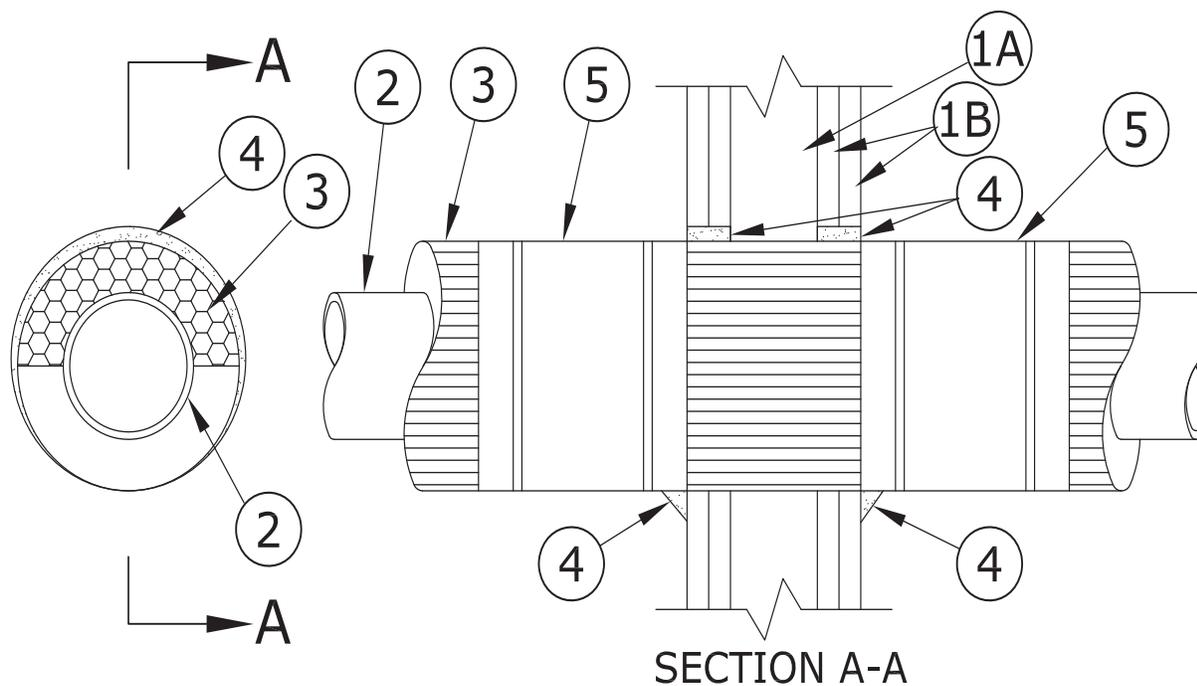

1. **Wall Assembly** — The fire-rated gypsum board/stud wall assembly shall be constructed of the materials and in the manner specified in the individual U300, U400 or V400 Series Wall or Partition Designs in the UL Fire Resistance Directory and shall include the following construction features:
 - A. **Studs** — Wall framing may consist of either wood studs or steel channel studs. Wood studs to consist of nom 2 by 4 in. (51 by 102 mm) lumber spaced 16 in. (406 mm) OC. Steel studs to be min 3-5/8 in. (92 mm) wide and spaced max 24 in. (610 mm) OC.
 - B. **Gypsum Board*** — Two layers of nom 5/8 in. (16 mm) thick gypsum board, as specified in the individual Wall and Partition Design. Max diam of opening in gypsum board layers is 11 in. (279 mm).
 2. **Steel Pipe** — Nom 4 in. (102 mm) diam (or smaller) Schedule 10 (or heavier) steel pipe. One pipe to be installed either concentrically or eccentrically within the firestop system. The annular space between the insulated pipe and the edge of the through opening shall be min 0 in. (0 mm, point contact) to max 1/2 in. (13 mm). Pipe to be rigidly supported on both sides of wall assembly.
 3. **Pipe Covering Materials*** — **Cellular Glass Insulation** — Nom 1-1/2 to 3 in. (38 to 76 mm) thick cellular glass units sized to the outside diam of the steel pipe and supplied in nom 24 in. (610 mm) long half sections or nom 18 in. (457 mm) long segments. Pipe insulation installed on pipe in accordance with the manufacturer's instructions.
 4. **Fill, Void or Cavity Materials*** — **Caulk or Sealant** — Installed to fill annular space to a min depth of 1-1/4 in. (32 mm), flush with each surface of wall. A min 1/2 in. (13 mm) diam bead of caulk shall be applied to the pipe insulation/wallboard interface at the point contact location on both sides of wall.

3M COMPANY — Type CP 25WB+, IC 15WB+ caulk or FB-3000 WT sealant
 5. **Metal Jacket** — Min 12 in. (305 mm) long jacket formed of min 0.010 in. (0.25 mm) thick steel or aluminum sheet cut to wrap tightly around the pipe insulation with a min 2 in. (51 mm) lap and secured using bands and seals of similar material. Bands to be located within 2 in. (51 mm) of each end of the jacket and spaced max 10 in. (254 mm) OC. Jacket to be installed with edge abutting surface of caulk fill material (Item 4) on each side of wall. Metal jacket to be used in addition to any other jacketing material which may be required or desired on the pipe insulation.
- * Indicates such products shall bear the UL or cUL Certification Mark for jurisdictions employing the UL or cUL Certification (such as Canada), respectively.





UL System No. W-L-5039
XHEZ – Through-penetration Firestop Systems
XHEZ7 – Through-penetration Firestop Systems Certified for Canada

May 04, 2017

| ANSI/UL1479 (ASTM E814) | CAN/ULC S115 |
|--|--|
| F Ratings – 1 and 2 Hr (See Item 1) | F Ratings – 1 and 2 Hr (See Item 1) |
| T Ratings – 0, 1 and 1-1/2 Hr (See Item 3) | FT Ratings – 0, 1 and 1-1/2 Hr (See Item 3) |
| | FH Ratings – 1 and 2 Hr (See Item 1) |
| | FTH Ratings – 0, 1 and 1-1/2 Hr (See Item 3) |

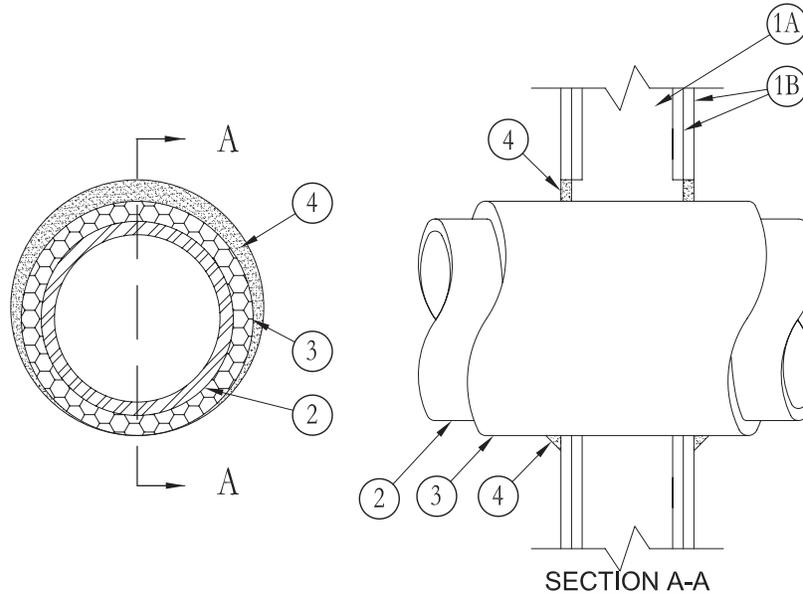

1. Wall Assembly – The 1 or 2 hr fire-rated gypsum wallboard/stud wall assembly shall be constructed of the materials and in the manner specified in the individual U300, U400, V400 or W400 Series Wall or Partition Designs in the UL Fire Resistance Directory and shall include the following construction features:

- A. Studs** – Wall framing may consist of either wood studs or steel channel studs. Wood studs to consist of nom 2 by 4 in. (51 by 102 mm) lumber spaced 16 in. (406 mm) OC. Steel studs to be min 3-5/8 in. (92 mm) wide and spaced max 24 in. (610 mm) OC.
- B. Gypsum Board*** – Nom 5/8 in. (16 mm) thick, 4 ft (122 cm) wide with square or tapered edges. The gypsum wallboard type, number of layers, fastener type and sheet orientation shall be as specified in the individual Wall and Partition Design. Max diam of opening in wallboard layers is 13-3/4 in. (349 mm).

The hourly F and FH Ratings of the firestop system are equal to the hourly fire rating of the wall assembly.

2. Through Penetrant – One metallic pipe or tube to be installed either concentrically or eccentrically within the firestop system. Pipe to be rigidly supported on both sides of wall assembly. The following types and sizes of pipe and tubing may be used:

- A. Steel Pipe** – Nom 8 in. (203 mm) diam (or smaller) Sch 10 (or heavier) steel pipe.
- B. Copper Tube** – Nom 4 in. (102 mm) diam (or smaller) Type L (or heavier) copper tubing.

3. Pipe Covering* – Nom 1/2 to 2 in. (13 to 51 mm) thick hollow cylindrical heavy density (min 3.5 pcf or 24 kg/m³) glass fiber units for 1 hr rated assemblies, nom 1/2 to 1-1/2 in. (13 to 38 mm) thick cylindrical heavy density (min 3.5 pcf or 24 kg/m³) glass fiber units for 2 hr rated assemblies, jacketed on the outside with an all service jacket. Longitudinal joints sealed with metal fasteners or factory-applied SSL tape. Transverse joints secured with metal fasteners or with butt tape supplied with the product. The annular space between the insulated pipe and the edge of the through opening shall be min 0 in. (continuous point contact) to max 1-1/4 in. (32 mm).

The hourly T, FT and FTH Ratings are 0 hr when pipe covering less than nom 1-1/2 in. (38 mm) thick is used and/or when nom penetrant diam exceeds 4 in. (102 mm). When 1-1/2 in. (38 mm) thick pipe covering is used and penetrant diam does not exceed 4 in. (102 mm), the hourly T, FT and FTH Ratings are 1 hr when installed in 1 hr rated walls. When 1-1/2 in. (38 mm) thick pipe covering is used in 2 hr rated wall, the T, FT and FTH Ratings are 1 hr when copper tube is used and 1-1/2 hr when steel pipe not exceeding 4 in. (102 mm) diam is used.

See Pipe and Equipment Covering – Materials (BRGU) category in the Building Materials Directory for names of manufacturers. Any pipe covering material meeting the above specifications and bearing the UL Classification Marking with a Flame Spread Index of 25 or less and a Smoke Developed Index of 50 or less may be used.

UL System No. W-L-5039 (cont.)

4. Fill, Void or Cavity Materials* – Caulk or Sealant – Min 5/8 in. (16 mm) thickness of caulk applied within annular space flush with each surface of wall. A min 1/2 in. (13 mm) diam bead of caulk shall be applied to the pipe insulation/ wallboard interface at the point contact location on both sides of wall.

3M COMPANY – Type CP 25WB+ or FB-3000 WT

Through Penetrations

Insulated Pipes

5000 Series

WL



*Indicates such products shall bear the UL or cUL Certification Mark for jurisdictions employing the UL or cUL Certification (such as Canada), respectively.
Reprinted from the Online Certifications Directory with permission from UL©

3M Industrial Adhesive and Tapes
Fire Protection Products
3M Center, Building 230-B-S-37
St. Paul, MN 55144-1000

System No. W-L-5040

September 07, 2004

F Ratings – 1 and 2 Hr (See Item 1)

T Ratings – 1/4, 1/2 and 3/4 Hr (See Item 2)

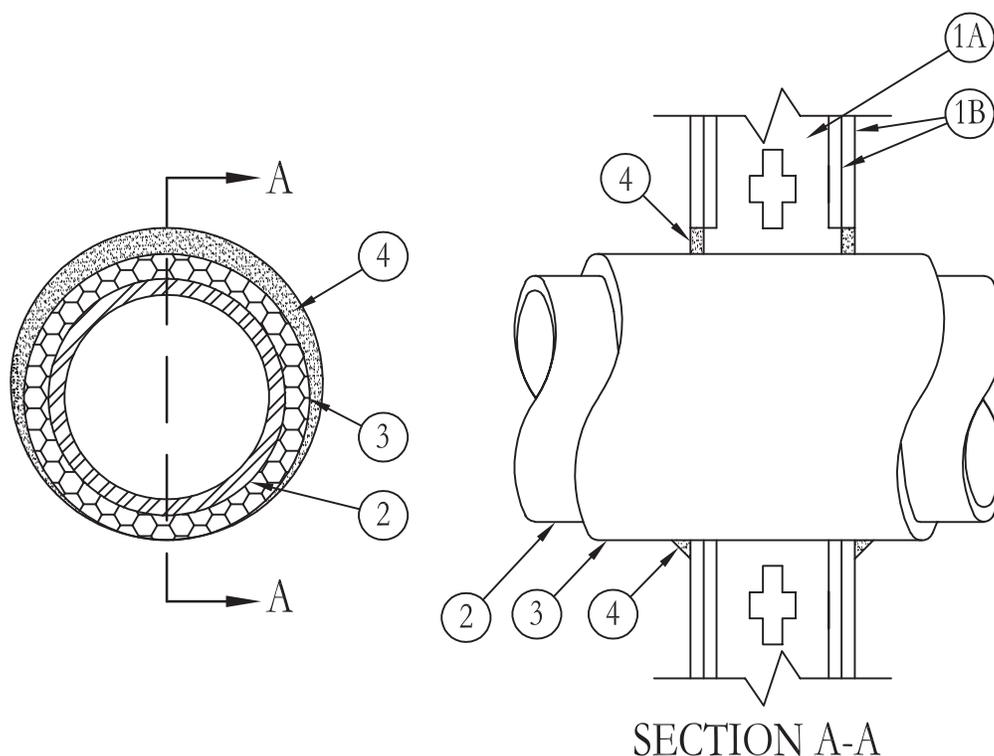

1. **Wall Assembly** – The 1 or 2 hr fire-rated gypsum wallboard/stud wall assembly shall be constructed of the materials and in the manner specified in the individual U300 or U400 Series Wall or Partition Designs in the UL Fire Resistance Directory and shall include the following construction features:

- A. **Studs** – Wall framing may consist of either wood studs or steel channel studs. Wood studs to consist of nom 2 by 4 in. lumber spaced 16 in. OC. Steel studs to be min 3-5/8 in. wide and spaced max 24 in. OC.
- B. **Gypsum Board*** – Nom 5/8 in. thick, 4 ft wide with square or tapered edges. The gypsum wallboard type, number of layers, fastener type and sheet orientation shall be as specified in the individual Wall and Partition Design. Max diam of opening in wallboard layers is 7 in.

The hourly F Rating of the firestop system is 1 hr when installed in a 1 hr fire rated wall and 2 hr when installed in a 2 hr fire rated wall.

2. **Through Penetrants** – One metallic pipe or tubing to be installed either concentrically or eccentrically within the firestop system. Pipe or tubing to be rigidly supported on both sides of wall assembly. The following types and sizes of metallic pipes or tubing may be used:
 - A. **Steel Pipe** – Nom 4 in. diam (or smaller) Schedule 10 (or heavier) steel pipe. **When steel pipe is used, T Rating is 3/4 hr.**
 - B. **Copper Tubing** – Nom 4 in. diam (or smaller) Type L (or heavier) copper tubing. **T Rating is 3/4 hr for copper tubing of nom 2 in. diam and smaller. For copper tubing greater than nom 2 in. diam, T Rating is 1/4 and 1/2 hr when installed in 1 and 2 hr rated walls, respectively.**
 - C. **Copper Pipe** – Nom 4 in. diam (or smaller) Regular (or heavier) copper pipe. **T Rating is 3/4 hr for copper pipe of nom 2 in. diam and smaller. For copper pipe greater than nom 2 in. diam, T Rating is 1/4 and 1/2 hr when installed in 1 and 2 hr rated wall respectively.**
3. **Pipe Insulation – Plastics#** – Nom 3/4 in. thick acrylonitrile butadiene/polyvinyl chloride (AB/PVC) flexible foam furnished in the form of tubing. The annular space between the insulated pipe and the edge of the through opening shall be min zero in. (point contact) to max 1-1/4 in. See **Plastics#** (QMFZ2) category in the Recognized Component Directory for names of manufacturers. Any Recognized Component tube insulation material meeting the above specifications and having a UL94 Flammability Classification of 94-5VA may be used.
4. **Fill, Void or Cavity Materials* – Caulk or Sealant** – Min 5/8 in. thickness of caulk applied within the annular space, flush with each surface of wall. A min 1/2 in. diam bead of caulk shall be applied to the pipe insulation/ wallboard interface at the point contact location on both sides of wall.

3M COMPANY – CP 25WB+ caulk or FB-3000 WT sealant

*Bearing the UL Classification Marking

Reprinted from the Online Certifications Directory with permission from Underwriters Laboratories Inc.
Copyright © 2010 Underwriters Laboratories Inc.®



System No. W-L-5045

March 23, 2016

F Ratings — 1 and 2 Hr (See Item 1)

T Ratings — 1/2, 1 and 1-1/2 Hr (See Item 3)

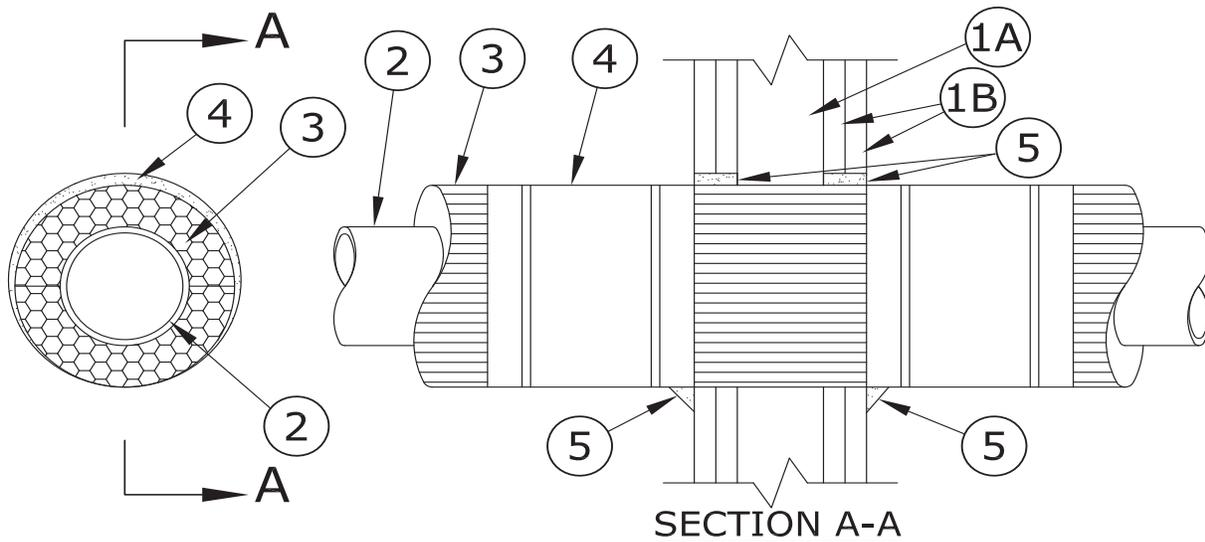

1. **Wall Assembly** — The 1 or 2 hr fire rated gypsum board/stud wall assembly shall be constructed of the materials and in the manner specified in the individual U300, U400 or V400 Series Wall and Partition Designs in the UL Fire Resistance Directory and shall include the following construction features:

A. **Studs** — Wall framing may consist of either wood studs or steel channel studs. Wood studs to consist of nom 2 by 4 in. (51 by 102 mm) lumber spaced 16 in. (406 mm) OC. Steel studs to be min 3-5/8 in. (92 mm) wide and spaced max 24 in. (610 mm) OC.

B. **Gypsum Board*** — Nom 5/8 in. (16 mm) thick gypsum board, as specified in the individual Wall and Partition Design. Max diam of opening is 14-1/2 in. (368 mm) for wood stud walls and 20 in. (508 mm) for steel stud walls.

1A. **Steel Sleeve** — (Optional, Not Shown) — Cylindrical sleeve fabricated from min 0.019 in. (0.48 mm) thick (No. 28 gauge) galv sheet steel and having a min 2 in. (51 mm) lap along the longitudinal seam. Length of steel sleeve to be equal to thickness of wall plus 1 in. (25 mm) such that, when installed, the ends of the sleeve will project approx 1/2 in. (13 mm) beyond the surface of the wall on both sides of the wall assembly. Sleeve installed by coiling the sheet steel to a diam smaller than the through opening, inserting the coil through the openings and releasing the coil to let it uncoil against the circular cutouts in the gypsum board layers.

2. **Through Penetrants** — One metallic pipe or tubing to be positioned within the firestop system. Pipe or tubing to be rigidly supported on both sides of floor or wall assembly. The following types and sizes of metallic pipes or tubing may be used:

A. **Steel Pipe** — Nom 12 in. (305 mm) diam (or smaller) Schedule 10 (or heavier) steel pipe.

B. **Copper Tubing** — Nom 6 in. (152 mm) diam (or smaller) Type L (or heavier) copper tubing.

C. **Copper Pipe** — Nom 6 in. (152) diam (or smaller) Regular (or heavier) copper pipe.

3. **Pipe Covering Materials*** — **Cellular Glass Insulation** — Nom 1-1/2 to 3 in. (38 to 76 mm) thick cellular glass units sized to the outside diam of the steel pipe and supplied in nom 24 in. (610 mm) long half sections or nom 18 in. (457 mm) long segments. Pipe insulation installed on pipe in accordance with the manufacturer's instructions. The annular space between insulation and sleeve or edge of opening shall be min 0 in. (0 mm, point contact) to max 1-1/4 in. (32 mm) **T Rating is 1/2 hr when nom 1-1/2 in. (48 mm) thick pipe insulation is used in 1 hr and 2 hr fire rated wall assembly. T Rating is 1 hr when nom 3 in. (76 mm) thick pipe insulation is used in 1 hr fire rated wall assembly. T Rating is 1-1/2 hr when nom 3 in. (76 mm) thick pipe insulation is used in 2 hr fire rated wall assembly.**

4. **Metal Jacket** — Min 12 in. (305 mm) long jacket formed of min 0.010 in. (.25 mm) thick steel or aluminum sheet cut to wrap tightly around the pipe insulation with a min 2 in. (51 mm) lap. Jacket secured with min 1/2 in. (13 mm) wide stainless steel hose clamps or bands located within 2 in. (51 mm) of each end of the jacket and spaced a max of 10 in. (254 mm) O.C. Jacket to be installed with edges abutting surface of caulk fill material (Item 5) on both surfaces of wall. Metal jacket to be used in addition to any other jacketing material which may be required or desired on the pipe insulation.

5. **Fill, Void or Cavity Materials*** — **Caulk or Sealant** — Installed to fill annular space to a min depth of the gypsum board, flush with both surfaces of wall. A min 1/2 in. (13 mm) diam bead of caulk shall be applied to the pipe insulation/gypsum board interface at the point contact location on both sides of wall.

3M COMPANY — CP 25WB+, IC 15WB+ caulk or FB-3000 WT sealant

* Indicates such products shall bear the UL or cUL Certification Mark for jurisdictions employing the UL or cUL Certification (such as Canada), respectively.



System No. W-L-5053

July 29, 1995
 F Rating – 2 Hr
 T Rating – 1 Hr

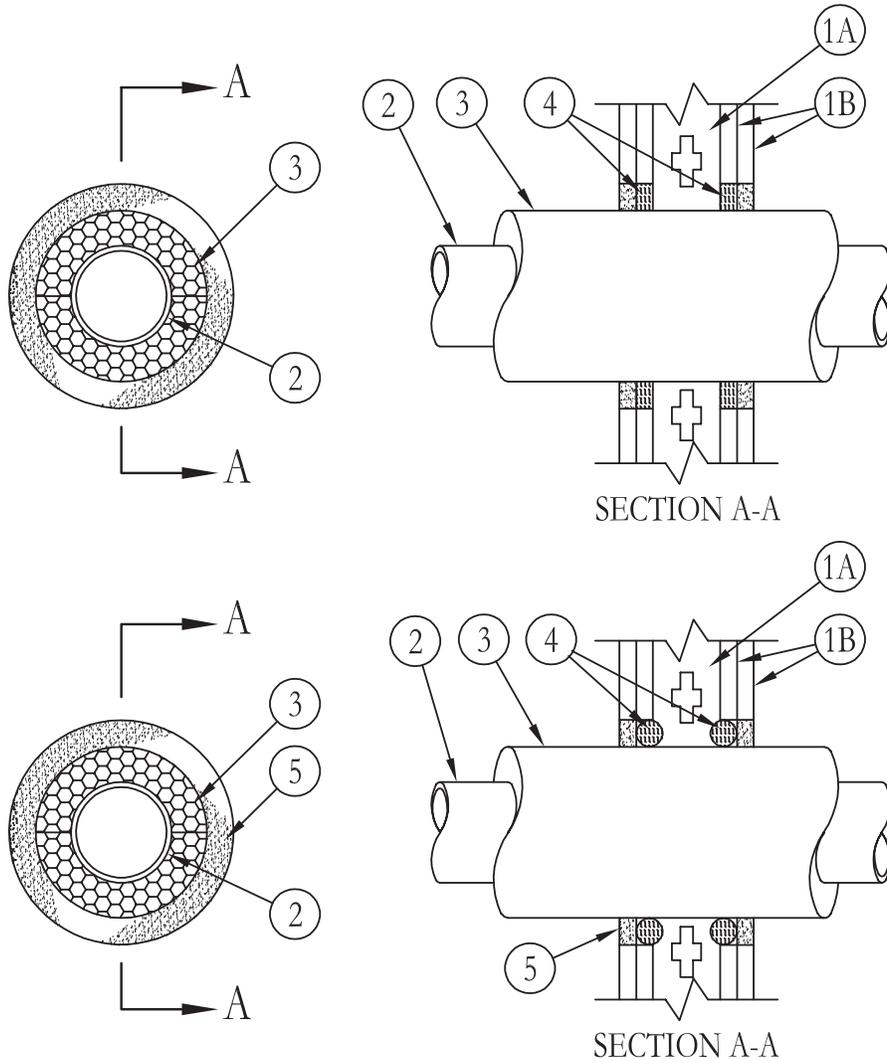

1. **Wall Assembly** – The fire rated gypsum wallboard/stud wall assembly shall be constructed of the materials and in the manner specified in the individual U300 or U400 Series Wall and Partition Designs in the UL Fire Resistance Directory and shall include the following construction features:
 - A. **Studs** – Wall framing may consist of either wood studs or steel channel studs. Wood studs to consist of nom 2 by 4 in. lumber spaced 16 in. OC. Steel studs to be min 3-1/2 in. wide and spaced max 24 in. OC.
 - B. **Gypsum Board*** – Two layers of nom 5/8 in. thick gypsum wallboard, as specified in the individual Wall and Partition Design. Diam of opening is 1-1/2 in. larger than the outside diam of pipe.
2. **Steel Pipe** – Nom 6 in. diam (or smaller) Schedule 10 (or heavier) 6 steel pipe to be centered within the firestop system. Pipe to be rigidly supported on both sides of floor or wall assembly.
3. **Pipe Covering*** – Nom 1 in. thick hollow cylindrical heavy density glass fiber units jacketed on the outside with an all service jacket. Longitudinal joints tightly butted and sealed with metal fasteners or factory applied self-sealing lap tape. Transverse joints secured with metal fasteners or with butt tape supplied with the product. An annular space of 3/4 in. is required within the firestop system.
 See **Pipe and Equipment Covering – Materials (BRGU)** category in the Building Materials Directory for names of manufacturers. Any pipe covering material meeting the above specification and bearing the UL Classification Marking with a Flame Spread Index of 25 or less and a Smoke Developed Index of 50 or less may be used.
4. **Forming Material** – Nom 1 in. diam polyethylene backer rod friction fitted into opening as a permanent form. Forming material to be recessed from both surfaces of wall as required to accommodate the required thickness of fill material.
5. **Fill, Void or Cavity Material* – Sealant** – Min 5/8 in. thickness of fill material applied within annulus, flush with both surfaces of wall assembly.

3M COMPANY – FB-2000+

*Bearing the UL Classification Marking

Reprinted from the Online Certifications Directory with permission from Underwriters Laboratories Inc.
 Copyright © 2010 Underwriters Laboratories Inc.®

System No. W-L-5089

September 07, 2004

F Rating – 2 Hr

T Ratings – 1 and 1-1/4 Hrs (See Item 2)

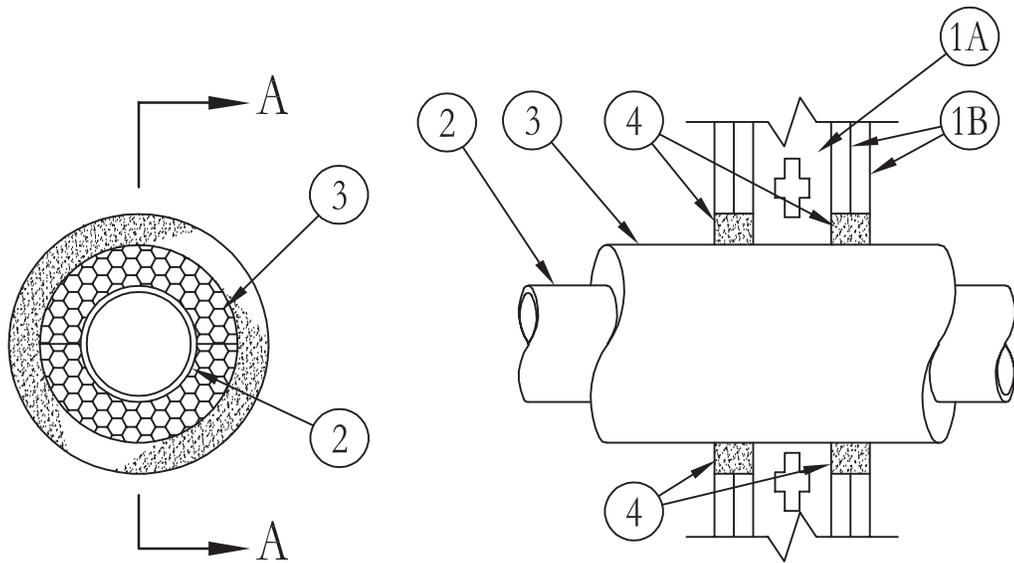

SECTION A-A

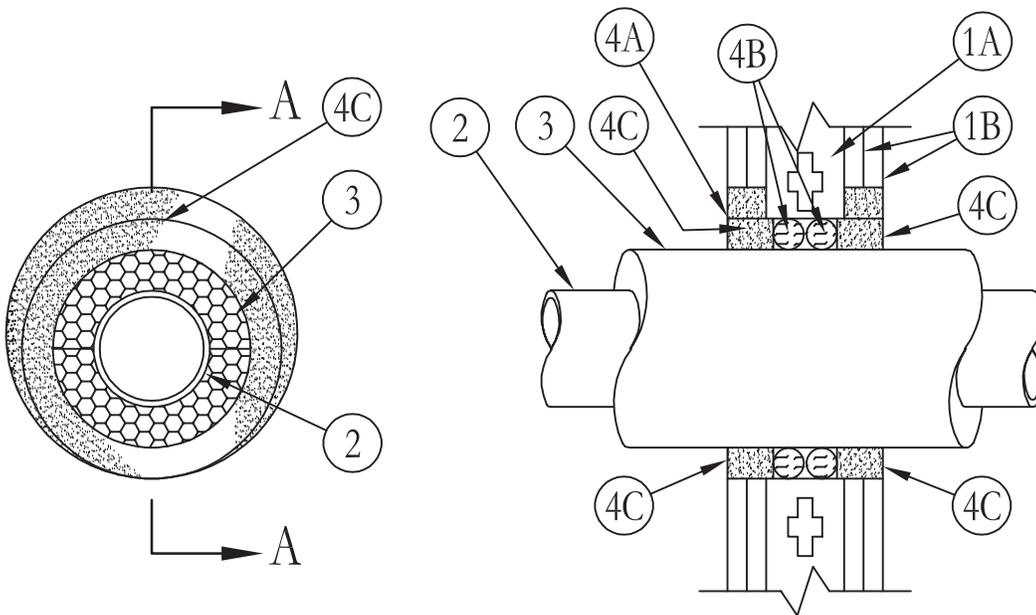

SECTION A-A

1. **Wall Assembly** – The fire-rated gypsum wallboard/stud wall assembly shall be constructed of the materials and in the manner specified in the individual U300 or U400 Series Wall and Partition Designs in the UL Fire Resistance Directory and shall include the following construction features:
 - A. **Studs** – Wall framing may consist of either wood studs or steel channel studs. Wood studs to consist of nom 2 by 4 in. lumber spaced 16 in. OC. Steel studs to be min 2-1/2 in. wide and spaced max 24 in. OC.
 - B. **Gypsum Board*** – Two layers of nom 5/8 in. thick gypsum wallboard, as specified in the individual Wall and Partition Design. Max diam of opening is 21-3/4 in.
2. **Through Penetrant** – One metallic pipe, conduit or tubing installed either concentrically or eccentrically within the firestop system. Pipe, conduit or tubing to be rigidly supported on both sides of wall assembly. The following types of pipe, conduit or tubing may be used:
 - A. **Steel Pipe** – Nom 16 in. diam (or smaller) Schedule 30 (or heavier) steel pipe.
 - B. **Copper Tubing** – Nom 6 in. diam (or smaller) Type L (or heavier) copper tubing.
 - C. **Copper Pipe** – Nom 6 in. diam (or smaller) Regular (or heavier) copper pipe.

System No. W-L-5089 *continued*

D. **Conduit** – Nom 4 in. diam (or smaller) steel electrical metallic tubing (EMT) or steel conduit.

The T Ratings are dependent on the types and sizes of pipes used in conjunction with the type and thickness of pipe coverings (Item 3) used as shown in the following table:

| Nom Pipe Diam | Pipe Type | Insulation Type | Nom Insulation Thkns In. | T Rating Hr |
|---------------|-----------|----------------------------|--------------------------|-------------|
| 1/2 to 6 | copper | fiberglass or mineral wool | 1 & 1-1/2 | 1-1/4 |
| 1/2 to 6 | steel | fiberglass or mineral wool | 1 & 1-1/2 | 1-1/4 |
| 6-1/2 to 16 | steel | mineral wool | 1 & 1-1/2 | 1 |

Firestop Configuration A

3. **Pipe Covering*** – Nom 1 or 1-1/2 in. thick hollow cylindrical heavy density (min 7.0 pcf) mineral fiber units jacketed on the outside with an all service jacket. Longitudinal joints sealed with metal fasteners or factory-applied self-sealing lap tape. Transverse joints secured with metal fasteners or with butt tape supplied with the product. The annular space shall be min 1/2 in. to max 1-3/8 in.

See **Pipe and Equipment Covering – Materials** (BRGU) category in the Building Materials Directory for names of manufacturers. Any pipe covering material meeting the above specifications and bearing the UL Classification Marking with a Flame Spread Index of 25 or less and a Smoke Developed Index of 50 or less may be used.

4. **Fill, Void or Cavity Material* – Sealant** – Min 1-1/4 in. thickness of fill material applied within the annular space, flush with both surfaces of wall.

3M COMPANY – FB-1000 NS or FB-3000 WT sealant

Firestop Configuration B

3. **Pipe Covering*** – Nom 1 or 1-1/2 in. thick hollow cylindrical heavy density (min 7.0 pcf) mineral fiber units jacketed on the outside with an all service jacket. Longitudinal joints sealed with metal fasteners or factory-applied self-sealing lap tape. Transverse joints secured with metal fasteners or with butt tape supplied with the product. The annular space shall be min 1/2 in. to max 1-3/8 in.

See **Pipe and Equipment Covering – Materials*** (BRGU) category in the Building Materials Directory for names of manufacturers. Any pipe covering material meeting the above specifications and bearing the UL Classification Marking with a Flame Spread Index of 25 or less and a Smoke Developed Index of 50 or less may be used.

4. **Firestop System** – The firestop system shall consist of the following:

- A. **Metallic Sleeve** – Cylindrical sleeve fabricated from min 0.018 in. thick (No. 28 gauge) galv sheet steel and having a min 1 in. lap along the longitudinal seam. Length of steel sleeve to be equal to thickness of wall. The inside diam of sleeve shall be 1 to 1-1/2 in. larger than the outside diam of pipe covering. Sleeve is secured with two min No. 18 AWG steel tie wires located 1 to 2 in. from each end of sleeve. A min 1/2 in. annular space is required between the sleeve and the pipe covering. The annular space between the steel sleeve and the periphery of the opening shall be a min 0 in. (point contact) to a max 1-3/8 in.
- B. **Packing Material** – Polyethylene backer rod friction-fitted into annular space between the penetrating item and the sleeve on both sides of the wall and recessed a 1-1/4 in. from each end of the sleeve.
- C. **Fill, Void or Cavity Material* – Sealant** – Min 1-1/4 in. thickness of fill material applied within the annular space between the steel sleeve and the periphery of the opening, flush with both surfaces of wall. Min 1-1/4 in. thickness of fill material applied within the annular space between the steel sleeve and the pipe covering, flush with both surfaces of wall.

3M COMPANY – FB-1000 NS or FB-3000 WT sealant

*Bearing the UL Classification Mark

Reprinted from the Online Certifications Directory with permission from Underwriters Laboratories Inc.
Copyright © 2010 Underwriters Laboratories Inc.®



Through Penetrations

Insulated Pipes

5000 Series

Gypsum

WL

System No. W-L-5111

September 07, 2004

F Rating – 4 Hr

T Rating – 1 Hr

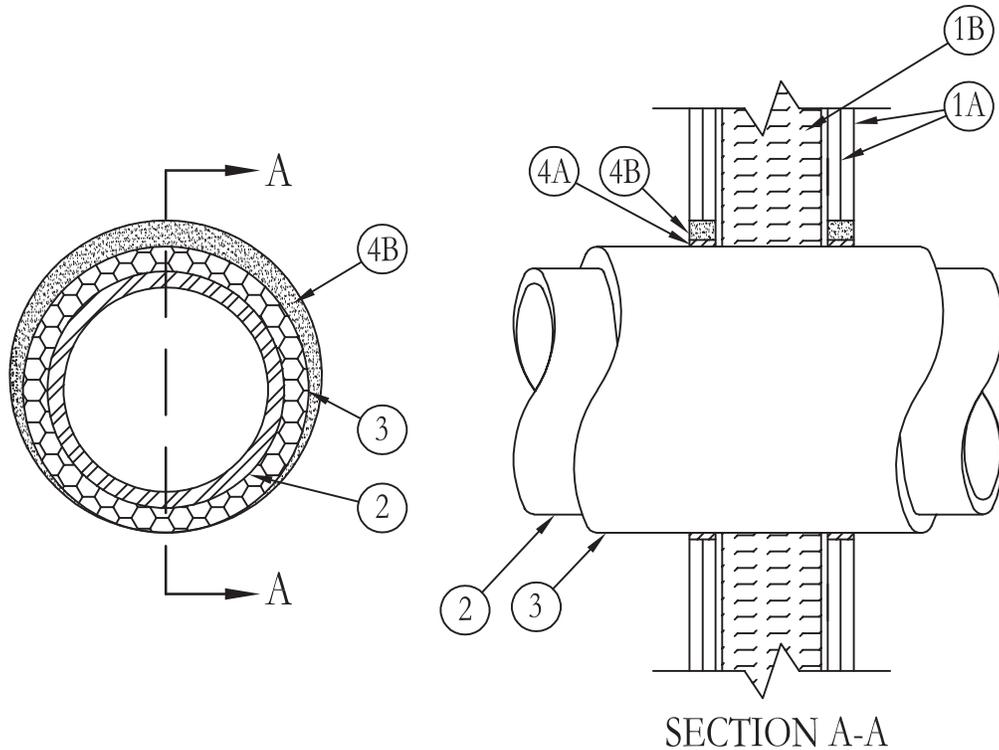

1. **Wall Assembly** – The 4 hr fire rated gypsum board/stud wall assembly shall be constructed of the materials and in the manner specified in the individual U400 Series Wall and Partition Designs in the UL Fire Resistance Directory and shall include the following construction features:
 - A. **Studs** – Wall framing consists of steel channel studs. Steel studs to be min 2-1/2 in. wide and spaced max 16 in. OC. Additional steel studs used to completely frame area of opening.
 - B. **Batts and Blankets** – Min 2 in. thickness of min 4 pcf mineral wool batt insulation was placed in the stud cavity.
 - C. **Gypsum Board*** – Two layers of nom 3/4 in. thick gypsum board, as specified in the individual Wall and Partition Design. Max size of opening is 29 in.
2. **Through Penetrants** – One metallic pipe, conduit or tubing installed either concentrically or eccentrically within the firestop system. Pipe, conduit or tubing to be rigidly supported on both sides of wall assembly. The following types and sizes of metallic pipes, conduits or tubing may be used:
 - A. **Steel Pipe** – Nom 24 in. diam (or smaller) Schedule 10 (or heavier) steel pipe.
 - B. **Copper Tubing** – Nom 4 in. diam (or smaller) Type L (or heavier) copper tubing.
 - C. **Copper Pipe** – Nom 4 in. diam (or smaller) Regular (or heavier) copper pipe.
3. **Pipe Covering** – Min 1 in. to max 2 in. thick hollow cylindrical heavy density glass fiber units jacketed on the outside with an all service jacket. Longitudinal joints tightly butted and sealed with metal fasteners or factory applied self-sealing lap tape. Annular space between the pipe covering and periphery of opening to be min of 1/4 in. to max of 3/4 in.
 See **Pipe and Equipment Coverings – Materials (BRGU)** category in the Building Materials Directory for the names of manufacturers. Any pipe covering material meeting the above specifications and bearing the UL Classification Marking with a Flame Spread Index of 25 or less and a Smoke Developed Index of 50 or less may be used.
4. **Firestop System** – The details of the firestop system shall be as follows:
 - A. **Fill, Void or Cavity Materials* – Wrap Strip** – Nom 1/8 in. thick intumescent material supplied in 2 in. wide strips. One layer of wrap strip required for 1 in. thick fiberglass pipe insulation. Two layers of wrap strip required for 1-1/2 and 2 in. thick fiberglass pipe insulation. Wrap strip layer(s) tightly wrapped around insulated pipe and held in place with 2 in. wide min 3 mil foil tape. Wrap strip to be slid into annular space on both sides of wall to be positioned to extend 1/4 in. beyond the wall surfaces. Min 18 gauge steel wire tie to be secured around middle of extending portion of wrap strip.
3M COMPANY – Ultra GS
 - B. **Fill, void or Cavity Materials* – Caulk, Sealant or Putty** – Min thickness of 3/4 in. of fill material applied within annulus, flush with both surfaces of wall assembly.
3M COMPANY – CP 25WB+, FB-3000 WT sealant or MP+ Stix putty

*Bearing the UL Classification Mark

+Bearing the UL Classification Marking

Reprinted from the Online Certifications Directory with permission from Underwriters Laboratories Inc.
 Copyright © 2010 Underwriters Laboratories Inc.®



System No. W-L-5124

September 07, 2004

F Rating – 1 Hr

T Rating – 1 Hr

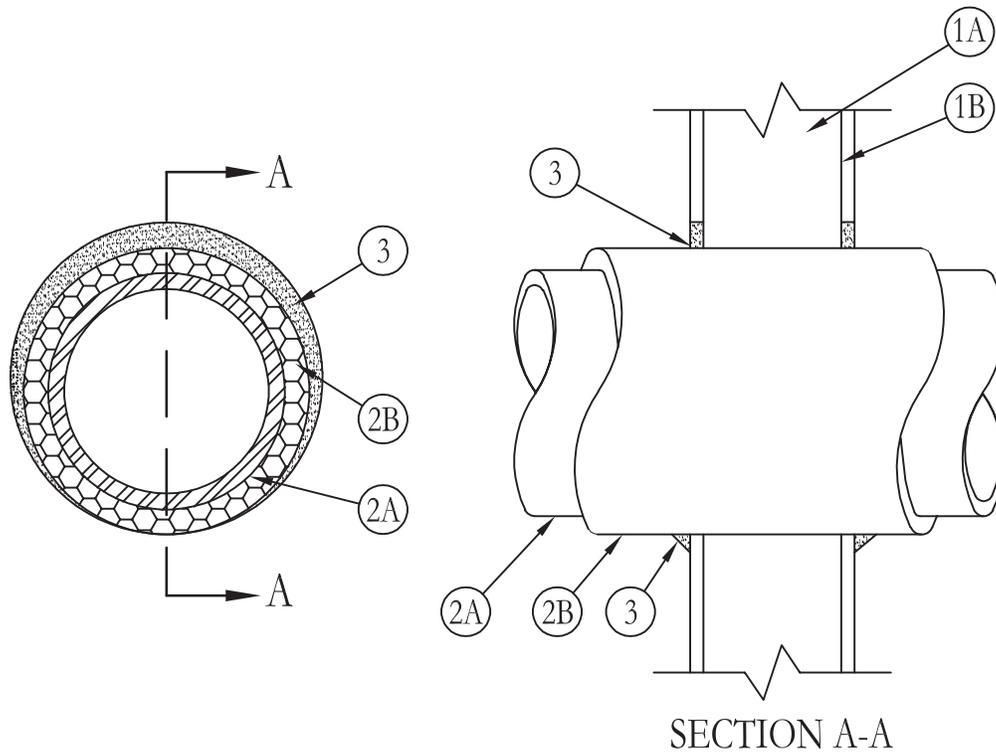

- Wall Assembly** – The 1 hr fire rated gypsum board/stud wall assembly shall be constructed of the materials and in the manner specified in the individual U400 series Wall and Partition Designs in the UL Fire Resistance Directory and shall include the following construction features:
 - Studs** – Wall framing may consist of min 2-1/2 in. wide steel channel studs spaced max 24 in. OC.
 - Gypsum* Board** – Thickness, type, number of layers and fasteners as required in the individual Wall and Partition Design. Max diam opening is 20-7/8 in.
- Through Penetrants** – Metallic pipes or tubing to be installed either concentrically or eccentrically within the firestop system. Pipe or tubing to be rigidly supported on both sides of wall assembly. The following types and sizes of metallic pipes or tubing may be used:
 - Metallic Pipes** – Max one metallic pipe or tubing. The annular space between penetrant and periphery of opening shall be min 0 in. to max 1-7/8 in. The following types and sizes of metallic pipes or tubing may be used:
 - Steel Pipe** – Nom 16 in. diam (or smaller) Schedule 10 (or heavier) steel pipe.
 - Iron Pipe** – Nom 16 in. diam (or smaller) cast or iron ductile pipe.
 - Copper Tube** – Nom 6 in. diam (or smaller) Type L (or heavier) copper tube.
 - Copper Pipe** – Nom 6 in. diam (or smaller) Regular (or heavier) copper pipe.
 - Pipe Covering*** – Max 1-1/2 in. thick hollow cylindrical heavy density glass fiber units jacketed on the outside with an all-service jacket. Longitudinal joints sealed with metal fasteners or factory applied self-sealing lap tape. Transverse joints secured with metal fasteners or with butt tape supplied with the product. The annular space shall be min 0 in. (point contact) to max 1-7/8 in. See **Pipe and Equipment Covering – Materials (BRGU)** category in the Building Materials Directory for names of manufacturers. Any pipe covering material meeting the above specifications and bearing the UL Classified Marking with a Flame Spread Index of 25 or less and a Smoke Developed Index of 50 or less may be used.
- Fill, Void or Cavity Materials* – Sealant** – Min 5/8 in. thickness of fill material applied within the annulus, flush with both surfaces of the wall. Min 1/2 in. diam bead of fill material applied to the wallboard/penetrant interface at point contact location on both surfaces of wall.
3M COMPANY – FB-1000 NS or FB-3000 WT sealant

*Bearing the UL Classification Mark

Reprinted from the Online Certifications Directory with permission from Underwriters Laboratories Inc.
Copyright © 2010 Underwriters Laboratories Inc.®



System No. W-L-5147

May 19, 2005

F Ratings – 1 and 2 Hr (See Item 1)

T Ratings – 1 and 2 Hr (See Item 1)

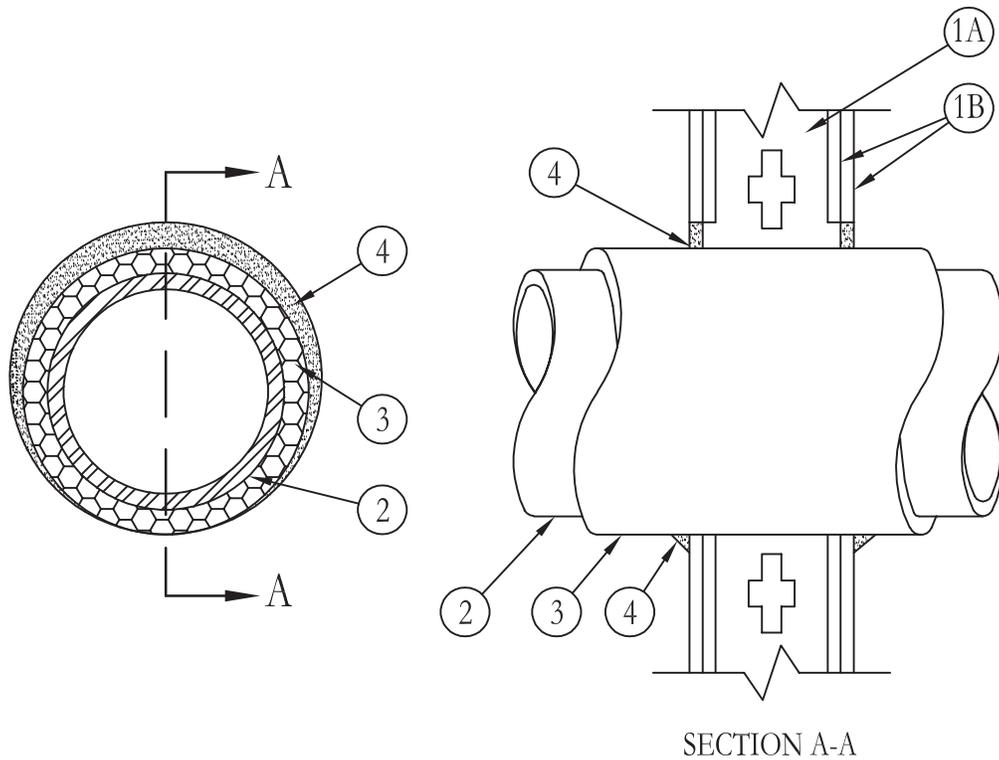

- Wall Assembly** – The 1 or 2 hr fire-rated gypsum board/stud wall assembly shall be constructed of the materials and in the manner specified in the individual U300, U400 or V400 Series Wall or Partition Designs in the UL Fire Resistance Directory and shall include the following construction features:

- Studs** – Wall framing may consist of either wood studs or steel channel studs. Wood studs to consist of nom 2 in. by 4 in. (51 mm by 102 mm) lumber spaced 16 in. (406 mm) OC. Steel studs to be min 3-5/8 in. (92 mm) wide spaced max 24 in. (610 mm) OC.
- Gypsum Board*** – Nom 5/8 in. (16 mm) thick, 4 ft (122 cm) wide with square or tapered edges. The gypsum board type, number of layers, fastener type and sheet orientation shall be as specified in the individual Wall and Partition Design. Max diam of opening is 10-1/2 in. (267 mm).

The hourly F and T Ratings for the firestop system are equal to the hourly fire rating of the wall assembly in which it is installed.

- Through Penetrants** – One metallic pipe or tubing to be installed either concentrically or eccentrically within the firestop system. Penetrants to be rigidly supported on both sides of floor or wall assembly. The following types and sizes of metallic pipes or tubings may be used:
 - Steel Pipe** – Nom 6 in. (152 mm) diam (or smaller) Schedule 10 (or heavier) steel pipe.
 - Iron Pipe** – Nom 6 in. (152 mm) diam (or smaller) cast or ductile iron pipe.
 - Conduit** – Nom 6 in. (152 mm) diam (or smaller) steel conduit, or nom 4 in. (or smaller) steel electrical metallic tubing.
 - Copper Tubing** – Nom 2 in. (51 mm) diam (or smaller) Type M (or heavier) copper tube.
 - Copper Pipe** – Nom 2 in. (51 mm) diam (or smaller) Regular (or heavier) copper pipe.
- Pipe Covering*** – Nom 1 in. or 1-1/2 in. (25 mm or 38 mm) thick hollow cylindrical heavy density glass fiber units jacketed on the outside with an all service jacket. Longitudinal joints sealed with metal fasteners or factory-applied SSL tape. Transverse joints secured with metal fasteners or with butt tape supplied with the product. The annular space between the insulated pipe and the edge of the through opening shall be min 0 in. (point contact) to max 1-1/2 in. (0 mm to max 38 mm).

See **Pipe and Equipment Covering – Materials (BRGU)** category in the Building Materials Directory for names of manufacturers. Any pipe covering material meeting the above specifications and bearing the UL Classification Marking with a Flame Spread Index of 25 or less and a Smoke Developed Index of 50 or less may be used

- Fill, Void or Cavity Material* – Caulk or Sealant** – Min 5/8 in. (16 mm) thickness of fill material applied within the annulus, flush with both surfaces of wall. Min 1/2 in. (13 mm) diam bead of caulk applied to the pipe covering/gypsum board interface at the point contact location on both sides of wall.

3M COMPANY – FireDam 150+, IC 15WB+ caulk or FB-3000 WT sealant.

*Bearing the UL Classification Mark

Reprinted from the Online Certifications Directory with permission from Underwriters Laboratories Inc.
Copyright © 2010 Underwriters Laboratories Inc.®





UL System No. W-L-5168
XHEZ - Through-penetration Firestop Systems
XHEZ7 - Through-penetration Firestop Systems Certified for Canada

July 13, 2016

| ANSI/UL1479 (ASTM E814) | CAN/ULC S115 |
|--|--|
| F Rating – 1 and 2 Hr (See Item 1) | F Rating – 1 and 2 Hr (See Item 1) |
| T Rating – 0, 1/2, 3/4, 1-1/4 and 1-1/2 Hr (See Items 2 and 4) | FT Rating – 0, 1/2, 3/4, 1-1/4 and 1-1/2 Hr (See Items 2 and 4) |
| | FH Rating – 2 Hr |
| | FTH Rating – 0, 1/2, 3/4, 1-1/4 and 1-1/2 Hr (See Items 2 and 4) |

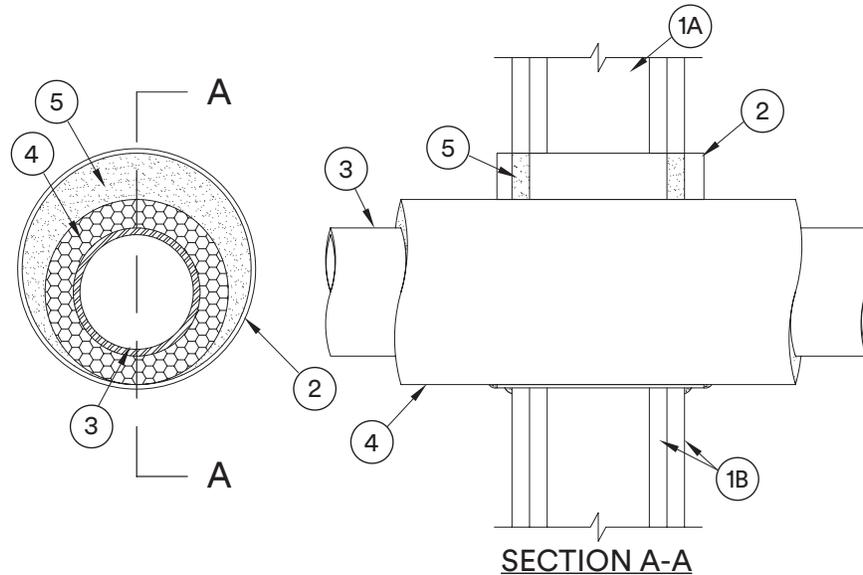

1. Wall Assembly – The 1 or 2 hr fire rated gypsum board/stud wall assembly shall be constructed of the materials and in the manner described in the individual U300, U400 or V400 Series Wall or Partition Design in the UL Fire Resistance Directory and shall include the following construction features:

- A. Studs** – Wall framing may consist of either wood studs or steel channel studs. Wood studs to consist of nom 2 by 4 in. (51 by 102 mm) lumber spaced 16 in. (406 mm) OC. Steel studs to be min 3-1/2 in. (89 mm) wide spaced max 24 in. (610 mm) OC.
- B. Gypsum Board*** – The gypsum board type, thickness, number of layers, fastener type and sheet orientation shall be as specified in the individual Design in the UL Fire Resistance Directory. Max diam of opening is 12-1/2 in. (318 mm).

The hourly F Rating of the firestop system is equal to the hourly fire rating of the wall assembly in which it is installed.

2. Steel Sleeve – (Optional) – Cylindrical sleeve fabricated from min 0.019 in.(0.49 mm) thick (28 gauge) galv sheet steel and having a min 2 in. (51 mm) lap along the longitudinal seam. Length of steel sleeve to be equal to thickness of wall or up to 2 in. (51 mm) longer than the thickness of wall such that, when installed, the ends of the sleeve will be flush with wall surface or project up to 1 in. (25 mm) beyond the surface of the wall on each side of the wall assembly. Sleeve installed by coiling the sheet steel to a diam smaller than the max 12-1/2 in. (318 mm) diam through opening, inserting the coil through the opening and releasing the coil to let it uncoil against the circular cutouts in the gypsum board layers.

The hourly T Rating is 0 hr when optional sleeve is used.

3. Through-Penetrants – One metallic pipe or tubing installed concentrically or eccentrically within opening. Penetrant to be rigidly supported on both sides of wall. The following types and sizes of penetrants may be used:

- A. Steel Pipe** – Nom 8 in. (203 mm) diam (or smaller) Schedule 10 (or heavier) steel pipe.
- B. Iron Pipe** – Nom 8 in. (203 mm) diam (or smaller) cast or ductile iron pipe.
- C. Copper Tubing** – Nom 4 in. (102 mm) diam (or smaller) Type L (or heavier) copper tubing.
- D. Copper Pipe** – Nom 4 in. (102 mm) diam (or smaller) Regular (or heavier) copper pipe.

Through Penetrations

Insulated Pipes

5000 Series

WL

UL System No. W-L-5168 (cont.)

4. **Pipe Covering*** – Nom 1 in. (25 mm), 1-1/2 in. (38 mm) or 2 in. (51 mm) thick hollow cylindrical heavy density (min 3.5 pcf or 56 kg/m³) glass fiber units jacketed on the outside with an all service jacket. Longitudinal joints sealed with metal fasteners or factory-applied SSL tape. Transverse joints secured with metal fasteners or with butt tape supplied with the product. Annular space between pipe covering and periphery of opening to be min 0 in. (0 mm, point contact) to max 1-7/8 in. (48 mm). When the steel sleeve (Item 2) is used the annular space between the pipe covering and the periphery of the opening is to be min 1/8 in. (3 mm) to max 1-3/4 in. (44 mm).

See **Pipe and Equipment Covering-Materials (BRGU)** category in the Building Materials Directory for names of manufacturers. Any pipe covering material meeting the above specifications and bearing the UL Classification Marking with a Flame Spread Index of 25 or less and a Smoke Developed Index of 50 or less may be used.

The hourly T Rating is 1-1/4 Hr for pipe coverings of nom 1 in. and 1-1/2 in. (25 mm and 38 mm) thick for 2 Hr rated assemblies. The hourly T Rating is 1-1/2 Hr for pipe coverings of nom 2 in. (51 mm) thick for 2 Hr rated assemblies. The hourly T Rating is 1/2 Hr for pipe coverings of nom 1 in. and 1-1/2 in. (25 mm and 38 mm) thick for 1 Hr rated assemblies. The hourly T Rating is 3/4 Hr for pipe coverings of nom 2 in. (51 mm) thick for 1 Hr rated assemblies.

5. **Fill, Void or Cavity Material* – Caulk or Sealant** – Min 5/8 in. (16 mm) thickness of caulk applied within annulus, flush with both surfaces of wall. Min 1/4 in. (6 mm) diam bead of caulk applied to gypsum board/pipe covering interface or gypsum board/sleeve at point contact location on both sides of wall.

3M COMPANY – IC 15WB+, CP 25WB+ caulk or FB-3000 WT sealant

Through Penetrations

Insulated Pipes

5000 Series

WL



*Indicates such products shall bear the UL or cUL Certification Mark for jurisdictions employing the UL or cUL Certification (such as Canada), respectively.

Reprinted from the Online Certifications Directory with permission from UL©

3M Industrial Adhesives and Tapes
Fire Protection Products
3M Center, Building 230-B-S-37
St. Paul, MN 55144-1000

System No. W-L-5169

May 19, 2005

F Ratings – 1 & 2 Hr (See Item 1)

T Ratings – 0 & 1 Hr (See Item 3)

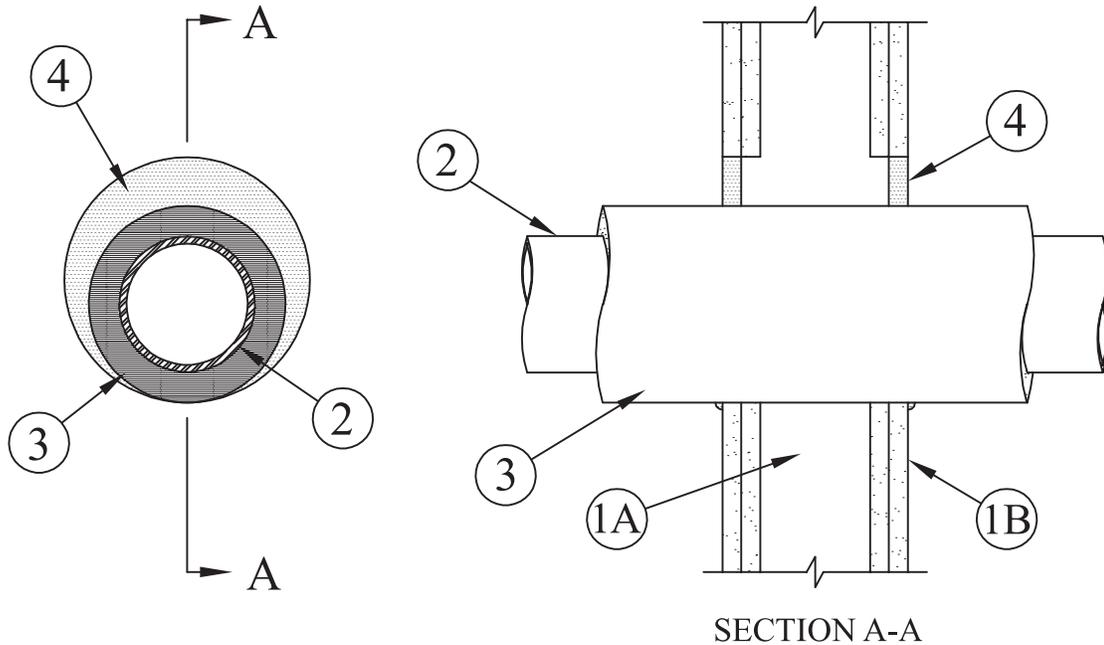

- Wall Assembly** – The 1 or 2 hr fire rated gypsum board/stud wall assembly shall be constructed of the materials and in the manner described in the individual U300, U400 or V400 Series Wall or Partition Design in the UL Fire Resistance Directory and shall include the following construction features:
 - Studs** – Wall framing may consist of either wood studs or steel channel studs. Wood studs to consist of nom 2 in. by 4 in. (51 mm by 102 mm) lumber spaced 16 in. (406 mm) OC. Steel studs to be min 3-1/2 in. (89 mm) wide spaced max 24 in. (610 mm) OC.
 - Gypsum Board*** – The gypsum board type, thickness, number of layers, fastener type and sheet orientation shall be as specified in the individual U300 or U400 Series Design in the UL Fire Resistance Directory. Max diam of opening is 7-1/2 in. (191 mm).

The hourly F Rating of the firestop system is equal to the hourly fire rating of the wall assembly in which it is installed.
- Through Penetrants** – One metallic pipe or tubing installed concentrically or eccentrically within opening. Penetrant to be rigidly supported on both sides of wall assembly. The following types and sizes of metallic pipes or tubing may be used:
 - Steel Pipe** – Nom 4 in. (102 mm) diam (or smaller) Schedule 10 (or heavier) steel pipe.
 - Iron Pipe** – Nom 4 in. (102 mm) diam (or smaller) cast or ductile iron pipe.
 - Copper Tubing** – Nom 2 in. (51 mm) diam (or smaller) Type L (or heavier) copper tubing.
 - Copper Pipe** – Nom 2 in. (51 mm) diam (or smaller) Regular (or heavier) copper pipe.
- Tube Insulation-Plastics+** – Nom 3/4 in. (19 mm) thick (or less) acrylonitrile butadiene/polyvinyl chloride (AB/PVC) flexible foam furnished in the form of tubing. Annular space between tube insulation and periphery of opening to be min 0 in. (point contact) to max 1-1/2 in. (0 mm to 38 mm).
See **Plastics (QMFZ2)** category in the Plastics Recognized Component Directory for names of manufacturers. Any Recognized Component tube insulation material meeting the above specifications and having a UL 94 Flammability Classification of 94-5A may be used.
T Rating is 1 Hr for nom 3/4 in. (19 mm) thick tube insulation in 2 Hr rated assemblies. T Rating is 0 Hr for 3/4 in. (19 mm) thick tube insulation in 1 Hr rated assemblies. T Rating is 0 Hr for tube insulations less than nom 3/4 in. (19 mm) thick in 1 and 2 Hr rated assemblies.
- Fill, Void or Cavity Material* – Caulk or Sealant** – Min 5/8 in. (16 mm) thickness of caulk applied within annulus, flush with both surfaces of wall. Min 1/4 in. (6 mm) diam bead of caulk applied to gypsum board/tube insulation interface at point contact location on both sides of wall.

3M COMPANY – CP 25WB+, IC 15WB+ caulk or FB-3000 WT sealant

*Bearing the UL Classification Marking

+Bearing the UL Recognized Component Marking

Reprinted from the Online Certifications Directory with permission from Underwriters Laboratories Inc.

Copyright © 2010 Underwriters Laboratories Inc.®



System No. W-L-5196

May 19, 2005

F Rating – 2 Hr

T Ratings – 0 & 3/4 Hr (See Item 4)

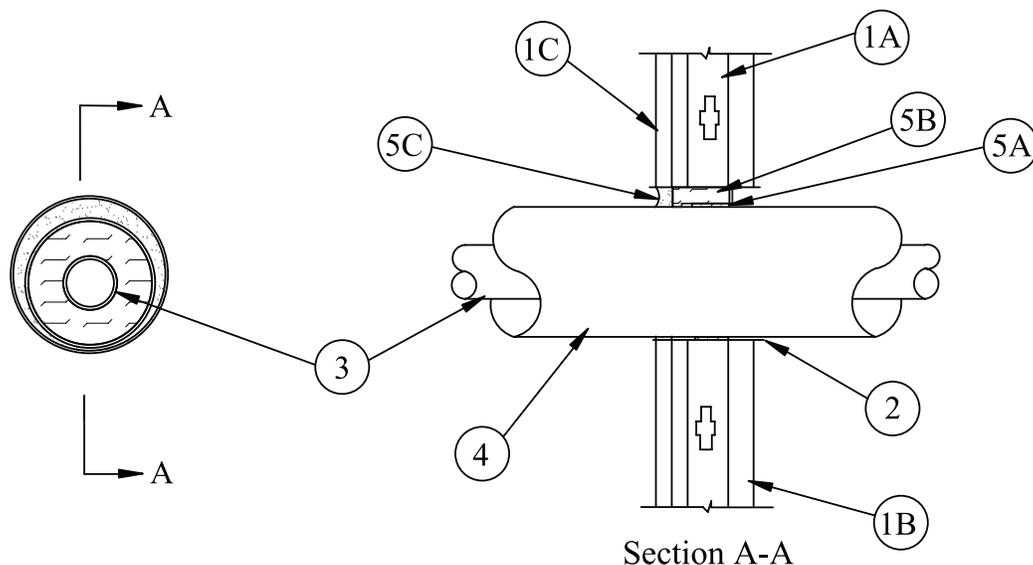

Section A-A

- Wall Assembly** – The 2 hr fire-rated shaft wall assembly shall be constructed of the materials and in the manner specified in the individual U400 or V400 Series Wall and Partition Designs in the UL Fire Resistance Directory and shall include the following construction features:
 - Steel Studs** – C-H-shaped studs, 2-1/2 in. (64 mm) wide by 1-1/2 in. (38 mm) deep, spaced 24 in. (610 mm) OC.
 - Gypsum Board*** – 1 in. (25 mm) thick gypsum board liner panels, supplied in nom 24 in. (610 mm) widths as specified in the individual Wall and Partition Design. Max diam of opening is 6 in. (152 mm).
 - Gypsum Board*** – Two layers of 5/8 in. (16 mm) thick gypsum board as specified in the individual Wall and Partition Design. Max diam of opening is 6 in. (152 mm).
- Steel Sleeve** – Cylindrical sleeve fabricated from min 0.019 in. (0.49 mm) thick (28 gauge) galv sheet steel and having a min 2 in. (51 mm) lap along the longitudinal seam. Length of steel sleeve to be equal to thickness of wall or up to 2 in. (51 mm) longer than the thickness of wall such that, when installed, the ends of the sleeve will be flush with wall surface or project up to 1 in. (25 mm) beyond the surface of the wall on each side of the wall assembly. Sleeve installed by coiling the sheet steel to a diam smaller than the max 6 in. (152 mm) diam through opening, inserting the coil through the opening and releasing the coil to let it uncoil against the circular cutouts in the gypsum board layers.
- Through Penetrants** – One metallic pipe or tube installed within the firestop system. Pipe or conduit to be rigidly supported on both sides of wall assembly. The following types of metallic pipes or tubes may be used:
 - Steel Pipe** – Nom 2 in. (51 mm) (or smaller) Schedule 5 (or heavier) steel pipe.
 - Iron Pipe** – Nom 2 in. (51 mm) (or smaller) cast or ductile iron pipe.
 - Copper Tubing** – Nom 2 in. (51 mm) (or smaller) Type L (or heavier) copper tubing.
 - Copper Pipe** – Nom 2 in. (51 mm) (or smaller) Regular (or heavier) copper pipe.
- Pipe Covering** – Nom 1/2 in. to 1-1/2 in. (13 mm to 38 mm) thick hollow cylindrical heavy density glass fiber units jacketed on the outside with an all service jacket. Longitudinal joints sealed with metal fasteners or factory-applied self-sealing lap tape. Transverse joints secured with metal fasteners or with butt tape supplied with product. Annular space between the pipe covering and sleeve shall be min 1/8 in. to max 3/4 in. (3.2 mm to max 19 mm).

See **Pipe and Equipment Covering – Materials (BRGU)** category in the Building Materials Directory for names of manufacturers. Any pipe covering material meeting the above specifications and bearing the UL Classification Marking with a Flame Spread Index of 25 or less and a smoke Developed Index of 50 or less may be used.

T Rating is 3/4 Hr when nom 1-1/2 in. (38 mm) thick pipe covering is used. T Rating is 0 Hr when pipe covering is less than nom 1-1/2 in. (38 mm) thick.

- Firestop System** – The firestop system shall consist of the following:
 - Fill, Void or Cavity Materials* – Wrap Strip** – Nom 1/8 in. (3.2 mm) thick intumescent material supplied in 2 in. (51 mm) wide strips. Min one layer of wrap strip tightly wrapped around pipe covering and held in position using foil tape. Wrap strip to be recessed from finished surface of wall (Item 1C) approx 1-3/4 in. (44 mm) such that the leading edge of wrap strip is flush with inner surface of gypsum board liner panel (Item 1B).
3M COMPANY – Ultra GS
 - Packing Material** – Min 3 in. (76 mm) thickness of min 4 pcf (64 kg/m³) mineral wool batt insulation firmly packed into opening as a permanent form. Packing material to be recessed from finished surface of wall to accommodate the required thickness of fill material.
 - Fill, Void or Cavity Materials* – Caulk or Sealant** – Min 5/8 in. (16 mm) thickness of caulk applied within annulus, flush with finished surface of wall assembly.
3M COMPANY – CP 25WB+, IC 15WB+ caulk or FB-3000 WT sealant

*Bearing the UL Classification Marking

Reprinted from the Online Certifications Directory with permission from Underwriters Laboratories Inc.
Copyright © 2010 Underwriters Laboratories Inc.®



System No. W-L-5246

May 23, 2011

F Ratings – 1 and 2 Hr (See Item 1)

T Ratings – 0 Hr

L Rating At Ambient – 4 CFM/sq ft. (See Item 4B)

L Rating At 400 F – Less Than 1 CFM/sq ft. (See Item 4B)

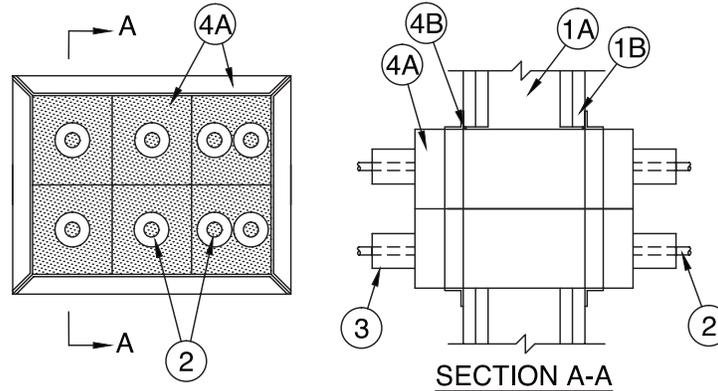

- Wall Assembly** – The 1 or 2 hr fire rated gypsum board/stud wall assembly shall be constructed of the materials and in the manner described in the individual U300, U400 or V400 Series Wall and Partition Design in the UL Fire Resistance Directory and shall include the following construction features:

- Studs** – Wall framing may consist of either wood or steel channel studs. Wood studs to consist of nom 2 by 4 in. (51 by 102 mm) lumber spaced 16 in. (406 mm) OC. Steel studs to be min 3-1/2 in. (89 mm) wide spaced max 24 in. (610 mm) OC.
- Gypsum Board*** – The gypsum board type, thickness, number of layers, fastener type and sheet orientation shall be as specified in the individual Wall and Partition Design in the UL Fire Resistance Directory. Max area of opening is 98-1/2 in.2 (635 cm²) with a max dimension of 12-1/8 in. (308 mm) for square devices. Max diam of opening is 2-1/4 in. (57 mm) for nom 2 in. (51 mm) round devices and 4-1/4 in. (108 mm) for 4 in. (102 mm) round devices.

The hourly F Rating of the firestop system is equal to the hourly fire rating of the wall assembly in which it is installed.

- Through-Penetrants** – One or more metallic pipes or tubes with tube insulation may be installed within each firestop device (Item 4A). Through penetrants to be rigidly supported on both sides of wall assembly. The following types and sizes of through-penetrants may be used:
 - Steel Pipe** – Nom 3/4 in. (19 mm) diam (or smaller) Schedule 10 (or heavier) steel pipe.
 - Iron Pipe** – Nom 3/4 in. (19 mm) diam (or smaller) cast or ductile iron pipe.
 - Copper Tubing** – Nom 3/4 in. (19 mm) diam (or smaller) Type L (or heavier) copper tube.
 - Copper Pipe** – Nom 3/4 in. (19 mm) diam (or smaller) Regular (or heavier) copper pipe.
- Tube Insulation - Plastic+** – Nom 1/2 in (13 mm) thick or smaller acrylonitrile butadiene/polyvinyl chloride (AB/PVC) flexible foam furnished in the form of tubing with skin may be used on the copper tubes. If multiple insulated through penetrants are installed within the firestop device, the insulated through penetrants may be bundled together.

See **Plastics+** (QMFZ2) category in the Plastics Recognized Component Directory for names of manufacturers. Any Recognized Component tube insulation material meeting the above specifications and having a UL 94 Flammability Classification of 94-5VA may be used.

- Firestop System** – The firestop system shall consist of the following:
 - Firestop Device*** – A max of six square firestop devices may be ganged together. As an alternate, one round device may be centered in a round opening. Each device consists of a nom 2-1/2 by 2-1/2 by 10 in. (64 by 64 by 254 mm), a nom 4 by 4 by 10 in. (102 by 102 by 254 mm), a nom 2 in. (51 mm) diam by 10 in. (254 mm) or a nom 4 in. (102 mm) diam by 10 in. (254 mm) powder coated steel transit incorporating internal intumescent material, foam plugs and mounting flanges. Firestop device(s) to be installed within opening with ends projecting an equal distance beyond each surface of wall assembly in accordance with the accompanying installation instructions. The annular space between device(s) and periphery of opening shall be min 0 in. (0 mm, point contact) to max 1/8 in. (3 mm). Firestop device(s) secured in place by means of fill material (Item 3B) and steel split mounting flanges sized to accommodate the firestop device. Steel split mounting flanges installed on both sides of wall after installation of fill material, and secured together with supplied steel set screws. Nom 1 in. (25 mm) thick pre-cut foam plugs sized to accommodate the insulated through penetrants and installed flush with each end of device on both sides of wall assembly. The foam plug in one or both ends of the device is optional except when L Rating is required (See Item 3B).

3M COMPANY – 3M Fire Barrier Pass-Through Device

- Fill, Void or Cavity Materials* – Putty or Caulk** – Min 1/8 in. (3 mm) bead of fill material shall be applied at interface of gypsum board and firestop devices immediately prior to the installation of the mounting flanges. If three or less devices (Item 3A) are ganged together, the fill material may be optional. As an option, foam plugs may be recessed into device and the recess filled with putty or caulk flush with the ends of the device. L Rating applies only when fill material is applied at interface of gypsum board and device(s) prior to mounting flanges and with both ends of firestop device(s) filled with nominal 1/8 in. (3.2 mm) of Moldable Putty+.

3M COMPANY – Moldable Putty+, CP 25WB+, IC 15WB+, 3000 WT

*Bearing the UL Classification Mark

+ Bearing the UL Recognized Component Mark

Reprinted from the Online Certifications Directory with permission from Underwriters Laboratories Inc.

Copyright © 2011 Underwriters Laboratories Inc.®



System No. W-L-5264

February 07, 2007

F Ratings – 1 and 2 Hr (See Item 1)
T Ratings – 1/2 and 1-1/4 Hr (See Item 3)

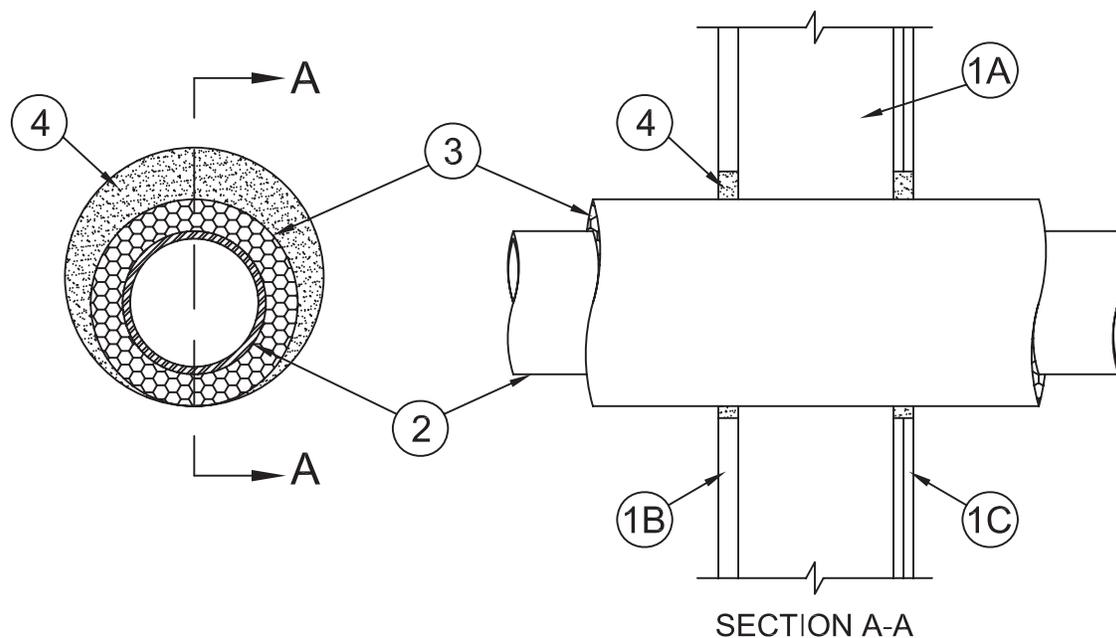

- Wall Assembly** – The 1 or 2 hr fire-rated gypsum board/stud shaft wall assembly shall be constructed of the materials and in the manner specified in the individual U400 or V400 Series Wall and Partition Designs in the UL Fire Resistance Directory and shall incorporate the following construction features:
 - Steel Studs** – “C-H” or “C-T” shaped studs, min 2-1/2 in. (64 mm) wide by 1-1/2 in. (38 mm) deep, fabricated from min No. 25 gauge (0.6 mm thick) galv steel, spaced max 24 in. (610 mm) OC.
 - Gypsum Board*** – 1 in. (25 mm) thick, 24 in. (610 mm) wide gypsum liner panels installed vertically. Diam of circular cutout in gypsum liner panel to be min 1 in. (25 mm) larger than OD of pipe covering (Item 3). Max diam of circular cutout is 13 in. (330 mm).
 - Gypsum Board*** – 1/2 in. or 5/8 in. (13 or 16 mm) thick, 48 in. (1.2 m) wide gypsum boards. The gypsum board type, thickness, number of layers, fastener type and sheet orientation shall be as specified in the individual Wall and Partition Design. Diam of circular cutout in gypsum board to be min 1 in. (25 mm) larger than OD of pipe covering (Item 3). Max diam of circular cutout is 13 in. (330 mm).

The hourly F Rating of the firestop system is equal to the hourly fire rating of the wall assembly in which it is installed.

- Through Penetrant** – One metallic pipe or tubing installed either concentrically or eccentrically within the firestop system. Pipe or tubing to be rigidly supported on both sides of wall assembly. The following types and sizes of metallic pipes or tubing may be used:
 - Steel Pipe** – Nom 8 in. (203 mm) diam (or smaller) Schedule 10 (or heavier) steel pipe.
 - Iron Pipe** – Nom 8 in. (203 mm) diam (or smaller) service weight (or heavier) cast iron soil pipe, nom 8 in. (203 mm) diam (or smaller) or Class 50 (or heavier) ductile iron pressure pipe.
 - Copper Tubing** – Nom 6 in. (152 mm) diam (or smaller) Type L (or heavier) copper tubing
 - Copper Pipe** – Nom 6 in. (152 mm) diam (or smaller) Regular (or heavier) copper pipe.
- Pipe Covering*** – Nom 1 in. (25 mm) or 1-1/2 in. (38 mm) thick hollow cylindrical heavy density (min 3.5 pcf or 56 kg/m³) glass fiber units jacketed on the outside with an all service jacket. Longitudinal joints sealed with metal fasteners or factory-applied SSL tape. Transverse joints secured with metal fasteners or with butt tape supplied with the product. Annular space between pipe covering and periphery of opening to be min 1/4 in. (6 mm) to max 1 in. (25 mm).

See **Pipe and Equipment Covering – Materials (BRGU)** category in the Building Materials Directory for names of manufacturers. Any pipe covering material meeting the above specifications and bearing the UL Classification Marking with a Flame Spread Index of 25 or less and a Smoke Developed Index of 50 or less may be used.

The hourly T Rating is 1/2 Hr for 1 Hr rated assemblies and 1-1/4 Hr for 2 Hr rated assemblies.

- Fill, Void or Cavity Materials* – Caulk or Sealant** – Caulk or sealant applied within annulus at a thickness equal to the total thickness of the gypsum board on both sides of the wall.

3M COMPANY – CP25WB+ Caulk or FB-3000 WT Sealant

*Bearing the UL Classification Mark

Reprinted from the Online Certifications Directory with permission from Underwriters Laboratories Inc.
Copyright © 2010 Underwriters Laboratories Inc.®



System No. W-L-5268

January 17, 2014

F Rating – 2 Hr

T Rating – 2 Hr

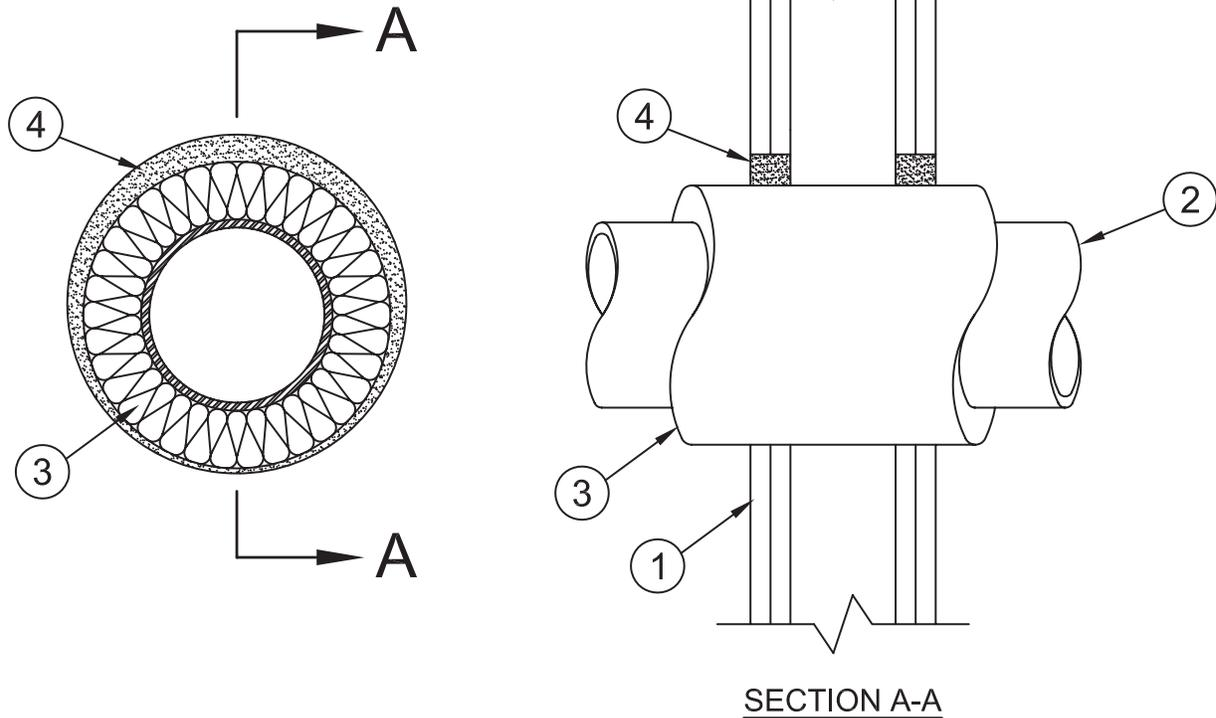

1. **Wall Assembly** – The 2 hour fire rated gypsum board/stud wall assembly shall be constructed of the materials and in the manner specified in the individual U300, U400, or V400 Series Wall and Partition Designs in the UL Fire Resistance Directory and shall include the following construction features:
 - A. **Studs** – Wall framing may consist of either wood studs or steel channel studs. Wood studs to consist of nominal 2 by 4 in. (51 by 102 mm) lumber spaced a maximum 16 in. (406 mm) OC. Steel studs to be minimum 3-1/2 in. (89 mm) wide and spaced a maximum 24 in. (610 mm) OC.
 - B. **Wallboard, Gypsum*** – Two layers of min 5/8 in. (16 mm) thick, 4 ft. (1.2 m) wide with square or tapered edges as specified in the individual Wall and Partition Design. Opening shall be sized to be nom. 2 in. (51 mm) larger than outside diam. of pipe cover (Item 3).
2. **Through Penetrants** – One metallic pipe or tubing to be installed either concentrically or eccentrically within the firestop system. Pipe or tubing to be rigidly supported on both sides of wall assembly. The following types and sizes of metallic pipes or tubing may be used:
 - A. **Steel Pipe** – Nom 6 in. (152 mm) diam (or smaller) Schedule 40 (or heavier) steel pipe.
 - B. **Iron Pipe** – Nom 6 in. (152 mm) diam (or smaller) cast or ductile iron pipe.
 - C. **Copper Tubing** – Nom 6 in. (152 mm) diam (or smaller) Type L (or heavier) copper tubing.
 - D. **Copper Pipe** – Nom 6 in. (152 mm) diam (or smaller) Regular (or heavier) copper pipe.
3. **Pipe Covering*** – Nom. 3 in. (76 mm) thick hollow cylindrical heavy density glass fiber units jacketed on the outside with an all service jacket. Longitudinal joints sealed with metal fasteners or factory applied self-sealing lap tape. Transverse joints secured with metal fasteners or with butt tape supplied with the product. The annular spacing between pipe covering and the edge of the through-opening shall be min. 0 in. (point contact) to max. 2 in. (51 mm).
See **Pipe and Equipment Covering-Materials** (BRGU) category in the Building Materials Directory for names of manufacturers. Any pipe covering material meeting the above specifications and bearing the UL Classification Marking with a Flame Spread Index of 25 or less and a Smoke Developed Index of 50 or less may be used.
4. **Fill, Void or Cavity Material* – Sealant** – Min 1-1/4 in. (32 mm) thickness of sealant applied within the gypsum board annulus, flush with the finished side of the wall. Min 1/2 in. (13 mm) diameter bead of sealant applied to the penetrant/gypsum board interface at the point contact location on the finished side of the wall.

3M COMPANY**3M FIRE PROTECTION PRODUCTS – FB-3000 WT**

*Bearing the UL Classification Mark

Reprinted from the Online Certifications Directory with permission from UL

© 2014 UL LLC



System No. W-L-5288

July 10, 2009

F Ratings — 1 and 2 Hr (See Item 1)

T Ratings — 1 and 2 Hr (See Item 1)

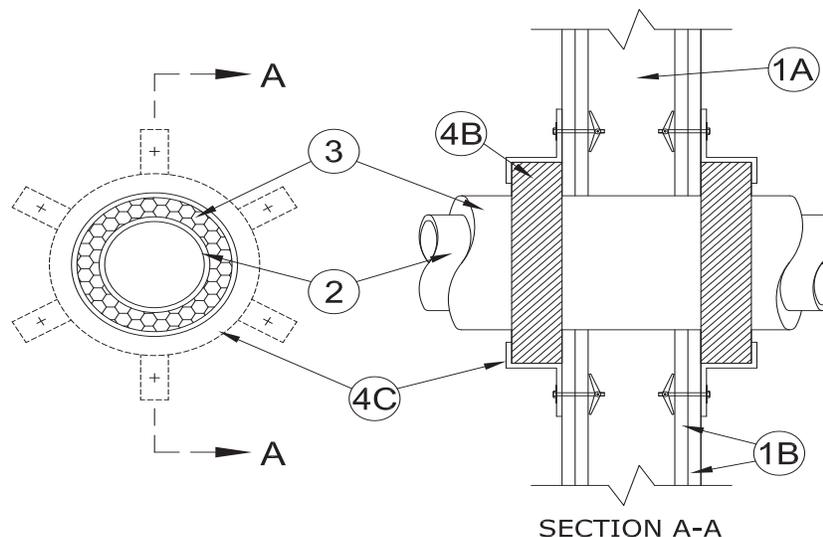

1. **Wall Assembly** — The 1 or 2 h fire rated gypsum board/stud wall assembly shall be constructed of the materials and in the manner described in the individual U300, U400 or V400 Series Wall and Partition Designs in the UL Fire Resistance Directory and shall include the following construction features:

A. **Studs** — Wall framing may consist of either wood studs or steel channel studs. Wood studs to consist of nom 2 by 4 in. (51 by 102 mm) lumber spaced 16 in. (406 mm) OC. Steel studs to be min 3-1/2 in. (89 mm) wide and spaced max 24 in. (610 mm) OC.

B. **Gypsum Board** — Thickness, type, number of layers and fasteners as specified in the individual Wall and Partition Design. Max diam of opening is 2 in. (51 mm).

The hourly F Rating of the firestop system is equal to the hourly assembly rating of the wall assembly in which it is installed.

2. **Through Penetrants** — One nonmetallic pipe to be installed either concentrically or eccentrically within the firestop system. Pipe to be rigidly supported on both sides of wall assembly. The following types and sizes of nonmetallic pipes or tubing may be used:

A. **Polyvinyl Chloride (PVC) Pipe** — Nom 2 in. (51 mm) diam (or smaller) Schedule 40 solid core PVC pipe for use in closed (process or supply) or vented (drain, waste or vent) piping systems.

B. **Chlorinated Polyvinyl Chloride (CPVC) Pipe** — Nom 2 in. (51 mm) diam (or smaller) SDR13.5 CPVC pipe for use in closed (process or supply) or vented (drain, waste or vent) piping systems.

3. **Tube Insulation - Plastics+** — Nom 1 in. (25 mm) thick acrylonitrile butadiene/polyvinyl chloride (AB/PVC) flexible foam furnished in the form of tubing. The tube insulation should be compressed and installed with continuous point contact within the opening.

See **Plastics+** (QMFZ2) (QMFZ2) category in the Plastics Recognized Component Directory for names of manufacturers. Any Recognized Component tube insulation material meeting the above specifications and having a UL 94 Flammability Classification of 94-5VA may be used.

4. **Firestop System** — The firestop system shall consist of the following:

A. **Fill, Void or Cavity Material*-Caulk or Sealant** — (Not Shown) Min 1/4 in. (6 mm) thickness of fill material applied around the outer circumference of the insulated through penetrant at the gypsum board interface on both sides of the wall assembly.

3M COMPANY 3M FIRE PROTECTION PRODUCTS — IC 15WB+, CP25WB+ or FB-3000 WT

B. **Fill, Void or Cavity Materials* — Wrap Strip** — Nom 2 in. (51 mm) wide, nom 1/4 in. (6 mm) thick intumescent elastomeric material faced on one side with aluminum foil. Two layers of wrap strip tightly wrapped around insulated through penetrant (foil side exposed) and butted against the wall surface on both sides of the wall assembly. Each layer of wrap strip to be installed with butted seams in successive layers staggered. Wrap strips temporarily held in position using aluminum foil tape, steel wire tie, or equivalent.

3M COMPANY 3M FIRE PROTECTION PRODUCTS — Ultra GS Wrap Strip

C. **Steel Collar** — Nom 2 in. (51 mm) deep collar with 1-1/4 in. (32 mm) wide by 2 in. (51 mm) long anchor tabs and min 1/2 in. (13 mm) long tabs to retain wrap strip. Coils of precut min 0.016 in. (0.41 mm) in thick (30 gauge) galv sheet steel available from wrap strip manufacturer. As an alternate, collar may be field-fabricated from min 0.016 in. (0.41 mm) thick (30 gauge) galv sheet steel in accordance with instruction sheet supplied by wrap strip manufacturer. Collar, with anchor tabs bent outward 90 degrees, wrapped tightly around wrap strip with min 1 in. (25 mm) overlap at seam and compressed around wrap strip(s) using a min 1/2 in. (13 mm) wide by min 0.028 in. (0.71 mm) thick stainless steel band at the collar midheight. As an alternate to the band clamps, collars may be secured by means of No. 10 by 3/8 in. (10 mm) long steel sheet metal screws installed in the vertical axis at the center of the 1 in. (25 mm) overlap along the perimeter joint of the collar. A min of three screws is required. Collar anchor tabs pressed tightly against wall surfaces and secured to wall surfaces with nom 3/16 in. (5 mm) diam steel toggle bolts, or equivalent, in conjunction with min 1-1/4 in. (32 mm) diam steel fender washers.

+Bearing the UL Recognized Component Mark

* Indicates such products shall bear the UL or cUL Certification Mark for jurisdictions employing the UL or cUL Certification (such as Canada), respectively.



System No. W-L-5289

July 20, 2009

F Ratings – 1 and 2 Hr (See Item 1)

T Ratings – 1 and 1-1/2 Hr (See Item 1)

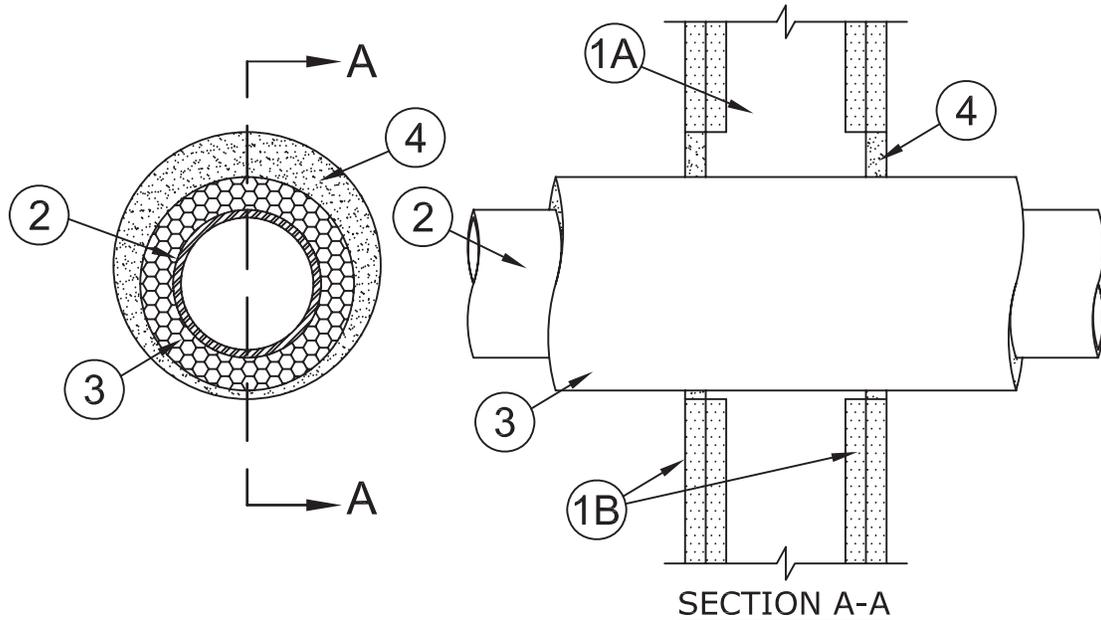

- Wall Assembly** – The 1 or 2 hr fire rated gypsum board/stud wall assembly shall be constructed of the materials and in the manner described in the individual U300, U400 or V400 Series Wall and Partition Design in the UL Fire Resistance Directory and shall include the following construction features:

- Studs** – Wall framing may consist of either wood studs or steel channel studs. Wood studs to consist of nom 2 by 4 in. (51 by 102 mm) lumber spaced 16 in. (406 mm) OC. Steel studs to be min 3-1/2 in. (89 mm) wide spaced max 24 in. (610 mm) OC.
- Gypsum Board*** – The gypsum board type, thickness, number of layers, fastener type and sheet orientation shall be as specified in the individual U300, U400 or V400 Series Design in the UL Fire Resistance Directory. Diam of wall opening to be min 1 in. (25 mm) to max 1-1/2 in. (38 mm) larger than outside diam of insulated pipe or tube.

The hourly F Rating of the firestop system is equal to the hourly fire rating of the wall assembly in which it is installed. The hourly T Rating of the firestop system is 1 hr and 1-1/2 hr for the 1 hr and 2 hr fire rated assemblies, respectively.

- Through Penetrant** – One metallic pipe or tube to be installed eccentrically or concentrically within the firestop system. Pipe or tube to be rigidly supported on both sides of the floor or wall assembly. The following types and sizes of metallic pipes and tubes may be used:
 - Steel Pipe** – Nom 3 in. (76 mm) diam (or smaller) Schedule 5 (or heavier) steel pipe.
 - Iron Pipe** – Nom 3 in. (76 mm) diam (or smaller) cast or ductile iron pipe.
 - Copper Pipe** – Nom 2 in. (51 mm) diam (or smaller) Regular (or heavier) copper pipe.
 - Copper Tube** – Nom 2 in. (51 mm) diam (or smaller) Type L (or heavier) copper tube.
- Pipe Insulation – Foamed Plastic*** – Nom 1 in. (25 mm) thick polyisocyanurate foamed plastic units jacketed with an all service jacket. Longitudinal joints sealed with self-sealing lap tape. Transverse joints secured with butt tape. Annular space shall be min 1/4 in. (6 mm) to max 3/4 in. (19 mm).
See **Foamed Plastic** (BRYX) category in the Building Materials Directory for names of manufacturers. Any foamed plastic pipe covering material meeting the above specifications and bearing the UL Classification Marking with a Flame Spread Index of 25 or less may be used.
- Band Clamp** – Nom 1/2 (13 mm) wide stainless steel band clamp with worm gear tightening mechanism. Band clamp to be secured around pipe insulation 1 in. (25 mm) from both surfaces of wall.
- Fill, Void or Cavity Material* – Sealant** – Min 5/8 in. (16 mm) thickness of fill material applied within annulus, flush with both surfaces of wall, with a nominal 1/2 in. (13 mm) lap onto the wall surfaces.

3M COMPANY**3M FIRE PROTECTION PRODUCTS** – Type CP-25WB+ Caulk, FB-3000WT Sealant

*Bearing the UL Classification Mark

Reprinted from the Online Certifications Directory with permission from Underwriters Laboratories Inc.
Copyright © 2010 Underwriters Laboratories Inc.®



System No. W-L-5291

February 18, 2010

F Ratings – 1 and 2 Hr (See Item 1)

T Ratings – 1 and 2 Hr (See Item 1)

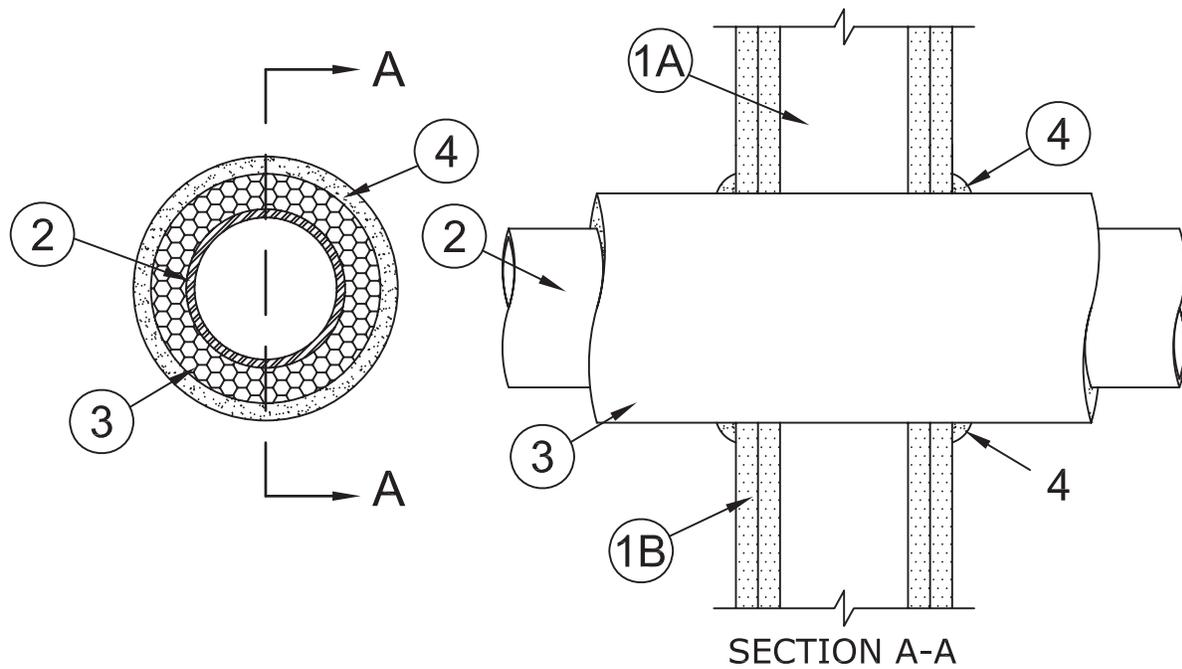

- Wall Assembly** – The 1 or 2 hr fire rated gypsum board/stud wall assembly shall be constructed of the materials and in the manner described in the individual U300, U400 or V400 Series Wall and Partition Design in the UL Fire Resistance Directory and shall include the following construction features:

A. **Studs** – Wall framing may consist of either wood studs or steel channel studs. Wood studs to consist of nom 2 by 4 in. (51 by 102 mm) lumber spaced 16 in. (406 mm) OC. Steel studs to be min 3-5/8 in. (92 mm) wide spaced max 24 in. (610 mm) OC.

B. **Gypsum Board*** – The gypsum board type, thickness, number of layers, fastener type and sheet orientation shall be as specified in the individual U300, U400 or V400 Series Design in the UL Fire Resistance Directory. Diam of wall opening to be equal to the outside diam of insulated pipe or tube.

The hourly F and T Ratings of the firestop system are equal to the hourly fire rating of the wall assembly in which it is installed.

- Through Penetrant** – One metallic pipe or tube to be installed eccentrically or concentrically within the firestop system. Pipe or tube to be rigidly supported on both sides of the wall assembly. The following types and sizes of metallic pipes and tubes may be used:
 - Steel Pipe** – Nom 2 in. (51 mm) diam (or smaller) Schedule 5 (or heavier) steel pipe.
 - Iron Pipe** – Nom 2 in. (51 mm) diam (or smaller) cast or ductile iron pipe.
 - Copper Pipe** – Nom 2 in. (51 mm) diam (or smaller) Regular (or heavier) copper pipe.
 - Copper Tube** – Nom 2 in. (51 mm) diam (or smaller) Type L (or heavier) copper tube.
- Pipe Covering*** – Nom. 1-1/2 in. (38 mm) thick hollow cylindrical heavy density glass fiber units jacketed on the outside with an all service jacket. Longitudinal joints sealed with metal fasteners or factory applied self-sealing lap tape. Transverse joints secured with metal fasteners or with butt tape supplied with the product. The annular spacing between pipe covering and periphery of opening shall be min. 0 in. (continuous point contact).

See **Pipe and Equipment Covering-Materials** (BRGU) category in the Building Materials Directory for names of manufacturers. Any pipe covering material meeting the above specifications and bearing the UL Classification Marking with a Flame Spread Index of 25 or less and a Smoke Developed Index of 50 or less may be used.

- Fill, Void or Cavity Material*** – Min 1/2 in. (13 mm) thickness of fill material applied at the pipe covering/gypsum board interface to lap onto the wall surfaces on both sides of wall.

3M COMPANY

3M FIRE PROTECTION PRODUCTS – Type CP-25WB+ Caulk, FB-3000WT Sealant

*Bearing the UL Classification Mark

Reprinted from the Online Certifications Directory with permission from Underwriters Laboratories Inc.

Copyright © 2010 Underwriters Laboratories Inc.®



Through Penetrations

Insulated Pipes

5000 Series

Gypsum

WL

Insulated Pipes • Wood Frame Floor/Ceiling

| 3M UL Systems | "F" Rating | 3M Product | Through Penetrant Details |
|---------------|------------|--|---|
| F-C-5002 | 1 | 3M™ Fire Barrier Sealant CP 25WB+ 3M™ Fire Barrier Sealant IC 15WB+ 3M™ Fire Barrier Sealant FD 150+ 3M™ Fire Barrier Wrap Strips FS-195+ 3M™ Fire Barrier Water Tight Sealant 3000 WT | 4" steel, 3" copper. Nom 1" glass fiber insulation, nom 1/2" or 5/8" AB/PVC insulation. Max diam of opening 7". Min 1/2" to max 3/4" annular. 1 hour F Rating. Also referred as FC5002. |
| F-C-5058 | 1 | 3M™ Fire Barrier Sealant CP 25WB+ 3M™ Fire Barrier Sealant IC 15WB+ 3M™ Fire Barrier Water Tight Sealant 3000 WT | 4" steel pipe, 4" cast iron pipe, 4" ductile iron pipe, 4" copper tubing, 4" copper pipe. 1-1/2" glass fiber insulation, Nom 3/4" AB/PVC flexible foam insulation. Max diam of opening 8". Point contact to max 7/8" annular. 1 hour F Rating. Also referred as FC5058. |
| F-C-5085 | 1 | 3M™ Fire Barrier Sealant CP 25WB+ 3M™ Fire Barrier Sealant IC 15WB+ 3M™ Fire Barrier Water Tight Sealant 3000 WT | Max 6 in. steel, max 6 in. iron, max 6 in. copper tubing, max 6 in. copper pipe. L500 series floor ceiling assembly. Max diam of opening 8 in. Point contact to max 1-7/8 in. annular space. Concentric or eccentric installation. Nominal 2 in. fiberglass insulation. 1 hour F & T rating. No mineral wool or sleeve required. Also known as FC5085. |
| F-E-5005 | 1 | 3M™ Fire Barrier Sealant CP 25WB+ 3M™ Fire Barrier Sealant IC 15WB+ 3M™ Fire Barrier Water Tight Sealant 3000 WT | 4" steel, 4" cast iron, 4" ductile iron, 4" copper tubing, 4" copper pipe. 1-1/2" glass fiber insulation, 3/4" AB/PVC flexible foam insulation. Max diam of opening 8". Concentric or eccentric installation. Point contact to max 7/8" annular. 1 hour F Rating. Also referred as FE5005. |
| F-E-5012 | 1 | 3M™ Fire Barrier Sealant CP 25WB+ 3M™ Fire Barrier Sealant IC 15WB+ 3M™ Fire Barrier Water Tight Sealant 3000 WT | Max 6 in. steel, max 6 in. iron, max 6 in. copper tubing, max 6 in. copper pipe. G500 series floor ceiling assembly. Max diam of opening 12 in. Point contact to max 1-7/8 in. annular space. Concentric or eccentric installation. Nominal 2 in. fiberglass insulation. 1 hour F & T rating. No mineral wool or sleeve required. Also known as FE5012. |

System No. F-C-5002

May 19, 2005

F Rating – 1 Hr

T Rating – 1 Hr

L Rating At Ambient – 7 CFM/sq ft

L Rating At 400 F – Less Than 1 CFM/sq ft

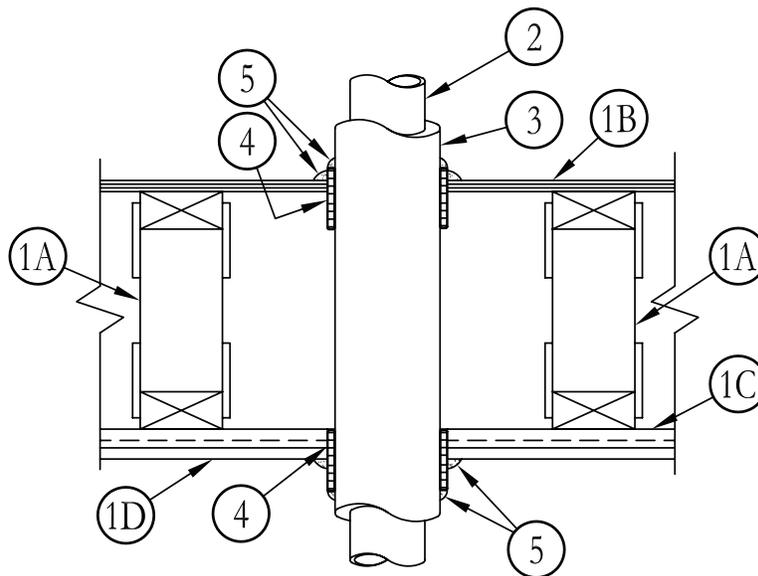

- 1. Floor Assembly** – The fire rated wood truss or combination wood and steel truss Floor-Ceiling assembly shall be constructed of the materials and in the manner described in the individual L500-Series Designs in the UL Fire Resistance Directory and shall include the following construction features:
 - A. Trusses** – Min 12 in. (305 mm) deep parallel chord trusses fabricated from nom 2 in. by 4 in. (51 mm by 102 mm) lumber in conjunction with galv steel truss plates or **Structural Wood Members*** with bridging as required.
 - B. Flooring** – Nom 3/4 in. (19 mm) thick plywood flooring with or without **Floor Topping Mixture***. Max diam of hole-sawed opening in flooring is 7 in. (178 mm).
 - C. Furring Channels** – Rigid or resilient galv steel furring channels installed perpendicular to bottom chord of trusses.
 - D. Gypsum Board*** – Nom 4 ft (122 cm) wide by 5/8 in. (16 mm) thick, screw-attached to furring channels. Max diam of hole-sawed opening in gypsum wallboard ceiling is 7 in. (178 mm).
- 2. Pipe** – Nom 4 in. (102 mm) diam (or smaller) Schedule 10 (or heavier) steel pipe or nom 3 in. (76 mm) diam (or smaller) Type L (or heavier) copper pipe. Pipe to be installed approximately midway between trusses and centered in circular cutouts in flooring (Item 1B) and gypsum wallboard ceiling (Item 1D). Diam of circular cutouts in flooring and gypsum wallboard ceiling to be 1/2 in. to 3/4 in. (13 mm by 19 mm) larger than outside diam of pipe covering (Item 3) or tube insulation (Item 3A) on pipe. Pipe to be rigidly supported on both sides of Floor-Ceiling assembly.
- 3. Pipe Covering*** – Nom 1 in. (25 mm) thick hollow cylindrical heavy density (min 3.5 pcf or 56 kg/m³) glass fiber units jacketed on the outside with an all service jacket. Longitudinal joints sealed with metal fasteners or factory-applied self-sealing lap tape. Transverse joints secured with metal fasteners or with butt strip tape supplied with the product.

See **Pipe and Equipment Covering – Materials*** (BRGU) category in Building Materials Directory for names of manufacturers. Any pipe covering material meeting the above specifications and bearing the UL Classification Marking with a Flame Spread Index of 25 or less and a Smoke Developed Index of 50 or less may be used.
- 3A. Tube Insulation – Plastics+** – As an alternate to the glass fiber pipe covering (Item 3), nom 1/2 in. or 5/8 in. (13 mm by 16 mm) thick acrylonitrile butadiene/polyvinyl chloride (AB/PVC) flexible foam furnished in the form of tubing with skin may be used.

See **Plastics** (QMFZ2) category in the Recognized Component Directory for names of manufacturers. Any Recognized Component tube insulation material meeting the above specifications and having a UL 94 Flammability Classification of 94-5VA may be used.
- 4. Fill, Void or Cavity Materials* – Wrap Strip** – Nom 1/4 in. thick intumescent elastomeric material faced on one side with aluminum foil, supplied in 2 in. wide strips. Nom 2 in. wide strip tightly wrapped around pipe covering or tube insulation (foil side exposed), secured with two steel tie wires and slid into hole-sawed opening in flooring (Item 1B) and in gypsum wallboard ceiling (Item 1D). Bottom edge of wrap strip to project 9/16 in. to 11/16 in. (14 mm to 17.5 mm) below bottom surface of flooring and below bottom (ceiling) surface of gypsum wallboard.

3M COMPANY – FS-195, FS-195+

3M COMPANY – CP 25WB+, IC 15WB+, FireDam 150+ caulk or FB-3000 WT sealant

*Bearing the UL Classification Marking

Reprinted from the Online Certifications Directory with permission from Underwriters Laboratories Inc.

Copyright © 2010 Underwriters Laboratories Inc.®



System No. F-C-5058

May 19, 2005

F Rating – 1 Hr

T Ratings – 0, 3/4 and 1 Hr (See Item 3)

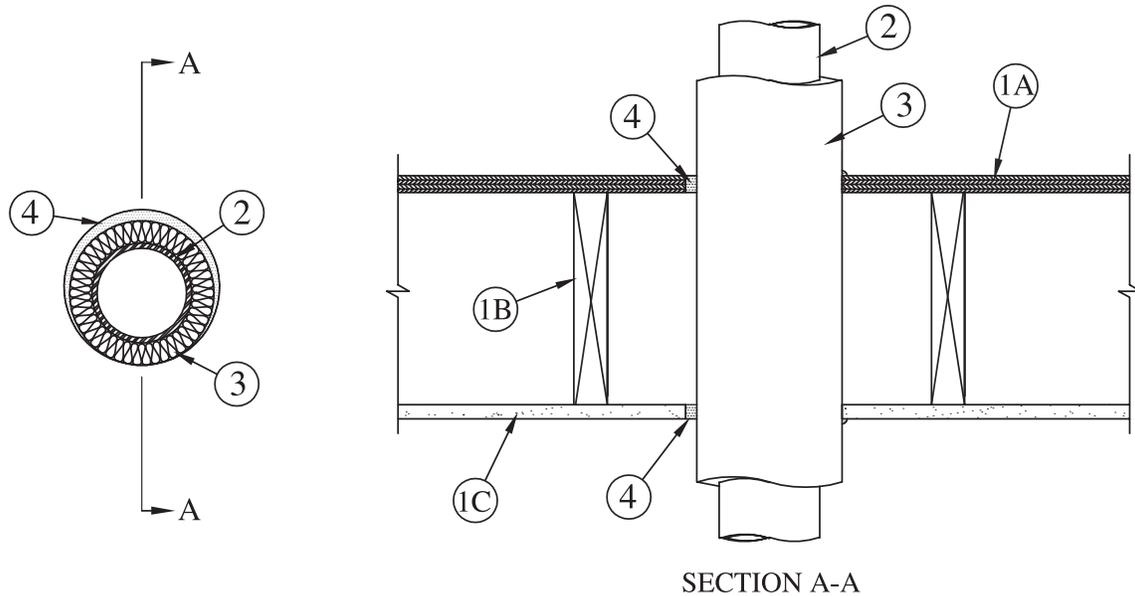

1. **Floor-Ceiling Assembly** – The 1 hr fire-rated solid or trussed lumber joist floor-ceiling assembly shall be constructed of the materials and in the manner specified in the individual L500 Series Floor-Ceiling Designs in the UL Fire Resistance Directory. The general construction details of the floor-ceiling assembly are summarized below:
 - A. **Flooring System** – Lumber or plywood subfloor with finish floor of lumber, plywood or Floor Topping Mixture* as specified in the individual Floor-Ceiling Design. Max diam of opening is 8 in. (203 mm).
 - B. **Wood Joists** – Nom 10 in. (254 mm) deep (or deeper) lumber, steel or combination lumber and steel joists, trusses or Structural Wood Members* with bridging as required and with ends firestopped.
 - C. **Gypsum Board*** – Nom 4 ft (122 cm) wide by 5/8 in. (16 mm) thick as specified in the individual Floor-Ceiling Design. Max diam of opening is 8 in. (203 mm).
2. **Through Penetrants** – One metallic pipe, conduit, tubing or flexible metal pipe installed concentrically or eccentrically within opening. Penetrant to be rigidly supported on both sides of floor-ceiling. The following types and sizes of penetrants may be used:
 - A. **Steel Pipe** – Nom 4 in. (102 mm) diam (or smaller) Schedule 5 (or heavier) steel pipe.
 - B. **Iron Pipe** – Nom 4 in. (102 mm) diam (or smaller) cast or ductile iron pipe.
 - C. **Copper Tubing** – Nom 4 in. (102 mm) diam (or smaller) Type L (or heavier) copper tubing.
 - D. **Copper Pipe** – Nom 4 in. (102 mm) diam (or smaller) Regular (or heavier) copper pipe.
3. **Pipe Coverings** – Pipe covering installed such that the annular space between pipe covering and periphery of opening shall be min 0 in. (point contact) to max 7/8 in. (0 mm to 22 mm). The following types of pipe coverings shall be used:
 - A. **Pipe Coverings*** – Nom 1-1/2 in. (38 mm) thick (or less) hollow cylindrical heavy density glass fiber units jacketed on the outside with an all service jacket. Longitudinal joints sealed with metal fasteners or factory-applied SSL tape. Transverse joints secured with metal fasteners or with butt tape supplied with the product.
 See **Pipe and Equipment Covering- Materials (BRGU)** category in the Building Materials Directory for names of manufacturers. Any pipe covering material meeting the above specifications and bearing the UL Classification Marking with a Flame Spread Index of 25 or less and a Smoke Developed Index of 50 or less may be used.
 - B. **Tube Insulation-Plastics+** – Nom 3/4 in. (19 mm) thick (or less) acrylonitrile butadiene/polyvinyl chloride (AB/PVC) flexible foam furnished in the form of tubing.
 See **Plastics (QMFZ2)** category in the Recognized Component Directory for names of manufacturers. Any Recognized Component tube insulation material meeting the above specifications and having a UL 94 Flammability Classification of 94-5A may be used.

T Rating is 1 Hr for nom 1-1/2 and 1 in. (25 mm) thick glass fiber units. T Rating is 0 Hr for glass fiber units less than nom 1 in. (25 mm) thick. T Rating is 3/4 Hr for nom 3/4 in. (19 mm) thick tube insulation. T Rating is 0 Hr for tube insulations less than nom 3/4 in. (19 mm) thick.
4. **Fill, Void or Cavity Materials* – Caulk or Sealant** – Min 3/4 in. (19 mm) thickness of caulk applied within annulus, flush with top surface of floor. Min 5/8 in. (16 mm) thickness of caulk applied within annulus, flush with bottom surface of ceiling. Min 1/4 in. (6 mm) diam bead of caulk applied at point contact locations at pipe covering/floor interface on top surface of floor and at pipe covering/ceiling interface.

3M COMPANY – IC 15WB+, CP 25WB+ caulk or FB-3000 WT sealant

*Bearing the UL Classification Marking

+Bearing the UL Recognized Component Marking

Reprinted from the Online Certifications Directory with permission from Underwriters Laboratories Inc.

Copyright © 2010 Underwriters Laboratories Inc.®



System No. F-C-5085

February 19, 2010

F Rating – 1 Hr

T Rating – 1 Hr

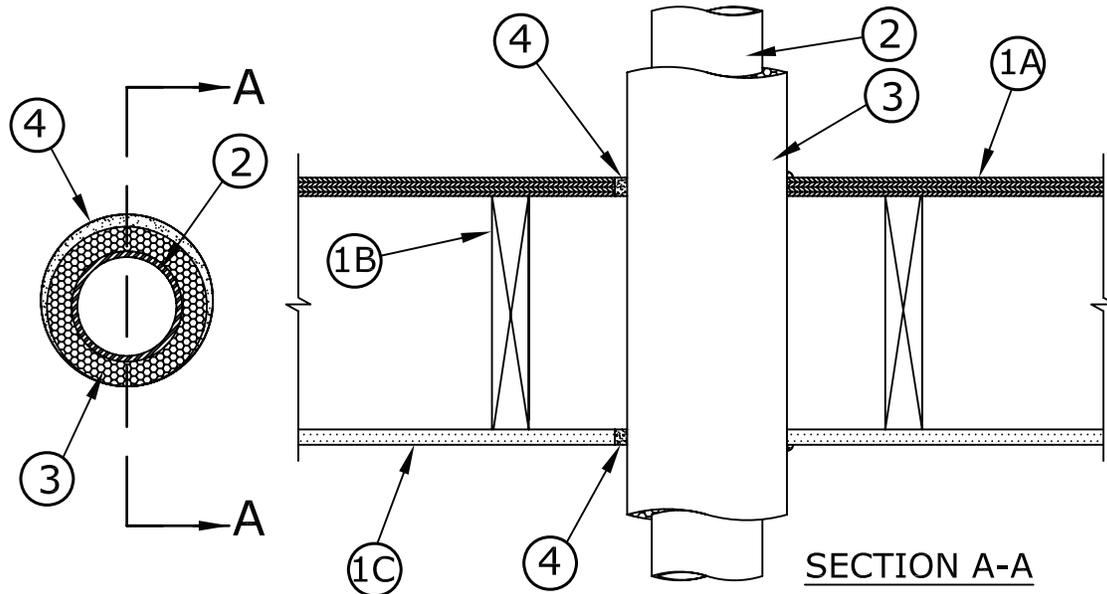

1. **Floor-Ceiling Assembly** – The 1 hr fire-rated solid or trussed lumber joist floor-ceiling assembly shall be constructed of the materials and in the manner specified in the individual L500 Series Floor-Ceiling Designs in the UL Fire Resistance Directory. The general construction details of the floor-ceiling assembly are summarized below:
 - A. **Flooring System** – Lumber or plywood subfloor with finish floor of lumber, plywood or **Floor Topping Mixture*** as specified in the individual Floor-Ceiling Design. Max diam of opening is 8 in. (203 mm).
 - B. **Wood Joists** – Nom 10 in. (254 mm) deep (or deeper) lumber, steel or combination lumber and steel joists, trusses or **Structural Wood Members*** with bridging as required and with ends firestopped.
 - C. **Gypsum Board*** – Nom 4 ft (122 cm) wide by 5/8 in. (16 mm) thick as specified in the individual Floor-Ceiling Design. Max diam of opening is 8 in. (203 mm).
2. **Through Penetrants** – One metallic pipe or tubing installed concentrically or eccentrically within opening. Penetrant to be rigidly supported on both sides of floor-ceiling. The following types and sizes of penetrants may be used:
 - A. **Steel Pipe** – Nom 6 in. (151 mm) diam (or smaller) Schedule 5 (or heavier) steel pipe.
 - B. **Iron Pipe** – Nom 6 in. (151 mm) diam (or smaller) cast or ductile iron pipe.
 - C. **Copper Tubing** – Nom 6 in. (151 mm) diam (or smaller) Type L (or heavier) copper tubing.
 - D. **Copper Pipe** – Nom 6 in. (151 mm) diam (or smaller) Regular (or heavier) copper pipe.
3. **Pipe Coverings*** – Nom 2 in. (51 mm) thick (hollow cylindrical heavy density (min 3.5 pcf or 56 kg/m³) glass fiber units jacketed on the outside with an all service jacket. Longitudinal joints sealed with metal fasteners or factory-applied SSL tape. Transverse joints secured with metal fasteners or with butt tape supplied with the product. Pipe covering installed such that the annular space between pipe covering and periphery of opening shall be min 0 in. (point contact) to max 1-7/8 in. (48 mm).
See **Pipe and Equipment Covering-Materials** (BRGU) category in the Building Materials Directory for names of manufacturers. Any pipe covering material meeting the above specifications and bearing the UL Classification Marking with a Flame Spread Index of 25 or less and a Smoke Developed Index of 50 or less may be used.
4. **Fill, Void or Cavity Materials* – Caulk or Sealant** – Min 3/4 in. (19 mm) thickness of fill material applied within annulus, flush with top surface of floor. Min 5/8 in. (16 mm) thickness of fill material applied within annulus, flush with bottom surface of ceiling. Min 1/2 in. (13 mm) diam bead of fill material applied at point contact locations at pipe covering/floor interface on top surface of floor and at pipe covering/ceiling interface.

3M COMPANY

3M FIRE PROTECTION PRODUCTS – IC 15WB+, CP 25WB+ or FB-3000 WT

*Bearing the UL Classification Mark

Reprinted from the Online Certifications Directory with permission from Underwriters Laboratories Inc.

Copyright © 2010 Underwriters Laboratories Inc.®



Through Penetrations

Insulated Pipes

5000 Series

Floor/Ceiling

FC

System No. F-E-5005

May 20, 2005

F Rating – 1 Hr

T Ratings – 0, 3/4 and 1 Hr (See Item 3)

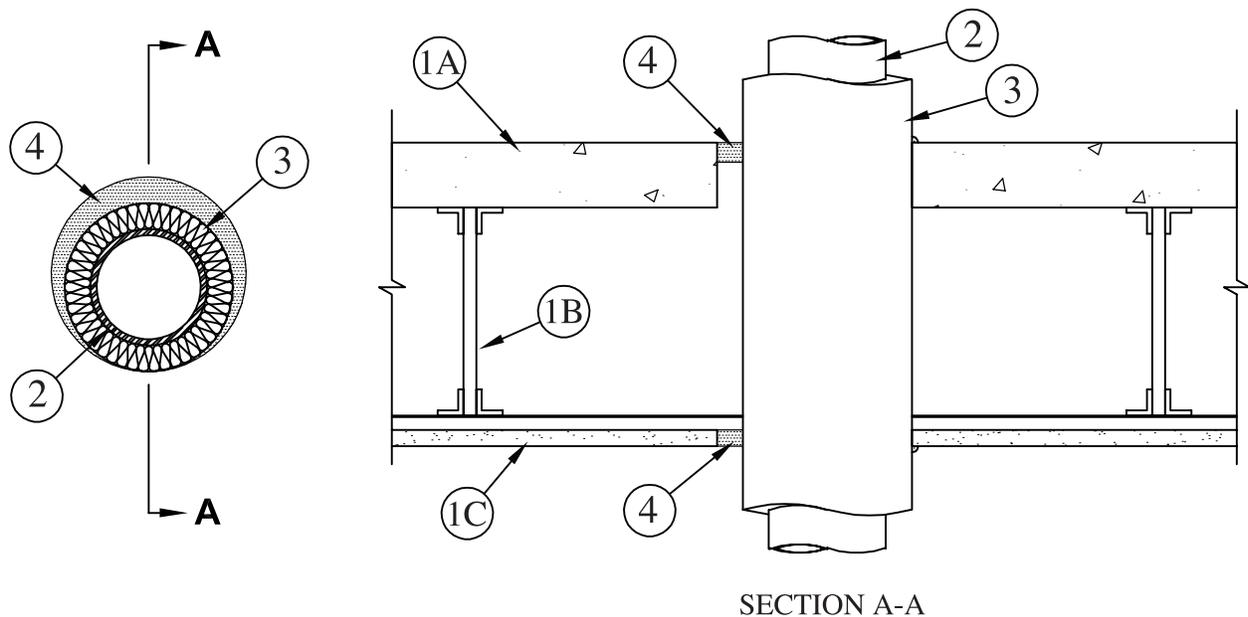

1. **Floor-Ceiling Assembly** – The 1 hr fire rated concrete and steel joist Floor-Ceiling assembly shall be constructed of the materials and in the manner described in the individual G500 Series Design in the UL Fire Resistance Directory, as summarized below:
 - A. **Flooring** – Normal or Lightweight concrete as specified in the individual G500 Series Design. Max diam of opening is 8 in. (203 mm).
 - B. **Joists** – Steel joists or Structural Steel Members* as specified in the individual G500 Series Design.
 - C. **Gypsum Board*** – Min 5/8 in. (16 mm) thick, screw-attached to furring channels as specified in the individual G500 Series Design. Max diam of opening is 8 in. (203 mm).
2. **Through Penetrants** – One metallic pipe, conduit, tubing or flexible metal pipe installed concentrically or eccentrically within opening. Penetrant to be rigidly supported on both sides of floor-ceiling. The following types and sizes of penetrants may be used:
 - A. **Steel Pipe** – Nom 4 in. (102 mm) diam (or smaller) Schedule 5 (or heavier) steel pipe.
 - B. **Iron Pipe** – Nom 4 in. (102 mm) diam (or smaller) cast or ductile iron pipe.
 - C. **Copper Tubing** – Nom 4 in. (102 mm) diam (or smaller) Type L (or heavier) copper tubing.
 - D. **Copper Pipe** – Nom 4 in. (102 mm) diam (or smaller) Regular (or heavier) copper pipe.
3. **Pipe Coverings** – Pipe covering installed such that the annular space between pipe covering and periphery of opening shall be min 0 in. (point contact) to max 7/8 in. (22 mm). The following types of pipe coverings shall be used:
 - A. **Pipe Coverings*** – Nom 1-1/2 in. (38 mm) thick (hollow cylindrical heavy density glass fiber units jacketed on the outside with an all service jacket. Longitudinal joints sealed with metal fasteners or factory-applied SSL tape. Transverse joints secured with metal fasteners or with butt tape supplied with the product.
See **Pipe and Equipment Covering-Materials (BRGU)** category in the Building Materials Directory for names of manufacturers. Any pipe covering material meeting the above specifications and bearing the UL Classification Marking with a Flame Spread Index of 25 or less and a Smoke Developed Index of 50 or less may be used.
 - B. **Tube Insulation-Plastics+** – Nom 3/4 in. (19 mm) thick (or less) acrylonitrile butadiene/polyvinyl chloride (AB/PVC) flexible foam furnished in the form of tubing.
See **Plastics (QMFZ2)** category in the Plastics Recognized Component Directory for names of manufacturers. Any Recognized Component tube insulation material meeting the above specifications and having a UL 94 Flammability Classification of 94-5A may be used.

T Rating is 1 Hr for nom 1-1/2 in. and 1 in. (38 mm and 25 mm) thick glass fiber units. T Rating is 0 Hr for glass fiber units less than nom 1 in. (25 mm) thick. T Rating is 3/4 Hr for nom 3/4 in. (19 mm) thick tube insulation. T Rating is 0 Hr for tube insulations less than nom 3/4 in. (19 mm) thick.
4. **Fill, Void or Cavity Materials*** – **Caulk or Sealant** – Min 3/4 in. (19 mm) thickness of caulk applied within annulus, flush with top surface of floor. Min 5/8 in. (16 mm) thickness of caulk applied within annulus, flush with bottom surface of ceiling. Min 1/4 in. (6 mm) diam bead of caulk applied at point contact locations at pipe covering/floor interface on top surface of floor and at pipe covering/ceiling interface.

3M COMPANY – IC 15WB+, CP 25WB+ caulk or FB-3000 WT sealant

*Bearing the UL Classification Marking

+Bearing the UL Recognized Component Marking

Reprinted from the Online Certifications Directory with permission from Underwriters Laboratories Inc.

Copyright © 2010 Underwriters Laboratories Inc.®



System No. F-E-5012

February 19, 2010

F Rating – 1 Hr

T Rating – 1 Hr

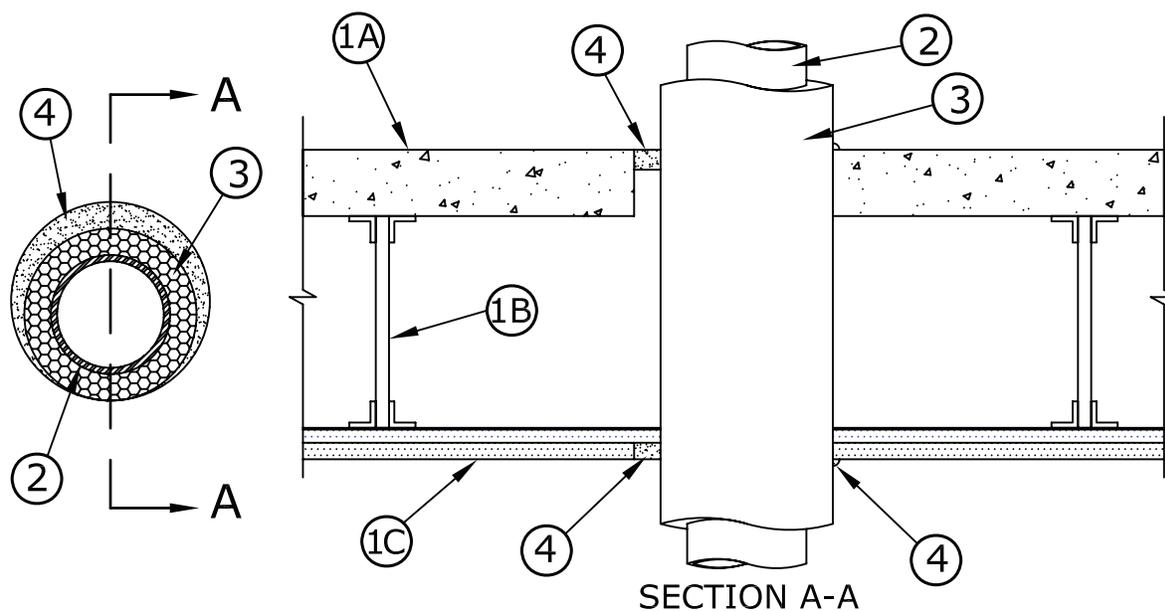

1. **Floor-Ceiling Assembly** – The 1 hr fire rated concrete and steel joist Floor-Ceiling assembly shall be constructed of the materials and in the manner described in the individual G500 Series Design in the UL Fire Resistance Directory, as summarized below:
 - A. **Flooring** – Lightweight or normal weight (100-150 pcf or 1600-2400 kg/m³) concrete as specified in the individual G500 Series Design. Max diam of opening is 12 in. (305 mm).
 - B. **Joists** – Steel joists or Structural Steel Members* as specified in the individual G500 Series Design.
 - C. **Gypsum Board*** – Min 5/8 in. (16 mm) thick, screw-attached to furring channels as specified in the individual G500 Series Design. Max diam of opening is 12 in. (305 mm).
2. **Through Penetrants** – One metallic pipe or tubing installed concentrically or eccentrically within opening. Penetrant to be rigidly supported on both sides of floor-ceiling. The following types and sizes of penetrants may be used:
 - A. **Steel Pipe** – Nom 6 in. (151 mm) diam (or smaller) Schedule 5 (or heavier) steel pipe.
 - B. **Iron Pipe** – Nom 6 in. (151 mm) diam (or smaller) cast or ductile iron pipe.
 - C. **Copper Tubing** – Nom 6 in. (151 mm) diam (or smaller) Type L (or heavier) copper tubing.
 - D. **Copper Pipe** – Nom 6 in. (151 mm) diam (or smaller) Regular (or heavier) copper pipe.
3. **Pipe Coverings*** – Nom 2 in. (51 mm) thick (hollow cylindrical heavy density (min 3.5 pcf or 56 kg/m³) glass fiber units jacketed on the outside with an all service jacket. Longitudinal joints sealed with metal fasteners or factory-applied SSL tape. Transverse joints secured with metal fasteners or with butt tape supplied with the product. Pipe covering installed such that the annular space between pipe covering and periphery of opening shall be min 0 in. (point contact) to max 1-7/8 in. (48 mm).
See **Pipe and Equipment Covering-Materials** (BRGU) category in the Building Materials Directory for names of manufacturers. Any pipe covering material meeting the above specifications and bearing the UL Classification Marking with a Flame Spread Index of 25 or less and a Smoke Developed Index of 50 or less may be used.
4. **Fill, Void or Cavity Materials* – Caulk or Sealant** – Min 3/4 in. (19 mm) thickness of fill material applied within annulus, flush with top surface of floor. Min 5/8 in. (16 mm) thickness of fill material applied within annulus, flush with bottom surface of ceiling. Min 1/2 in. (13 mm) diam bead of fill material applied at point contact locations at pipe covering/floor interface on top surface of floor and at pipe covering/ceiling interface.

3M COMPANY

3M FIRE PROTECTION PRODUCTS – IC 15WB+, CP 25WB+ caulk or FB-3000 WT sealant

*Bearing the UL Classification Mark

Reprinted from the Online Certifications Directory with permission from Underwriters Laboratories Inc.

Copyright © 2010 Underwriters Laboratories Inc.®



Through Penetrations

Insulated Pipes

5000 Series

Floor/Ceiling

FE

Miscellaneous Electrical

CAJ

Concrete floors with a minimum thickness less than or equal to 5 inches (127 mm)

Concrete or masonry walls with a minimum thickness less than or equal to 8 inches (203 mm)

FA

Concrete floors/Steel decks

Concrete or masonry walls with a minimum thickness less than or equal to 8 inches (203 mm)

WL

Wall assemblies

Framed walls

Misc. Electrical • Concrete

| 3M UL Systems | "F" Rating | 3M Product | Through Penetrant Details |
|---------------|------------|---|---|
| C-AJ-6001 | 2, 3 | 3M™ Fire Barrier Sealant CP 25WB+ 3M™ Fire Barrier Sealant IC 15WB+ 3M™ Fire Barrier Composite Sheet CS-195+ 3M™ Fire Barrier Wrap Strips FS-195+ 3M™ Fire Barrier Moldable Putty Stix MP+ 3M™ Expantrol™ Flexible Intumescent Strip E-FIS 3M™ Fire Barrier Water Tight Sealant 3000 WT 3M™ Fire Barrier Wrap Ultra GS | Steel and aluminum busway, sized max. 23 in. x 4.5 in. for 2 hour and max. 9 in. x 4.5 in. for 3 hour, penetrating a minimum 2.5 in. thick concrete floor or wall. Utilizing CS 195+ Composite Sheet and FS 195+ Wrap Strip. |
| C-AJ-6002 | 2, 3 | 3M™ Fire Barrier Silicone Sealant 2000+ 3M™ Fire Barrier Water Tight Sealant 1000 NS 3M™ Fire Barrier Water Tight Sealant 1003 SL 3M™ Fire Barrier Water Tight Sealant 3000 WT 3M™ Fire Barrier Water Tight Sealant 3000 WT | Max. 23 in. x 4.5 in. aluminum busway penetrating a minimum 4.5 in. thick concrete floor or wall. Utilizing packing material and silicone sealant. |
| C-AJ-6041 | 2, 3 | 3M™ Fire Barrier Moldable Putty Stix MP+ 3M™ Fire Barrier Pillows 3M™ Fire Barrier Self-Locking Pillows | Max. 23 in. x 4.5 in. aluminum busway penetrating a minimum 4.5 in. thick concrete floor or wall. Utilizing Fire Barrier Pillows and Putty. |
| F-A-6001 | 1, 2, 3 | 3M™ Fire Barrier Sealant CP 25WB+ 3M™ Fire Barrier Water Tight Sealant 3000 WT | 9" x 4" "I" steel & aluminum with copper bars rated for max 600V, 1600A. Max area of opening 144 sq. in. 12" max dimension. Support hanger required. Min 28 gauge steel cover plate require. Packing material required. 3 hour F Rating. Also referred as FA6001. |

System No. C-AJ-6001

May 19, 2005

F Ratings – 2 and 3 Hr (See Items 1 and 2)

T Rating – 0 Hr

L Rating At Ambient – 2 CFM/sq ft

L Rating At 400 F – less than 1 CFM/sq ft

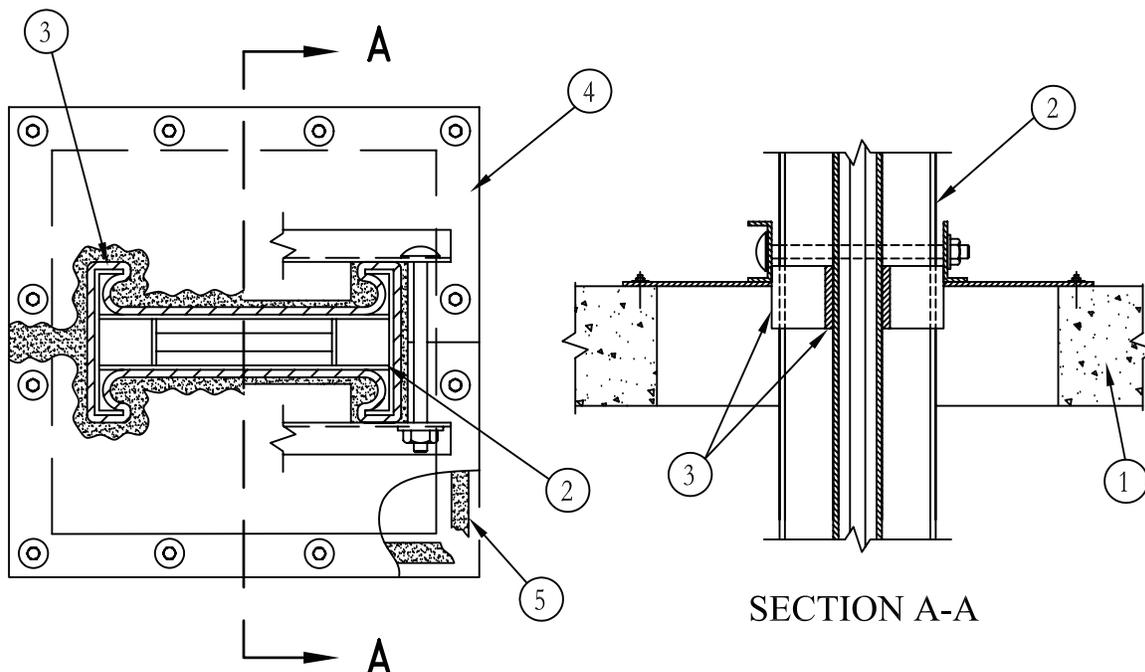

1. **Floor or Wall Assembly** – Lightweight or normal weight (100-150 pcf or 1600-2400 kg/m³) concrete. Min thickness of concrete floor or wall assembly is 2-1/2 in. (64 mm) for 2 hr F Rating and 4-1/2 in. (114 mm) for 3 hr F Rating. Wall may also be constructed of any UL Classified **Concrete Blocks***. The size of the rectangular through opening shall be such that the annular space between the outside corners of the busway (Item 2) and the periphery of the through opening is in the range of 1/2 in. to 3 in. (13 mm to 76 mm).

See **Concrete Blocks (CAZT)** category in Fire Resistance Directory for names of manufacturers.

2. **Busway** – For 3 hr F Rating, the busway shall consist of a nom 9 in. (229 mm) wide (or smaller) by 4-1/2 in. (114 mm) deep (or smaller) “I” -shaped steel and aluminum enclosure containing factory mounted copper bars rated for max 600V, 1600A. For 2 hr F Rating, the busway shall consist of a nom 23 in. (584 mm) wide (or smaller) by 4-1/2 in. (114 mm) deep (or smaller) “I” -shaped aluminum or steel and aluminum enclosure containing factory mounted copper bars rated for max 600V, 4000A or aluminum bars rated for max 600V, 3000A. The busway shall bear the UL Listing Mark and shall be installed in accordance with all provisions of Article 364 of the National Electrical Code, NFPA No. 70. Busway to be installed with min 1/2 in. to max 3 in. (13 mm to max 76 mm) clearance from its outside corners to the sides of the rectangular floor or wall opening and shall be rigidly supported on both sides of floor or wall assembly.

See **Busways and Associated Fittings (CWFT)** category in the Electrical Construction Materials Directory for names of manufacturers.

3. **Fill, Void or Cavity Materials* – Wrap Strip** – Nom 1/4 in. (6 mm) thick intumescent elastomeric material faced on one side with aluminum foil, supplied in strips. Min 2 in. (51 mm) wide strip formed to follow the contours around the entire periphery of the busway (foil side exposed) and secured in place with steel wire. Busway wrap to extend 1 in. (25 mm) above and 1 in. (25 mm) below the top plane of the floor assembly. For wall assemblies, the busway wrap is to be installed in the same manner used for floor assemblies, but it shall be installed symmetrically on both sides of the wall assembly. When steel cover flange (Item 7) provided by the busway manufacturer is used, the busway wrap is not used.

3M COMPANY – FS-195+

4. **Fill, Void or Cavity Materials* – Intumescent Sheet** – Rigid aluminum foil-faced sheets with galv steel sheet backer. Sheet cut to tightly follow the contours of the busway and with a min lap of 2 in. (51 mm) on all sides of the through opening. Sheets to be installed with the galv steel sheet backer exposed (aluminum foil facing against floor or wall surface). Sheet secured to top surface of floor and to both surfaces of wall using min 1/4 in. (6 mm) diam by 1-1/2 in. (38 mm) long steel expansion bolts, or equivalent, in conjunction with min 1-1/4 in. (32 mm) diam steel fender. Max spacing of sheet fasteners not to exceed 5 in. (127 mm) OC When steel cover flange (Item 7) supplied by the busway manufacturer is used, the sheet (s) shall be secured using the same fasteners used to secure the steel cover flange sections. Prior to installation of the sheet(s), a nom 1/4 in. (6 mm) diam bead of caulk (Item 5) shall be applied to the top surface of the floor and to both surfaces of the wall around the perimeter of the through opening.

3M COMPANY – CS-195+

5. **Fill, Void or Cavity Materials* – Graphite Seal, Caulk, Sealant or Putty** – One layer of 1/2 in. x 1/16 in. (13 mm by 1.6 mm) adhesive backed graphite intumescent seal positioned under intumescent sheet around entire perimeter of through opening or in 1/4 in. (6 mm) diam continuous bead of caulk or putty applied to edge of intumescent sheet at its interface with surface of floor or wall around entire perimeter of through opening. Generous application of caulk to be applied around the base of the busway or the busway wrap at its egress from the intumescent sheet (s) in addition to completely covering the busway wrap up to the interface (s) with the busway. All seams in the intumescent sheet (s) made to accommodate the busway to be covered with a generous bead of caulk.

3M COMPANY – E-FIS or Ultra GS seals, CP 25WB+, IC 15WB+ caulk, FB-3000 WT sealant or MP+ Stix putty.

Through Penetrations

Misc. Electrical

6000 Series

Concrete

CAJ

System No. C-AJ-6001 *continued*

6. **Steel Cover Strip** (Not Shown) – Min 2 in. (51 mm) wide strip of min 0.020 in. (0.51 mm) thick (No. 26 gauge) galv steel centered over entire length of each slit made in intumescent sheet (Item 4) to permit installation about the busway. Prior to installation of the steel strip, the seam or slit in the intumescent sheet shall be covered with a nom 1/4 in. (6 mm) diam bead of caulk (Item 5). Steel cover strip secured to galv steel sheet backer of intumescent sheet with steel sheet metal screws or steel rivets spaced max 3 in. (76 mm) O.C. on each side of seam or slit.
7. **Steel Cover Flange** (Optional, Not Shown) – Four piece interlocking cover flange formed from nom 1/8 in. (3.2 mm) thick steel, supplied by busway manufacturer. Steel cover flange to lap min 2 in. (51 mm) on floor or wall surface on all sides of the through opening and secured to top surface of floor and to both surfaces of wall using min 1/4 in. (6 mm) diam by 2 in. (51 mm) long steel expansion bolts, or equivalent. Sheet fasteners installed in factory drilled and field-drilled holes in cover flange sections, through intumescent sheet; and spaced max 5 in. (127 mm) O.C. When steel cover flange is used, a generous application of caulk (Item 5) shall be applied around the base of the busway at its egress from the cover flange (s) and around the perimeter of the cover flange to cover the edges of the cover flange and the intumescent sheet.

*Bearing the UL Classification Marking

Reprinted from the Online Certifications Directory with permission from Underwriters Laboratories Inc.
Copyright © 2010 Underwriters Laboratories Inc.®



Through Penetrations

Misc. Electrical

6000 Series

Concrete

CAJ

System No. C-AJ-6002

September 03, 2004
(Formerly System No. 486)

F Rating – 3 Hr

T Rating – 0 Hr

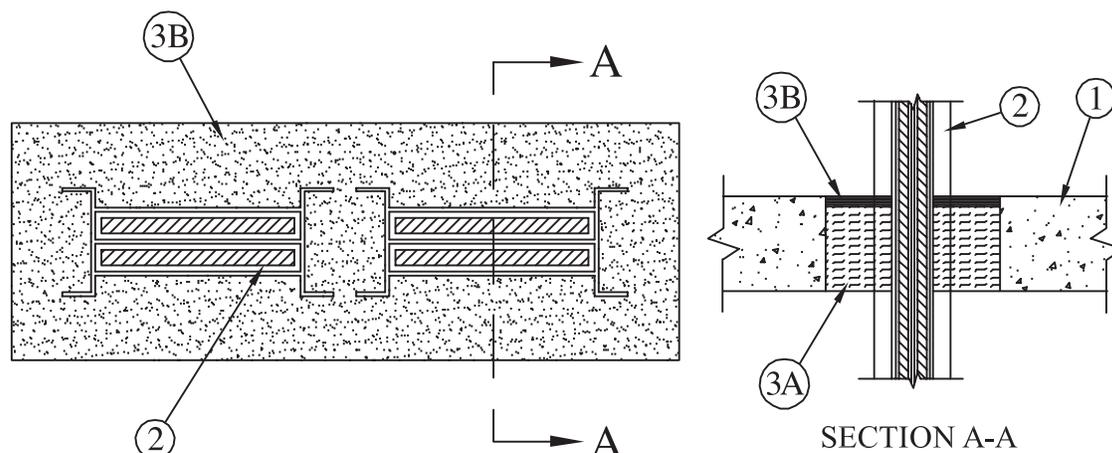

- 1. Floor or Wall Assembly** – Min 4-1/2 in. (114 mm) thick reinforced lightweight or normal weight concrete (100-150 pcf or 1600-2400 kg/m³). Wall may also be constructed of any UL Classified **Concrete Blocks***. Max area of opening is 300 sq in. (1935 c/m²) with max dimension of 30 in. (762 mm).
See **Concrete Blocks (CAZT)** category in the Fire Resistance Directory for names of manufacturers.
- 2. Busway+** – Nom 23 in. (584 mm) wide (or smaller) by 4.5 in. (114 mm) deep “I” shaped aluminum enclosure containing factory mounted copper bars rated for 600 V, 5000 A or aluminum bars rated for 600 V, 4000 A. The busway shall bear the UL Listing Mark and shall be installed in accordance with all provisions of Article 364 of the National Electrical Code, NFPA No. 70. The annular space between the busway and the periphery of the opening shall be min 3/4 in. to max 1-3/4 in. (76 mm to max 44 mm).
- 3. Firestop System** – The firestop system shall consist of the following components:
 - A. Packing Material** – Min 4 in. (102 mm) thickness of min 4 pcf (64 kg/m³) mineral wool batt insulation firmly packed into opening as a permanent form. Packing material to be recessed from top surface of floor or from both surfaces of wall as required to accommodate the required thickness of fill material.
 - B. Fill, Void or Cavity Material* – Sealant** – Min 1/2 in. (13 mm) thickness of fill material applied within annulus, flush with top surface of floor or with both surfaces of wall.
3M COMPANY – FB-1000 NS, FB-1003 SL, FB-2000, FB-2000+ or FB-3000 WT sealant.

+Bearing the UL Listing Mark

*Bearing the UL Classification Marking

Reprinted from the Online Certifications Directory with permission from Underwriters Laboratories Inc.
Copyright © 2010 Underwriters Laboratories Inc.®



System No. C-AJ-6041

September 20, 2011

ANSI/UL1479 (ASTM E814)

F Rating – 3 Hr

T Rating – 0 Hr

CAN/ULC S115

F Rating – 3 Hr

FT Rating – 0 Hr

FH Rating – 3 Hr

FTH Rating – 0 Hr

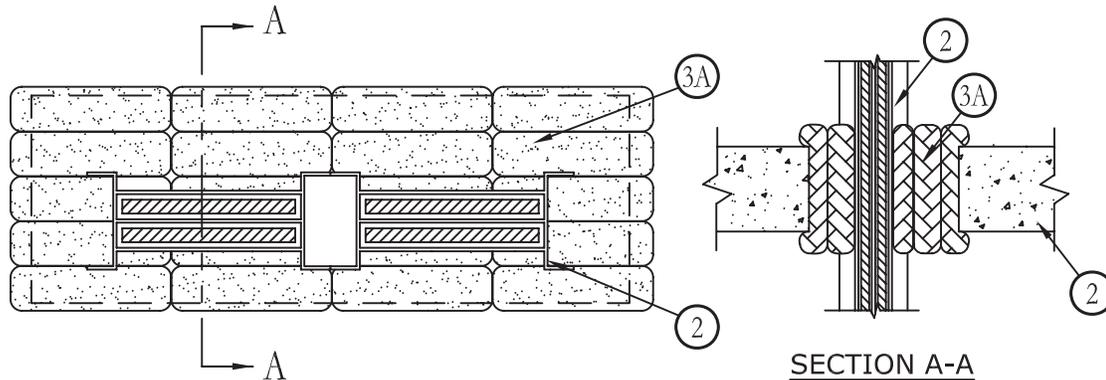

1. **Floor or Wall Assembly** – Min 4-1/2 in. (114 mm) thick reinforced lightweight or normal weight concrete (100-150 pcf or 1600 - 2400 kg/m³). Wall may also be constructed of any UL Classified **Concrete Blocks***. Max area of opening is 305 sq in. (0.2 m²) with max dimension of 29 in. (737 mm).

See **Concrete Blocks (CAZT)** category in the Fire Resistance Directory for names of manufacturers.

2. **Busway+** – Nom 23 in. (584 mm) wide (or smaller) by 4.5 in. (114 mm) deep “I” shaped aluminum enclosure containing factory mounted copper bars rated for 600 V, 5000 A or aluminum bars rated for 600 V, 4000 A. The busway shall bear the UL Listing Mark and shall be installed in accordance with all provisions of the National Electrical Code, NFPA No. 70. The annular space between the busway and the periphery of the opening shall be min 1 in. (25 mm) to max 3 in. (76 mm).
3. **Firestop System** – The firestop system shall consist of the following:
 - A. **Fill, Void or Cavity Material* – Pillows** – Nom 9 in. (229 mm) long by 4 or 6 in. (102 or 152 mm) wide by 2 or 3 in. (51 or 76 mm) thick plastic covered pillows. Pillows to be installed lengthwise through the opening and positioned to extend equally in both directions from the approximate center line of the floor or wall. Pillows tightly-packed into opening to fill the annular space between the busway and the periphery of the opening.

3M COMPANY

3M FIRE PROTECTION PRODUCTS – Fire Barrier Pillows or Fire Barrier Self-Locking Pillows

- B. **Fill, Void or Cavity Material* – Putty** – (Not Shown) – After installation of pillows (Item 3A), putty applied to seal any voids between or around the pillows on the top surface of the floor or on both sides of the wall assembly.

3M COMPANY

3M FIRE PROTECTION PRODUCTS – MP+

+Bearing the UL Listing Mark

*Bearing the UL Classification Mark

Reprinted from the Online Certifications Directory with permission from Underwriters Laboratories Inc.

Copyright © 2011 Underwriters Laboratories Inc.®



System No. F-A-6001

September 07, 2004
(Formerly System No. 97)
F Rating – 3 Hr
T Rating – 1/2 Hr

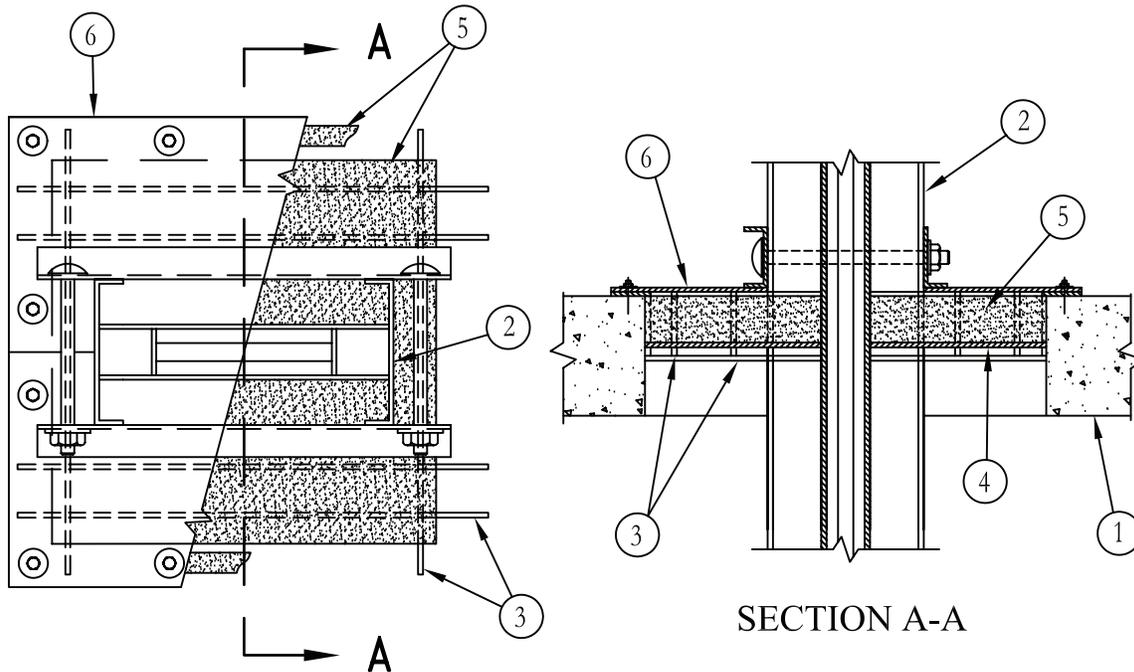

1. **Floor Assembly** – Min 4-1/2 in. thick lightweight or normal weight (100-150 lb per cu ft) concrete floor. Max area of through opening 144 sq in. with max dimension of 12 in.
2. **Feeder Busway** – Nominal 9 in. wide by 4 in. deep “I” -shaped steel and aluminum enclosure containing factory mounted insulated copper bars rated for max 600 v, 1600 a. The copper feeder busway shall bear the UL Listing Mark and shall be installed in accordance with all provisions of Article 364 of the National Electrical Code, NFPA No. 70.
3. **Support Hanger** – Min 0.134 in. diam (10 gauge) galv steel wire bent to form a “hat”-shape with each “brim” of the hat shape bearing 2 in. on the top surface of the floor and with the “crown” depth sufficient to accommodate the packing material (Item 4) and the required fill material (Item 5) thickness.
4. **Packing Material** – Used as a permanent form to prevent leakage of the fill material when in a plastic state. Packing material may consist of cardboard, glass fiber or mineral wool batt insulation.
5. **Fill, Void or Cavity Materials* – Caulk or Sealant** – Applied to fill through opening to a min depth of 1 in. As measured from the top surface of the packing material.
3M COMPANY – CP 25WB+ caulk or FB-3000 WT sealant.
6. **Steel Cover Plate** – Min 0.019 in. thick (28 gauge) galv steel cut to follow the contours of the busway with a min lap of 2 in. on all sides of the through opening. Steel cover plate secured to top surface of floor assembly with min 1/4 in. diam by 1-1/2 in. long steel expansion bolts in conjunction with steel nuts and washers. Max spacing of steel cover plate fasteners not to exceed 7 in. O.C. Prior to installation of the steel cover plate, a nom 1/4 in. diam bead of caulk (Item 5) shall be applied to the floor surface around the perimeter of the through opening.

*Bearing the UL Classification Marking

Reprinted from the Online Certifications Directory with permission from Underwriters Laboratories Inc.
Copyright © 2010 Underwriters Laboratories Inc.®



Misc. Electrical • Gypsum

Through Penetrations • Misc. Electrical • Gypsum

| 3M UL Systems | "F" Rating | 3M Product | Through Penetrant Details |
|-----------------|------------|--|--|
| W-L-6002 | 2 | 3M™ Fire Barrier Composite Sheet CS-195+ 3M™ Fire Barrier Wrap Strips FS-195+ 3M™ Fire Barrier Sealant CP 25WB+ 3M™ Fire Barrier Sealant IC 15WB+ 3M™ Fire Barrier Moldable Putty Stix MP+ | 7" x 4" cable trough, fiber optic cables. Also referred as WL6002. |
| W-L-6022 | 1, 2 | 3M™ Fire Barrier Water Tight Sealant 3000 WT 3M™ Fire Barrier Water Tight Sealant 1000 NS 3M™ Fire Barrier Silicone Sealant 2000 NS 3M™ Fire Barrier Silicone Sealant 2000+ | U400 Series gypsum wall. Max 23 in. x 4-1/2 in. I shaped aluminum/steel enclosure with 600 V, 5000 A copper bars or 600V, 4000A aluminum bars. Max 30 in. x 10 in. opening. Min 3/4 in. to max 1-3/4 in. annular space. 1 & 2 hour F. Mineral wool required. Also known as WL6022. |

System No. W-L-6002

May 19, 2005

F Rating – 2 Hr

T Rating – 2 Hr

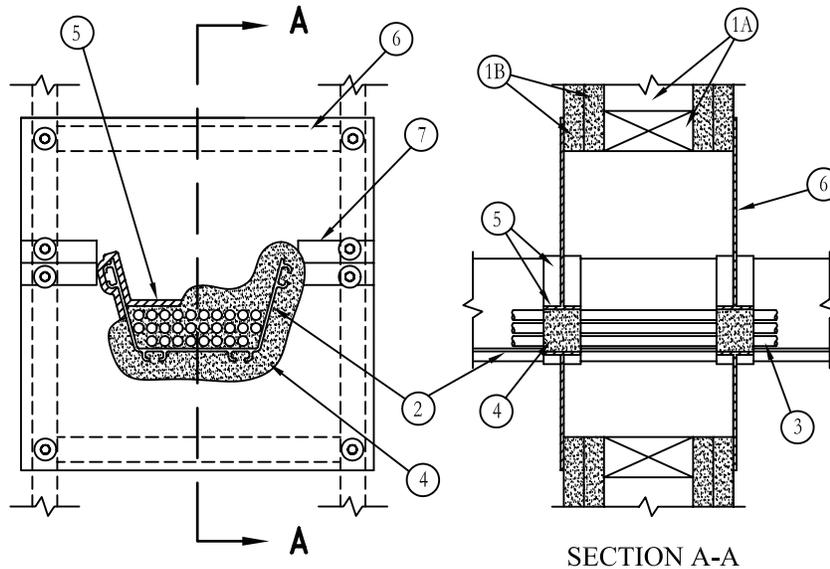

1. **Wall Assembly** – The fire-rated gypsum board/stud wall assembly shall be constructed of the materials and in the manner described in the individual U300, U400 or V400 Series Wall and Partition Design in the UL Fire Resistance Directory and shall include the following construction features:
 - A. **Studs** – Wall framing may consist of either wood studs or steel channel studs. Wood studs to consist of nom 2 in. by 4 in. (51 mm by 102 mm) lumber spaced max 16 in. (406 mm) OC. Steel studs to be min 3-5/8 in. (92 mm) wide and spaced max 24 in. (610 mm) OC. The opening in the wall to accommodate the cable trough (Item 2) shall be framed on all sides using lengths of stud installed between the vertical studs and secured to the studs at each end. The framed opening in the wall shall be min 4 in. to max 6 in. (102 mm to max 152 mm) wider and higher than the width and height of the cable trough such that, when the cable trough is centered in the opening, a 2 in. to 3 in. (51 mm to 76 mm) clearance is present between the cable trough and the framing on all four sides.
 - B. **Gypsum Board*** – Two layers of nom 5/8 in. (16 mm) thick gypsum board, as specified in the individual Wall and Partition Design.
2. **Cable Trough** – Max 7 in. (178 mm) wide by max 4 in. (102 mm) deep telecommunication cable trough formed from nom 0.105 in. (2.7 mm) thick polyvinyl chloride (PVC). Cable trough centered in framed opening and rigidly supported on both sides of wall assembly.
3. **Fiber Optic Cables** – Multiple fiber optical communication cable jacketed on the outside with PVC and having a max outside diam of 1/2 in. (13 mm) Aggregate cross-sectional area of cables in cable trough not to exceed 31 percent of the cross-sectional area of the cable trough.
4. **Fill, Void or Cavity Materials* – Caulk, Sealant or Putty** – Moldable putty material kneaded by hand and packed tightly into cable interstices within cable trough. A min 2 in. (51 mm) wide band of moldable putty shall be applied inside the cable trough and inside the cable bundle on each side of the assembly. The nom 2 in. (51 mm) wide moldable putty band shall extend approx 1 in. (25 mm) into the framed opening and approx 1 in. (25 mm) beyond the wall surface. After installation of the wrap strip (Item 5) and intumescent sheet (Item 6) fill materials, a nom 1/8 in. (3.2 mm) thickness of the moldable putty shall be applied to completely cover the wrap strip fill material at its egress from the intumescent sheet on each side of the wall.

3M COMPANY – CP 25WB+, IC 15WB+ caulk, FB-3000 WT sealant, MPP+ putty
5. **Fill, Void or Cavity Materials* – Wrap Strip** – Nom 1/4 in. (6 mm) thick intumescent elastomeric material faced on one side with aluminum foil, supplied in nom 2 in. (51 mm) wide strips. Nom 2 in. (51 mm) wide strip installed (foil side out) to tightly-follow the contours of the moldable putty band (Item 4) within the cable trough and also to the entire perimeter of the cable trough at its egress from the intumescent sheet (Item 6) on each side of the wall assembly. Narrow pieces of wrap strip to be inserted in the “support channels” of the cable trough. Wrap strips to project approx 7/8 in. (22 mm) beyond each face of the intumescent sheet (Item 6) on each side of the wall.

3M COMPANY – FS-195+
6. **Fill, Void or Cavity Materials* – Intumescent Sheet** – Rigid aluminum foil-faced sheet with galv steel sheet backer. Sheets cut to tightly-follow the contours of the wrap strip (Item 4) around the entire perimeter of the cable trough and cable fill. Sheets cut to lap a min of 2 in. (51 mm) on the wall on all sides of the opening on both sides of the wall. Prior to installation, a nom 1/8 in. by 1/2 in. (3.2 mm by 13 mm) ribbon of putty (Item 4) shall be applied as a gasket approx 1 in. (25 mm) from and on all sides of the through opening. Sheet to be installed with the galv steel sheet backer exposed (aluminum foil facing against wall surface) and secured to framing, through gypsum board layers, with steel screws or nails in conjunction with min 1-1/4 in. (32 mm) diam steel fender washers. Max spacing of fasteners not to exceed 6 in. (152 mm) with additional fasteners located on each side of butted seams or slits made to permit installation of the sheet around the cable trough.

3M COMPANY – CS-195+
7. **Steel Cover Strip** – Min 2 in. (51 mm) wide strip of min 0.020 in. (0.51 mm) thick (26 gauge) galv steel centered over entire length of each butted seam or slit made in the intumescent sheet (Item 6). Prior to installation of the steel strip, the seam or slit in the intumescent sheet shall be covered with a nom 1/8 in. by 1/2 in. (3.2 mm by 13 mm) ribbon of putty (Item 4). Steel cover strip secured to galv steel sheet backer of intumescent sheet with steel sheet metal screws or steel rivets spaced max 3 in. (76 mm) OC on each side of seam or slit.

*Bearing the UL Classification Marking

Reprinted from the Online Certifications Directory with permission from Underwriters Laboratories Inc.
Copyright © 2010 Underwriters Laboratories Inc.®



System No. W-L-6022

May 09, 2013

F Rating – 1 & 2 Hr (See Item 1)

T Rating – 0 Hr

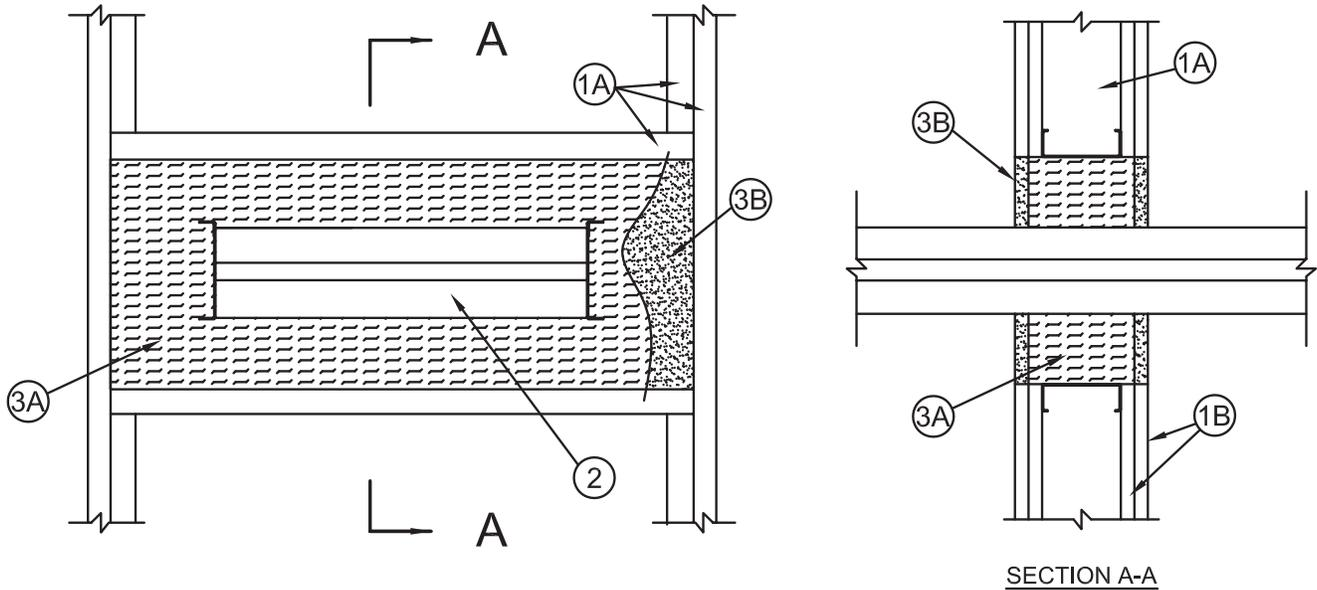

SECTION A-A

1. **Wall Assembly** – The 1 or 2 Hr fire-rated gypsum wallboard/stud wall assembly shall be constructed of the materials and in the manner specified in the individual U400 Series Wall and Partition Designs in the UL Fire Resistance Directory and shall include the following construction features:
 - A. **Studs** – Wall framing to consist of min 3-1/2 in. (89 mm) wide steel channel studs spaced max 24 in. (610 mm) OC for 1 Hr rated walls. Steel studs to be min 2-1/2 in. (64 mm) wide and spaced max 24 in. (610 mm) OC for 2 Hr rated walls. Additional framing members to be installed in stud cavity containing busway to form a rectangular box around the opening.
 - B. **Gypsum Board*** – One or two layers of nom 5/8 in. (16 mm) thick gypsum wallboard, as specified in the individual Wall and Partition Design. Max area of opening is 300 sq in. (1935 cm²) with max dimensions of 30 in. (762 mm) wide by 10 in. (254 mm) high.

The hourly F Rating of the firestop system is equal to the hourly rating of the wall.
2. **Busway+** – Nom 23 in. (584 mm) wide by 4.5 in. (114 mm) deep (or smaller) “T” shaped aluminum and steel enclosure containing factory mounted copper bars rated for 600 V, 5000A or aluminum bars rated 600V, 4000A. One busway to be installed within the opening. The annular space between the busway and the periphery of the opening shall be min 3/4 in. (19 mm) to max 1-3/4 in. (44 mm). Busway to be rigidly supported on both sides of wall assembly. The busway shall bear the UL Listing Mark and shall be installed in accordance with all provisions of Article 364 of the National Electrical Code, NFPA 70.
3. **Firestop System** – The firestop system shall consist of the following:
 - A. **Packing Material** – Min 4 in. (102 mm) thickness of min 4 pcf (64 kg/m³) mineral wool batt insulation firmly packed and compressed to 50 percent into opening as a permanent form. Packing material to be recessed from both surfaces of wall as required to accommodate the required thickness of fill material.
 - B. **Fill, Void or Cavity Material* – Sealant** – Min 1/2 in. (13 mm) thickness of fill material applied within the annular space, flush with both surfaces of wall.

3M COMPANY 3M FIRE PROTECTION PRODUCTS – Types FB-2000, FB2000+, FB-1000NS or FB-3000WT.

+Bearing the UL Listing Mark

*Bearing the UL Classification Mark

Reprinted from the Online Certifications Directory with permission from UL

© 2013 UL LLC



Miscellaneous Mechanical

CAJ

Concrete floors with a minimum thickness less than or equal to 5 inches (127 mm)

Concrete or masonry walls with a minimum thickness less than or equal to 8 inches (203 mm)

FA

Concrete floors/Steel decks

Concrete or masonry walls with a minimum thickness less than or equal to 8 inches (203 mm)

FC

Floor assemblies

Framed floors

FE

Truss floor assemblies

WJ

Floor assemblies

Concrete or masonry walls with a minimum thickness less than or equal to 8 inches (203 mm)

WL

Wall assemblies

Framed walls

Misc. Mechanical • Concrete

| 3M UL Systems | "F" Rating | 3M Product | Through Penetrant Details |
|---------------|------------|--|---|
| C-AJ-7003 | 2, 3 | 3M™ Fire Barrier Sealant CP 25WB+ 3M™ Fire Barrier Water Tight Sealant 3000 WT | Max. 16 in. diameter spiral wound steel duct or max. 10 in. diameter straight seam duct penetrating a min. 4.5 in. thick concrete floor or wall. Steel sleeve required. |
| C-AJ-7016 | 2, 3 | 3M™ Fire Barrier Sealant CP 25WB+ 3M™ Fire Barrier Sealant IC 15WB+ 3M™ Fire Barrier Water Tight Sealant 3000 WT | Max. 32 in. x 14 in. galvanized steel duct penetrating a minimum 2.5 in. thick concrete floor or wall. |
| C-AJ-7017 | 2 | 3M™ Fire Barrier Sealant CP 25WB+ 3M™ Fire Barrier Sealant IC 15WB+ 3M™ Fire Barrier Composite Sheet CS-195+ 3M™ Fire Barrier Moldable Putty Stix MP+ 3M™ Expanrol™ Flexible Intumescent Strip E-FIS | Max. two max. 14 in. x 12 in. steel ducts penetrating the same opening in a min. 2.5 in. thick concrete floor or wall. Utilizing CS 195+ Composite Sheet. |
| C-AJ-7029 | 2 | 3M™ Fire Barrier Mortar | Steel duct coated with Flamebar® BW11 coating with a max. perimeter of 13.4 feet with a max. 44 in. dimension penetrating a min. 4.5 in. thick concrete floor or wall. Utilizing Fire Barrier Mortar. |
| C-AJ-7030 | 2 | 3M™ Fire Barrier Mortar | Steel duct coated with Flamebar® BW11 coating with a max. perimeter of 160 in. with a max. 44 in. dimension penetrating a min. 4.5 in. thick concrete floor or wall. Utilizing Fire Barrier Mortar. |
| C-AJ-7076 | 2 | 3M™ Fire Barrier Sealant CP 25WB+ 3M™ Fire Barrier Sealant IC 15WB+ 3M™ Fire Barrier Water Tight Sealant 3000 WT 3M™ Fire Barrier Packing Material PM4 | Max. 30 in. x 18 in. steel duct penetrating a min. 4.5 in. thick concrete floor or wall. |
| C-AJ-7081 | 2 | 3M™ Fire Barrier Sealant IC 15WB+ 3M™ Fire Barrier Sealant CP 25WB+ 3M™ Fire Barrier Water Tight Sealant 3000 WT | Max. 16 in. diameter spiral wound steel duct or max. 10 in. diameter straight seam duct penetrating a min. 4.5 in. thick concrete floor or wall. |
| C-AJ-7096 | 2 | 3M™ Fire Barrier Water Tight Sealant 1000 NS 3M™ Fire Barrier Duct Wrap 615 3M™ Fire Barrier Duct Wrap 615+ | Max. 168 in. perimeter steel duct having a max. 60 in. dimension wrapped with Fire Barrier Duct Wrap 615 or 615+ penetrating a min. 4.5 in. thick concrete floor or wall. |
| C-AJ-7110 | 2 | 3M™ Fire Barrier Pillows 3M™ Fire Barrier Self-Locking Pillows 3M™ Fire Barrier Moldable Putty Stix MP+ | Max. 30 in. x 24 in. steel duct penetrating a min. 4.5 in. thick concrete floor or wall. Utilizing Fire Barrier Pillows and Putty. |
| C-AJ-7155 | 2 | 3M™ Fire Barrier Tuck-In Wrap Strips 3M™ Fire Barrier Sealant CP 25WB+ 3M™ Fire Barrier Sealant IC 15WB+ 3M™ Fire Barrier Water Tight Sealant 3000 WT | Max. 36 in. diameter spiral wound steel duct having 2 in. thick fiberglass insulation penetrating a min. 4.5 in. thick concrete floor or wall. |
| F-A-7019 | 1, 2 | 3M™ Fire Barrier Sealant CP 25WB+ 3M™ Fire Barrier Composite Sheet CS-195+ | 24 in. x 30 in. Pottorff fire damper. Max 13-1/2 sq. ft opening with max dimension of 48-1/4 in. Mounting angles and retaining angles required. Min 2 in. to max 22-1/4 in. annular. 2 hour F rating. Also known as FA7019. |
| W-J-7030 | 1, 2 | 3M™ Fire Barrier Sealant CP 25WB+ 3M™ Fire Barrier Sealant IC 15WB+ 3M™ Fire Barrier Wrap Ultra GS | 30" x 24" 24 gauge steel air duct, 1-1/2" fiberglass insulation, max opening 1015 sq. in.. Also referred as WJ7030. |
| W-J-7036 | 1, 2 | 3M™ Fire Barrier Sealant CP 25WB+ | Max. 96 in. x 96 in. duct built to SMACNA guidelines. Max opening 9800 sq. in. with max dimension 100 in. Min 1 in. to max 2 in. annular space. 2 hour F. No packing material required-sealant only. Retaining angles required. Also known as WJ7036. |
| W-J-7050 | 1, 2 | 3M™ Fire Barrier Sealant CP 25WB+ 3M™ Fire Barrier Sealant IC 15WB+ | 30" x 18" 24 gauge steel duct, maximum area opening 640 sq. in. maximum opening. Also referred as WJ7050. |
| W-J-7057 | 1, 2 | 3M™ Fire Barrier Sealant CP 25WB+ 3M™ Fire Barrier Sealant IC 15WB+ | Max. 5" min. 30 gauge steel HVAC duct through wall only. Also referred as WJ7057. |
| W-J-7095 | 1, 2 | 3M™ Fire Barrier Sealant CP 25WB+ 3M™ Fire Barrier Water Tight Sealant 3000 WT 3M™ Fire Barrier Sealant IC 15WB+ | Max 26 in. x 40 in. steel duct. Max opening 1617 sq. in. with max dimension 42 in. Concentric or eccentric installation. Min 1/2 in. to max 2 in. annular. 2 hour F. 0 hour T. Retaining angles required. Caulk only system. Also known as WJ7095. |
| W-J-7104 | 1, 2 | 3M™ Fire Barrier Duct Wrap 615 3M™ Fire Barrier Water Tight Sealant 1000 NS 3M™ Fire Barrier Duct Wrap 615+ | Max 85 in. x 24 in. min 22 ga. Steel duct. Max opening 17.3 sq. ft. with max width 89 in. Min 6 in. thick concrete. Duct protected with Fire Barrier Duct Wrap 615 or Fire Barrier Duct Wrap 615+. Concentric or eccentric installation. Min 1 in. to max 3 in. annular. 2 hour F & T rating. Packing material and retaining angles required. Also known as WJ7104. |
| W-J-7111 | 1, 2 | 3M™ Fire Barrier Packing Material PM4 3M™ Fire Barrier Water Tight Sealant 3000 WT 3M™ Fire Barrier Sealant CP 25WB+ 3M™ Fire Barrier Sealant IC 15WB+ | Max 24 in. x 24 in., min 22 gauge steel duct. Max area of opening 576 sq. in. with 24 in. max dimension. Min 3/4 in. to max 1-1/2 in. annular space. Concentric or eccentric installation. 2 hour F. No retaining angles. Mineral wool required. Also known as WJ7111. |

Misc. Mechanical • Concrete

| 3M UL Systems | "F" Rating | 3M Product | Through Penetrant Details |
|---------------|------------|--|---|
| W-J-7114 | 1, 2 | 3M™ Fire Barrier Sealant IC 15WB+ 3M™ Fire Barrier Sealant CP 25WB+ 3M™ Fire Barrier Water Tight Sealant 3000 WT | Max 100 in. x 100 in. steel duct per SMACNA guidelines. Min 6 in. concrete wall or concrete block wall. Max area of opening 77.3 sq. ft. with max width of 105-1/2 in. Nom 1-1/2 in. to 2 in. fiberglass insulation compressed a minimum 50% in plane of wall to create annular space. Mineral wool and sealant required. Min 16 gauge steel retaining angles required. Also known as WJ7114. |
| W-J-7115 | 1, 2 | 3M™ Fire Barrier Sealant IC 15WB+ 3M™ Fire Barrier Sealant CP 25WB+ 3M™ Fire Barrier Water Tight Sealant 3000 WT | Max 12 in. min 26 gauge spiral wound or long seam steel duct. Min 6 in. concrete wall or concrete block wall. Max diam of opening 14 in. Point contact to max 2 in. annular space. Sealant only solution-no mineral wool required. 2 hour F rating. Also known as WJ7115. |
| W-J-7129 | 1, 2 | 3M™ Fire Barrier Sealant IC 15WB+ 3M™ Fire Barrier Sealant CP 25WB+ 3M™ Fire Barrier Water Tight Sealant 3000 WT | Min 6 in. concrete or concrete block wall. Max 676 sq. in. opening with max 26 in. dimension. Max 24 by 24 in. min 26 gauge steel duct with 1/2 to 1-1/2 in. annular space. 2 hour F and 1/4 hour T rating. Less than 1 CFM/sq. ft. at ambient and 400°F. Also known as WJ7129 |
| W-J-7130 | 1, 2 | 3M™ Fire Barrier Sealant IC 15WB+ 3M™ Fire Barrier Sealant CP 25WB+ 3M™ Fire Barrier Water Tight Sealant 3000 WT | Min 6 in. concrete or concrete block wall. Max 928 sq. in. opening with max 32 in. dimension. Max 27 by 30 in. min 24 gauge steel duct with 1/2 to 1-1/2 in. annular space. 2 hour F and 1/2 hour T rating. Less than 1 CFM/sq. ft. at ambient and 400°F. Also known as WJ7130 |
| W-J-7131 | 1, 2 | 3M™ Fire Barrier Sealant IC 15WB+ 3M™ Fire Barrier Sealant CP 25WB+ 3M™ Fire Barrier Water Tight Sealant 3000 WT | Min 6 in. concrete or concrete block wall. Max 1024 sq. in. opening with max 32 in. dimension. Max 30 by 30 in. min 22 gauge steel duct with 1/2 to 1-1/2 in. annular space. 2 hour F and 1 hour T rating. Less than 1 CFM/sq. ft. at ambient and 400°F. Also known as WJ7131 |
| W-J-7134 | 1, 2 | 3M™ Fire Barrier Rated Foam FIP 1-Step | Min 6 in. concrete or concrete block wall. Max 1024 sq. in. opening with max 32 in. dimension. Max 30 by 30 in. min 22 gauge steel duct with 1/2 to 1-1/2 in. annular space. 2 hour F, 1/4 hour T, less than 1 CFM/sq. ft. at ambient and 400°F. Also known as WJ7134 |
| W-J-7135 | 1, 2 | 3M™ Fire Barrier Rated Foam FIP 1-Step | Min 6 in. concrete or concrete block wall. Max 928 sq. in. opening with max 32 in. dimension. Max 27 by 30 in. min 24 gauge steel duct with 1/2 to 1-1/2 in. annular space. 2 hour F, 1/2 hour T, less than 1 CFM/sq. ft. at ambient and 400°F. Also known as WJ7135 |
| W-J-7136 | 1, 2 | 3M™ Fire Barrier Rated Foam FIP 1-Step | Min 6 in. concrete or concrete block wall. Max 676 sq. in. opening with max 26 in. dimension. Max 24 by 24 in. min 26 gauge steel duct with 1/2 to 1-1/2 in. annular space. 2 hour F, less than 1 CFM/sq. ft. at ambient and 400°F. Also Known as WJ7136 |
| W-J-7137 | 1, 2 | 3M™ Fire Barrier Rated Foam FIP 1-Step | Min 6 in. concrete or concrete block wall. Max 1521 sq. in. opening with max 39 in. dimension. Nom 36 in. min 22 gauge spiral steel duct with 1/2 to 9-1/2 in. annular space. 2 hour F, 1/4 hour T, less than 1 CFM/sq. ft. at ambient and 400°F. Also known as WJ7137 |
| W-J-7167 | 2 | 3M™ Fire Barrier Sealant IC 15WB+ 3M™ Fire Barrier Sealant CP 25WB+ 3M™ Fire Barrier Water Tight Sealant 3000 WT 3M™ Fire Barrier Sealant FD 150+ | Max 20 in. No. 26 gauge spiral wound or max 12 in. No. 28 gauge steel duct |

System No. C-AJ-7003

October 05, 2006

F Rating – 3 Hr

T Rating – 0 Hr

L Rating At Ambient – 1 CFM/sq ft (See Item 3)

L Rating At 400 F – less than 1 CFM/sq ft (See Item 3)

W Rating – Class I (See Item 3B)

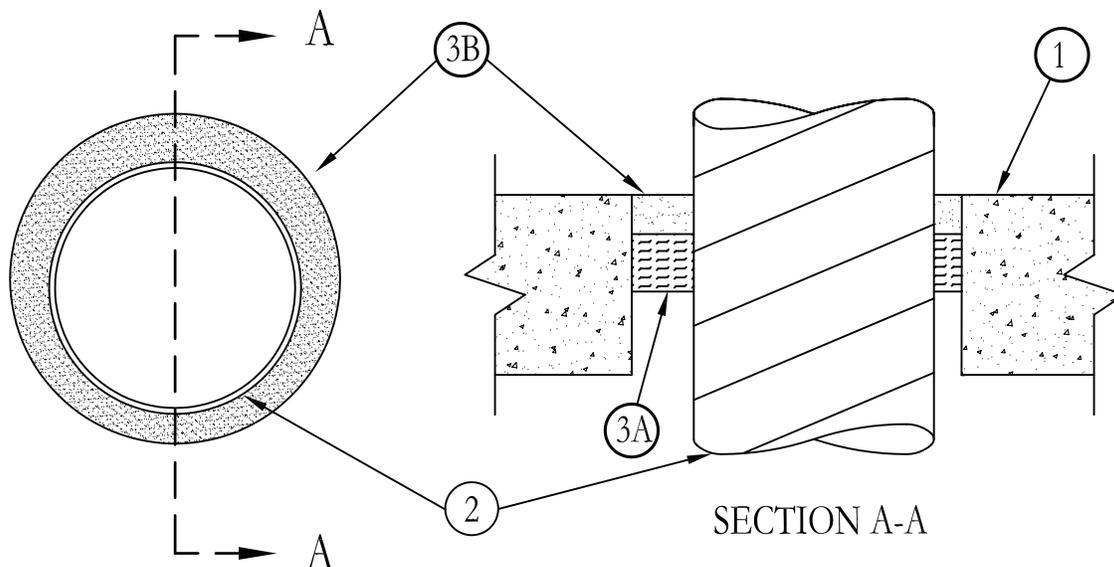

1. **Floor or Wall Assembly** – Min 4-1/2 in. (114 mm) thick lightweight or normal weight (100-150 pcf or 1600-2400 kg/m³) concrete. Wall may also be constructed of any UL Classified **Concrete Blocks***. Max diam of opening is 18 in. (457 mm).

See **Concrete Blocks** (CAZT) category in the Fire Resistance Directory for names of manufacturers.

- 1A. **Steel Sleeve** – Nom 6 in. (152 mm) diam (or smaller) Schedule 40 (or heavier) steel pipe sleeve, cast into floor or wall flush with floor or wall surfaces.
2. **Through Penetrant** – One steel duct to be installed either concentrically or eccentrically within the firestop system. An annular space of min 1/2 in. (13 mm) to max 1-1/2 in. (38 mm) is required within the firestop system. Steel duct to be rigidly supported on both sides of floor or wall assembly. The following sizes of steel ducts may be used:
 - A. **Steel Duct** – Nom 16 in. (406 mm) diam (or smaller) No. 24 gauge (or heavier) spiral wound galv steel duct.
 - B. **Steel Vent Duct** – Nom 10 in. (254 mm) diam (or smaller) No. 28 gauge (or heavier) galv steel vent duct.
3. **Firestop System** – The firestop system shall consist of the following:
 - A. **Packing Material** – Nom 1 in. (25 mm) thickness of tightly-packed mineral wool batt insulation firmly packed into opening as a permanent form. Polyethylene backer rod or nom 1 in. (25 mm) thick glass fiber insulation may be used with steel vent ducts (Item 2B) in lieu of mineral batt insulation. Packing material to be recessed from top surface of floor or from both surfaces of wall as required to accommodate the required thickness of caulk fill material.
 - B. **Fill, Void or Cavity Materials*** – **Caulk or Sealant** – Min 1 in. (25 mm) thickness of fill material applied within the annulus, flush with top surface of floor or both surfaces of wall assembly. W Rating applies only when FB-3000 WT sealant is used. Water resistance of through penetrant (Item 2) must be considered in addition to water resistance of firestop system.

3M COMPANY – CP 25WB+ or FB-3000 WT

(Note: W Rating applies only when FB-3000 WT sealant is used.)

*Bearing the UL Classification Marking

Reprinted from the Online Certifications Directory with permission from Underwriters Laboratories Inc.
Copyright © 2010 Underwriters Laboratories Inc.®



System No. C-AJ-7016

January 02, 2009

F Rating – 2 & 3 Hr (See Item 1)

T Rating – 0 Hr

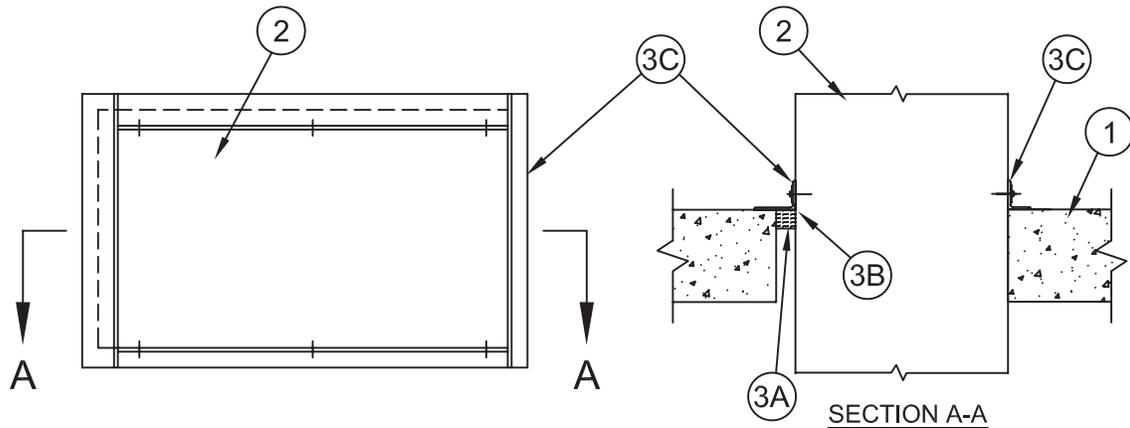

- Floor or Wall Assembly** – Min 2-1/2 in. (64 mm) thick or min 4-1/2 in. (114 mm) thick lightweight or normal weight (100-150 pcf or 1600 - 2400 kg/m³) concrete. Wall may also be constructed of any UL Classified **Concrete Blocks***. **The F Rating is 2 hr and 3 hr for min 2-1/2 in. (64 mm) or min 4-1/2 in. (114 mm) thick assemblies.** Max area of opening is 576 sq in. (3716 c/m² with max dimension of 36 in. (914 mm) for 2 hr assemblies and 544 sq in. (3510 c/m² with max dimension of 34 in. (864 mm) for 3 hr assemblies.

See **Concrete Blocks (CAZT)** category in the Fire Resistance Directory for names of manufacturers.

- Through-Penetrants** – One steel duct to be installed either concentrically or eccentrically within the firestop system. An annular space of min 0 in. (point contact) to max 4 in. (0 mm to max 102 mm) is required within the firestop system for 2 hr assemblies and min 0 in. (point contact) to max 2 in. (0 mm to max 51 mm) is required within the firestop system for 3 hr assemblies. Steel duct to be rigidly supported on both sides of floor or wall assembly. The following sizes of steel ducts may be used:
 - Steel Duct** – Nom 32 in. by 14 (813 mm by 356 mm) (or smaller) No. 22 gauge (or heavier) galv steel duct.
 - Steel Duct** – Nom 30 in. by 12 (762 mm by 305 mm) (or smaller) No. 24 gauge (or heavier) galv steel duct.
- Firestop System** – The firestop system shall consist of the following:
 - Packing Material** – Nom 1 in. (25 mm) thickness of tightly packed mineral wool batt insulation firmly packed into opening as a permanent form. Packing material to be recessed from top surface of floor or from both surfaces of wall as required to accommodate the required thickness of caulk fill material.
 - Fill, Void or Cavity Material* – Caulk or Sealant** – Min 1 in. (25 mm) thickness of fill material applied within annulus, flush with top surface of floor or both surfaces of wall assembly. At the point contact location between duct and concrete, a min 1/4 in. (6 mm) diam bead of sealant shall be applied to the concrete/duct interface on the top surface of floor and on both surfaces of wall assembly.
3M COMPANY – CP 25WB+, FB-3000 WT or IC 15WB+
 - Retaining Angles** – Min 16 gauge galv steel angles sized to lap duct a min of 2 in. (51 mm) and lap top surface of floor or both surfaces of wall a min of 1 in. (25 mm) Angles attached to duct with min 1/2 in. (13 mm) long, No. 10 (or larger) sheet metal screws spaced a max of 1 in. (25 mm) from each end of duct and spaced a max of 6 in. (152 mm) OC.

*Bearing the UL Classification Mark

Reprinted from the Online Certifications Directory with permission from Underwriters Laboratories Inc.
Copyright © 2010 Underwriters Laboratories Inc.®



System No. C-AJ-7017

May 19, 2005

F Rating – 2 Hr

T Rating – 0 Hr

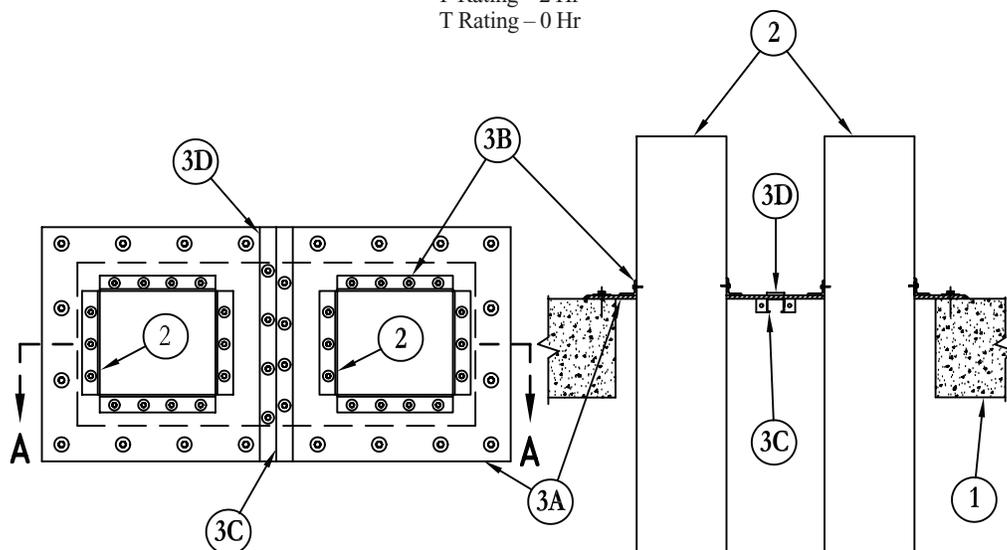

- 1. Floor or Wall Assembly** – Min 2-1/2 in. (64 mm) thick lightweight or normal weight (100-150 pcf or 1600-2400 kg/m³) concrete. Wall may also be constructed of any UL Classified **Concrete Blocks***. Max area of opening is 720 sq in. (4645 cm²) with max dimension of 40 in. (1016 mm).

See **Concrete Blocks (CAZT)** category in the Fire Resistance Directory for names of manufacturers.

- 2. Through Penetrant** – Max of two steel ducts, nom 12 in. by 14 in. (305 mm by 356 mm) (or smaller) No. 24 gauge (or heavier) to be installed either concentrically or eccentrically within the firestop system. An annular space of 0 in. (point contact) to max 5 in. (0 mm to max 127 mm) is required within the firestop system. A min 4 in. (102 mm) space shall be maintained between two ducts. Steel ducts to be rigidly supported on both sides of floor or wall assembly.

- 3. Firestop System** – The firestop system shall consist of the following:

- A. Fill, Void of Cavity Materials* – Intumescent Sheet** – Rigid aluminum foil-faced sheet with galv steel sheet backer. Sheets cut to tightly follow the contours of the duct with a max 1/4 in. (6 mm) gap between the sheets and the ducts. Sheets cut to lap a min of 2 in. (51 mm) on the floor or wall surface on all sides of the opening. Sheet is required to be installed on the top surface of floor or both sides of wall assembly. Sheet to be installed with the galv steel sheet backer exposed (aluminum foil facing against floor or wall surface) and secured to floor or wall surface with min 3/16 in. (5 mm) diam by 1-1/4 in. (32 mm) long steel anchor screws, or equivalent, in conjunction with min 1-1/4 in. (32 mm) diam steel fender washers. Max spacing of fasteners not to exceed 6 in. (152 mm) with additional fasteners located on each side of butted seams made to permit installation of the sheet around the ducts.
- B. Retaining Angles** – Min 16 gauge galv steel angles sized to lap duct a min of 2 in. (51 mm) and lap intumescent sheet on top surface of floor or both surfaces of wall a min of 2 in. (51 mm). Angles attached to duct and intumescent sheet with min 1/4 in. (6 mm) long, No. 10 (or larger) sheet metal screws spaced a max of 1 in. (25 mm) from each end of duct and spaced a max of 6 in. (152 mm) OC. Prior to the installation of the retaining angles, a min 1/4 in. (6 mm) diam bead of caulk (Item 3E) shall be applied at the intumescent sheet/duct interface on the top surface of floor and on both surfaces of wall assembly.
- C. Support Channel** – Support channel shall be installed flush with top surface of floor or both surfaces of wall, centered between ducts. Support channels to be min 1-5/8 in. by 1-5/8 in. (41 mm by 41 mm) and formed of min 0.093 in. (2.4 mm) thick (No. 12 gauge) painted or galv steel. Ends of steel channel bolted or welded to steel angles anchored to inside walls of through opening. Intumescent sheet secured to steel support channels with steel sheet metal screws in conjunction with min 1-1/4 in. (32 mm) diam steel fender washers. When support channel is used beneath butted seam of intumescent sheets, fasteners spaced max 3 in. (76 mm) OC on each side of butted seam. When support channel is located away from intumescent sheet seam, fasteners spaced max 6 in. OC. Prior to installation of the intumescent sheet(s), a nom 1/4 in. (6 mm) diam continuous bead of caulk (Item 3E) shall be applied as gasket over the steel support channel and the edge of intumescent sheet at its interface with surface of floor or wall around entire perimeter of through opening.
- D. Steel Cover Strip** – Min 2 in. (51 mm) wide strip of min 0.019 in. (0.5 mm) thick (26 ga) galv steel centered over entire length of each butted seam made in the intumescent sheet. Prior to installation of the steel strip, the seams in the intumescent sheet shall be covered with a min 1/4 in. (6 mm) diam bead of caulk (Item 3E). Steel cover strip secured to galv steel sheet backer of intumescent sheet with steel sheet metal screws or steel rivets spaced max 3 in. (76 mm) OC on each side of seam or slit.
- E. Fill, Void or Cavity Material* – Graphite Seal, Caulk, Sealant or Putty (Not Shown)** – One layer of 1/2 in. x 1/16 in. (13 mm by 1.6 mm) adhesive backed graphite intumescent seal positioned under intumescent sheet around entire perimeter of through opening or min 1/4 in. (6 mm) diam continuous bead of caulk or putty applied to edge of intumescent sheet at its interface with surface of floor or wall around entire perimeter of through opening. Min 1/4 in. (6 mm) bead of caulk applied to fill all interstices between duct and intumescent sheet. A min 1/4 in. (6 mm) diam bead of caulk shall be applied at the intumescent sheet/duct interface, and to all seams in the intumescent sheet on the top surface of floor and on both surfaces of wall assembly.

3M COMPANY – E-FIS or Ultra GS seals, CP 25WB+, IC 15WB+ caulk, FB-3000 WT sealant, or MP+ Stix putty.

*Bearing the UL Classification Marking

Reprinted from the Online Certifications Directory with permission from Underwriters Laboratories Inc.
Copyright © 2010 Underwriters Laboratories Inc.®





UL System No. C-AJ-7029
XHEZ - Through-penetration Firestop Systems

May 09, 2013

F Rating — 2 Hr

T Rating — 0 Hr

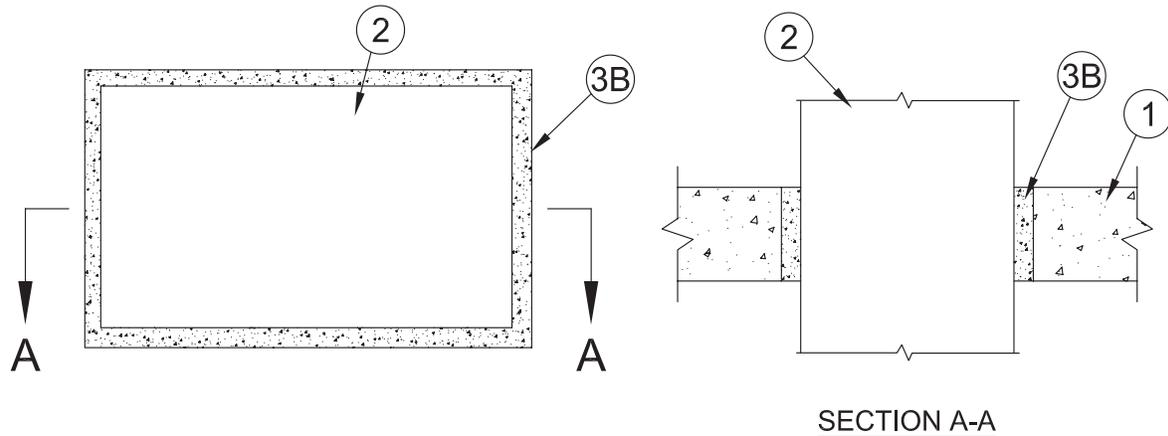

- 1. Floor or Wall Assembly** – Min 4-1/2 in. (114 mm) thick reinforced lightweight or normal weight (100-150 pcf or 1600-2400 kg/m³) concrete. Wall may also be constructed of any UL Classified **Concrete Blocks***. For rectangular ducts, max area of opening shall be 13.4 ft² (1.25 m²) with max dimension of 44 in. (1.11 m). For round ducts, max diam of opening shall be 44 in. (1.11 m). For oval shaped ducts, max dimension of opening shall be 44 in. (1.11 m) by 14 in. (0.37 m).

See **Concrete Blocks** (CAZT) category in the Fire Resistance Directory for names of manufacturers.

- 2. Through-Penetrants — Coated Ducts*** – Rectangular, round or flat oval coated steel air duct. For rectangular duct, max perimeter dimension shall be 13.3 ft. (4.06 m) with a max individual dimension of 40 in. (1.02 m). For round ducts, max diam shall be 40 in. (1.02 m) and for oval shaped ducts, max size of oval shall be 40 in. (1.02 m) by 10 in. (254 mm). Duct supplied coated with BW11 coating material. One duct to be centered within the firestop system with an annular space of 2 in. (51 mm). Reinforcement stiffener or transverse joint with bolted flanges shall be located approximately at the mid depth of the annular space. Duct to be rigidly supported on both sides of the floor or wall assembly. Duct sections shall be assembled using bolted flanges or SMACNA approved Transverse Joint Reinforcements.

FIRESPRAY INTERNATIONAL LTD — FLAMEBAR BW11 FIRE RATED DUCTWORK

- 3. Firestop System** – The firestop system shall consist of the following:

- A. Forms** — (Not Shown) — Used as a form to prevent leakage of fill material during installation. Forms to be a rigid sheet material, cut to fit the contour of the penetrating item and fastened to the underside of the floor or both sides of wall. Forms to be removed after fill material has cured.
- B. Fill, Void or Cavity Material* — Mortar** — Fill material applied within the annulus, flush with top and bottom surfaces of floor or with both surfaces of wall. Mortar is mixed with water in accordance with the mortar manufacturer's installation instructions.

A/D FIRE PROTECTION SYSTEMS INC — A/D Firebarrier Mortar

HILTI CONSTRUCTION CHEMICALS, DIV OF HILTI INC — CP637 Mortar

ISOLATEK INTERNATIONAL — Cafco TPS Mortar

EGS NELSON FIRESTOP — Type CMP Mortar

RECTORSEAL — Bio K10+ Mortar

HOBEN INTERNATIONAL LTD — Firecrete Mortar

SPECIFIED TECHNOLOGIES INC — SpecSeal Mortar

TREMCO INC — TREMstop M mortar

GCP APPLIED TECHNOLOGIES INC — Type KBS Mortar

3M COMPANY — 3M Fire Barrier Mortar

- C. Steel Angles** — (Optional, Not Shown) - Nom 4 by 4 by 1/4 in. (102 by 102 by 6 mm) thick steel angles installed around perimeter of opening on top surface of floor or both surfaces of wall. Steel angles shall lap a min of 2 in. (51 mm) onto the concrete on all sides of the opening. Steel angles shall be attached to through penetrant (Item 2) by means of nom 3/8 in. (9.5 mm) diam by 1-1/4 in. (32 mm) long steel bolts in conjunction with nom 3/8 in. (9.5 mm) by 1-1/2 in. (38 mm) diam steel fender washers spaced max 6 in. (152 mm) OC. Steel angles attached to concrete floor on all sides of the opening by means of nom 5/16 in. (8 mm) diam by 1-3/4 in. (45 mm) long concrete screws in conjunction with 3/8 in. (10 mm) by 1-1/2 in. (38 mm) diam steel fender washers spaced max 6 in. (152 mm) OC.

*Indicates such products shall bear the UL or cUL Certification Mark for jurisdictions employing the UL or cUL Certification (such as Canada), respectively.

Reprinted from the Online Certifications Directory with permission from UL©

3M Industrial Adhesives and Tapes
Fire Protection Products
 3M Center, Building 230-B-S-37
 St. Paul, MN 55144-1000



System No. C-AJ-7030

December 14, 2012

F Rating – 2 Hr

T Rating – 2 Hr

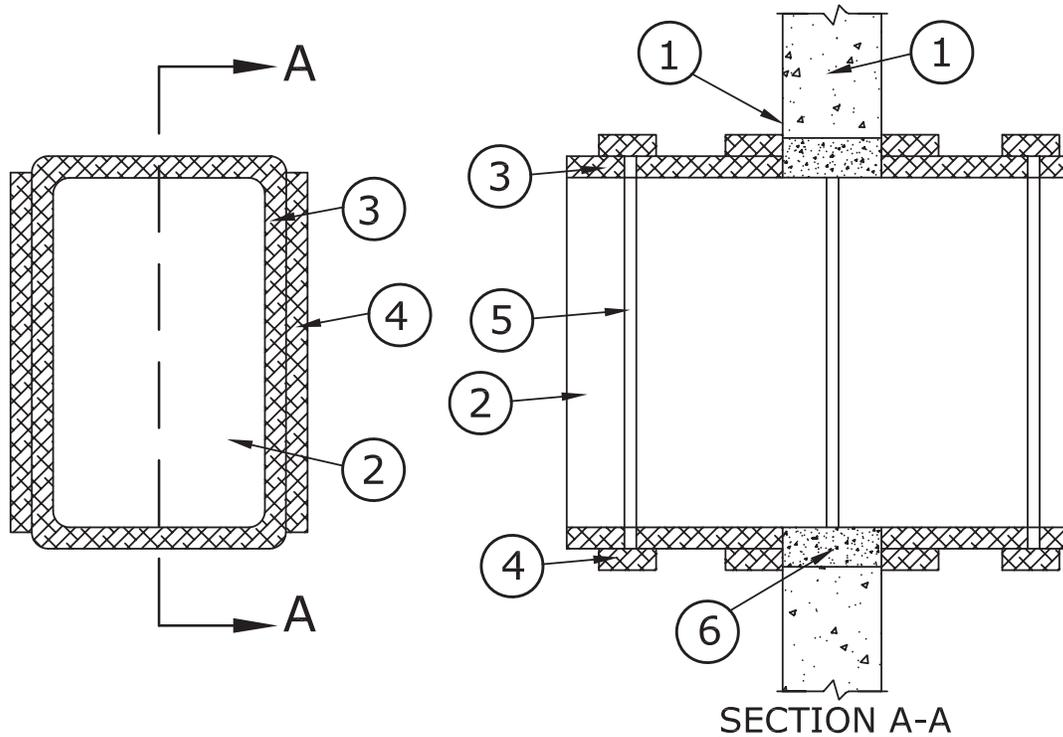

1. **Floor or Wall Assembly** – Min 4-1/2 in. (114 mm) thick reinforced lightweight or normal weight (100-150 pcf or 1600-2400 kg/m³) concrete. Wall may also be constructed of any UL Classified **Concrete Blocks***. For rectangular ducts, max area of opening shall be 1936 in². with max dimension of 44 in. (1118 mm). For round ducts, max diam of opening shall be 44 in. (1118 mm). For oval shaped ducts, max dimension of opening shall be 44 in. (1118 mm) by 14 in. (356 mm).
See **Concrete Blocks (CAZT)** category in the Fire Resistance Directory for names of manufacturers.
2. **Through-Penetrants – Coated Ducts*** – Rectangular, round or flat oval coated steel air duct. For rectangular ducts, max perimeter dimension shall be 160 in. (4064 mm) and a max individual dimension shall be 40 in. (1016 mm). For round ducts, max diam shall be 40 in. (1016 mm) and for oval shaped ducts, max size of oval shall be 40 in. (1016 mm) by 10 in. (254 mm). Duct supplied coated with BW11 coating material. One duct to be centered within the firestop system with an annular space of 2 in. (51 mm). Reinforcement stiffener or transverse joint with bolted flanges shall be located approximately at the mid depth of the annular space. Duct to be rigidly supported on both sides of the floor or wall assembly. Duct sections shall be assembled using bolted flanges or SMACNA approved Transverse Joint Reinforcements.
FIRESPRAY INTERNATIONAL LTD – FLAMEBAR BW11 FIRE RATED DUCTWORK
3. **Batts and Blankets*** – Nom 2 in. (51 mm) thick unfaced mineral wool batts having a min density of 6 pcf (96 kg/m³). Single layer of mineral wool batt material installed on duct with all joints sealed with a 4 in. (102 mm) wide pressure sensitive aluminum foil tape at each transverse joint, insulation material shall be cut to provide an overlapping (strip lapped) joint of 1 in. (25 mm).
See **Batts and Blankets (BZJZ)** category in the **Fire Resistance Directory** or **Batts and Blankets*** (BKNV) category in the **Building Materials Directory** for names of manufacturers.
4. **Insulation Collar** – Fabricated from the same mineral wool insulation material described in Item 3. Strips are 8 in. (203 mm) wide and are centered over each joint between adjacent ventilation duct sections, over each ventilation duct stiffener, and adjacent to each Firestop System.
5. **Steel Banding Straps** – (Not Shown) – Min 3/4 in. (19 mm) wide by 0.015 in. (0.38 mm) thick stainless steel banding strips used in conjunction with min 3/4 in. (19 mm) wide by 1 in. (25 mm) long stainless steel crimp clips. Banding strips spaced a max of 12 in. (305 mm) OC. Two banding strips used to secure each insulation collar (Item 4).
6. **Firestop System** – The firestop system shall consist of the following:
 - A. **Forms** – (Not Shown) – Used as a form to prevent leakage of fill material during installation. Forms to be a rigid sheet material, cut to fit the contour of the penetrating item and fastened to the underside of the floor or both sides of wall. Forms to be removed after fill material has cured.
 - B. **Fill, Void or Cavity Material*** – **Mortar** – Fill material applied within the annulus, flush with top and bottom surfaces of floor or with both surfaces of wall. Mortar is mixed with water by volume in accordance with the mortar manufacturer’s installation instructions.

3M COMPANY – 3M Fire Barrier Motar

*Bearing the UL Classification Mark

Reprinted from the Online Certifications Directory with permission from UL
© 2013 UL LLC



System No. C-AJ-7076

October 14, 2009

F Rating – 2 Hr

T Rating – 0 Hr

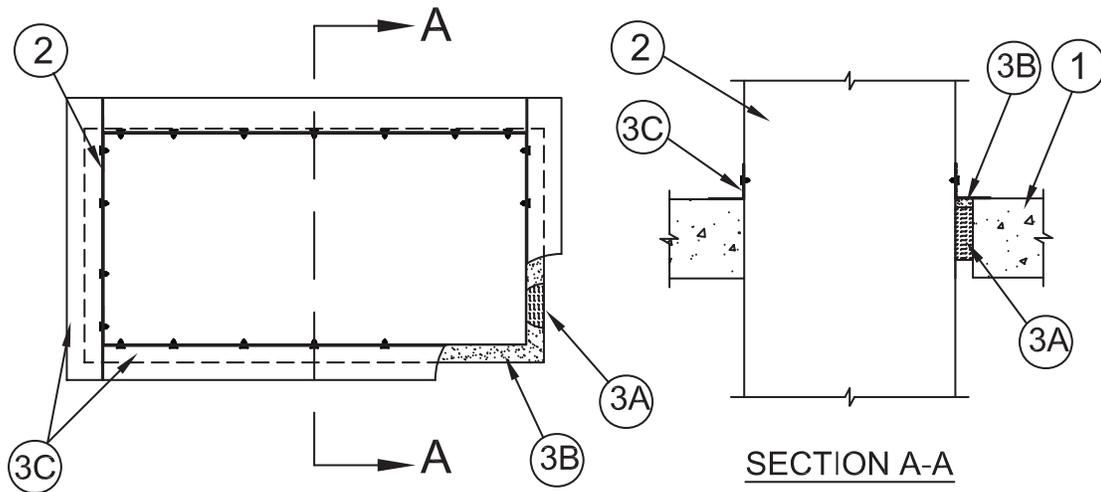

1. **Floor or Wall Assembly** – Min 4-1/2 in. (114 mm) thick reinforced lightweight or normal weight (100-150 pcf or 1600 - 2400 kg/m³) concrete. Floor assembly may also be constructed of any min 6 in. thick UL Classified hollow-core **Precast Concrete Units***. Wall may also be constructed of any UL Classified **Concrete Blocks***. Max area of opening 640 sq in. (4129 cm²) with a max dimension of 32 in. (812 mm). Max area of in floors constructed of hollow-core concrete is 49 sq in. (316 cm²) with a max dimension of 7 in. (178 mm).
See **Concrete Blocks (CAZT)** and **Precast Concrete Units (CFTV)** categories in Fire Resistance Directory for names of manufacturers.
2. **Steel Duct** – Nom 30 by 18 in. (762 by 457 mm) (or smaller) steel duct to be installed concentrically or eccentrically within opening. The duct shall be constructed and reinforced in accordance with SMACNA construction standards. Annular space between duct and periphery of opening shall be min 0 in. (point contact) to max 2 in. (51 mm). Duct to be rigidly supported on both sides of floor or wall assembly.
3. **Firestop System** – The firestop system shall consist of the following:
 - A. **Packing Material** – Min 3 in. (76 mm) thickness of min 4 pcf or 64 kg/m³ mineral wool batt insulation firmly packed into opening as a permanent form. Packing material to be recessed from top surface of floor or from both surfaces of wall as required to accommodate the required thickness of fill material. In floors constructed of hollow-core concrete, packing material to be recessed from top and bottom surfaces of floor as required to accommodate the required thickness of fill material.
 - A1. **Forming Material*** – As an alternate to the packing material in Item 3A, nom 4 in. (102 mm) wide strips of min 1/2 in (13 mm) thick compressible mat to be stacked to a thickness greater than the width of the annular space and compression-fitted, edge-first, to fill the annular space to a min 4 in. (102 mm) depth. Top of forming material to be recessed from top surface of floor or from both surfaces of wall as necessary to accommodate the required thickness of caulk fill material. In floors constructed of hollow-core concrete, forming material to be recessed from top and bottom surfaces of floor as required to accommodate the required thickness of fill material.
3M COMPANY – Fire Barrier Packing Material
 - B. **Fill, Void or Cavity Materials* – Caulk or Sealant** – Min 1/2 in. (13 mm) thickness of caulk applied within the annulus, flush with top surface of floor or with both surfaces of wall. In floors constructed of hollow-core concrete, min 1/2 in. (13 mm) thickness of caulk applied within the annulus, flush with top and bottom surfaces of floor. Min 1/4 in. (6 mm) diam bead of caulk applied to the duct/concrete interface at the point contact location on the top surface of floor or both surfaces of wall or hollow-core concrete.
3M COMPANY – IC 15WB+, CP 25WB+ caulk, or FB-3000 WT sealant
 - C. **Retaining Angles** – Min 16 GA galv steel angles sized to lap duct a min of 2 in. (51 mm) and lap periphery of opening a min of 1 in. (25 mm). Angles attached to all four sides of steel duct on top surface of floor or both surfaces of wall with No. 10 (or larger) steel sheet metal screws spaced a max 1 in. (25 mm) from each end and max 6 in. (152 mm) OC.

*Bearing the UL Classification Mark

Reprinted from the Online Certifications Directory with permission from Underwriters Laboratories Inc.
Copyright © 2010 Underwriters Laboratories Inc.®



System No. C-AJ-7081

May 19, 2005

F Rating – 2 Hr

T Rating – 0 Hr

W Rating – Class I (See Item 3)

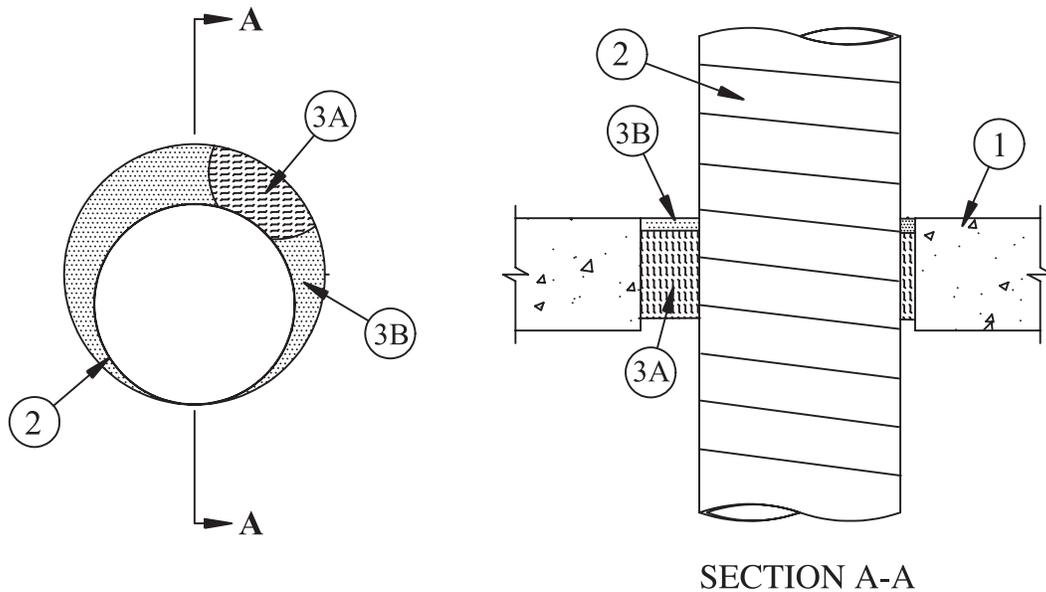

- Floor or Wall Assembly** – Min 4-1/2 in. (114 mm) thick reinforced lightweight or normal weight (100-150 pcf or 1600-2400 kg/m³) concrete. Floor assembly may also be constructed of any min 6 in. (152 mm) thick UL Classified hollow-core **Precast Concrete Units***. Wall assembly may also be constructed of any UL Classified **Concrete Blocks***. Max diam of opening is 18 in. (457 mm) Max diam of openings in floors constructed of hollow-core concrete is 7 in. (178 mm).
See **Concrete Blocks (CAZT)** categories in Fire Resistance Directory for names of manufacturers.
- Through Penetrant** – One steel duct to be installed either concentrically or eccentrically within the firestop system. An annular space of min 1/2 in. to max 1-1/2 in. (13 mm to max 38 mm) is required within the firestop system. Steel duct to be rigidly supported on both sides of floor or wall assembly. The following sizes of steel ducts may be used:
 - Steel Duct** – Nom 16 in. (406 mm) diam (or smaller) No. 24 gauge (or heavier) spiral wound galv steel duct.
 - Steel Vent Duct** – Nom 10 in. (254 mm) diam (or smaller) No. 28 gauge (or heavier) galv steel vent duct.
- Firestop System** – The firestop system shall consist of the following:
 - Packing Material** – Min 3-1/2 in. (89 mm) thickness of min 4 pcf (64 kg/m³) mineral wool batt insulation firmly packed into opening as a permanent form. Packing material to be recessed from top surface of floor or from both surfaces of wall to accommodate the required thickness of fill material. In floors constructed of hollow-core concrete, packing material to be recessed from top and bottom surfaces of floor as required to accommodate the required thickness of fill material.
 - Fill Void or Cavity Materials* – Caulk or Sealant** – Min 1/2 in. (13 mm) thickness of caulk applied within the annulus, flush with top surface of floor or with both surfaces of wall. In floors constructed of hollow-core concrete, min 1/2 in. (13 mm) thickness of caulk applied within the annulus, flush with top and bottom surfaces of floor. **W Rating applies only when FB-3000 WT sealant is used. Water resistance of through penetrant (Item 2) must be considered in addition to water resistance of firestop system.**
3M COMPANY – CP 25WB+, IC 15WB+ caulk or FB-3000 WT sealant.
(Note: W Rating applies only when FB-3000 WT sealant is used.)

*Bearing the UL Classification Mark

Reprinted from the Online Certifications Directory with permission from Underwriters Laboratories Inc.

Copyright © 2010 Underwriters Laboratories Inc.®



System No. C-AJ-7096

August 14, 2009

F Rating – 2 Hr

T Rating – 2 Hr

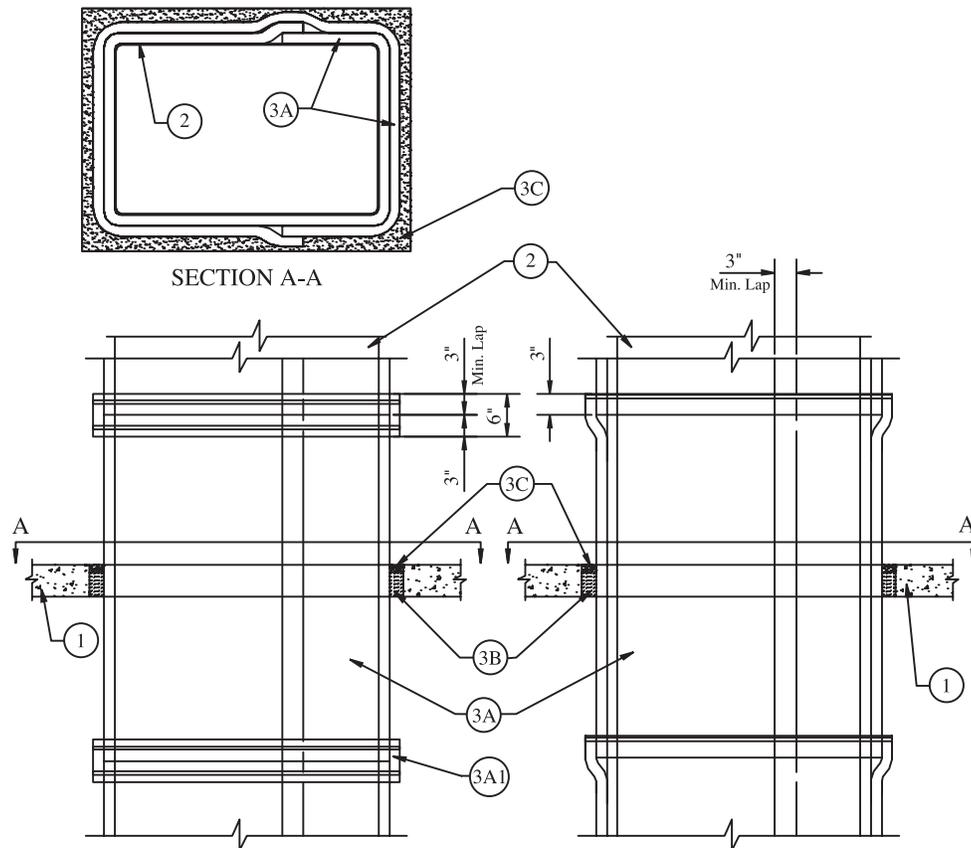

1. **Floor or Wall Assembly** – Min 4-1/2 in. (114 mm) thick reinforced normal weight (140-150 pcf or 1600-2400 kg/m³) concrete floor or min 5-1/4 in. (133 mm) thick reinforced normal weight concrete wall. Wall may also be constructed of any UL Classified **Concrete Blocks***. Max area of opening is 15 ft² (1.4 m²) with max dimension of 70 in. (1.8 m).
See **Concrete Blocks** (CAZT) category in the Fire Resistance Directory for names of manufacturers.
2. **Steel Air Duct** – Min 0.035 in. (0.9 mm) (20 gauge) thick (or heavier) steel duct having a max perimeter of 168 in (4.27 m) with max individual dimension of 60 in (1.52 m) and constructed in accordance with SMACNA HVAC Duct Construction standards. The sections shall be assembled using bolted flanges or SMACNA approved Transverse Joint Reinforcements. Duct to be rigidly supported in accordance with SMACNA requirement and as specified in Item 4. One steel duct to be installed concentrically or eccentrically within the firestop system. Duct to rigidly supported on both sides of floor or wall assembly.
3. **Firestop System** – The firestop system shall consist of the following:
 - A. **Duct Wrap Materials*** – Min 1-1/2 in. (38 mm) thick blanket totally encapsulated within foil-scrim facers. The steel duct shall be wrapped with two layers of duct wrap installed in accordance with the Ventilation Assembly No. V-20. See Ventilation Duct Assemblies in Vol. 2 of the Fire Resistance Directory. The annular space between the insulated steel air duct and the periphery of the opening shall be a min of 1 in. (25 mm) to a max of 3 in. (76 mm).
3M COMPANY – 3M FireBarrier Duct Wrap 15A, 3M FireBarrier Duct Wrap 20A, 3M FireBarrier Duct Wrap 615 or 3M FireBarrier Duct Wrap 615+
 - A1. **Batts and Blankets*** – **Collars** – Min 1-1/2 in. (38 mm) thick, 6 in. (152 mm) wide collars, totally encapsulated within foil-scrim facers. The transverse butt joints shall be wrapped using a collar. The collars shall be installed in accordance with the Ventilation Assembly No. V-20. See Ventilation Duct Assemblies in Vol. 2 of the Fire Resistance Directory.
3M COMPANY – 3M FireBarrier Duct Wrap 15A Collars, 3M FireBarrier Duct Wrap 20A Collars, 3M FireBarrier Duct Wrap 615 Collars or 3M FireBarrier Duct Wrap 615+ wCollars
 - B. **Packing Material** – Min 4 in. (102 mm) thickness of unfaced scrap duct wrap material or min 3 pcf (48 kg/m³) mineral wool batt insulation firmly packed into opening as a permanent form. Packing material to be recessed from the top surface of the floor or both surfaces of wall as required to accommodate the required thickness of fill material.
 - C. **Fill, Void or Cavity Material*** – **Sealant** – Min 5/8 in. (16 mm) thickness of fill material applied within the annulus, flush with top surface of floor or with both surfaces of wall.
3M COMPANY – FB 1000 N/S Sealant

*Bearing the UL Classification Mark

Reprinted from the Online Certifications Directory with permission from Underwriters Laboratories Inc.
Copyright © 2010 Underwriters Laboratories Inc.®

System No. C-AJ-7110

September 20, 2011

ANSI/UL1479 (ASTM E814)

F Rating – 2 Hr

T Rating – 3/4 Hr

CAN/ULC S115

F Rating – 2 Hr

FT Rating – 3/4 Hr

FH Rating – 2 Hr

FTH Rating – 3/4 Hr

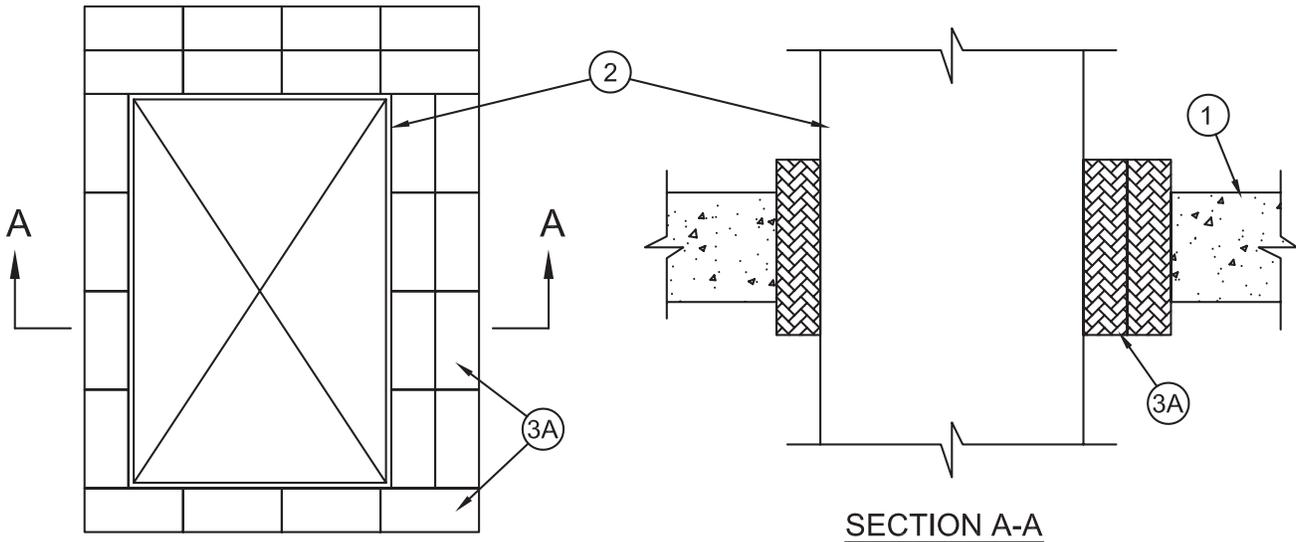

- Floor or Wall Assembly** – Min 4-1/2 in. (114 mm) thick reinforced lightweight or normal weight (100-150 pcf or 1600-2400 kg/m³) concrete. Wall may also be constructed of any UL Classified **Concrete Blocks***. Max area of opening 952 sq in. (0.61 m²) with a max dimension of 34 in. (864 mm).
See **Concrete Blocks** (CAZT) category in Fire Resistance Directory for names of manufacturers.
- Steel Duct** – Max 24 by 30 in. (610 by 762 mm) No. 22 gauge (or heavier) steel duct to be installed concentrically or eccentrically within opening. Annular space between duct and periphery of opening shall be min 1 in. (25 mm) to max 3 in. (76 mm). Duct to be rigidly supported on both sides of floor or wall assembly.
- Firestop System** – The firestop system shall consist of the following:
 - Fill, Void or Cavity Material* – Pillows** – Nom 9 in. (229 mm) long by 4 or 6 in. (102 or 152 mm) wide by 2 or 3 in. (51 or 76 mm) thick plastic covered pillows. Pillows to be installed lengthwise through the opening and positioned to extend equally in both directions from the approximate center line of the floor or wall. Pillows tightly-packed into opening to fill the annular space between the steel duct and the periphery of the opening.
3M COMPANY – Fire Barrier Pillows or Fire Barrier Self-Locking Pillows
 - Fill, Void or Cavity Material* – Putty** – (Not Shown) – After installation of pillows (Item 3A), putty applied to seal any voids between or around the pillows on the top surface of the floor or on both sides of the wall assembly.
3M COMPANY – MP+

*Bearing the UL Classification Mark

Reprinted from the Online Certifications Directory with permission from Underwriters Laboratories Inc.
Copyright © 2011 Underwriters Laboratories Inc.®



Through Penetrations

Misc. Mechanical

7000 Series

Concrete

CAJ

System No. C-AJ-7155

September 03, 2013

ANSI/UL1479 (ASTM E814)

F Rating – 2 Hr

T Rating – 1-1/2 Hr

CAN/ULC S115

F Rating – 2 Hr

FT Rating – 1-1/2 Hr

FH Rating – 2 Hr

FTH Rating – 1-1/2 Hr

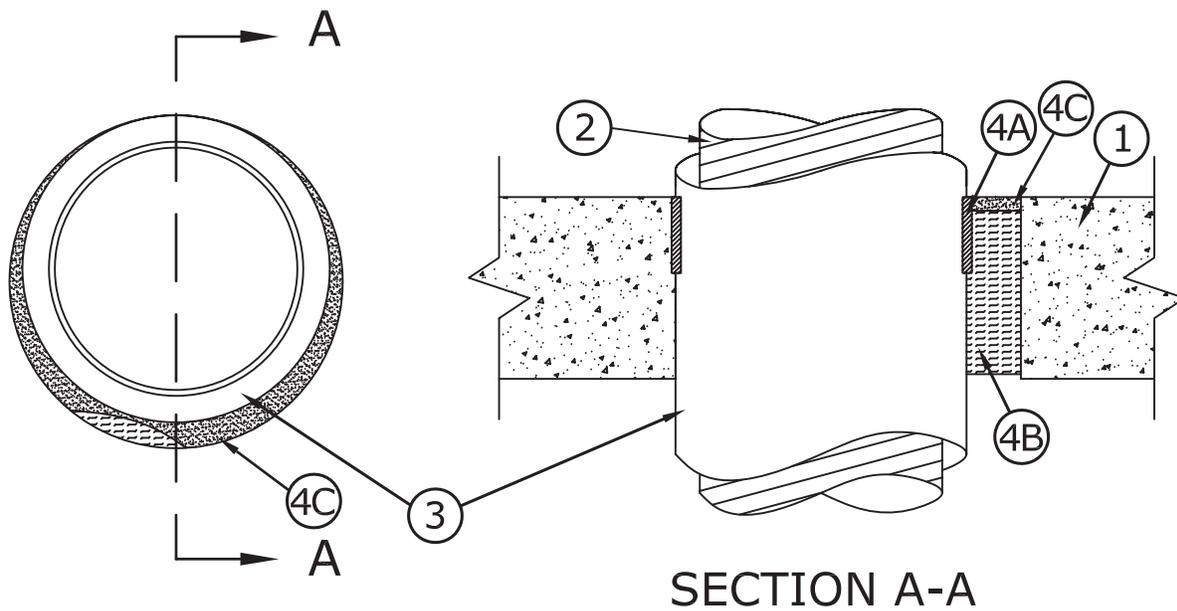

SECTION A-A

- Floor or Wall Assembly** – Min 4-1/2 in. thick reinforced lightweight or normal weight (100-150 pcf or 1600-2400 kg/m³) concrete floor or min 5 in. (127 mm) thick reinforced lightweight or normal weight concrete wall. Wall may also be constructed of any UL Classified **Concrete Blocks***. Max diam of opening 42 in. (1067 mm).
See **Concrete Blocks (CAZT)** in the Fire Resistance Directory for names of manufacturers.
- Steel Duct** – Nom 36 in. diam (or smaller) No. 22 gauge (or heavier) spiral-wound galvanized steel duct to be installed either concentrically or eccentrically within the firestop system. The annular space between duct and periphery of opening shall be min 2 in. (51 mm) to max 4 in. (102 mm) Steel duct to be rigidly supported on both sides of floor or wall assembly.
- Pipe Covering** – Nom 2 in. (51 mm) thick hollow cylindrical heavy density (min 2.5 pcf or 40 kg/m³) glass fiber units jacketed on the outside with an all service jacket. Longitudinal joints sealed with metal fasteners or factory-applied self-sealing lap tape. Transverse joints secured with metal fasteners or with butt tape supplied with product. Annular space between the pipe covering and periphery of opening or sleeve shall be min 0 in. (point contact) to max 2 in. (51 mm).

See **Pipe and Equipment Covering – Materials** – (BRGU) category in the Building Materials Directory for names of manufacturers. Any pipe covering material meeting the above specifications and bearing the UL Classification Marking with a Flame Spread Index of 25 or less and a smoke Developed Index of 50 or less may be used.

- Firestop System** – The firestop system shall consist of the following:
 - Fill, Void or Cavity Materials* – Wrap Strip** – Nom 1/4 in. (6 mm) thick intumescent elastomeric material faced on one side with plastic, supplied in 2 in. (51 mm) wide strips. One nom 2 in. (51 mm) wide strip tightly-wrapped around pipe covering material (Item 3) with the plastic side exposed and slid into through opening to be recessed from top surface of floor or from both surfaces of wall to accommodate the required thickness of fill material Item 4C. Wrap strip held in place with pressure-sensitive tape, steel tie wire, or equivalent.
3M COMPANY
3M FIRE PROTECTION PRODUCTS – Tuck-In Wrap Strip
 - Packing Material** – Min 4 in. (102 mm) thickness of min 4 pcf mineral wool batt insulation firmly packed into opening as a permanent form. Packing material to be recessed from top surface of floor or from both surfaces of wall to accommodate the required thickness of fill material.
 - Fill, Void or Cavity Materials* – Caulk or Sealant** – Min 1/2 in. (13 mm) thickness of caulk applied within the annulus, flush with top surface of floor or with both surfaces of wall. In floors constructed of hollow-core concrete, min 1/2 in. (13 mm) thickness of caulk applied within the annulus, flush with top and bottom surfaces of floor. Min 1/2 in. (13 mm) diam bead of caulk applied to the pipe covering/concrete interface at the point contact location on the top surface of floor or both surfaces of wall or hollow-core concrete.

3M COMPANY

3M FIRE PROTECTION PRODUCTS – IC 15WB+, CP 25WB+ caulk, or FB-3000 WT Sealant

*Bearing the UL Classification Mark

Reprinted from the Online Certifications Directory with permission from UL

© 2013 UL LLC



System No. F-A-7019

May 18, 2007
 F Rating – 2 Hr
 T Rating – 0 Hr

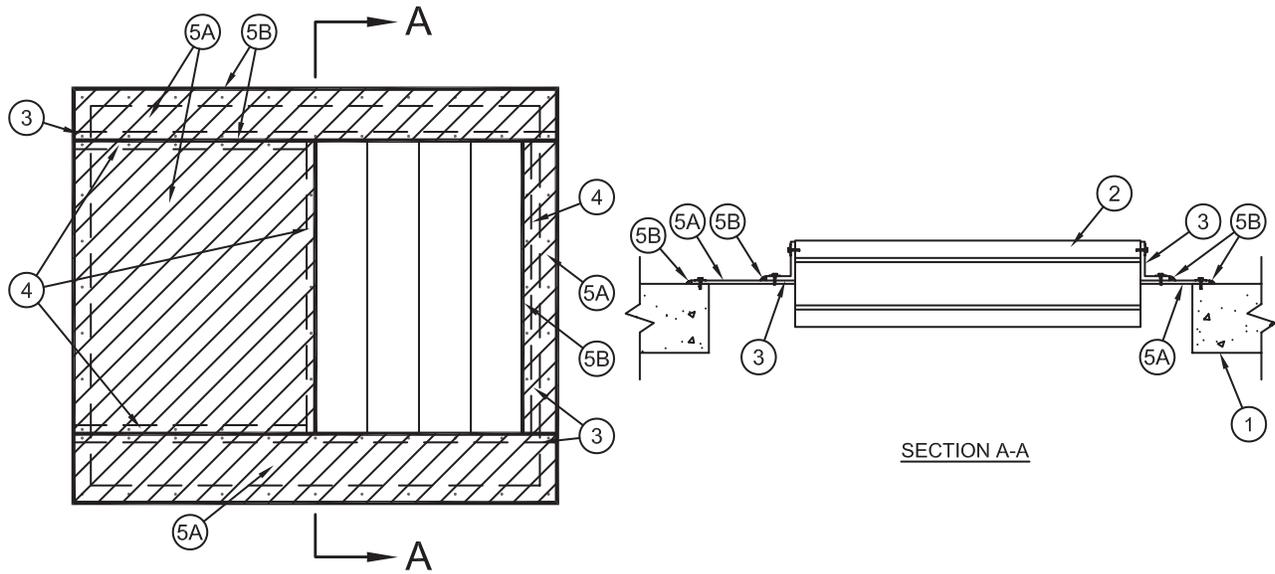

1. **Floor Assembly** – Min 4-1/2 in. (114 mm) thick reinforced lightweight or normal weight (100-150 pcf or 1600-2400 kg/m³) concrete. Max area of opening is 13.5 ft² (1.25 m²) with a max dimension of 48-1/4 in. (1.23 m).
2. **Fire Damper*** – Max 24 in. (610 mm) wide by 30 in. (762 mm) high multi-blade 1-1/2 hr fire damper provided with min 16 ga (0.060 in. or 0.41 mm thick) galv steel sleeve. Damper installed within opening such that the damper blades are flush with the top surface of the floor assembly when the blades are in the closed position. The annular spaces between the damper and the periphery of the opening shall be min 2 in. (51 mm) to max 22-1/4 in. (565 mm). The damper is secured within the opening through the attachment to the mounting angles (Item 3) and the retaining angles (Item 4).
POTTORFF – FD-140 fire damper
3. **Mounting Angles** – Min 2 by 2 by 1/4 in. (51 by 51 by 6 mm) steel angles sized to span the length of the opening and overlap onto the floor assembly a min of 2 in. (51 mm) on both sides of the opening. Angles are placed along opposite sides of the damper and anchored to the floor assembly through the composite sheet (Item 5A) with min 1/4 in. (25 mm) diam by 1-1/4 in. (32 mm) long steel masonry screws in conjunction with min 1/4 by 1-1/4 in. (6 by 32 mm) diam steel fender washers. The damper is attached to the angles with min No. 10 by 3/4 in. (19 mm) long steel self-tapping screws located a max of 1 in. (25 mm) from each end of the damper and spaced a max of 3 in. (76 mm) OC.
4. **Retaining Angles** – Min 2 by 2 in. (51 by 51 mm) min 16 ga (0.060 in. or 0.41 mm thick) galv steel angles. Angles are placed along opposite sides of the damper to extend the entire distance between the mounting angles (Item 3) at the same elevation as the mounting angles. The retaining angles are attached to the damper with min No. 10 by 3/4 in. (19 mm) long steel self-tapping screws located a max of 1 in. (25 mm) from each end and a max of 6 in. (152 mm) OC. Additional angles are placed along opposite sides of the opening on the insides of the mounting angles to span the distance between the retaining angle on the damper and overlap onto the floor assembly a min of 2 in. (51 mm). The retaining angles are attached to the mounting angles with min No. 10 by 3/4 in. (19 mm) long steel self-tapping screws located a max of 1 in. (25 mm) from each end and spaced a max of 6 in. (152 mm) OC.
5. **Firestop System** – The firestop system shall consist of the following:
 - A. **Fill, Void or Cavity Material* – Intumescent Sheet** – Rigid aluminum foil faced sheet with galv steel sheet backer. Intumescent sheet cut to lie within the mounting and retaining angles to cover all openings around the damper and overlap onto the floor assembly a min of 2 in. (51 mm) with galv steel side facing upward. A 1/4 in. (6 mm) spacing shall be maintained between the edge of the sheets and the vertical legs of the angles. Sheets are attached to the angles with min No. 10 by 1 in. (25 mm) long steel self-tapping screws in conjunction with min 3/16 by 1-1/4 in. (5 by 32 mm) diam steel fender washers located a max of 1 in. (25 mm) from each end and spaced a max of 6 in. (152 mm) OC. Sheets anchored to the floor assembly with min 1/4 in. (6 mm) diam by 1-1/4 in. (32 mm) long steel masonry screws in conjunction with min 1/4 by 1-1/4 in. (6 by 32 mm) diam steel fender washers.
3M COMPANY – CS-195+
 - B. **Fill, Void or Cavity Material* – Caulk** – Min 1/4 in. (6 mm) diam bead of caulk to be applied around the perimeter of the intumescent sheets at the floor/sheet interfaces. Min 1/2 in. (13 mm) diam bead of caulk installed to fill the 1/4 in. (6 mm) spacing between the intumescent sheets and the vertical legs of the mounting and retaining angles, overlapping onto the intumescent sheets.
3M COMPANY – CP 25WB+

*Bearing the UL Classification Mark

Reprinted from the Online Certifications Directory with permission from Underwriters Laboratories Inc.
 Copyright © 2010 Underwriters Laboratories Inc.®

System No. W-J-7030

May 19, 2005

F Rating – 2 Hr

T Rating – 2 Hr

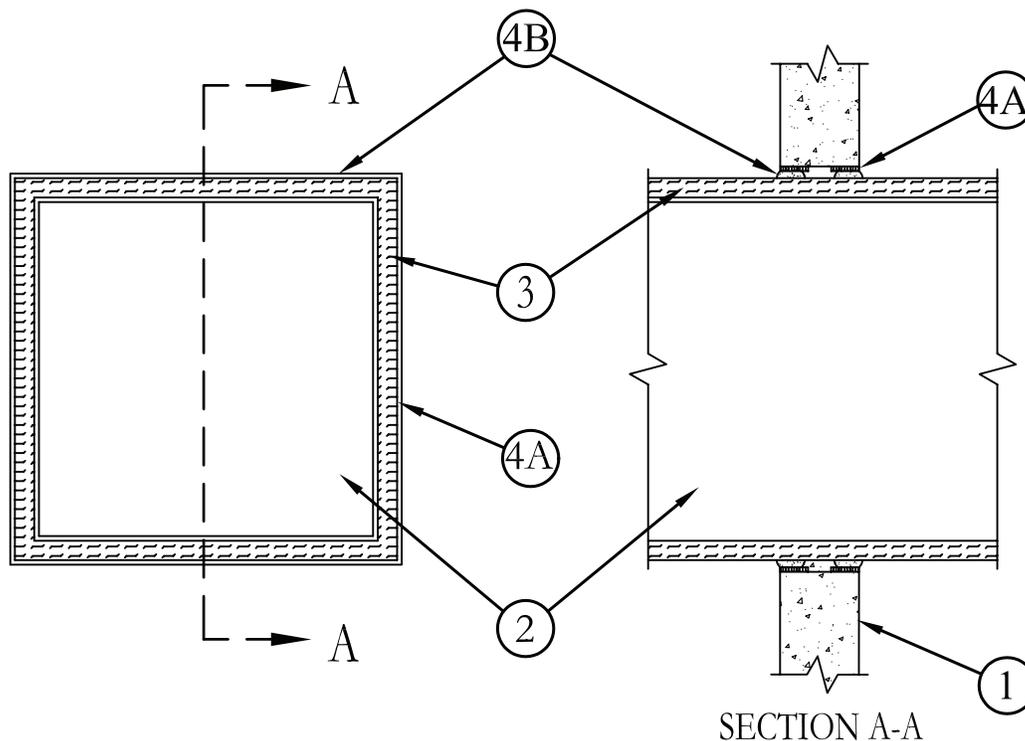

1. **Wall Assembly** – Min 6 in. (152 mm) thick reinforced lightweight or normal weight (100-150 pcf or 1600-2400 kg/m³) concrete wall. Wall may also be constructed of any UL Classified **Concrete Blocks***. Max size of opening is 1015 sq. in. (6548 cm²) with a max dimension of 35 in. (889 mm).
See **Concrete Blocks (CAZT)** category in the Fire Resistance Directory for names of manufacturers.
2. **Steel Air Duct** – Nom 30 in. by 24 in. (762 mm by 610 mm) min 24 gauge (or heavier) galv steel air duct to be installed either concentrically or eccentrically within the opening. Duct to be rigidly supported on both sides of wall assembly.
3. **Duct Insulation*** – Nom 1-1/2 in (38 mm) thick glass fiber blanket insulation jacketed on the outside with foil-scrim-kraft facing. Longitudinal and transverse joints sealed with foil-scrim kraft tape. A nominal 1 in. (25 mm) annular space shall be maintained between the insulated duct and the periphery of the opening.
See **Batts and Blankets (BKNV)** category in the Building Materials Directory for names of manufacturers. Any batts and blankets material meeting the above specifications and bearing the UL Classification Marking with a Flame Spread Index of 25 or less and a Smoke Developed Index of 50 or less may be used.
4. **Firestop System** – The firestop system shall consist of the following:
 - A. **Wrap Strip** – One layer of nom 1/8 in. (3.2 mm) thick intumescent material supplied in 2 in. (51 mm) wide strips tightly wrapped around duct insulation and held in place with 2 in. (51 mm) wide min 3 mil foil tape. Wrap strip slid into annulus on both sides of wall such that wrap strips extend approx 1/2 in. (13 mm) beyond both surfaces of wall. Exposed portion of wrap strip to be completely covered with min 3 mil foil tape.
3M COMPANY – Ultra GS
 - B. **Fill, Void or Cavity Materials*** – **Caulk or Sealant** – Min 5/8 in. (16 mm) thickness of fill material applied within annulus, flush with both surfaces of wall assembly
3M COMPANY – CP 25WB+, IC 15WB+ caulk or FB-3000 WT sealant

*Bearing the UL Classification Mark

Reprinted from the Online Certifications Directory with permission from Underwriters Laboratories Inc.
Copyright © 2010 Underwriters Laboratories Inc.®



Through Penetrations

Misc. Mechanical

7000 Series

Concrete

WJ

System No. W-J-7036

October 14, 2009

F Rating – 2 Hr

T Ratings – 0 and 3/4 Hr (See Item 2)

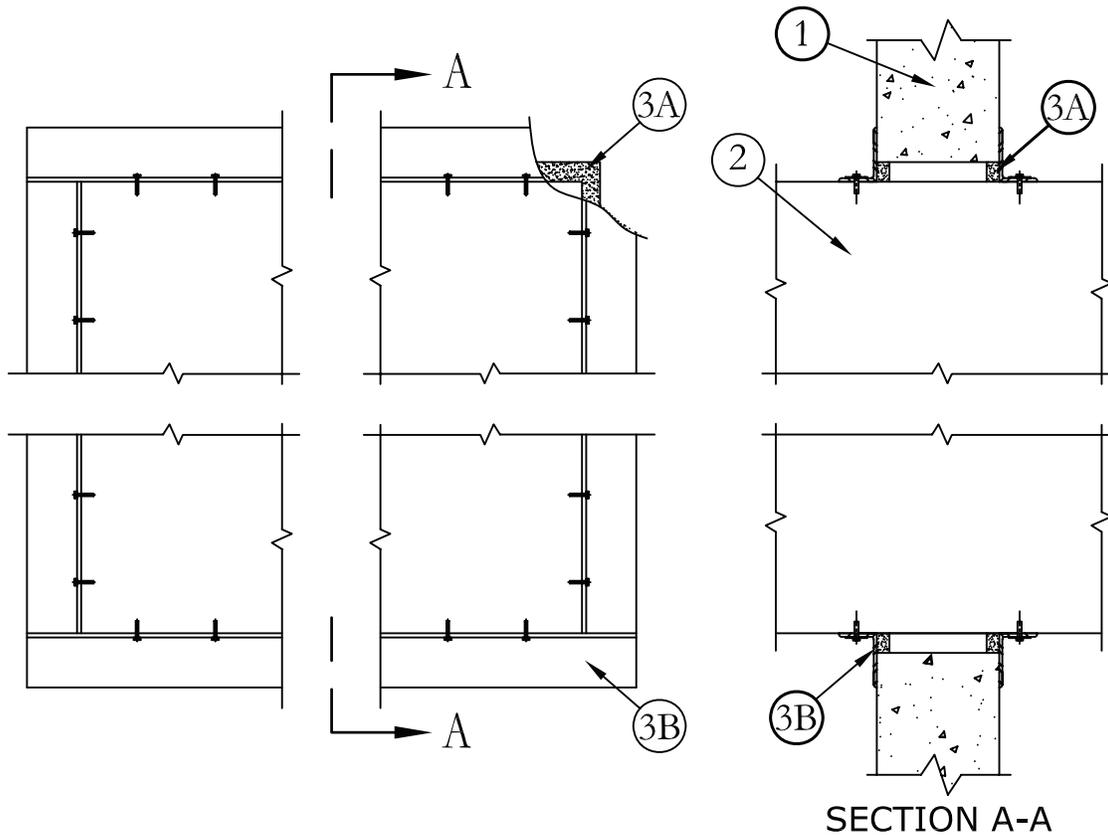

SECTION A-A

1. **Wall Assembly** – Min 4-3/4 in. (121 mm) thick reinforced lightweight or normal weight (100-150 pcf or 1600-2400 kg/m³) concrete wall. Wall may also be constructed of any UL Classified **Concrete Blocks***. Max size of opening is 9,800 sq. in. (6.32 m²) with a max dimension of 100 in. (254 cm).
See **Concrete Blocks (CAZT)** category in the Fire Resistance Directory for names of manufacturers.
2. **Steel Duct** – Nom 96 by 96 in. (2.44 by 2.44 mm) (or smaller) galv steel duct to be installed within the opening. The duct shall be constructed and reinforced in accordance with SMACNA construction standards and provided with 2 in. (51 mm) standing seams. The annular space between the duct and the periphery of opening shall be a min 1 in. (25 mm) to a max 2 in. (51 mm) with the exception that the standing seams which shall be installed at point contact to the framing of the opening. Duct to be rigidly supported on both sides of opening.
The hourly T Rating of the firestop system is 0 hr except that when the thickness of the steel duct is 18 ga, the T Rating is 3/4 hr.
3. **Firestop System** – The firestop system shall consist of the following.
 - A. **Fill, Void or Cavity Material*** – **Caulk or Sealant** – Min 5/8 in. (16 mm) thickness of caulk applied within annulus, flush with both surfaces of wall assembly.
3M COMPANY – CP 25WB+ or FB-3000 WT
 - B. **Steel Retaining Angles** – Min 16 gauge galv steel angles sized to lap duct a min of 2 in. (51 mm) and lap wall surface a min of 1 in. (25 mm) Angles attached to the duct on both sides of wall with No. 10 (or larger) steel sheet metal screws 1 in. (25 mm) from each end, and 6 in. (152 mm) OC. On the opposite side of wall, the screw pattern to be staggered.

*Bearing the UL Classification Mark

Reprinted from the Online Certifications Directory with permission from Underwriters Laboratories Inc.
Copyright © 2010 Underwriters Laboratories Inc.®



System No. W-J-7050

May 19, 2005

F Rating – 2 Hr

T Rating – 0 Hr

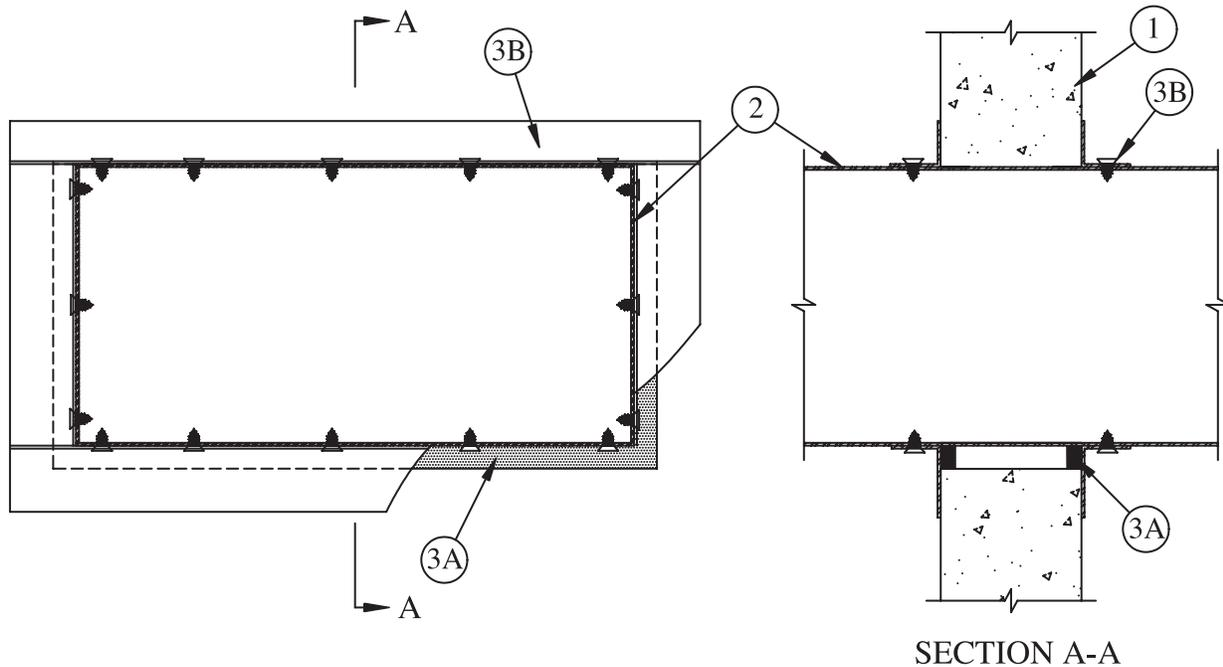

- Wall Assembly** – Min 6 in. (152 mm) thick reinforced lightweight or normal weight (100-150 pcf or 1600-2400 kg/m³) concrete wall. Wall may also be constructed of any UL Classified **Concrete Blocks***. Max size of opening to be 640 sq in. (4129 cm²) with a max dimension of 32 in. (813 mm).
See **Concrete Blocks** (CAZT) category in the Fire Resistance Directory for names of manufacturers.
- Steel Duct** – Nom 30 in. by 18 in. (762 mm by 457 mm) (or smaller) No. 24 gauge (or heavier) galv steel duct installed concentrically or eccentrically within opening. Annular space between duct and periphery of opening to be min 0 in. (point contact) to max 2 in. (0 mm to max 51 mm). Duct to be rigidly supported on both sides of wall assembly.
- Firestop System** – The firestop system shall consist of the following:
 - Fill, Void or Cavity Material* – Caulk or Sealant** – Min 5/8 in. (16 mm) thickness of caulk applied within annulus, flush with both surfaces of wall.
3M COMPANY – CP 25WB+, IC 15WB+ caulk or FB-3000 WT sealant
 - Retaining Angles** – Min 16 gauge galv steel angles sized to lap duct a min of 2 in. (51 mm) and lap wall surfaces a min of 1 in. (25 mm). Angles attached to duct on both sides of wall with min 1/2 in. (13 mm) long, No. 10 (or larger) sheet metal screws spaced a max 1 in. (25 mm) from each end and spaced a max 6 in. (152 mm) OC.

*Bearing the UL Classification Marking

Reprinted from the Online Certifications Directory with permission from Underwriters Laboratories Inc.
Copyright © 2010 Underwriters Laboratories Inc.®



Through Penetrations

Misc. Mechanical

7000 Series

Concrete

WJ

System No. W-J-7057

May 19, 2005
 F Rating – 2 Hr
 T Rating – 1/4 Hr

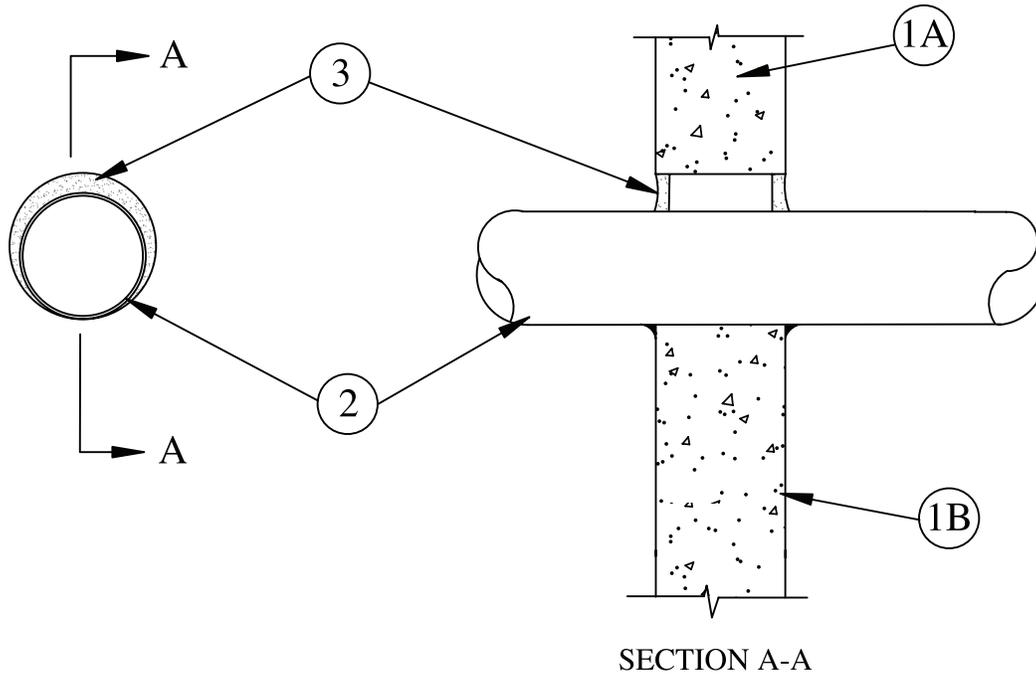

- Wall Assembly** – Min 6 in. (152 mm) thick reinforced lightweight or normal weight (100-150 pcf or 1600-2400 kg/m³) concrete wall. Wall may also be constructed of any UL Classified **Concrete Blocks***. Max diam of opening is 6-1/2 in. (165 mm). See **Concrete Blocks** (CAZT) category in the Fire Resistance Directory for names of manufacturers.
- Steel Duct** – Nom 5 in. (127 mm) diam (or smaller) No. 30 gauge (or heavier) galv steel duct installed concentrically or eccentrically within opening. Annular space between duct and periphery of opening to be min 0 in. (point contact) to max 1-1/2 in. (0 mm to max 38 mm). Duct to be rigidly supported on both sides of wall assembly.
- Fill, Void or Cavity Material*** – **Caulk or Sealant** – Min 5/8 in. (16 mm) thickness of caulk applied within annulus, flush with both surfaces of wall. An additional min 1/4 in. (6 mm) diam bead of caulk applied to the duct/wall interface at the point contact locations on both sides of wall.

3M COMPANY – CP 25WB+, IC 15WB+ caulk or FB-3000 WT sealant

*Bearing the UL Classification Marking

Reprinted from the Online Certifications Directory with permission from Underwriters Laboratories Inc.
 Copyright © 2010 Underwriters Laboratories Inc.®



System No. W-J-7095

April 19, 2007

F Rating – 2 Hr

T Rating – 0 Hr

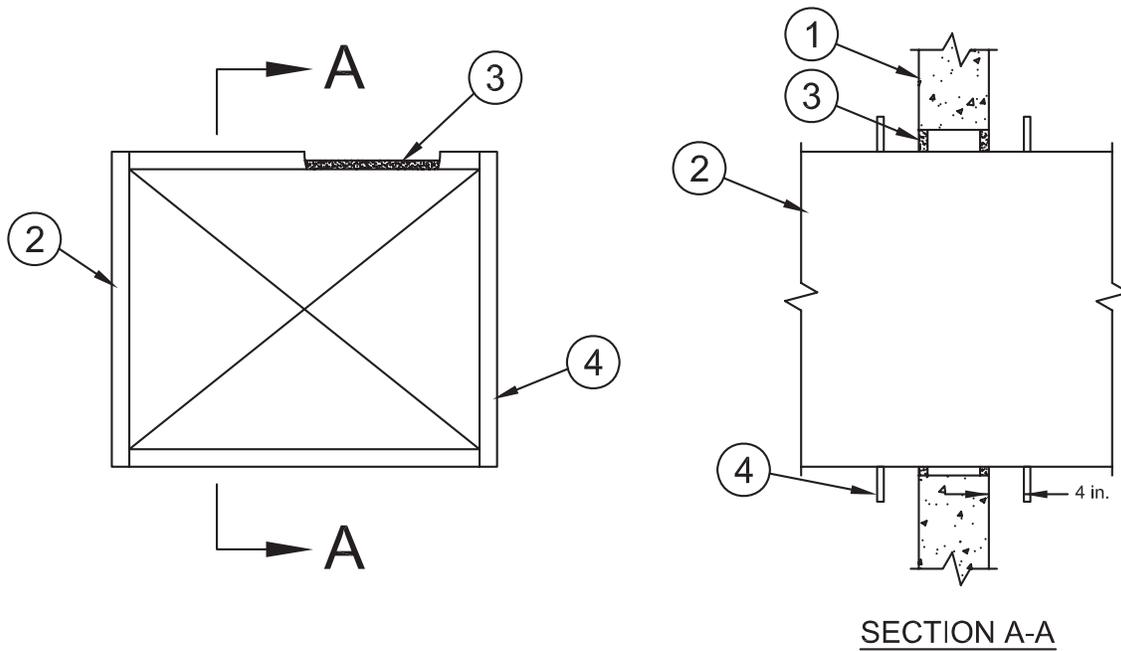

1. **Wall Assembly** – Min 6 in. (152 mm) thick reinforced lightweight or normal weight (100-150 pcf or 1600 - 2400 kg/m³) concrete wall. Wall may also be constructed of any UL Classified **Concrete Blocks***. Max size of opening is 1,617 in² (1.04 m²) with a max dimension of opening 42 in. (1.06 m).
See **Concrete Blocks** (CAZT) category in the Fire Resistance Directory for names of manufacturers.
2. **Steel Duct** – Max 36 by 40 in. (914 by 1016 mm) by min 0.030 in. (0.76 mm) thick steel duct to be installed either concentrically or eccentrically within the opening. The annular space shall be min 1/2 in. (13 mm) to max 2 in. (51 mm). Duct to be rigidly supported on both sides of wall assembly.
3. **Fill, Void or Cavity Material* – Caulk or Sealant** – Min 5/8 in. (16 mm) thickness of fill material applied within the annulus, flush with both surfaces of the wall.
3M COMPANY – IC 15WB+, CP 25WB+, FB-3000 WT
4. **Steel Reinforcement Angles** – Min 2 by 2 by 0.070 in. (51 by 51 by 1.78 mm) steel angles attached to all four sides of duct on both sides of wall 4 in. (102 mm) away from the surface of the wall. The angles shall be attached to the duct with min 1/8 in. (3 mm) diam steel rivets or No. 8 (or larger) sheet metal screws spaced max 1 in. (25 mm) from each end of duct and spaced a max of 3 in. (76 mm) OC.

*Bearing the UL Classification Mark

Reprinted from the Online Certifications Directory with permission from Underwriters Laboratories Inc.
Copyright © 2010 Underwriters Laboratories Inc.®



System No. W-J-7104

July 24, 2009
 F Rating – 2 Hr
 T Rating – 2 Hr

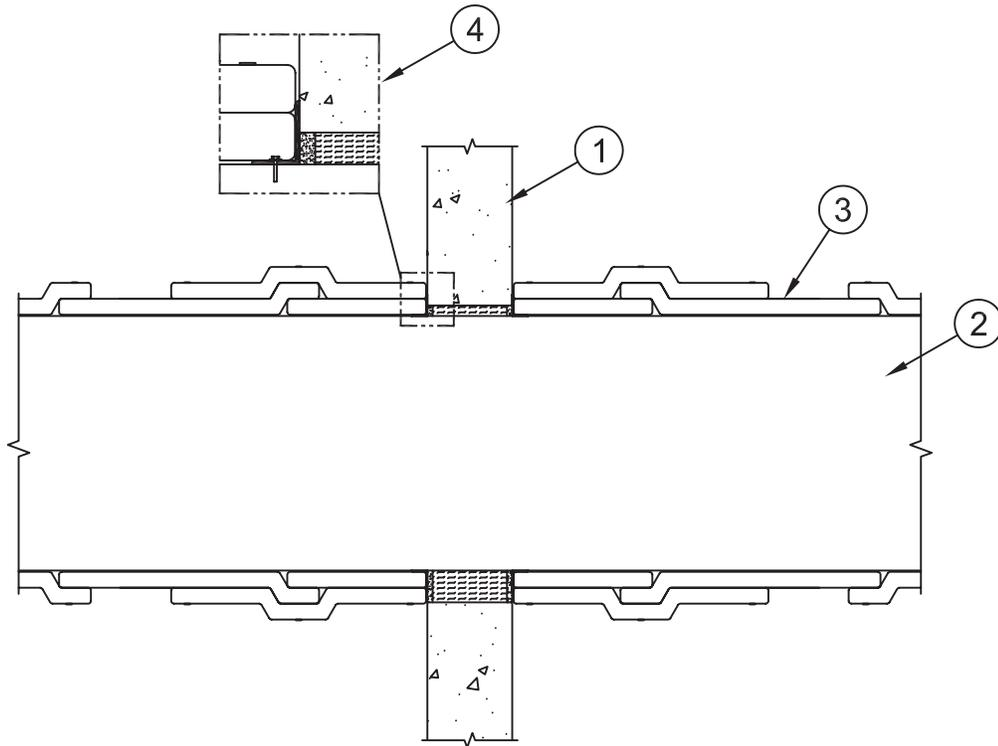

1. **Wall Assembly** – Min 6 in. (152 mm) thick reinforced lightweight or normal weight (100-150 pcf or 1600-2400 kg/m³) concrete. Wall may also be constructed of any UL Classified **Concrete Blocks***. Max size of opening is 17.3 sq ft (1.61 m²) with a max width of 89 in. (2.26 m). See **Concrete Blocks** (CAZT) category in Fire Resistance Directory for names of manufacturers.
2. **Steel Air Duct** – Max 85 by 24 in. (2160 by 610 mm) by 0.030 in. (0.76 mm) thick (22 GA) galvanized steel duct to be installed either concentrically or eccentrically within the opening. The annular space shall be min 1 in. (25 mm) to max 3 in. (76 mm) within the framed opening. The duct shall be constructed and reinforced in accordance with SMACNA HVAC Duct Construction Standards - Metal and Flexible. Steel duct to be rigidly supported on both sides of wall assembly.
3. **Duct Wrap Materials*** – Nom 1-1/2 in. (38 mm) thick ceramic fiber batt or blanket (min 6 pcf or 96 kg/m³) jacketed on the outside with a foil-scrim-poly facing, installed in a telescope, checkerboard or butt-joint-and-collar pattern with 3 in. (76 mm) transverse and longitudinal overlaps, in accordance with the requirements of Ventilation Assembly No. V-27. See Ventilation Duct Assemblies in Vol. 2 of the UL Fire Resistance Directory. Longitudinal and transverse joints sealed with aluminum foil tape.

3M COMPANY

3M FIRE PROTECTION PRODUCTS – 3M FireBarrier Duct Wrap 615 or 3M FireBarrier Duct Wrap 615+

4. **Firestop System** – The firestop system shall consist of the following:

- A. **Packing Material** – Min 4-3/4 (121 mm) thickness of min 6 pcf (96 kg/m³) duct insulation firmly packed into opening as a permanent form. Packing material to be recessed from both surfaces of wall as required to accommodate the required thickness of fill material.

3M COMPANY

3M FIRE PROTECTION PRODUCTS – 3M FireBarrier Duct Wrap 615 or 3M FireBarrier Duct Wrap 615+

- B. **Fill Void or Cavity Material*** – **Sealant** – Min 5/8 in. (16 mm) thickness of fill material applied within annulus, flush with both surfaces of wall.

3M COMPANY

3M FIRE PROTECTION PRODUCTS – 3M FB-1000 NS

- C. **Steel Retaining Angles** – Stiffening angle 1-1/2 by 2 by 1/8 in. (38 by 52 by 3.2 mm), applied around the perimeter of the duct with the 2 in. (52 mm) leg against the sealant (Item 4B above). Angles attached to steel duct on both sides of wall with min No. 10 steel sheet metal screws spaced a max of 1 in. (25 mm) from each end of steel duct and spaced a max of 6 in. (152 mm) OC.

*Bearing the UL Classification Mark

Reprinted from the Online Certifications Directory with permission from Underwriters Laboratories Inc.
 Copyright © 2010 Underwriters Laboratories Inc.®



System No. W-J-7111

February 10, 2009

F Rating – 2 Hr

T Rating – 0 Hr

L Rating At Ambient – Less Than 1 CFM/sq ft

L Rating At 400 F – Less Than 1 CFM/sq ft

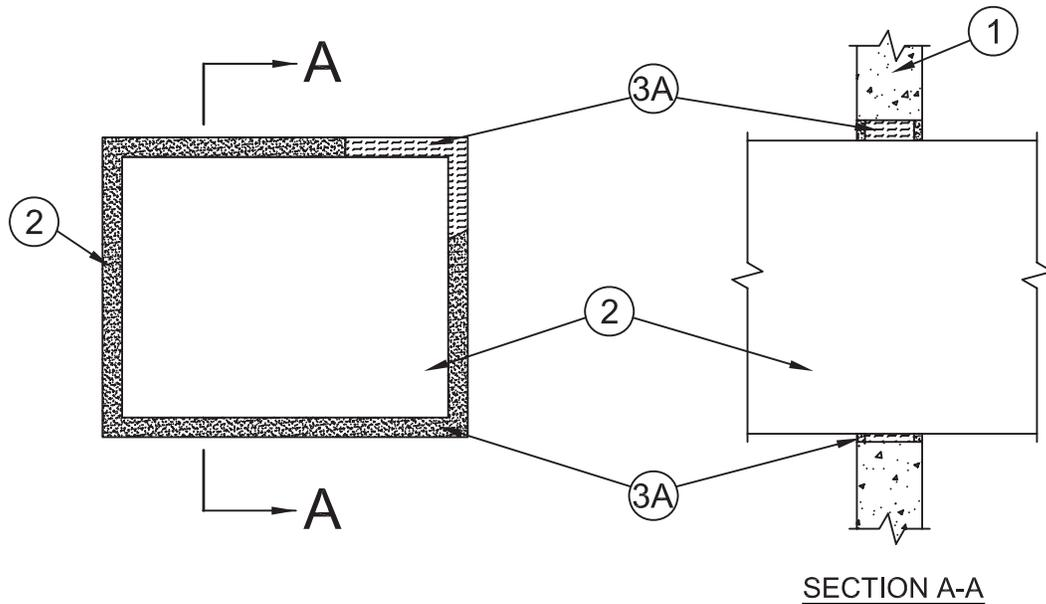

1. **Wall Assembly** – Min 8 in. (203 mm) thick reinforced lightweight or normal weight (100-150 pcf or 1600-2400 kg/m³) concrete. Wall may also be constructed of any UL Classified **Concrete Blocks***. Max size of opening is 576 sq in. (0.37 m²) with a max dimension of 24 in. (610 mm).

See **Concrete Blocks (CAZT)** category in the Fire Resistance Directory for names of manufacturers

2. **Steel Duct** – Nom 24 by 24 in. (610 by 610 mm) (or smaller) No. 22 gauge (or heavier) steel duct to be installed either concentrically or eccentrically within the opening. The annular space shall be min 3/4 in. (19 mm) to max 1-1/2 in (38 mm). Duct to be rigidly supported on both sides of wall assembly.
3. **Firestop System** – The firestop system shall consist of the following:
 - A. **Packing Material** – Min 6 in. (152 mm) thickness of min 4 pcf (64 kg/m³) mineral wool batt insulation firmly packed into opening as a permanent form, flush with both surfaces of wall.
 - A1. **Forming Material*** – As an alternate to the packing material in Item 3A, nom 4 in. (102 mm) wide strips of min 1/2 in (13 mm) thick compressible mat to be stacked to a thickness greater than the width of the annular space and compression-fitted, edge-first, to fill the annular space to a min 6 in. (152 mm) depth. Forming material to be recessed from both surfaces of wall as necessary to accommodate the required thickness of caulk fill material.

3M COMPANY

3M FIRE PROTECTION PRODUCTS – Fire Barrier Packing Material

- B. **Fill Void or Cavity Material*** – **Caulk** – Min 5/8 in. (16 mm) thickness of fill material applied within annular space, flush with both sides of wall.

3M COMPANY

3M FIRE PROTECTION PRODUCTS – FB-3000 WT, IC 15WB+ or CP 25WB+

*Bearing the UL Classification Mark

Reprinted from the Online Certifications Directory with permission from Underwriters Laboratories Inc.

Copyright © 2010 Underwriters Laboratories Inc.®



System No. W-J-7114

June 16, 2010
 F Rating – 2 Hr
 T Rating – 0 Hr

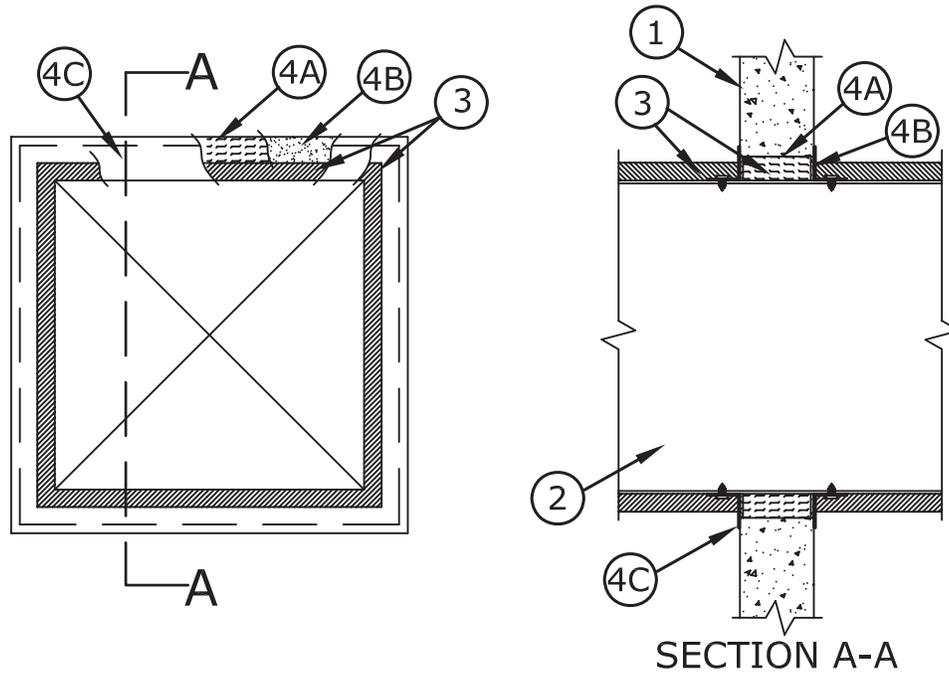

- Wall Assembly** – Min 6 in. (152 mm) thick reinforced lightweight or normal weight 100-150 pcf (1600-2400 kg/m³) concrete. Wall may also be constructed of any UL Classified **Concrete Blocks***. Max area of opening is 77.3 sq ft. (7.2 m²) with a max width of 105-1/2 in. (2.7 m). See **Concrete Blocks** (CAZT) category in the Fire Resistance Directory for names of manufacturers.
- Steel Duct** – Max 100 by 100 in. (2.5 by 2.5 m) steel duct to be installed within the framed opening. The duct shall be constructed and reinforced in accordance with SMACNA construction standards. Steel duct to be rigidly supported on both sides of wall assembly.
- Batts and Blankets*** – Nom 1-1/2 or 2 in. (38 or 51 mm) thick glass fiber batt or blanket (min 3/4 pcf or 12 kg/m³) jacketed on the outside with a foil-scrim-kraft facing. Longitudinal and transverse joints sealed with aluminum foil tape. During the installation of the fill material, the batt or blanket shall be compressed minimum 50% such that the annular space within the firestop system shall be min 1/2 in. (13 mm) to max 2 in. (51 mm).

See **Batts and Blankets** (BKNV) category in the Building Materials Directory for names of manufacturers. Any batt or blanket meeting the above specifications and bearing the UL Classification Marking with a Flame Spread Index of 25 or less and a Smoke Developed Index 50 or less may be used.

- Firestop System** – The firestop system shall consist of the following:
 - Packing Material** – Min 4-3/4 in. (121 mm) thickness of min 4 pcf (64 kg/m³) mineral wool batt insulation firmly packed into opening as a permanent form. Packing material to be recessed from both surfaces of wall to accommodate the required thickness of fill material.
 - Fill, Void or Cavity Material* – Sealant** – Min 5/8 in. (16 mm) thickness of fill material applied within annulus, flush with both surfaces of wall.

3M COMPANY

3M FIRE PROTECTION PRODUCTS – IC 15WB+, CP 25WB+, FB-3000 WT

- Steel Retaining Angles** – Min No. 16 gauge (0.059 in. or 1.5 mm) galv steel angles sized to lap steel duct a min of 1 in. (25 mm) and lap wall surfaces a min of 2 in. (51 mm). Angles attached to steel duct on both sides of wall with min No. 10 steel sheet metal screws spaced a max of 1 in. (25 mm) from each end of steel duct and spaced a max of 6 in. (152 mm) OC.

*Bearing the UL Classification Mark

Reprinted from the Online Certifications Directory with permission from Underwriters Laboratories Inc.
 Copyright © 2010 Underwriters Laboratories Inc.®



System No. W-J-7115

July 12, 2010

F Rating – 2 Hr

T Rating – 0 Hr

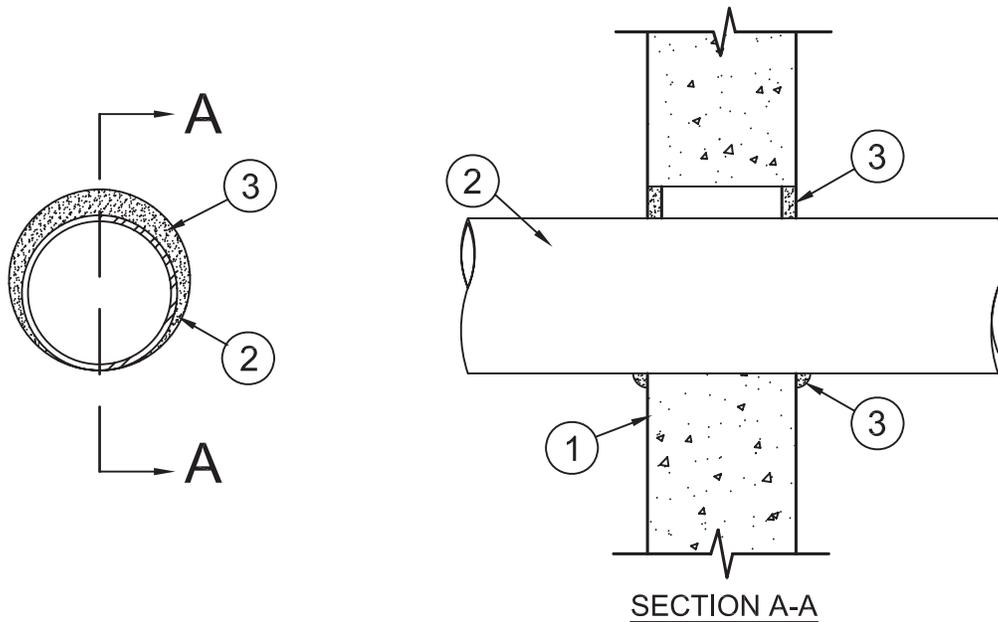

1. **Wall Assembly** – Min 6 in. (152 mm) thick reinforced lightweight or normal weight (100-150 pcf or 1600-2400 kg/m³) concrete. Wall may also be constructed of any UL Classified **Concrete Blocks***. Max diam of opening is 14 in. (356 mm).
See **Concrete Blocks** (CAZT) category in the Fire Resistance Directory for names of manufacturers.
2. **Steel Duct** – Nom 12 in. (305 mm) diam (or smaller) No. 26 gauge (or heavier) spiral wound or long seam galv steel duct. The duct shall be constructed and reinforced in accordance with SMACNA construction standards. Annular space between duct and periphery of opening to be min 0 in. (point contact) to max 2 in. (51 mm). Duct to be rigidly supported on both sides of the wall assembly.
3. **Fill, Void or Cavity Material* – Sealant** – Min 5/8 in. (16 mm) thickness of fill material applied within annulus, flush with both surfaces of wall assembly. At point contact location, min 1/4 in. (6 mm) diam bead of fill material applied at steel duct/concrete interface on both surfaces of wall.

3M COMPANY

3M FIRE PROTECTION PRODUCTS – IC 15WB+, CP 25WB+ or FB-3000 WT sealant

*Bearing the UL Classification Mark

Reprinted from the Online Certifications Directory with permission from Underwriters Laboratories Inc.
Copyright © 2010 Underwriters Laboratories Inc.®



Through Penetrations

Misc. Mechanical

7000 Series

Concrete

WJ

System No. W-J-7129

November 10, 2014

ANSI/UL1479 (ASTM E814)
 F Rating — 2 Hr
 T Rating — 1/4 Hr
 L Rating At Ambient — Less Than 1 CFM/sq ft
 L Rating At 400 F — Less Than 1 CFM/sq ft

CAN/ULC S115
 F Rating — 2 Hr
 FT Rating — 1/4 Hr
 FH Rating — 2 Hr
 FTH Rating — 1/4 Hr
 L Rating At Ambient — Less Than 1 CFM/sq ft
 L Rating At 400 F — Less Than 1 CFM/sq ft

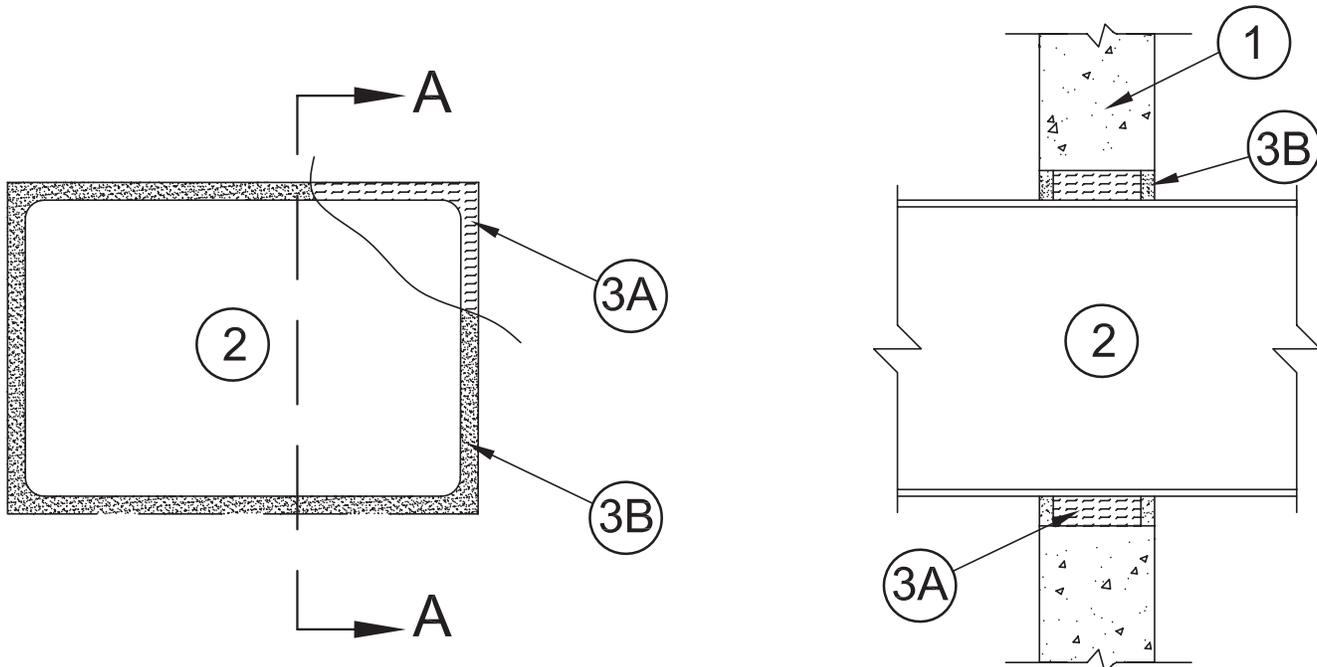

SECTION A-A

1. **Wall Assembly** — Min 6 in. (152 mm) thick reinforced lightweight or normal weight (100-150 pcf or 1600-2400 kg/m³) concrete. Wall may also be constructed of any UL Classified **Concrete Blocks***. Max area of opening is 676 in² (4362 cm²) with a max dimension of 26 in. (660 mm).
 See **Concrete Blocks (CAZT)** category in the Fire Resistance Directory for names of manufacturers
2. **Steel Duct** — Max 24 by 24 in. (610 by 610 mm) No. 26 gauge (or heavier) steel duct to be installed either concentrically or eccentrically within the opening. The annular space shall be min 1/2 in. (19 mm) to max 1-1/2 in (38 mm). Duct to be rigidly supported on both sides of wall assembly.
3. **Firestop System** — The firestop system shall consist of the following:
 - A. **Packing Material** — Min 5 in. (127 mm) thickness of min 4 pcf (64 kg/m³) mineral wool batt insulation to be firmly packed into opening as a permanent form and recessed from both surfaces of wall to accommodate the required thickness of fill material.
 - A1. **Forming Material*** — As an alternate to the packing material in Item 3A, nom 4 in. (102 mm) wide strips of min 1/2 in (13 mm) thick compressible mat to be stacked to a thickness greater than the width of the annular space and compression-fitted, edge-first, to fill the annular space to a min 5 in. (127 mm) depth. Forming material to be recessed from both surfaces of wall as necessary to accommodate the required thickness of fill material.
 - B. **Fill Void or Cavity Material*** — **Caulk** — Min 5/8 in. (16 mm) thickness of fill material applied within annular space, flush with both sides of wall.

3M COMPANY 3M FIRE PROTECTION PRODUCTS — Fire Barrier Packing Material

3M COMPANY 3M FIRE PROTECTION PRODUCTS — FB-3000 WT, IC 15WB+ or CP 25WB+

* Indicates such products shall bear the UL or cUL Certification Mark for jurisdictions employing the UL or cUL Certification (such as Canada), respectively.

Reprinted from the Online Certifications Directory with permission from UL
 © 2014 UL LLC



Through Penetrations

Misc. Mechanical

7000 Series

Concrete

WJ



UL System No. W-J-7130
XHEZ – Through-penetration Firestop Systems
XHEZ7 – Through-penetration Firestop Systems Certified for Canada

April 25, 2017

| ANSI/UL1479 (ASTM E814) | CAN/ULC S115 |
|---|---|
| F Rating – 2 Hr | F Rating – 2 Hr |
| T Rating – 1/2 Hr | T Rating – 1/2 Hr |
| L Rating At Ambient — Less Than 1 CFM/sq ft | FH Rating – 2 Hr |
| L Rating At 400 F — Less Than 1 CFM/sq ft | FTH Rating – 1/2 Hr |
| | L Rating At Ambient — Less Than 1 CFM/sq ft |
| | L Rating At 400 F — Less Than 1 CFM/sq ft |

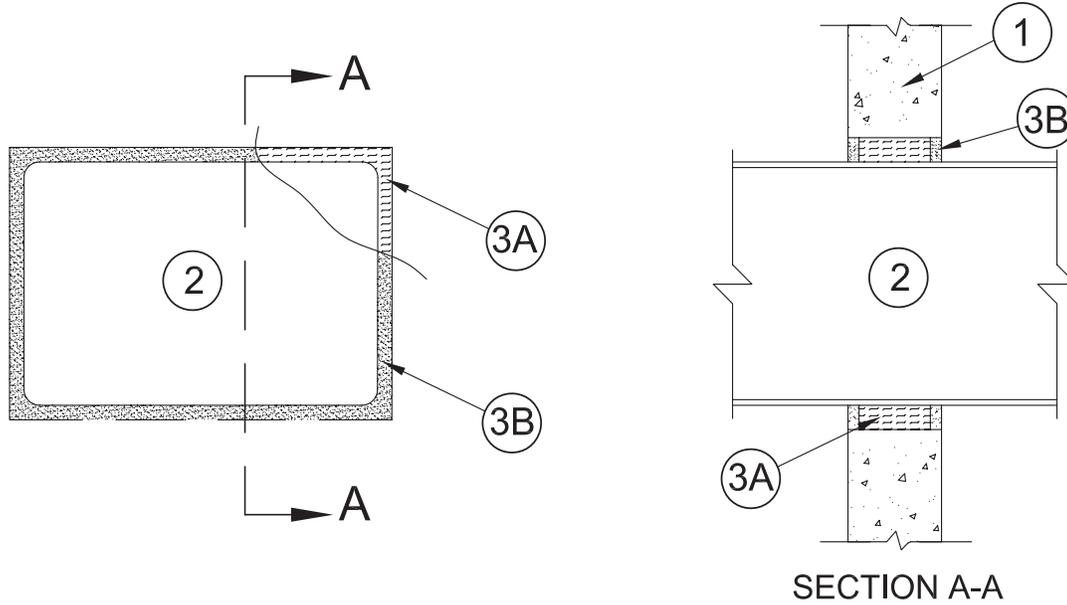

- Wall Assembly** – Min 6 in. (152 mm) thick reinforced lightweight or normal weight (100-150 pcf or 1600-2400 kg/m³) concrete. Wall may also be constructed of any UL Classified Concrete Blocks*. Max area of opening is 928 in² (5987 cm²) with a max dimension of 32 in. (813 mm). See **Concrete Blocks** (CAZT) category in the Fire Resistance Directory for names of manufacturers.
- Steel Duct** – Max 27 by 30 in. (686 by 762 mm) No. 24 gauge (or heavier) steel duct to be installed either concentrically or eccentrically within the opening. The annular space shall be min 1/2 in. (13 mm) to max 1-1/2 in (38 mm). Duct to be rigidly supported on both sides of wall assembly.
- Firestop System** – The firestop system shall consist of the following:
 - Packing Material** – Min 5 in. (127 mm) thickness of min 4 pcf (64 kg/m³) mineral wool batt insulation to be firmly packed into opening as a permanent form and recessed from both surfaces of wall to accommodate the required thickness of fill material.
 - Forming Material*** – As an alternate to the packing material in Item 3A, nom 4 in. (102 mm) wide strips of min 1/2 in (13 mm) thick compressible mat to be stacked to a thickness greater than the width of the annular space and compression-fitted, edge-first, to fill the annular space to a min 5 in. (127 mm) depth. Forming material to be recessed from both surfaces of wall as necessary to accommodate the required thickness of fill material.

3M COMPANY 3M FIRE PROTECTION PRODUCTS – Fire Barrier Packing Material

 - Fill Void or Cavity Material* – Caulk** – Min 5/8 in. (16 mm) thickness of fill material applied within annular space, flush with both sides of wall.

3M COMPANY 3M FIRE PROTECTION PRODUCTS – FB-3000 WT, IC 15WB+ or CP 25WB+

*Indicates such products shall bear the UL or cUL Certification Mark for jurisdictions employing the UL or cUL Certification (such as Canada), respectively.

Reprinted from the Online Certifications Directory with permission from UL©

Through Penetrations

Misc. Mechanical

7000 Series

WJ



System No. W-J-7131

November 10, 2014

ANSI/UL1479 (ASTM E814)
 F Rating — 2 Hr
 T Rating — 1 Hr
 L Rating At Ambient — Less Than 1 CFM/sq ft
 L Rating At 400 F — Less Than 1 CFM/sq ft

CAN/ULC S115
 F Rating — 2 Hr
 FT Rating — 1 Hr
 FH Rating — 2 Hr
 FTH Rating — 1 Hr
 L Rating At Ambient — Less Than 1 CFM/sq ft
 L Rating At 400 F — Less Than 1 CFM/sq ft

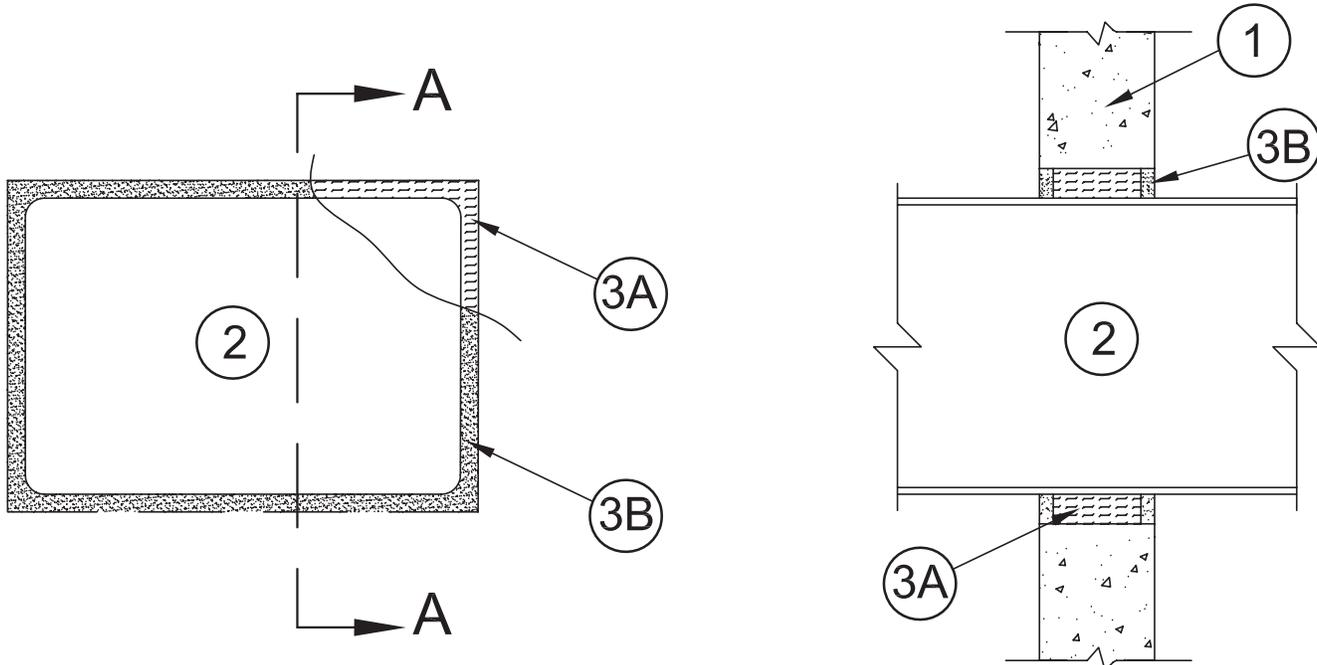

SECTION A-A

1. **Wall Assembly** — Min 6 in. (152 mm) thick reinforced lightweight or normal weight (100-150 pcf or 1600-2400 kg/m³) concrete. Wall may also be constructed of any UL Classified **Concrete Blocks***. Max area of opening is 1024 in² (6606 cm²) with a max dimension of 32 in. (813 mm).
 See **Concrete Blocks (CAZT)** category in the Fire Resistance Directory for names of manufacturers
2. **Steel Duct** — Max 30 by 30 in. (762 by 762 mm) No. 22 gauge (or heavier) steel duct to be installed either concentrically or eccentrically within the opening. The annular space shall be min 1/2 in. (19 mm) to max 1-1/2 in (38 mm). Duct to be rigidly supported on both sides of wall assembly.
3. **Firestop System** — The firestop system shall consist of the following:
 - A. **Packing Material** — Min 5 in. (127 mm) thickness of min 4 pcf (64 kg/m³) mineral wool batt insulation to be firmly packed into opening as a permanent form and recessed from both surfaces of wall to accommodate the required thickness of fill material.
 - A1. **Forming Material*** — As an alternate to the packing material in Item 3A, nom 4 in. (102 mm) wide strips of min 1/2 in (13 mm) thick compressible mat to be stacked to a thickness greater than the width of the annular space and compression-fitted, edge-first, to fill the annular space to a min 5 in. (127 mm) depth. Forming material to be recessed from both surfaces of wall as necessary to accommodate the required thickness of fill material.
 - B. **Fill Void or Cavity Material*** — **Caulk** — Min 5/8 in. (16 mm) thickness of fill material applied within annular space, flush with both sides of wall.

3M COMPANY 3M FIRE PROTECTION PRODUCTS — Fire Barrier Packing Material

3M COMPANY 3M FIRE PROTECTION PRODUCTS — FB-3000 WT, IC 15WB+ or CP 25WB+

* Indicates such products shall bear the UL or cUL Certification Mark for jurisdictions employing the UL or cUL Certification (such as Canada), respectively.

Reprinted from the Online Certifications Directory with permission from UL
 © 2014 UL LLC



Through Penetrations

Misc. Mechanical

7000 Series

Concrete

WJ

System No. W-J-7134

December 15, 2014

ANSI/UL1479 (ASTM E814)
 F Rating — 2 Hr
 T Rating — 1/4 Hr
 L Rating At Ambient — Less Than 1 CFM/sq ft
 L Rating At 400 F — Less Than 1 CFM/sq ft

CAN/ULC S115
 F Rating — 2 Hr
 FT Rating — 1/4 Hr
 FH Rating — 2 Hr
 FTH Rating — 1/4 Hr
 L Rating At Ambient — Less Than 1 CFM/sq ft
 L Rating At 400 F — Less Than 1 CFM/sq ft

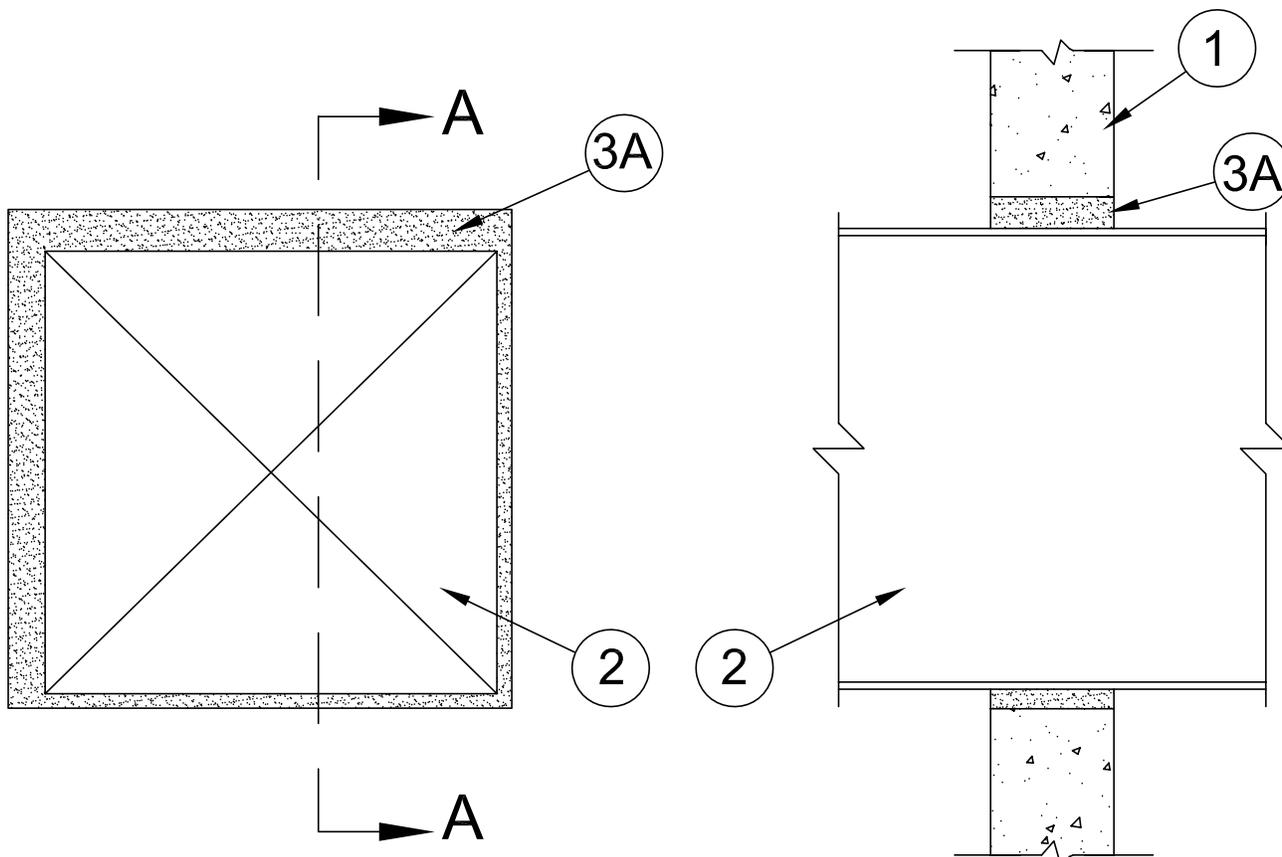

- Wall Assembly** — Min 6 in. (152 mm) thick reinforced lightweight or normal weight (100-150 pcf or 1600-2400 kg/m³) concrete. Wall may also be constructed of any UL Classified **Concrete Blocks***. Max area of opening is 1024 in² (6606 cm²) with a max dimension of 32 in. (813 mm).

See **Concrete Blocks (CAZT)** in the Fire Resistance Directory for names of manufacturers.

- Steel Duct** — Max 30 by 30 in. (762 by 762 mm) No. 22 gauge (or heavier) steel duct to be installed either concentrically or eccentrically within the opening. The annular space shall be min 1/2 in. (19 mm) to max 1-1/2 in (38 mm). Duct to be rigidly supported on both sides of wall assembly.

- Firestop System** — The firestop system shall consist of the following:

A. **Fill, Void or Cavity Material* — Foam** — Foam to be injected into annular space to a min 6 in. (152 mm) thickness to completely fill the annular space between duct and opening to full thickness of wall, flush with both sides of wall.

3M COMPANY 3M FIRE PROTECTION PRODUCTS — Fire Barrier Rated Foam, FIP 1 - Step

* Indicates such products shall bear the UL or cUL Certification Mark for jurisdictions employing the UL or cUL Certification (such as Canada), respectively.

Reprinted from the Online Certifications Directory with permission from UL
 © 2015 UL LLC



Through Penetrations

Misc. Mechanical

7000 Series

Concrete

WJ

System No. W-J-7135

March 13, 2015

ANSI/UL1479 (ASTM E814)
 F Rating — 2 Hr
 T Rating — 1/2 Hr
 L Rating At Ambient — Less Than 1 CFM/sq ft
 L Rating At 400 F — Less Than 1 CFM/sq ft

CAN/ULC S115
 F Rating — 2 Hr
 FT Rating — 1/2 Hr
 FH Rating — 2 Hr
 FTH Rating — 1/2 Hr
 L Rating At Ambient — Less Than 1 CFM/sq ft
 L Rating At 400 F — Less Than 1 CFM/sq ft

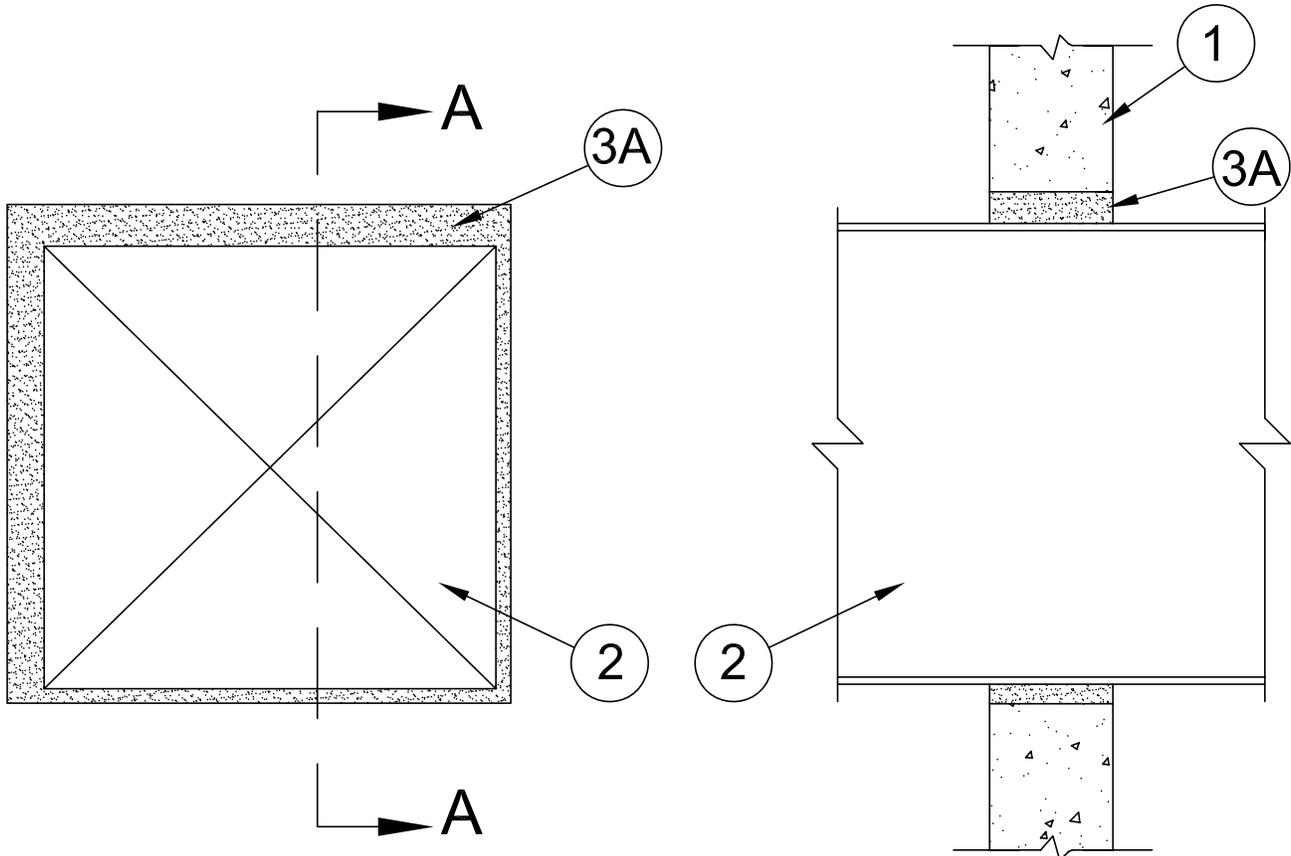

1. **Wall Assembly** — Min 6 in. (152 mm) thick reinforced lightweight or normal weight (100-150 pcf or 1600-2400 kg/m³) concrete. Wall may also be constructed of any UL Classified **Concrete Blocks***. Max area of opening is 928 in² (5987 cm²) with a max dimension of 32 in. (813 mm).
 See **Concrete Blocks (CAZT)** in the Fire Resistance Directory for names of manufacturers.
2. **Steel Duct** — Max 27 by 30 in. (686 by 762 mm) No. 24 gauge (or heavier) steel duct to be installed either concentrically or eccentrically within the opening. The annular space shall be min 1/2 in. (13 mm) to max 1-1/2 in (38 mm). Duct to be rigidly supported on both sides of wall assembly.
3. **Firestop System** — The firestop system shall consist of the following:
 - A. **Fill, Void or Cavity Material* - Foam** — Foam to be injected into annular space to a min 6 in. (152 mm) thickness to completely fill the annular space between duct and opening to full thickness of wall, flush with both sides of wall.

3M COMPANY 3M FIRE PROTECTION PRODUCTS — Fire Barrier Rated Foam, FIP 1 - Step

* Indicates such products shall bear the UL or cUL Certification Mark for jurisdictions employing the UL or cUL Certification (such as Canada), respectively.

Reprinted from the Online Certifications Directory with permission from UL
 © 2015 UL LLC



System No. W-J-7136

March 26, 2015

ANSI/UL1479 (ASTM E814)
 F Rating — 2 Hr
 T Rating — 0 Hr
 L Rating At Ambient — Less Than 1 CFM/sq ft
 L Rating At 400 F — Less Than 1 CFM/sq ft

CAN/ULC S115
 F Rating — 2 Hr
 FT Rating — 0 Hr
 FH Rating — 2 Hr
 FTH Rating — 0 Hr
 L Rating At Ambient — Less Than 1 CFM/sq ft
 L Rating At 400 F — Less Than 1 CFM/sq ft

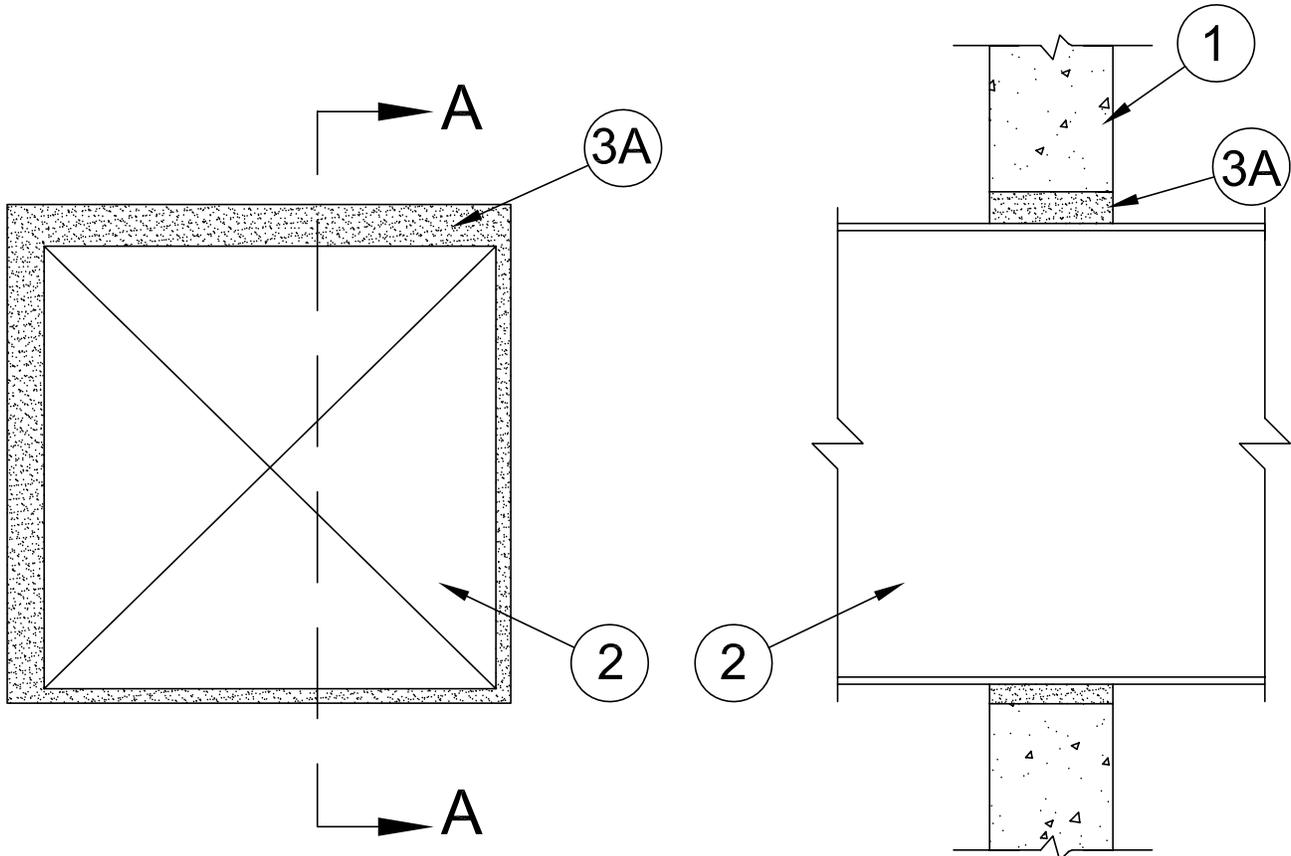

1. **Wall Assembly** — Min 6 in. (152 mm) thick reinforced lightweight or normal weight (100-150 pcf or 1600-2400 kg/m³) concrete. Wall may also be constructed of any UL Classified **Concrete Blocks***. Max area of opening is 676 in² (4361 cm²) with a max dimension of 26 in. (660 mm).
 See **Concrete Blocks (CAZT)** in the Fire Resistance Directory for names of manufacturers.
2. **Steel Duct** —Max 24 by 24 in. (610 by 610 mm) No. 26 gauge (or heavier) steel duct to be installed either concentrically or eccentrically within the opening. The annular space shall be min 1/2 in. (13 mm) to max 1-1/2 in (38 mm). Duct to be rigidly supported on both sides of wall assembly.
3. **Firestop System** — The firestop system shall consist of the following:
 - A. **Fill, Void or Cavity Material* - Foam** — Foam to be injected into annular space to a min 6 in. (152 mm) thickness to completely fill the annular space between duct and opening to full thickness of wall, flush with both sides of wall.

3M COMPANY 3M FIRE PROTECTION PRODUCTS — Fire Barrier Rated Foam, FIP 1 - Step

* Indicates such products shall bear the UL or cUL Certification Mark for jurisdictions employing the UL or cUL Certification (such as Canada), respectively.

Reprinted from the Online Certifications Directory with permission from UL
 © 2015 UL LLC



System No. W-J-7137

April 01, 2015

ANSI/UL1479 (ASTM E814)
 F Rating — 2 Hr
 T Rating — 1/4 Hr
 L Rating At Ambient — Less Than 1 CFM/sq ft
 L Rating At 400 F — Less Than 1 CFM/sq ft

CAN/ULC S115
 F Rating — 2 Hr
 FT Rating — 1/4 Hr
 FH Rating — 2 Hr
 FTH Rating — 1/4 Hr
 L Rating At Ambient — Less Than 1 CFM/sq ft
 L Rating At 400 F — Less Than 1 CFM/sq ft

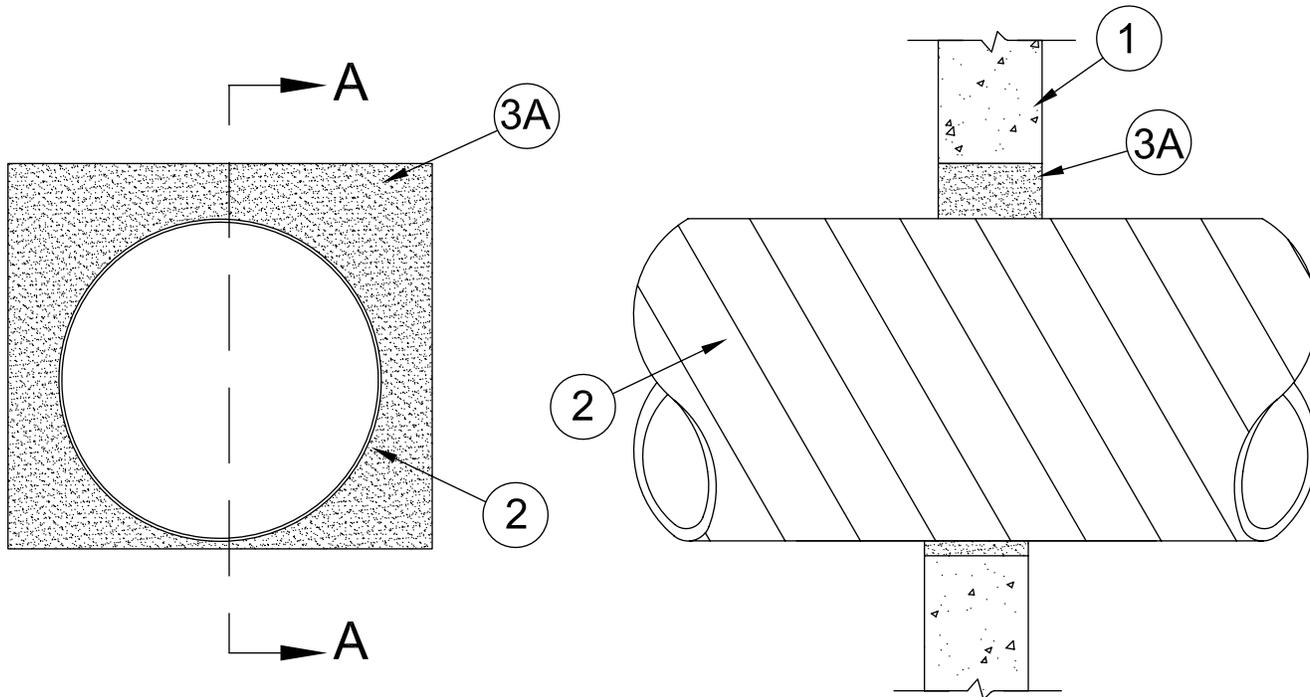

SECTION A-A

1. **Wall Assembly** — Min 6 in. (152 mm) thick reinforced lightweight or normal weight (100-150 pcf or 1600-2400 kg/m³) concrete. Wall may also be constructed of any UL Classified **Concrete Blocks***. Max area of opening is 1521 in² (0.981 m²) with a max dimension of 39 in. (991 mm).
 See **Concrete Blocks** (CAZT) category in the Fire Resistance Directory for names of manufacturers
2. **Steel Duct** — Nom 36 in. (914 mm) (or smaller) No. 22 gauge (or heavier) spiral steel duct to be installed either concentrically or eccentrically within the opening. The annular space shall be min 1/2 in. (13 mm) to max 9 1/2 in (241 mm). Duct to be rigidly supported on both sides of wall assembly.
3. **Firestop System** — The firestop system shall consist of the following:
 - A. **Fill, Void or Cavity Material***— **Foam** — Foam to be injected into annular space to a min 6 in. (152 mm) thickness to completely fill the annular space between duct and opening to full thickness of wall, flush with both sides of wall.

3M COMPANY 3M FIRE PROTECTION PRODUCTS — Fire Barrier Rated Foam, FIP 1 - Step

* Indicates such products shall bear the UL or cUL Certification Mark for jurisdictions employing the UL or cUL Certification (such as Canada), respectively.

Reprinted from the Online Certifications Directory with permission from UL
 © 2015 UL LLC



Through Penetrations

Misc. Mechanical

7000 Series

Concrete

WJ



UL System No. W-J-7167
XHEZ - Through-penetration Firestop Systems
XHEZ7 - Through-penetration Firestop Systems Certified for Canada

June 11, 2018

| ANSI/UL1479 (ASTM E814) | CAN/ULC S115 |
|-------------------------|-------------------|
| F Rating — 2 Hr | F Rating — 2 Hr |
| T Rating — 0 Hr | FT Rating — 0 Hr |
| | FH Rating — 2 Hr |
| | FTH Rating — 0 Hr |

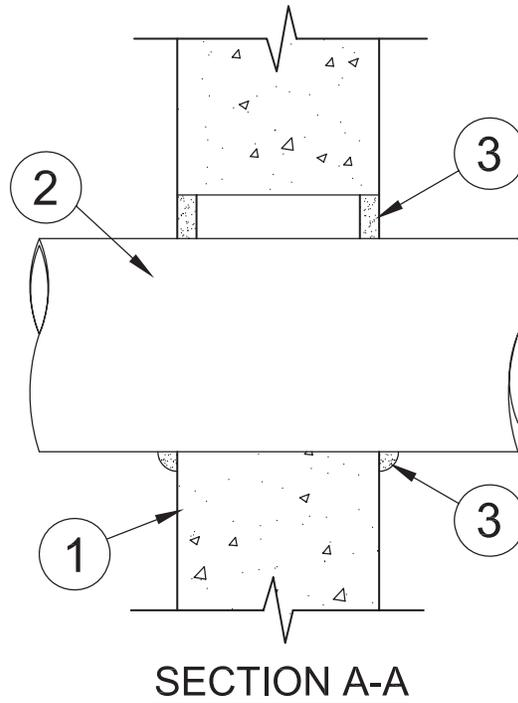
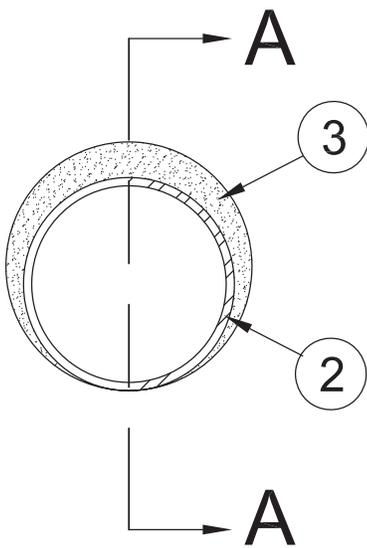

- Wall Assembly** – Min 6 in. (152 mm) thick reinforced lightweight or normal weight (100-150 pcf or 1600-2400 kg/m³) concrete. Wall may also be constructed of any UL Classified **Concrete Blocks***. Max diam of opening is 22-1/2 in. (572 mm).
See **Concrete Blocks** (CAZT) category in the Fire Resistance Directory for names of manufacturers
 - Steel Duct** – Max 20 in. (508 mm) No. 26 gauge (or heavier) spiral wound steel duct or max 12 in. (305 mm) No. 28 gauge (or heavier) steel duct to be installed either concentrically or eccentrically within the opening. The annular space shall be min 0 in. to max 2-1/2 in (64 mm). Duct to be rigidly supported on both sides of wall assembly.
 - Fill Void or Cavity Material* — Caulk** – Min 1-1/4 in. (32 mm) thickness of fill material applied within annular space, flush with both sides of wall. At point contact location, min 1/4 in. (6 mm) diam bead of caulk applied at the duct/concrete interface.
- 3M COMPANY 3M FIRE PROTECTION PRODUCTS** – FD 150+, FB-3000 WT, IC 15WB+ or CP 25WB+

*Indicates such products shall bear the UL or cUL Certification Mark for jurisdictions employing the UL or cUL Certification (such as Canada), respectively.

Reprinted from the Online Certifications Directory with permission from UL©

3M Industrial Adhesives and Tapes
Fire Protection Products
 3M Center, Building 230-B-S-37
 St. Paul, MN 55144-1000

Through Penetrations

Misc. Mechanical

7000 Series

Concrete

WJ



Misc. Mechanical • Gypsum

| 3M UL Systems | "F" Rating | 3M Product | Through Penetrant Details |
|---------------|------------|--|--|
| W-L-7008 | 1, 2 | 3M™ Fire Barrier Sealant CP 25WB+ | 36" x 30" 24 gauge steel duct. Also referred as WL7008. |
| W-L-7013 | 2 | 3M™ Fire Barrier Sealant CP 25WB+ | 16", 24 gauge steel duct 10", 28 gauge steel vent duct. Also referred as WL7013. |
| W-L-7016 | 2 | 3M™ Fire Barrier Sealant CP 25WB+ | 4", 28 gauge steel vent duct. Also referred as WL7016. |
| W-L-7032 | 1 | 3M™ Fire Barrier Sealant CP 25WB+ | 6" (or smaller) steel vent duct. Also referred as WL7032. |
| W-L-7045 | 1, 2 | 3M™ Fire Barrier Sealant CP 25WB+ 3M™ Fire Barrier Water Tight Sealant 3000 WT | Max 24 in. min. 24 ga. spiral wound steel duct. Max diam of opening 25-1/2 in. Concentric installation. 3/4 in. annular space. 1 & 2 hour F Rating. Caulk only system. Also known as WL7045. |
| W-L-7051 | 1, 2 | 3M™ Fire Barrier Sealant CP 25WB+ 3M™ Fire Barrier Sealant IC 15WB+ 3M™ Fire Barrier Wrap Ultra GS | 30" x 24" 24 gauge steel duct, duct insulation with 1-1/2" fiberglass insulation. Also referred as WL7051. |
| W-L-7052 | 1 | 3M™ Fire Barrier Sealant CP 25WB+ | 12" x 12" 24 gauge steel duct. Also referred as WL7052. |
| W-L-7056 | 2 | 3M™ Fire Barrier Sealant CP 25WB+ 3M™ Fire Barrier Sealant IC 15WB+ 3M™ Fire Barrier Moldable Putty Stix MP+ | 6" x 6" 24 gauge steel duct. Also referred as WL7056. |
| W-L-7063 | 1, 2 | 3M™ Fire Barrier Sealant CP 25WB+ 3M™ Fire Barrier Water Tight Sealant 3000 WT | Max 96 in. x 96 in. steel duct built to SMACNA guidelines. U400 or V400 series assemblies. Max opening 9800 sq. in. with max dimension of 100 in. Min 1 in. to max 2 in. annular space. Standing seams must be installed at point contact. No mineral wool required. Retaining angles required. 1 and 2 hour F ratings. Also known at WL7063. |
| W-L-7091 | 1, 2 | 3M™ Fire Barrier Sealant CP 25WB+ 3M™ Fire Barrier Sealant IC 15WB+ | 30" x 18" 24 gauge steel, maximum area opening, 640 sq. in. Also referred as WL7091. |
| W-L-7095 | 1, 2 | 3M™ Fire Barrier Sealant CP 25WB+ 3M™ Fire Barrier Sealant IC 15WB+ | Max. 5" min. 30 gauge HVAC duct. Also referred as WL7095. |
| W-L-7112 | 1, 2 | 3M™ Fire Barrier Sealant CP 25WB+ 3M™ Fire Barrier Sealant IC 15WB+ 3M™ Fire Barrier Water Tight Sealant 3000 WT | Max 12" x 6" galv. steel duct. Max area of opening 72 sq. inches with max dimension of 12". Concentric or eccentric installation. Steel sleeve. 1 & 2 Hour F Rating. Mineral wool required. Also known as WL7112. |
| W-L-7146 | 1, 2 | 3M™ Fire Barrier Sealant IC 15WB+ 3M™ Fire Barrier Water Tight Sealant 1000 NS 3M™ Fire Barrier Sealant CP 25WB+ 3M™ Fire Barrier Water Tight Sealant 3000 WT | Max 1-5/8 in. by 1-5/8 in. channel strut, 3-1/4 in. x 1-5/8 in. H strut, 3/8 in. steel cable, max 5/8 in. steel threaded rod. Max area of opening 16.5 sq. in. with max dimension of 5 in. Wood or steel studs. U300, U400, or V400 series walls. Allows angles up to 45 degrees from perpendicular. Min 1/8 in. to max 7/8 in. annular. 1 & 2 hour F, 0 hr. T. No mineral wool required. Also known as WL7146 |
| W-L-7152 | 1, 2 | 3M™ Fire Barrier Water Tight Sealant 3000 WT | Max 30 in. x 24 in. min 24 ga. steel duct. Max area of opening 1080 sq. in. with max dimension 36 in. 2 in. fiberglass insulation. Concentric installation. 1 in. annular required. Framed opening. 1 & 2 Hour F Rating. Caulk only system. Also known as WL7152. |
| W-L-7161 | 1, 2 | 3M™ Fire Barrier Sealant CP 25WB+ 3M™ Fire Barrier Water Tight Sealant 3000 WT | Max 5 in. minimum 30 gauge galvanized steel duct. Max diameter of opening 6 in. U400 or V400 series gypsum shaft wall assembly. Concentric or eccentric installation. Point contact to max 1 in. annular. 1 & 2 hour F rating. Also known at WL7161. |
| W-L-7168 | 1, 2 | 3M™ Interam™ Endothermic Mat E-5A-4 3M™ Fire Barrier Moldable Putty Stix MP+ 3M™ Fire Barrier Sealant CP 25WB+ 3M™ Fire Barrier Water Tight Sealant 3000 WT | Max 19 in. x 32 in. x 3-1/2 in. steel utility box. U400 or V400 series design with steel studs. Framed opening 1 in. wider than width of box. Opening in gypsum 1 in. wider and higher than width and height of box. 1 and 2 hour F rating. Max two 1-1/2 in. penetrants into box. Also known as WL7168. |
| W-L-7169 | 1, 2 | 3M™ Fire Barrier Sealant CP 25WB+ 3M™ Fire Barrier Water Tight Sealant 3000 WT 3M™ Fire Barrier Sealant IC 15WB+ | Max 26 in. x 40 in. steel duct. U400 or V400 Series wall. Max opening 1617 sq. in. with max dimension 42 in. Concentric or eccentric installation. Min 1/2 in. to max 2 in. annular. 2 hour F. 0 hour T. Retaining angles required. Caulk only system. Also known as WL7169. |
| W-L-7177 | 1, 2 | 3M™ Fire Barrier Water Tight Sealant 3000 WT | Max 24 in. min. 24 gauge spiral duct. Nominal 2 in. fiber glass insulation. Max diam of opening 30 in. Nominal 1 in. annular space. Concentric installation. 1 & 2 hour F Rating. No mineral wool required. Also known as WL7177. |
| W-L-7180 | 2 | 3M™ Fire Barrier Duct Wrap 615+ 3M™ Fire Barrier Water Tight Sealant 1000 NS 3M™ Fire Barrier Duct Wrap 615 | Max 85 in. x 24 in. min 22 ga. Steel duct. Max opening 17.3 sq. ft. with max width 89 in.. Duct protected with Fire Barrier Duct Wrap 615 or Fire Barrier Duct Wrap 615+. Concentric or eccentric installation. Min 1 in. to max 3 in. annular. 2 hour F & T rating. Packing material and retaining angles required. Also known as WL7180. |

Misc. Mechanical • Gypsum

| 3M UL Systems | "F" Rating | 3M Product | Through Penetrant Details |
|---------------|------------|--|--|
| W-L-7182 | 1 | 3M™ Fire Barrier Sealant CP 25WB+ | Steel dryer vent cabinet penetrating a gypsum wallboard assembly through max 10 in. x 17 in. opening. Min 4 in. galvanized steel vent duct entering box. Also known as WL7182 |
| W-L-7190 | 1, 2 | 3M™ Interam™ Endothermic Mat E-5A-4 3M™ Fire Barrier Water Tight Sealant 3000 WT 3M™ Fire Barrier Sealant CP 25WB+ 3M™ Fire Barrier Moldable Putty Stix MP+ | Max 20 in. x 48 in. min 18 gauge steel utility box. U400, V400 or W400 gypsum wallboard assembly. Framed opening 1 in. wider than width of box. Opening in gypsum 1 in. wider and 1 in. higher than box. Box penetrated by 1 max 2 in. EMT and max 12 max 1 in. diam conduits installed from top of box and 1 max 3/4 in. and 1 max 1 in. conduit from bottom of box. 1 & 2 hour F & T rating. Also known as WL7190. |
| W-L-7191 | 1, 2 | 3M™ Fire Barrier Sealant IC 15WB+ 3M™ Fire Barrier Sealant CP 25WB+ 3M™ Fire Barrier Water Tight Sealant 3000 WT 3M™ Fire Barrier Packing Material PM4 | Max 24 in. x 24 in. min 22 gauge steel duct. U400 or V400 series wall. Max area of opening 676 sq. in. with 26 in. max dimension. Min 3/4 in. to max 1-1/2 in. annular space. Concentric or eccentric installation. Framed opening. 1 & 2 hour F. No retaining angles. Mineral wool required. Also known as WL7191. |
| W-L-7195 | 1, 2 | 3M™ Fire Barrier Sealant IC 15WB+ 3M™ Fire Barrier Sealant CP 25WB+ 3M™ Fire Barrier Water Tight Sealant 3000 WT | Max 100 in. x 100 in. steel duct per SMACNA guidelines. U300, U400 or V400 Series gypsum assemblies. Max area of opening 77.3 sq. ft. with max width of 105-1/2 in. Nom 1-1/2 in. to 2 in. fiberglass insulation Insulation compressed a minimum 50% in plane of wall to create annular space. Mineral wool and sealant required. Min 16 gauge steel retaining angles required. Also known as WL7195. |
| W-L-7196 | 1, 2 | 3M™ Fire Barrier Sealant IC 15WB+ 3M™ Fire Barrier Sealant CP 25WB+ 3M™ Fire Barrier Water Tight Sealant 3000 WT | Max 12 in. min 26 gauge spiral wound or long seam steel duct. U300, U400 or V 400 Series gypsum assembly. Max diam of opening 14 in. Point contact to max 2 in. annular space. Sealant only solution-no mineral wool required. 2 hour F rating. Also known as WL7196. |
| W-L-7197 | 1, 2 | 3M™ Fire Barrier Pillows 3M™ Fire Barrier Self-Locking Pillows 3M™ Fire Barrier MP+ Moldable Putty Stix | Max. 24 in. x 30 in. steel duct penetrating a 1 or 2 hour gypsum wallboard assembly with annular space ranging from 1 in. to 4 in. Utilizing Fire Barrier Pillows. |
| W-L-7207 | 1, 2 | 3M™ Fire Barrier MP+ Moldable Putty Stix | Utility control cabinet making a membrane penetration in a gypsum wallboard assembly. |
| W-L-7216 | 1, 2 | 3M™ Interam™ Endothermic Mat E-5A-4 3M™ Fire Barrier Sealant CP 25WB+ 3M™ Fire Barrier Water Tight Sealant 3000 WT | 1 or 2 hour fire rated gypsum wallboard/stud assembly constructed to U300, U400, V400 or W400 designs. Min 18 gauge, max 11-7/8 in. wide by max 20 in. high by max 3-7/8 in. deep steel box. 1 or 2 hour F and T. Also known as WL7216 |
| W-L-7221 | 1, 2 | 3M™ Fire Barrier Sealant IC 15WB+ 3M™ Fire Barrier Sealant CP 25WB+ 3M™ Fire Barrier Water Tight Sealant 3000 WT | 1 or 2 hour fire rated gypsum wallboard/stud assembly constructed to U400 or V400 designs. Max 928 sq. in. opening with max 32 in. dimension. Max 27 by 30 in. min 24 gauge steel duct with 1/2 to 1-1/2 in. annular space. 1 or 2 hour F, 0 or 1/2 hour T. Less than 1 CFM/sq. ft. at ambient and 400°F. Also known as WL7221 |
| W-L-7222 | 1, 2 | 3M™ Fire Barrier Sealant IC 15WB+ 3M™ Fire Barrier Sealant CP 25WB+ 3M™ Fire Barrier Water Tight Sealant 3000 WT | 1 or 2 hour fire rated gypsum wallboard/stud assembly constructed to U400 or V400 designs. Max 1024 sq. in. opening with max 32 in. dimension. Max 30 by 30 in. min 22 gauge steel duct with 1/2 to 1-1/2 in. annular space. 1 or 2 hour F, 0 or 1 hour T. Less than 1 CFM/sq. ft. at ambient and 400°F. Also known as WL7222 |
| W-L-7223 | 1, 2 | 3M™ Fire Barrier Sealant FD 150+ 3M™ Fire Barrier Sealant IC 15WB+ 3M™ Fire Barrier Sealant CP 25WB+ 3M™ Fire Barrier Water Tight Sealant 3000 WT | Max. 24 in. x 24 in. steel duct penetrating a 1 or 2 hour rated gypsum wallboard assembly. Annular space ranges from 1/2 in. to 1-1/2 in. utilizing packing material and sealant. |
| W-L-7225 | 2 | 3M™ Fire Barrier Rated Foam FIP 1-Step | 2 hour fire rated gypsum wall assembly. Max 1024 sq. in. opening with max 32 in. dimension. Max 30 by 30 in. min 22 gauge steel duct with 1/2 to 1-1/2 in. annular space. 2 hour F, 1/4 hour T, less than 1 CFM/sq. ft. at ambient and 400°F. Also known as WL7225 |
| W-L-7226 | 2 | 3M™ Fire Barrier Rated Foam FIP 1-Step | 2 hour fire rated gypsum wall assembly. Max 928 sq. in. opening with max 32 in. dimension. Max 27 by 30 in. min 24 gauge steel duct with 1/2 to 1-1/2 in. annular space. 2 hour F, 1/2 hour T, less than 1 CFM/sq. ft. at ambient and 400°F. Also known as WL7226 |
| W-L-7227 | 2 | 3M™ Fire Barrier Rated Foam FIP 1-Step | 2 hour fire rated gypsum wall assembly. Max 676 sq. in. opening with max 26 in. dimension. Max 24 by 24 in. min 26 gauge steel duct with 1/2 to 1-1/2 in. annular space. 2 hour F, less than 1 CFM/sq. ft. at ambient and 400°F. Also known as WL7227 |
| W-L-7228 | 2 | 3M™ Fire Barrier Rated Foam FIP 1-Step | 2 hour fire rated gypsum wall assembly. Max 1521 sq. in. opening with max 39 in. dimension. Nom 36 in. min 22 gauge spiral steel duct with 1/2 to 9-1/2 in. annular space. 2 hour F, 1/4 hour T, less than 1 CFM/sq. ft. at ambient and 400°F. Also known as WL7228 |

Misc. Mechanical • Gypsum

| 3M UL Systems | "F" Rating | 3M Product | Through Penetrant Details |
|-----------------|------------|--|---|
| W-L-7242 | 1, 2 | 3M™ Fire Barrier Sealant CP 25WB+ 3M™ Fire Barrier Water Tight Sealant 3000 WT | Max 1 5/8 in. x 1 5/8 in. steel channel strut, Max 3 1/4 in. x 1- 5/8 in. Steel H strut, Max 2 in. x 2 in. steel angle or channel penetrating a U400, V400, or W400 gypsum or gypsum shaft wall assembly. Also known as WL7242. |
| W-L-7243 | 1, 2 | 3M™ Fire Barrier Sealant IC 15WB+ 3M™ Fire Barrier Sealant CP 25WB+ 3M™ Fire Barrier Water Tight Sealant 3000 WT | 1 5/8" x 1 5/8 in. Steel Strut, 3/8" Steel cable, 1" Threaded rod, 2" x2" x1/8" steel angle penetrating a gypsum wallboard assembly. 1/8" to 7/8 " annular space. |
| W-L-7276 | 2 | 3M™ Fire Barrier Sealant IC 15WB+ 3M™ Fire Barrier Sealant CP 25WB+ 3M™ Fire Barrier Water Tight Sealant 3000 WT 3M™ Fire Barrier Sealant FD 150+ | Max 20 in. No. 26 gauge spiral wound or max 12 in. No. 28 gauge steel duct |

System No. W-L-7008

June 15, 2005

F Rating – 1 & 2 Hr (See Item 1)

T Ratings – 0 Hr

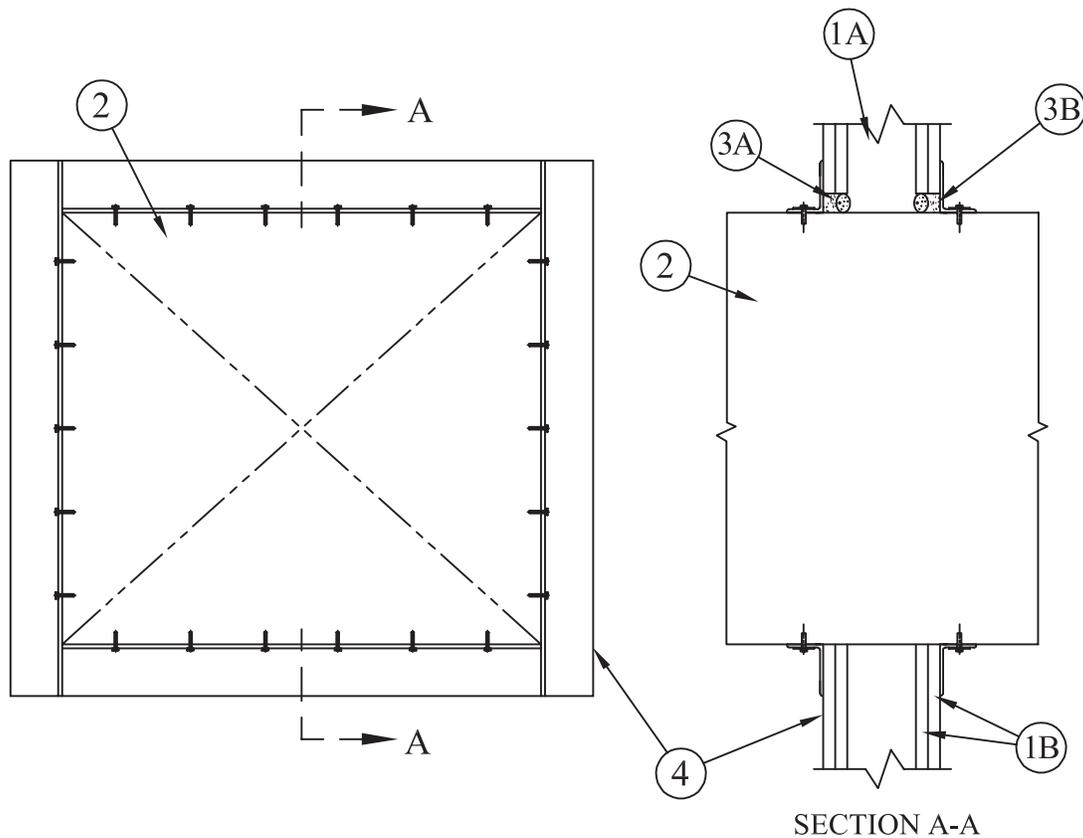

- Wall Assembly** – The 1 and 2 hr fire rated gypsum wallboard/stud wall assembly shall be constructed of the materials and in the manner specified in the individual U400 Series Wall and Partition Designs in the UL Fire Resistance Directory and shall include the following construction features:
 - Studs** – Wall framing shall consist of steel channel studs to be min 3-1/2 in. (89 mm) wide and spaced max 24 in. (610 mm) OC. Additional 3-1/2 in. (89 mm) wide steel studs shall be used to completely frame opening.
 - Gypsum Board*** – Thickness, type, number of layers and fasteners as required in the individual Wall and Partition Design. Max size of opening to be 1216 sq in. (188.5 cm²) with a max dimension of 38 in. (965 mm).

The hourly F Rating of the firestop system is equal to the hourly fire rating of the wall assembly in which it is installed.
- Through Penetrant** – Nom 36 by 30 in. (914 by 762 mm) (or smaller) No. 24 gauge (or heavier) galv steel duct to be installed either concentrically or eccentrically within the firestop system. An annular space of min 0 in. (0 mm) (point contact) to max 2 in. (51 mm) is required within the firestop system. Steel duct to be rigidly supported on both sides of floor or wall assembly.
- Firestop System** – The details of the firestop system shall be as follows:
 - Packing Material** (Optional) – Polyethylene backer rod, mineral wool batt insulation or fiberglass batt insulation friction-fit into annular space for 2 hr rated wall assemblies only. Packing material to be recessed from both surfaces of wall to accommodate the required thickness of fill material (Item 3B).
 - Fill, Void or Cavity Material* – Caulk or Sealant** – Min 5/8 in. (16 mm) thickness of fill material applied within annulus, flush with both surfaces of wall assembly. At the point contact location between duct and wallboard, a min 1/4 in. (6 mm) diam bead of sealant shall be applied at the wallboard/duct interface on both surfaces of wall assembly.

3M COMPANY – CP 25WB+ caulk or FB-3000 WT sealant
 - Retaining Angles** – Min 16 gauge galv steel angles sized to lap duct a min of 2 in. (51 mm) and lap wall surfaces of a min of 1 in. (25 mm). Angles attached to duct on both sides of wall with min 1/2 in. (13 mm) long, No. 10 (or larger) sheet metal screws spaced a max of 1 in. (25 mm) from each end of duct and spaced a max of 6 in. (152 mm) OC.

*Bearing the UL Classification Marking

Reprinted from the Online Certifications Directory with permission from Underwriters Laboratories Inc.

Copyright © 2010 Underwriters Laboratories Inc.®



System No. W-L-7013

September 07, 2004

F Rating – 2 Hr

T Rating – 0 Hr

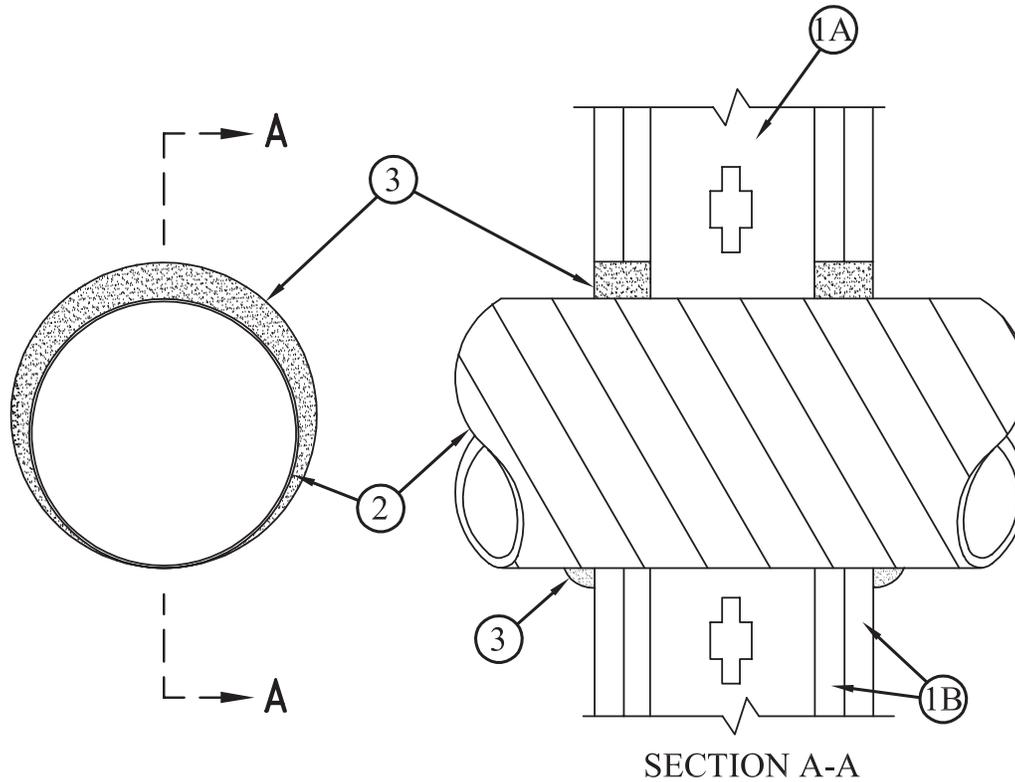

1. **Wall Assembly** – The 2 hr fire rated gypsum wallboard/stud wall assembly shall be constructed of the materials and in the manner specified in the individual U400 Series Wall and Partition Designs in the UL Fire Resistance Directory and shall include the following construction features:
 - A. **Studs** – Wall framing shall consist of steel channel studs to be min 3-1/2 in. wide and spaced max 24 in. OC.
 - B. **Gypsum Board*** – Two layers of min 5/8 in. thick gypsum wallboard, as specified in the individual Wall and Partition Design. Max diam of opening is 17-1/2 in.
2. **Through Penetrant** – One steel duct to be installed either concentrically or eccentrically within the firestop system. An annular space of min 0 in. to max 1-1/2 in. is required within the firestop system. Steel duct to be rigidly supported on both sides of wall assembly. The following sizes of steel ducts may be used.
 - A. **Steel Duct** – Nom 16 in. diam (or smaller) No. 24 gauge (or heavier) spiral wound galv steel duct.
 - B. **Steel Duct** – Nom 10 in. diam (or smaller) No. 28 gauge (or heavier) galv steel vent duct.
3. **Fill, Void or Cavity Material* – Caulk or Sealant** – Min 1-1/4 in. thickness of fill material applied within annulus, flush with both surfaces of wall assembly. At the point contact location between duct and wallboard, a min 1/4 in. diam bead of caulk shall be applied at the wallboard/duct interface on both surfaces of wall assembly.

3M COMPANY – CP 25WB+ caulk or FB-3000 WT sealant

*Bearing the UL Classification Marking

Reprinted from the Online Certifications Directory with permission from Underwriters Laboratories Inc.
Copyright © 2010 Underwriters Laboratories Inc.®



System No. W-L-7016

September 07, 2004

F Rating – 2 Hr

T Rating – 0 Hr

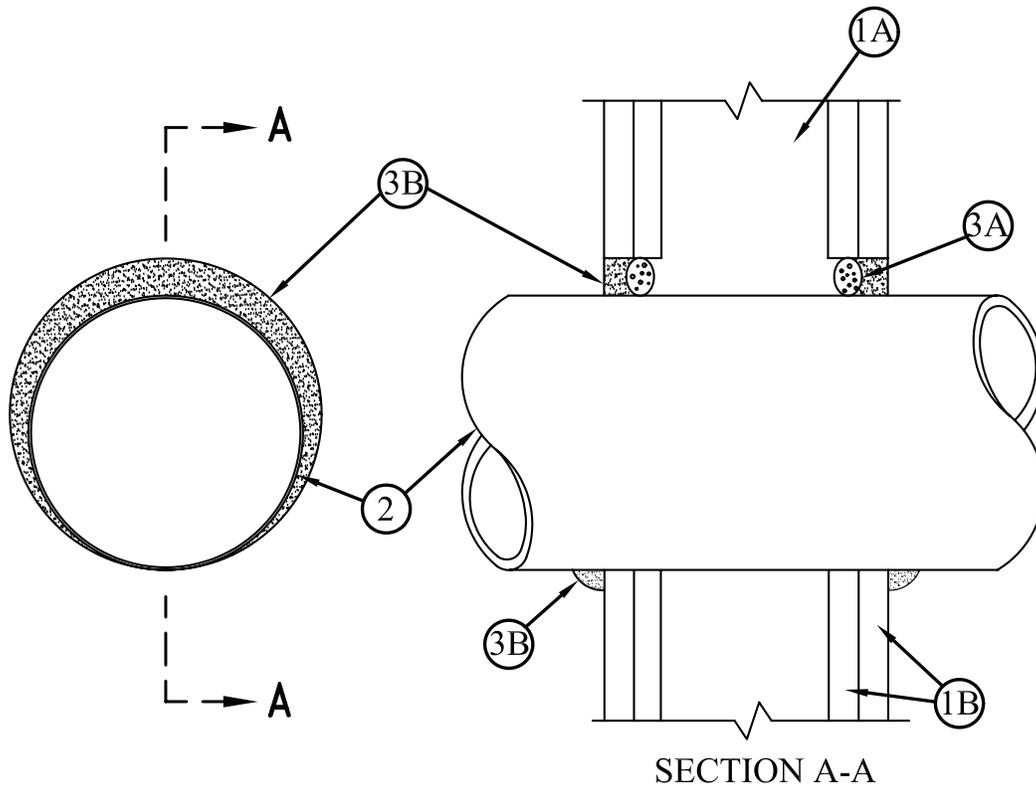

- Wall Assembly** – The 2 hr fire rated gypsum wallboard/stud wall assembly shall be constructed of the materials and in the manner specified in the individual U300 or U400 Series Wall and Partition Designs in the UL Fire Resistance Directory and shall include the following construction features:
 - Studs** – Wall framing shall consist of either wood or steel studs. Wood studs to consist of nom 2 by 4 in. lumber spaced max 16 in. OC. Steel studs to be min 3-1/2 in. wide and spaced max 24 in. OC.
 - Gypsum Board*** – Thickness, type, number of layers and fasteners as required in the individual Wall and Partition Design. Max diam of opening is 5 in.
- Steel Vent Duct** – Nom 4 in. diam (or smaller) No. 28 gauge (or heavier) galv steel duct to be installed either concentrically or eccentrically within the firestop system. An annular space of min 0 in. (point contact) to max 1 in. is required within the firestop system. Duct to be rigidly supported on both sides of wall assembly.
- Firestop System** – The details of the firestop system shall be as follows:
 - Packing Material** (Optional) – Polyethylene backer rod, mineral wool batt insulation or fiberglass batt insulation friction-fit into annular space and recessed from both surfaces of wall to accommodate the required thickness of fill material (Item 3B).
 - Fill, Void or Cavity Material* – Caulk or Sealant** – Min 1/2 in. thickness of fill material applied within annulus, flush with both surfaces of wall assembly. At the point contact location between duct and wallboard, a min 1/2 in. diam bead of sealant shall be applied at the wallboard/duct interface on both surfaces of wall assembly.
3M COMPANY – CP 25WB+ caulk or FB-3000 WT sealant

*Bearing the UL Classification Marking

Reprinted from the Online Certifications Directory with permission from Underwriters Laboratories Inc.
Copyright © 2010 Underwriters Laboratories Inc.®



System No. W-L-7032

September 07, 2004

F Rating – 1 Hr

T Rating – 0 Hr

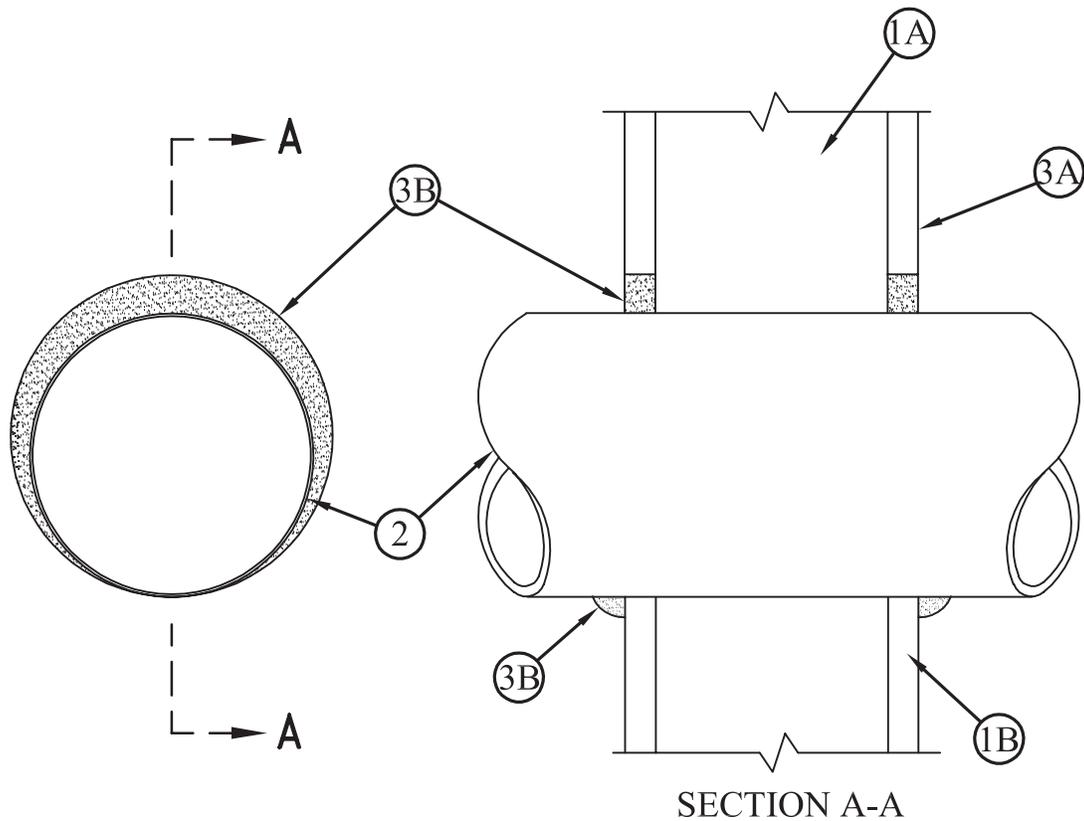

- Wall Assembly** – The 1 hr fire rated gypsum wallboard/stud wall assembly shall be constructed of the materials and in the manner specified in the individual U300 or U400 Series Wall and Partition Designs in the UL Fire Resistance Directory and shall include the following construction features:
 - Studs** – Wall framing shall consist of either wood or steel studs. Wood studs to consist of nom 2 by 4 in. lumber spaced max 16 in. OC. Steel studs to be min 3-1/2 in. wide and spaced max 24 in. OC.
 - Gypsum Board*** – One layer of min 5/8 in. thick wallboard as required in the individual Wall and Partition Design. Max diam of opening is 7 in.
- Steel Vent Duct** – Nom 6 in. diam (or smaller) No. 28 gauge (or heavier) galv steel duct to be installed either concentrically or eccentrically within the firestop system. An annular space of min 0 in. (point contact) to max 1 in. is required within the firestop system. Duct to be rigidly supported on both sides of wall assembly.
- Fill, Void or Cavity Material* – Caulk or Sealant** – Min 5/8 in. thickness of fill material applied within annulus, flush with both surfaces of wall assembly. At the point contact location between duct and wallboard, a min 1/2 in. diam bead of sealant shall be applied at the wallboard/duct interface on both surfaces of wall assembly.

3M COMPANY – CP 25WB+ caulk or FB-3000 WT sealant

*Bearing the UL Classification Marking

Reprinted from the Online Certifications Directory with permission from Underwriters Laboratories Inc.

Copyright © 2010 Underwriters Laboratories Inc.®



System No. W-L-7045

July 26, 2007

F Ratings – 1 and 2 Hr (See Item 1)

T Rating – 0 Hr

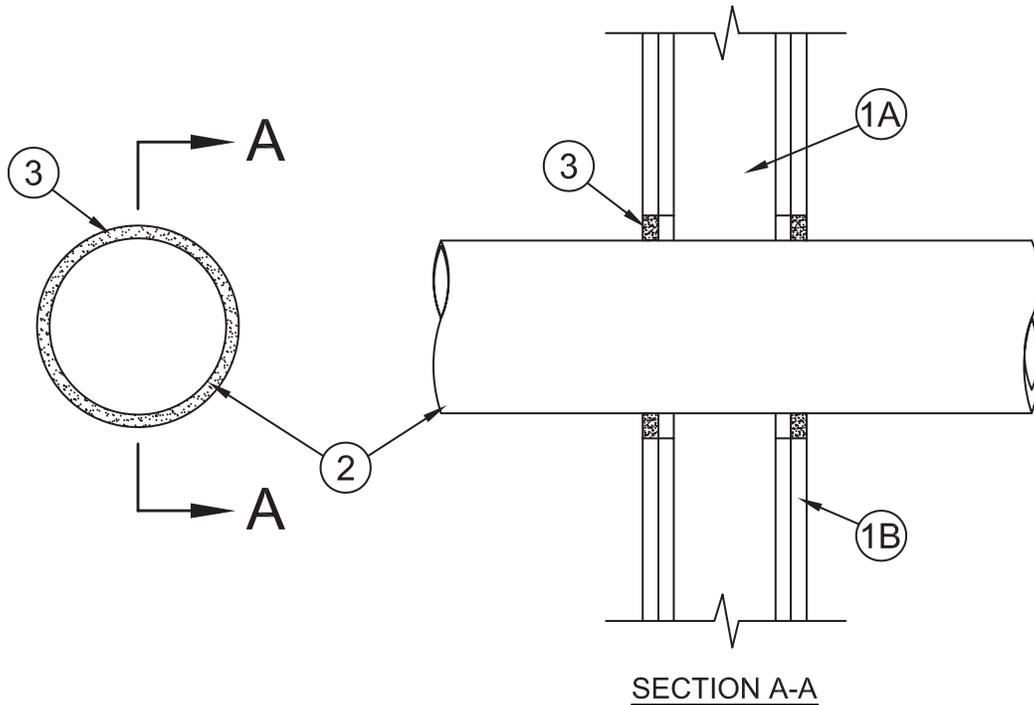

1. **Wall Assembly** – The 1 hr or 2 hr fire rated gypsum board/stud wall assembly shall be constructed of the materials and in the manner specified in the individual U400 or V400 Series Wall and Partition Designs in the UL Fire Resistance Directory and shall include the following construction features.

- A. **Studs** – Wall framing shall consist of min 3-1/2 in. (89 mm) wide steel channel studs spaced max 24 in. (610 mm) OC. When diam of opening exceeds width of stud cavity, additional lengths of steel stud installed to frame out opening around steel duct (Item 2).
- B. **Gypsum Board*** – Min 5/8 in. (16 mm) thick, 4 ft (1.22 m) wide with square or tapered edges. The gypsum board type, thickness, number of layers, fastener type and sheet orientation shall be as specified in the individual U400 or V400 Series Design in the UL Fire Resistance Directory. Max diam of opening is 25-1/2 in. (648 mm).

The hourly F Rating of the firestop system is equal to the hourly fire rating of the wall assembly in which it is installed.

- 2. **Steel Duct** – Max 24 in. (610 mm) diam No. 24 gauge (or heavier) spiral wound steel duct to be installed concentrically with a 3/4 in. (19 mm) annular space. Duct to be rigidly supported on both sides of wall assembly.
- 3. **Fill, Void or Cavity Material* – Caulk or Sealant** – Min 5/8 in. (16 mm) thickness of fill material applied within annulus, flush with both surfaces of wall assembly.

3M COMPANY – CP 25WB+ or FB-3000 WT

*Bearing the UL Classification Mark

Reprinted from the Online Certifications Directory with permission from Underwriters Laboratories Inc.

Copyright © 2010 Underwriters Laboratories Inc.®



System No. W-L-7051

October 02, 2006

F Rating – 1 and 2 Hr (See Item 1)

T Rating – 3/4 and 2 Hr (See Item 1)

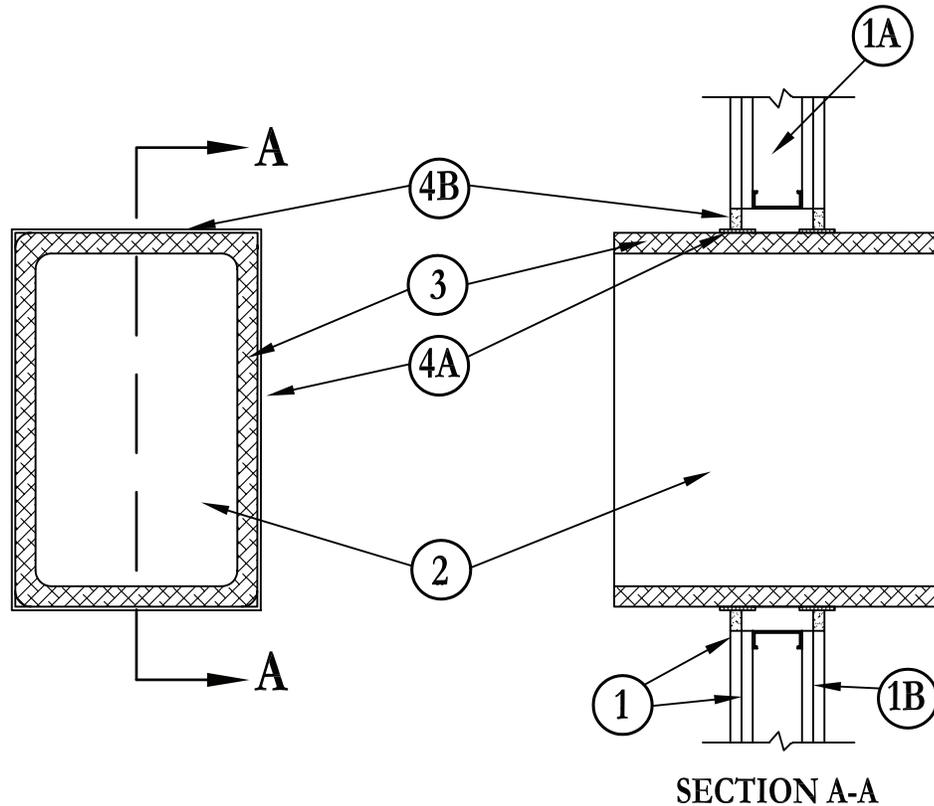

1. **Wall Assembly** – The 1 and 2 hr fire rated gypsum board/stud wall assembly shall be constructed of the materials and in the manner specified in the individual U400 or V400 Series Wall and Partition Designs in the UL Fire Resistance Directory and shall include the following construction features.
 - A. **Studs** – Wall framing shall consist of min 3-1/2 in. (89 mm) wide steel studs spaced a max 24 in. (610 mm) OC. Additional min 3-1/2 in. (89 mm) wide steel studs shall be used to completely frame the opening.
 - B. **Gypsum Board*** – Thickness, type, number of layers and fasteners as specified in the individual Wall and Partition Design. Max size of opening is 35 in. by 29 in. (889 mm by 737 mm) opening.

The hourly F Rating of the firestop system is equal to the hourly fire rating of the wall assembly in which it is installed. The hourly T Rating is 3/4 and 2 Hr for 1 and 2 Hr rated assemblies, respectively.
2. **Steel Air Duct** – Nom 30 in. by 24 in. (762 mm by 610 mm) min 24 gauge (or heavier) galv steel air duct to be installed either concentrically or eccentrically within the opening. Duct to be rigidly supported on both sides of wall assembly.
3. **Duct Insulation*** – Nom 1-1/2 in. (38 mm) thick glass fiber blanket insulation jacketed on the outside with foil-scrim-kraft facing. Longitudinal and transverse joints sealed with foil-scrim kraft tape. A nominal 1 in. (25 mm) annular space shall be maintained between the insulated duct and the periphery of the opening.

See **Batts and Blankets** (BKNV) category in the Building Materials Directory for names of manufacturers. Any batts and blankets material meeting the above specifications and bearing the UL Classification Marking with a Flame Spread Index of 25 or less and a Smoke Developed Index of 50 or less may be used.
4. **Firestop System** – The firestop system shall consist of the following:
 - A. **Wrap Strip** – One layer of nom 1/8 in. (3.2 mm) thick intumescent material supplied in 2 in. (51 mm) wide strips tightly wrapped around duct insulation and held in place with 2 in. (51 mm) wide min 3 mil foil tape. Wrap strip slid into annulus on both sides of wall such that wrap strips extend approx 1/2 in. (13 mm) beyond both surfaces of wall. Exposed portion of wrap strip to be completely covered with min 3 mil foil tape.

3M COMPANY – Ultra GS
 - B. **Fill, Void or Cavity Material* – Caulk or Sealant** – Min 5/8 in. (16 mm) thickness of fill material applied within annulus, flush with both surfaces of wall assembly.

3M COMPANY – CP 25WB+, IC 15WB+, FB-3000 WT

*Bearing the UL Classification Mark

Reprinted from the Online Certifications Directory with permission from Underwriters Laboratories Inc.
Copyright © 2010 Underwriters Laboratories Inc.®



System No. W-L-7052

May 19, 2005

F Rating – 1 Hr

T Rating – 0 Hr

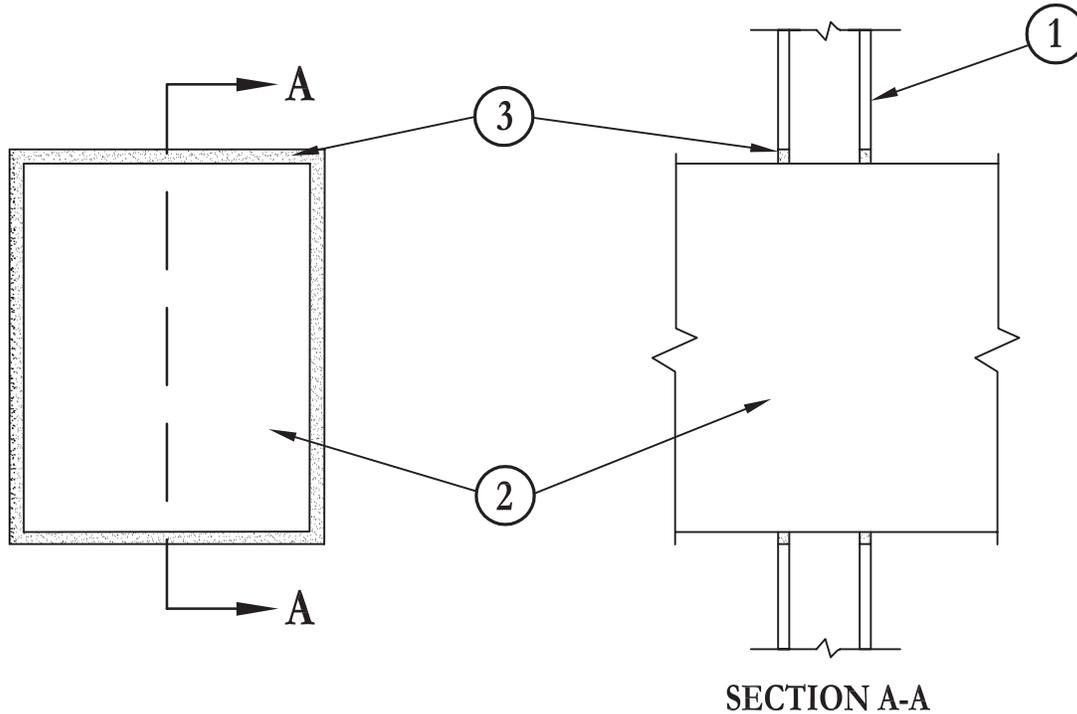

- Wall Assembly** – The 1 hr fire rated gypsum board/stud wall assembly shall be constructed of the materials and in the manner specified in the individual U300, U400 or V400 Series Wall and Partition Designs in the UL Fire Resistance Directory and shall include the following construction features.
 - Studs** – Wall framing may consist of either wood studs or steel studs. Wood studs to consist of nom 2 by 4 in. (51 mm by 102 mm) lumber spaced 16 in. (406 mm) OC. Steel studs to be min 3-1/2 in. (89 mm) wide and spaced max 24 in. (610 mm) OC.
 - Gypsum Board*** – Thickness, type, number of layers and fasteners as required in the individual Wall and Partition Design. Max size of opening is 14 by 14 in. (356 mm by 356 mm) square.
- Steel Duct** – Nom 12 by 12 in. (305 mm by 305 mm) (or smaller) No. 24 gauge (or heavier) galv steel duct to be centered within opening with a nom annular space of 1 in. (25 mm). Duct to be rigidly supported on both sides of opening.
- Fill, Void or Cavity Material* – Caulk or Sealant** – Min 5/8 in. (16 mm) thickness of caulk applied within annulus, flush with both surfaces of wall assembly.

3M COMPANY – CP 25WB+, IC 15WB+ caulk or FB-3000 WT sealant

*Bearing the UL Classification Mark

Reprinted from the Online Certifications Directory with permission from Underwriters Laboratories Inc.

Copyright © 2010 Underwriters Laboratories Inc.®



System No. W-L-7056

May 19, 2005
 F Rating – 2 Hr
 T Rating – 1/4 Hr

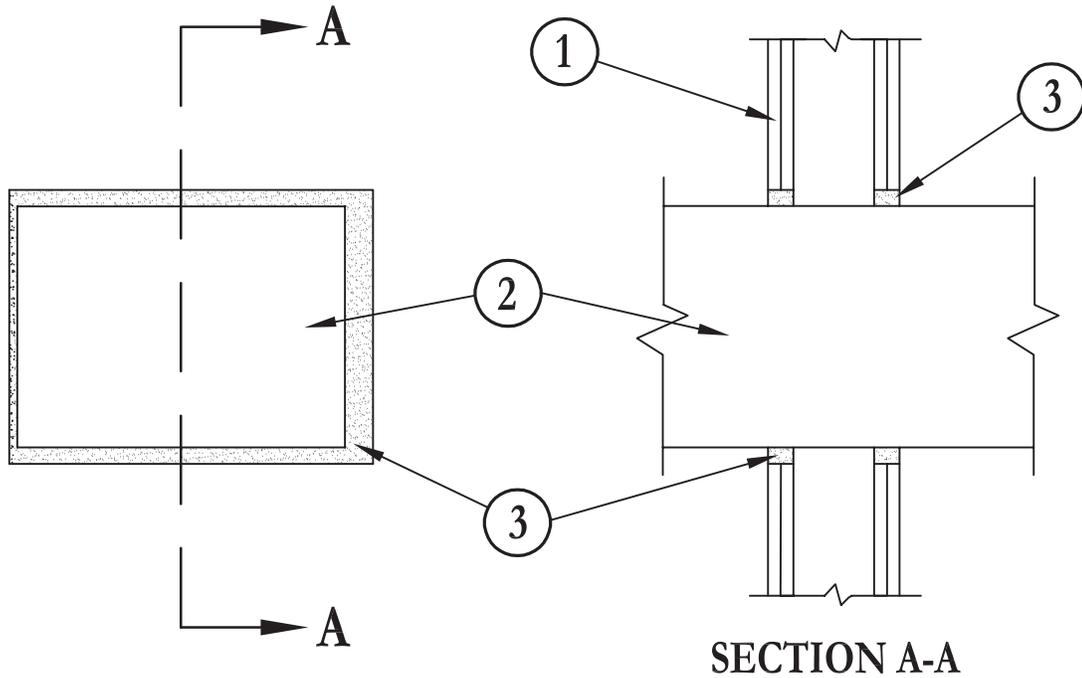

SECTION A-A

- Wall Assembly** – The 2 hr fire rated gypsum board/stud wall assembly shall be constructed of the materials and in the manner specified in the individual U400 or V400 Series Wall and Partition Designs in the UL Fire Resistance Directory and shall include the following construction features:
 - Studs** – Wall framing may consist of min 2-1/2 in. (64 mm) wide steel channel studs spaced max 24 in. (610 mm) OC.
 - Gypsum Board*** – Thickness, type, number of layers and fasteners as required in the individual Wall and Partition Design. Max area of opening is 49 sq in. (316 cm²) with max dimension of 7 in. (178 mm).
- Steel Duct** – Nom 6 by 6 in. (152 mm by 152 mm) (or smaller) No. 24 gauge (or heavier) steel duct to be installed either concentrically or eccentrically within the opening. The annular space shall be min 1/4 in. to max 3/4 in. (6 mm to max 19 mm). Duct to be rigidly supported on both sides of wall assembly.
- Fill, Void or Cavity Materials* – Caulk, Sealant or Putty** – Min 1-1/4 in. (32 mm) thickness of moldable putty, applied within the annulus flush with both surfaces of the wall.

3M COMPANY – CP 25WB+, IC 15WB+ caulk, FB-3000 WT sealant or MP+ Stix putty

*Bearing the UL Classification Marking

Reprinted from the Online Certifications Directory with permission from Underwriters Laboratories Inc.
 Copyright © 2010 Underwriters Laboratories Inc.®



System No. W-L-7063

October 14, 2009

F Ratings – 1 and 2 Hr (See Item 1)

T Ratings – 0 and 3/4 Hr (See Item 2)

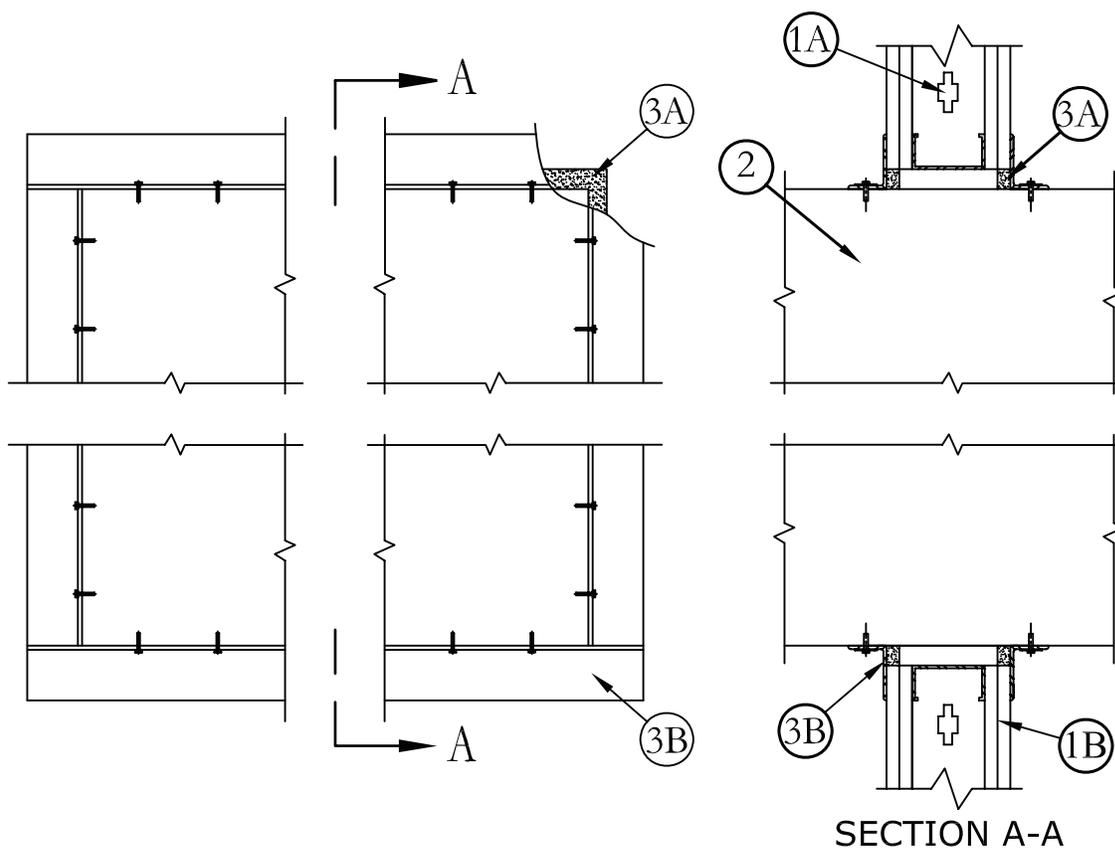

1. **Wall Assembly** – The 1 or 2 hr fire rated gypsum board/stud wall assembly shall be constructed of the materials and in the manner specified in the individual U400 or V400 Series Wall and Partition Designs in the UL Fire Resistance Directory and shall include the following construction features:
 - A. **Studs** – Wall framing may consist of steel channel studs. Steel studs to be min 3-1/2 in. (89 mm) wide and spaced max 24 in. (610 mm) OC. Additional steel studs shall be used to completely frame the opening.
 - B. **Wallboard, Gypsum*** – Thickness, type, number of layers and fasteners as required in the individual Wall and Partition Design. Max size of opening is 9,800 in² (6.32 m²) with a max dimension of 100 in. (254 cm).

The hourly F Rating of the firestop system is equal to the hourly fire rating of the wall assembly in which it is installed.
2. **Steel Duct** – Nom 96 by 96 in. (244 by 244 cm, or smaller) galv steel duct to be installed within the opening. The duct shall be constructed and reinforced in accordance with SMACNA construction standards and provided with 2 in. (51 mm) standing seams. The annular space between the duct and the periphery of opening shall be a min 1 in. (25 mm) to a max 2 in. (51 mm) with the exception that the standing seams which shall be installed at point contact to the framing of the opening. Duct to be rigidly supported on both sides of opening.

The hourly T Rating of the firestop system is 0 hr except that when the thickness of the steel duct is 18 ga, the T Rating is 3/4 hr.
3. **Firestop System** – The firestop system shall consist of the following.
 - A. **Fill, Void or Cavity Material* – Caulk or Sealant** – Min 5/8 in. (16 mm) thickness of caulk applied within annulus, flush with both surfaces of wall assembly.
3M COMPANY – CP 25WB+ or FB-3000 WT
 - B. **Steel Retaining Angles** – Min 16 gauge galv steel angles sized to lap duct a min of 2 in. (51 mm) and lap wall surface a min of 1 in. (25 mm). Angles attached to the duct on both sides of wall with No. 10 (or larger) steel sheet metal screws 1 in. (25 mm) from each end, and 6 in. (152 mm) OC. On the opposite side of wall, the screw pattern to be staggered.

*Bearing the UL Classification Mark

Reprinted from the Online Certifications Directory with permission from Underwriters Laboratories Inc.

Copyright © 2010 Underwriters Laboratories Inc.®



Through Penetrations

Misc. Mechanical

7000 Series

Gypsum

WL

System No. W-L-7091

May 19, 2005

F Ratings – 1 & 2 Hr (See Item 1)

T Rating – 0 Hr

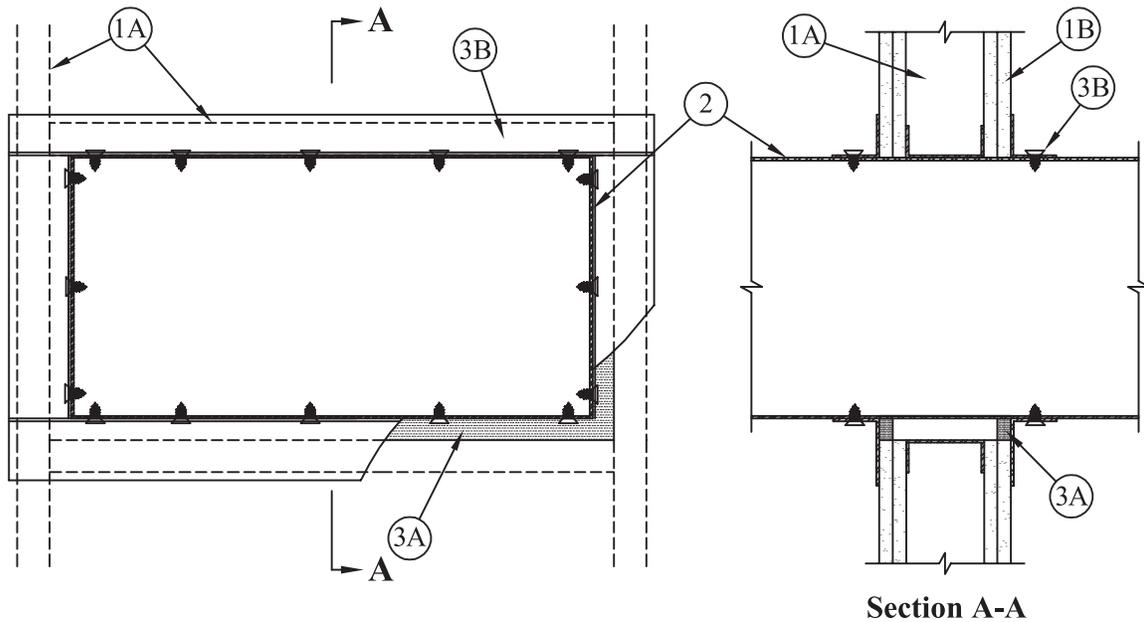
**Section A-A**

- Wall Assembly** – The 1 or 2 hr fire rated gypsum board/steel stud wall assembly shall be constructed of the materials and in the manner described in the individual U400 or V400 Series Wall or Partition Design in the UL Fire Resistance Directory and shall include the following construction features:

- Studs** – Wall framing shall consist of steel channel studs to be min 3-1/2 in. (89 mm) wide and spaced max 24 in. (610 mm) OC. Additional 3-1/2 in. (89 mm) wide steel studs shall be used to completely frame opening.
- Gypsum Board*** – Thickness, type, number of layers and fasteners as required in the individual Wall and Partition Design. Max size of opening to be 640 sq in. (4129 cm²) with a max dimension of 32 in. (813 mm)

The hourly F Rating of the firestop system is equal to the hourly fire rating of the wall assembly in which it is installed.

- Steel Duct** – Nom 30 in. by 18 in. (762 mm by 457 mm) (or smaller) No. 24 gauge (or heavier) galv steel duct installed concentrically or eccentrically within opening. Annular space between duct and periphery of opening to be min 0 in. (point contact) to max 2 in. (0 mm to max 51 mm). Duct to be rigidly supported on both sides of wall assembly.
- Firestop System** – The firestop system shall consist of the following:
 - Fill, Void or Cavity Material* – Caulk or Sealant** – Min 5/8 in. (16 mm) thickness of caulk applied within annulus, flush with both surfaces of wall.
3M COMPANY – CP 25WB+, IC 15WB+ caulk or FB-3000 WT sealant
 - Retaining Angles** – Min 16 gauge galv steel angles sized to lap duct a min of 2 in. (51 mm) and lap wall surfaces a min of 1 in. (25 mm). Angles attached to duct on both sides of wall with min 1/2 in. (13 mm) long, No. 10 (or larger) sheet metal screws spaced a max 1 in. (25 mm) from each end and spaced a max 6 in. (152 mm) OC.

*Bearing the UL Classification Marking

Reprinted from the Online Certifications Directory with permission from Underwriters Laboratories Inc.

Copyright © 2010 Underwriters Laboratories Inc.®



System No. W-L-7095

May 19, 2005

F Ratings – 1 & 2 Hr (See Item 1)

T Ratings – 0 & 1/4 Hr (See Item 1)

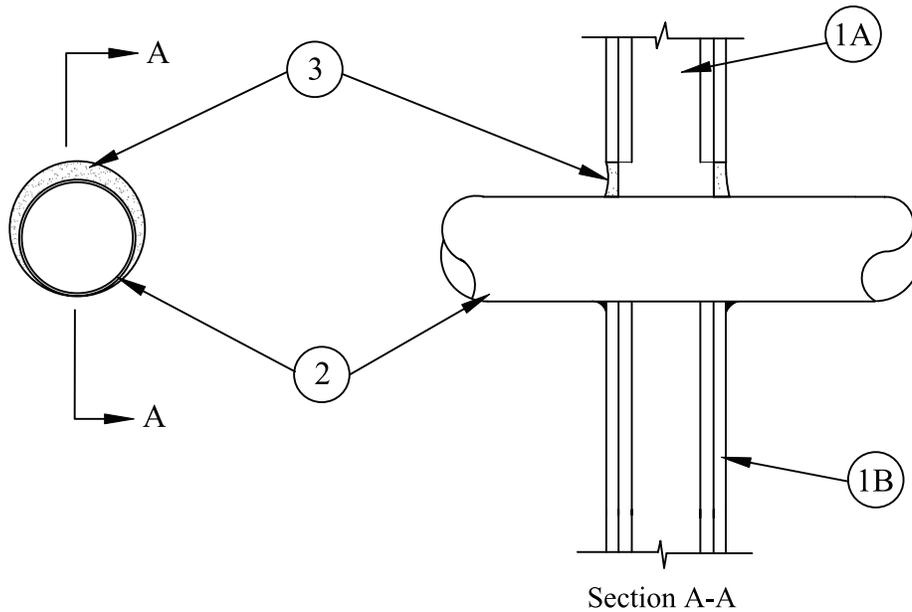

- Wall Assembly** – The 1 or 2 hr fire rated gypsum board/steel stud wall assembly shall be constructed of the materials and in the manner described in the individual U400 or V400 Series Wall or Partition Design in the UL Fire Resistance Directory and shall include the following construction features:
 - Studs** – Wall framing shall consist of steel channel studs to be min 3-1/2 in. (89 mm) wide and spaced max 24 in. (610 mm) OC. Additional 3-1/2 in. (89 mm) wide steel studs shall be used to completely frame opening.
 - Gypsum Board*** – Thickness, type, number of layers and fasteners as required in the individual Wall and Partition Design. Max diam of opening is 6-1/2 in. (165 mm).

The hourly F Rating of the firestop system is equal to the hourly fire rating of the wall assembly in which it is installed. The hourly T Rating of the firestop system is 0 and 1/4 Hr for 1 and 2 Hr rated assemblies, respectively.
- Steel Duct** – Nom 5 in. (127 mm) diam (or smaller) No. 30 gauge (or heavier) galv steel duct installed concentrically or eccentrically within opening. Annular space between duct and periphery of opening to be min 0 in. (point contact) to max 1-1/2 in. (0 mm to max 38 mm). Duct to be rigidly supported on both sides of wall assembly.
- Fill, Void or Cavity Material* – Caulk or Sealant** – Min 5/8 in. (16 mm) thickness of caulk applied within annulus, flush with both surfaces of wall. An additional min 1/4 in. (6 mm) diam bead of caulk applied to the duct/gypsum board interface at the point contact locations on both sides of wall.

3M COMPANY – CP 25WB+, IC 15WB+ caulk or FB-3000 WT sealant

*Bearing the UL Classification Marking

Reprinted from the Online Certifications Directory with permission from Underwriters Laboratories Inc.
Copyright © 2010 Underwriters Laboratories Inc.®



Through Penetrations

Misc. Mechanical

7000 Series

Gypsum

WL

System No. W-L-7112

May 19, 2005

F Ratings – 1 and 2 Hr (See Item 1)

T Rating – 0 Hr

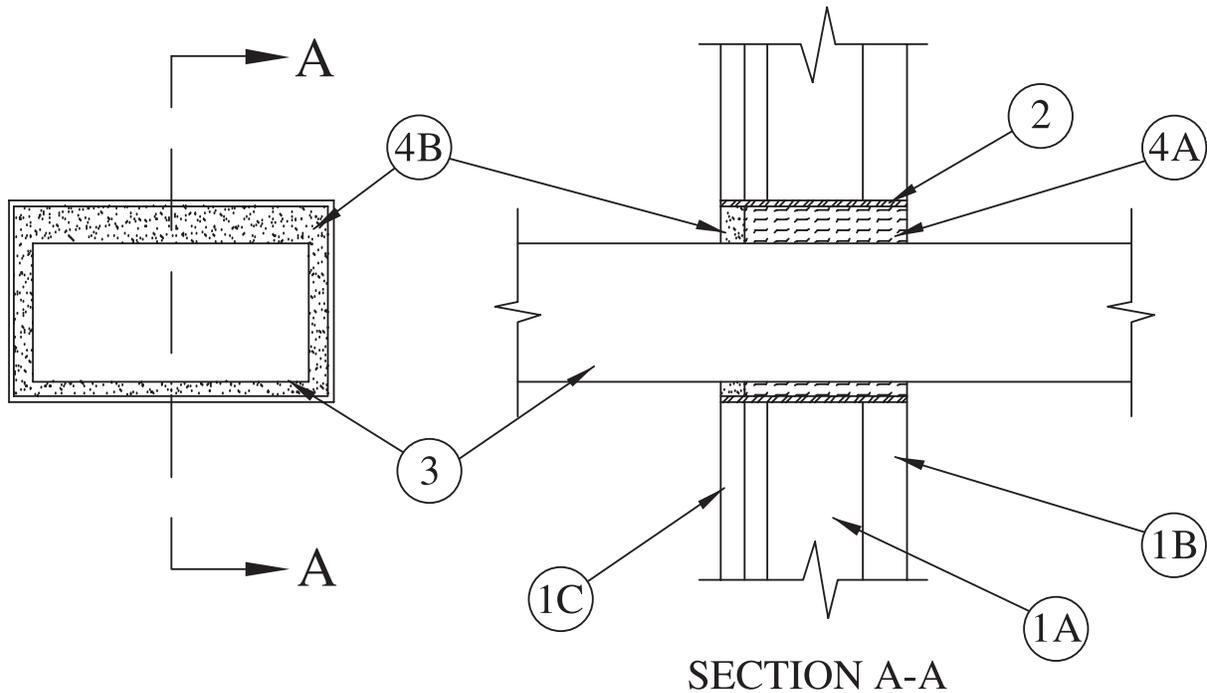

1. **Wall Assembly** – The 2 hr fire-rated shaft wall assembly shall be constructed of the materials and in the manner specified in the individual U400 or V400 Series Wall and Partition Designs in the UL Fire Resistance Directory and shall include the following construction features:
 - A. **Steel Studs** – C-H-shaped studs, min 2-1/2 in. (64 mm) wide by 1-1/2 in. (38 mm) deep, spaced 24 in. (610 mm) OC.
 - B. **Gypsum Board*** – 1 in. (25 mm) thick gypsum board liner panels, supplied in nom 24 in. (610 mm) widths as specified in the individual Wall and Partition Design. Max area of opening is 72 in.2 (465 cm²) with a max dimension of 12 in. (305 mm).
 - C. **Gypsum Board*** – Thickness, type, number of layers and fasteners as required in the individual Wall and Partition Design. Max area of opening is 72 in.2 (465 cm²) with a max dimension of 12 in. (305 mm).

The hourly F Rating of the firestop system is equal to the hourly fire rating of the wall assembly in which it is installed.

2. **Steel Sleeve** – Rectangular sleeve fabricated from min 0.019 in. (0.49 mm) thick galv sheet steel and sized to tightly fit into opening. Length of steel sleeve to be equal to thickness of wall.
3. **Steel Duct** – Nom 12 by 6 in. (305 by 152 mm) (or smaller) min 0.019 in. (0.49 mm) thick galv steel duct installed concentrically or eccentrically within opening. Annular space between duct and periphery of opening to be min 1/2 in. (13 mm) to max 1-1/2 in. (38 mm). Duct to be rigidly supported on both sides of wall assembly.
4. **Firestop System** – The firestop system shall consist of the following:
 - A. **Packing Material** – Min 3-1/2 (89 mm) and 4-1/8 in. (105 mm) thickness of min 4 pcf (64 kg/m³) mineral wool batt insulation firmly packed into opening as a permanent form for 1 and 2 hr rated assemblies, respectively. Packing material to be recessed from finished surface of wall (Item 1C) to accommodate the required thickness of fill material.
 - B. **Fill, Void or Cavity Materials* – Caulk or Sealant** – Min 5/8 in. (16 mm) thickness of caulk applied within annulus, flush with finished surface of wall assembly.
3M COMPANY – IC 15WB+, CP 25WB+ caulk or FB-3000 WT sealant

*Bearing the UL Classification Mark

Reprinted from the Online Certifications Directory with permission from Underwriters Laboratories Inc.
Copyright © 2010 Underwriters Laboratories Inc.®



System No. W-L-7146

July 11, 2006

F Ratings – 1 and 2 Hr (See Item 1)

T Rating – 0 Hr

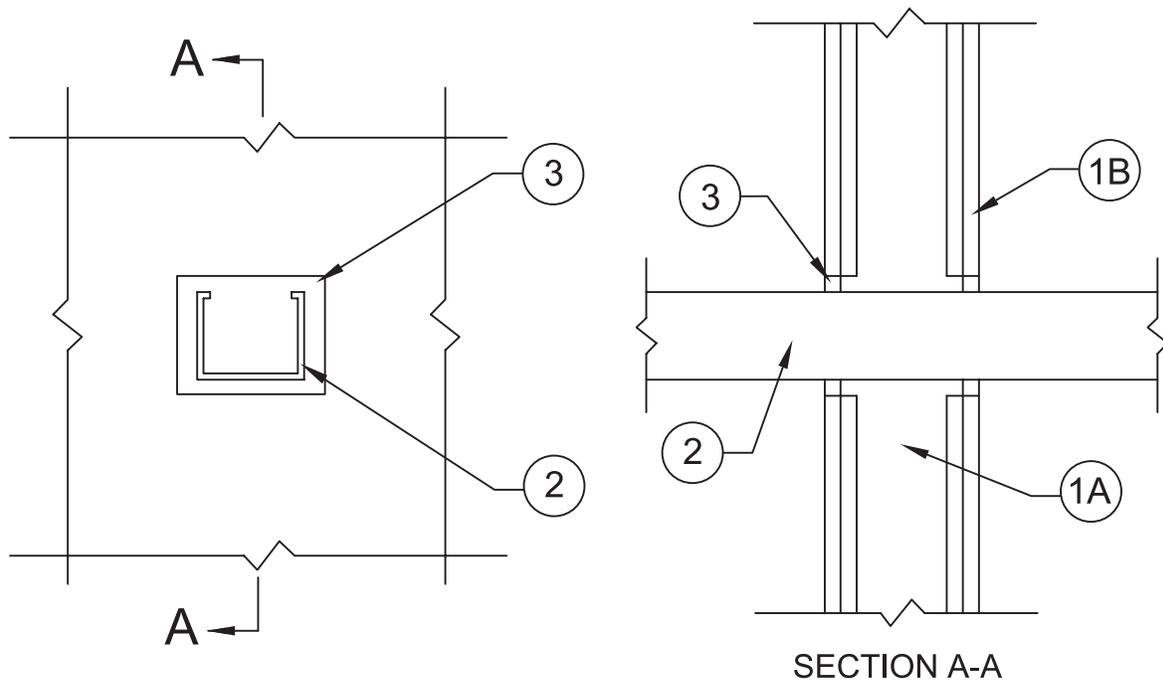

1. **Wall Assembly** – The 1 or 2 hr fire-rated gypsum board/stud wall assembly shall be constructed of the materials and in the manner specified in the individual U300, U400 or V400 Series Wall and Partition Designs in the UL Fire Resistance Directory and shall include the following construction features:

- A. **Studs** – Wall framing may consist of either wood studs or steel channel studs. Wood studs to consist of nom 2 by 4 in. (51 by 102 mm) lumber spaced max 16 in. (406 mm) OC. Steel studs to be min 2-1/2 in. (64 mm) wide and spaced max 24 in. (610 mm) OC.
- B. **Gypsum Board*** – One or two layers of gypsum board, as specified in the individual Wall and Partition Design. Max diam of opening is 3-3/8 in. (86 mm). Max area of rectangular opening is 16.5 sq in. (106 cm²) with max dimension of 5 in. (127 mm).

The hourly F Rating of the firestop system is equal to the hourly fire rating of the wall assembly in which it is installed.

2. **Through Penetrants** – One metallic strut, cable or rod service support to be installed within the firestop system. An annular space of min 1/8 in. (3 mm) to max 7/8 in. (22 mm) is required within the firestop system. Strut, cable or rod service support to be rigidly supported on both sides of wall assembly. The strut, cable or rod service support may be installed at an angle not greater than 45 degrees from the perpendicular. The following types and sizes of metallic strut, cable or rod service support may be used:
 - A. **Steel Strut** – Max 1-5/8 by 1-5/8 in. (41 by 41 mm) channel strut formed from min 0.105 in. (2.7 mm) thick galv or painted steel.
 - B. **Steel Strut** – Max 3-1/4 by 1-5/8 in. (83 by 41 mm) H strut formed from min 0.105 in. (2.7 mm) thick galv or painted steel.
 - C. **Cable** – Max 3/8 in. (9.5 mm) diam unjacketed galv steel cable.
 - D. **Threaded Rod** – Max 5/8 in. (16 mm) diam galv steel threaded rod.
3. **Fill, Void or Cavity Material* – Caulk** – Min 5/8 in. (16 mm) thickness of fill material applied within the annulus, flush with both surfaces of wall.

3M COMPANY – IC 15 WB+ caulk, CP 25WB+ caulk, 1000 NS sealant or FB-3000 WT sealant

*Bearing the UL Classification Mark

Reprinted from the Online Certifications Directory with permission from Underwriters Laboratories Inc.
Copyright © 2010 Underwriters Laboratories Inc.®



Through Penetrations

Misc. Mechanical

7000 Series

Gypsum

WL

System No. W-L-7152

October 16, 2006

F Ratings – 1 and 2 Hr (See Item 1)

T Ratings – 1 and 1-3/4 Hr (See Item 1)

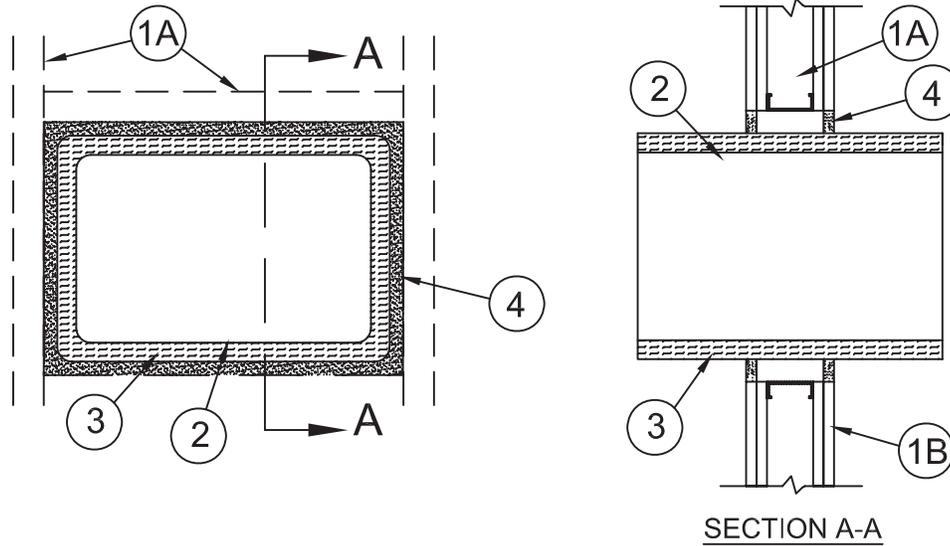

1. **Wall Assembly** – The 1 or 2 hr fire rated gypsum board/steel stud wall assembly shall be constructed of the materials and in the manner described in the individual U400 or V400 Series Wall and Partition Design in the UL Fire Resistance Directory and shall include the following construction features:
 - A. **Studs** – Wall framing shall consist of steel channel studs to be min 3-1/2 in. (89 mm) wide and spaced max 24 in. (610 mm) OC. Additional 3-1/2 in. (89 mm) wide steel studs shall be used to completely frame opening.
 - B. **Gypsum Board*** – Thickness, type, number of layers and fasteners as required in the individual Wall and Partition Design. Max area of opening to be 1080 sq in. (6968 cm²) with a max dimension of 36 in. (914 mm).

The hourly F Rating of the firestop system is equal to the hourly fire rating of the wall assembly in which it is installed. The hourly T rating of the firestop system is 1 and 1-3/4 Hr for 1 and 2 Hr rated assemblies, respectively.
2. **Steel Duct** – Max 30 in. by 24 in. (762 mm by 610 mm) No. 24 gauge (or heavier) galv steel duct installed concentrically within opening. Duct to be rigidly supported on both sides of wall assembly.
3. **Duct Insulation*** – Nom 2 in. (51 mm) thick glass fiber blanket insulation jacketed on the outside with foil-scrim-kraft facing. Longitudinal and transverse joints sealed with foil-scrim-kraft tape. A nominal 1 in. (25 mm) annular space shall be maintained between the insulated duct and the periphery of the opening.
See **Batts and Blankets** (BKNV) category in the Building Materials Directory for names of manufacturers. Any batts and blankets material meeting the above specifications and bearing the UL Classification Marking with a Flame Spread Index of 25 or less and a Smoke Developed Index of 50 or less may be used.
4. **Fill, Void or Cavity Material* – Caulk or Sealant** – Min 5/8 in. (16 mm) thickness of caulk applied within annulus, flush with both surfaces of wall.

3M COMPANY – FB-3000 WT sealant

*Bearing the UL Classification Mark

Reprinted from the Online Certifications Directory with permission from Underwriters Laboratories Inc.

Copyright © 2010 Underwriters Laboratories Inc.®



System No. W-L-7161

February 07, 2007

F Ratings – 1 and 2 Hr (See Item 1)

T Rating – 0 Hr

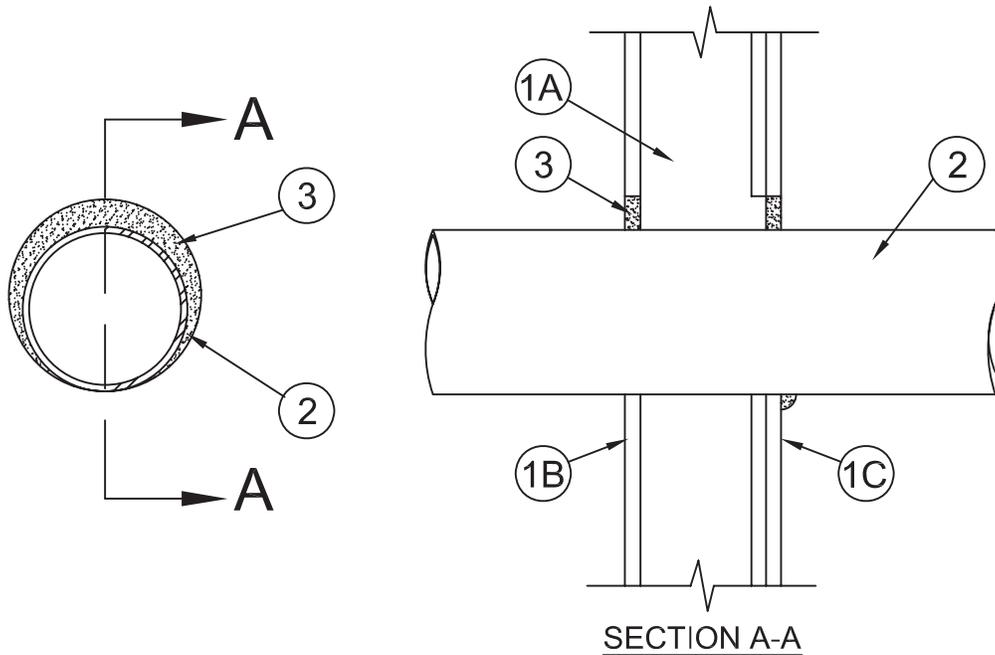

- Wall Assembly** – The 1 or 2 hr fire-rated gypsum board/stud shaft wall assembly shall be constructed of the materials and in the manner specified in the individual U400 or V400 Series Wall and Partition Designs in the UL Fire Resistance Directory and shall incorporate the following construction features:
 - Steel Studs** – “C-H” or “C-T” shaped studs, min 2-1/2 in. (64 mm) wide by 1-1/2 in. (38 mm) deep, fabricated from min No. 25 gauge (0.6 mm thick) galv steel, spaced max 24 in. (610 mm) OC.
 - Gypsum Board*** – 1 in. (25 mm) thick, 24 in. (610 mm) wide gypsum liner panels installed vertically. Max diam of circular cutout in gypsum liner panel is 6 in. (152 mm).
 - Gypsum Board*** – 1/2 in. or 5/8 in. (13 or 16 mm) thick, 48 in. (1.2 m) wide gypsum boards. The gypsum board type, thickness, number of layers, fastener type and sheet orientation shall be as specified in the individual Wall and Partition Design. Max diam of circular cutout in gypsum board is 6 in. (152 mm).

The hourly F Rating of the firestop system is equal to the hourly fire rating of the wall assembly in which it is installed.

- Steel Duct** – Nom 5 in. (127 mm) diam (or smaller) No. 30 gauge (or heavier) galv steel duct installed concentrically or eccentrically within opening. Annular space between duct and periphery of opening to be min 0 in. (0 mm, point contact) to max 1 in. (25 mm). Duct to be rigidly supported on both sides of wall assembly.
- Fill, Void or Cavity Materials* – Caulk or Sealant** – Min 1 in. (25 mm) thickness of fill material applied within the gypsum board liner panel flush with the faces of the liner panel. Min 5/8 in. (16 mm) thickness of fill material applied within the gypsum board annulus, flush with the finished side of the wall. Min 1/2 in. (13 mm) diam bead of caulk applied to the penetrant/gypsum board interface at the point contact location on the finished side of the wall.

3M COMPANY – CP25WB+ Caulk or FB-3000 WT Sealant

*Bearing the UL Classification Mark

Reprinted from the Online Certifications Directory with permission from Underwriters Laboratories Inc.
Copyright © 2010 Underwriters Laboratories Inc.®



Through Penetrations

Misc. Mechanical

7000 Series

Gypsum

WL

| ANSI/UL1479 (ASTM E814) | CAN/ULC S115 |
|-------------------------------------|---------------------------------------|
| F Ratings — 1 and 2 Hr (See Item 1) | F Ratings — 1 and 2 Hr (See Item 1) |
| T Ratings — 1 and 2 Hr (See Item 1) | FT Ratings — 1 and 2 Hr (See Item 1) |
| | FH Ratings — 1 and 2 Hr (See Item 1) |
| | FTH Ratings — 1 and 2 Hr (See Item 1) |

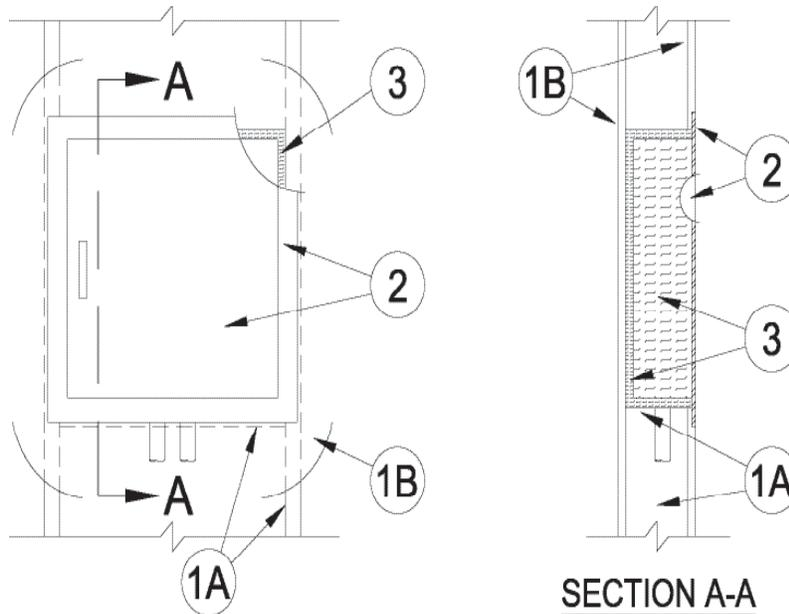

1. **Wall Assembly** — The 1 or 2 hr fire rated framed gypsum board wall assembly shall be constructed of the materials and in the manner specified in the individual U300, U400, V400, or W400 Series Wall and Partition Designs in the UL Fire Resistance Directory and shall include the following construction features:

- A. **Studs** — Wall framing shall consist of steel channel studs or wood studs. Steel studs to be min 3-5/8 in. (92 mm) wide and spaced max 24 in. (610 mm) OC. Wood studs to be min 2 by 4 in. (51 by 102 mm) or larger and spaced max 16 in. (406 mm) OC. An additional framing member shall be used to form a shelf within the wall cavity to support the steel box (Item 2) and mat fill material (Item 3). The framed opening is to be 1 in. (25 mm) wider than the width of the steel box.
- B. **Gypsum Board*** — The gypsum board type, thickness, number of layers and orientation shall be, as specified in the individual Wall and Partition Design. Size of cutout made to accommodate steel box (Item 2) is to be 1 in. (25 mm) wider and 1 in. (25 mm) higher than the width and height of the steel box.

The hourly F, T, FT, FH and FTH Ratings of the firestop system are equal to the hourly fire rating of the wall in which the firestop system is installed.

2. **Steel Box** — Max 19 in. (483 mm) wide by max 32 in. (813 mm) high by max 3 1/2 in. (89 mm) deep for steel stud walls. Max 12 in. (305 mm) wide by max 32 in. (813 mm) high by max 3 1/2 in. (89 mm) deep for wood stud walls. Box to be recessed box with hinged steel door and mounting flange. Steel box secured to steel studs with steel screws after application of mat material (Item 3) on exterior surfaces of steel box. Bottom and/or top of steel box may be penetrated by up to two max 1-1/2 in. (38 mm) diam copper, steel or iron pipes or tubes. Open pipes or tubes which terminate within the box shall be sealed with caulk (Item 4) or plugged with a ball of putty (Item 5).

3. **Fill, Void or Cavity Materials* - Mat** — Nominal 0.4 in. (10 mm) thick aluminum foil faced endothermic mat supplied in 24 in. wide rolls. Individual pieces of mat cut to cover four sides and back of box and laminated to box with high strength, fast, contact type adhesive (foil face exposed). The mat sections on the top and bottom of the box shall be cut to overlap the mat sections on the sides of the box. The mat section on the back of the box shall be cut to lap over the edge of the mat sections on the top, bottom and vertical sides of box. Circular cutouts made in the mat to accommodate the pipes or tubes to be 1/4 in. to 1/2 in. (6 to 13 mm) larger than outside diam of pipe or tube. All corners and butted seams in the mat are to be covered with min 2 mil aluminum foil tape.

3M COMPANY 3M FIRE PROTECTION PRODUCTS — Type E-54A or E-5A-4 Mat

4. **Fill, Void or Cavity Materials* - Caulk or Sealant** — (Not Shown) - Nom 1/4 in. (6 mm) diam bead of caulk applied to the edge of the mat material around the perimeter of the box mounting flange. Additional caulk fill material shall be used to completely fill each circular cutout made in the mat material to accommodate a pipe or tube. The end of each open pipe or tube which terminates within the box shall be sealed with a min 1/2 in. (13 mm) depth of caulk.

3M COMPANY 3M FIRE PROTECTION PRODUCTS — Type CP 25WB+ Caulk, FB-3000WT Sealant

5. **Fill, Void or Cavity Materials* - Putty** — (Not Shown) - As an alternate to the caulk (Item 4), the end of each open pipe or tube which terminates within the box may be sealed with a min 1/2 in. (13 mm) depth of putty fill material.

3M COMPANY 3M FIRE PROTECTION PRODUCTS — Type MP+ Moldable Putty

* Indicates such products shall bear the UL or cUL Certification Mark for jurisdictions employing the UL or cUL Certification (such as Canada), respectively.



System No. W-L-7169

October 06, 2010

F Ratings – 1 and 2 Hr (See Item 1)

T Rating – 0 Hr

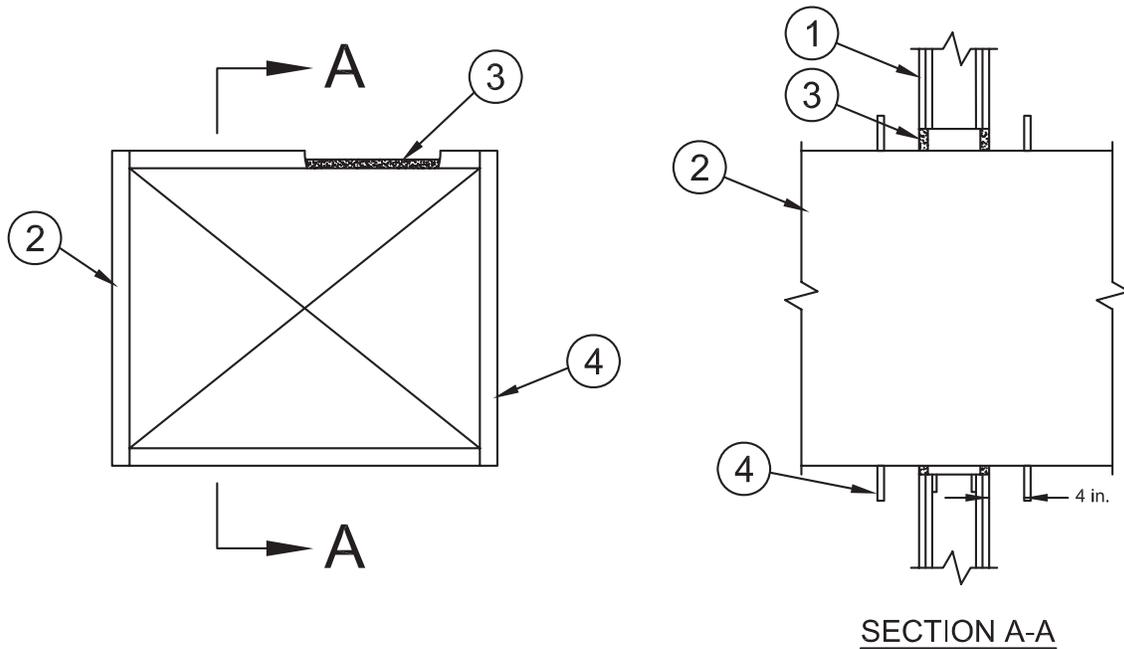

- Wall Assembly** – The 1 hr or 2 hr fire rated gypsum board/stud wall assembly shall be constructed of the materials and in the manner specified in the individual U400 or V400 Series Wall and Partition Designs in the UL Fire Resistance Directory and shall include the following construction features:
 - Studs** – Wall framing shall consist of min 3-5/8 in. (92 mm) wide steel studs, spaced max 24 in. (610 mm) OC. Additional min 3-5/8 in. (92 mm) wide steel studs shall be used to completely frame the opening.
 - Gypsum Board*** – Min 5/8 in. (16 mm) thick, 4 ft (1.22 m) wide with square or tapered edges. The gypsum board type, thickness, number of layers and orientation shall be as specified in the individual design. Max area of opening is 11.2 ft² (1.04 m²) with a max dimension of 42 in. (1.06 m).

The F Rating of the firestop system is equal to the fire rating of the wall assembly in which it is installed.

- Steel Duct** – Max 36 by 40 in. (914 by 1016 mm) by min 0.030 in. (0.76 mm) thick steel duct to be installed either concentrically or eccentrically within the opening. The annular space shall be min 1/2 in. (13 mm) to max 2 in. (51 mm). Duct to be rigidly supported on both sides of wall assembly.
- Fill, Void or Cavity Material* – Caulk or Sealant** – Min 5/8 in. (16 mm) thickness of fill material applied within the annulus, flush with both surfaces of the wall.
3M COMPANY
3M FIRE PROTECTION PRODUCTS – IC 15WB+, CP 25WB+, FB-3000 WT
- Steel Reinforcement Angles** – Min 2 by 2 by 0.070 in. (51 by 51 by 1.78 mm) thick steel angles attached to all four sides of duct on both sides of wall with protruding leg located 4 in. (102 mm) away from the surface of the wall. The angles shall be attached to the duct with min 1/8 in. (3.2 mm) diam steel rivets or No. 8 (or larger) steel sheet metal screws spaced max 1 in. (25 mm) from each end of duct and spaced a max of 3 in. (76 mm) OC.

*Bearing the UL Classification Mark

Reprinted from the Online Certifications Directory with permission from Underwriters Laboratories Inc.
Copyright © 2010 Underwriters Laboratories Inc.®



Through Penetrations

Misc. Mechanical

7000 Series

Gypsum

WL

System No. W-L-7177
 October 04, 2007
 F Ratings – 1 and 2 Hr (See Item 1)
 T Ratings – 1 and 1-3/4 Hr (See Item 1)

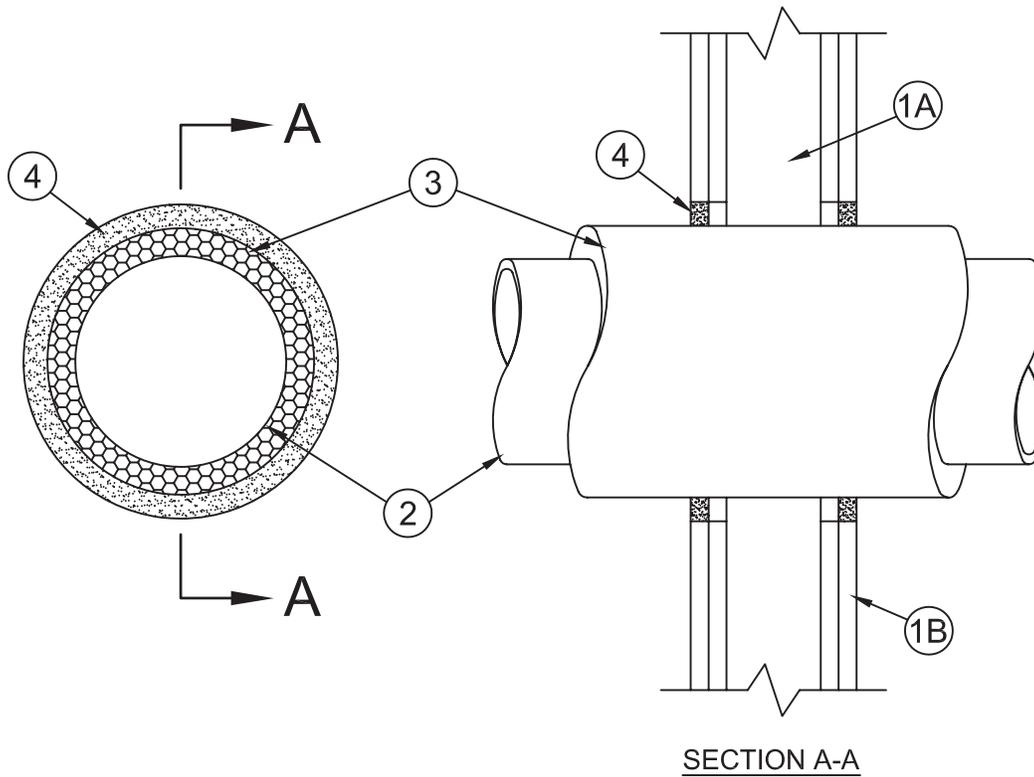

Through Penetrations

Misc. Mechanical

7000 Series

Gypsum

W/L

1. **Wall Assembly** – The 1 hr or 2 hr fire rated gypsum board/stud wall assembly shall be constructed of the materials and in the manner specified in the individual U400 or V400 Series Wall and Partition Designs in the UL Fire Resistance Directory and shall include the following construction features.

- A. **Studs** – Wall framing shall consist of min 3-1/2 in. (89 mm) wide steel channel studs spaced max 24 in. (610 mm) OC. When diam of opening exceeds width of stud cavity, additional lengths of steel stud installed to frame out opening around steel duct (Item 2).
- B. **Gypsum Board*** – Min 5/8 in. (16 mm) thick, 4 ft (1.22 m) wide with square or tapered edges. The gypsum board type, thickness, number of layers, fastener type and sheet orientation shall be as specified in the individual U400 or V400 Series Design in the UL Fire Resistance Directory. Max diam of opening is 30 in. (762 mm).

The hourly F Rating of the firestop system is equal to the hourly fire rating of the wall assembly in which it is installed. The hourly T rating of the firestop system is 1 and 1-3/4 Hr for 1 and 2 Hr rated assemblies, respectively.

- 2. **Steel Duct** – Max 24 in. (610 mm) diam No. 24 gauge (or heavier) spiral wound steel duct to be installed concentrically with a 3 in. (76 mm) annular space. Duct to be rigidly supported on both sides of wall assembly.
- 3. **Duct Insulation*** – Nom 2 in. (51 mm) thick glass fiber blanket insulation jacketed on the outside with foil-scrim-kraft facing. Longitudinal and transverse joints sealed with foil-scrim-kraft tape. A nominal 1 in. (25 mm) annular space shall be maintained between the insulated duct and the periphery of the opening.

See **Batts and Blankets** (BKNV) category in the Building Materials Directory for names of manufacturers. Any batts and blankets material meeting the above specifications and bearing the UL Classification Marking with a Flame Spread Index of 25 or less and a Smoke Developed Index of 50 or less may be used.

- 4. **Fill, Void or Cavity Material* – Sealant** – Min 5/8 in. (16 mm) thickness of fill material applied within annulus, flush with both surfaces of wall assembly.

3M COMPANY – FB-3000 WT

*Bearing the UL Classification Mark

Reprinted from the Online Certifications Directory with permission from Underwriters Laboratories Inc.
 Copyright © 2010 Underwriters Laboratories Inc.®



This material was extracted and drawn by 3M Fire Protection Products from the 2009 edition of the UL Fire Resistance Directory.

System No. W-L-7180

July 24, 2009

F Rating – 2 Hr

T Rating – 2 Hr

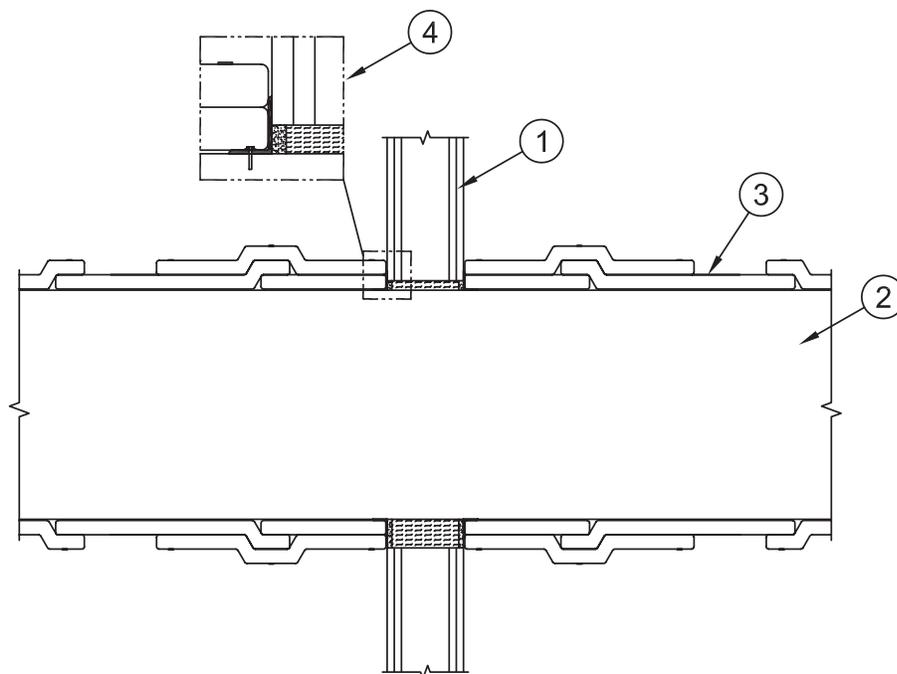

1. **Wall Assembly** – The 2 hr fire-rated gypsum board/stud wall assembly shall be constructed of the materials and in the manner specified in the individual U400 or V400 Series Wall and Partition Designs in the UL Fire Resistance Directory and shall include the following construction features:
 - A. **Studs** – Wall framing shall consist of steel “C” studs min 3-5/8 in. (92 mm) wide and spaced max 24 in. (610 mm) OC. Additional framing members shall be used to completely frame around opening.
 - B. **Gypsum Board*** – Min 5/8 in. (15.9 mm) thick, 4 ft (1220 mm) wide with square or tapered edges as specified in the individual U400 or V400 Wall and Partition Design.

Max size of opening is 17.3 sq ft (1.61 m²) with a max width of 89 in. (2.26 m).

See **Gypsum Board** (CKNX) category in the Fire Resistance Directory for names of manufacturers.

2. **Steel Air Duct** – Max 85 by 24 in. (2160 by 610 mm) 0.030 in. (0.76 mm) thick (22 GA) galvanized steel duct to be installed either concentrically or eccentrically within the opening. The annular space shall be min 1 in. (25 mm) to max 3 in. (76 mm) within the framed opening. The duct shall be constructed and reinforced in accordance with SMACNA HVAC Duct Construction Standards - Metal and Flexible. Steel duct to be rigidly supported on both sides of wall assembly.
3. **Duct Wrap Materials*** – Nom 1-1/2 in. (38 mm) thick ceramic fiber batt or blanket (min 6 pcf or 96 kg/m³) jacketed on the outside with a foil-scrim-poly facing, installed in a telescope, checkerboard or butt-joint-and-collar pattern with 3 in. (76 mm) transverse and longitudinal overlaps, in accordance with the requirements of Ventilation Assembly No. V-20. See Ventilation Duct Assemblies in Vol. 2 of the UL Fire Resistance Directory. Longitudinal and transverse joints sealed with aluminum foil tape.

3M COMPANY

3M FIRE PROTECTION PRODUCTS – 3M FireBarrier Duct Wrap 615 or 3M FireBarrier Duct Wrap 615+

4. **Firestop System** – The firestop system shall consist of the following:
 - A. **Packing Material** – Min 4-3/4 (121 mm) thickness of min 6 pcf (96 kg/m³) duct insulation firmly packed into opening as a permanent form. Packing material to be recessed from both surfaces of wall as required to accommodate the required thickness of fill material.

3M COMPANY

3M FIRE PROTECTION PRODUCTS – 3M FireBarrier Duct Wrap 615 or 3M FireBarrier Duct Wrap 615+

- B. **Fill Void or Cavity Material* – Sealant** – Min 5/8 in. (16 mm) thickness of fill material applied within annulus, flush with both surfaces of wall.

3M COMPANY

3M FIRE PROTECTION PRODUCTS – 3M FB-1000 NS

- C. **Steel Retaining Angles** – Stiffening angle 1-1/2 by 2 by 1/8 in. (38 by 52 by 3.2 mm), applied around the perimeter of the duct with the 2 in. (52 mm) leg against the sealant (Item 4B above). Angles attached to steel duct on both sides of wall with min No. 10 steel sheet metal screws spaced a max of 1 in. (25 mm) from each end of steel duct and spaced a max of 6 in. (152 mm) OC.

*Bearing the UL Classification Mark

Reprinted from the Online Certifications Directory with permission from Underwriters Laboratories Inc.

Copyright © 2010 Underwriters Laboratories Inc.®



System No. W-L-7182

March 16, 2016

F Rating — 1 Hr

T Rating — 1 Hr

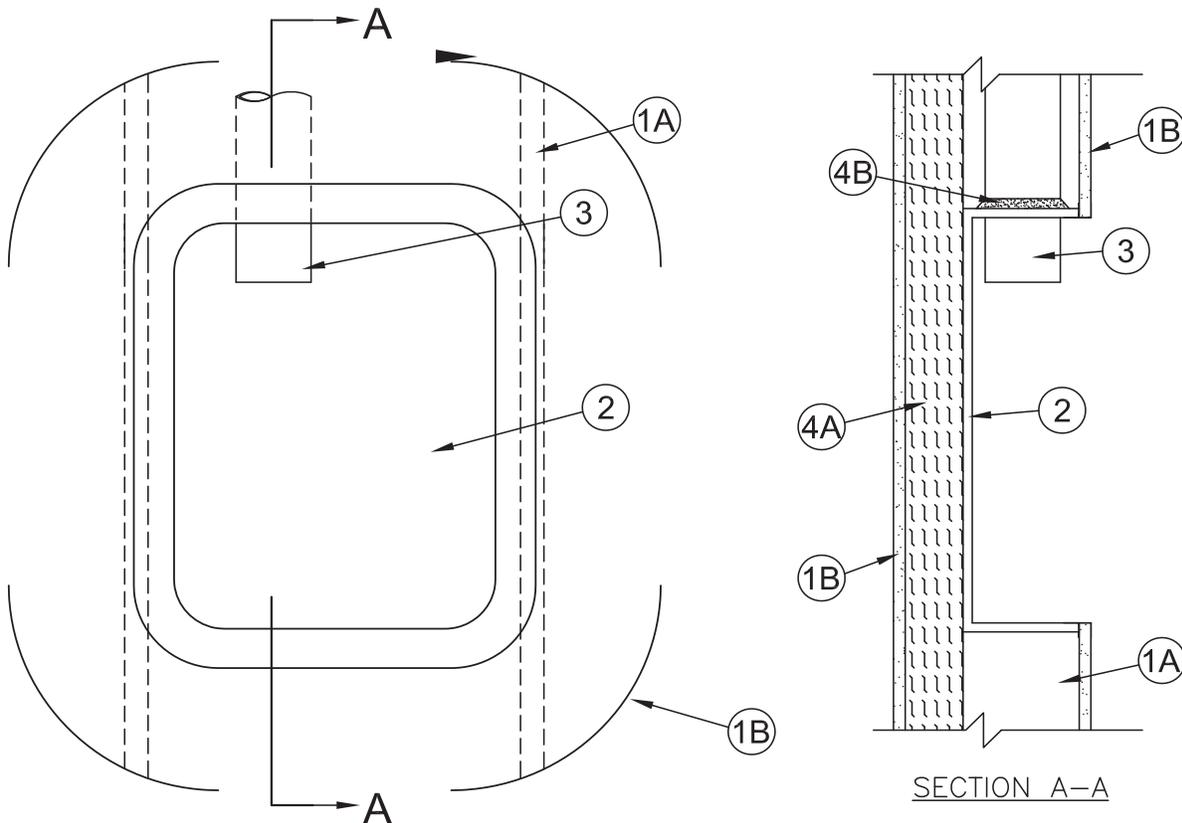

1. **Wall Assembly** — The 1 hr fire rated framed gypsum board wall assembly shall be constructed of the materials and in the manner specified in the individual U400 or V400 Series Wall and Partition Designs in the UL Fire Resistance Directory and shall include the following construction features:

- A. **Studs** — Wall framing shall consist of min 6 in. (152 mm) wide steel channel studs spaced max 24 in. (610 mm) OC. Additional framing members shall be used to form a nominal 11 in. (279 mm) wide stud cavity to support and accommodate the dryer vent cabinet (Item 2).
- B. **Gypsum Board*** — The gypsum board type, thickness, number of layers and orientation shall be as specified in the individual Wall and Partition Design. Size of cutout made to accommodate dryer vent cabinet (Item 2) to be nom 10 in. (254 mm) wide by 17 in. (432 mm) high.

2. **Cabinet*** — Dryer vent cabinet kit consisting of a flanged steel cabinet with separate trim ring, precut pieces of mat material and foil tape installed per manufacturers' installation instructions in nom 10 by 17 in. (254 by 432 mm) opening on one side of the wall. The dryer cabinet may be provided with the mat material factory installed.

3. **Vent Duct** — Nom 4 in. diam duct formed of min No. 26 gauge galvanized steel.

4. **Firestop System** — The details of the firestop system shall be as follows.

- A. **Batts and Blankets*** — Min 2 in. (51 mm) thickness of nom 4 pcf (64 kg/m³) mineral wool batt insulation. For the nominal 6 in. (152 mm) deep cabinet mineral wool batt installed between gypsum board and vent duct above the back of the cabinet. For the nominal 4 in. (102 mm) deep dryer vent cabinet a min 2 in. (51 mm) thickness of nom 4 pcf (64 kg/m³) mineral wool batt insulation to be installed to line the entire height of the stud cavity below, behind and above the cabinet.

See Batts and Blankets (BZJZ) category for names of manufacturers.

- B. **Fill, Void or Cavity Material*** — **Caulk** — Min 1/2 in. (13 mm) thickness of fill material applied to vent pipe/cabinet interface within the stud cavity.

3M COMPANY 3M FIRE PROTECTION PRODUCTS — CP 25WB+

* Indicates such products shall bear the UL or cUL Certification Mark for jurisdictions employing the UL or cUL Certification (such as Canada), respectively.



Through Penetrations

Misc. Mechanical

7000 Series

Gypsum

WL

System No. W-L-7190

December 05, 2013

ANSI/UL1479 (ASTM E814)
F Ratings — 1 and 2 Hr (See Item 1)
T Ratings — 1 and 2 Hr (See Item 1)

CAN/ULC S115
F Ratings — 1 and 2 Hr (See Item 1)
FT Ratings — 1 and 2 Hr (See Item 1)
FH Ratings — 1 and 2 Hr (See Item 1)
FTH Ratings — 1 and 2 Hr (See Item 1)

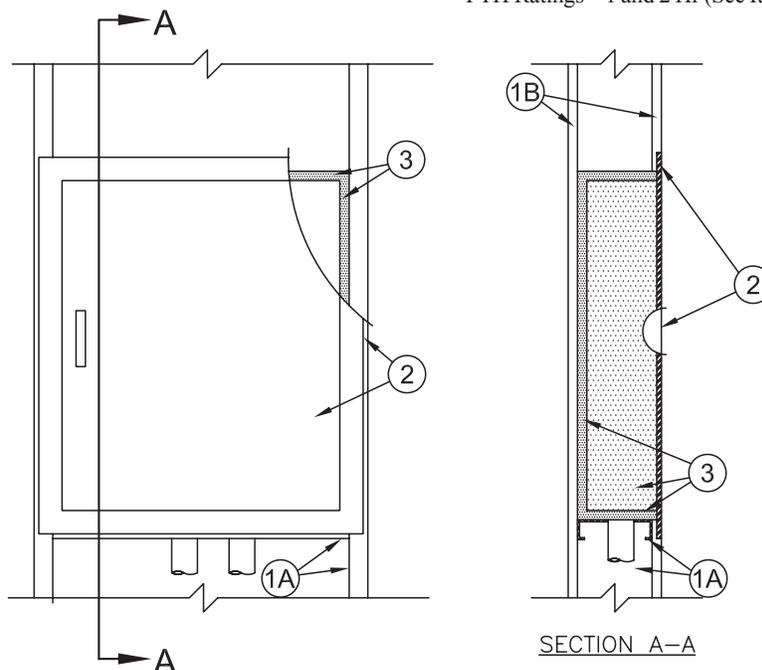

- Wall Assembly** – The 1 or 2 hr fire rated framed gypsum board wall assembly shall be constructed of the materials and in the manner specified in the individual U300, U400, V400 or W400 Series Wall and Partition Designs in the UL Fire Resistance Directory and shall include the following construction features:
 - Studs** – Wall framing shall consist of steel channel studs or wood studs. Steel studs to be min 6 in. (152 mm) wide and spaced max 24 in. (610 mm) OC. Wood studs to be nom 2 by 6 in. (51 by 152 mm) or larger and spaced max 16 in. (406 mm) OC. An additional framing member shall be used to form a shelf within the wall cavity to support the steel box (Item 2) and mat fill material (Item 3). The framed opening is to be 1 in. (25 mm) wider than the width of the steel box.
 - Gypsum Board*** – The gypsum board type, thickness, number of layers and orientation shall be, as specified in the individual Wall and Partition Design. Size of cutout made to accommodate steel box (Item 2) is to be 1 in. (25 mm) wider and 1 in. (25 mm) higher than the width and height of the steel box.

The hourly F, T, FT, FH and FTH Ratings are equal to the hourly rating of the wall assembly.

- Steel Box** – Min 18 gauge, max 20 in. (508 mm) wide by max 48 in. (1.22 m) high by max 6 in. (152 mm) deep for steel stud walls. Min 18 gauge, max 12 in. (305 mm) wide by max 48 in. (1.22 m) high by max 5-1/2 in. (140 mm) deep for wood stud walls. Box to be recessed with hinged steel door and mounting flange. Steel box secured to steel studs with steel screws after application of mat material (Item 3) on exterior surfaces of steel box. Bottom and/or top of steel box may be penetrated by one 2 in. (51 mm) diam steel EMT conduit and up to twelve 1 in. (25 mm) max diam installed from the top and one 1 in. (25 mm) and one 3/4 in. (19 mm) diam conduits installed from the bottom of the box.. Open pipes or tubes which terminate within the box shall be sealed with caulk (Item 4) or plugged with a ball of putty (Item 5).
- Fill, Void or Cavity Materials* – Mat** – Nominal 0.4 in. (10 mm) thick aluminum foil faced endothermic mat supplied in 24 in. wide rolls. Individual pieces of mat cut to cover four sides and back of box and laminated to box with high strength, fast, contact type adhesive (foil face exposed). The mat sections on the top and bottom of the box shall be cut to overlap the mat sections on the sides of the box. The mat section on the back of the box shall be cut to lap over the edge of the mat sections on the top, bottom and vertical sides of box. Circular cutouts made in the mat to accommodate the pipes or tubes to be 1/4 in. to 1/2 in. (6 to 13 mm) larger than outside diam of pipe or tube. All corners and butted seams in the mat are to be covered with min 2 mil aluminum foil tape.

3M COMPANY 3M FIRE PROTECTION PRODUCTS – Type E-54A or E-5A-4 Mat
- Fill, Void or Cavity Materials* – Caulk or Sealant** – (Not Shown) - Nom 1/4 in. (6 mm) diam bead of caulk applied to the edge of the mat material around the perimeter of the box mounting flange. Additional caulk fill material shall be used to completely fill each circular cutout made in the mat material to accommodate a pipe or tube. The end of each open pipe or tube which terminates within the box shall be sealed with a min 1/2 in. (13 mm) depth of caulk.

3M COMPANY 3M FIRE PROTECTION PRODUCTS – Type CP 25WB+ Caulk, FB-3000WT Sealant

3M COMPANY 3M FIRE PROTECTION PRODUCTS – Type CP 25WB+ Caulk, FB-3000WT Sealant

- Fill, Void or Cavity Materials* – Putty** – (Not Shown) - As an alternate to the caulk (Item 4), the end of each open pipe or tube which terminates within the box may be sealed with a min 1/2 in. (13 mm) depth of putty fill material.

3M COMPANY 3M FIRE PROTECTION PRODUCTS – Type MP+ Moldable Putty

* Indicates such products shall bear the UL or cUL Certification Mark for jurisdictions employing the UL or cUL Certification (such as Canada), respectively.

Reprinted from the Online Certifications Directory with permission from UL
© 2015 UL LLC



System No. W-L-7191

March 30, 2009

F Ratings – 1 and 2 Hr (See Item 1)

T Rating – 0 Hr

L Rating At Ambient – Less Than 1 CFM/sq ft

L Rating At 400 F – Less Than 1 CFM/sq ft

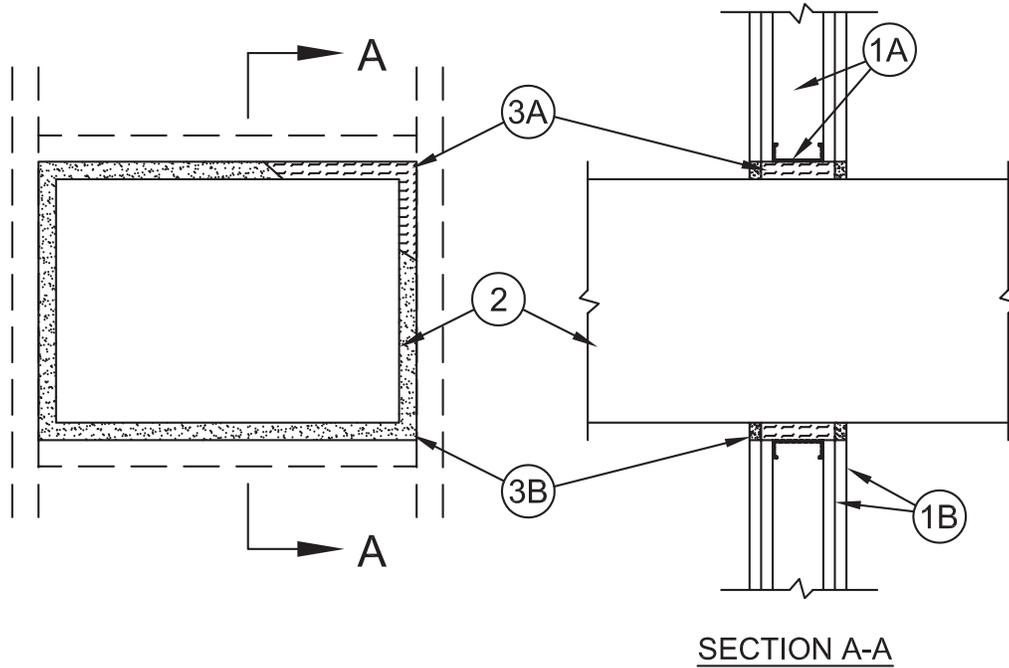
**SECTION A-A**

1. **Wall Assembly** – The 1 or 2 hr fire-rated gypsum board/stud wall assembly shall be constructed of the materials and in the manner specified in the individual U400 or V400 Series Wall and Partition Designs in the UL Fire Resistance Directory and shall include the following construction features:

- A. **Studs** – Wall framing shall consist of steel channel studs. Steel studs to be min 6 in. (152 mm) wide and spaced max 24 in. (60 mm) OC. Additional framing members shall be used to completely frame around opening.
- B. **Gypsum Board*** – Min 5/8 in. (16 mm) thick, 4 ft (121 cm) wide with square or tapered edges. The gypsum board type, thickness, number of layers and orientation shall be as specified in the individual U400 or V400 Wall and Partition Design. Max area of opening is 676 sq in. (4362 sq cm) with a max dimension of 26 in.

The hourly F Rating of the firestop system is equal to the hourly fire rating of the wall assembly in which it is installed.

2. **Steel Duct** – Max 24 by 24 in. (610 by 610 mm) No. 22 gauge (or heavier) steel duct to be installed either concentrically or eccentrically within the opening. The annular space shall be min 3/4 in. (19 mm) to max 1-1/2 in (38 mm). Duct to be rigidly supported on both sides of wall assembly.
3. **Firestop System** – The firestop system shall consist of the following:
- A. **Packing Material** – Min 6 in. (152 mm) or 7-1/4 in. (184 mm) thickness of min 4 pcf (64 kg/m³) mineral wool batt insulation for 1 or 2 hr rated walls, respectively. Mineral wool to be firmly packed into opening as a permanent form and recessed from both surfaces of wall to accommodate the required thickness of fill material.
- A1. **Forming Material*** – As an alternate to the packing material in Item 3A, nom 4 in. (102 mm) wide strips of min 1/2 in (13 mm) thick compressible mat to be stacked to a thickness greater than the width of the annular space and compression-fitted, edge-first, to fill the annular space to a min 6 in. (152 mm) depth for 1 hr rated walls and min 7-1/4 in. depth for 2 hr rated walls. Forming material to be recessed from both surfaces of wall as necessary to accommodate the required thickness of fill material.

3M COMPANY**3M FIRE PROTECTION PRODUCTS** – Fire Barrier Packing Material

- B. **Fill Void or Cavity Material*** – **Caulk** – Min 5/8 in. (16 mm) thickness of fill material applied within annular space, flush with both sides of wall.

3M COMPANY**3M FIRE PROTECTION PRODUCTS** – FB-3000 WT, IC 15WB+ or CP 25WB+

*Bearing the UL Classification Mark

Reprinted from the Online Certifications Directory with permission from Underwriters Laboratories Inc.

Copyright © 2010 Underwriters Laboratories Inc.®



System No. W-L-7195

April 16, 2014

F Rating — 1 and 2 Hr (See Item 1)

T Rating — 0 Hr

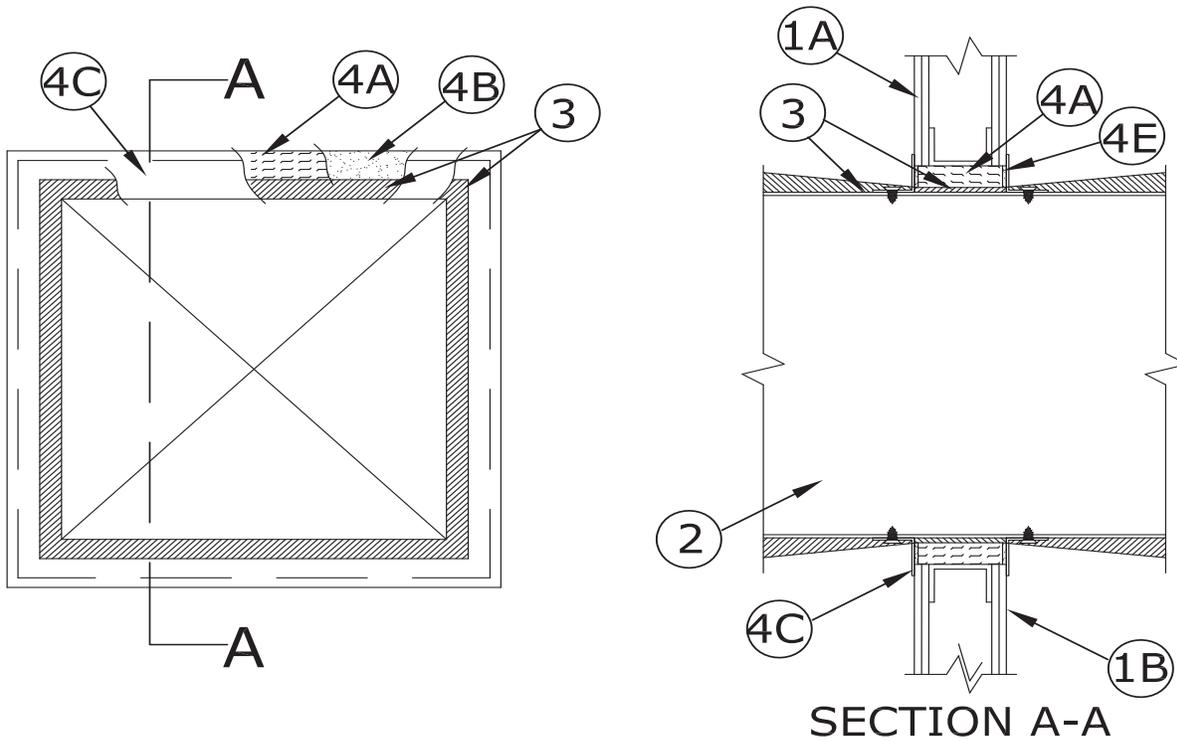

1. **Wall Assembly** — The 1 or 2 hr fire-rated gypsum board/stud wall assembly shall be constructed of the materials and in the manner specified in the individual U300, U400 or V400 Series Wall and Partition Designs in the UL Fire Resistance Directory and shall include the following construction features:

- A. **Studs** — Wall framing shall consist of either wood studs or steel channel studs. Wood studs to consist of nom 2 by 4 in. (51 by 102 mm) lumber spaced max 16 in. (406 mm) OC. Steel studs to be min 3-1/2 in. (89 mm) wide and spaced max 24 in. (610 mm) OC. Additional framing members shall be used to completely frame around opening.
- B. **Gypsum Board*** — Min 5/8 in. (16 mm) thick, 4 ft (1.2 m) wide with square or tapered edges. The gypsum board type, thickness, number of layers and orientation shall be as specified in the individual U300, U400 or V400 Wall and Partition Design. Max size of opening is 210 sq in. (1355 cm²) with a max width of 14-1/2 in. (368 mm) for wood studs. Max area of opening is 77.3 sq ft. (7.2 m²) with a max width of 105-1/2 in. (2.7 m) for steel studs.

The hourly F Rating of the firestop system is equal to the hourly fire rating of the wall in which it is installed.

- 2. **Steel Duct** — Max 100 by 100 in. (2.5 by 2.5 m) steel duct to be installed within the framed opening. The duct shall be constructed and reinforced in accordance with SMACNA construction standards. Steel duct to be rigidly supported on both sides of wall assembly.
- 3. **Batts and Blankets*** — Nom 1-1/2 or 2 in. (38 or 51 mm) thick glass fiber batt or blanket (min 3/4 pcf or 12 kg/m³) jacketed on the outside with a foil-scrim-kraft facing. Longitudinal and transverse joints sealed with aluminum foil tape. During the installation of the fill material, the batt or blanket shall be compressed minimum 50% such that the annular space within the firestop system shall be min 1/2 in. (13 mm) to max 2 in. (51 mm).

See Batts and Blankets (BKNV) category in the Building Materials Directory for names of manufacturers. Any batt or blanket meeting the above specifications and bearing the UL Classification Marking with a Flame Spread Index of 25 or less and a Smoke Developed Index 50 or less may be used.

4. **Firestop System** — The firestop system shall consist of the following:

A. **Packing Material** — Min 3-5/8 (92 mm) or 4-7/8 in. (124 mm) thickness of min 4 pcf (64 kg/m³) mineral wool batt insulation firmly packed into opening as a permanent form for 1 or 2 hr fire-rated walls, respectively. Packing material to be recessed from both surfaces of wall to accommodate the required thickness of fill material.

B. **Fill, Void or Cavity Material* — Sealant** — Min 5/8 in. (16 mm) thickness of fill material applied within annulus, flush with both surfaces of wall.

3M COMPANY 3M FIRE PROTECTION PRODUCTS — IC 15WB+, CP 25WB+, FB-3000 WT

C. **Steel Retaining Angles** — Min No. 16 gauge (0.059 in. or 1.5 mm) galv steel angles sized to lap steel duct a min of 1 in. (25 mm) and lap wall surfaces a min of 2 in. (51 mm). Angles attached to steel duct on both sides of wall with min No. 10 steel sheet metal screws spaced a max of 1 in. (25 mm) from each end of steel duct and spaced a max of 6 in. (152 mm) OC.

* Indicates such products shall bear the UL or cUL Certification Mark for jurisdictions employing the UL or cUL Certification (such as Canada), respectively.



System No. W-L-7196

July 12, 2010

F Ratings – 1 and 2 Hr (See Item 1)

T Rating – 0 Hr

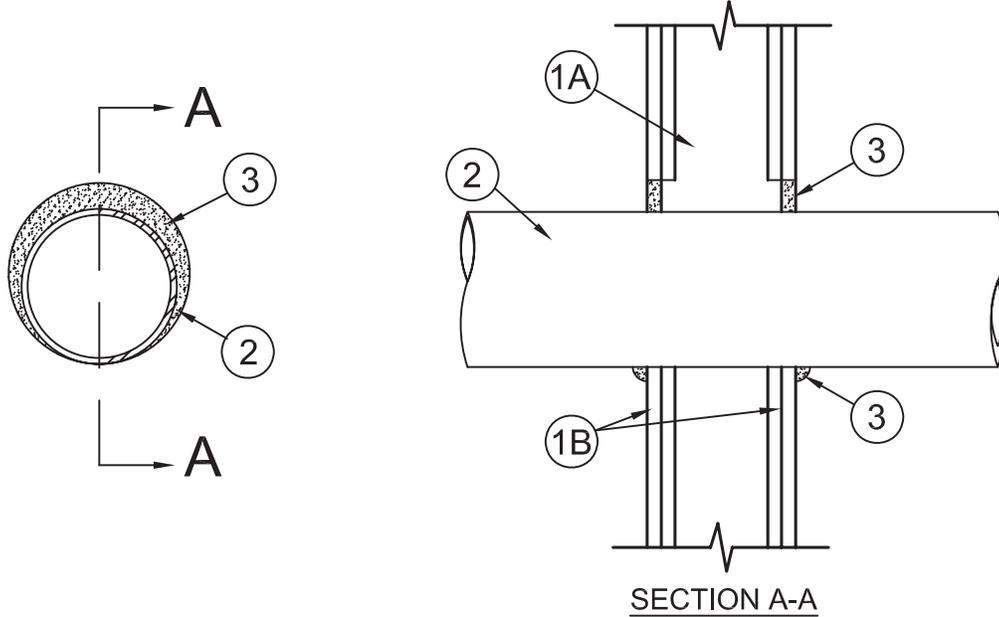

- Wall Assembly** – The 1 or 2 hr fire-rated gypsum board/stud wall assembly shall be constructed of the materials and in the manner specified in the individual U300, U400 or V400 Series Wall and Partition Design in the UL Fire Resistance Directory and shall include the following construction features:

- Studs** – Wall framing may consist of either wood studs or steel channel studs. Wood studs to consist of nom 2 by 4 in. (51 by 102 mm) lumber spaced 16 in. (406 mm) OC. Steel studs to be min 3-1/2 in. (89 mm) wide and spaced max 24 in. (610 mm) OC.
- Gypsum Board*** – Thickness, type, number of layers and fasteners as specified in the individual Wall and Partition Design. Diam of opening to be max 2 in. (51 mm) larger than OD of steel duct (Item 2). Max diam of opening is 14 in. (356 mm).

The hourly F Rating of the firestop system is equal to the hourly fire rating of the wall assembly in which it is installed.

- Steel Duct** – Nom 12 in. (305 mm) diam (or smaller) No. 26 gauge (or heavier) spiral wound or long seam galv steel duct. The duct shall be constructed and reinforced in accordance with SMACNA construction standards. Annular space between duct and periphery of opening to be min 0 in. (point contact) to max 2 in. (51 mm). Duct to be rigidly supported on both sides of the wall assembly.
- Fill, Void or Cavity Material* – Sealant** – Min 5/8 in. (16 mm) thickness of fill material applied within annulus, flush with both surfaces of wall assembly. At point contact location, min 1/4 in. (6 mm) diam bead of fill material applied at steel duct/gypsum board interface on both surfaces of wall.

3M COMPANY**3M FIRE PROTECTION PRODUCTS** – IC 15WB+, CP 25WB+ or FB-3000 WT sealant

*Bearing the UL Classification Mark

Reprinted from the Online Certifications Directory with permission from Underwriters Laboratories Inc.

Copyright © 2010 Underwriters Laboratories Inc.®



System No. W-L-7197

September 20, 2011

ANSI/UL1479 (ASTM E814)

F Ratings – 1 and 2 Hr (See Item 1)

T Rating – 0 Hr

CAN/ULC S115

F Ratings – 1 and 2 Hr (See Item 1)

FT Rating – 0 Hr

FH Ratings – 1 and 2 Hr (See Item 1)

FTH Rating – 0 Hr

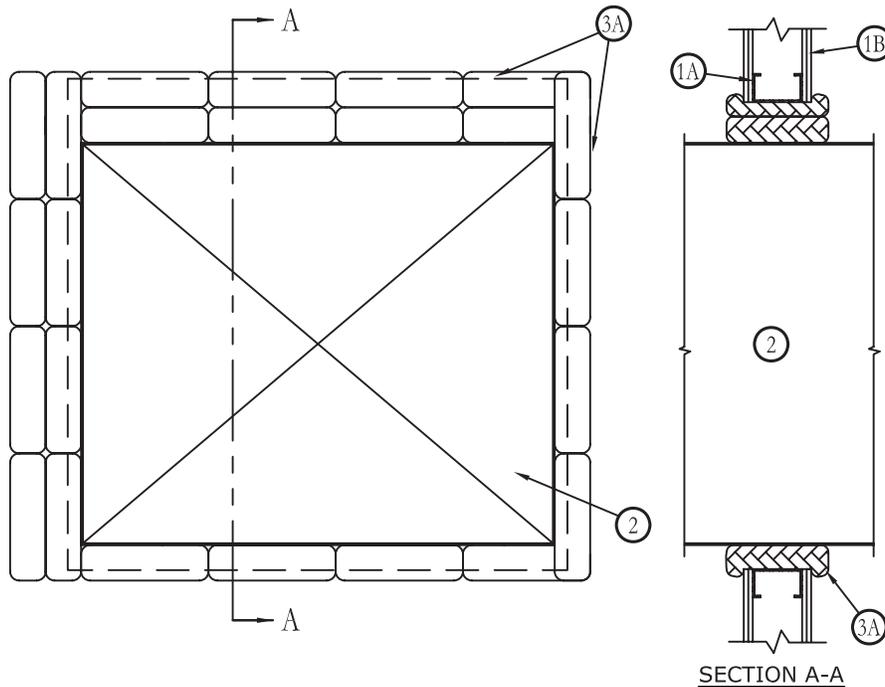

1. **Wall Assembly** – The 1 or 2 hr fire rated framed gypsum board wall assembly shall be constructed of the materials and in the manner specified in the individual U400, V400 or W400 Series Wall and Partition Designs in the UL Fire Resistance Directory and shall include the following construction features:

- A. **Studs** – Wall framing shall consist of min 3-5/8 in. (92 mm) wide steel channel studs spaced max 24 in. (610 mm) OC. Additional framing members shall be used to completely frame around opening.
- B. **Gypsum Board*** – Thickness, type, number of layers and fasteners as required in the individual Wall and Partition Design. Max area of opening is 952 sq in. (0.61 m²) with a max dimension of 34 in. (864 mm).

The hourly F and FH Ratings for the firestop system are equal to the hourly fire rating of the wall assembly in which it is installed.

2. **Steel Duct** – Max 24 by 30 in. (610 by 762 mm) No. 22 gauge (or heavier) steel duct to be installed concentrically or eccentrically within opening. Annular space between duct and periphery of opening shall be min 1 in. (25 mm) to max 4 in. (102 mm). Duct to be rigidly supported on both sides of wall assembly.
3. **Firestop System** – The firestop system shall consist of the following:
 - A. **Fill, Void or Cavity Material* – Pillows** – Nom 9 in. (229 mm) long by 4 or 6 in. (102 or 152 mm) wide by 2 or 3 in. (51 or 76 mm) thick plastic covered pillows. Pillows to be installed lengthwise through the opening and positioned to extend equally in both directions from the approximate center line of the wall. Pillows tightly-packed into opening to completely fill the annular space between the steel duct and the periphery of the opening.

3M COMPANY

3M FIRE PROTECTION PRODUCTS – Fire Barrier Pillows, Fire Barrier Self-Locking Pillows

- B. **Fill, Void or Cavity Material* – Putty** – (Not Shown) – After installation of pillows (Item 3A), putty applied to seal any voids between or around the pillows on both sides of the wall assembly.

3M COMPANY

3M FIRE PROTECTION PRODUCTS – MP+

*Bearing the UL Classification Mark

Reprinted from the Online Certifications Directory with permission from Underwriters Laboratories Inc.
Copyright © 2011 Underwriters Laboratories Inc.®



System No. W-L-7207

January 17, 2012

ANSI/UL1479 (ASTM E814)
 F Ratings — 1 and 2 Hr (See Item 1)
 T Ratings — 1 and 2 Hr (See Item 1)

CAN/ULC S115
 F Ratings — 1 and 2 Hr (See Item 1)
 FT Ratings — 1 and 2 Hr (See Item 1)
 FH Ratings — 1 and 2 Hr (See Item 1)
 FTH Ratings — 1 and 2 Hr (See Item 1)

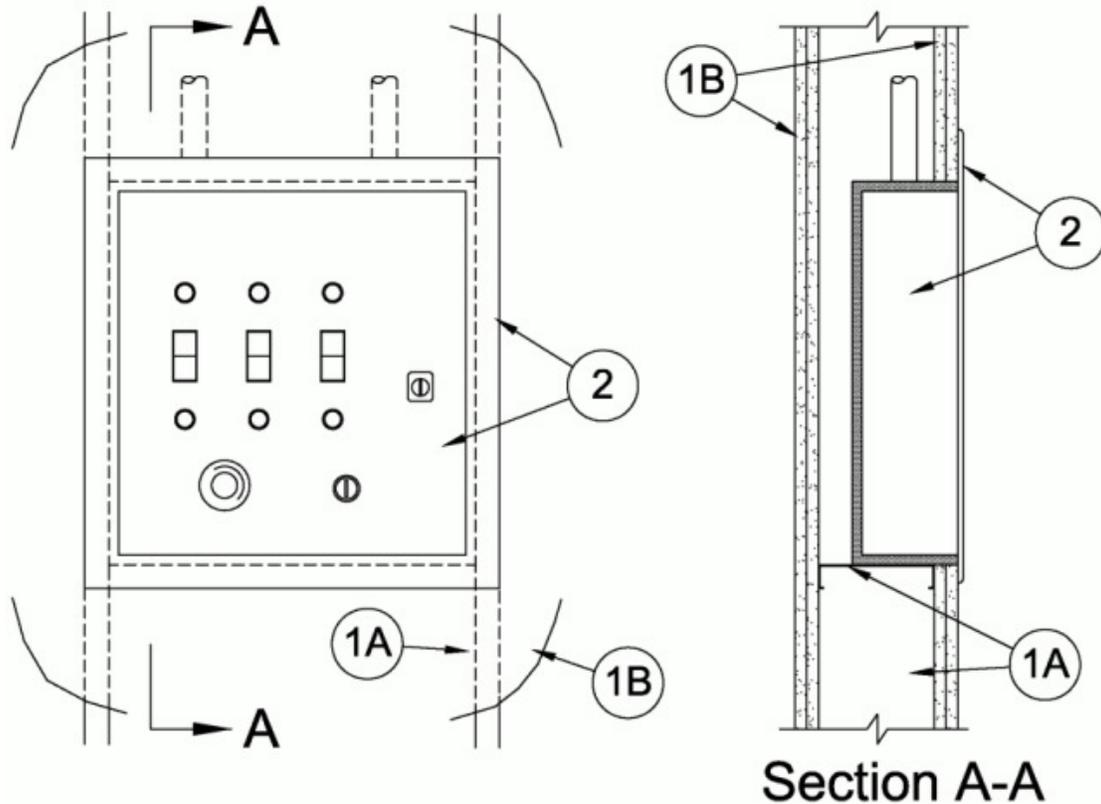

Section A-A

- Wall Assembly** — The 1 hr or 2 hr fire rated framed gypsum board wall assembly shall be constructed of the materials and in the manner specified in the individual U400, V400 or W400 Series Wall and Partition Designs in the UL Fire Resistance Directory and shall include the following construction features:
 - Studs** — Wall framing shall consist of steel channel studs. Steel studs to be min 6 in. (152 mm) wide and spaced max 24 in. (610 mm) OC. An additional framing member shall be used to form a shelf within the wall cavity to support the utility controller cabinet (Item 2). The framed opening is to be 1 in. (25 mm) wider than the steel enclosure of the cabinet.
 - Gypsum Board*** — The gypsum board type, thickness, number of layers and orientation shall be as specified in the individual Wall and Partition Design. Size of cutout made to accommodate steel box (Item 2) is to be 1 in. (25 mm) wider and 1 in. (25 mm) higher than the width and height of the steel enclosure of the cabinet.

The hourly F and T Ratings of the firestop system are equal to the hourly fire rating of the wall in which the firestop system is installed.
- Cabinet* - Utility Controller** — Recessed factory-protected utility control cabinet with hinged door and trim frame installed per manufacturers' installation instructions in opening on one side of the wall. Mounting brackets at top and bottom of utility control cabinet secured to steel studs with steel screws through mounting brackets prior to installation of gypsum board on one or both sides of wall. Bottom and/or top of steel box may be penetrated by one 2 in. (51 mm) diam steel EMT conduit and up to twelve 1 in. (25 mm) max diam installed from the top and one 1 in. (25 mm) and one 3/4 in. (19 mm) diam conduits installed from the bottom of the box. Conduit which terminates within the box shall be internally plugged with a min 1/2 in. (13 mm) depth of caulk supplied with cabinet or with a ball of putty fill material (Item 3).

ISIMET LLC — Series UtC-F2, LSP-F2 and S-F2

- Fill, Void or Cavity Materials* - Putty — (Not Shown) - As an alternate to the caulk supplied with the cabinet, the end of each conduit which terminates within the cabinet may be sealed with a min 1/2 in. (13 mm) depth of putty fill material.

3M COMPANY

3M FIRE PROTECTION PRODUCTS — Type MP+ Moldable Putty

*Bearing the UL Classification Mark

Reprinted from the Online Certifications Directory with permission from UL

© 2012 UL LLC



System No. W-L-7216

May 23, 2014

ANSI/UL1479 (ASTM E814)

F Rating — 1 and 2 Hr (See Item 1)

T Rating — 1 and 2 Hr (See Item 1)

CAN/ULC S115

F Rating — 1 and 2 Hr (See Item 1)

FT Rating — 1 and 2 Hr (See Item 1)

FH Ratings — 1 and 2 Hr (See Item 1)

FTH Rating — 1 and 2 Hr (See Item 1)

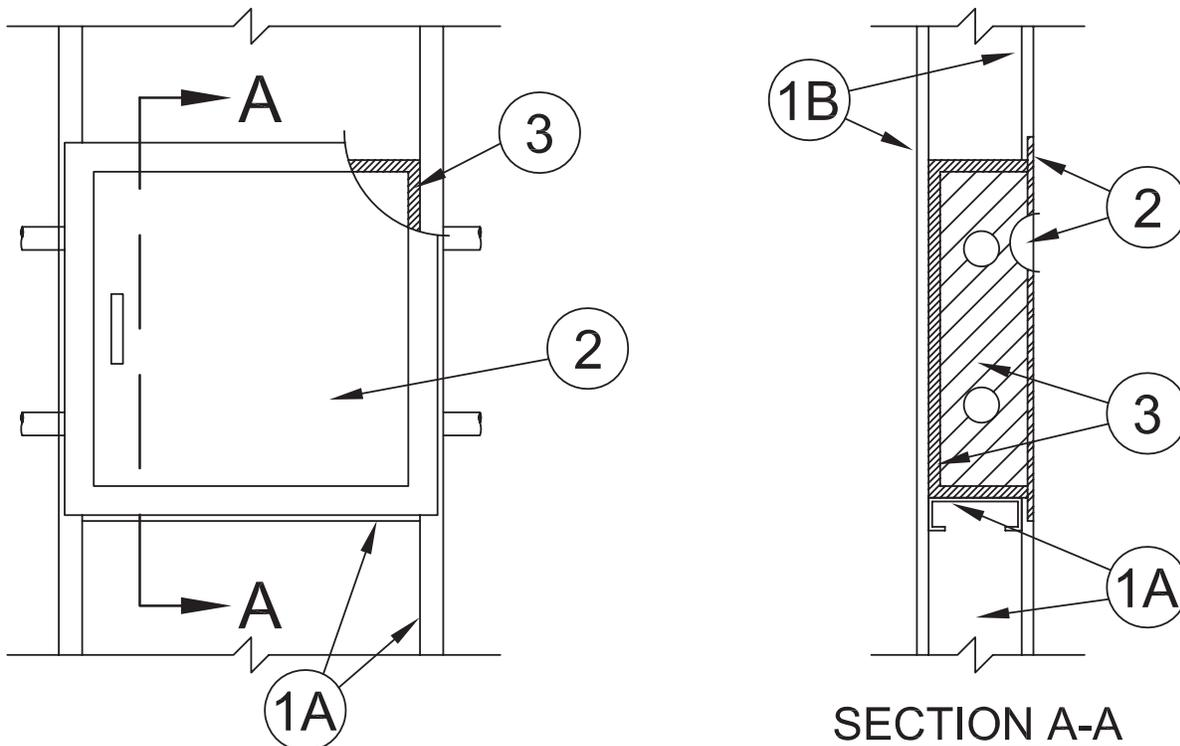

1. **Wall Assembly** — The 1 or 2 hr fire rated framed gypsum board wall assembly shall be constructed of the materials and in the manner specified in the individual U300, U400, V400 or W400 Series Wall and Partition Designs in the UL Fire Resistance Directory and shall include the following construction features:
 - A. **Studs** — Wall framing shall consist of steel channel studs or wood studs. Steel studs to be min 3-5/8 in. (92 mm) wide and spaced max 24 in. (610 mm) OC. Wood studs to be nom 2 by 4 in. (51 by 102 mm) or larger and spaced max 16 in. (406 mm) OC. An additional framing member shall be used to form a shelf within the wall cavity to support the steel box (Item 2) and mat fill material (Item 3). The framed opening is to be 1 in. (25 mm) wider than the width of the steel box.
 - B. **Gypsum Board*** — The gypsum board type, thickness, number of layers and orientation shall be, as specified in the individual Wall and Partition Design. Size of cutout made to accommodate steel box (Item 2) is to be 1 in. (25 mm) wider and 1 in. (25 mm) higher than the width and height of the steel box.

The hourly F, T, FT, FH and FTH Ratings are equal to the hourly rating of the wall assembly.

2. **Steel Box** — Min 18 gauge, max 11-7/8 in. (302 mm) wide by max 20 in. (508 mm) high by max 3-7/8 in. (98 mm) deep for steel and wood stud walls. Box to be recessed with hinged steel door and mounting flange. Steel box secured to steel studs with steel screws after application of mat material (Item 3) on exterior surfaces of steel box. Each vertical side of steel box may be penetrated by a maximum of two 1-1/2 in. (38 mm) max diam copper pipes or tubes. Pipes or tubes shall not terminate within the box and shall be contained in a closed system.
3. **Fill, Void or Cavity Materials*** — **Mat** — Nominal 0.4 in. (10 mm) thick aluminum foil faced endothermic mat supplied in 24 in. wide rolls. Individual pieces of mat cut to cover four sides and back of box and laminated to box with high strength, fast, contact type adhesive (foil face exposed). The mat sections on the top and bottom of the box shall be cut to overlap the mat sections on the sides of the box. The mat section on the back of the box shall be cut to lap over the edge of the mat sections on the top, bottom and vertical sides of box. Circular cutouts made in the mat to accommodate the pipes or tubes to be 1/4 in. to 1/2 in. (6 to 13 mm) larger than outside diam of pipe or tube. All corners and butted seams in the mat are to be covered with min 2 mil aluminum foil tape.

3M COMPANY 3M FIRE PROTECTION PRODUCTS — Type E-54A or E-5A-4 Mat

4. **Fill, Void or Cavity Materials*** — **Caulk or Sealant** — (Not Shown) - Nom 1/4 in. (6 mm) diam bead of caulk applied to the edge of the mat material around the perimeter of the box mounting flange. Additional caulk fill material shall be used to completely fill each circular cutout made in the mat material to accommodate a pipe or tube.

3M COMPANY 3M FIRE PROTECTION PRODUCTS — Type CP 25WB+ Caulk, FB-3000WT Sealant

*Bearing the UL Classification Mark

Reprinted from the Online Certifications Directory with permission from UL
© 2014 UL LLC



System No. W-L-7221

November 10, 2014

ANSI/UL1479 (ASTM E814)
 F Ratings — 1 and 2 Hr (See Item 1)
 T Ratings — 0 and ½ Hr (See Item 1)
 L Rating At Ambient — Less Than 1 CFM/sq ft
 L Rating At 400 F — Less Than 1 CFM/sq ft

CAN/ULC S115
 F Ratings — 1 and 2 Hr (See Item 1)
 FT Ratings — 0 and ½ Hr (See Item 1)
 FH Ratings — 1 and 2 Hr (See Item 1)
 FTH Ratings — 0 and ½ Hr (See Item 1)
 L Rating At Ambient — Less Than 1 CFM/sq ft
 L Rating At 400 F — Less Than 1 CFM/sq ft

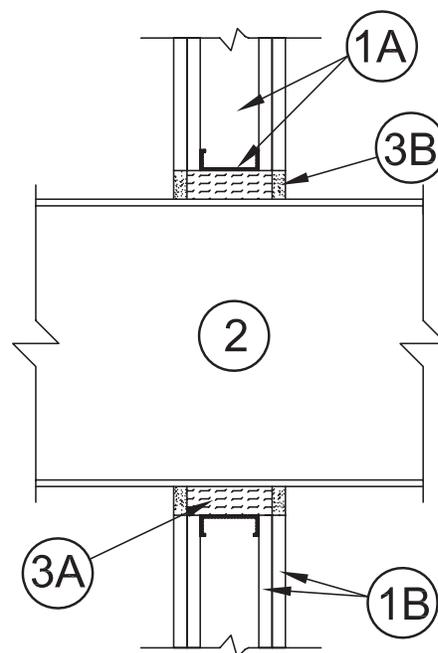
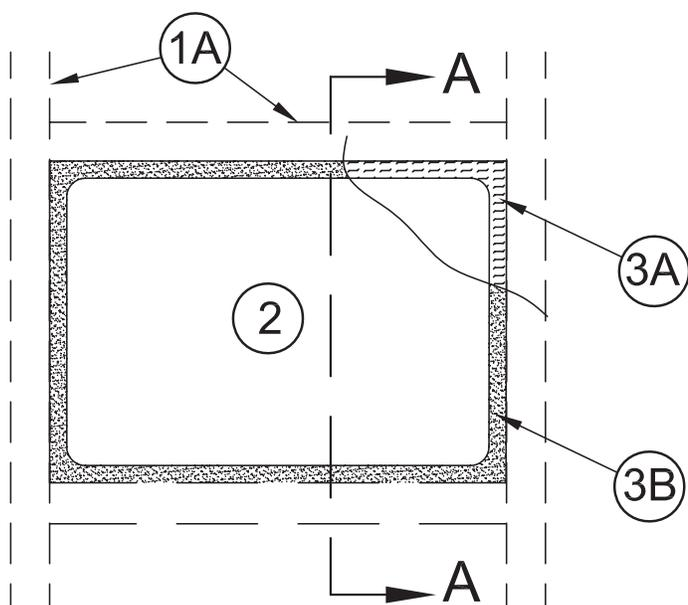

SECTION A-A

1. **Wall Assembly** — The 1 or 2 hr fire-rated gypsum board/stud wall assembly shall be constructed of the materials and in the manner specified in the individual U400 or V400 Series Wall and Partition Designs in the UL Fire Resistance Directory and shall include the following construction features:
 - A. **Studs** — Wall framing shall consist of steel channel studs. Steel studs to be min 3-5/8 in. (92 mm) wide and spaced max 24 in. (610 mm) OC. Additional framing members shall be used to completely frame around opening.
 - B. **Gypsum Board*** — Min 5/8 in. (16 mm) thick, 4 ft (121 cm) wide with square or tapered edges. The gypsum board type, thickness, number of layers and orientation shall be as specified in the individual U400 or V400 Wall and Partition Design. Max area of opening is 928 sq in. (5987 sq cm) with a max dimension of 32 in. (813 mm).

The hourly F Rating of the firestop system is equal to the hourly fire rating of the wall assembly in which it is installed. The hourly T, FT and FTH Rating of the firestop system is 0 hr when installed in 1 hr rated walls and ½ hr when installed in 2 hr rated walls.

2. **Steel Duct** — Max 27 by 30 in. (686 by 762 mm) No. 24 gauge (or heavier) steel duct to be installed either concentrically or eccentrically within the opening. The annular space shall be min 1/2 in. (19 mm) to max 1-1/2 in (38 mm). Duct to be rigidly supported on both sides of wall assembly.
3. **Firestop System** — The firestop system shall consist of the following:
 - A. **Packing Material** — Min 3-5/8 in. (92 mm) or 5 in. (127 mm) thickness of min 4 pcf (64 kg/m³) mineral wool batt insulation for 1 or 2 hr rated walls, respectively. Mineral wool to be firmly packed into opening as a permanent form and recessed from both surfaces of wall to accommodate the required thickness of fill material.
 - A1. **Forming Material*** — As an alternate to the packing material in Item 3A, nom 4 in. (102 mm) wide strips of min 1/2 in (13 mm) thick compressible mat to be stacked to a thickness greater than the width of the annular space and compression-fitted, edge-first, to fill the annular space to a min 3-5/8 in. (92 mm) or 5 in. (127 mm) depth for 1 hr and 2 hr rated walls respectively. Forming material to be recessed from both surfaces of wall as necessary to accommodate the required thickness of fill material.
 - 3M COMPANY 3M FIRE PROTECTION PRODUCTS** — Fire Barrier Packing Material
 - B. **Fill Void or Cavity Material*** — **Caulk** — Min 5/8 in. (16 mm) thickness of fill material applied within annular space, flush with both sides of wall.

3M COMPANY 3M FIRE PROTECTION PRODUCTS — FB-3000 WT, IC 15WB+ or CP 25WB+

* Indicates such products shall bear the UL or cUL Certification Mark for jurisdictions employing the UL or cUL Certification (such as Canada), respectively.

Reprinted from the Online Certifications Directory with permission from UL
 © 2014 UL LLC



System No. W-L-7222

November 10, 2014

ANSI/UL1479 (ASTM E814)
 F Ratings — 1 and 2 Hr (See Item 1)
 T Ratings — 0 and 1 Hr (See Item 1)
 L Rating At Ambient — Less Than 1 CFM/sq ft
 L Rating At 400 F — Less Than 1 CFM/sq ft

CAN/ULC S115
 F Ratings — 1 and 2 Hr (See Item 1)
 FT Ratings — 0 and 1 Hr (See Item 1)
 FH Ratings — 1 and 2 Hr (See Item 1)
 FTH Ratings — 0 and 1 Hr (See Item 1)
 L Rating At Ambient — Less Than 1 CFM/sq ft
 L Rating At 400 F — Less Than 1 CFM/sq ft

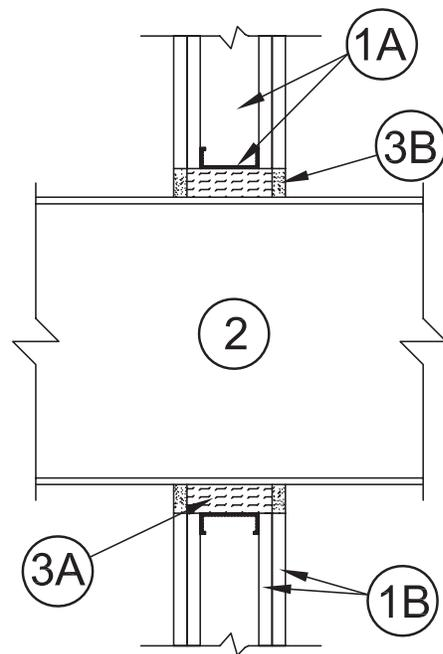
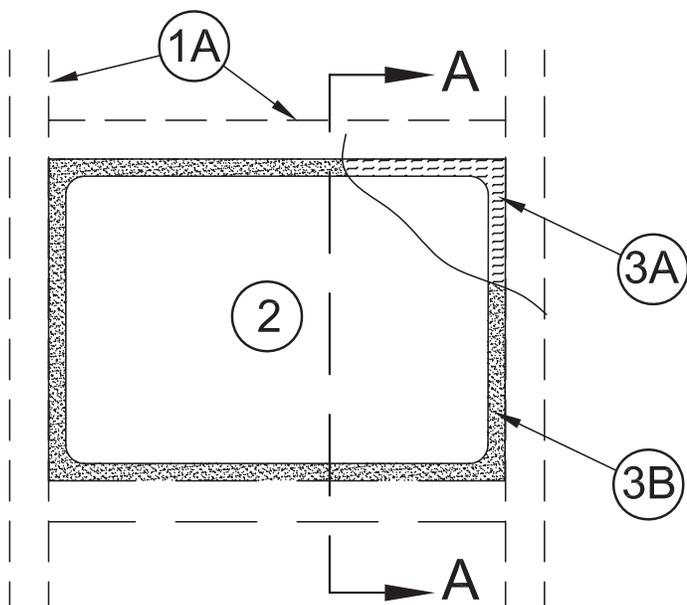

SECTION A-A

1. **Wall Assembly** — The 1 or 2 hr fire-rated gypsum board/stud wall assembly shall be constructed of the materials and in the manner specified in the individual U400 or V400 Series Wall and Partition Designs in the UL Fire Resistance Directory and shall include the following construction features:
 - A. **Studs** — Wall framing shall consist of steel channel studs. Steel studs to be min 3-5/8 in. (92 mm) wide and spaced max 24 in. (610 mm) OC. Additional framing members shall be used to completely frame around opening.
 - B. **Gypsum Board*** — Min 5/8 in. (16 mm) thick, 4 ft (121 cm) wide with square or tapered edges. The gypsum board type, thickness, number of layers and orientation shall be as specified in the individual U400 or V400 Wall and Partition Design. Max area of opening is 1024 sq in. (6606 sq cm) with a max dimension of 32 in. (813 mm).

The hourly F Rating of the firestop system is equal to the hourly fire rating of the wall assembly in which it is installed. The hourly T, FT and FTH Rating of the firestop system is 0 hr when installed in 1 hr rated walls and 1 hr when installed in 2 hr rated walls.
2. **Steel Duct** — Max 30 by 30 in. (762 by 762 mm) No. 22 gauge (or heavier) steel duct to be installed either concentrically or eccentrically within the opening. The annular space shall be min 1/2 in. (19 mm) to max 1-1/2 in (38 mm). Duct to be rigidly supported on both sides of wall assembly.
3. **Firestop System** — The firestop system shall consist of the following:
 - A. **Packing Material** — Min 3-5/8 in. (92 mm) or 5 in. (127 mm) thickness of min 4 pcf (64 kg/m³) mineral wool batt insulation for 1 or 2 hr rated walls, respectively. Mineral wool to be firmly packed into opening as a permanent form and recessed from both surfaces of wall to accommodate the required thickness of fill material.
 - A1. **Forming Material*** — As an alternate to the packing material in Item 3A, nom 4 in. (102 mm) wide strips of min 1/2 in (13 mm) thick compressible mat to be stacked to a thickness greater than the width of the annular space and compression-fitted, edge-first, to fill the annular space to a min 3-5/8 in. (92 mm) or 5 in. (127 mm) depth for 1 hr and 2 hr rated walls respectively. Forming material to be recessed from both surfaces of wall as necessary to accommodate the required thickness of fill material.

3M COMPANY 3M FIRE PROTECTION PRODUCTS — Fire Barrier Packing Material
 - B. **Fill Void or Cavity Material*** — **Caulk** — Min 5/8 in. (16 mm) thickness of fill material applied within annular space, flush with both sides of wall.

3M COMPANY 3M FIRE PROTECTION PRODUCTS — FB-3000 WT, IC 15WB+ or CP 25WB+

* Indicates such products shall bear the UL or cUL Certification Mark for jurisdictions employing the UL or cUL Certification (such as Canada), respectively.

Reprinted from the Online Certifications Directory with permission from UL
 © 2014 UL LLC



System No. W-L-7223

November 19, 2014

| ANSI/UL1479 (ASTM E814) | CAN/ULC S115 |
|---|---|
| F Ratings — 1 and 2 Hr (See Item 1) | F Ratings — 1 and 2 Hr (See Item 1) |
| T Ratings — 0 and ¼ Hr (See Item 1) | FT Ratings — 0 and ¼ Hr (See Item 1) |
| L Rating At Ambient — Less Than 1 CFM/sq ft | FH Ratings — 1 and 2 Hr (See Item 1) |
| L Rating At 400 F — Less Than 1 CFM/sq ft | FTH Ratings — 0 and ¼ Hr (See Item 1) |
| | L Rating At Ambient — Less Than 1 CFM/sq ft |
| | L Rating At 400 F — Less Than 1 CFM/sq ft |

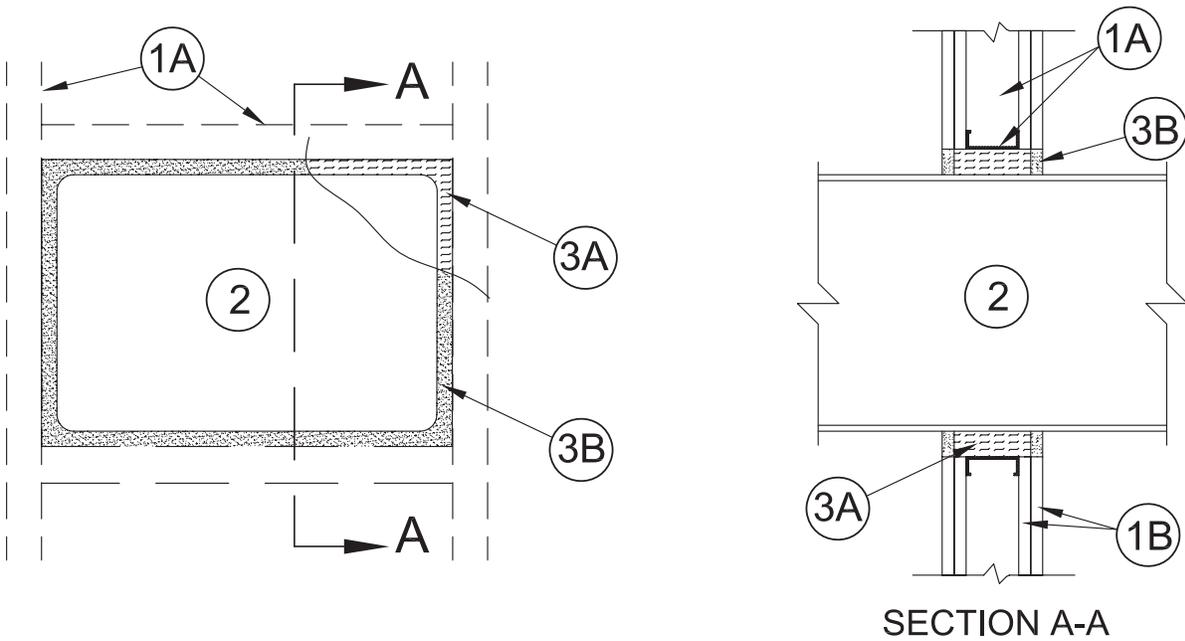

1. **Wall Assembly** — The 1 or 2 hr fire-rated gypsum board/stud wall assembly shall be constructed of the materials and in the manner specified in the individual U400 or V400 Series Wall and Partition Designs in the UL Fire Resistance Directory and shall include the following construction features:

- A. **Studs** — Wall framing shall consist of steel channel studs. Steel studs to be min 3-5/8 in. (92 mm) wide and spaced max 24 in. (610 mm) OC. Additional framing members shall be used to completely frame around opening.
- B. **Gypsum Board*** — Min 5/8 in. (16 mm) thick, 4 ft (121 cm) wide with square or tapered edges. The gypsum board type, thickness, number of layers and orientation shall be as specified in the individual U400 or V400 Wall and Partition Design. Max area of opening is 676 sq in. (4362 sq cm) with a max dimension of 26 in. (660 mm).

The hourly F Rating of the firestop system is equal to the hourly fire rating of the wall assembly in which it is installed. The hourly T, FT and FTH Rating of the firestop system is 0 hr when installed in 1 hr rated walls and ¼ hr when installed in 2 hr rated walls.

2. **Steel Duct** — Max 24 by 24 in. (610 by 610 mm) No. 22 gauge (or heavier) steel duct to be installed either concentrically or eccentrically within the opening. The annular space shall be min 1/2 in. (19 mm) to max 1-1/2 in (38 mm). Duct to be rigidly supported on both sides of wall assembly.

3. **Firestop System** — The firestop system shall consist of the following:

A. **Firestop Material** — Min 3-5/8 in. (92 mm) or 5 in. (127 mm) thickness of min 4 pcf (64 kg/m³) mineral wool batt insulation for 1 or 2 hr rated walls, respectively. Mineral wool to be firmly packed into opening as a permanent form and recessed from both surfaces of wall to accommodate the required thickness of fill material.

A1. **Forming Material*** — As an alternate to the packing material in Item 3A, nom 4 in. (102 mm) wide strips of min 1/2 in. (13 mm) thick compressible mat to be stacked to a thickness greater than the width of the annular space and compression-fitted, edge-first, to fill the annular space to a min 3-5/8 in. (92 mm) or 5 in. (127 mm) depth for 1 hr and 2 hr rated walls respectively. Forming material to be recessed from both surfaces of wall as necessary to accommodate the required thickness of fill material.

3M COMPANY 3M FIRE PROTECTION PRODUCTS — Fire Barrier Packing Material

B. **Fill Void or Cavity Material*** — Caulk — Min 5/8 in. (16 mm) thickness of fill material applied within annular space, flush with both sides of wall.

3M COMPANY 3M FIRE PROTECTION PRODUCTS — FD 150+, FB-3000 WT, IC 15WB+ or CP25WB+

* Indicates such products shall bear the UL or cUL Certification Mark for jurisdictions employing the UL or cUL Certification (such as Canada), respectively.



Through Penetrations

Misc. Mechanical

7000 Series

Gypsum

WL

System No. W-L-7225

December 15, 2014

ANSI/UL1479 (ASTM E814)
 F Rating — 2 Hr
 T Rating — 1/4 Hr
 L Rating At Ambient — Less Than 1 CFM/sq ft
 L Rating At 400 F — Less Than 1 CFM/sq ft

CAN/ULC S115
 F Rating — 2 Hr
 FT Rating — 1/4 Hr
 FH Rating — 2 Hr
 FTH Rating — 1/4 Hr
 L Rating At Ambient — Less Than 1 CFM/sq ft
 L Rating At 400 F — Less Than 1 CFM/sq ft

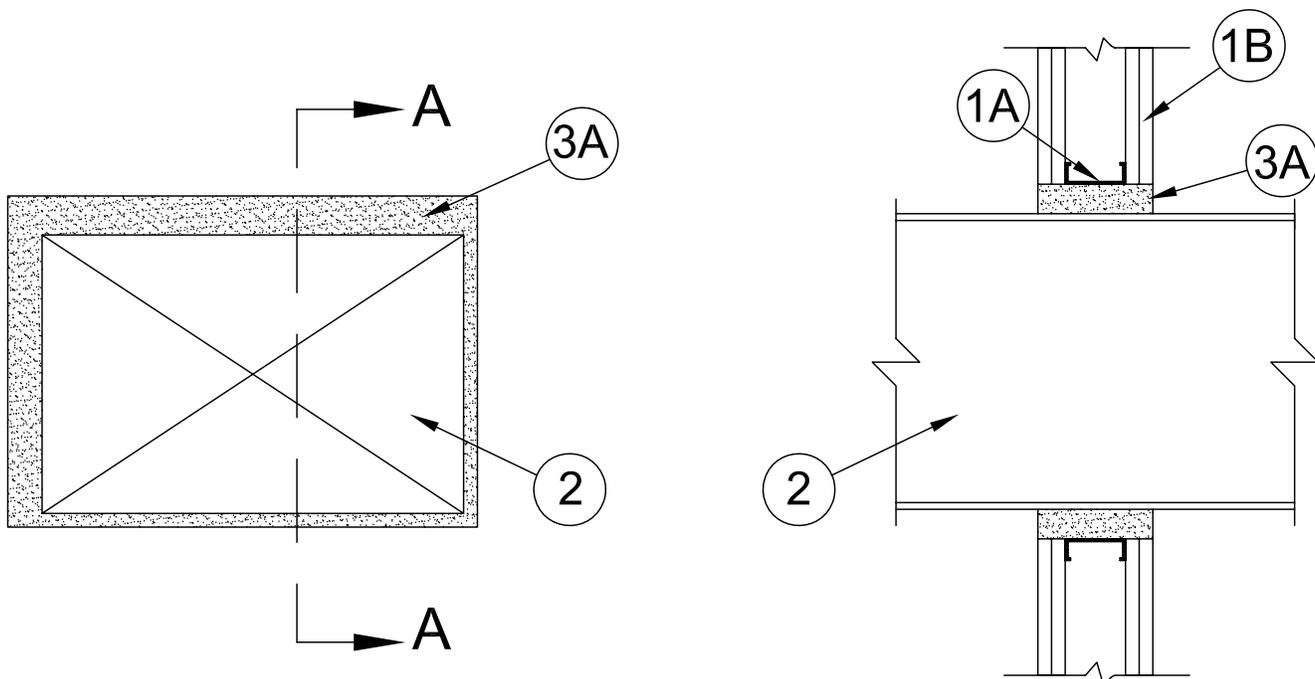

SECTION A-A

1. **Wall Assembly** — The 2 hr fire-rated gypsum board/stud wall assembly shall be constructed of the materials and in the manner specified in the individual U400 or V400 Series Wall and Partition Designs in the UL Fire Resistance Directory and shall include the following construction features:
 - A. **Studs** — Wall framing shall consist of steel channel studs. Steel studs to be min 3-5/8 in. (92 mm) wide and spaced max 24 in. (610 mm) OC. Additional framing members shall be used to completely frame around opening.
 - B. **Gypsum Board*** — Min 5/8 in. (16 mm) thick, 4 ft (121 cm) wide with square or tapered edges. The gypsum board type, thickness, number of layers and orientation shall be as specified in the individual U400 or V400 Wall and Partition Design. Max area of opening is 1024 sq in. (6606 sq cm) with a max dimension of 32 in. (813 mm).
2. **Steel Duct** — Max 30 by 30 in. (762 by 762 mm) No. 22 gauge (or heavier) steel duct to be installed either concentrically or eccentrically within the opening. The annular space shall be min 1/2 in. (19 mm) to max 1-1/2 in (38 mm). Duct to be rigidly supported on both sides of wall assembly.
3. **Firestop System** — The firestop system shall consist of the following:
 - A. **Fill, Void or Cavity Material* - Foam** — Foam to be injected into annular space to a min 6-1/8 in. (156 mm) thickness to completely fill the annular space between duct and opening to full thickness of wall, flush with both sides of wall.

3M COMPANY 3M FIRE PROTECTION PRODUCTS — Fire Barrier Rated Foam, FIP 1 - Step

* Indicates such products shall bear the UL or cUL Certification Mark for jurisdictions employing the UL or cUL Certification (such as Canada), respectively.

Reprinted from the Online Certifications Directory with permission from UL
 © 2015 UL LLC



Through Penetrations

Misc. Mechanical

7000 Series

Gypsum

WL

System No. W-L-7226

March 13, 2015

ANSI/UL1479 (ASTM E814)
 F Rating — 2 Hr
 T Rating — 1/2 Hr
 L Rating At Ambient — Less Than 1 CFM/sq ft
 L Rating At 400 F — Less Than 1 CFM/sq ft

CAN/ULC S115
 F Rating — 2 Hr
 FT Rating — 1/2 Hr
 FH Rating — 2 Hr
 FTH Rating — 1/2 Hr
 L Rating At Ambient — Less Than 1 CFM/sq ft
 L Rating At 400 F — Less Than 1 CFM/sq ft

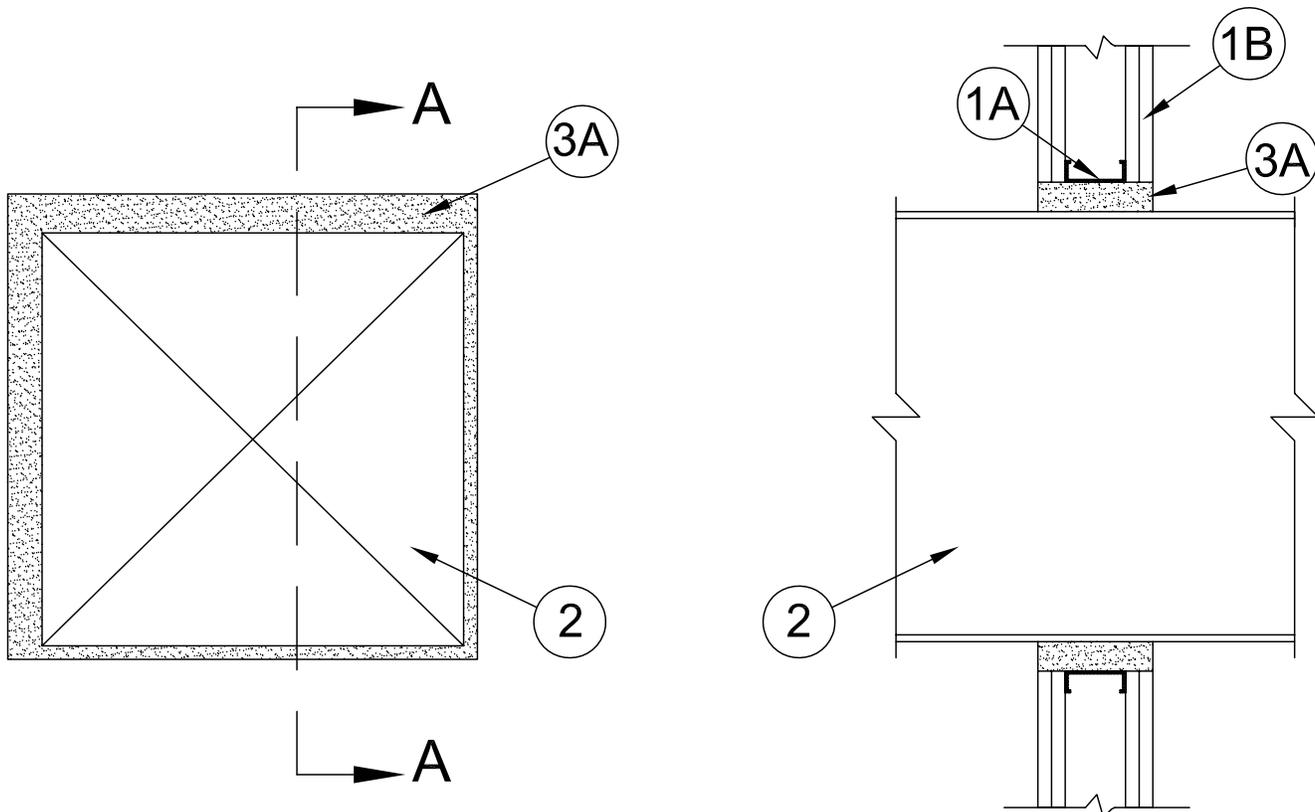

1. **Wall Assembly** — The 2 hr fire-rated gypsum board/ stud wall assembly shall be constructed of the materials and in the manner specified in the individual U400, V400 or W400 Series Wall and Partition Designs in the UL Fire Resistance Directory and shall include the following construction features:
 - A. **Studs** — Wall framing shall consist of steel channel studs. Steel studs to be min 3-5/8 in. (92 mm) wide and spaced max 24 in. (610 mm) OC. Additional framing members shall be used to completely frame around opening.
 - B. **Gypsum Board*** — Min 5/8 in. (16 mm) thick, 4 ft (121 cm) wide with square or tapered edges. The gypsum board type, thickness, number of layers and orientation shall be as specified in the individual Wall and Partition Design. Max area of opening is 928 sq in. (5987 sq cm) with a max dimension of 32 in. (813 mm).
2. **Steel Duct** — Max 27 by 30 in. (686 by 762 mm) No. 24 gauge (or heavier) steel duct to be installed either concentrically or eccentrically within the opening. The annular space shall be min 1/2 in. (13 mm) to max 1-1/2 in (38 mm). Duct to be rigidly supported on both sides of wall assembly.
3. **Firestop System** — The firestop system shall consist of the following:
 - A. **Fill, Void or Cavity Material* - Foam** — Foam to be injected into annular space to a min 6-1/8 in. (156 mm) thickness to completely fill the annular space between duct and opening to full thickness of wall, flush with both sides of wall.

3M COMPANY 3M FIRE PROTECTION PRODUCTS — Fire Barrier Rated Foam, FIP 1 - Step

* Indicates such products shall bear the UL or cUL Certification Mark for jurisdictions employing the UL or cUL Certification (such as Canada), respectively.

Reprinted from the Online Certifications Directory with permission from UL
 © 2015 UL LLC



Through Penetrations

Misc. Mechanical

7000 Series

Gypsum

WL

System No. W-L-7227

March 26, 2015

ANSI/UL1479 (ASTM E814)
 F Rating — 2 Hr
 T Rating — 0 Hr
 L Rating At Ambient — Less Than 1 CFM/sq ft
 L Rating At 400 F — Less Than 1 CFM/sq ft

CAN/ULC S115
 F Rating — 2 Hr
 FT Rating — 0 Hr
 FH Rating — 2 Hr
 FTH Rating — 0 Hr
 L Rating At Ambient — Less Than 1 CFM/sq ft
 L Rating At 400 F — Less Than 1 CFM/sq ft

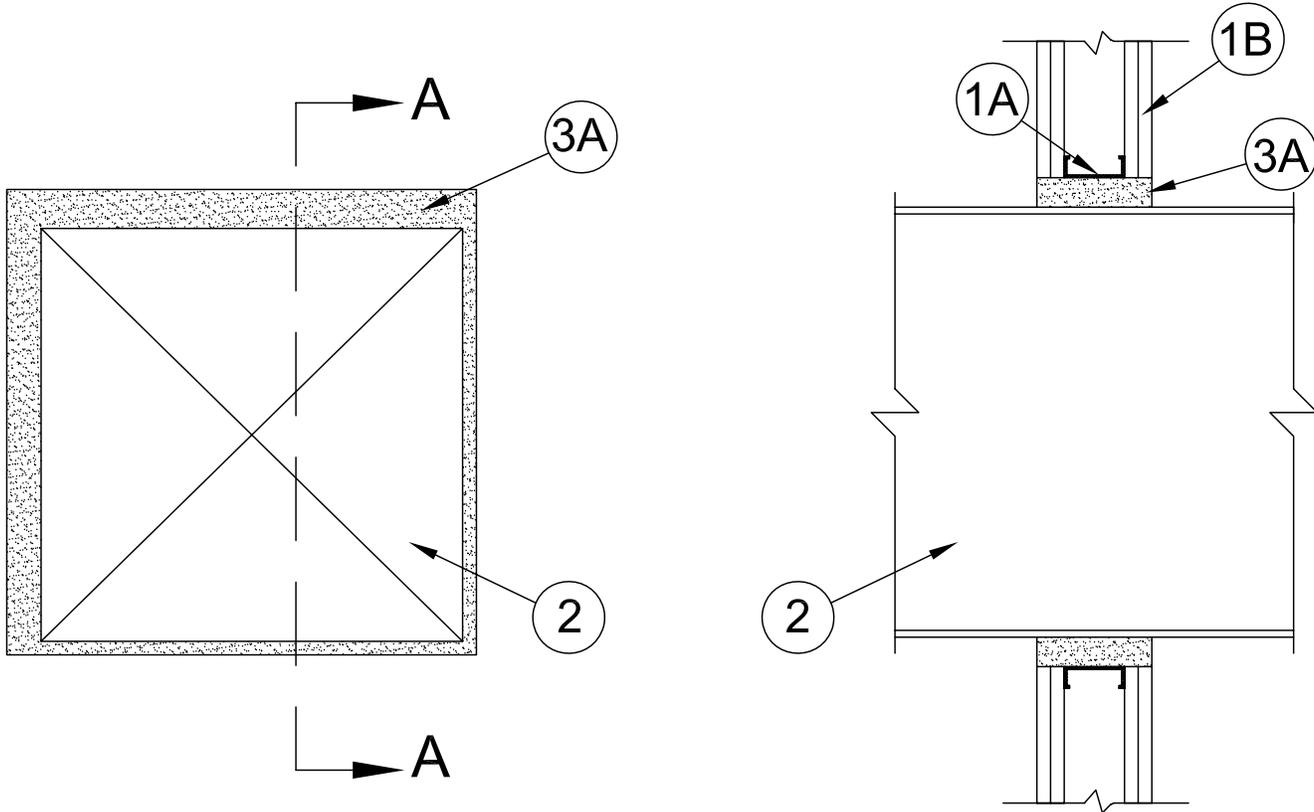

1. **Wall Assembly** — The 2 hr fire-rated gypsum board/ stud wall assembly shall be constructed of the materials and in the manner specified in the individual U400, V400 or W400 Series Wall and Partition Designs in the UL Fire Resistance Directory and shall include the following construction features:
 - A. **Studs** — Wall framing shall consist of steel channel studs. Steel studs to be min 3-5/8 in. (92 mm) wide and spaced max 24 in. (610 mm) OC. Additional framing members shall be used to completely frame around opening.
 - B. **Gypsum Board*** — Min 5/8 in. (16 mm) thick, 4 ft (121 cm) wide with square or tapered edges. The gypsum board type, thickness, number of layers and orientation shall be as specified in the individual Wall and Partition Design. Max area of opening is 676 sq in. (4361 sq cm) with a max dimension of 26 in. (660 mm).
2. **Steel Duct** — Max 24 by 24 in. (610 by 610 mm) No. 26 gauge (or heavier) steel duct to be installed either concentrically or eccentrically within the opening. The annular space shall be min 1/2 in. (13 mm) to max 1-1/2 in (38 mm). Duct to be rigidly supported on both sides of wall assembly.
3. **Firestop System** — The firestop system shall consist of the following:
 - A. **Fill, Void or Cavity Material* - Foam** — Foam to be injected into annular space to a min 6-1/8 in. (156 mm) thickness to completely fill the annular space between duct and opening to full thickness of wall, flush with both sides of wall.

3M COMPANY 3M FIRE PROTECTION PRODUCTS — Fire Barrier Rated Foam, FIP 1 - Step

* Indicates such products shall bear the UL or cUL Certification Mark for jurisdictions employing the UL or cUL Certification (such as Canada), respectively.

Reprinted from the Online Certifications Directory with permission from UL
 © 2015 UL LLC



Through Penetrations

Misc. Mechanical

7000 Series

Gypsum

WL

System No. W-L-7228

April 01, 2015

ANSI/UL1479 (ASTM E814)
 F Rating — 2 Hr
 T Rating — 1/4 Hr
 L Rating At Ambient — Less Than 1 CFM/sq ft
 L Rating At 400 F — Less Than 1 CFM/sq ft

CAN/ULC S115
 F Rating — 2 Hr
 FT Rating — 1/4 Hr
 FH Rating — 2 Hr
 FTH Rating — 1/4 Hr
 L Rating At Ambient — Less Than 1 CFM/sq ft
 L Rating At 400 F — Less Than 1 CFM/sq ft

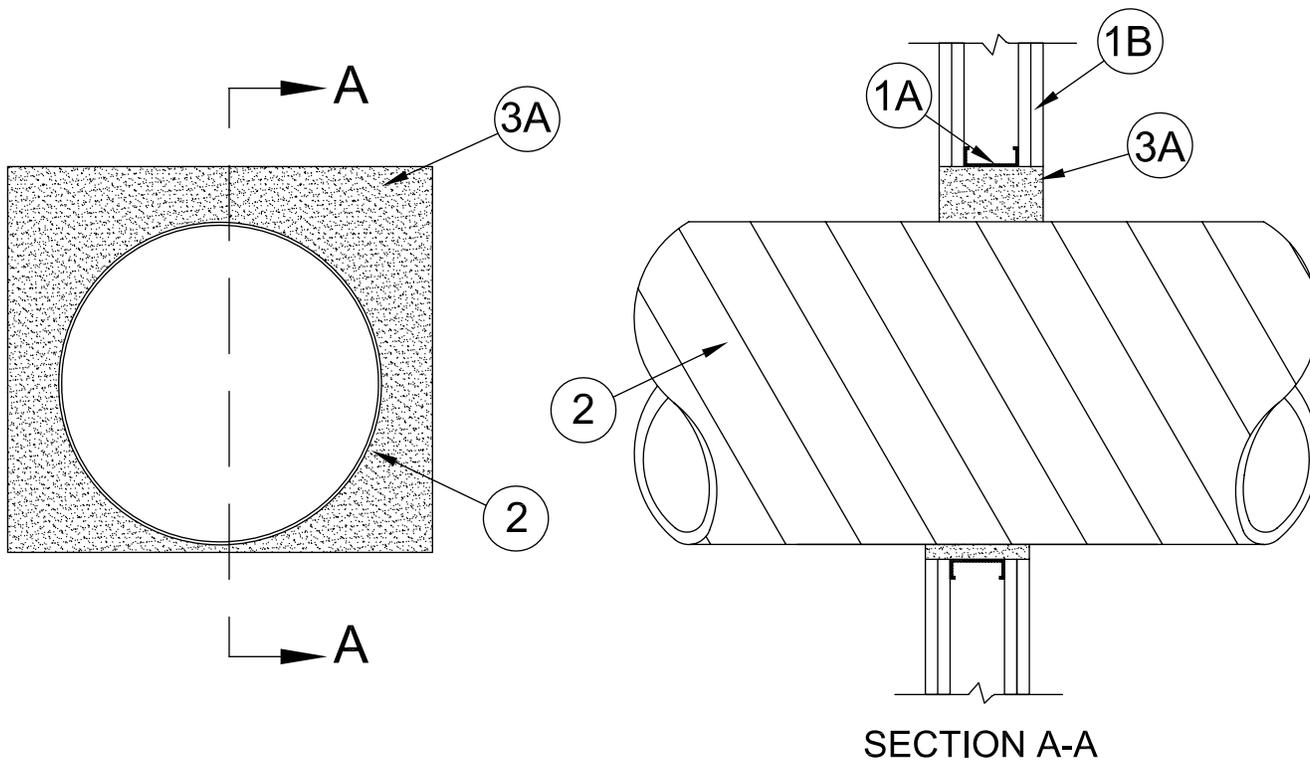

SECTION A-A

1. **Wall Assembly** — The 2 hr fire-rated gypsum board/ stud wall assembly shall be constructed of the materials and in the manner specified in the individual U400, V400 or W400 Series Wall and Partition Designs in the UL Fire Resistance Directory and shall include the following construction features:
 - A. **Studs** — Wall framing shall consist of steel channel studs. Steel studs to be min 3-5/8 in. (92 mm) wide and spaced max 24 in. (610 mm) OC. Additional framing members shall be used to completely frame around opening.
 - B. **Gypsum Board*** — Min 5/8 in. (16 mm) thick, 4 ft (121 cm) wide with square or tapered edges. The gypsum board type, thickness, number of layers and orientation shall be as specified in the individual Wall and Partition Design. Max area of opening is 1521 sq in. (0.981 sq m) with a max dimension of 39 in. (991 mm).
2. **Steel Duct** — Nom 36 in. (914 mm) (or smaller) No. 22 gauge (or heavier) spiral steel duct to be installed either concentrically or eccentrically within the opening. The annular space shall be min 1/2 in. (13 mm) to max 9 1/2 in (241 mm). Duct to be rigidly supported on both sides of wall assembly.
3. **Firestop System** — The firestop system shall consist of the following:
 - A. **Fill, Void or Cavity Material* - Foam** —Foam to be injected into annular space to a min 6-1/8 in. (156 mm) thickness to completely fill the annular space between duct and opening to full thickness of wall, flush with both sides of wall.

3M COMPANY 3M FIRE PROTECTION PRODUCTS —Fire Barrier Rated Foam, FIP 1 - Step

* Indicates such products shall bear the UL or cUL Certification Mark for jurisdictions employing the UL or cUL Certification (such as Canada), respectively.

Reprinted from the Online Certifications Directory with permission from UL

© 2015 UL LLC



Through Penetrations

Misc. Mechanical

7000 Series

Gypsum

WL

System No. W-L-7242

February 12, 2016

| ANSI/UL1479 (ASTM E814) | CAN/ULC S115 |
|--|---|
| F Ratings - 1 and 2 Hr (See Items 1 and 2) | F Ratings - 1 and 2 Hr (See Items 1 and 2) |
| T Rating - 0 Hr | FT Rating - 0 Hr |
| | FH Ratings - 1 and 2 Hr (See Items 1 and 2) |
| | FTH Rating - 0 Hr |

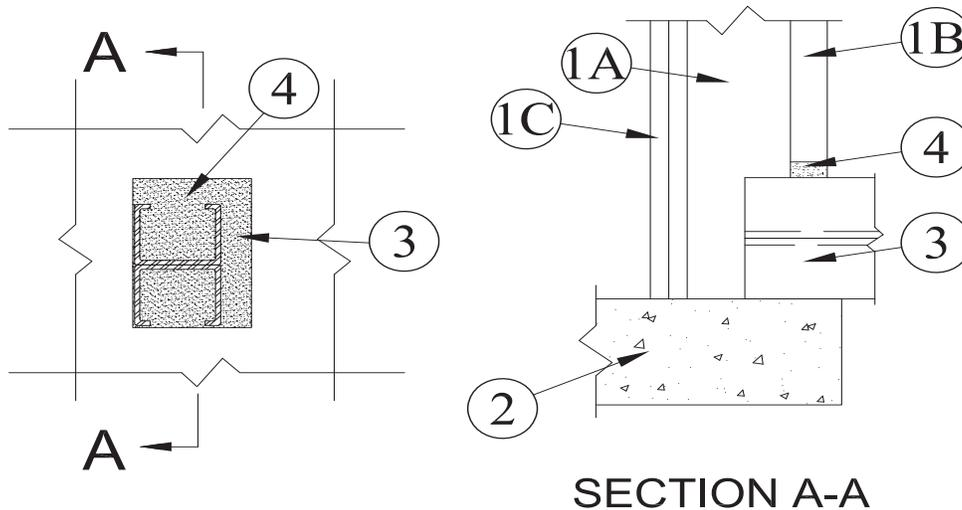

1. **Wall Assembly** — The 1 or 2 hr fire rated shaft wall assembly shall be constructed of the materials and in the manner specified in the individual U400, V400 or W400 Series Wall and Partition Designs in the UL Fire Resistance Directory and shall include the following construction features:

- A. **Steel Studs** — C-H shaped studs, 2-1/2 in. (64 mm) wide by 1-1/2 in. (38 mm) deep, spaced 24 in. (610 mm) OC.
- B. **Gypsum Board*** — 1 in. (25 mm) thick gypsum board liner panels, supplied in nom 24 in. (610 mm) widths as specified in the individual Wall and Partition Design. Max area of opening is 8 in. (52 sq cm) with a max dimension of 4 in. (102 mm). The opening cutout shall follow the contour of the penetrant when steel angle or steel channel is used.
- C. **Gypsum Board*** — One or two layers of 5/8 in. (16 mm) thick gypsum board for 1 or 2 Hr rated assemblies, respectively, as specified in the individual Wall and Partition Design.

1A. **Alternate Wall Assembly** — (Not shown) As an alternate to the shaft wall described above, the 1 or 2 Hr fire rated wall assembly shall be constructed of the materials and in the manner specified in the individual U400, V400 or W400 Series Wall and Partition Designs in the UL Fire Resistance Directory and shall include the following construction features:

- A. **Studs** — Wall framing shall consist of min 2-1/2 in. (64 mm) steel channel studs spaced max 24 in. (610 mm) OC.
- B. **Gypsum Board*** — Thickness, type, number of layers and fasteners as required in the individual Wall and Partition Design. Max area of opening is 8.6 sq in. (55 sq cm) with a max dimension of 6-7/8 in. (175 mm). The opening cutout shall follow the contour of the penetrant when steel angle or steel channel is used.

The hourly F and FH Ratings of the firestop system are equal to the hourly rating of the wall.

2. **Floor Assembly** — Min 2-1/2 and 4-1/2 in. (64 or 114 mm) thick reinforced lightweight or normal weight (100-150 pcf or 1600-2400 kg/m³) concrete for 1 and 2 hr rated assemblies, respectively. Floor may also be constructed of any min 6 in. (152 mm) UL Classified Precast Concrete Units*.

See **Precast Concrete Units** (CFTV) category in the Fire Resistance Directory for names of manufacturers.

3. **Penetrants** — One metallic strut, steel angle or steel channel to be installed within the firestop system. An annular space of min 0 in. (point contact) to max 7/8 in. (22 mm) is required within the firestop system. Penetrant to terminate within the stud cavity and shall be secured to floor assembly within 2 in. (51 mm) of the fill material (Item 4) on either side of the fill material with at least one min 1/4 in. (6 mm) diam by min 1-1/4 in. (32 mm) long steel masonry anchor in conjunction with steel washers. The following types and sizes of metallic struts, angles or channels may be used:

- A. **Steel Strut** — Max 1-5/8 by 1-5/8 in. (41 by 41 mm) channel strut formed from min 0.105 in. (2.7 mm) thick galv or painted steel.
- B. **Steel Strut** — Max 3-1/4 by 1-5/8 in. (83 by 41 mm) H strut formed from min 0.105 in. (2.7 mm) thick galv or painted steel.
- C. **Steel Angle or Channel** — Max 2 by 2 in. (51 by 51 mm) by min 1/8 in. (3.2 mm) thick or max 3 by 3 in. (76 by 76 mm) by min 1/4 in. (6 mm) thick steel angle or C channel.

4. **Fill, Void or Cavity Material*** — Sealant — Fill material to be installed to completely fill the annular space within and around the penetrant, flush with the surface of the wall. The thickness of the fill material shall be the thickness of the gypsum board(s) in which it is installed. An additional min 1/2 in. (13 mm) diam bead of sealant to be installed at the point contact location at the penetrant/gypsum board interface.

3M COMPANY 3M FIRE PROTECTION PRODUCTS — CP 25WB+ or FB-3000 WT

* Indicates such products shall bear the UL or cUL Certification Mark for jurisdictions employing the UL or cUL Certification (such as Canada), respectively.



System No. W-L-7243

March 23, 2016

| ANSI/UL1479 (ASTM E814) | CAN/ULC S115 |
|-------------------------------------|--------------------------------------|
| F Ratings - 1 and 2 Hr (See Item 1) | F Ratings - 1 and 2 Hr (See Item 1) |
| T Rating - 0 Hr | FT Rating - 0 Hr |
| | FH Ratings - 1 and 2 Hr (See Item 1) |
| | FTH Rating - 0 Hr |

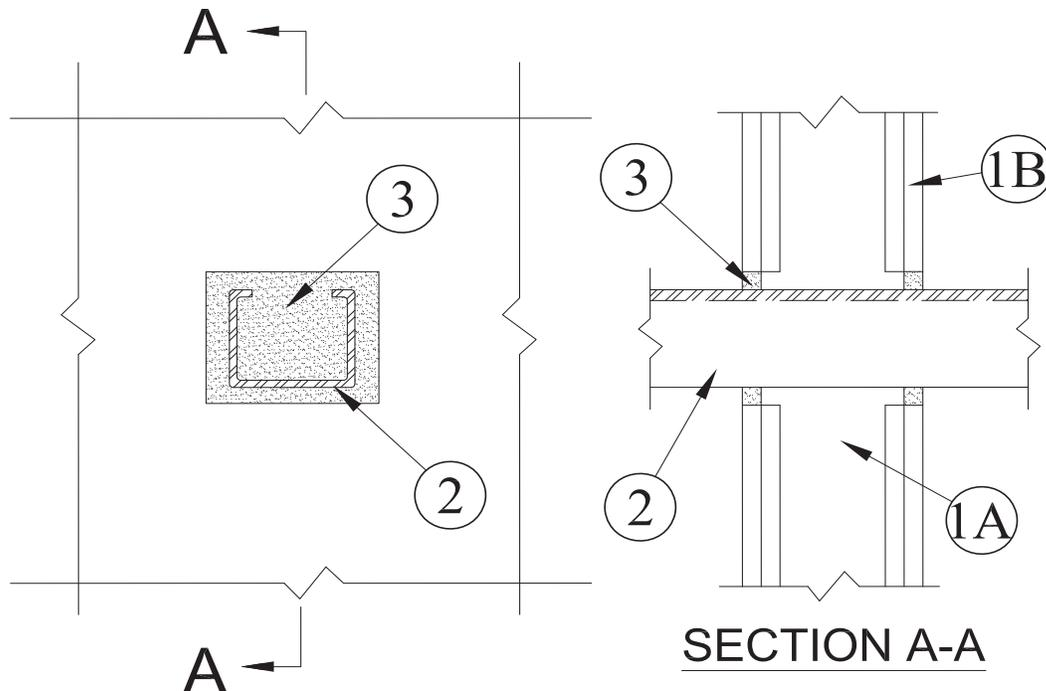

1. **Wall Assembly** — The 1 or 2 hr fire-rated gypsum board/stud wall assembly shall be constructed of the materials and in the manner specified in the individual U300, U400, V400 or W400 Series Wall and Partition Designs in the UL Fire Resistance Directory and shall include the following construction features:

- A. **Studs** — Wall framing may consist of either wood studs or steel channel studs. Wood studs to consist of nom 2 by 4 in. (51 by 102 mm) lumber spaced max 16 in. (406 mm) OC. Steel studs to be min 2-1/2 in. (64 mm) wide and spaced max 24 in. (610 mm) OC.
- B. **Gypsum Board*** — One or two layers of gypsum board, as specified in the individual Wall and Partition Design. Max area of rectangular opening is 15 sq in. (96 cm²) with max dimension of 5 in. (127 mm). Max diam of circular opening is 3 in. (76 mm). The opening cutout shall follow the contour of the penetrant when steel angle is used.

The F and FH Ratings of the firestop system are equal to the hourly fire rating of the wall assembly.

2. **Through Penetrants** — One metallic strut, cable, rod or angle service support to be installed within the firestop system. An annular space of min 1/8 in. (3 mm) to max 7/8 in. (22 mm) is required within the firestop system. The penetrant shall be rigidly supported on both sides of floor or wall assembly. The following types and sizes of metallic strut, cable, rod or angle service support may be used:

- A. **Steel Strut** — Max 1-5/8 by 1-5/8 in. (41 by 41 mm) channel strut formed from min 0.105 in. (2.7 mm) thick galv or painted steel.
- B. **Steel Strut** — Max 3-1/4 by 1-5/8 in. (83 by 41 mm) H strut formed from min 0.105 in. (2.7 mm) thick galv or painted steel.
- C. **Cable** — Max 3/8 in. (9.5 mm) diam unjacketed galv steel cable.
- D. **Threaded Rod** — Max 1 in. (25 mm) diam galv steel threaded rod.
- E. **Steel Angle** — 2 by 2 by 1/8 in. (51 by 51 by 3 mm) thick steel angle.

3. **Firestop System** — The firestop system shall consist of the following:

- A. **Fill, Void or Cavity Material* — Sealant** — Min 5/8 in. (16 mm) thickness of fill material applied within the annulus and within the channel struts, flush with both surfaces of wall.

3M COMPANY 3M FIRE PROTECTION PRODUCTS — IC 15 WB+ Sealant, CP25WB+ Sealant or FB-3000 WT Sealant

* Indicates such products shall bear the UL or cUL Certification Mark for jurisdictions employing the UL or cUL Certification (such as Canada), respectively.



Through Penetrations

Misc. Mechanical

7000 Series

Gypsum

WL



UL System No. W-L-7276
XHEZ - Through-penetration Firestop Systems
XHEZ7 - Through-penetration Firestop Systems Certified for Canada

June 11, 2018

| ANSI/UL1479 (ASTM E814) | CAN/ULC S115 |
|-------------------------|-------------------|
| F Rating — 2 Hr | F Rating — 2 Hr |
| T Rating — 0 Hr | FT Rating — 0 Hr |
| | FH Rating — 2 Hr |
| | FTH Rating — 0 Hr |

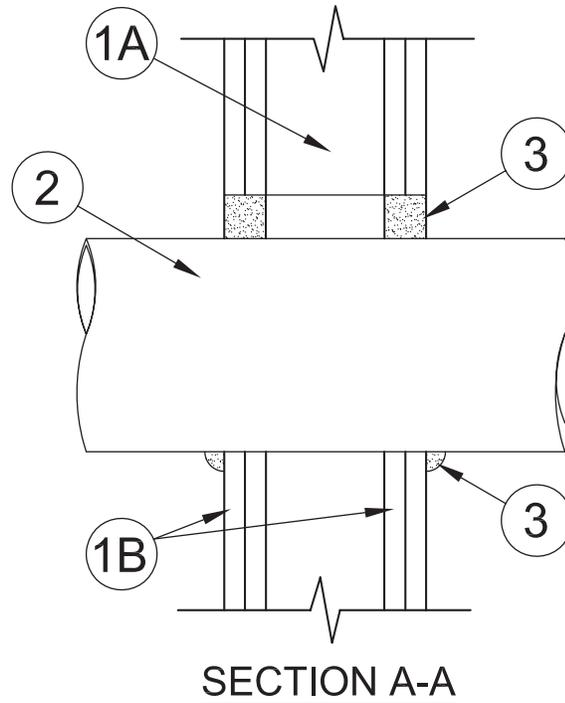
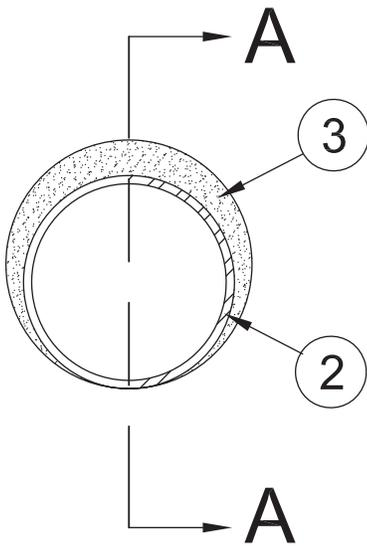

- 1. Wall Assembly** – The 2 hr fire-rated gypsum board/stud wall assembly shall be constructed of the materials and in the manner specified in the individual U400, V400 or W400 Series Wall and Partition Designs in the UL Fire Resistance Directory and shall include the following construction features:
 - A. Studs** – Wall framing shall consist of steel channel studs. Steel studs to be min 3-5/8 in. (92 mm) wide and spaced max 24 in. (610 mm) OC.
 - B. Gypsum Board*** – Min 5/8 in. (16 mm) thick, 4 ft (121 cm) wide with square or tapered edges. The gypsum board type, thickness, number of layers and orientation shall be as specified in the individual U400, V400 or W400 Wall and Partition Design. Max diam of opening is 22-1/2 in. (572 mm).
- 2. Steel Duct** – Max 20 in. (508 mm) No. 26 gauge (or heavier) spiral wound steel duct or max 12 in. (305 mm) No. 28 gauge (or heavier) steel duct to be installed either concentrically or eccentrically within the opening. The annular space shall be min 0 in. to max 2-1/2 in (64 mm). Duct to be rigidly supported on both sides of wall assembly.
- 3. Fill Void or Cavity Material* — Caulk** – Min 1-1/4 in. (32 mm) thickness of fill material applied within annular space, flush with both sides of wall. At point contact location, min 1/4 in. (6 mm) diam bead of caulk applied at the duct/gypsum board interface.

3M COMPANY 3M FIRE PROTECTION PRODUCTS – FD 150+, FB-3000 WT, IC 15WB+ or CP 25WB+

Through Penetrations
Misc. Mechanical
7000 Series
Gypsum
WL



*Indicates such products shall bear the UL or cUL Certification Mark for jurisdictions employing the UL or cUL Certification (such as Canada), respectively.

Reprinted from the Online Certifications Directory with permission from UL©

3M Industrial Adhesives and Tapes
Fire Protection Products
 3M Center, Building 230-B-S-37
 St. Paul, MN 55144-1000

Misc. Mechanical • Wood Frame Floor/Ceiling

| 3M UL Systems | "F" Rating | 3M Product | Through Penetrant Details |
|---------------|------------|--|--|
| F-C-7001 | 1 | 3M™ Fire Barrier Sealant CP 25WB+ 3M™ Fire Barrier Water Tight Sealant 3000 WT | 10" diameter steel 28 gauge, 4" diameter steel 30 gauge. Max diam of opening 11". Point contact to max 1" annular. Concentric or eccentric installation. Chase wall optional. 1 hour F Rating. Also known as FC7001. |
| F-C-7017 | 1 | 3M™ Fire Barrier Sealant CP 25WB+ 3M™ Fire Barrier Sealant IC 15WB+ 3M™ Fire Barrier Sealant FD 150+ 3M™ Fire Barrier Water Tight Sealant 3000 WT | 4" diameter 30 gauge steel. Max diam of opening 5". Concentric or eccentric installation. Point contact to max 2" annular. Chase wall optional. 1 hour F Rating. Also referred as FC7017. |
| F-C-7022 | 1 | 3M™ Fire Barrier Sealant CP 25WB+ 3M™ Fire Barrier Sealant IC 15WB+ 3M™ Fire Barrier Water Tight Sealant 3000 WT | 10" 24 gauge steel, 5" 30 gauge steel. Max diam of opening 11". Concentric or eccentric installation. Point contact to max 1" annular. 1 hour F Rating. Also known as FC7022. |
| F-C-7054 | 1 | 3M™ Fire Barrier Duct Wrap 615+ 3M™ Fire Barrier Duct Wrap 615 3M™ Fire Barrier Water Tight Sealant 1003 SL | Steel HVAC duct wrapped with Fire Barrier Duct Wrap 615 or 615+ penetrating a 1 hour rated floor/ceiling assembly. |
| F-E-7001 | 1 | 3M™ Fire Barrier Sealant CP 25WB+ 3M™ Fire Barrier Sealant IC 15WB+ 3M™ Fire Barrier Water Tight Sealant 3000 WT | 4" 30 gauge steel duct, 10" 28 gauge steel duct. Diam of opening 1" larger than duct. Concentric or eccentric installation. Point contact to max 1" annular. 1 hour F Rating. Also referred as FE7001. |
| F-E-7005 | 1 | 3M™ Fire Barrier Sealant CP 25WB+ 3M™ Fire Barrier Sealant IC 15WB+ 3M™ Fire Barrier Water Tight Sealant 3000 WT | 10" 24 gauge steel duct, 5" 30 gauge steel duct. Max diam of opening 11". Concentric or eccentric installation. Point contact to max 1" annular. 1 hour F rating. Also referred as FE7005. |

System No. F-C-7001

September 03, 2004
(Formerly System No. 169)
F Rating – 1 Hr
T Rating – 1/2 Hr

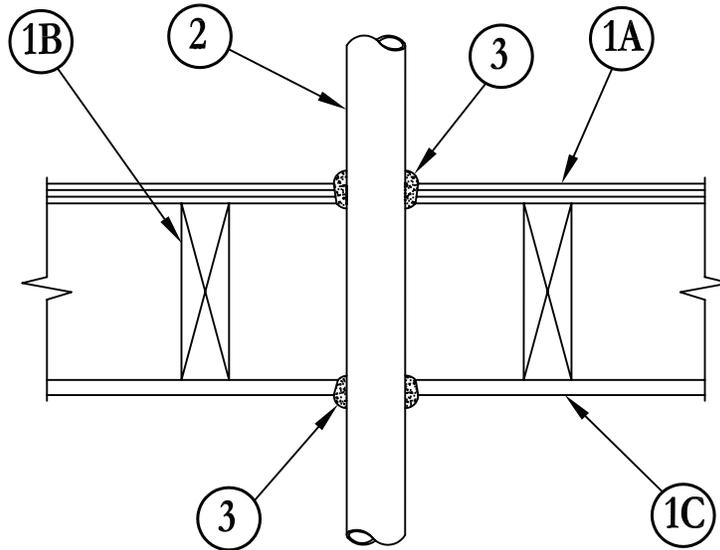

1. **Floor-Ceiling Assembly** – The 1 hr fire-rated wood joist floor-ceiling assembly shall be constructed of the materials and in the manner specified in the individual L500 Series Floor-Ceiling Designs in the UL Fire Resistance Directory, as summarized below:
 - A. **Flooring System** – Lumber or plywood subfloor with finish floor of lumber, plywood or **Floor Topping Mixture*** as specified in the individual Floor-Ceiling Design. Max diam of opening is 11 in.
 - B. **Wood Joists** – Nom 2 by 10 in. lumber joists spaced 16 in. OC with nom 1 by 3 in. lumber bridging and with ends firestopped.
 - C. **Gypsum Board*** – Nom 4 ft wide by 5/8 in. thick as specified in the individual Floor-Ceiling Design. Max diam of opening is 11 in.
- 1.1 **Chase Wall (Optional, not shown)** – The through penetrants (Item No. 2) shall be routed through a 1 hr fire-rated single, double or staggered wood stud/gypsum wallboard chase wall constructed of the materials and in the manner specified in the individual U300 Series Wall and Partition Designs in the UL Fire Resistance Directory and shall include the following construction features:
 - A. **Studs** – Nom 2 by 6 in. or double nom 2 by 4 in. lumber studs.
 - B. **Sole Plate** – Nom 2 by 6 in. or parallel 2 by 4 in. lumber plates, tightly butted.
 - C. **Top Plate** – The double top plate shall consist of two nom 2 by 6 in. or two sets of parallel 2 by 4 in. lumber plates, tightly butted. Max diam of opening is 5 in.
 - D. **Gypsum Board*** – Thickness, type, number of layers and fasteners shall be as specified in individual Wall and Partition Design.
2. **Steel Vent Duct** – Nom 4 in. diam (or smaller) No. 30 gauge (or heavier) galv steel vent duct or nom 10 in. diam (or smaller) No. 28 gauge (or Heavier) galv steel vent duct. Diam of openings to be max 1 in. larger than outside diam of duct. Duct to be installed approx midway between wood joists and installed either concentrically or eccentrically in opening. The annular space between the duct and the periphery of opening shall be min 0 in. (point contact) to max 1 in. Duct to be rigidly supported on both sides of floor-ceiling assembly.
3. **Fill, Void or Cavity Materials* – Caulk or Sealant** – Min 3/4 in. thickness of fill material applied within the annulus, flush with top surface of floor or sole plate. Min 5/8 in. thickness of fill material applied within the annulus, flush with bottom surface of ceiling or top plate. An additional min 1/4 in. crown of fill material applied to perimeter of duct at its egress from the top of flooring and underside of ceiling or from top of sole plate and underside of top plate.

3M COMPANY – CP 25WB+ caulk or FB-3000 WT sealant

*Bearing the UL Classification Marking

Reprinted from the Online Certifications Directory with permission from Underwriters Laboratories Inc.
Copyright © 2010 Underwriters Laboratories Inc.®



System No. F-C-7017

May 19, 2005

F Rating - 1 Hr

T Rating -1 Hr

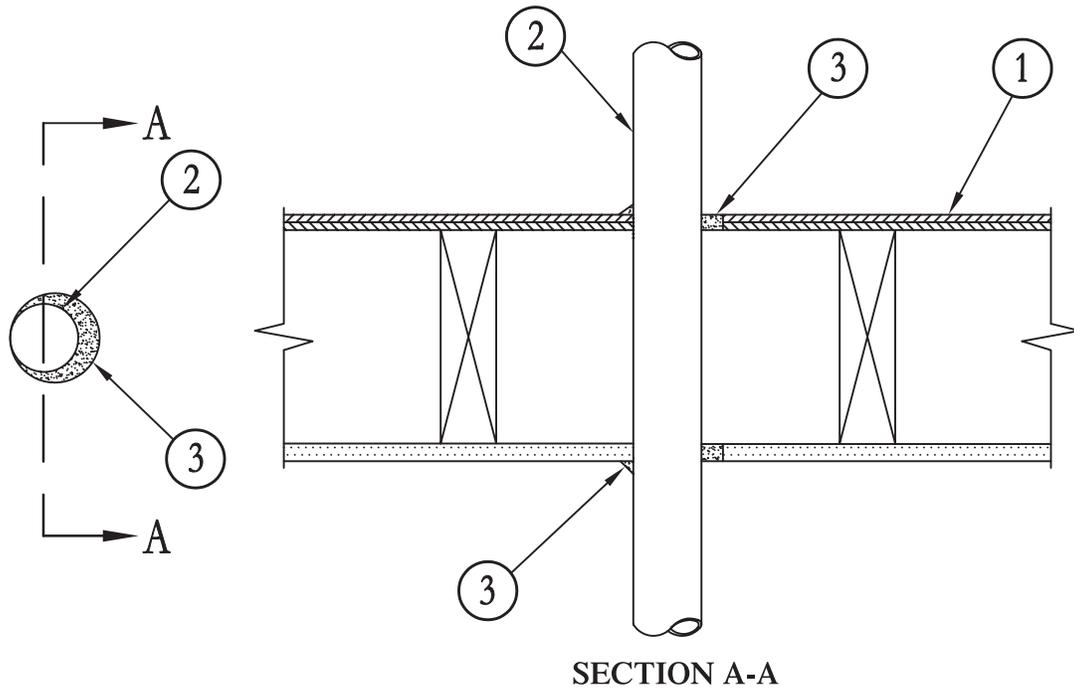

SECTION A-A

1. **Floor-Ceiling Assembly** – The 1 hr fire-rated solid or trussed lumber joist floor-ceiling assembly shall be constructed of the materials and in the manner specified in the individual L500 Series Floor-Ceiling Designs in the UL Fire Resistance Directory. The general construction details of the floor-ceiling assembly are summarized below:
 - A. **Flooring System** – Lumber or plywood subfloor with finish floor of lumber, plywood or **Floor Topping Mixture*** as specified in the individual Floor-Ceiling Design. Max diam of opening is 5 in. (127 mm).
 - B. **Wood Joists** – Nom 10 in. (254 mm) deep (or deeper) lumber, steel or combination lumber and steel joists, trusses or **Structural Wood Members*** with bridging as required and with ends firestopped.
 - C. **Gypsum Board*** – Nom 4 ft (122 cm) wide by 5/8 in. (16 mm) thick as specified in the individual Floor-Ceiling Design. Gypsum board secured to wood joists or furring channels as specified in the individual Floor-Ceiling Design. Max of opening is 6 in. by 5-1/2 in. (152 mm by 140 mm).
- 1.1 **Chase Wall** (Optional, not shown) – The duct (Item 2) may be routed through a fire-rated single, double or staggered wood stud/gypsum board chase wall having a fire rating consistent with that of the floor-ceiling assembly. The chase wall shall be constructed of the materials and in the manner specified in the individual U300 Series Wall and Partition Designs in the UL Fire Resistance Directory and shall include the following construction features:
 - A. **Studs** – Nom 2 in. by 6 in. (51 mm by 152 mm) or double nom 2 in. by 4 in. (51 mm by 102 mm) lumber studs.
 - B. **Sole Plate** – Nom 2 in. by 6 in. (51 mm by 152 mm) or parallel 2 in. by 4 in. (51 mm by 102 mm) lumber plates, tightly butted.
 - C. **Top Plate** – The double top plate shall consist of two nom 2 in. by 6 in. (51 mm by 152 mm) or two sets of parallel 2 in. by 4 in. (51 mm by 102 mm) lumber plates, tightly butted. Max of opening is 6 in. by 5-1/2 in. (152 mm by 140 mm)
 - D. **Gypsum Board*** – Thickness, type, number of layers and fasteners shall be as specified in individual Wall and Partition Design.
2. **Steel Duct** – Nom 4 in. (102 mm) diam (or Smaller) No. 30 gauge (or heavier) galv steel duct to be installed eccentrically or concentrically within the firestop system. The annular space between the duct and the periphery of opening shall be min 0 in. (0 mm) (point contact) to max 2 in. (51 mm) Duct to be rigidly supported on both sides of the Floor-Ceiling assembly.
3. **Fill, Void or Cavity Materials* – Caulk or Sealant** – Min 3/4 in. (19 mm) thickness of caulk applied within the annulus, flush with top surface of floor or sole plate. Min 5/8 in. (16 mm) thickness of caulk applied within the annulus, flush with bottom surface of ceiling or top plate. Min 1/2 in. (13 mm) diam bead of caulk applied at the duct/floor or sole plate interface at point contact location on the top side of assembly and at the duct/ceiling or top plate interface at point contact location on bottom side of assembly.

3M COMPANY – FireDam 150+, CP 25WB+, IC 15WB+ caulk or FB-3000 WT sealant

*Bearing the UL Classification Mark

Reprinted from the Online Certifications Directory with permission from Underwriters Laboratories Inc.
Copyright © 2010 Underwriters Laboratories Inc.®



System No. F-C-7022

May 19, 2005
F Rating – 1 Hr
T Rating – 1/4 Hr

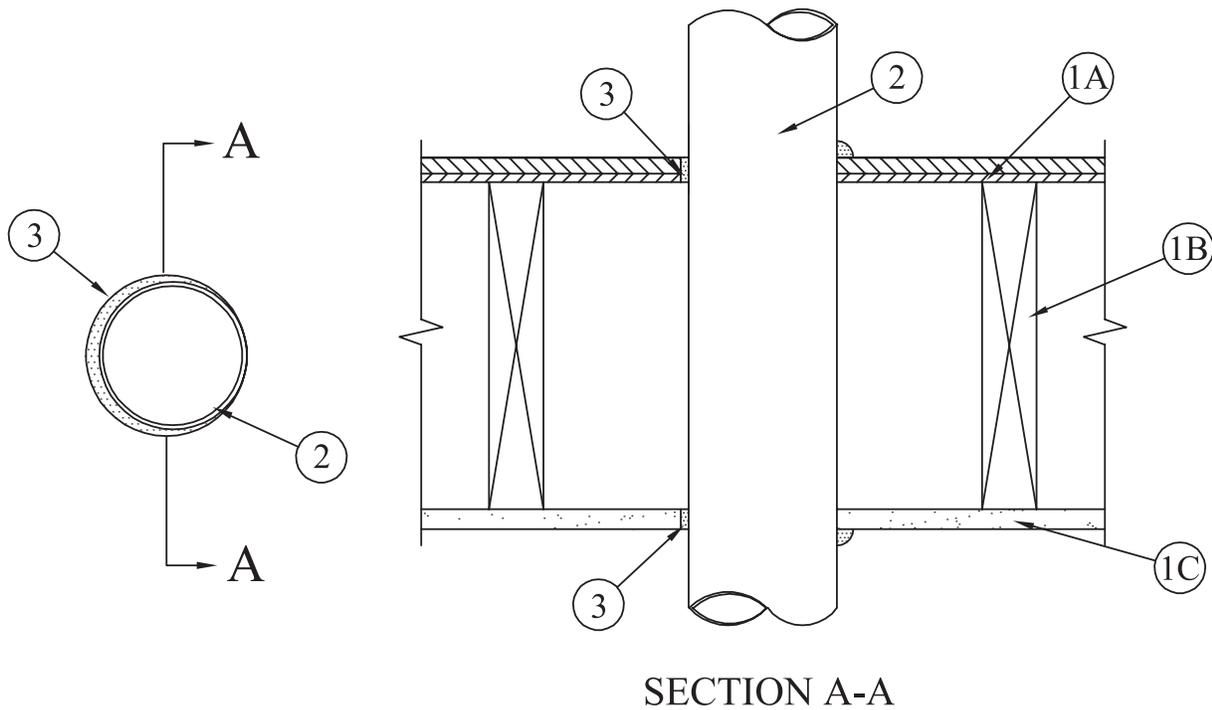

SECTION A-A

- Floor-Ceiling Assembly** – The 1 hr fire-rated solid or trussed lumber joist floor-ceiling assembly shall be constructed of the materials and in the manner specified in the individual L500 Series Floor-Ceiling Designs in the UL Fire Resistance Directory. The general construction details of the floor-ceiling assembly are summarized below:
 - Flooring System** – Lumber or plywood subfloor with finish floor of lumber, plywood or **Floor Topping Mixture*** as specified in the individual Floor-Ceiling Design. Max diam of opening is 11 in. (279 mm).
 - Wood Joists** – Nom 10 in. (254 mm) deep (or deeper) lumber, steel or combination lumber and steel joists, trusses or **Structural Wood Members*** with bridging as required and with ends firestopped.
 - Gypsum Board*** – Nom 4 ft. (122 cm) wide by 5/8 in. (16 mm) thick as specified in the individual Floor-Ceiling Design. Max diam of opening is 11 in. (279 mm).
- Steel Duct** – Nom 10 in. (254 mm) (or smaller) No. 28 gauge (or heavier) steel duct or nom 5 in. (127 mm) (or smaller) No. 30 gauge (or heavier) steel duct to be installed either concentrically or eccentrically within opening. The annular space between duct and periphery of opening shall be min 0 in. (point contact) to max 1 in. (0 mm to max 25 mm). Duct to be rigidly supported on both sides of floor assembly.
- Fill, Void or Cavity Materials* – Caulk or Sealant** – Min 3/4 in. (19 mm) thickness of caulk applied within annulus, flush with top surface of floor. Min 5/8 in. (16 mm) thickness of caulk applied within annulus, flush with bottom surface of ceiling. Min 1/4 in. (6 mm) diam bead of caulk applied at point contact locations at duct/floor interface on top surface of floor and at duct/ceiling interface.

3M COMPANY – CP 25WB+, IC 15WB+ caulk or FB-3000 WT sealant

*Bearing the UL Classification Marking

Reprinted from the Online Certifications Directory with permission from Underwriters Laboratories Inc.
Copyright © 2010 Underwriters Laboratories Inc.®



System No. F-C-7054

July 24, 2009
 F Rating – 1 Hr
 T Rating – 1 Hr

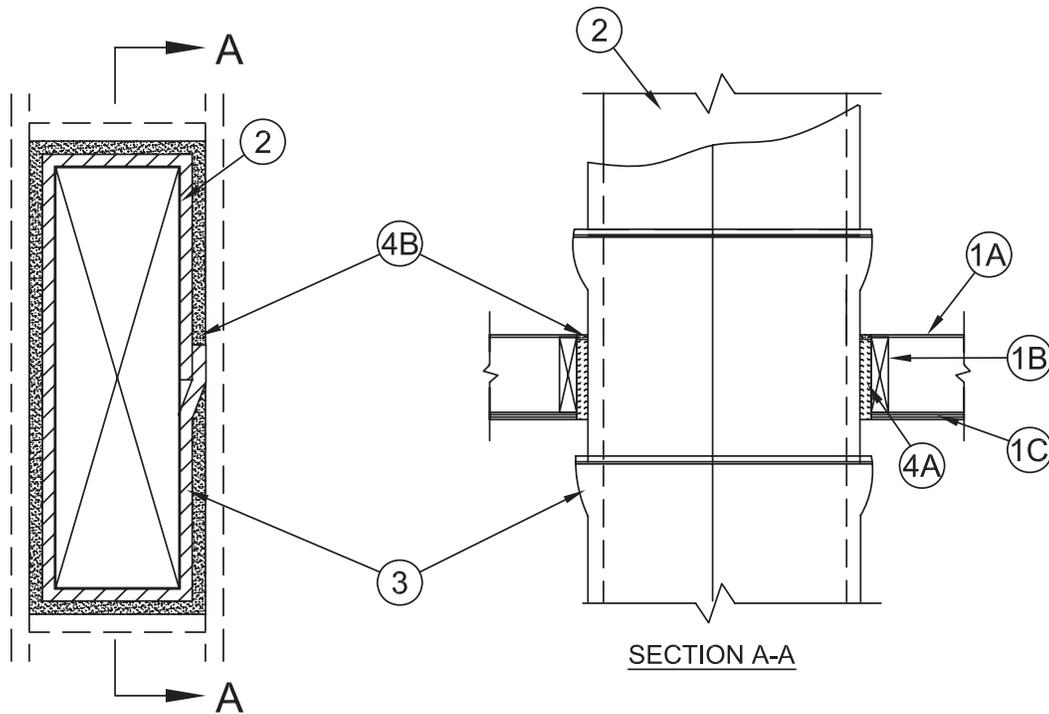

1. **Floor-Ceiling Assembly** – The 1 hr fire-rated solid wood joist floor-ceiling assembly shall be constructed of the materials and in the manner described in the individual L500 Series Design in the UL Fire Resistance Directory. The general construction features of the floor-ceiling assembly are summarized below:

- A. **Flooring System** – Lumber or plywood subfloor with finish floor as specified in the individual Floor-Ceiling Design. Max size of opening is 55 by 27 in. (1387 by 686 mm).
- B. **Wood Joists** – Nom 10 in. (254 mm) deep (or deeper) wood joists with bridging as required and with ends firestopped. Opening to be framed on all 4 sides with sections of solid wood joist.
- C. **Gypsum Board*** – Thickness, type, number of layers and fasteners shall be as specified in individual Floor-Ceiling Design. Max size of opening is 55 by 27 in. (1387 by 686 mm).

See **Gypsum Board** (CKNX) category in the Fire Resistance Directory for names of manufacturers.

2. **Steel Air Duct** – Max 48 by 20 in. (1220 by 508 mm), min 0.030 in. (0.76 mm) thick (22 GA) galvanized steel duct to be installed either concentrically or eccentrically within the opening. The duct shall be constructed and reinforced in accordance with SMACNA HVAC Duct Construction Standards - Metal and Flexible. Steel duct to be rigidly supported on both sides of wall assembly.
3. **Duct Wrap Materials*** – Nom 1-1/2 in. (38 mm) thick ceramic fiber batt or blanket (min 6 pcf or 96 kg/m³) jacketed with a foil-scrim-poly facing, installed in a telescope, checkerboard or butt-joint-and-collar pattern with 3 in. (76 mm) transverse and longitudinal overlaps, in accordance with the requirements of Ventilation Duct Assembly No. V-27. See Ventilation Duct Assemblies in Vol. 2 of the UL Fire Resistance Directory. Longitudinal and transverse joints sealed with aluminum foil tape. The annular space shall be min 1 in. (25 mm) to max 3 in. (76 mm) within the framed opening.

3M COMPANY

3M FIRE PROTECTION PRODUCTS – 3M FireBarrier Duct Wrap 615 or 3M FireBarrier Duct Wrap 615+

4. **Firestop System** – The firestop system shall consist of the following:

- A. **Packing Material*** – Min 9-1/2 in. (240 mm) thickness of min 6 pcf (96 kg/m³) density duct insulation compressed 33% minimum or min 5 pcf (80 kg/m³) density UL Classified mineral fiber compressed 50% minimum and installed into the opening. Packing material to be recessed from top surface of floor as required to accommodate the required thickness of fill material.

3M COMPANY

3M FIRE PROTECTION PRODUCTS – 3M FireBarrier Duct Wrap 615 or 3M FireBarrier Duct Wrap 615+

- B. **Fill Void or Cavity Material* – Sealant** – Min 1/4 in. (6.3 mm) thickness of fill material applied within annulus, flush with surface of floor.

3M COMPANY

3M FIRE PROTECTION PRODUCTS – 3M FireBarrier 1003 SL

*Bearing the UL Classification Mark

Reprinted from the Online Certifications Directory with permission from Underwriters Laboratories Inc.
 Copyright © 2010 Underwriters Laboratories Inc.®



System No. F-E-7001

May 20, 2005

F Rating – 1 Hr

T Rating – 1 Hr

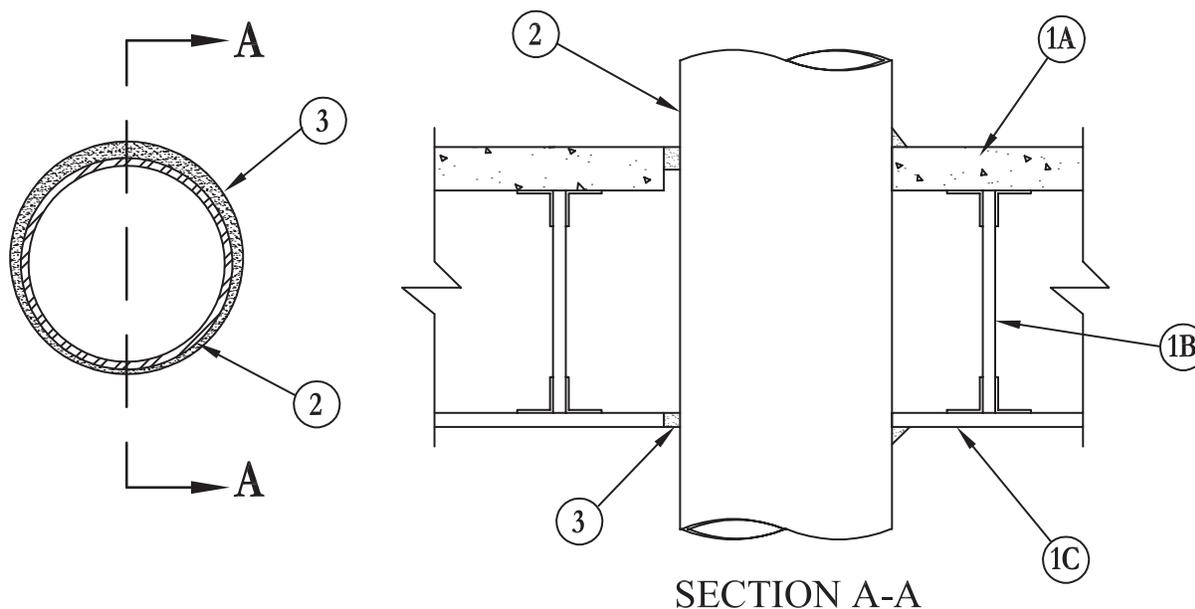

- Floor-Ceiling Assembly** – The 1 hr fire rated concrete and steel joist Floor-Ceiling assembly shall be constructed of the materials and in the manner described in the individual G500 Series Design in the UL Fire Resistance Directory, as summarized below:
 - Flooring** – Normal or Lightweight concrete as specified in the individual G500 Series Design. Max diam of opening is 11 in. (279 mm).
 - Joists** – Steel joists or **Structural Steel Members*** as specified in the individual G500 Series Design.
 - Gypsum Board*** – Min 5/8 in. (16 mm) thick, screw-attached to furring channels as specified in the individual G500 Series Design. Max diam of opening is 11 in. (279 mm).
- Steel Vent Duct** – Nom 4 in. (102 mm) diam (or smaller) No. 30 gauge (or heavier) galv steel vent duct or nom 10 in. (254 mm) diam (or smaller) No. 28 gauge (or heavier) galv steel vent duct. Diam of openings to be max 1 in. (25 mm) larger than outside diam of duct. Duct to be installed either concentrically or eccentrically in opening. The annular space between the duct and the periphery of opening shall be min 0 in. (point contact) to max 1 in. (0 to max 25 mm). Duct to be rigidly supported on both sides of floor-ceiling assembly.
- Fill, Void or Cavity Materials* – Caulk or Sealant** – Min 3/4 in. (19 mm) thickness of fill material applied within the annulus, flush with top surface of floor. Min 5/8 in. (16 mm) thickness of fill material applied within the annulus, flush with bottom surface of ceiling. An additional min 1/4 in. (6 mm) bead of fill material applied at the duct/floor interface at point contact location on the top surface of floor and at the duct/ceiling interface at point contact location on the lower surface of ceiling.

3M COMPANY – CP 25WB+, IC 15WB+ caulk or FB-3000 WT sealant.

*Bearing the UL Classification Marking

Reprinted from the Online Certifications Directory with permission from Underwriters Laboratories Inc.

Copyright © 2010 Underwriters Laboratories Inc.®



Through Penetrations

Misc. Mechanical

7000 Series

Wood Frame Floor/Ceiling

FE

System No. F-E-7005

May 21, 2009
 F Rating – 1 Hr
 T Rating – 1/4 Hr

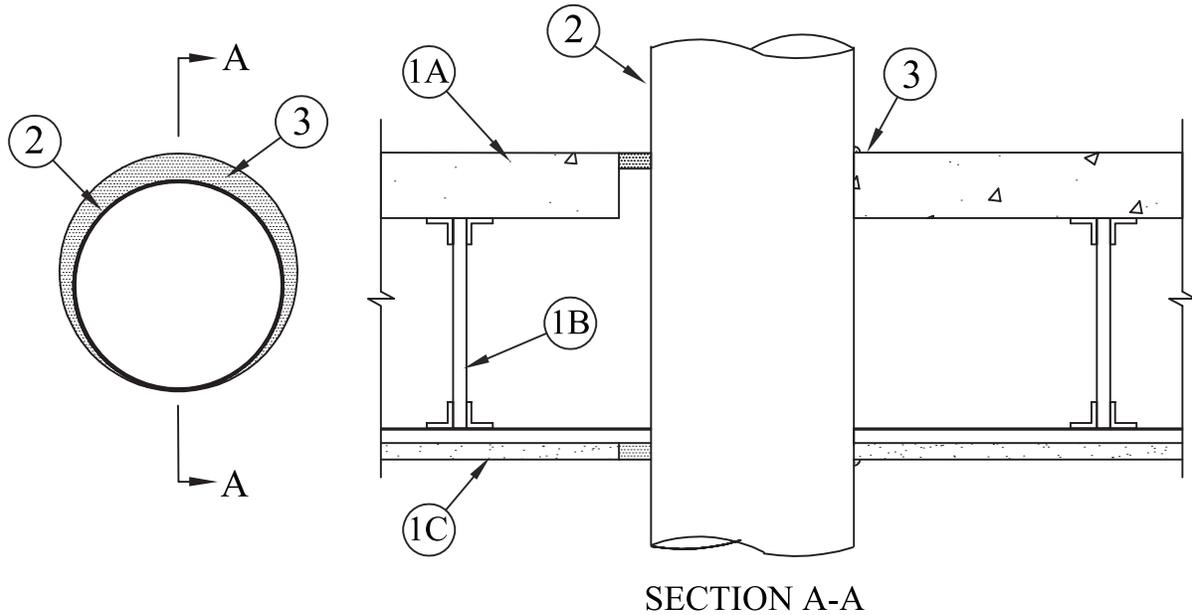

- Floor-Ceiling Assembly** – The 1 hr fire rated concrete and steel joist Floor-Ceiling assembly shall be constructed of the materials and in the manner described in the individual G500 Series Design in the UL Fire Resistance Directory, as summarized below:
 - Flooring** – Lightweight or normal weight (100-150 pcf or 1600-2400 kg/m³) concrete as specified in the individual G500 Series Design. Max diam of opening is 11 in. (279 mm).
 - Joists** – Steel joists or **Structural Steel Members*** as specified in the individual G500 Series Design.
 - Gypsum Board*** – Min 5/8 in. (16 mm) thick, screw-attached to furring channels as specified in the individual G500 Series Design. Max diam of opening is 11 in. (279 mm).
- Steel Duct** – Nom 10 in. (254 mm) diam (or smaller) No. 28 gauge (or heavier) steel duct or nom 5 in. (127 mm) diam (or smaller) No. 30 gauge (or heavier) steel duct to be installed either concentrically or eccentrically within opening. The annular space between duct and periphery of opening shall be min 0 in. (0 mm, point contact) to max 1 in. (25 mm). Duct to be rigidly supported on both sides of floor assembly.
- Fill, Void or Cavity Materials* – Caulk or Sealant** – Min 3/4 in. (19 mm) thickness of caulk applied within annulus, flush with top surface of floor. Min 5/8 in. (16 mm) thickness of caulk applied within annulus, flush with bottom surface of ceiling. Min 1/4 in. (6 mm) diam bead of caulk applied at point contact locations at duct/floor interface on top surface of floor and at duct/ceiling interface.

3M COMPANY – IC 15WB+, CP 25WB+ caulk or FB-3000 WT sealant

*Bearing the UL Classification Mark

Reprinted from the Online Certifications Directory with permission from Underwriters Laboratories Inc.
 Copyright © 2010 Underwriters Laboratories Inc.®



Combos

CAJ

Concrete floors with a minimum thickness less than or equal to 5 inches (127 mm)
Concrete or masonry walls with a minimum thickness less than or equal to 8 inches (203 mm)

CBJ

Concrete floors with a minimum thickness greater than 5 inches (127 mm)
Concrete or masonry walls with a minimum thickness less than or equal to 8 inches (203 mm)

FA

Concrete floors/Steel decks
Concrete or masonry walls with a minimum thickness less than or equal to 8 inches (203 mm)

FB

Concrete floors/Steel decks
Concrete floors with a minimum thickness greater than 5 inches (127 mm)

FC

Floor assemblies
Framed floors

FE

Truss floor assemblies

WJ

Floor assemblies
Concrete or masonry walls with a minimum thickness less than or equal to 8 inches (203 mm)

WL

Wall assemblies
Framed walls

Combos • Concrete

| 3M UL Systems | "F" Rating | 3M Product | Through Penetrant Details |
|---------------|------------|--|---|
| C-AJ-8001 | 1, 2, 3 | 3M™ Fire Barrier Sealant CP 25WB+ 3M™ Fire Barrier Sealant IC 15WB+ 3M™ Fire Barrier Composite Sheet CS-195+ 3M™ Fire Barrier Wrap Strips FS-195+ 3M™ Fire Barrier Moldable Putty Stix MP+ 3M™ Expanrol™ Flexible Intumescent Strip E-FIS 3M™ Fire Barrier Water Tight Sealant 3000 WT 3M™ Fire Barrier Wrap Ultra GS | Max. 36 square foot opening with a max. 36 in. dimension in a concrete floor or wall with various mechanical penetrations. Bare or insulated metallic pipes, cables, or cable trays penetrating. Utilizing CS 195+ Composite Sheet, FS 195+ Wrap Strips, and sealant. |
| C-AJ-8003 | 1 | 3M™ Fire Barrier Silicone Sealant 2000+ 3M™ Fire Barrier Water Tight Sealant 1000 NS 3M™ Fire Barrier Water Tight Sealant 1003 SL | One or more steel pipe/conduit or cables penetrating a 1 hour rated, min. 5 in. thick concrete floor or wall. |
| C-AJ-8013 | 2, 3 | 3M™ Fire Barrier Sealant CP 25WB+ 3M™ Fire Barrier Wrap Strips FS-195+ 3M™ Fire Barrier Water Tight Sealant 3000 WT | Multiple pipes, including 1 in. PVC pipe, 3 in. copper pipe, and/or 2.5 in. steel pipe and low voltage cables penetrating the same max. 45 square in. opening in a min. 2.5 in. thick concrete floor or wall. AB/PVC insulation optional. |
| C-AJ-8060 | 1 | 3M™ Fire Barrier Sealant CP 25WB+ 3M™ Fire Barrier Sealant IC 15WB+ 3M™ Fire Barrier Ultra Plastic Pipe Device 3M™ Fire Barrier Moldable Putty Stix MP+ 3M™ Fire Barrier Water Tight Sealant 3000 WT | Multiple max. 3/4 in. metallic pipes with or without AB/PVC insulation, max. 1-1/4 in. PVC or CPVC pipes, and low voltage cables (AC line set) penetrating a 1 hour rated concrete floor or wall. |
| C-AJ-8069 | 2 | 3M™ Fire Barrier Sealant CP 25WB+ 3M™ Fire Barrier Sealant IC 15WB+ 3M™ Fire Barrier Water Tight Sealant 3000 WT | Multiple metallic pipes with or without AB/PVC insulation penetrating a concrete floor or wall through a max. 3 foot x 1 foot opening. |
| C-AJ-8072 | 2 | 3M™ Fire Barrier Sealant CP 25WB+ | Multiple metallic pipes, with or without fiberglass or AB/PVC insulation, and low voltage cables penetrating a max. 84 square in. opening in a concrete floor or wall. |
| C-AJ-8073 | 2 | 3M™ Fire Barrier Mortar 3M™ Fire Barrier Sealant CP 25WB+ 3M™ Fire Barrier Wrap Strips FS-195+ 3M™ Fire Barrier Moldable Putty Stix MP+ | Max. 24 square foot opening in a concrete floor or wall with multiple mechanical penetrations. Metallic pipes, bare or having fiberglass, cellular glass, or AB/PVC insulation, cable trays, and cables. Utilizing Fire Barrier Mortar. |
| C-AJ-8075 | 2 | 3M™ Fire Barrier Water Tight Sealant 1000 NS 3M™ Fire Barrier Water Tight Sealant 1003 SL | Max. 24 square foot opening in a concrete floor or wall with multiple mechanical penetrations. Metallic pipes, bare or having fiberglass insulation, cable trays, and cables. Utilizing packing material and silicone sealant. |
| C-AJ-8085 | 2 | 3M™ Fire Barrier Water Tight Sealant 1000 NS 3M™ Fire Barrier Water Tight Sealant 1003 SL 3M™ Fire Barrier Water Tight Sealant 3000 WT | Max. 108 square in. opening in a concrete floor or wall having low voltage cables and multiple metallic pipes penetrating, bare or having AB/PVC insulation. Optional steel sleeve. |
| C-AJ-8087 | 2 | 3M™ Fire Barrier Sealant CP 25WB+ 3M™ Fire Barrier Sealant IC 15WB+ 3M™ Fire Barrier Moldable Putty Stix MP+ | Max. 1 in. copper tubes, bare or having AB/PVC insulation, and low voltage cables (AC line set) penetrating a concrete floor or wall through a max. 4 in. diameter opening. |
| C-AJ-8088 | 2 | 3M™ Fire Barrier Sealant CP 25WB+ 3M™ Fire Barrier Moldable Putty Stix MP+ 3M™ Fire Barrier Wrap Ultra GS | Max. 144 square in. opening in a concrete floor or wall having max. 3 in. copper pipes, with or without AB/PVC insulation, and low voltage cables penetrating. Insulated pipes may be installed with point contact between penetrants. |
| C-AJ-8106 | 2 | 3M™ Fire Barrier Moldable Putty Stix MP+ 3M™ FireDam™ Spray 200 | Max. 24 square foot opening in a concrete floor or wall with multiple mechanical penetrations. Metallic pipes, bare or having fiberglass or mineral wool insulation, cable trays, and cables. Utilizing packing material and FireDam Spray 200. |
| C-AJ-8123 | 2 | 3M™ Fire Barrier Sealant CP 25WB+ 3M™ Fire Barrier Sealant IC 15WB+ | Max. 1 in. metallic pipes, bare or having AB/PVC insulation, and low voltage cables (AC line set) penetrating a concrete floor or wall through a max. 4 in. diameter opening. Steel sleeve optional. |
| C-AJ-8128 | 2 | 3M™ Fire Barrier Sealant CP 25WB+ 3M™ Fire Barrier Sealant IC 15WB+ | Metallic pipes, bare or having fiberglass or AB/PVC insulation, penetrating the same max. 192 square in. opening in a concrete floor or wall. Steel sleeve optional. |
| C-AJ-8135 | 2 | 3M™ Fire Barrier Sealant CP 25WB+ 3M™ Fire Barrier Sealant IC 15WB+ 3M™ Fire Barrier Water Tight Sealant 3000 WT | Max. 3/4 in. metallic pipes, bare or having AB/PVC or fiberglass insulation, max. 1 in. nonmetallic pipe, and low voltage cables (AC line set) penetrating a concrete floor or wall through a max. 5 in. diameter opening. |
| C-AJ-8172 | 2 | 3M™ Fire Barrier Pass-Through Products 3M™ Fire Barrier Water Tight Sealant 3000 WT 3M™ Fire Barrier Sealant CP 25WB+ 3M™ Fire Barrier Sealant IC 15WB+ 3M™ Fire Barrier Moldable Putty Stix MP+ | Pass-Through device system for various mechanical penetrants penetrating a concrete floor or wall. Metallic pipes, plastic pipes, insulated pipes, and cables. |

Combos • Concrete

| 3M UL Systems | "F" Rating | 3M Product | Through Penetrant Details |
|---------------|------------|--|--|
| C-AJ-8187 | 2 | 3M™ Fire Barrier Moldable Putty Stix MP+ 3M™ Fire Barrier Composite Sheet CS-195+ 3M™ Fire Barrier Sealant CP 25WB+ 3M™ Fire Barrier Water Tight Sealant 3000 WT | Multiple max. 4 in. nonmetallic pipes penetrating the same 7 square foot opening in a concrete floor or wall. Utilizing CS 195+ Composite Sheet and PPD or Ultra GS Wrap Strips within an RC-1 Restricting Collar. |
| C-AJ-8205 | 2 | 3M™ Fire Barrier Pillows 3M™ Fire Barrier Self-Locking Pillows 3M™ Fire Barrier Moldable Putty Stix MP+ 3M™ Fire Barrier Tuck-In Wrap Strips | One or two AC line sets, consist of copper pipes with or without AB/PVC insulation, a nonmetallic pipe, and low voltage cables, penetrating a max. 1024 square in. opening in a concrete floor or wall. |
| C-AJ-8206 | 2, 3 | 3M™ Fire Barrier Tuck-In WS Roll 3M™ Fire Barrier Mortar | Multiple metallic pipes and/or max. 2 in. PVC pipes penetrating the same max. 1656 square in. opening in a concrete floor or wall. Utilizing Fire Barrier Mortar and Tuck-In Wrap Strip. |
| C-AJ-8216 | 2 | 3M™ Fire Barrier Water Tight Sealant 3000 WT 3M™ Fire Barrier Sealant CP 25WB+ 3M™ Fire Barrier Sealant IC 15WB+ 3M™ Fire Barrier Packing Material PM4 | Steel tube and communication cable penetrating a max. 8 in. diameter opening in a concrete floor or wall. Steel sleeve optional. |
| C-AJ-8217 | 2 | 3M™ Fire Barrier Rated Foam FIP 1-Step | Max. 1 inch metallic and/or nonmetallic pipes, with or without AB/PVC insulation, and low voltage cables penetrating the same max. 6 in. diameter opening in a concrete floor or wall. Utilizing Fire Barrier Rated Foam, FIP 1-Step. |
| C-AJ-8231 | 2 | 3M™ Fire Barrier Sealant CP 25WB+ 3M™ Fire Barrier Water Tight Sealant 3000 WT | Metallic pipes, cable bundles, cable tray, and insulated pipes penetrating the same max. 1440 square in. opening in a minimum 4.5 in. thick concrete floor or wall. Utilizing packing material and sealant. |
| C-AJ-8251 | 2, 3 | 3M™ Fire Barrier Packing Material 3M™ Fire Barrier Sealant IC 15WB+ 3M™ Fire Barrier Sealant CP 25WB+ 3M™ Fire Barrier Water Tight Sealant 3000 WT | AC line set consisting of max. 1 in. two max. 1 in. copper tubes, one having AB/PVC insulation, a single max. 1 in. nonmetallic pipe and two low voltage cables penetrating the same max. 4.5 in. diameter opening in a concrete floor or wall. Bottom side access for floors, both side access for walls. |
| C-AJ-8255 | 2 | 3M™ Fire Barrier Block 3M™ Fire Barrier Plank 3M™ Fire Barrier Rated Foam FIP 1-Step 3M™ Fire Barrier Tuck-In Wrap Strips | Fire Barrier Blocks, Plugs, and Planks system for multiple mechanical penetrations. Metallic pipes, with or without fiberglass insulation, nonmetallic pipes, cable trays, and cables penetrating the same max. 900 square in. opening in a concrete floor or wall. |
| C-AJ-8275 | 2 | 3M™ Fire Barrier Sealant CP 25WB+ 3M™ Fire Barrier Water Tight Sealant 3000 WT | Metallic pipes, cable bundles, cable tray, busway, nonmetallic pipe, round steel ducts, AC line sets, and insulated pipes penetrating the same max. 1024 square in. opening in a minimum 4.5 in. thick concrete floor or wall. Utilizing packing material and sealant. |
| C-BJ-8004 | 2, 3, 4 | 3M™ Fire Barrier Sealant CP 25WB+ 3M™ Fire Barrier Sealant IC 15WB+ 3M™ Fire Barrier Composite Sheet CS-195+ 3M™ Fire Barrier Wrap Strips FS-195+ 3M™ Fire Barrier Water Tight Sealant 3000 WT | Metallic pipes, insulated metallic pipes, and cables/cable bundles penetrating the same max. 1500 square in. opening in a 2 or 4 hour rated concrete floor or wall. |
| C-BJ-8005 | 4 | 3M™ Fire Barrier Sealant CP 25WB+ 3M™ Fire Barrier Sealant IC 15WB+ 3M™ Fire Barrier Composite Sheet CS-195+ 3M™ Fire Barrier Wrap Strips FS-195+ 3M™ Fire Barrier Moldable Putty Stix MP+ 3M™ Fire Barrier Water Tight Sealant 3000 WT | Metallic pipes and cables/cable bundles penetrating the same max. 1500 square in. opening in a 4 hour rated concrete floor or wall. |
| F-A-8001 | 1, 2 | 3M™ Fire Barrier Sealant CP 25WB+ 3M™ Fire Barrier Wrap Strips FS-195+ 3M™ Fire Barrier Water Tight Sealant 3000 WT | 4" copper tubing, 4" steel, 4" steel conduit, 4" steel EMT:1/2" to 1" glass fiberinsulation, Nominal 3/4" AB/PVC insulation. Max area of opening 192 sq. in. Max length 24", max width 8". See system for annular and pipe separation. Mineral wool required. 2 hour F Rating. Also known as FA8001. |
| F-A-8007 | 1, 2, 3 | 3M™ Fire Barrier Cast-In Devices for Metal Pipes 3M™ Fire Barrier Water Tight Sealant 1000 NS 3M™ Fire Barrier Water Tight Sealant 1003 SL 3M™ Fire Barrier Sealant CP 25WB+ 3M™ Fire Barrier Sealant FD 150+ 3M™ Fire Barrier Sealant IC 15WB+ 3M™ Fire Barrier Moldable Putty Stix MP+ 3M™ Fire Barrier Water Tight Sealant 3000 WT | 1 in. copper tubing, 1 in. copper pipe, max 1 nom 1 in. PVC (closed or vented), 2/C No. 18 gauge thermostat cable. Max 3/4 in. glass fiber or AB/PVC insulation. Penetrants bundled. Point contact to max 2 in. annular. Min 4-1/2 in. concrete. See system for penetrant spacing. Mineral wool required. 3 hour F rating. Class I W rating. PVC jacket required for Class I W rating. Also known as FA8007. |

Compos • Concrete

| 3M UL Systems | "F" Rating | 3M Product | Through Penetrant Details |
|---------------|------------|--|--|
| F-A-8010 | 1, 2 | 3M™ Fire Barrier Cast-In Devices for Metal Pipes 3M™ Fire Barrier Water Tight Sealant 1000 NS 3M™ Fire Barrier Water Tight Sealant 1003 SL 3M™ Fire Barrier Sealant CP 25WB+ 3M™ Fire Barrier Sealant FD 150+ 3M™ Fire Barrier Sealant IC 15WB+ 3M™ Fire Barrier Moldable Putty Stix MP+ 3M™ Fire Barrier Water Tight Sealant 3000 WT | Max 4 metallic pipes: 4 in. copper tubing or pipe. Pipes larger than 1/2 in. must be insulated with 1/2 in. AB/PVC. Max one 1 in. PVC (closed or vented), Max 2 8/C No. AWG thermostat cable. Space between penetrants point contact to max 1 in.. Point contact to max 1 in. annular. Minimum 2-1/2 in. concrete. 2 hr. F Rating. Class I W rating. Mineral wool required. Also known as FA8010. |
| F-A-8014 | 1, 2, 3 | 3M™ Fire Barrier Mortar 3M™ Fire Barrier Wrap Ultra GS | Max 4" 30 ga. steel duct concentric or eccentric installation. 4" PVC (vented), 4" ccPVC (vented), 4" ABS (vented), 4" FRPP (vented). Double HVAC line set. Single HVAC line set. Max opening 180 sq. inches. Max dimension 18 inches. 3 hour F Rating. Steel collar. See system for annular spaces. Also known as FA8014 |
| F-A-8015 | 1, 2, 3 | 3M™ Fire Barrier Mortar 3M™ Fire Barrier Wrap Ultra GS | Max 4" 30 ga. steel duct concentric or eccentric installation. 4" PVC (vented), 4" ccPVC (vented), 4" ABS (vented), 4" FRPP (vented). Double HVAC line set. Single HVAC line set. Max opening 180 sq. inches. Max dimension 18 inches. 3 hour F Rating. Steel collar. See system for annular spaces. Also known as FA8015 |
| F-B-8001 | 1, 2 | 3M™ Fire Barrier Sealant CP 25WB+ 3M™ Fire Barrier Sealant IC 15WB+ 3M™ Fire Barrier Ultra Plastic Pipe Device 3M™ Fire Barrier Moldable Putty Stix MP+ 3M™ Fire Barrier Water Tight Sealant 3000 WT | 3/4" steel pipe, 3/4" steel conduit, 3/4" steel EMT, 3/4" copper tubing, 3/4" copper pipe, 1-1/4" PVC (closed or vented), 1-1/4" SDR 13.5 CPVC (closed), 1/2" AB/PVC or glass fiber insulation required on pipes larger than 1/2". 1-1/4" PVC (closed or vented), 1-1/4" RNC. 2 8/C No. 12 AWG cables. Max opening 4-1/2". Min 1/4" annular. 28 gauge steel sleeve, mineral wool required. 2 hour F. Also known as FB8001. |
| F-B-8005 | 1, 2 | 3M™ Fire Barrier Sealant CP 25WB+ 3M™ Fire Barrier Sealant IC 15WB+ 3M™ Fire Barrier Sealant FD 150+ 3M™ Fire Barrier Water Tight Sealant 3000 WT | Max 4 metallic pipes: 4" copper tubing, 4" copper pipe. Pipes larger than 1/2" must be insulated with 1/2" AB/PVC. Max one 1" PVC (closed or vented), Max 2 8/C No. AWG thermostat. Hollowcore. Max opening 5". Penetrants bundled. Point contact to max 1" between penetrants. Min 1/2" to max 1" annular between bundle and opening. Steel sleeve, mineral wool required. 2 hour F Rating. Also known as FB8005. |
| F-B-8006 | 1, 2 | 3M™ Fire Barrier Sealant CP 25WB+ 3M™ Fire Barrier Sealant IC 15WB+ 3M™ Fire Barrier Water Tight Sealant 3000 WT | Max 4 metallic pipes: 4" copper tubing, 4" copper pipe. Pipes larger than 1/2" must be insulated with 1/2" AB/PVC. Max 1: 1" PVC (closed or vented). Max 2: 8/C No. AWG thermostat cables. Hollowcore. Max opening 5". Space between penetrants min 1/2" to max 1". Space between penetrants & opening min 1/2" to max 1". 2 hr. F Rating. Mineral wool required. Also known as FB8006 |
| W-J-8019 | 1, 2 | 3M™ Fire Barrier Sealant CP 25WB+ 3M™ Fire Barrier Sealant IC 15WB+ | Multiple 1" copper tubing or pipe, steel pipe, 7/C power cables, 3/4" AB/PVC flexible foam. Also referred as WJ8019. |
| W-J-8025 | 1, 2 | 3M™ Fire Barrier Sealant CP 25WB+ 3M™ Fire Barrier Sealant IC 15WB+ | Max. (4) AC line sets through max. 58 sq. in. opening with a max. dimension of 14-1/2". Also referred as WJ8025. |
| W-J-8042 | 1, 2 | 3M™ Fire Barrier Pillows 3M™ Fire Barrier Self-Locking Pillows 3M™ Fire Barrier Moldable Putty Stix MP+ | Max two max 4 in. diam cable bundles, max one non-metallic optical fiber raceway. Max opening 8 in. x 16 in. See system for cable descriptions. 2 hour F Rating. Also known as WJ8042. |
| W-J-8052 | 1, 2 | 3M™ Fire Barrier Pillows 3M™ Fire Barrier Self-Locking Pillows 3M™ Fire Barrier Rated Foam FIP 1-Step | Min 6 in. concrete wall or concrete block wall with max 36 in. by 36 in. opening. Max 20, nom 4 in. EMT or steel conduit. Nom 6 in. Sch. 10 steel pipe. Nom 6 in. by 12 in. 26 ga steel duct. Nom 4 in. 28 ga steel duct. Nom 3 in. service weight cast iron pipe. Max W8 x 15 steel beam. Nom 4 in. sq. steel tube. Nom 6 in. type L copper pipe. Nom 1 in. EMT or steel conduit. Nom 4 in. Sch. 40 steel pipe. |

System No. C-AJ-8001

May 19, 2005

F Ratings – 1, 2 and 3 Hr
(See Items 1, 2A, 2B and 2C)
T Rating – 0 Hr

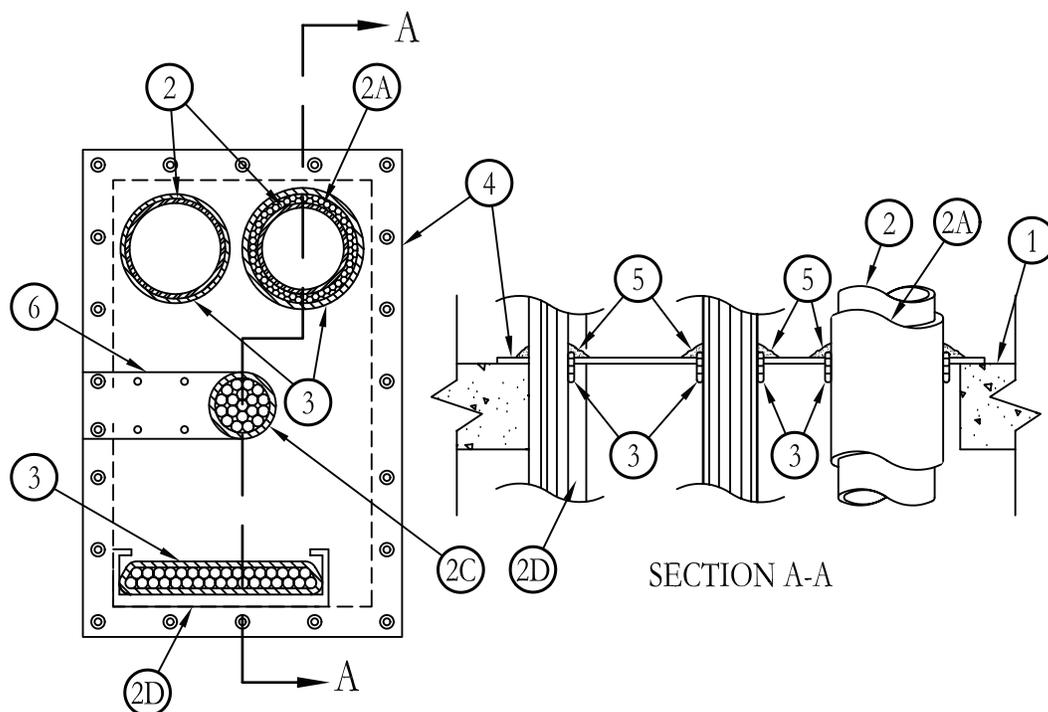

1. **Floor or Wall Assembly** – Lightweight or normal weight (100-150 pcf or 1600-2400 kg/m³) concrete. Min thickness of concrete floor or wall is 2-1/2 in. (64 mm) for 1 hr F Rating and 4-1/2 in. (114 mm) for 2 or 3 hr F Rating. Wall may also be constructed of any UL Classified **Concrete Blocks***. Max area of opening 36 sq ft (3.4 m²) with one dimension of opening being 36 in. (914 mm) or less. See **Concrete Blocks (CAZT)** category in the Fire Resistance Directory for names of manufacturers.

2. **Pipe or Conduit** – Nom 12 in. (305 mm) diam (or smaller) Schedule 10 (or heavier) steel pipe, nom 6 in. (152 mm) diam (or smaller) steel conduit, nom 4 in. (102 mm) diam (or smaller) Schedule 10 (or heavier) steel pipe, steel EMT or nom 6 in. (152 mm) diam (or smaller) Type L (or heavier) copper tubing. Min clearance between pipes 1 in. (25 mm). Min clearance between pipe and wall of through opening 1/4 in. (6 mm). When single nom 4 in. (102 mm) diam (or smaller) pipe, conduit or EMT is installed in nom 7 in. (178 mm) diam (or smaller) circular through opening, min clearance between pipe, conduit or EMT and wall of through opening is 0 in. (0 mm) (point contact). Pipes and conduits rigidly supported on both sides of floor or wall assembly.

2A. **Pipe Covering (Optional)** – Nom 1 in. to 2 in. (25 mm to 51 mm) thick hollow cylindrical heavy density (min 3.5 pcf or 56 kg/m³) glass fiber units jacketed on the outside with an all service jacket may be used on nom 12 in. (305 mm) diam (or smaller) Schedule 10 (or heavier) steel pipe or on nom 6 in. (152 mm) diam (or smaller) copper tubing. Longitudinal joints sealed with metal fasteners or factory-applied self-sealing lap tape. Transverse joints secured with metal fasteners or with butt strip tape supplied with the product. **When pipe covering material is used, max F Rating is 2 hr.**

See **Pipe and Equipment Covering – Materials*** (BRGU) category in Building Materials Directory for names of manufacturers. Any pipe covering material meeting the above specifications and bearing the UL Classification Marking with a Flame Spread Index of 25 or less and a Smoke Developed Index of 50 or less may be used.

2B. **Pipe Insulation (Optional, Not Shown)** – As an alternate to Item 2A, nom 1 in. (25 mm) thick acrylonitrile butadiene/polyvinyl chloride (AB/PVC) flexible foam furnished in the form of tubing with skin may be used on nom 4 in. (102 mm) diam (or smaller) Schedule 10 (or heavier) steel pipe or on nom 4 in. (102 mm) diam (or smaller) copper tubing. **When pipe insulation material is used, max F Rating is 2 hr.**

See **Plastics (QMFZ2)** category in the Recognized Component Directory for names of manufacturers. Any Recognized Component tube insulation material meeting the above specifications and having a UL94 Flammability classification of 94-5VA may be used.

2C. **Cables** – Nom 4 in. (102 mm) diam (or smaller) tight bundle of cable. When cable bundle is installed in through opening containing pipes or conduits, a min separation of 12 in. (305 mm) shall be maintained between cable bundle and pipe/conduit. Cable bundle rigidly supported on both sides of floor or wall assembly. The following types and sizes of cables may be used:

A. Max 150 pair No. 24 AWG telephone cable; polyvinyl chloride (PVC) insulation and jacket materials. **When telephone cable is used, F Rating is 2 hr.**

B. Max No. 2/0 AWG multi conductor power/control cable; cross-linked polyethylene (XLPE) insulation, PVC jacket. **When power/control cable is used, F Rating is 3 hr.**

C. Max 350 kcmil single-conductor power cable; XLPE insulation. **When power cable is used, F Rating is 3 hr.**

D. Multiple fiber optical communication cable jacketed with polyvinyl chloride and having a max outside diam of 5/8 in. (16 mm).

E. Max 22 AWG coaxial data cable with polyethylene insulation and polyvinyl chloride jacket.

Through Penetrations

Compos

8000 Series

Concrete

CAJ

System No. C-AJ-8001 *continued*

Through Penetrations

Compos

8000 Series

Concrete

CAJ

2D. **Cable Tray** – Max 36 in. (914 mm) wide by max 6 in. (152 mm) deep steel or aluminum open ladder cable tray. Cable tray to consist of channel-shaped side-rails with boxed channel rungs spaced 9 in. (229 mm) OC. Cable tray side-rails to be formed of min 0.056 in. (1.42 mm) thick (16 ga) galv steel or min 0.125 in. (3.2 mm) thick aluminum. Cable tray rungs to be formed of min 0.029 in. (0.72 mm) thick (22 ga) galv steel or min 0.080 in. (2 mm) thick aluminum. When more than one cable tray is installed in opening, min distance between cable trays is 24 in. (610 mm). Min annular space between cable tray and edge of opening is 0 in. (0 mm) (point contact). When annular space between cable tray and edge of opening exceeds 3 in. (76 mm), a support channel (Item 7) shall be installed between the cable tray and the edge of the opening to support the edge of the intumescent sheet (Item 4) parallel with the width dimension of the cable tray. Aggregate cross-sectional area of cables in cable tray not to exceed 39 percent of the cross-sectional area of the cable tray based on a max 3 in. (76 mm) loading depth within the cable tray. Any combination of the types and sizes specified in Item 2C may be used. Cable tray(s) rigidly supported on both sides of floor or wall assembly.

3. **Fill, Void or Cavity Materials* – Wrap Strip** – Nom 1/4 in. (6 mm) thick intumescent elastomeric material faced on one side with aluminum foil, supplied in strips. Min 2 in. (51 mm) wide strip wrapped around pipe/conduit, cable bundle, pipe insulation or cable fill within cable tray (foil side exposed) and secured in place with steel wire or aluminum foil tape. One layer of wrap strip is required when max 1 in. (25 mm) thick pipe covering is used. Two layers of wrap strip are required when nom 2 in. (51 mm) thick pipe covering is used. Wrap strip to extend approx 7/8 in. (22 mm) beyond each face of the intumescent sheet (Item 4). Prior to installation of the wrap strip on cable bundle or cable fill within cable tray, caulk (Item 5) to be forced into cable bundle to fill all interstices between cables throughout 2 in. (51 mm) height of wrap strip layer. When nom 6 in. (152 mm) diam (or smaller) uninsulated pipe, conduit or EMT is installed in through opening, no wrap strip is required on pipe, conduit or EMT for 2 hr F Rating.

3M COMPANY – FS-195+

4. **Fill, Void or Cavity Materials* – Intumescent Sheet** – Rigid aluminum foil-faced sheet with galv steel sheet backer. Sheet cut to tightly follow the contours of the pipe/cable wrap strip (or individual pipe) and with a min lap of 2 in. (51 mm) on all sides of the through opening. Sheet to be installed with the galv steel sheet backer exposed (aluminum foil facing against floor or wall surface). Sheet secured to top surface of floor and both sides of wall using min 3/16 in. (5 mm) diam by 1-1/4 in. (32 mm) long steel masonry fasteners with min 1-1/4 in. (32 mm) diam steel washers. Max spacing of fasteners not to exceed 6 in. (152 mm) OC. As an alternate when (1) the max pipe or conduit size is nom 4 in. (102 mm) diam, (2) each pipe or conduit is provided with a layer of wrap strip and (3) no bundled cables or insulated pipes are installed in the through opening, the intumescent sheet may be installed on bottom surface of floor or on only one side of wall.

3M COMPANY – CS-195+

5. **Fill, Void or Cavity Materials* – Graphite Seal, Caulk, Sealant or Putty** – One layer of 1/2 in. x 1/16 in. (13mm by 1.6 mm) adhesive backed graphite intumescent seal positioned under intumescent sheet around entire perimeter of through opening or min 1/4 in. (6 mm) diam continuous bead of caulk or putty applied to edge of intumescent sheet at its interface with surface of floor or wall around entire perimeter of through opening. Generous application of caulk to be applied around the base of the wrap strip (or individual pipe) at its egress from the intumescent sheet(s) in addition to completely covering the wrap strip up to the interface(s) with the pipe, pipe insulation and/or cable bundle. All interstices between cables to be filled with caulk throughout the 2 in. (51 mm) height of the wrap strip.

3M COMPANY – E-FIS or GS seals, CP 25WB+, IC 15WB+ caulk, FB-3000 WT sealant or MP+ Stix putty.

6. **Steel Cover Strip** – Min 2 in. (51 mm) wide strip of min 0.015 in. (0.4 mm) thick (30 gauge) galv steel centered over entire length of slit made in intumescent sheet (Item 4) to permit installation about the pipe/cable bundle. Prior to installation of the steel strip, slit in intumescent sheet covered with nom 1/4 in. (6 mm) diam bead of caulk (Item 5). Steel cover strip secured to galv steel backer of intumescent sheet with steel sheet-metal screws or steel rivets spaced max 2 in. (51 mm) OC on each side of slit.

7. **Support Channels** (Not Shown) – When area of through opening exceeds 1440 sq in. (9290 cm²), an intermediate support channel shall be installed flush with top surface of floor or both surfaces of wall. Support channels to be min 1-5/8 in. by 1-5/8 in. (41 mm by 41 mm) and formed of min 0.093 in. (2.4 mm) thick (No. 12 gauge) painted or galv steel. Ends of steel channel bolted or welded to steel angles anchored to inside walls of through opening. When width of cable tray (Item 2D) exceed 24 in. (610 mm) and/or when more than one cable tray is installed in the opening, additional support channels are to be installed such that intumescent sheet is supported within 3 in. (76 mm) of each side of the cable tray(s). When steel support channels are centered beneath butted seams of intumescent sheets, no steel cover strip (Item 6) is required over butted seam. Intumescent sheet secured to steel support channels with steel sheet metal screws in conjunction with min 1-1/4 in. (32 mm) diam steel fender washers.

When support channel is used beneath butted seam of intumescent sheets, fasteners spaced max 3 in. (76 mm) OC on each side of butted seam. When support channel is located away from intumescent sheet seam, fasteners spaced max 6 in. (152 mm) OC. Prior to installation of the intumescent sheet(s), a nom 1/4 in. (6 mm) diam continuous bead of caulk (Item 5) shall be applied as gasket over the steel support channel.

*Bearing the UL Classification Mark

Reprinted from the Online Certifications Directory with permission from Underwriters Laboratories Inc.
Copyright © 2010 Underwriters Laboratories Inc.®



System No. C-AJ-8003

May 09, 2013

F Rating – 1 Hr

T Rating – 0 Hr

L Rating At Ambient – Less Than 1 CFM/sq ft

L Rating At 400 F – Less Than 1 CFM/sq ft

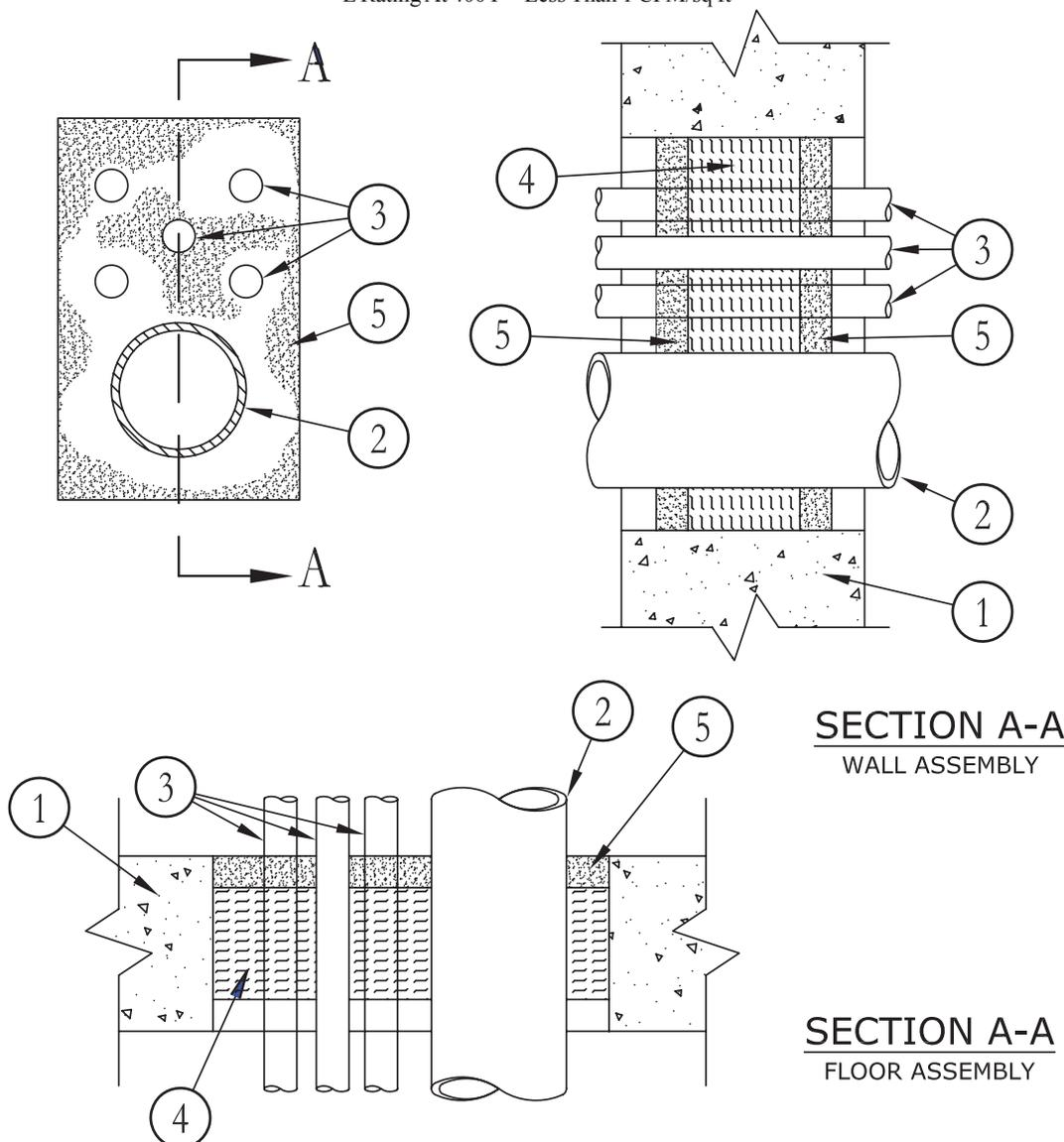

- Floor or Wall Assembly** – Min 5 in. (127 mm) thick reinforced normal weight (100-150 pcf or 1600-2400 kg/m³) concrete. Wall may also be constructed of any UL Classified **Concrete Blocks***. Max area of opening is 40 in. (1016 mm) with max dimension of 8 in. (203 mm). See **Concrete Blocks (CAZT)** category in the Fire Resistance Directory for names of manufacturers.
- Through-Penetrants** – One metallic pipe or conduit to be installed within the firestop system. The annular space between the pipe or conduit and periphery of opening shall be min 1/2 in. (13 mm). Pipe or conduit to be rigidly supported on both sides of floor or wall assembly. The following types and sizes of metallic pipes or conduits may be used:
 - Steel Pipe** – Nom 3 in. (76 mm) diam (or smaller) Schedule 5 (or heavier) steel pipe.
 - Conduit** – Nom 3 in. (76 mm) diam electrical metallic tubing or steel conduit.
- Cables** – Max five 7/C No. 12 AWG polyvinyl chloride (PVC) or cross-linked polyethylene (XLPE) insulated/PVC jacketed cables spaced a min of 1/2 in. (13 mm) apart and located a min of 2 in. (51 mm) from steel pipe and a min of 1/2 in. (13 mm) from periphery of opening.
- Packing Material** – Min 3 in. (76 mm) thickness of min 4 pcf (64 kg/m³) mineral wool batt insulation firmly packed into opening as a permanent form. Packing material to be recessed from top surface of floor as required to accommodate the required thickness of fill material. Packing material to be centered in walls mid-depth and recessed to allow for installation of fill material.
- Fill, Void or Cavity Material* – Sealant** – Min 1/2 in. (13 mm) thickness of fill material applied within the annulus, flush with top surface of floor. In walls, fill material to be applied on each side of packing material. Sealant to be forced into interstices of cable group to max extent possible.

3M COMPANY – Type FB-1000 NS, FB-1003SL (floors only), FB-2000 or FB-2000+.

*Bearing the UL Classification Mark

Reprinted from the Online Certifications Directory with permission from UL

© 2013 UL LLC



System No. C-AJ-8013

September 03, 2004

(Formerly System No. 395)

F Rating – 3 Hr

T Ratings – 0, 1/2, 1 and 3 Hr (See Item 3)

L Rating At Ambient – 2 CFM/sq ft

L Rating At 400 F – less than 1 CFM/sq ft

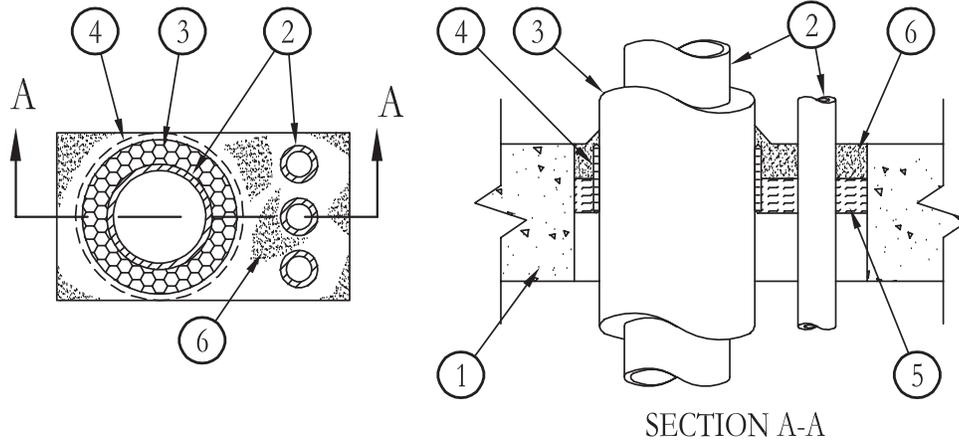

- Floor or Wall Assembly** – Min 2-1/2 in. (64 mm) thick lightweight or normal weight (100-150 pcf or 1600-2400 kg/m³) concrete. Wall may also be constructed of any UL Classified **Concrete Blocks***. Max area of square, rectangular or circular opening is 45 sq in. (290 cm²) with max dimension of 9 in. (229 mm).
See **Concrete Blocks** (CAZT) category in the Fire Resistance Directory for names of manufacturers.
- Pipe** – Nom 3 in. (76 mm) diam (or smaller) Type L (or heavier) copper pipe, nom 2-1/2 in. (64 mm) diam (or smaller) Schedule 10 (or heavier) steel pipe and/or nom 1 in. diam (or smaller) Schedule 40 (or heavier) polyvinyl chloride (PVC) pipe in closed (process or supply) or vented (drain, waste, vent) piping systems. One or more pipes may be installed with a min clearance of 1/2 in. (13 mm) maintained between pipes and with a min clearance of 1/4 in. (6 mm) maintained between pipe and sides of through opening. When pipe insulation material (Item 3) is used, a min clearance of 1/2 in. (13 mm) shall be maintained between insulated and/or uninsulated pipes and a min clearance of 1/4 in. shall be maintained between insulated pipe and sides of through opening. When cables (Item 3A) are used, a min clearance of 1/2 in. (13 mm) shall be maintained between cables and pipes and a min clearance of 1/4 in. (6 mm) shall be maintained between cables and sides of through opening. When PVC pipe is included in opening containing copper or steel pipes, each copper or steel pipe must be provided with pipe insulation (Item 3). Pipes to be rigidly supported on both sides of floor or wall assembly.
- Pipe Insulation – Plastics+** – (Optional) – Nom 3/4 in. (19 mm) thick acrylonitrile butadiene/polyvinyl chloride (AB/PVC) flexible foam furnished in the form of tubing with skin. When uninsulated steel or copper pipes are used, T Rating is 0 hr. When nom 2-1/2 or 3 in. (64 mm or 76 mm) diam insulated steel or copper pipe is used, T Rating is 1/2 hr. When max 2 in. (51 mm) diam insulated steel or copper pipe is used, T Rating is 1 hr. When max 1 in. (25 mm) diam PVC pipe is used, T Rating is 3 hr.
See **Plastics+** (QMFZ2) category in the Recognized Component Directory for names of manufacturers. Any Recognized Component tube insulation material meeting the above specifications and having a UL94 Flammability Classification of 94-5VA may be used.
- Cables** – (not show) – A max of two cables may be used. Max 8/C No. 12 AWG multiconductor power and control cables; XLPE or PVC insulation with XLPE or PVC jacket.
- Fill, Void or Cavity Materials* – Wrap Strip** – Nom 1/4 in. (6 mm) thick intumescent elastomeric material faced on one side with aluminum foil, supplied in 2 in. (51 mm) wide strips. One nom 2 in. (51 mm) wide strip tightly-wrapped around pipe insulation (Item 3) and PVC pipe with the foil side exposed and slid into through opening such that the top edge is flush with top surface of floor. When a single insulated pipe is installed in a circular through opening and when the max annular space between the insulated pipe and the sides of the through opening is 3/8 in., (9.5 mm) the wrap strip layer may be secured in place with pressure-sensitive tape. In all other situations, the wrap strip layer shall be secured in place with min No. 18 gauge galv steel tie wire. In wall assemblies, the wrap strip layer is to be installed on the insulated pipe and PVC pipe in the same manner used for floor assemblies but shall be installed symmetrically on both sides of the wall. When no pipe insulation is used (bare copper or steel pipe with no PVC pipe in opening), no wrap strip material is required.
3M COMPANY – Type FS-195+
- Packing Material** – Min 1 in. (25 mm) thick mineral wool batt insulation firmly packed into opening with its top surface recessed min 1 in. (25 mm) from top surface of the floor. In wall assemblies, packing material to be firmly packed into opening on both sides of wall and recessed min 1 in. (25 mm) from wall surface. When a single insulated pipe (with wrap strip layer) is installed in a circular through opening and when the max annular space between the wrap strip layer and the sides of the through opening is 1/8 in. (3.2 mm), no forming material is required.
- Fill, Void or Cavity Materials* – Caulk or Sealant** – Applied to fill through opening to a min depth of 1 in. (25 mm). In floor assemblies, fill material to be installed flush with top surface of floor. In wall assemblies, fill material to be installed flush with wall surface on both sides of wall.

3M COMPANY – CP 25WB+ caulk or FB-3000 WT sealant.

*Bearing the UL Classification Mark

Reprinted from the Online Certifications Directory with permission from Underwriters Laboratories Inc.
Copyright © 2010 Underwriters Laboratories Inc.®



Note: Systems with Nonmetallic Through Penetrant(s) have not been evaluated with a pressure differential of 50 Pa between the exposed and unexposed surfaces as required by the National Building Code of Canada.

System No. C-AJ-8060

May 18, 2005

F Rating – 1 Hr

T Rating – 0 Hr

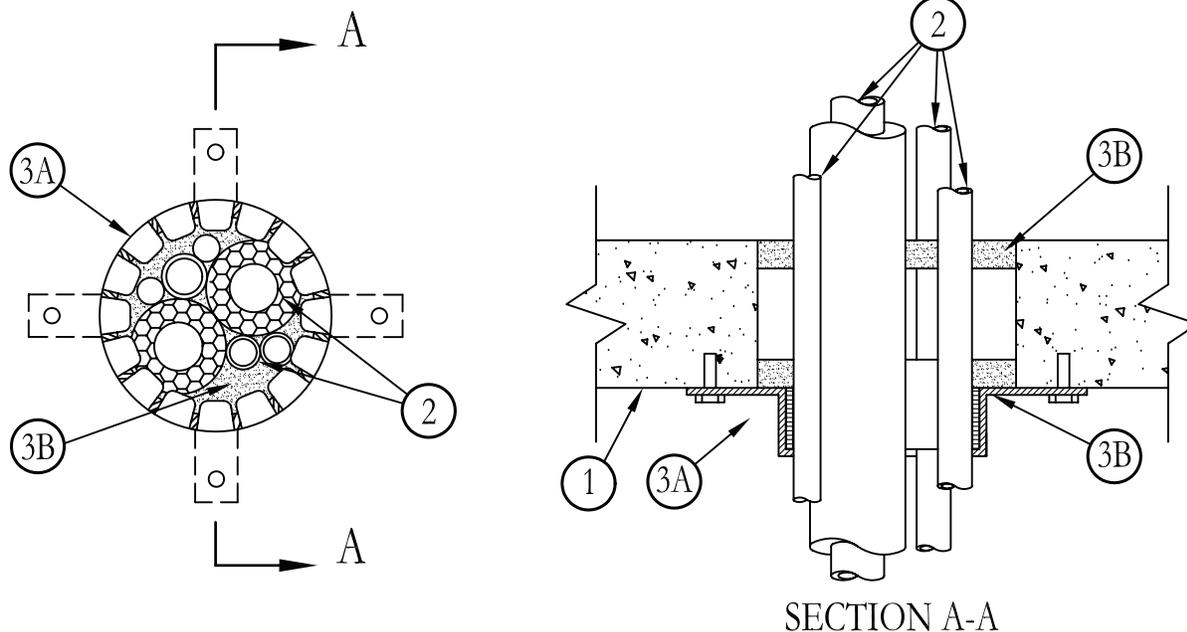

- Floor or Wall Assembly** – Min 2-1/2 in. (64 mm) thick reinforced lightweight or normal weight (100-150 pcf or 1600-2400 kg/m³) concrete. Wall may also be constructed of any UL Classified **Concrete Blocks***. Floor may also be constructed of any min 6 in. (152 mm) thick UL Classified hollow-core **Precast Concrete Units***. Max diam of opening is 4-1/2 in. (114 mm).

See **Concrete Blocks (CAZT)** and **Precast Concrete Units (CFTV)** categories in the Fire Resistance Directory for names of manufacturers.

- Through Penetrants** – Pipes, conduits, tubing or cables to be bundled within the opening such that the aggregate cross-sectional area of penetrants in opening to be min 42 percent to max 54 percent of the cross-sectional area of the opening in floor or wall. A min 1/4 in. (6 mm) annular space shall be maintained around uninsulated metallic pipes. The space between penetrants and periphery of opening shall be min 1/4 in. (6 mm). Penetrants to be rigidly supported on both sides of floor or wall assembly. The following types and sizes of penetrants may be used:

A. **Metallic Pipes** – The following types and sizes of metallic pipes, conduits or tubing may be used:

- Steel Pipe** – Nom 3/4 in. (19 mm) diam (or smaller) Schedule 5 (or heavier) steel pipe.
- Conduit** – Nom 3/4 in. (19 mm) diam (or smaller) electrical metallic tubing or steel conduit.
- Copper Tubing** – Nom 3/4 in. (19 mm) diam (or smaller) Type L (or heavier) copper tubing.
- Copper Pipe** – Nom 3/4 in. (19 mm) diam (or smaller) Regular (or heavier) copper pipe.

All pipes, conduits or tubing larger than nom 1/2 in. (13 mm) diam shall be provided with pipe covering (Item 3).

B. **Nonmetallic Pipes** – A max of one nonmetallic pipe or conduit may be used. A min 1/4 in. (6 mm) space must be maintained between uninsulated metallic pipes and nonmetallic pipes or conduits. The following types and sizes of nonmetallic pipes or conduits may be used:

- Polyvinyl Chloride (PVC) Pipe cv** – Nom 1-1/4 in. (32 mm) diam (or smaller) Schedule 40 solid core PVC pipe for use in closed (process or supply) or vented (drain, waste or vent) piping system.
- Chlorinated Polyvinyl Chloride (CPVC) Pipe** – Nom 1-1/4 in. (32 mm) diam (or smaller) SDR13.5 CPVC pipe for use in closed (process or supply) piping systems.
- Rigid Nonmetallic Conduit++** – Nom 1-1/4 in. (32 mm) diam (or smaller) Schedule 40 PVC conduit installed in accordance with Article 347 of the National Electrical Code (NFPA No. 70).

C. **Cables** – Max 7/C No. 12 AWG multi conductor power and control cables; XLPE or PVC insulation with XLPE or PVC jacket.

D. **Pipe Covering** – The following types and sizes of pipe coverings may be used with the metallic pipes:

- Tube Insulation – Plastics+++** – Nom 1/2 in. (13 mm) thick acrylonitrile butadiene/polyvinyl chloride (AB/PVC) flexible foam furnished in the form of tubing.

See **Plastics+++ (QMFZ2)** category in the Plastics Recognized Component Directory for names of manufacturers. Any Recognized Component tube insulation material meeting the above specifications and having a UL94 Flammability Classification of 94-5VA may be used.

- Pipe Covering*** – Nom 1/2 in. (13 mm) thick hollow cylindrical heavy density (min 3.5 pcf or 56 kg/m³) glass fiber units jacketed on the outside with an all service jacket. Longitudinal joints sealed with metal fasteners or factory-applied self-sealing lap tape. Transverse joints secured with metal fasteners or with butt tape supplied with the product.

See **Pipe and Equipment Covering – Materials* (BRGU)** category in the Building Materials Directory for names of manufacturers. Any pipe covering material meeting the above specifications and bearing the UL Classification Marking with a Flame Spread Index of 25 or less and a Smoke Developed Index of 50 or less may be used.

Through Penetrations

Compos

8000 Series

Concrete

CAJ

System No. C-AJ-8060 *continued*

3. **Firestop System** – The details of the firestop system shall be as follows:

- A. **Firestop Device*** – Firestop device consisting of a steel collar lined with intumescent material and provided with steel clips for attachment to underside of floor or both sides of wall in accordance with accompanying installation instructions. The following firestop devices are to be used, dependent on the max opening size.

| Max Opening Size In. (mm) | Firestop Device |
|---------------------------|-----------------|
| 3-1/2 (89) | PPD 3 |
| 4-1/2 (114) | PPD 4 |

3M COMPANY

- B. **Fill, Void or Cavity Materials* – Caulk, Sealant or Putty** – When PPD 3 firestop device is used, min 1 in. (25 mm) thickness of caulk or putty applied to completely fill annular space inside of firestop device and between penetrants, flush with the bottom surface of floor and extending downward. When PPD 4 firestop device is used, min 2 in. (51 mm) thickness of caulk or putty applied to completely fill annular space inside of firestop device and between penetrants, flush with the bottom surface of floor or and extending downward. Min 5/8 in. (16 mm) thickness of caulk or putty applied within annular space between penetrants and periphery of opening flush with bottom surface of floor. Min 3/4 in. (19 mm) thickness of caulk or putty applied to completely fill annular space, flush with top surface of floor. In walls, min 5/8 in. (16 mm) thickness of caulk or putty applied within annular space between penetrants and periphery of opening flush with both surfaces of wall. Min 1 in. or 2 in. (25 mm or 51 mm) thickness of caulk or putty for PPD 3 and PPD 4 devices, respectively, applied to completely fill annular space inside of firestop devices and between penetrants, flush with both surfaces of wall and extending outward.

3M COMPANY – CP25WB+, IC 15WB+ caulk, FB-3000 WT sealant or MP+ Stix putty.)

(Note: CP 25WB+ not suitable for use with CPVC pipes.)

*Bearing the UL Classification Marking

++Bearing the UL Listing Mark

+++Bearing the UL Recognized Component Marking

Reprinted from the Online Certifications Directory with permission from Underwriters Laboratories Inc.
Copyright © 2010 Underwriters Laboratories Inc.®



Note: Systems with Nonmetallic Through Penetrant(s) have not been evaluated with a pressure differential of 50 Pa between the exposed and unexposed surfaces as required by the National Building Code of Canada.

Through Penetrations

Compos

8000 Series

Concrete

CAJ

System No. C-AJ-8069

May 18, 2005

F Rating – 2 Hr

T Rating – 0 Hr

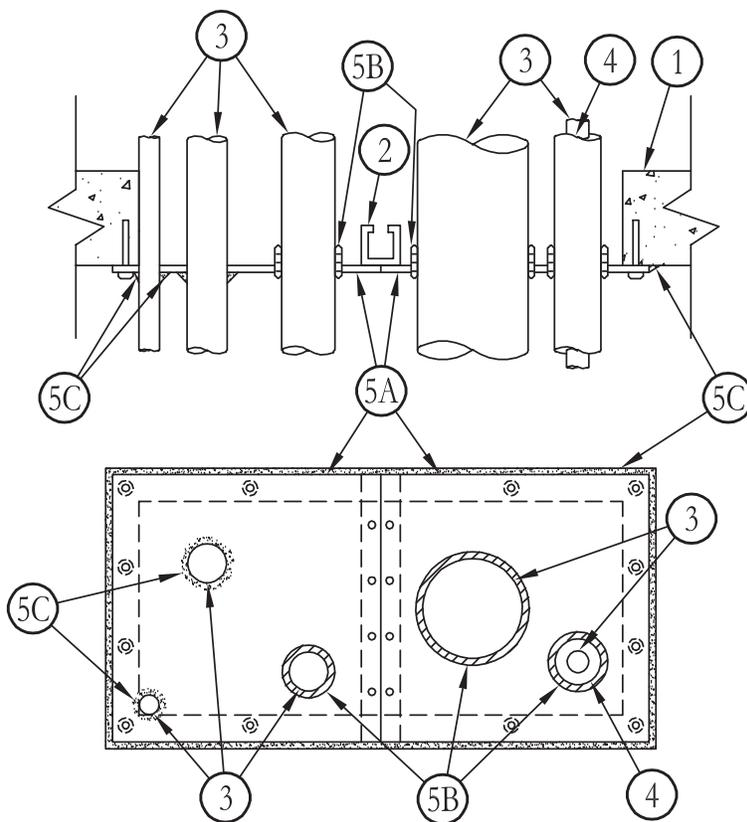

- 1. Floor or Wall Assembly** – Min 4-1/2 in. (114 mm) thick reinforced lightweight or normal weight (100-150 pcf or 1600-2400 kg/m³) concrete. Wall may also be constructed of any UL Classified **Concrete Blocks***. Max area of opening 3 sq ft (2787 cm²) with max dimension of 36 in. (914 mm).

See **Concrete Block (CAZT)** category in the Fire Resistance Directory for names of manufacturers.

- 2. Support Channel** – Support channel shall be installed flush with bottom surface of floor or both sides of wall, midway in opening. Support channel not required for openings with a max dimension of 18 in. (457 mm) or less. Support channels to be min 1-5/8 in. by 1-5/8 in. (41 mm by 41 mm) and formed of min 0.093 in. (2.4 mm) thick (No. 12 gauge) painted or galv steel. Ends of steel channel bolted or welded to steel angles anchored to inside walls of through opening using min 1/4 in. (6 mm) diam by 1-1/2 in. (38 mm) long steel expansion bolts, or equivalent, in conjunction with steel nuts and washers.
- 3. Through Penetrants** – Multiple metallic pipes, conduits or tubings to be installed either concentrically within the firestop system. Min 1 in. (25 mm) clearance between pipes. Min clearance between uninsulated penetrants and wall of through opening 1/4 in. (6 mm). When single nom 4 in. (102 mm) diam (or smaller) steel pipe or conduit or nom 2 in. (51 mm) diam (or smaller) copper tube or pipe is installed, min clearance between pipe, tube, conduit or EMT and wall of through opening is 0 in. (0 mm) (point contact). Clearance between penetrants shall be min 1 in. (25 mm). Pipe and conduits rigidly supported on both sides of floor or wall assembly. The following types and sizes of metallic pipes, conduits or tubing may be used:
 - A. Steel Pipe** – Nom 6 in. (152 mm) diam (or smaller) Schedule 10 (or heavier) or nom 4 in. (102 mm) diam (or smaller) Schedule 5 (or heavier) steel pipe.
 - B. Iron Pipe** – Nom 6 in. (152 mm) diam (or smaller) cast or ductile iron pipe.
 - C. Conduit** – Nom 4 in. (102 mm) diam (or smaller) steel electrical metallic tubing or steel conduit.
 - D. Copper Tubing** – Nom 4 in. (102 mm) diam (or smaller) Type L (or heavier) copper tube.
 - E. Copper Pipe** – Nom 4 in. (102 mm) diam (or smaller) Regular (or heavier) copper pipe.
- 4. Tube Insulation – Plastics++** – Nom 1/2 in. (13 mm) thick acrylonitrile butadiene/polyvinyl chloride (AB/PVC) flexible foam furnished in the form of tubing. For use with penetrants having a nom 2 in. (51 mm) diam and less. The annular space between the insulated pipe and the edge of the through opening shall be min 1/4 in. (6 mm).

See **Plastics (QMFZ2)** category in the Recognized Component Directory for names of manufacturers. Any Recognized Component tube insulation material meeting the above specifications and having a UL94 Flammability Classification of 94-5VA may be used.

- 5. Firestop System** – The details of the firestop system shall be as follows:
 - A. Fill, Void or Cavity Materials* – Intumescent Sheet** – Rigid aluminum foil-faced sheets with galv steel sheet backer. Sheet cut to tightly follow the contours of the penetrants or wrap strip (Item 5B) and to lap a min of 3 in. (76 mm) on the floor surface on all sides of the through opening. Sheets to be installed with the galv steel sheet backer exposed (aluminum foil facing against floor or wall surfaces). Sheets secured to bottom side of floor or both sides of wall using min 1/4 in. (6 mm) diam by 1-1/2 in. (38 mm) long steel

System No. C-AJ-8069 *continued*

expansion bolts, or equivalent, in conjunction with steel nuts and washers. Max spacing of sheet fasteners not to exceed 4 in. (6 mm) OC. Intumescent sheet secured to steel support channels (Item 2) with steel sheet metal screws in conjunction with min 1-1/4 in. (32 mm) diam steel fender washers spaced max 3 in. (76 mm) OC. When support channel is used beneath butted seam of intumescent sheets, fasteners spaced max 3 in. (76 mm) OC on each side of butted seam. Seams cut to permit installation around penetrants are provided with min 2 in. (51 mm) wide strip of min 0.016 in. (0.41 mm) thick (28 gauge) galv steel (not shown) centered over entire length of seam. Prior to installation of the steel strip, seam in intumescent sheet covered with nom 1/4 in. (6 mm) diam bead of caulk (Item 5C). Steel cover strip secured to galv steel backer of intumescent sheet with steel sheet-metal screws or steel rivets spaced max 3 in. (76 mm) OC on each side of seam.

3M COMPANY – CS-195+

- B. **Fill, Void or Cavity Materials*** – **Wrap Strip** – Nom 1/4 in. (6 mm) thick intumescent material supplied in 2 in. (51 mm) wide strips. Min one layer of wrap strip wrapped around penetrants and pipe insulation and secured in place with steel wire or aluminum foil tape. Wrap strip to extend approx 7/8 in. (22 mm) beyond each face of the intumescent sheet (Item 5A). When nom 4 in. (102 mm) diam (or smaller) uninsulated steel pipe or conduit or nom 2 in. (51 mm) diam (or smaller) uninsulated copper tube or pipe is installed in through opening, no wrap strip is required.

3M COMPANY – FS-195+

- C. **Fill, Void or Cavity Materials*** – **Caulk or Sealant** – Min 1/4 in. (6 mm) diam continuous bead applied to edge of intumescent sheet at its interface with surface of floor around entire perimeter of through opening. Min 1/4 in. (6 mm) diam bead applied at perimeter of penetrants not using wrap strips at the penetrant/intumescent sheet interface on bottom side of floor or both sides or wall.

3M COMPANY – CP 25WB+, IC 15WB+ caulk or FB-3000 WT sealant.

*Bearing the UL Classification Marking

Reprinted from the Online Certifications Directory with permission from Underwriters Laboratories Inc.
Copyright © 2010 Underwriters Laboratories Inc.®



Through Penetrations

Compos

8000 Series

Concrete

CAJ

System No. C-AJ-8072

September 07, 2004

F Rating – 2 Hr

T Ratings – 0, 1/4, 1/2, & 1 Hr (See Item 2)

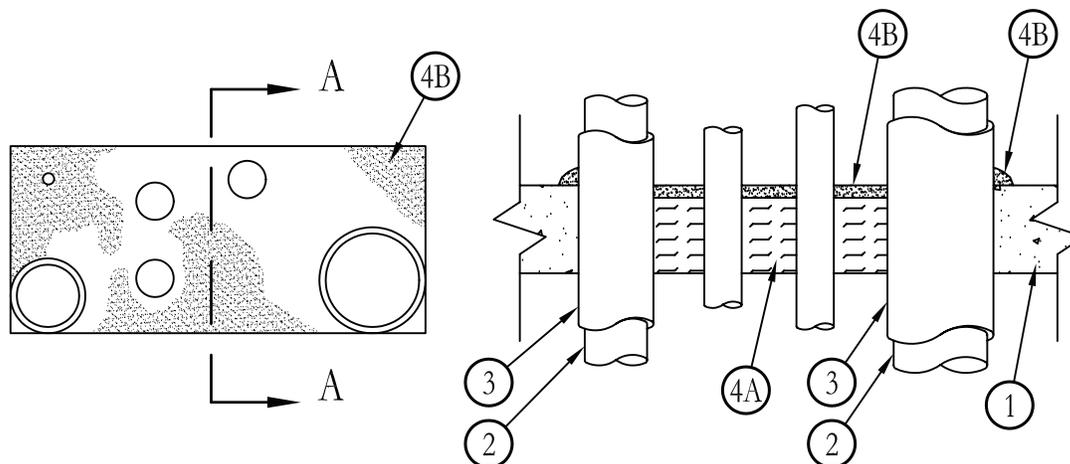

SECTION A-A

1. **Floor or Wall Assembly** – Min 4-1/2 in. thick reinforced lightweight or normal weight (100-150 pcf) concrete floor or min 5 in. thick reinforced lightweight or normal weight concrete wall. Wall may also be constructed of any UL Classified **Concrete Blocks***. Max area of opening 84 square in. with max dimension of 14 in.

See **Concrete Blocks** (CAZT) category in the Fire Resistance Directory for names of manufacturers.

2. **Through Penetrants** – Multiple metallic pipes, conduits, tubings or cables to be installed within the firestop system. Min 1/2 in. clearance between penetrants. Min clearance between uninsulated penetrants or cables and wall of through opening 0 in. (point contact). Penetrants rigidly supported on both sides of floor or wall assembly. The following types and sizes of metallic pipes, conduits, tubings or cables may be used:

- A. **Steel Pipe** – Nom 2 in. diam (or smaller) Schedule 5 (or heavier) steel pipe.
- B. **Iron Pipe** – Nom 2 in. diam (or smaller) cast or ductile iron pipe.
- C. **Conduit** – Nom 2 in. diam (or smaller) steel electrical metallic tubing or steel conduit.
- D. **Copper Tubing** – Nom 2 in. diam (or smaller) Type L (or heavier) copper tube.
- E. **Copper Pipe** – Nom 2 in. diam (or smaller) Regular (or heavier) copper pipe.
- F. **Cable** – Max 7/C No. 12 AWG (or smaller) copper conductor cable with PVC insulation and jacket.

The hourly T Rating is 1/4 hr when penetrants A, B and C are used, 0 hr when penetrants D and E are used and 1/2 hr when penetrant F is used. The hourly T Rating is 1 hr when penetrants A, B, C, D and E are used with pipe insulation (Item 3).

3. **Pipe Insulation** (Optional) – The following types of pipe insulation may be used:

- A. **Pipe Covering*** – Nom 1-1/2 in. thick (or thinner) hollow cylindrical heavy density glass fiber units jacketed on the outside with an all service jacket. Longitudinal joints sealed with metal fasteners or factory-applied self-sealing lap tape. Transverse joints secured with metal fasteners or with butt tape supplied with the product. The annular space between the insulated pipe and the edge of the through opening shall be min 0 in. (point contact).

See **Pipe and Equipment Covering – Materials*** (BRGU) category in the Building Materials Directory for names of manufacturers. Any pipe covering material meeting the above specifications and bearing the UL Classification Marking with a Flame Spread Index of 25 or less and a Smoke Developed Index of 50 or less may be used.

- B. **Tube Insulation – Plastics++** – Nom 3/4 in. thick (or thinner) acrylonitrile butadiene/polyvinyl chloride (AB/PVC) flexible foam furnished in the form of tubing. The annular space between the insulated pipe and the edge of the through opening shall be min 0 in. (point contact).

See **Plastics** (QMFZ2) category in the Plastics Recognized Component Directory for names of manufacturers. Any Recognized Component tube insulation material meeting the above specifications and having a UL 94 Flammability Classification of 94-5VA may be used.

4. **Firestop System** – The details of the firestop system shall be as follows:

- A. **Packing Material** – Min 4 in. thickness of min 4 pcf mineral wool batt insulation firmly packed into opening as a permanent form. Packing material to be recessed from top surface of floor or from both surfaces of wall as required to accommodate the required thickness of fill material.
- B. **Fill, Void or Cavity Materials* – Caulk or Sealant** – Min 1/2 in. thickness of fill material applied within the annulus, flush with top surface of floor or with both surfaces of wall. Min 1/2 in. diam bead of caulk applied to the concrete/penetrant interface at the point contact location on the top surface of floor or both surfaces of wall.

3M COMPANY – CP 25WB+ caulk or FB-3000 WT sealant.

*Bearing the UL Classification Marking

++Bearing the UL Recognized Component Marking

Reprinted from the Online Certifications Directory with permission from Underwriters Laboratories Inc.

Copyright © 2010 Underwriters Laboratories Inc.®



System No. C-AJ-8073

September 07, 2004

F Rating – 2 Hr

T Ratings – 0, 3/4 and 2 Hr

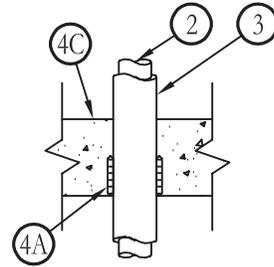
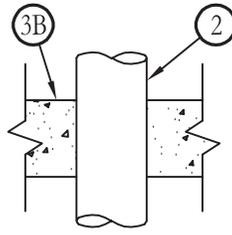
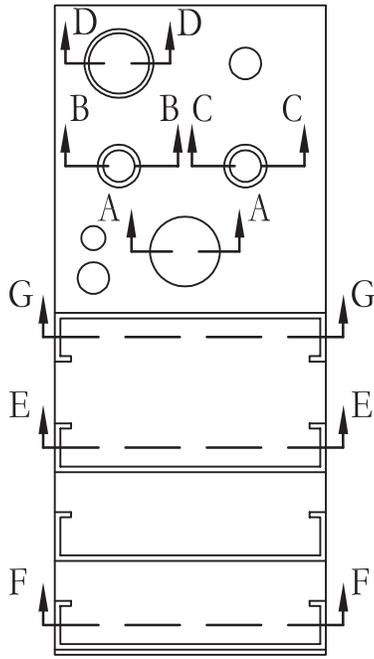

SECTION A-A
FIRESTOP
CONFIGURATION A

SECTION B-B
FIRESTOP
CONFIGURATION B

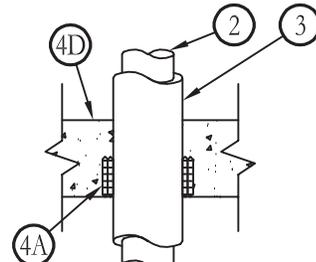
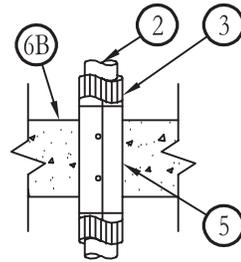

SECTION C-C
FIRESTOP
CONFIGURATION C

SECTION D-D
FIRESTOP
CONFIGURATION D

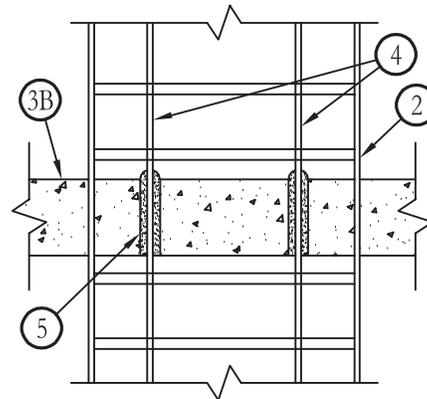
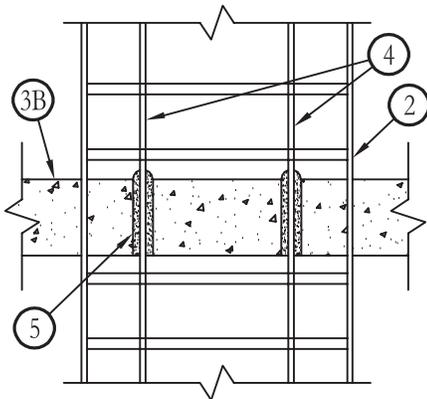

SECTION E-E
FIRESTOP
CONFIGURATION E

SECTION F-F
FIRESTOP
CONFIGURATION F

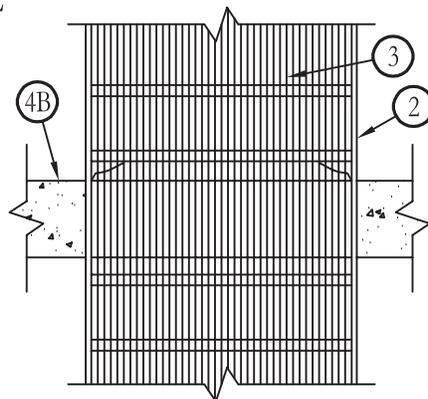

SECTION G-G
FIRESTOP
CONFIGURATION G

System No. C-AJ-8073 *continued*

1. **Floor or Wall Assembly** – Min 4-1/2 in. thick reinforced normal weight (140-150 pcf) concrete. Wall may also be constructed of any UL Classified **Concrete Blocks***. Max area of opening is 24 sq ft with max dimension of 8 ft.
See **Concrete Blocks** (CAZT) category in the Fire Resistance Directory for names of manufacturers.
2. **Through Penetrants** – A max of seven firestop configurations complying with Firestop Configuration A, B, C or D, and a max of four firestop configurations complying with Firestop Configuration E, F or G may be installed within the opening in any combination. The annular space between penetrating items and periphery of opening shall be as specified in the individual firestop configurations. The maximum open area within the opening shall be 480 sq in. with smaller dimension not exceeding 10 in. Pipe, conduit, tubing, cable tray or cable to be rigidly supported on both sides of floor or wall assembly. The T Rating of the system is dependent on the firestop configuration, as shown in the table below:

| Firestop Config | T Rating Hr |
|-----------------|-------------|
| A | 0 |
| B | 0 |
| C | 3/4 |
| D | 2 |
| E | 0 |
| F | 0 |
| G | 0 |

Firestop Configuration A

2. **Metallic Penetrants** – One metallic pipe, conduit or tubing to be installed within this firestop configuration. The annular space between pipes, conduit and tubing with a nom diam of 4 in. or less and the periphery of the opening shall be min 1/4 in. The annular space between pipes, conduit and tubing with a nom diam greater than 4 in. and the periphery of the opening shall be min 4-1/4 in. The annular space between pipes, conduit or tubing with a diam of 4 in. or less and other non-insulated penetrating items shall be min 1/2 in. The annular space between pipes, conduit and tubing with a nom diam greater than 4 in. and other non-insulated penetrating items shall be min 4-3/4 in. The following types and sizes of metallic pipes, conduits or tubing may be used:
 - A. **Steel Pipe** – Nom 8 in. diam (or smaller) Schedule 40 (or heavier) steel pipe.
 - B. **Iron Pipe** – Nom 8 in. diam (or smaller) cast or ductile iron pipe.
 - C. **Conduit** – Nom 3 in. diam (or smaller) steel electrical metallic tubing or nom 6 in. diam (or smaller) steel conduit.
 - D. **Copper Tubing** – Nom 3 in. diam (or smaller) Type M (or heavier) copper tubing.
 - E. **Copper Pipe** – Nom 3 in. diam (or smaller) Regular (or heavier) copper pipe.
3. **Firestop System** – The firestop system shall consist of the following:
 - A. **Forms** (Not Shown) – Used as a form to prevent leakage of mortar during installation. Forms to be a rigid sheet material, cut to fit the contour of the penetrating item and fastened to the underside of floor or both sides of wall. Forms to be removed after mortar has cured.
 - B. **Fill, Void or Cavity Materials* – Mortar** – Min 3 in. thickness of mortar applied within the annulus, flush with top surface of floor or with both surfaces of wall. Cementitious mortar mixed with water at a rate of 1.0 part dry mixture to 0.3 parts water by weight in accordance with the installation instructions supplied with the product.
3M COMPANY – 3M Fire Barrier Mortar

Firestop Configuration B

2. **Metallic Penetrants** – One metallic pipe or tubing to be installed within this firestop configuration. The following types and sizes of metallic pipes or tubing may be used:
 - A. **Steel Pipe** – Nom 3 in. diam (or smaller) Schedule 10 (or heavier) steel pipe.
 - B. **Iron Pipe** – Nom 3 in. diam (or smaller) cast or ductile iron pipe.
 - C. **Copper Tubing** – Nom 3 in. diam (or smaller) Type M (or heavier) copper tubing.
 - D. **Copper Pipe** – Nom 3 in. diam (or smaller) Regular (or heavier) copper pipe.
3. **Tube Insulation – Plastics**** – Nom 3/4 in. thick acrylonitrile butadiene/polyvinyl chloride (AB/PVC) flexible foam furnished in the form of tubing. The annular space between the insulated pipe or tubing and periphery of opening shall be min 6-1/2 in. The annular space between insulated pipe or tubing and other adjacent insulated penetrating items shall be min 1 in. The annular space between insulated pipe or tubing and other adjacent uninsulated penetrating items or cable trays shall be min 5 in.
See **Plastics**** (QMFZ2) category in the Plastics Recognized Component Directory for names of manufacturers. Any Recognized Component tube insulation material meeting the above specifications and having a UL 94 Flammability Classification of 94-5VA may be used.
4. **Firestop System** – The firestop system shall consist of the following:
 - A. **Fill, Void or Cavity Materials* – Wrap Strip** – Nom 1/4 in. thick intumescent elastomeric material faced on one side with aluminum foil, supplied in 2 in. wide strips. One nom 2 in. wide strip tightly-wrapped around tube insulation (Item 3) with ends butted and foil side exposed, and slid into through opening such that the bottom edge is flush with bottom surface of mortar in floors or both surfaces of mortar in walls. Wrap strip held in place with pressure-sensitive tape, steel tie wire, or equivalent.
3M COMPANY – FS-195+
 - B. **Forms** (Not Shown) – Used as a form to prevent leakage of mortar during installation. Forms to be a rigid sheet material, cut to fit the contour of the penetrating item and fastened to the underside of floor or both sides of wall. Forms to be removed after mortar has cured.
 - C. **Fill, Void or Cavity Materials* – Mortar** – Min 3 in. thickness of mortar applied within the annulus, flush with top surface of floor or with both surfaces of wall. Cementitious mortar mixed with water at a rate of 1.0 part dry mixture to 0.3 parts water by weight in

System No. C-AJ-8073 *continued*

accordance with the installation instructions supplied with the product.

3M COMPANY – 3M Fire Barrier Mortar

Firestop Configuration C

2. **Metallic Penetrants** – One metallic pipe to be installed within the opening. The following types and sizes of metallic pipes may be used:
 - A. **Steel Pipe** – Nom 3 in. diam (or smaller) Schedule 10 (or heavier) steel pipe.
 - B. **Iron Pipe** – Nom 3 in. diam (or smaller) cast or ductile iron pipe.
3. **Pipe Covering Materials* – Cellular Glass Insulation** – Nom 1 in. thick cellular glass units sized to the outside diam of pipe and supplied in nom 24 in. long half sections or nom 18 in. long segments. Pipe insulation installed on pipe in accordance with the manufacturer's instructions. The annular space between the insulated pipe and periphery of opening shall be min 6 in. The annular space between insulated pipe and other adjacent penetrating items shall be min 4-1/4 in.
4. **Fill, Void or Cavity Materials* – Caulk or Sealant** – (Not Shown) Nom 1/4 in. diam bead of caulk applied between adjacent sections of pipe covering material at longitudinal and transverse joints.

3M COMPANY – CP 25WB+ caulk or FB-3000 WT sealant.
5. **Metal Jacket** – Jacket, formed of min 0.015 in. thick aluminum sheet cut to wrap tightly around the pipe insulation with a min 2 in. lap and secured using min 18 gauge steel tie wire spaced 16 in. OC and nom 3/8 in. diam steel screws, located 1/2 in. from top of floor or both surfaces of wall.
6. **Firestop System** – The firestop system shall consist of the following:
 - A. **Forms** (Not Shown) – Used as a form to prevent leakage of mortar during installation. Forms to be a rigid sheet material, cut to fit the contour of the penetrating item and fastened to the underside of floor or both sides of wall. Forms to be removed after mortar has cured.
 - B. **Fill, Void or Cavity Materials* – Mortar** – Min 3 in. thickness of mortar applied within the annulus, flush with top surface of floor or with both surfaces of wall. Cementitious mortar mixed with water at a rate of 1.0 part dry mixture to 0.3 parts water by weight in accordance with the installation instructions supplied with the product.

3M COMPANY – 3M Fire Barrier Mortar

Firestop Configuration D

2. **Metallic Penetrants** – One metallic pipe, conduit or tubing to be installed within the opening. The following types and sizes of metallic pipes, conduits or tubing may be used:
 - A. **Steel Pipe** – Nom 10 in. diam (or smaller) Schedule 10 (or heavier) steel pipe.
 - B. **Iron Pipe** – Nom 10 in. diam (or smaller) cast or ductile iron pipe.
3. **Pipe Covering Material* – Fiberglass Insulation** – Nom 2 in. thick hollow cylindrical heavy density glass fiber units jacketed on the outside with an all service jacket. Longitudinal joints sealed with metal fasteners or factory-applied self-sealing lap tape. Transverse joints secured with metal fasteners or with butt tape supplied with the product. The annular space between the insulated pipe and periphery of opening shall be min 2-1/4 in. The annular space between insulated pipe and other adjacent insulated penetrating items shall be min 1 in. The annular space between insulated pipe and other adjacent uninsulated penetrating items or cable trays shall be min 8 in.

See **Pipe and Equipment Covering – Materials*** (BRGU) category in the Building Materials Directory for names of manufacturers. Any pipe covering material meeting the above specifications and bearing the UL Classification Marking with a Flame Spread Index of 25 or less and a Smoke Developed Index of 50 or less may be used.
4. **Firestop System** – The firestop system shall consist of the following:
 - A. **Fill, Void or Cavity Materials* – Wrap Strip** – Nom 1/4 in. thick intumescent elastomeric material faced on one side with aluminum foil, supplied in 2 in. wide strips. Two nom 2 in. wide strips tightly-wrapped around pipe covering material (Item 3) with the foil side exposed and slid into through opening such that the bottom edge is flush with bottom surface of mortar in floors or both surfaces of mortar in walls. Each layer of wrap strip to be installed with butted seam with butted seams in successive layers staggered. Wrap strip held in place with pressure-sensitive tape, steel tie wire, or equivalent.

3M COMPANY – FS-195+
 - B. **Fill, Void or Cavity Materials* – Caulk or Sealant** (Not Shown) – Generous bead of caulk applied to fill any voids which exist between pipe covering material and wrap strip.

3M COMPANY – CP 25WB+ caulk or FB-3000 WT sealant.
 - C. **Forms** (Not Shown) – Used as a form to prevent leakage of mortar during installation. Forms to be a rigid sheet material, cut to fit the contour of the penetrating item and fastened to the underside of floor or both sides of wall. Forms to be removed after mortar has cured.
 - D. **Fill, Void or Cavity Materials* – Mortar** – Min 3 in. thickness of mortar applied within the annulus, flush with top surface of floor or with both surfaces of wall. Cementitious mortar mixed with water at a rate of 1.0 part dry mixture to 0.3 parts water by weight in accordance with the installation instructions supplied with the product.

3M COMPANY – 3M Fire Barrier Mortar

Firestop Configuration E

2. **Cable Tray*** – Max 36 in. wide by max 6 in. deep open-ladder or solid back cable tray with channel-shaped side rails formed of galv steel and with rungs spaced 9 in. OC. The annular space between cable trays and the periphery of the opening shall be min 0 in. (point contact) to max 10 in. The annular space between cable trays and other adjacent uninsulated penetrating items shall be min 2 in. The annular space between adjacent cable trays shall be 10 in.
3. **Firestop System** – The firestop system shall consist of the following:
 - A. **Forms** (Not Shown) – Used as a form to prevent leakage of mortar during installation. Forms to be a rigid sheet material, cut to fit the contour of the cable tray and fastened to the underside of floor or both sides of wall. Forms to be removed after mortar has cured.
 - B. **Fill, Void or Cavity Materials* – Mortar** – Min 3 in. thickness of mortar applied within the annulus, flush with top surface of floor

Through Penetrations

Compos

8000 Series

Concrete

CAJ

System No. C-AJ-8073 *continued*

or with both surfaces of wall. Cementitious mortar mixed with water at a rate of 1.0 part dry mixture to 0.3 parts water by weight in accordance with the installation instructions supplied with the product.

3M COMPANY – 3M Fire Barrier Mortar

4. **Cables** – One cable to be centered in each of max two preformed or core-drilled openings within confines of cable tray. Diam of openings to be 1-3/8 in. Openings to be spaced min 21 in. OC and min 2-1/2 in. from back and sides of cable tray. Cables to be rigidly supported on both sides of floor or wall assembly. Any of the following types and sizes of cables may be used:
 - A. Max 1/C 1000 kcmil aluminum conductor cable with cross-linked polyethylene (XLPE) insulation and polyvinyl chloride (PVC) jacket.
 - B. Max 1/C No. 4/0 AWG aluminum conductor cable with cross-linked polyethylene (XLPE) insulation and polyvinyl chloride (PVC) jacket.
 - C. Max 1/C No. 6/0 AWG copper conductor cable with cross-linked polyethylene (XLPE) insulation and polyvinyl chloride (PVC) jacket.
 - D. Max 2/C No. 16 AWG shielded copper conductor cable with flame retardant polyvinyl chloride (FR-PVC) insulation and jacket.
 - E. Max 3/C No. 12 AWG copper conductor cable with flame retardant cross-linked polyethylene (FR-XLPE) insulation and polyvinyl chloride (PVC) jacket.
 - F. Max 3/C No. 4 AWG copper conductor TECK 90 cable with cross-linked polyethylene (XLPE) insulation and polyvinyl chloride (PVC) inner and outer jackets.
5. **Fill, Void or Cavity Materials* – Caulk, Sealant or Putty** – Min 3 in. thickness of caulk or putty applied within the annulus around cables, flush with top surface of floor or with both surfaces of wall. Additional caulk to be installed such that a min 1/4 in. crown is formed around the cables and at any voids between the cable trays and mortar, and between the cable trays and concrete floor or wall.

3M COMPANY – CP 25WB+ caulk, FB-3000 WT sealant or MP+ Stix putty.

Firestop Configuration F

2. **Cable Tray*** – Max 36 in. wide by max 6 in. deep open-ladder or solid back cable tray with channel-shaped side rails formed of galv steel and with rungs spaced 9 in. OC. The annular space between cable trays and the periphery of the opening shall be min 0 in. (point contact) to max 10 in. The annular space between cable trays and other adjacent uninsulated penetrating items shall be min 2 in. The annular space between adjacent cable trays shall be 10 in.
3. **Firestop System** – The firestop system shall consist of the following:
 - A. **Forms** (Not Shown) – Used as a form to prevent leakage of mortar during installation. Forms to be a rigid sheet material, cut to fit the contour of the cable tray and fastened to the underside of floor or both sides of wall. Forms to be removed after mortar has cured.
 - B. **Fill, Void or Cavity Materials* – Mortar** – Min 3 in. thickness of mortar applied within the annulus, flush with top surface of floor or with both surfaces of wall. Cementitious mortar mixed with water at a rate of 1.0 part dry mixture to 0.3 parts water by weight in accordance with the installation instructions supplied with the product.

3M COMPANY – 3M Fire Barrier Mortar
4. **Cables** – One cable to be centered in each of max two preformed opening within confines of cable tray. Size of opening to be maximum 1-1/2 by 2-1/2 in. Openings to be spaced min 21 in. OC and min 2-1/2 in. from back and sides of cable tray. Cables to be rigidly supported on both sides of floor or wall assembly. Any of the following types and sizes of cables may be used:
 - A. Max 1/C 1000 kcmil aluminum conductor cable with cross-linked polyethylene (XLPE) insulation and polyvinyl chloride (PVC) jacket.
 - B. Max 1/C No. 4/0 AWG aluminum conductor cable with cross-linked polyethylene (XLPE) insulation and polyvinyl chloride (PVC) jacket.
 - C. Max 1/C No. 60 AWG copper conductor cable with cross-linked polyethylene (XLPE) insulation and polyvinyl chloride (PVC) jacket.
 - D. Max 2/C No. 16 AWG shielded copper conductor cable with flame retardant polyvinyl chloride (FR-PVC) insulation and jacket.
 - E. Max 3/C No. 12 AWG copper conductor cable with flame retardant cross-linked polyethylene (FR-XLPE) insulation and polyvinyl chloride (PVC) jacket.
 - F. Max 3/C No. 4 AWG copper conductor TECK 90 cable with cross-linked polyethylene (XLPE) insulation and polyvinyl chloride (PVC) inner and outer jackets.
5. **Fill, Void or Cavity Materials* – Mortar** – Min 3 in. thickness of mortar applied within the annulus around cables, flush with top surface of floor or with both surfaces of wall. Additional mortar to be installed such that a min 1/4 in. crown is formed around the cables. Cementitious mortar mixed with water at a rate of 1.0 part dry mixture to 0.3 parts water by weight in accordance with the installation instructions supplied with the product.

3M COMPANY – 3M Fire Barrier Mortar
6. **Fill, Void or Cavity Materials* – Caulk or Sealant** – (Not Shown) Min 1/4 in. bead of caulk to be installed at any voids between the cable trays and mortar, and between the cable trays and concrete floor or wall.

3M COMPANY – CP 25WB+ caulk or FB-3000 WT sealant.

Firestop Configuration G

2. **Cable Tray*** – Max 36 in. wide by max 6 in. deep open-ladder or solid back cable tray with channel-shaped side rails formed of aluminum and with rungs spaced 9 in. OC. The annular space between cable trays and the periphery of the opening shall be min 0 in. (point contact) to max 10 in. The annular space between cable trays and other adjacent uninsulated penetrating items shall be min 2 in. The annular space between adjacent cable trays shall be 10 in.
3. **Cables** – Aggregate cross-sectional area of cables in cable tray to be max 51 percent of the cross-sectional area of the cable tray. Any of the following types and sizes of cables, up to the quantity shown, may be used:

System No. C-AJ-8073 *continued*

- A. Max 10, max 1/C 1000 kcmil aluminum conductor cable with cross-linked polyethylene (XLPE) insulation and polyvinyl chloride (PVC) jacket.
 - B. Max 10, max 1/C 500 kcmil aluminum conductor cable with cross-linked polyethylene (XLPE) insulation and polyvinyl chloride (PVC) jacket.
 - C. Max 29, max 1/C No. 4/0 AWG aluminum conductor cable with cross-linked polyethylene (XLPE) insulation and polyvinyl chloride (PVC) jacket.
 - D. Max 8, max 1/C No. 6/0 AWG copper conductor cable with cross-linked polyethylene (XLPE) insulation and polyvinyl chloride (PVC) jacket.
 - E. Max 9, max 2/C No. 16 AWG shielded copper conductor cable with flame retardant polyvinyl chloride (FR-PVC) insulation and jacket.
 - F. Max 2, max 3/C No 12 AWG copper conductor cable with flame retardant cross-linked polyethylene (FR-XLPE) insulation and polyvinyl chloride (PVC) jacket.
 - G. Max 2, max 3/C No. 4 AWG copper conductor TECK 90 cable with cross-linked polyethylene (XLPE) insulation and polyvinyl chloride (PVC) inner and outer jackets.
4. **Firestop System** – The firestop system shall consist of the following:
- A. **Forms** (Not Shown) – Used as a form to prevent leakage of mortar during installation. Forms to be a rigid sheet material, cut to fit the contour of the cable tray and cables, and fastened to the underside of floor or both sides of wall. Forms to be removed after mortar has cured.
 - B. **Fill, Void or Cavity Materials*** – **Mortar** – Min 3 in. thickness of mortar applied within the annulus, flush with top surface of floor or with both surfaces of wall. Additional fill material to be installed such that a min 2 in. crown is formed around the cables and lapping 2 in. beyond the cables. Cementitious mortar mixed with water at a rate of 1.0 part dry mixture to 0.3 parts water by weight in accordance with the installation instructions supplied with the product.
3M COMPANY – 3M Fire Barrier Mortar
5. **Fill, Void or Cavity Materials*** – **Caulk or Sealant** (Not Shown) Min 1/4 in. bead of caulk to be installed at any voids between the cable trays and mortar, and between the cable trays and concrete floor or wall.
3M COMPANY – CP 25WB+ caulk or FB-3000 WT sealant.

*Bearing the UL Classification Marking

Bearing the UL Recognized Component Marking

Reprinted from the Online Certifications Directory with permission from Underwriters Laboratories Inc.
Copyright © 2010 Underwriters Laboratories Inc.®



Through Penetrations

Compos

8000 Series

Concrete

CAJ

System No. C-AJ-8075

September 07, 2004

F Rating – 2 Hr

T Ratings – 0, 1/2, 3/4 & 1-1/2 Hr (See Item 2)

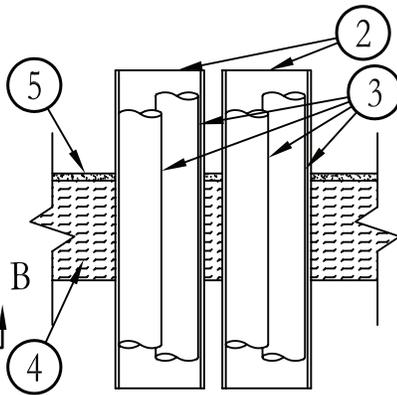
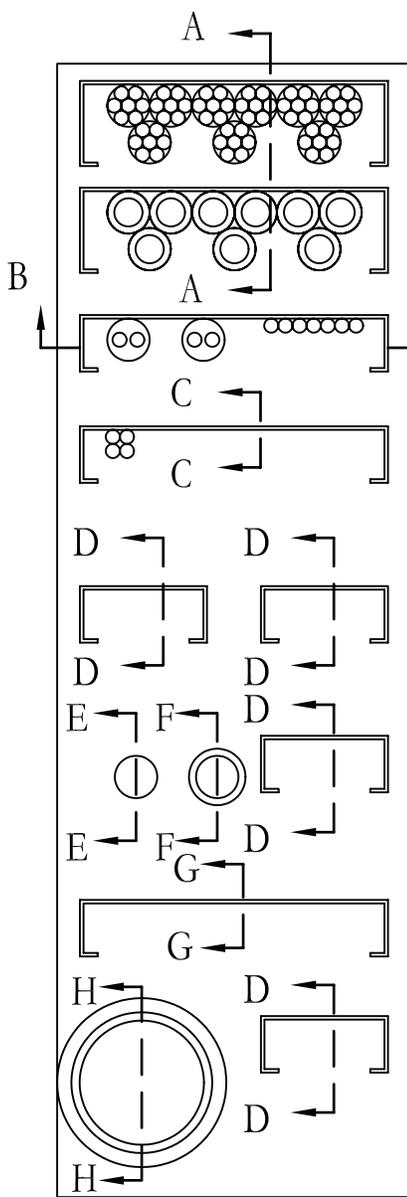

SECTION A-A

FIRESTOP
CONFIGURATION A

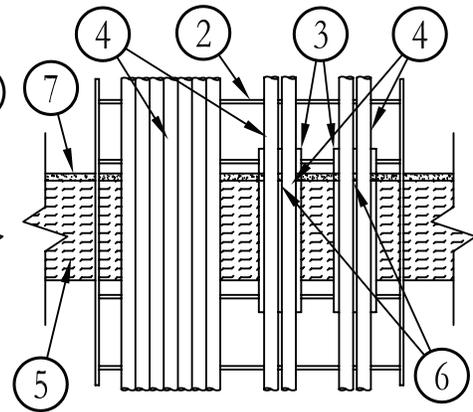

SECTION B-B

FIRESTOP
CONFIGURATION B

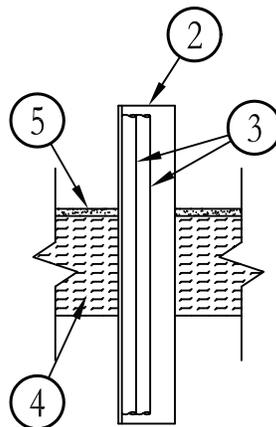

SECTION C-C

FIRESTOP
CONFIGURATION C

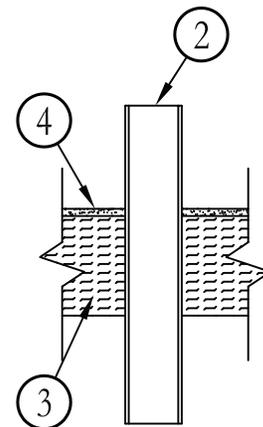

SECTION D-D

FIRESTOP
CONFIGURATION D

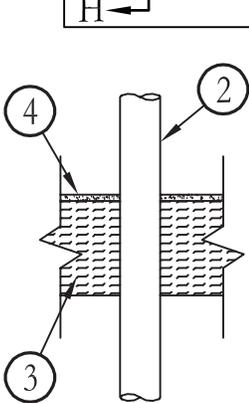

SECTION E-E

FIRESTOP
CONFIGURATION E

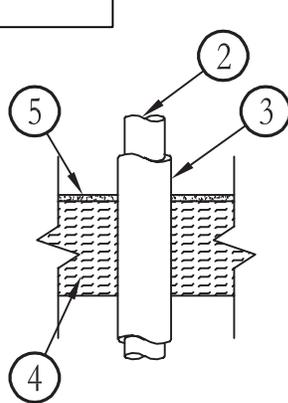

SECTION F-F

FIRESTOP
CONFIGURATION F

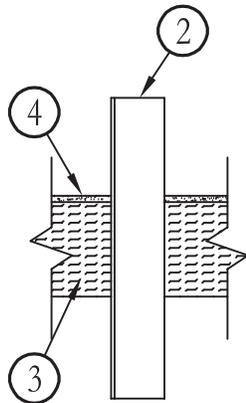

SECTION G-G

FIRESTOP
CONFIGURATION G

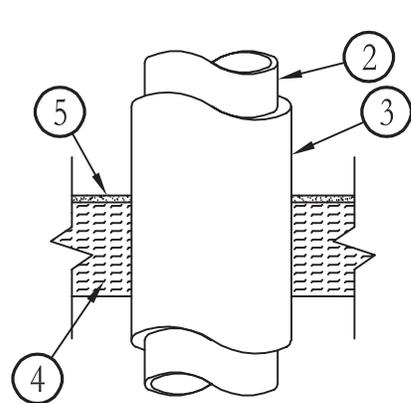

SECTION H-H

FIRESTOP
CONFIGURATION H

Through Penetrations

Compos

8000 Series

Concrete

CAJ

System No. C-AJ-8075 *continued*

1. **Floor or wall Assembly** – Min 4-1/2 in. thick reinforced lightweight or normal weight (100-150 pcf) concrete. Wall may also be constructed of any UL Classified **Concrete Blocks***. Max area of opening is 3520 sq in. with max dimension of 88 in.
See **Concrete Blocks** (CAZT) category in the Fire Resistance Directory for names of manufacturers.
2. **Through Penetrants** – A max of 8 firestop configurations may be installed within the opening. The space between firestop configurations shall be min 5-3/4 in. to max 7 in. The space between firestop configurations and periphery of opening shall be min 0 in. to max 17-1/2 in. Pipe, conduit, tubing or cable tray to be rigidly supported on both sides of floor or wall assembly. The T rating of the system is dependent on the firestop configuration, as shown in the table below. Any combination of the following firestop configurations detailed herein may be used:

| Firestop Config | T Rating Hr |
|-----------------|------------------|
| A | 0 |
| B | 1/2 |
| C | 1/2 |
| D | 1/2 |
| E | 0 |
| F | 3/4 |
| G | 1-1/2 |
| H | 0 & 1 (See Item) |

Firestop Configuration A

2. **Cable Trays** – Max 36 in. wide by max 3-1/2 in. deep open-ladder or solid-back cable trays with channel-shaped side rails formed of min 0.050 in. thick steel. Cable trays are provided with min 0.050 in. thick steel rungs spaced a max of 12 in. apart, or a min 0.050 in. thick steel solid back. A max of 2 cable trays are permitted per opening.
3. **Cables** – Aggregate cross-sectional area of cables in cable trays to be max 40 percent of the cross-sectional area of the cable tray based on a max 3.0 in. cable loading depth within the cable tray. Any combination of the following types and sizes of copper conductor cables may be used:
 - A. Max 1/C 500 kcmil cable with cross-linked polyethylene (XLPE) jacket and insulation.
 - B. Max 4/C No. 2 AWG cable with XLPE jacket and insulation.
4. **Packing Material** – Min 3-3/4 in. thickness of min 4.5 pcf mineral wool batt insulation firmly packed into the opening as a permanent form so that the width of the wool is compressed at least 50 percent. Packing material to be recessed from top surface of floor or from both surfaces of wall as required to accommodate the required thickness of fill material.
5. **Fill, Void or Cavity Material* – Sealant** – Min 3/8 in. thickness of caulk applied within the annulus, flush with top surface of floor or with both surfaces of wall.
3M COMPANY – FB-1000 NS (floors or walls), FB-1003 SL (floors only) or FB-3000 WT sealant.

Firestop Configuration B

2. **Cable Tray** – Max 36 in. wide by max 3-1/2 in. deep open-ladder cable tray with channel-shaped side rails formed of min 0.091 in. thick aluminum. Cable trays are provided with min 0.091 in. thick aluminum rungs spaced a max of 12 in. apart. One cable tray to be installed in the opening.
3. **Nonmetallic Sleeve** (Optional) – Nom 3-1/2 in. diam (or smaller) Schedule 10 polyvinyl chloride pipe. In floors, sleeve installed with nom 2 in. projecting above floor. In walls, sleeve installed to project min 2 in. beyond each surface of the wall. A max of 2 nonmetallic sleeves to be installed in the cable tray. The space between the sleeves and the cable tray should be min 1 in.
4. **Cables** – A max of eleven 12/C No. 14 AWG cables with cross-linked polyethylene (XLPE) jacket and insulation to be installed within the cable tray. Within each sleeve a max of two 12/C No. 4 AWG cables may be installed.
5. **Packing Material** – Min 3-3/4 in. thickness of min 4.5 pcf mineral wool batt insulation firmly packed into the opening and sleeves as a permanent form so that the width of the wool is compressed at least 50 percent. Packing material to be recessed from top surface of floor or from both surfaces of wall as required to accommodate the required thickness of fill material.
6. **Fill, Void or Cavity Material* – Sealant** – Min 3/8 in. thickness of caulk applied within the annulus, flush with top surface of floor or with both surfaces of wall.
3M COMPANY – FB-1000 NS (floors or walls), FB-1003 SL (floors only) or FB-3000 WT sealant.

Firestop Configuration C

2. **Cable Tray** – Max 36 in. wide by max 3-1/2 in. deep open-ladder cable tray with channel-shaped side rails formed of min 0.050 in. thick steel. Cable trays are provided with min 0.050 in. thick steel rungs spaced a max of 12 in. apart. One cable tray to be installed in the opening.
3. **Cables** – A max of four 12/C No. 14 AWG cables with cross-linked polyethylene (XLPE) jacket and insulation to be installed within the cable tray.
4. **Packing Material** – Min 3-3/4 in. thickness of min 4.5 pcf mineral wool batt insulation firmly packed into the opening as a permanent form so that the width of the wool is compressed at least 50 percent. Packing material to be recessed from top surface of floor or from both surfaces of wall as required to accommodate the required thickness of fill material.
5. **Fill, Void or Cavity Material* – Sealant** – Min 3/8 in. thickness of caulk applied within the annulus, flush with top surface of floor or with both surfaces of wall.
3M COMPANY – FB-1000 NS (floors or walls), FB-1003 SL (floors only) or FB-3000 WT sealant.

Through Penetrations

Combos

8000 Series

Concrete

CAJ

System No. C-AJ-8075 *continued*

Firestop Configuration D

- Cable Tray** – Max 12 in. wide by max 3-1/2 in. deep open-ladder cable tray with channel-shaped side rails formed of min 0.063 in. thick steel. Cable trays are provided with min 0.051 in. thick steel rungs spaced a max of 12 in. apart. A max of four cable trays to be installed in the opening.
- Packing Material** – Min 3-3/4 in. thickness of min 4.5 pcf mineral wool batt insulation firmly packed into the opening as a permanent form so that the width of the wool is compressed at least 50 percent. Packing material to be recessed from top surface of floor or from both surfaces of wall as required to accommodate the required thickness of fill material.
- Fill, Void or Cavity Material* – Sealant** – Min 3/8 in. thickness of caulk applied within the annulus, flush with top surface of floor or with both surfaces of wall.
3M COMPANY – FB-1000 NS (floors or walls), FB-1003 SL (floors only) or FB-3000 WT sealant.

Firestop Configuration E

- Steel Conduit** – Nom 4 in. diam (or smaller) electrical metallic tubing or steel conduit. One conduit to be installed within the firestop system. Conduit to be rigidly supported on both sides of floor or wall assembly.
- Packing Material** – Min 3-3/4 in. thickness of min 4.5 pcf mineral wool batt insulation firmly packed into the opening as a permanent form so that the width of the wool is compressed at least 50 percent. Packing material to be recessed from top surface of floor or from both surfaces of wall as required to accommodate the required thickness of fill material.
- Fill, Void or Cavity Material* – Sealant** – Min 3/8 in. thickness of caulk applied within the annulus, flush with top surface of floor or with both surfaces of wall.
3M COMPANY – FB-1000 NS (floors or walls), FB-1003 SL (floors only) or FB-3000 WT sealant.

Firestop Configuration F

- Copper Tubing** – Nom 4 in. diam (or smaller) Type M (or heavier) copper tubing or nom 6 in. diam (or smaller) Type L (or heavier) copper tubing. One tube to be installed within the firestop system. Tube to be rigidly supported on both sides of floor or wall assembly.
- Pipe Covering*** – Nom 1 in. thick hollow cylindrical heavy density (min 7.0 pcf) mineral fiber units with an all service jacket. Longitudinal joints sealed with metal fasteners or factory-applied self-sealing lap tape. Transverse joints secured with metal fasteners or with butt tape supplied with the product.
See **Pipe and Equipment Covering – Materials*** (BRGU) category in the Building Materials Directory for names of manufacturers. Any pipe covering meeting the above specifications and bearing the UL Classification Marking with a Flame Spread Index of 25 or less and a Smoke Developed Index of 50 or less may be used.
- Packing Material** – Min 3-3/4 in. thickness of min 4.5 pcf mineral wool batt insulation firmly packed into the opening as a permanent form so that the width of the wool is compressed at least 50 percent. Packing material to be recessed from top surface of floor or from both surfaces of wall as required to accommodate the required thickness of fill material.
- Fill, Void or Cavity Material* – Sealant** – Min 3/8 in. thickness of caulk applied within the annulus, flush with top surface of floor or with both surfaces of wall.
3M COMPANY – FB-1000 NS (floors or walls), FB-1003 SL (floors only) or FB-3000 WT sealant.

Firestop Configuration G

- Cable Tray** – Max 36 in. wide by max 3-1/2 in. deep open-ladder cable tray with channel-shaped side rails formed of min 0.050 in. thick steel. Cable trays are provided with min 0.050 in. thick steel rungs spaced a max of 12 in. apart. One cable tray to be installed in the opening.
- Packing Material** – Min 3-3/4 in. thickness of min 4.5 pcf mineral wool batt insulation firmly packed into the opening as a permanent form so that the width of the wool is compressed at least 50 percent. Packing material to be recessed from top surface of floor or from both surfaces of wall as required to accommodate the required thickness of fill material.
- Fill, Void or Cavity Material* – Sealant** – Min 3/8 in. thickness of caulk applied within the annulus, flush with top surface of floor or with both surfaces of wall.
3M COMPANY – FB-1000 NS (floors or walls), FB-1003 SL (floors only) or FB-3000 WT sealant.

Firestop Configuration H

- Steel Pipe** – Nom 16 in. diam (or smaller) Schedule 30 (or heavier) or nom 24 in. diam (or smaller) Schedule 40 (or heavier) steel pipe. Pipe to be rigidly supported on both sides of floor or wall assembly.
- Pipe Covering*** (Optional) – Nom 1 or 1-1/2 in. thick hollow cylindrical heavy density (min 7.0 pcf) mineral fiber units with an all service jacket. Longitudinal joints sealed with metal fasteners or factory-applied self-sealing lap tape. Transverse joints secured with metal fasteners or with butt tape supplied with the product. T Rating is 0 Hr when pipe covering is not used.
See **Pipe and Equipment Covering – Materials*** (BRGU) category in the Building Materials Directory for names of manufacturers. Any pipe covering meeting the above specifications and bearing the UL Classification Marking with a Flame Spread Index of 25 or less and a Smoke Developed Index of 50 or less may be used.
- Packing Material** – Min 3-3/4 in. thickness of min 4.5 pcf mineral wool batt insulation firmly packed into the opening as a permanent form so that the width of the wool is compressed at least 50 percent. Packing material to be recessed from top surface of floor or from both surfaces of wall as required to accommodate the required thickness of fill material.
- Fill, Void or Cavity Material* – Sealant** – Min 3/8 in. thickness of caulk applied within the annulus, flush with top surface of floor or with both surfaces of wall.
3M COMPANY – FB-1000 NS (floors or walls), FB-1003 SL (floors only) or FB-3000 WT sealant.

*Bearing the UL Classification Marking

Reprinted from the Online Certifications Directory with permission from Underwriters Laboratories Inc.
Copyright © 2010 Underwriters Laboratories Inc.®



System No. C-AJ-8085

March 05, 2007

F Rating – 2 Hr

T Rating – 0 Hr

W Rating – Class 1

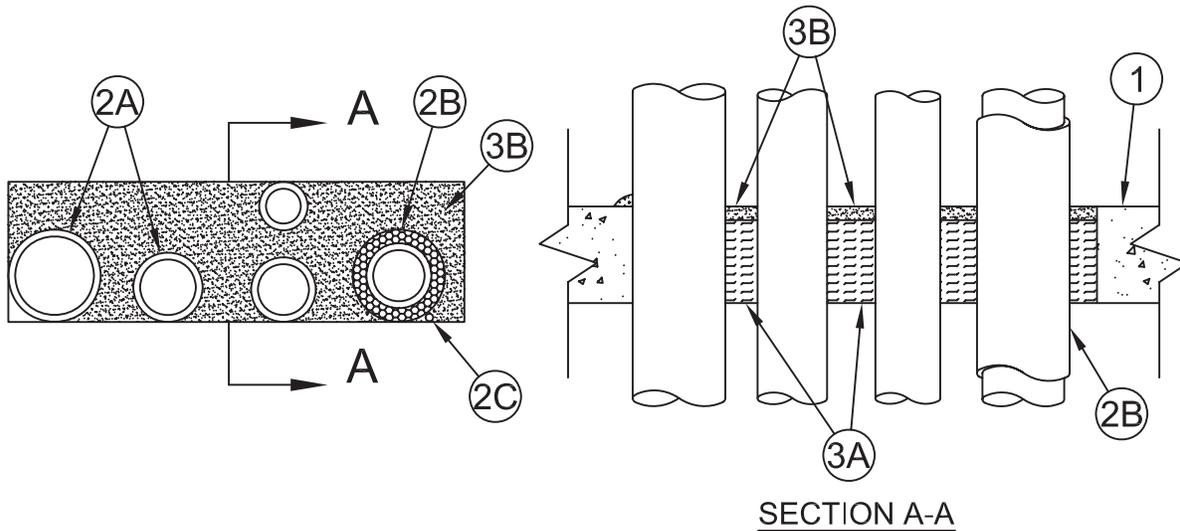

1. **Floor or Wall Assembly** – Min 4-1/2 in. (114 mm) thick reinforced lightweight or normal weight (100-150 pcf or 1600-2400 kg/m³) concrete. Wall may also be constructed of any UL Classified **Concrete Blocks***. Max area of opening is 108 sq. in. (697 cm²) with a max dimension of 18 in.
See **Concrete Blocks (CAZT)** category in the Fire Resistance Directory for names of manufacturers.
- 1A. **Steel Sleeve** – (Optional, Not Shown) - Nom 11 in. (279 mm) diam (or smaller) circular sleeve fabricated from nom 0.019 in. (0.48 mm) thick galv steel cast or grouted into floor or wall assembly flush with floor or wall surfaces.
2. **Through Penetrants** – Metallic pipes, tubing, conduit or cable to be installed either concentrically or eccentrically within the firestop system. Penetrants to be rigidly supported on both sides of floor assembly. The following types and sizes of penetrants may be used:
 - A. **Metallic Pipes** – Max five metallic pipes, conduit or tubing. The annular space between penetrant and periphery of opening shall be min 0 in. (point contact) to max 1-7/8 in. (48 mm). The following types and sizes of metallic pipes, conduit or tubing may be used:
 - A1. **Steel Pipe** – Nom 4 in. (102 mm) diam (or smaller) Schedule 10 (or heavier) steel pipe.
 - A2. **Iron Pipe** – Nom 4 in. (102 mm) diam (or smaller) cast or ductile iron pipe.
 - A3. **Conduit** – Nom 4 in. (102 mm) diam (or smaller) rigid steel conduit or steel electrical metallic tubing.
 - A4. **Copper Tubing** – Nom 4 in. (102 mm) diam (or smaller) Type L (or heavier) copper tube.
 - A5. **Copper Pipe** – Nom 4 in. (102 mm) diam (or smaller) Regular (or heavier) copper pipe.
 - B. **Tube Insulation – Plastics+** – Nom 1/2 in. (13 mm) thick acrylonitrile butadiene/polyvinyl chloride (AB/PVC) flexible foam furnished in the form of tubing. The tube insulation may be installed on all pipes or tubing. The annular space between the insulated penetrating item and the periphery of the opening shall be min 0 in. (0 mm) (point contact) to max 1-7/8 in. (48 mm). The annular space between the insulated penetrating item and uninsulated metallic pipes, conduit or tubing shall be min 1/2 in. (13 mm).
See **Plastics (QMFZ2)** category in the Recognized Component Directory for names of manufacturers. Any Recognized Component tube insulation material meeting the above specifications and having a UL 94 Flammability Classification of 94-5A may be used.
 - C. **Cables** – Max two 8/C No. 24 AWG (or smaller) control cable with polyvinyl chloride (PVC) insulation and jacket. Cable to be spaced min 0 in. (0 mm) (point contact) from tube insulation or min 1/2 in. (13 mm) from other penetrants. The annular space between cable and periphery of opening is min 0 in. (0 mm) (point contact) to max 1-7/8 in. (48 mm). Cable to be rigidly supported on both sides of floor or wall assembly.
3. **Firestop System** – The details of the firestop system shall be as follows:
 - A. **Packing Material** – Min 3 in. (76 mm) thickness of min 4 pcf (64 kg/m³) mineral wool batt insulation firmly packed into opening as a permanent form. Packing material to be recessed from top surface of floor to accommodate the required thickness of fill material.
 - B. **Fill, Void or Cavity Materials* – Sealant** – Min 1/4 in. (6 mm) thickness of fill material applied within the annulus, flush with top surface of floor. Min 1/2 in. (13 mm) diam bead of caulk applied to the penetrant/concrete interface at the point contact location on the top surface of floor or both surfaces of wall.
3M COMPANY – FB-1003 SL, FB-1000 NS or FB-3000 WT

*Bearing the UL Classification Mark

+Bearing the UL Recognized Component Marking

Reprinted from the Online Certifications Directory with permission from Underwriters Laboratories Inc.

Copyright © 2010 Underwriters Laboratories Inc.®



System No. C-AJ-8087

September 23, 2008

F Rating – 2 Hr

T Rating – 1/4 Hr

W Rating – Class 1 (See Item 3)

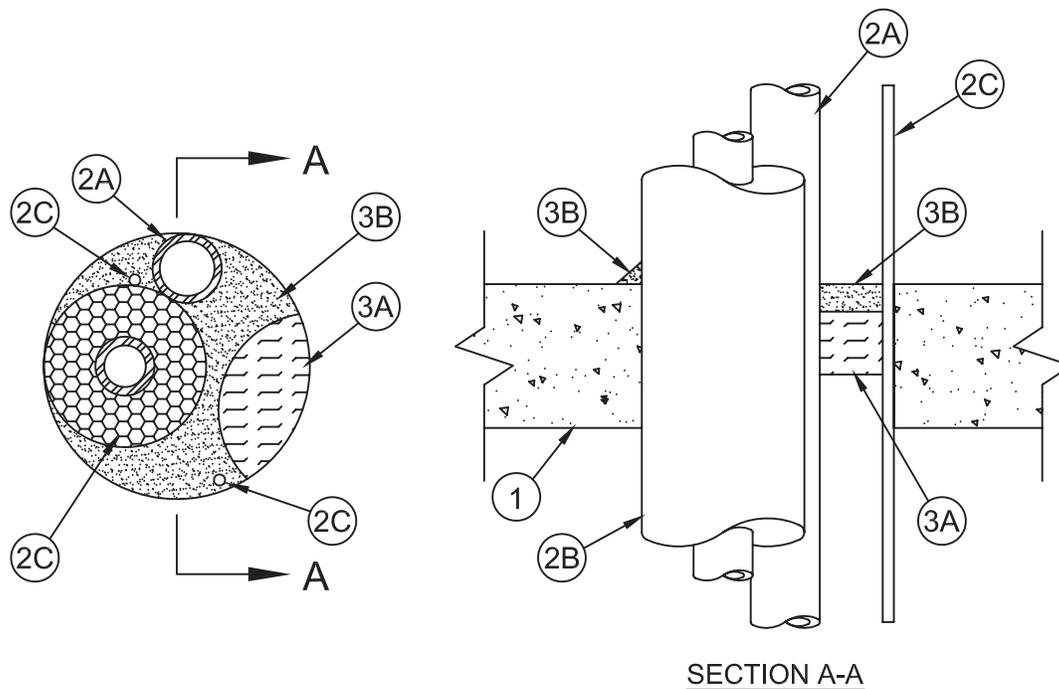

- Floor or Wall Assembly** – Min 4-1/2 in. (114 mm) thick reinforced lightweight or normal weight (100-150 pcf or 1600-2400 kg/m³) concrete. Wall may also be constructed of any UL Classified **Concrete Blocks***. Max diam of opening is 4 in. (102 mm).
See **Concrete Blocks (CAZT)** category in the Fire Resistance Directory for names of manufacturers.
- Through Penetrants** – Metallic pipes, tubing or cable to be installed either concentrically or eccentrically within the firestop system. Penetrants to be rigidly supported on both sides of floor assembly. The following types and sizes of penetrants may be used:
 - Metallic Pipes** – Max two metallic pipes or tubing. The annular space between penetrant and periphery of opening shall be min 0 in. (point contact) to max 2-1/4 in. (57 mm) The following types and sizes of metallic pipes or tubing may be used:
 - Copper Tubing** – Nom 1 in. (25 mm) diam (or smaller) Type M (or heavier) copper tube.
 - Copper Pipe** – Nom 1 in. (25 mm) diam (or smaller) Regular (or heavier) copper pipe.
 - Tube Insulation – Plastics+** – Nom 3/4 in. (19 mm) thick acrylonitrile butadiene/polyvinyl chloride (AB/PVC) flexible foam furnished in the form of tubing. The tube insulation may be installed on all tubing. The annular space between the insulated penetrating item and uninsulated metallic pipes, conduit or tubing shall be min 0 in. (point contact) to max 1-1/4 in. (32 mm) The annular space between the insulated penetrating item and the periphery of the opening shall be min 0 in. (point contact) to max 2-1/4 in. (57 mm).
See **Plastics (QMFZ2)** category in the Recognized Component Directory for names of manufacturers. Any Recognized Component tube insulation material meeting the above specifications and having a UL 94 Flammability Classification of 94-5A may be used.
 - Cables** – Max two cables spaced min 0 in. (0 mm) (point contact) from tube insulation or min 1/2 in. (13 mm) from other penetrants. The annular space between cable and periphery of opening is min 0 in. (point contact) to max 2-1/4 in. (57 mm). Cable to be rigidly supported on both sides of floor or wall assembly. The following types and sizes of cables may be used:
 - Max 7/C No. 24 AWG (or smaller) control cable with polyvinyl chloride (PVC) insulation and jacket.
 - Max 2/C No. 10 AWG (or smaller) thermostat wire.
- Firestop System** – The details of the firestop system shall be as follows:
 - Packing Material** – Min 3 in. (76 mm) thickness of min 4 pcf (64 kg/m³) mineral wool batt insulation firmly packed into opening as a permanent form. Packing material to be recessed from top surface of floor or from both surfaces of wall to accommodate the required thickness of fill material.
 - Fill, Void or Cavity Materials* – Putty, Sealant or Caulk** – Min 1/2 in. (13 mm) thickness of fill material applied within the annulus, flush with top surface of floor or with both surfaces of wall. Min 1/2 in. (13 mm) diam bead of fill material applied to the penetrant/concrete interface at the point contact location on the top surface of floor or both surfaces of wall.
3M COMPANY – CP 25WB+ caulk, FB-3000 WT Sealant, MP+ Stix putty or IC 15WB+ caulk
(Note - W Rating applies only when FB-3000 WT is used.)

*Bearing the UL Classification Mark

+Bearing the UL Recognized Component Marking

Reprinted from the Online Certifications Directory with permission from Underwriters Laboratories Inc.
Copyright © 2010 Underwriters Laboratories Inc.®



System No. C-AJ-8088

September 07, 2004

F Rating – 2 Hr

T Rating – 0 Hr

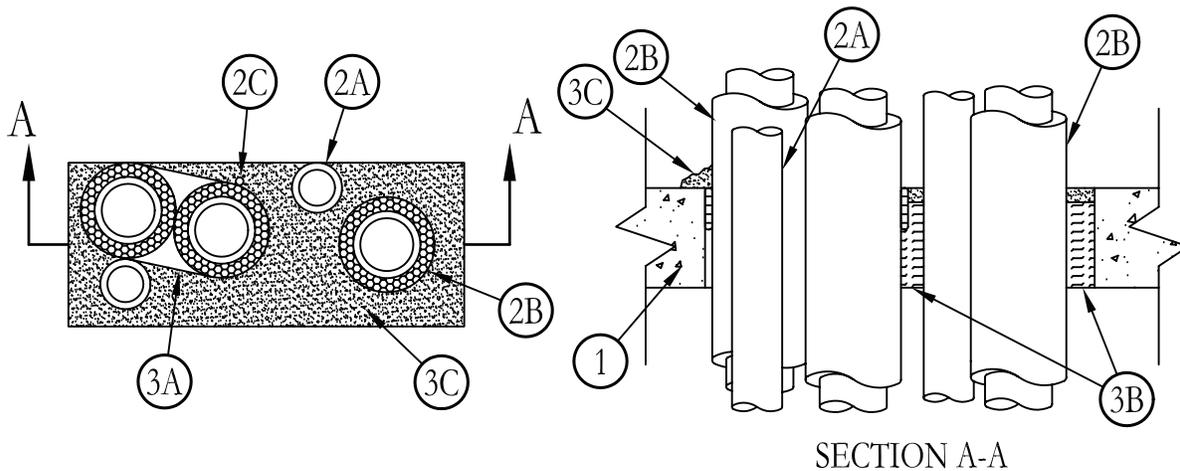

1. **Floor or Wall Assembly** – Min 4-1/2 in. thick reinforced lightweight or normal weight (100-150 pcf) concrete. Wall may also be constructed of any UL Classified **Concrete Blocks***. Max area of opening is 144 sq in. with a max dimension of 18 in.
See **Concrete Blocks (CAZT)** category in the Fire Resistance Directory for names of manufacturers.
2. **Through Penetrants** – Metallic pipes, tubing or cable to be installed either concentrically or eccentrically within the firestop system. Penetrants to be rigidly supported on both sides of floor assembly. The following types and sizes of penetrants may be used.
 - A. **Metallic Pipes** – Max five metallic pipes or tubing. The annular space between uninsulated penetrant and periphery of opening shall be min 0 in. (point contact) to max 2-3/4 in. The following types and sizes of metallic pipes or tubing may be used:
 - A1. **Copper Tubing** – Nom 3 in. diam (or smaller) Type M (or heavier) copper tube.
 - A2. **Copper Pipe** – Nom 3 in. diam (or smaller) Regular (or heavier) copper pipe.
 - B. **Tube Insulation – Plastics+** – Nom 1 in. thick acrylonitrile butadiene/polyvinyl chloride (AB/PVC) flexible foam furnished in the form of tubing. The tube insulation shall be installed on all tubing greater than nom 2 in. diam. The annular space between the insulated penetrating item and uninsulated metallic pipes, conduit or tubing shall be min 0 in. (point contact) to max 1-1/4 in. The annular space between the insulated penetrating item and the periphery of the opening shall be min 0 in. (point contact) to max 2-3/4 in.
See **Plastics (QMFZ2)** category in the Recognized Component Directory for names of manufacturers. Any Recognized Component tube insulation material meeting of the above specifications and having a UL 94 Flammability Classification of 94-5A may be used.
 - C. **Cables** – Max one 2/C No. 18 AWG (or smaller) thermostat wire spaced min 0 in. (point contact) from tube insulation or min 1/2 in. from other penetrants. The annular space between cable and periphery of opening is min 0 in. (point contact) to max 2-3/4 in. Cable to be rigidly supported on both sides of floor or wall assembly.
3. **Firestop System** – The details of the firestop system shall be as follows:
 - A. **Fill, Void or Cavity Materials* – Wrap Strip** – Nom 1/8 in. thick intumescent material supplied in 2 in. wide strips. Min one layer of wrap strip wrapped around penetrants and pipe insulation and secured in place with steel wire or aluminum foil tape and recessed within the opening not more than 2 in. above the bottom of the floor. Wrap strip required around insulated penetrants which may be tightly bundled together. Wrap strip also required to be installed around insulated penetrants when installed less than 1/2 in. from uninsulated tubes or cables. In such cases where insulated penetrant is at point contact with uninsulated tubes or cables, wrap strip to be wedged between insulation and uninsulated tube or cable by compressing insulation. Wrap strip not required around insulated tubes installed 1/2 in. or greater from other penetrants.
3M COMPANY – Ultra GS
 - B. **Packing Material** – Min 3 in. thickness of min 4 pcf mineral wool batt insulation firmly packed into opening as a permanent form. Packing material to be recessed from top surface of floor to accommodate the required thickness of fill material.
 - C. **Fill, Void or Cavity Materials* – Putty, Caulk or Sealant** – Min 1/2 in. thickness of fill material applied within the annulus, flush with top surface of floor. Min 1/2 in. diam bead of fill material applied to the penetrant/concrete interface at the point contact location on the top surface of floor.
3M COMPANY – MP+ Stix putty, CP 25WB+ caulk or FB-3000 WT sealant.

*Bearing the UL Classification Marking

+Bearing the UL Recognized Component Marking

Reprinted from the Online Certifications Directory with permission from Underwriters Laboratories Inc.

Copyright © 2010 Underwriters Laboratories Inc.®



System No. C-AJ-8106

January 31, 2006

F Rating – 2 Hr

T Ratings – 0, 1 and 2 Hr (See Item 2)

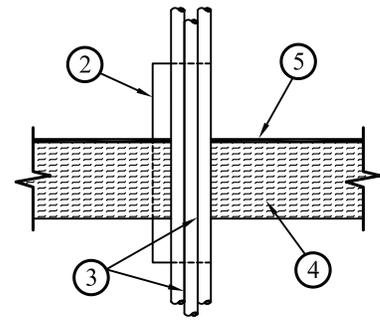
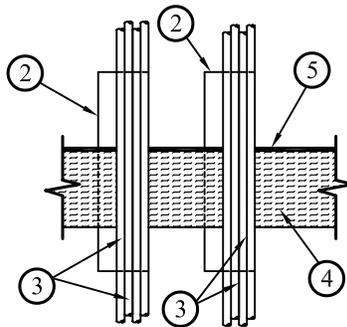
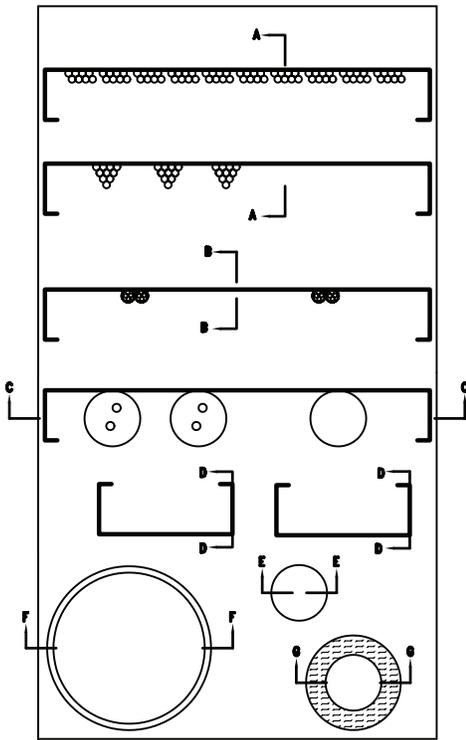

SECTION A-A
FIRESTOP
CONFIGURATION A

SECTION B-B
FIRESTOP
CONFIGURATION B

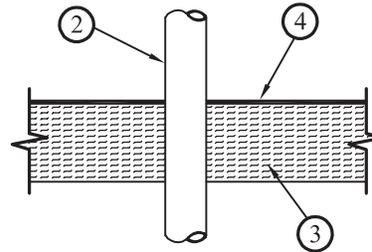
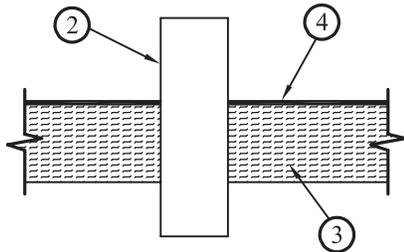
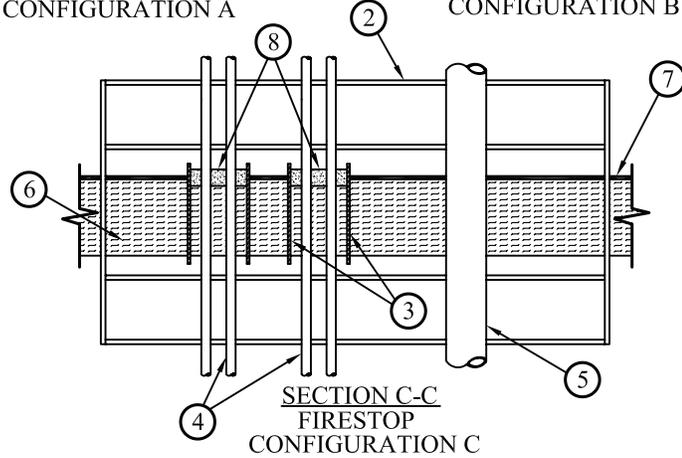

SECTION D-D
FIRESTOP
CONFIGURATION D

SECTION E-E
FIRESTOP
CONFIGURATION E

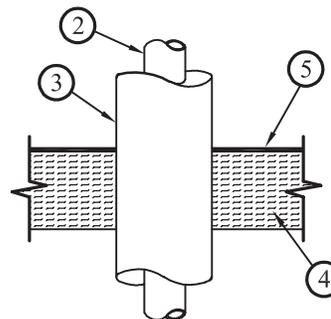
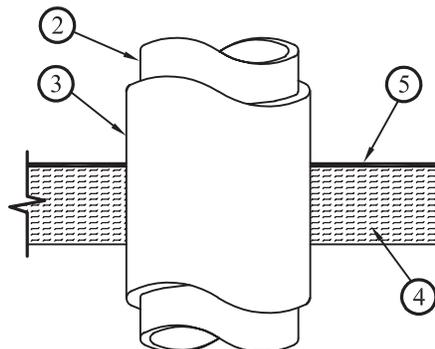

SECTION F-F
FIRESTOP
CONFIGURATION F

SECTION G-G
FIRESTOP
CONFIGURATION G

System No. C-AJ-8106 *continued*

Through Penetrations

Compos

8000 Series

Concrete

CAJ

- Floor or Wall Assembly** – Min 4-1/2 in. (114 mm) thick reinforced low-density or normal-density (100 to 150 pcf or 1600-2400 kg/m³) structural concrete. Wall may also be constructed of any UL Classified **Concrete Blocks***. Max area of the through opening is 21 sq ft (1.95 m²) with a maximum dimension of 7 ft (2.1 m).

See **Concrete Blocks (CAZT)** in Volume 1 of the Fire Resistance Directory for names of manufacturers.

- Through Penetrants** – A max of eight firestop configurations may be installed within the opening. The space between firestop configurations shall be min 5-3/4 in. (146 mm) to max 7 in. (178 mm). The space between firestop configurations and periphery of opening shall be min 0 in. (0 mm) point contact to max 8 in. (203 mm). Pipe, conduit, tubing or cable tray to be rigidly supported on both sides of floor or wall assembly. The T rating of the system is dependent on the firestop configuration as shown in the table below. Any combination of the following firestop configurations detailed herein may be used:

| Firestop Configuration | T Rating |
|------------------------|----------------------|
| A, B, C, D, E | 0 |
| F | 0 and 2 (see item 3) |
| G | 0 and 1 (see item 3) |

Firestop Configuration A

- Cable Trays** – Max 36 in. (914 mm) wide by max 3-1/2 in. (89 mm) deep solid-back or open ladder galvanized steel cable tray with channel-shaped side rails formed of min 0.050 in. (1.3 mm) thick steel. Cable trays are provided with min 0.050 in. (1.3 mm) thick steel rungs spaced a max of 12 in. (305 mm) OC or min 0.050 in. (1.3 mm) thick steel solid back. The cable tray is to be installed min 3/4 in. (19 mm) and max 8 in. (203 mm) from edge of opening and min 6 in. (152 mm) from any other cable tray or pipe.
- Cables** – Aggregate cross-sectional area of cables in cable trays to be max 40 percent of the cable tray based on a max 3 in. (76 mm) cable loading depth within the cable tray. Any combination of the following types and sizes of copper conductor cables may be used.
 - Max 2/C No.14 AWG cable with XLPE jacket and insulation. Cables can be installed in groups of eight (8) spaced a min 1 in. (25 mm) between bundles.
 - Max. 3/C No. 2 AWG cable with XLPE jacket and insulation. Cables can be installed in groups of ten (10), spaced a min 1 in. (25 mm) between bundles.
- Forming Material** – Min 4 in. (102 mm) thickness of min 4 pcf (64 kg/m³) density mineral wool insulation compressed minimum 50 percent into the opening as a permanent form and recessed from the floor surface or both wall surfaces as required to accommodate the required thickness of fill material.
- Fill, Void or Cavity Material*** – Material spray-applied or brushed over the mineral wool forming material to a min 1/16 in. (1.6 mm) dry thickness (min 1/8 in. or 3.2 mm wet thickness) flush with top surface of floor or both sides of wall assembly. Additional material is sprayed to a min height of 1/2 in. (13 mm) on penetrating items and to overlap surface of floor or both surfaces of wall by 1/2 in. (13 mm) min.

3M COMPANY – FireDam™ Spray 200

Firestop Configuration B

- Cable Trays** – Max 36 in. (914 mm) wide by max 3-1/2 in. (89 mm) deep solid-back or open ladder galvanized steel cable tray with channel-shaped side rails formed of min 0.050 in. (1.3 mm) thick steel. Cable trays are provided with min 0.050 in. (1.3 mm) thick steel rungs spaced a max of 12 in. (305 mm) OC or min 0.050 in. (1.3 mm) thick steel solid back. The cable tray is to be installed min 3/4 in. (19 mm) and max 8 in. (203 mm) from edge of opening and min 6 in. (152 mm) from any other cable tray or pipe.
- Cables** – A max of four (4) 1/C 500 MCM cable with XLPE jacket and insulation in a bundle or spaced 1 in. (25 mm) apart.
- Forming Material** – Min 4 in. (102 mm) thickness of min 4 pcf (64 kg/m³) density mineral wool insulation compressed min 50 percent into the opening as a permanent form and recessed from the floor surface or both wall surfaces as required to accommodate the required thickness of fill material.
- Fill, Void and Cavity Material*** – Material spray-applied or brushed over the mineral wool forming material to a min 1/16 in. (1.6 mm) dry thickness (min 1/8 in. or 3.2 mm thickness) flush with top surface of floor or both sides of wall assembly. Additional material is sprayed to a min height of 1/2 in. (13 mm) on penetrating items and to overlap surface of floor or both surfaces of wall by min 1/2 in. (13 mm).

3M COMPANY – FireDam™ Spray 200

Firestop Configuration C

- Cable Tray** – Max 36 in. (914 mm) wide by max 3-1/2 in. (89 mm) deep solid-back or open ladder galvanized steel cable tray with channel-shaped side rails formed of min 0.050 in. (1.3 mm) thick steel. Cable trays are provided with min 0.050 in. (1.3 mm) thick steel rungs spaced a max of 12 in. (305 mm) OC or min 0.050 in. (1.3 mm) thick steel solid back. The cable tray is to be installed min 3/4 in. (19 mm) and max 8 in. (203 mm) from edge of opening and min 6 in. (152 mm) from any other cable tray or pipe.
- Nonmetallic Sleeve** – Nom 4 in. (102 mm) diam (or smaller) Schedule 40 PVC pipe. Sleeve installed with a nom 2 in. (51 mm) projection above floor or both surfaces of wall. A max of two nonmetallic sleeves to be installed within the cable tray with a min of 1 in. (25 mm) between sleeves and from back of cable tray.
- Cables** – A max of two (2) 2/C No. 14 AWG cables with XLPE jacket and insulation to be installed within nonmetallic sleeve (Item 3).
- Electrical Metallic Tubing** – (Optional) – Nom 4 in. (102 mm) diam (or smaller) EMT may be installed within the cable tray 10 in. (254 mm) away from the PVC Sleeve (Item 3).
- Forming Material** – Min 4 in. (102 mm) thickness of min 4 pcf (64 kg/m³) density mineral wool insulation compressed min 50 percent into the opening and within nonmetallic sleeve (Item 3) as a permanent form and recessed from the floor surface or both wall surfaces as required to accommodate the required thickness of fill material.
- Fill, Void or Cavity Material*** – Material spray-applied or brushed over the mineral wool forming material to a min 1/16 in. (1.6 mm) dry thickness (min 1/8 in. or 3.2 mm wet thickness) flush with top surface of floor or both sides of wall assembly. Additional material is sprayed to a min height of 1/2 in. (13 mm) on penetrating items and to overlap surface of floor or both surfaces of wall by min 1/2 in. (13 mm).

3M COMPANY – FireDam™ Spray 200

System No. C-AJ-8106 *continued*

- Fill, Void or Cavity Material*** – MP+ Moldable Putty installed over the mineral wool forming material in the PVC Sleeve (item3) to a thickness of min 1 in. (25 mm) flush with top surface of floor or both sides of wall. Additional material is installed to form a crown of min 1/4 in. (6 mm) around the cables.

3M COMPANY – MP+ Moldable Putty

Firestop Configuration D

- Cable Trays** – Max 12 in. (305 mm) wide by max 3-1/2 in. (89 mm) deep solid-back or open ladder galvanized steel cable tray with channel-shaped side rails formed of min 0.050 in. (1.3 mm) thick steel. Cable trays are provided with min 0.050 in. (1.3 mm) thick steel rungs spaced a maximum of 12 in. (305 mm) OC or min 0.050 in. (1.3 mm) thick steel solid back. The cable tray is to be installed min 3/4 in. (19 mm) and max 8 in. (203 mm) from edge of opening and min 6 in. (152 mm) from any other cable tray or pipe.
- Forming Material** – Min 4 in. (102 mm) thickness of min 4 pcf (64 kg/m³) density mineral wool insulation compressed min 50 percent into the opening as a permanent form and recessed from the floor surface or both wall surfaces as required to accommodate the required thickness of fill material.
- Fill, Void or Cavity Material*** – Material spray-applied or brushed over the mineral wool forming material to a min 1/16 in. (1.6 mm) dry thickness (min 1/8 in. or 3.2 mm wet thickness) flush with top surface of floor or both sides of wall assembly. Additional material is sprayed to a min height of 1/2 in. (13 mm) on penetrating items and to overlap surface of floor or both surfaces of wall by min 1/2 in. (13 mm).

3M COMPANY – FireDam™ Spray 200

Firestop Configuration E

- Copper Tubing** – Nom 4 in. (102 mm) diam (or smaller) Type M (or heavier) copper tubing. Tube to be rigidly supported on both sides of floor or wall assembly.
- Forming Material** – Min 4 in. (102 mm) thickness of min 4 pcf (64 kg/m³) density mineral wool insulation compressed min 50 percent into the opening as a permanent form and recessed from the floor surface or both wall surfaces as required to accommodate the required thickness of fill material.
- Fill, Void or Cavity Material*** – Material spray-applied or brushed over the mineral wool forming material to a min 1/16 in. (1.6 mm) dry thickness (min 1/8 in. or 3.2 mm wet thickness) flush with top surface of floor or both sides of wall assembly. Additional material is sprayed to a min height of 1/2 in. (13 mm) on penetrating items and to overlap surface of floor or both surfaces of wall by min 1/2 in. (13 mm).

3M COMPANY – FireDam™ Spray 200

Firestop Configuration F

- Steel Pipe** – Nom 16 in. (406 mm) diam (or smaller) Schedule 30 (or heavier) steel pipe. Pipe to be wrapped with pipe covering material (Item 3), and rigidly supported on both sides of floor or wall assembly.
- Pipe Covering*** – Nom 1-1/2 in. (38 mm) hollow cylindrical mineral wool pipe insulation, min density 4 pcf (64 kg/m³). The pipe insulation is covered with an all service jacket. Longitudinal joints sealed with factory applied self-sealing lap tape. Transverse joints secured with butt tape supplied with the product. **T Rating is 0 hr when pipe covering is not used.**

IIG MINWOOL L L C – High Temperature Pipe Insulation 1200, High Temperature Pipe Insulation BWT or High Temperature Pipe Insulation Thermaloc

- Forming Material** – Min 4 in. (102 mm) thickness of min 4 pcf (64 kg/m³) density mineral wool forming material compressed min 50 percent into the opening as a permanent form and recessed from the floor surface or both wall surfaces as required to accommodate the required thickness of fill material.
- Fill, void or Cavity Material*** – Material spray-applied or brushed over the mineral wool forming material to a min 1/16 in. (1.6 mm) dry thickness (min 1/8 in. or 3.2 mm wet thickness) flush with top surface of floor or both sides of wall assembly. Additional material is sprayed to a min height of 1/2 in. (13 mm) on penetrating items and to overlap surface of floor or both surfaces of wall by min 1/2 in. (13 mm).

3M COMPANY – FireDam™ Spray 200

Firestop Configuration G

- Copper Tubing** – Nom 4 in. (102 mm) diam (or smaller) Type M (or heavier) copper tubing. Copper tube to be wrapped with pipe covering material (Item 3), and rigidly supported on both sides of floor or wall assembly.
- Pipe Covering*** – Nom 1-1/2 in. (38 mm) thick hollow cylindrical mineral wool pipe insulation, 4 pcf (64 kg/m³) density min. The pipe insulation is covered with an all service jacket. Longitudinal joints sealed with factory applied self-sealing lap tape. Transverse joints secured with butt tape supplied with the product. **T Rating is 0 hr when pipe covering is not used.**

IIG MINWOOL L L C – High Temperature Pipe Insulation 1200, High Temperature Pipe Insulation BWT or High Temperature Pipe Insulation Thermaloc

- Forming Material** – Min 4 in. (102 mm) thickness of min 4 pcf (64 kg/m³) density mineral wool forming material compressed min 50 percent into the opening as a permanent form and recessed from the floor surface or both wall surfaces as required to accommodate the required thickness of fill material.
- Fill, Void or Cavity Material*** – Material spray-applied or brushed over the mineral wool forming material to a min 1/16 in. (1.6 mm) dry thickness (min 1/8 in. or 3.2 mm wet thickness). flush with top surface of floor or both sides of wall assembly. Additional material is sprayed to a min height of 1/2 in. (13 mm) on penetrating items and to overlap surface of floor or both surfaces of wall by min 1/2 in. (13 mm).

3M COMPANY – FireDam™ Spray 200

*Bearing the UL Classification Mark

Reprinted from the Online Certifications Directory with permission from Underwriters Laboratories Inc.

Copyright © 2010 Underwriters Laboratories Inc.®



System No. C-AJ-8123

June 19, 2007
 F Rating – 2 Hr
 T Rating – 1/4 Hr

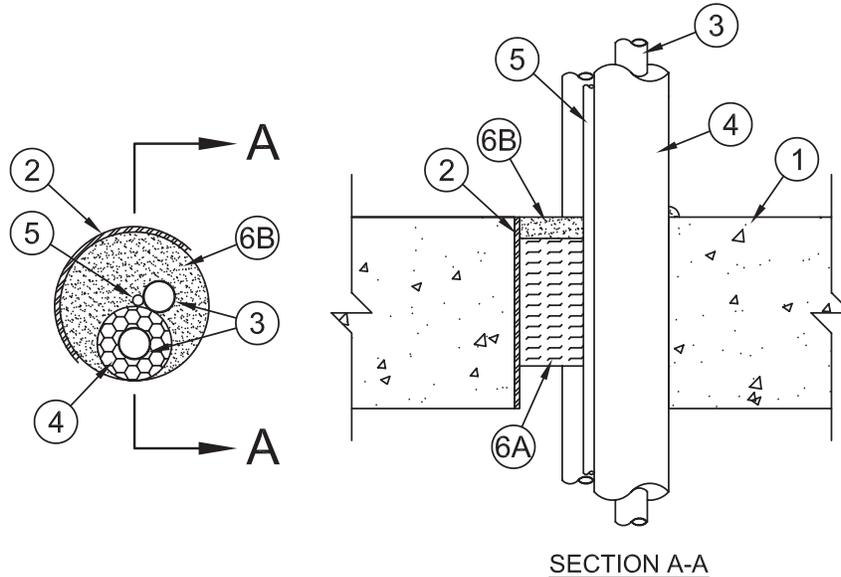

1. **Floor or Wall Assembly** – Min 4-1/2 in. (114 mm) thick reinforced lightweight or normal weight (100-150 pcf or 1600-2400 kg/m³) concrete. Floor assembly may also be constructed of any min 6 in. (152 mm) thick UL Classified hollow-core **Precast Concrete Units***. Wall may also be constructed of any UL Classified **Concrete Blocks***. Max diam of opening 4 in. (102 mm).
 See **Concrete Blocks** (CAZT) and **Precast Concrete Units** (CFTV) categories in Fire Resistance Directory for names of manufacturers.
2. **Steel Sleeve**• (Optional) – Nom 4 in. (102 mm) diam (or smaller) Schedule 10 (or heavier) steel sleeve cast or grouted into floor or wall assembly. Steel sleeve may be installed flush or may project max 2 in. (51 mm) beyond the floor or wall surfaces.
3. **Through Penetrants**• – A max of two pipes, conduits or tubes to be installed within the opening. Annular space between the penetrants and the periphery of the opening shall be min 0 in. (point contact) to max 2 in. (0 mm to max 51 mm). Penetrants to be rigidly supported on both sides of floor or wall assembly. The following types and sizes of metallic pipes, conduits or tubing may be used:
 - A. **Steel Pipe**• – Nom 1 in. (25 mm) diam (or smaller) Schedule 5 (or heavier) steel pipe.
 - B. **Iron Pipe**• – Nom 1 in. (25 mm) diam (or smaller) cast or ductile iron pipe.
 - C. **Conduit**• – Nom 1 in. (25 mm) diam (or smaller) rigid steel conduit or steel electrical metallic tubing (EMT).
 - D. **Copper Pipe**• – Nom 1 in. (25 mm) diam (or smaller) regular (or heavier) copper pipe.
 - E. **Copper Tube**• – Nom 1 in. (25 mm) diam (or smaller) Type L (or heavier) copper tube.
4. **Tube Insulation-Plastics**+• – A max of one pipe, tube or conduit to be provided with nom 3/4 in. (19 mm) thick (or less) acrylonitrile butadiene/polyvinyl chloride (AB/PVC) flexible foam furnished in the form of tubing. The annular space between the insulated penetrant and the periphery of the opening shall be min 0 in. (point contact) to max 2 in. (0 mm to max 51 mm). The annular space between insulated penetrants and non-insulated penetrants shall be min 0 in. (point contact) to max 2 in. (0 mm to max 51 mm).
 See **Plastics** (QMFZ2) category in the Recognized Component Directory for names of manufacturers. Any Recognized Component tube insulation material meeting the above specifications and having a UL 94 Flammability Classification of 94-5VA may be used.
5. **Cables**• – Max two 8/8 No. 12 AWG (or smaller) power and control cables with XLPE or PVC insulation with XLPE or PVC jacket. The annular space between the cable and the periphery of the opening shall be min 0 in. (point contact) to max 2 in. (0 mm to max 51 mm). The annular space between cable and insulated penetrants shall be min 0 in. (point contact) to max 2 in. (0 mm to max 51 mm). The annular space between cable and non-insulated penetrants shall be min 1/2 in. to max 2 in. (13 mm to max 51 mm).
6. **Firestop System**• – The details of the firestop system shall be as follows:
 - A. **Packing Material**• – Min 3 in. (76 mm) thickness of min 4 pcf (64 kg/m³) mineral wool batt insulation firmly packed into opening as a permanent form. Packing material to be recessed from top surface of floor or top edge of sleeve or from both surfaces of wall or both ends of sleeve as required to accommodate the required thickness of fill material. In floors constructed of hollow-core concrete, packing material to be recessed from top and bottom surfaces of floor or sleeve as required to accommodate the required thickness of fill material.
 - B. **Fill, Void or Cavity Materials*** – **Caulk or Sealant**• – Min 1/2 in. (13 mm) thickness of caulk applied within the annulus, flush with top surface of floor or top edge of sleeve or with both surfaces of wall or both ends of sleeves. In floors constructed of hollow-core concrete, min 1/2 in. (13 mm) thickness of caulk applied within the annulus, flush with top and bottom surfaces of floor or sleeve. Min 1/4 in. (6 mm) diam bead of caulk applied to the penetrant/concrete or penetrant/sleeve interface at the point contact location on the top surface of floor or both surfaces of wall or hollow-core concrete.

3M COMPANY– IC 15WB+, CP 25WB+ caulk or FB-3000 WT sealant.

* Bearing the UL Classification Marking

+ Bearing the UL Recognized Component Mark

Reprinted from the Online Certifications Directory with permission from Underwriters Laboratories Inc.
 Copyright © 2010 Underwriters Laboratories Inc.®



System No. C-AJ-8128

March 05, 2007

F Rating – 2 Hr

T Rating – 1/4 Hr

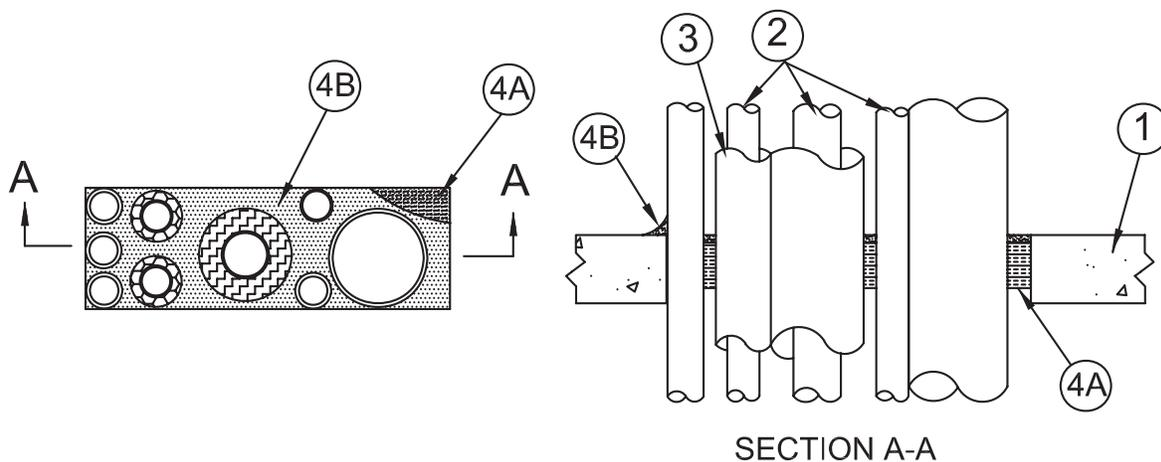

1. **Floor or Wall Assembly** – Min 4-1/2 in. (114 mm) thick reinforced lightweight or normal weight (100-150 pcf or 1600-2400 kg/m³) concrete. Wall may also be constructed of any UL Classified **Concrete Blocks***. Max size of opening to be 192 in.² (1239 cm²) with a max dimension of 28 in. (711 mm).

See **Concrete Blocks** (CAZT) category in Fire Resistance Directory for names of manufacturers.

- 1A. **Steel Sleeve** – (Optional, Not Shown) - Nom 15 in. (381 mm) diam (or smaller) circular sleeve fabricated from nom 0.028 in. (0.71 mm) thick galv steel cast or grouted into floor or wall assembly flush with floor or wall surfaces.
2. **Through Penetrants** – Multiple pipes, conduits or tubes to be installed within the opening. Annular space between penetrants and periphery of opening shall be min 0 in. (0 mm) (point contact) to max 3 in. (76 mm). Annular space between non-insulated penetrants shall be min 1/4 in. (6 mm) to max 3 in. (76 mm). Penetrants to be rigidly supported on both sides of floor or wall assembly. The following types and sizes of metallic pipes, conduits or tubing may be used:
 - A. **Steel Pipe** – Nom 6 in. (152 mm) diam (or smaller) Schedule 10 (or heavier) steel pipe.
 - B. **Iron Pipe** – Nom 6 in. (152 mm) diam (or smaller) cast or ductile iron pipe.
 - C. **Conduit** – Nom 6 in. (152 mm) diam (or smaller) rigid steel conduit or nom 4 in. (102 mm) diam (or smaller) steel electrical metallic tubing (EMT).
 - D. **Copper Pipe** – Nom 3 in. (76 mm) diam (or smaller) regular (or heavier) copper pipe.
 - E. **Copper Tube** – Nom 3 in. (76 mm) diam (or smaller) Type L (or heavier) copper tube.
3. **Pipe Insulation** – (Optional) – The annular space between insulated penetrants and the periphery of the opening shall be min 0 in. (0 mm) (point contact) to max 3 in. (76 mm). The annular space between insulated penetrants shall be min 1/2 in. (13 mm) to max 3 in. (76 mm). The annular space between insulated penetrants and non-insulated penetrants shall be min 1/2 in. (13 mm) to max 3 in. (76 mm). The following types of pipe insulations may be used:
 - A. **Pipe Covering*** – Nom 1-1/2 in. (38 mm) thick (or thinner) hollow cylindrical heavy density glass fiber units jacketed on the outside with an all service jacket. Longitudinal joints sealed with metal fasteners or factory-applied self-sealing lap tape. Transverse joints secured with metal fasteners or with butt tape supplied with the product.

See **Pipe and Equipment Covering – Materials** (BRGU) category in the Building Materials Directory for names of manufacturers. Any pipe covering material meeting the above specifications and bearing the UL Classification Marking with a Flame Spread Index of 25 or less and a Smoke Developed Index of 50 or less may be used.
 - B. **Tube Insulation-Plastics++** – Nom 5/8 in. (16 mm) thick (or thinner) acrylonitrile butadiene/polyvinyl chloride (AB/PVC) flexible foam furnished in the form of tubing.

See **Plastics** (QMFZ2) category in the Plastics Recognized Component Directory for names of manufacturers. Any Recognized Component tube insulation material meeting the above specifications and having a UL 94 Flammability Classification of 94-5VA may be used.
4. **Firestop System** – The firestop system shall consist of the following:
 - A. **Packing Material** – Min 3 in. (76 mm) thickness of min 4 pcf (64 kg/m³) mineral wool batt insulation firmly packed into opening as a permanent form. Packing material to be recessed from top surface of floor or from both surfaces of wall to accommodate the required thickness of fill material.
 - B. **Fill, Void or Cavity Materials* – Caulk or Sealant** – Min 1/2 in. (13 mm) thickness of caulk applied within the annulus, flush with top surface of floor or with both surfaces of wall. Min 1/4 in. (6 mm) diam bead of caulk applied to the penetrant/concrete interface at the point contact location on the top surface of floor or both surfaces of wall.

3M COMPANY – IC 15WB+, CP 25WB+ caulk, or FB-3000 WT sealant.

*Bearing the UL Classification Mark

++ Bearing the UL Recognized Component Mark

Reprinted from the Online Certifications Directory with permission from Underwriters Laboratories Inc.

Copyright © 2010 Underwriters Laboratories Inc.®



System No. C-AJ-8135

May 18, 2005

F Rating – 2 Hr

T Rating – 3/4 Hr

W Rating – Class I (See Items 3 and 4)

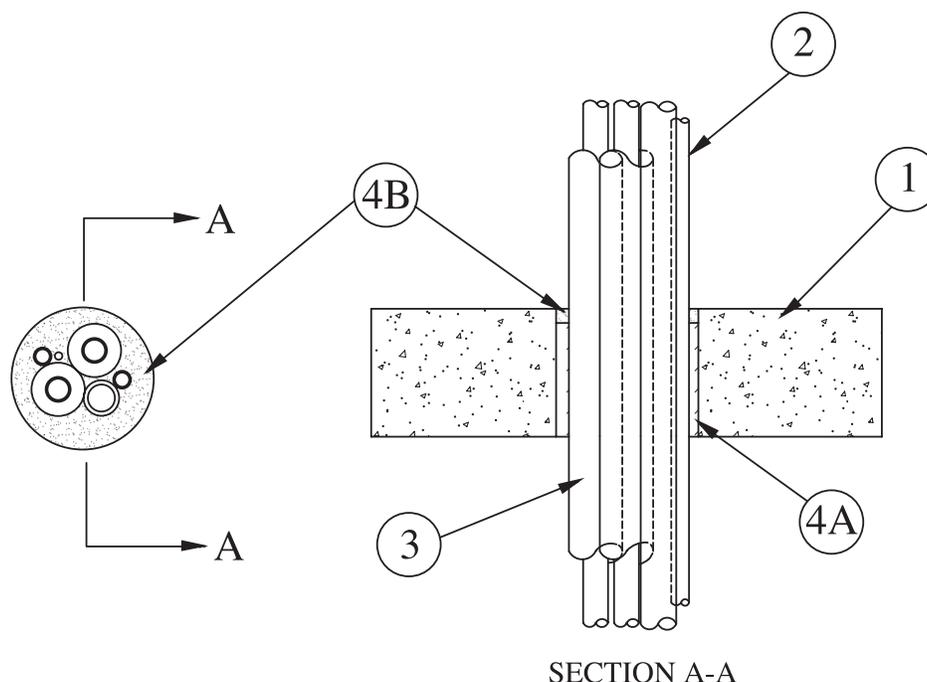

SECTION A-A

1. **Floor or Wall Assembly** – Min 4-1/2 in. (114 mm) thick reinforced lightweight or normal weight (100-150 pcf or 1600-2400 kg/m³) concrete floor. Min 5 in. (127 mm) thick reinforced lightweight or normal weight (100-150 pcf or 1600-2400 kg/m³) concrete wall. Wall may also be constructed of any UL Classified **Concrete Blocks***. Max diam of opening 5 in. (127 mm).
See **Concrete Blocks (CAZT)** category in Fire Resistance Directory for names of manufacturers.
2. **Through Penetrants** – A max of five pipes, conduits or tubes and a max of two cables to be installed within the opening. Annular space between the penetrants and the periphery of the opening shall be min 0 in. (point contact) to max 2 in. (0 mm to max 51 mm). Penetrants to be rigidly supported on both sides of floor or wall assembly. The following types and sizes of metallic pipes, conduits or tubing may be used:
 - A. **Metallic Pipes** – A max of four metallic pipes, conduits or tubing may be used. The following types and sizes may be used:
 - A1. **Steel Pipe** – Nom 3/4 in. (19 mm) diam (or smaller) Schedule 5 (or heavier) steel pipe.
 - A2. **Conduit** – Nom 1/2 in. (13 mm) diam (or smaller) electrical metallic tubing or rigid steel conduit.
 - A3. **Copper Tubing** – Nom 3/4 in. (19 mm) diam (or smaller) Type L (or heavier) copper tubing.
 - A4. **Copper Pipe** – Nom 3/4 in. (19 mm) diam (or smaller) Regular (or heavier) copper pipe.

All pipes or tubing larger than nom 1/2 in. (13 mm) diam shall be provided with pipe covering (Item 3). Nom 1/2 in. (13 mm) diam (or smaller) pipes or tubing may or may not be provided with pipe covering.
 - B. **Nonmetallic Pipes** – A max of one nonmetallic pipe or conduit may be used. A min 1/4 in. (6 mm) space must be maintained between uninsulated metallic pipes, conduits or tubing and nonmetallic pipes or conduits. The following types and sizes of nonmetallic pipes or conduits may be used:
 - B1. **Polyvinyl Chloride (PVC) Pipe** – Nom 1 in. (25 mm) diam (or smaller) Schedule 40 solid core PVC pipe for use in closed (process or supply) or vented (drain, waste or vent) piping system.
 - B2. **Chlorinated Polyvinyl Chloride (CPVC) Pipe** – Nom 1 in. (25 mm) diam (or smaller) SDR13.5 CPVC pipe for use in closed (process or supply) piping systems.
 - B3. **Rigid Nonmetallic Conduit++** – Nom 1 in. (25 mm) diam (or smaller) Schedule 40 PVC conduit installed in accordance with Article 347 of the National Electrical Code (NFPA No. 70.)
 - C. **Cables** – A max of two cables may be used. Max 8/C No. 12 AWG multiconductor power and control cables; XLPE or PVC insulation with XLPE or PVC jacket.
3. **Pipe Covering** – The following types and sizes of pipe coverings may be used with the metallic pipes or tubes:
Note – W Rating applies only when Tube Insulation (Item 3A is used.)
 - A. **Tube Insulation – Plastics+++** – Nom 1/2 in. (13 mm) thick acrylonitrile butadiene/polyvinyl chloride (AB/PVC) flexible foam furnished in the form of tubing.
See **Plastics (QMFZ2)** category in the Plastics Recognized Component Directory for names of manufacturers. Any Recognized Component tube insulation material meeting the above specifications and having a UL94 Flammability Classification of 94-5VA may be used.

System No. C-AJ-8135 *continued*

- B. **Pipe Covering*** – Nom 1/2 in. (13 mm) thick hollow cylindrical heavy density glass fiber units jacketed on the outside with an all service jacket. Longitudinal joints sealed with metal fasteners or factory-applied self-sealing lap tape. Transverse joints secured with metal fasteners or with butt tape supplied with the product.

See **Pipe and Equipment Covering – Materials** (BRGU) category in the Building Materials Directory for names of manufacturers. Any pipe covering material meeting the above specifications and bearing the UL Classification Marking with a Flame Spread Index of 25 or less and a Smoke Developed Index of 50 or less may be used.

4. **Firestop System** – The details of the firestop system shall be as follows:

- A. **Packing Material** – Min 4 in. (102 mm) thickness of min 4 pcf (64 kg/m³) mineral wool batt insulation firmly packed into opening as a permanent form. Packing material to be recessed from top surface of floor or from both surfaces of wall to accommodate the required thickness of fill material.

- B. **Fill, Void or Cavity Materials* – Caulk or Sealant** – Min 1/2 in. (13 mm) thickness of caulk applied within the annulus, flush with top surface of floor or with both surfaces of wall. Min 1/4 in. (6 mm) diam bead of caulk applied to the penetrant/concrete interface at the point contact location on the top surface of floor or both surfaces of wall.

3M COMPANY– IC 15WB+, CP 25WB+ caulk or FB-3000 WT sealant.

(Note: W Rating applies only when FB-3000 WT sealant is used. CP 25WB+ not suitable for use with CPVC pipes.)

*Bearing the UL Classification Marking

++Bearing the UL Listing Mark

+++Bearing the UL Recognized Component Mark

Reprinted from the Online Certifications Directory with permission from Underwriters Laboratories Inc.

Copyright © 2010 Underwriters Laboratories Inc.®



Note: This system was tested with a pressure differential of 50 Pa between the exposed and unexposed surfaces with the higher pressure on the exposed side.

System No. C-AJ-8172

June 23, 2015

F Rating — 2 Hr

T Rating — 0 Hr

L Rating At Ambient — 4 CFM/sq ft. (See Item 3B)

L Rating At 400 F — Less Than 1 CFM/sq ft. (See Item 3B)

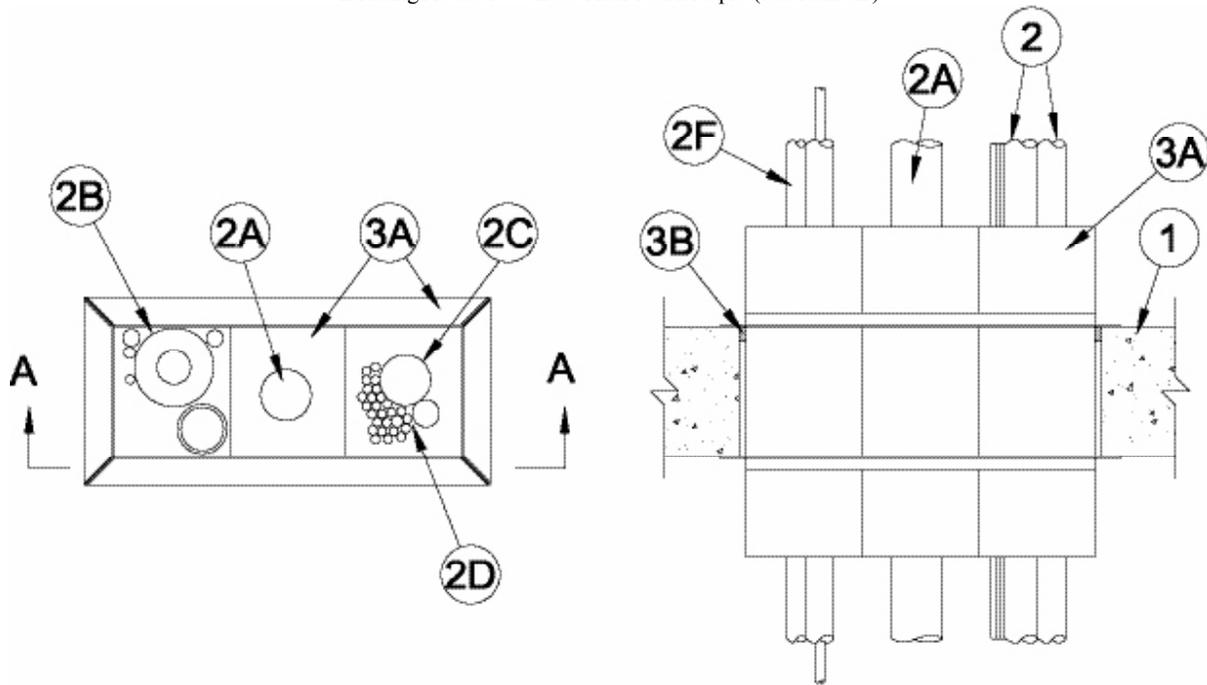

SECTION A-A

- Floor or Wall Assembly** — Min 2-1/2 in. (64 mm) thick reinforced lightweight or normal weight (100-150 pcf or 1600-2400 kg/m³) concrete. Wall may also be constructed of any UL Classified **Concrete Blocks***. Max area of opening is 56 in.² (363 cm²) with a max dimension of is 12-1/2 in. (318 mm) for square devices. Max diam of opening is 2-1/2 in. (64 mm) for nom 2 in. (51 mm) round devices and 4-1/2 in. (114 mm) for nom 4 in. (102 mm) round devices.

See **Concrete Blocks** (CAZT) category in Fire Resistance Directory for names of manufacturers.

- Through-Penetrants** — One or more metallic pipes, conduits or tubes, nonmetallic pipes, conduits or tubes, cables, and combinations of penetrants, as described below, may be installed within each firestop device (Item 3A) as further specified below. Through penetrants to be rigidly supported on both sides of wall assembly. The following types and sizes of through-penetrants may be used:
 - Metallic Penetrants** — One or more metallic pipe, tubing or conduit may be installed concentrically or eccentrically within each firestop device (Item 3A). Through penetrants to be rigidly supported on both sides of floor or wall assembly. The following types and sizes of through penetrants may be used:
 - Steel Pipe** — Nom 3 in. (76 mm) diam (or smaller) Schedule 10 (or heavier) steel pipe.
 - Iron Pipe** — Nom 3 in. (76 mm) diam (or smaller) cast or ductile iron pipe.
 - Copper Tubing** — Nom 3 in. (76 mm) diam (or smaller) Type L (or heavier) copper tube.
 - Copper Pipe** — Nom 3 in. (76 mm) diam (or smaller) Regular (or heavier) copper pipe.
 - Conduit** — Nom 3 in. (76 mm) diam (or smaller) steel electrical metallic tubing (EMT) or rigid steel conduit.
 - Through Penetrating Product* - Flexible Metal Piping** — Nom 1-1/4 in. diam (32 mm) diam (or smaller) steel flexible metal piping.

OMEGA FLEX INC — TracPipe Flexible Gas Piping

- Tube Insulation - Plastic+** — Nom 1/2 in (13 mm) thick or smaller acrylonitrile butadiene/polyvinyl chloride (AB/PVC) flexible foam furnished in the form of tubing with skin may be used on the copper tubes. If multiple insulated through penetrants are installed within the firestop device, the insulated through penetrants may be bundled together. If tube insulation is used, the max nom diam if the metallic through penetrant shall be 3/4 in. (19 mm).

See **Plastics+** (QMFZ2) category in the Plastics Recognized Component Directory for names of manufacturers. Any Recognized Component tube insulation material meeting the above specifications and having a UL 94 Flammability Classification of 94-5VA may be used.

- Nonmetallic Penetrants** — One or more nonmetallic pipes or tubes, as described in a single line item below, may be installed within each firestop device (Item 3A):
 - Polyvinyl Chloride (PVC) Pipe** — One nom 2 in. (51 mm) diam (or smaller) Schedule 40 solid core PVC pipe for use in closed (process or supply) or vented (drain, waste or vent) piping systems.
 - Chlorinated Polyvinyl Chloride (CPVC) Pipe** — One nom 2 in. (51 mm) diam (or smaller) SDR11 CPVC pipe for use in closed (process or supply) piping systems.
 - Rigid Nonmetallic Conduit+** — One nom 2 in. (51 mm) diam (or smaller) Schedule 40 PVC conduit installed in accordance with the National Electrical Code (NFPA No. 70).

System No. C-AJ-8172 *continued*

See **Rigid Nonmetallic, Schedule 40 and 80 PVC Conduit (DZYR)** category in the Electrical Construction Equipment Directory for names of manufacturers.

- C4. **Electrical Nonmetallic Tubing (ENT)+** — One nom 2 in. (51 mm) diam (or smaller) ENT installed in accordance with the National Electrical Code (NFPA No. 70).

See **Electrical Nonmetallic Tubing (FKHU)** category in the Electrical Construction Equipment Directory for names of manufacturers.

- C5. **Optical Fiber/Communications/Signaling/Coaxial Cable Raceways+** — One nom 2 in. (51 mm) diam (or smaller) plenum rated raceways installed in accordance with the National Electrical Code (NFPA No. 70).

See **Electrical Nonmetallic Tubing (FKHU)** category in the Electrical Construction Equipment Directory for names of manufacturers.

- C6. **Acrylonitrile Butadiene Styrene (ABS) Pipe** — One nom 2 in. (51 mm) diam (or smaller) Schedule 40 solid or cellular core ABS pipe for use in closed (process or supply) or vented (drain, waste or vent) piping systems.

D. **Cables** — One or more cables concentrically or eccentrically within each firestop device. The cable loading within the loading area of each firestop device module may represent a 0 to 100 percent visual fill. Any combination of the following types and sizes of cables may be used:

- D1. Max 2/C No. 18 AWG copper conductor thermostat cable with polyvinyl chloride (PVC) insulation and jacket materials.
D2. Max 4 pair No. 24 AWG copper conductor Cat5e or Cat 6 telephone cable with PVC insulation and jacket materials.
D3. Max RG/U (or smaller) coaxial cable with foam high density polyethylene insulation and PVC jacket materials.
D4. Max 3/C (with ground) No. 14 AWG (or smaller) nonmetallic sheathed (Romex) cable with PVC insulation and jacket materials.
D5. Max 1/C No. 8 AWG copper conductor cable with PVC insulation and nylon jacket materials.
D6. Max 12 core No. 26 AWG shielded multi coax cable with foam high density polyethylene insulation and PVC jacket.
D7. Max 48MM62.5 micron fiber optic cables with having a min FT-6 rating.
D8. Max 62.5/125 micron fiber optic cables with having a min Riser rating.
D9. Max 1/C 3/0 AWG copper conductor cable with PVC insulation and jacket materials.
D10. Max three copper conductors (with ground) No. 12 AWG **Metal Clad Cable+**.
D11. Max four copper conductors No. 2 AWG **Metal Clad Cable+**.

AFC CABLE SYSTEMS INC

- D12. Max 1/C 2/0 AWG non halogen copper conductor cable.
D13. Max 300 pair No. 24 AWG copper conductor telephone cable with PVC insulation and jacket materials.
D14. Max 30 pair No. 22 copper conductor shielded switchboard cable with PVC insulation and jacket materials.
D15. Max RG/6 (or smaller) coaxial cable with fluorinated ethylene (FE) or PVC insulation and jacket materials.
D16. Max RG/U (or smaller) coaxial cable with fluorinated ethylene (FE) or PVC insulation and jacket materials.
D17. Max 7/C No. 12 AWG copper conductors with PVC insulation and jacket materials.
D18. Max 4 pair No. 23 AWG copper conductor Cat 6 telephone cable with PVC insulation and jacket materials.
D19. Max three copper conductors (with ground) No. 12 AWG steel **Armored Cable+**.
D20. Max 04-02 2 5M fiber optic cables having a max diameter of 0.450 in. (11.4 mm).
D21. Max 1/C No. 750 kcmil copper conductors with PVC insulation and fabric jacket materials.
D22. Max 3/C with ground No. 2/0 AWG aluminum conductor SER cable with cross linked polyethylene (XLPE) insulation and PVC jacket.

3. **Firestop System** — The firestop system shall consist of the following:

- A. **Firestop Device*** — A max of three square firestop devices may be ganged together. As an alternate, one round device may be centered within a round opening. Each device consists of a nom 2-1/2 by 2-1/2 by 10 in. (64 by 64 by 254 mm), a nom 4 by 4 by 10 in. (102 by 102 by 254 mm), a nom 2 in. (51 mm) diam by 10 in. (254 mm) or a nom 4 in. (102 mm) diam by 10 in. (254 mm) powder coated steel transit incorporating internal intumescent material, foam plugs and mounting flanges. Firestop device to be centered within opening and installed with ends projecting an equal distance beyond each surface of the floor or wall assembly in accordance with the accompanying installation instructions. The annular space between the firestop device(s) and the periphery of the opening shall be nom 1/4 in. (6 mm). Firestop devices secured in place by means of fill material (Item 4B) and steel split mounting flanges sized to accommodate the firestop device. Steel split mounting flanges installed on both sides of floor or wall after installation of fill material and secured to together with supplied steel set screws. Nom 1 in. (25 mm) thick pre-cut foam plugs sized to accommodate the through penetrant(s) and installed flush with each end of device on both sides of floor or wall assembly.

3M COMPANY — 3M Fire Barrier Pass-Through Device

- B. **Fill, Void or Cavity Materials* - Caulk or Putty** — Min 1 in. (25 mm) thickness of fill material applied within the annulus, flush with top surface of floor or with both surfaces of wall prior to the installation of the mounting flanges. When the annular space is 1/8 in. (3 mm) or less, the fill material in the annulus is optional. Also, as an option, the foam plugs may be recessed into device and the recess filled with putty or caulk flush with the ends of the device. L Rating applies only when fill material is applied within annulus at interface of floor or both sides of wall and device(s) prior to mounting flanges and with both ends of firestop device(s) filled with nominal 1/8 in. (3.2 mm) of Moldable Putty+.

3M COMPANY — Moldable Putty+, CP 25WB+, IC 15WB+, 3000 WT. CP 25WB+ not suitable for use with CPVC pipes.

* Indicates such products shall bear the UL or cUL Certification Mark for jurisdictions employing the UL or cUL Certification (such as Canada), respectively.

+ Bearing the UL Listing Mark

System No. C-AJ-8187

June 23, 2015

F Rating — 2 Hr

T Rating — 0 Hr

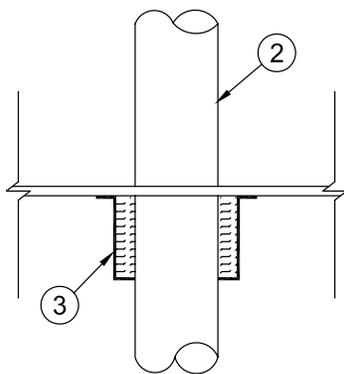
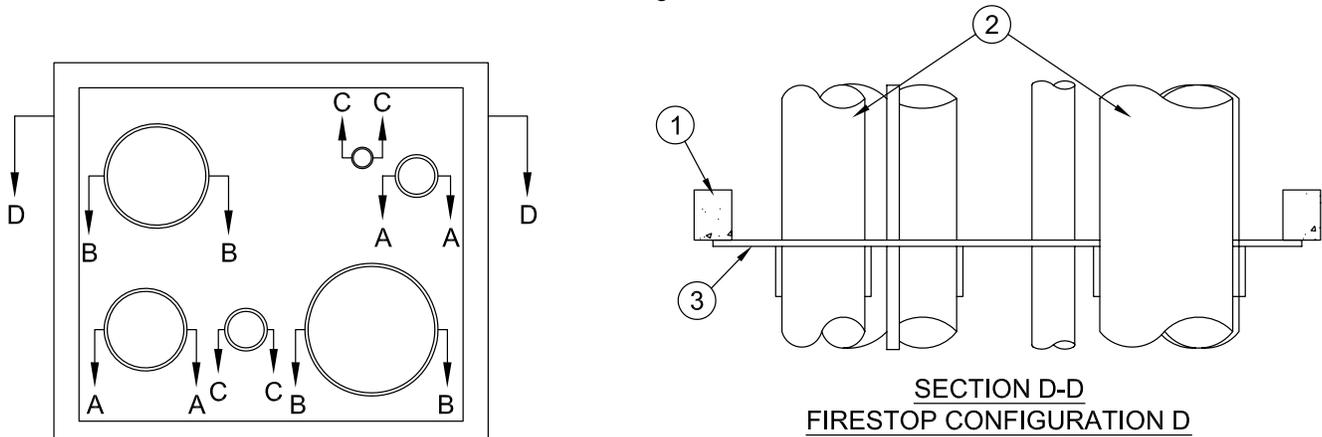
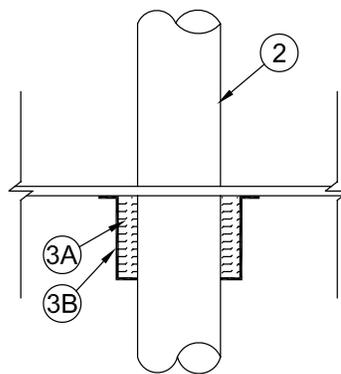
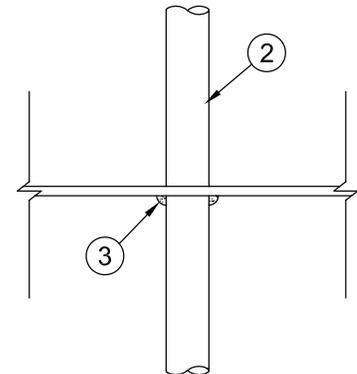
SECTION A-A
FIRESTOP CONFIGURATION ASECTION B-B
FIRESTOP CONFIGURATION BSECTION C-C
FIRESTOP CONFIGURATION C

- Floor or Wall Assembly** — Min 4-1/2 in. (114 mm) thick reinforced lightweight or normal weight (100-150 pcf or 1600 - 2400 kg/m³) concrete. Wall may also be constructed of any UL Classified Concrete Blocks*. Max area of opening 7 ft² (6503 cm²) with max dimension of 34 in. (864 mm).

See **Concrete Block (CAZT)** category in the Fire Resistance Directory for names of manufacturers.

- Through Penetrants** — A max of six firestop configurations may be installed within the opening. The space between firestop configurations shall be min 1 in. (25 mm) to max 42-3/4 in. (109 cm). The annular space between firestop configurations and periphery of opening shall be 0 in. (0 mm, point contact). Penetrants to be rigidly supported on both sides of floor or wall assembly.
- Firestop System — Fill, Void or Cavity Materials* — Intumescent Sheet** — Rigid aluminum foil-faced sheets with galv steel sheet backer. Sheet cut to tightly follow the contours of the penetrants or wrap strip and to lap a min of 3 in. (76 mm) on the floor or wall surface on all sides of the through opening. Sheets to be installed with the galv steel sheet backer exposed (aluminum foil facing against floor or wall surfaces). Sheets secured to bottom side of floor or both sides of wall using steel Tapcon fasteners spaced max 6 in. (152 mm) OC.

3M COMPANY 3M FIRE PROTECTION PRODUCTS — CS-195+

- 3A. Fill, Void or Cavity Material—Sealant (Not Shown)** — Min 1/4 in. (6 mm) diam continuous bead of fill material applied to edge of intumescent sheet at its interface with surface of floor or wall around entire perimeter of through opening on bottom surface of floor and both surfaces of wall.

3M COMPANY 3M FIRE PROTECTION PRODUCTS — MP+, CP-25WB+ Caulk or FB-3000 WT Sealant

Any combination of the following firestop configurations detailed herein may be used:

Firestop Configuration A

- Through Penetrants** — The details of the through penetrants are as follows:
 - Polyvinyl Chloride (PVC) Pipe** — Nom 4 in. (102 mm) diam (or smaller) Schedule 40 solid core PVC pipe for use in closed (process or supply) or vented (drain, waste or vent) piping systems.
 - Chlorinated Polyvinyl Chloride (CPVC) Pipe** — Nom 4 in. (102 mm) diam (or smaller) SDR13.5 solid core CPVC pipe for use in closed (process or supply) piping systems.
 - Rigid Nonmetallic Conduit (RNC)+** — Nom 4 in. (102 mm) diam (or smaller) Schedule 40 PVC conduit installed in accordance with the National Electrical Code (NFPA No. 70).

System No. C-AJ-8187 *continued*

3. **Firestop Device*** — Firestop device consisting of a steel collar lined with intumescent material sized to fit the specific diameter of the through penetrant. Firestop device provided with steel clips for attachment to underside of floor or both sides of wall in accordance with accompanying installation instructions.

3M COMPANY 3M FIRE PROTECTION PRODUCTS — Ultra PPD 3.0 or Ultra PPD 4.0

Firestop Configuration B

2. **Through Penetrants** — The details of the through penetrants are as follows:
- A. **Polyvinyl Chloride (PVC) Pipe** — Nom 6 in. (152 mm) diam (or smaller) Schedule 40 solid core PVC pipe for use in closed (process or supply) or vented (drain, waste or vent) piping systems.
 - B. **Chlorinated Polyvinyl Chloride (CPVC) Pipe** — Nom 6 in. (152 mm) diam (or smaller) SDR13.5 solid core CPVC pipe for use in closed (process or supply) piping systems.
 - C. **Rigid Nonmetallic Conduit (RNC)+** — Nom 6 in. (152 mm) diam (or smaller) Schedule 40 PVC conduit installed in accordance with the National Electrical Code (NFPA No. 70).

3. **Firestop System** — The details of the firestop system shall be as follows:

- A. **Fill, Void or Cavity Material — Wrap Strip** — Nom 1/8 in. (3 mm) thick intumescent elastomeric material supplied 2 in. (51 mm) wide strips. Two stacks of wrap strips, each consisting of three wrap strips are individually wrapped around the through-penetrant with the ends butted and held in place with masking tape. Butted ends in successive layers shall be offset. The edge of the wrap strips shall abut the surface of the composite sheet (Item 3). In floor assemblies the two stacks of wrap strips are installed on the bottom side of the composite sheet. In wall assemblies, the two stacks of wrap strips are installed on each side of the composite sheet. As an option, the penetrant may be wrapped with aluminum foil tape beneath the wrap strips.

3M COMPANY 3M FIRE PROTECTION PRODUCTS — Interam Ultra GS

- B. **Steel Collar** — Steel restricting collar fabricated from No. 28 MSG (0.016 in., 0.405 mm) thick galvanized steel. Collar shall be nom 4 in. (102 mm) deep with 1-1/4 in. (32 mm) wide and 1-1/2 in. (38 mm) long anchor tabs and min 3/4 in. (19 mm) long tabs to retain the layers of intumescent material. Collar anchor tabs are bent outward 90°. Collar wrapped tightly around layers of intumescent material with min 1 in. (25 mm) overlap at seam and compressed around penetrant using steel hose clamps with worm drive tightening mechanism at the collar midheight. The collar is secured to the intumescent sheet surface with 1/4 in. (6 mm) diam by min 1-1/2 in. (38 mm) long steel toggle bolts in conjunction with 1-1/4 in. (32 mm) diam washers on bottom surface of floor and both surfaces of wall. As a final step, the retainer tabs shall be bent 90° towards the pipe to lock layers of intumescent material in position.

Firestop Configuration C

2. **Through Penetrants** — The details of the through penetrants are as follows:
- A. **Copper Tubing** — Nom 2 in. (51 mm) diam (or smaller) Type L (or heavier) copper tube.
 - B. **Steel Pipe** — Nom 2 in. (51 mm) diam (or smaller) Schedule 5 (or heavier) steel pipe.
 - C. **Iron Pipe** — Nom 2 in. (51 mm) diam (or smaller) cast or ductile iron pipe.
 - D. **Conduit** — Nom 2 in. (51 mm) diam (or smaller) rigid steel conduit or steel electrical metallic tubing.
3. **Fill, Void or Cavity Materials* — Putty, Caulk or Sealant** — Min 1/4 in. (6 mm) rope of putty or 1/4 in. (6 mm) diam bead of sealant or caulk applied at point contact locations between penetrant and periphery of opening on bottom of composite sheet.

3M COMPANY 3M FIRE PROTECTION PRODUCTS — MP+, CP-25WB+ Caulk or FB-3000 WT Sealant. CP 25WB+ not suitable for use with CPVC pipes.

* Indicates such products shall bear the UL or cUL Certification Mark for jurisdictions employing the UL or cUL Certification (such as Canada), respectively.

+Bearing the UL Listing Mark

System No. C-AJ-8205

September 20, 2011

ANSI/UL1479 (ASTM E814)

F Rating – 2 Hr

T Rating – 1/2 Hr

CAN/ULC S115

F Rating – Hr

FT Rating – 1/2 Hr

FH Rating – Hr

FTH Rating – 1/2 Hr

System tested with a pressure differential of 2.5 Pa between the exposed and the unexposed surfaces with the higher pressure on the exposed side.

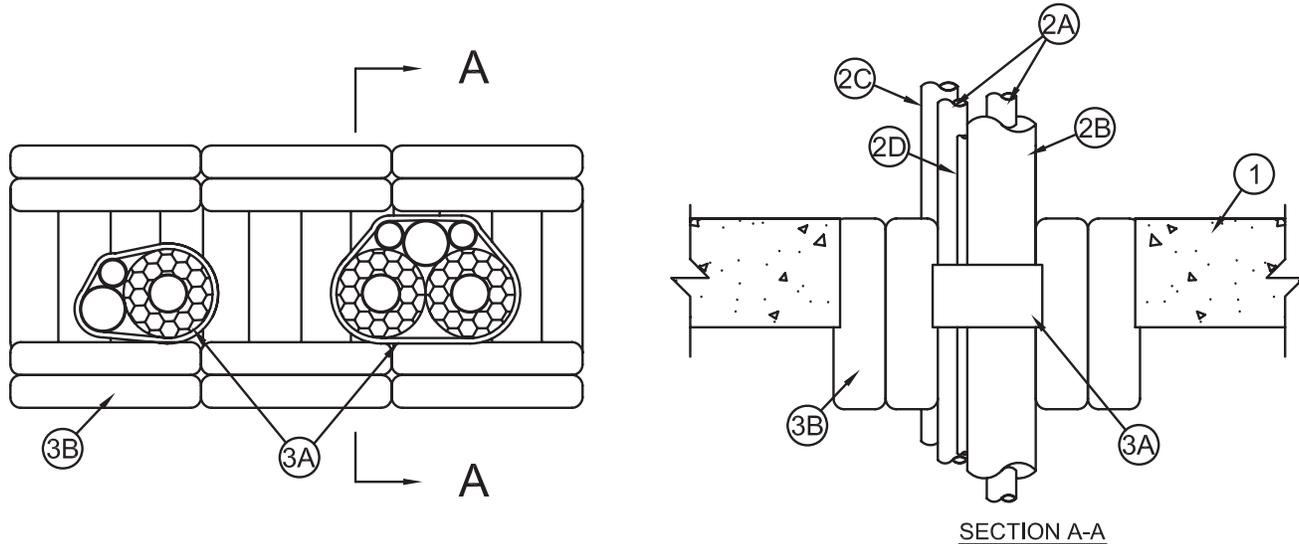

- Floor or Wall Assembly** – Min 4-1/2 in. (114 mm) thick reinforced lightweight or normal weight (100-150 pcf or 1600-2400 kg/m³) concrete. Wall may also be constructed of any UL Classified **Concrete Blocks***. Max area of opening is 1024 sq in. (0.66 m²) with a max height of 32 in. (813 mm) when installed in a wall or a max width of 32 in. (813 mm) when installed in a floor.
See **Concrete Blocks (CAZT)** category in the Fire Resistance Directory for names of manufacturers.
- Air Conditioning (AC) Line Set** – One or two single or double AC line sets installed within opening. Each single AC line set consists of two metallic pipes or tubes (Item 2A), tubing insulation (Item 2B), one nonmetallic pipe (Item 2C) and a thermostat cable (Item 2D). Each double AC line set consists of four metallic pipes or tubes (Item 2A), tubing insulation (Item 2B), one nonmetallic pipe (Item 2C) and two thermostat cables (Item 2D). The space between the AC line sets shall be min 2 in. (51 mm) to max 6 in. (152 mm). The space between the AC line sets and the periphery of the opening shall be min 2 in. (51 mm) to max 6 in. (152 mm). The AC line sets shall be rigidly supported on both sides of the floor or wall assembly.
 - Metallic Pipe** – A max of two pipes or tubes to be installed in each AC line set. The following types and sizes of through metallic pipe may be used:
 - Copper Pipe** – Nom 3/4 in. (19 mm) diam (or smaller) Regular (or heavier) copper pipe.
 - Copper Tube** – Nom 3/4 in. (19 mm) diam (or smaller) Type L (or heavier) copper tube.
 - Tube Insulation – Plastics#** – Nom 3/4 in. (19 mm) thick acrylonitrile butadiene/polyvinyl chloride (AB/PVC) flexible foam furnished in the form of tubing. The tube insulation may be installed on one max 3/4 in. (19 mm) diam pipe or tube in each single AC line set and on two max 3/4 in. (19 mm) diam pipes or tubes in each double AC line set.
See **Plastics (QMFZ2)** category in the Plastics Recognized Component Directory for names of manufacturers. Any Recognized Component tube insulation meeting the above specifications and having a UL 94 Flammability Classification of 945VA may be used.
 - Nonmetallic Pipe** – A max of one nonmetallic drain pipe to be installed in each AC line set. The following types and sizes of nonmetallic pipe may be used:
 - Polyvinyl Chloride (CPVC) Pipe** – Nom 1-1/4 in. (32 mm) diam (or smaller) Schedule 40 solid core PVC pipe.
 - Chlorinated Polyvinyl Chloride (CPVC) Pipe** – Nom 1-1/4 in. (32 mm) diam (or smaller) SDR 13.5 CPVC pipe.
 - Cable** – Four pair No. 18 AWG (or smaller) thermostat cable with polyvinyl chloride (PVC) insulation and jacket materials. One thermostat cable may be installed with each single AC line set and two thermostat cables may be installed with each double AC line set.
- Firestop System** – The firestop system shall consist of the following items:
 - Fill, Void or Cavity Materials* – Wrap Strip** – Nom 3/16 in. (5 mm) thick intumescent material supplied in nom 2-1/2 in. (64 mm) wide strips. One layer of wrap strip tightly wrapped around each AC line set and secured with glass fiber-reinforced strapping tape. Wrap strip to be recessed into floor opening such that the bottom edge of wrap strip is flush with bottom plane of floor. In walls, wrap strip to be centered in the wall thickness.

3M COMPANY**3M FIRE PROTECTION PRODUCTS** – Fire Barrier Tuck-In WS Roll

System No. C-AJ-8205 continued

- B. **Fill, Void or Cavity Materials* – Pillows** – Max 9 in. (229 mm) long by 6 in. (152 mm) wide by 2 and 3 in. (51 and 76 mm) thick plastic covered pillows tightly-packed to fill annular space between the AC line set and periphery of opening and the annular space between the AC line sets installed within the opening. Pillows installed with 9 in. (229 mm) dimension projecting through the floor or wall. In floors, pillows to be installed flush with top plane of floor or centered in floor thickness. In walls, pillows to be centered in wall thickness.

3M COMPANY

3M FIRE PROTECTION PRODUCTS – Fire Barrier Pillow or Fire Barrier Self-Locking Pillow

- C. **Fill, Void or Cavity Materials* – Putty** – (Not Shown) – Moldable putty material, installed within voids around penetrants and pillows to a min thickness of 1 in. (25 mm) on both sides of wall.

3M COMPANY

3M FIRE PROTECTION PRODUCTS – MP+ Moldable Putty

*Bearing the UL Classification Mark

+Bearing the UL Listing Mark

Reprinted from the Online Certifications Directory with permission from Underwriters Laboratories Inc.
Copyright © 2011 Underwriters Laboratories Inc.®



Through Penetrations

Combos

8000 Series

Concrete

CAJ

System No. C-AJ-8206

October 07, 2010

F Rating – 3 Hr

T Rating – 0 Hr

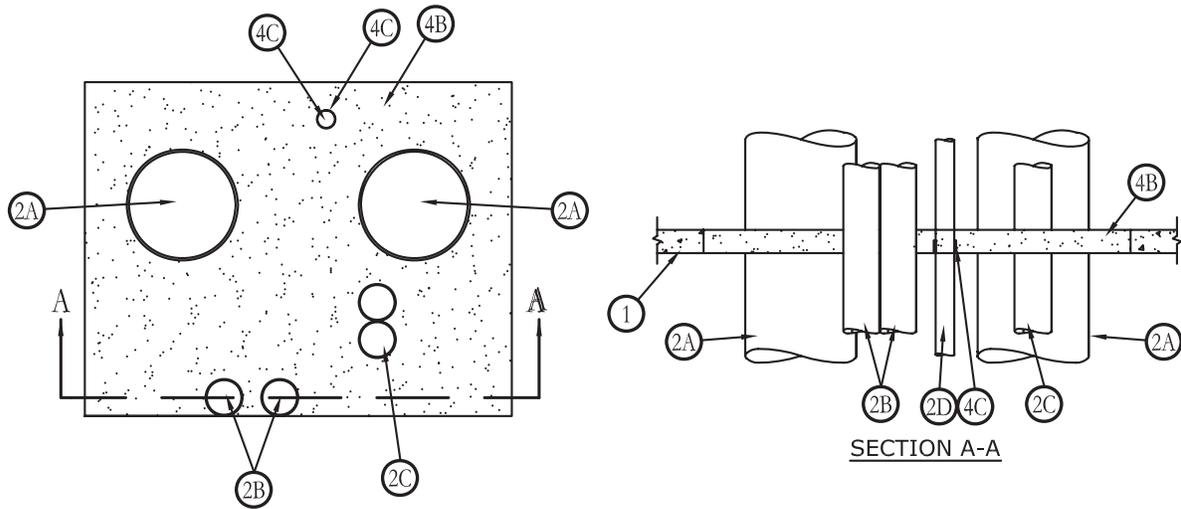

- Floor or Wall Assembly** – Min 2-1/2 in. (63 mm) thick reinforced lightweight or normal weight (100-150 pcf or 1600-2400 kg/m³) concrete. Wall may also be constructed of any UL Classified **Concrete Blocks***. Max area of opening is 1656 sq in. (1.07 m²) with max dimension of 46 in. (1168 mm).
See **Concrete Blocks (CAZT)** category in the Fire Resistance Directory for names of manufacturers.
- Through Penetrants** – A max of seven penetrants to be installed in opening. Min clearance between pipes, conduits or tubing is 0 in. (point contact). Min clearance between pipe, conduit, or tubing and periphery of through opening is 0 in. (point contact). Pipe conduit or tubing to be rigidly supported on both sides of floor or wall assembly. The following types and sizes of pipes, conduits, or tubing may be used:
 - Steel Pipe** – Nom 12 in. (305 mm) diam, or smaller, schedule 10, or heavier, steel pipe.
 - Copper Tubing** – Nom 4 in. (102 mm) diam, or smaller, Type L, or heavier, copper tubing.
 - Conduit** – Nom 4 in. (102 mm) diam, or smaller steel electrical metallic tubing or steel conduit.
 - PVC Pipe** – Nom 2 in. (50 mm) diam, or smaller, Schedule 40 solid-core PVC pipe for use in closed (process or supply), or vented (drain, waste, or vent) piping systems.
- Forms** – (Not Shown) – Used as a form to prevent leakage of fill material during installation. Forms to be a rigid sheet material, cut to fit the contour of the penetrating item and positioned as required to accommodate the required thickness of fill material. Forms to be removed after fill material has cured.
- Firestop System** – The firestop system shall consist of the following:
 - Packing Material** – (Optional, Not Shown) – For floors greater than 2-1/2 in. (63 mm) thick, mineral wool batt insulation firmly packed into opening as a permanent or temporary form and recessed from the top surface of floor, or both surfaces of wall, to accommodate the required thickness of the fill material, item 5B.
 - Fill, Void, or Cavity Material*** – **Mortar** – Min 2-1/2 in. (63 mm) thickness of fill material applied within the annulus. Mortar to be mixed with water in accordance with manufacturer's instructions. TAPCON concrete screws, spaced at max 12 in. (305 mm) OC, to be partially embedded into the vertical sides of opening all-around to key the mortar to the opening periphery. A Nom 1/4 in to 3/8 in (6 mm to 10 mm) high crown bead of mortar to be applied at the top surface of the floor or both surfaces of wall to cover the edges of the Wrap Strip, item 5C.
3M COMPANY
3M FIRE PROTECTION PRODUCTS – 3M Fire Barrier Mortar
 - Fill, Void, or Cavity Material*** – **Wrap Strip** – Nom 3/16 in. (5 mm) thick intumescent material supplied in nom 2-1/2 in. (64 mm) wide strips. One layer of wrap strip to be tightly wrapped around pipe and secured with glass-fiber reinforced strapping tape and positioned such that the top and bottom edges are approximately flush with the top and bottom floor surfaces. In walls, wrap strip to be flush with both surfaces of wall.
3M COMPANY
3M FIRE PROTECTION PRODUCTS – Tuck-In Wrap Strip WS 200

*Bearing the UL Classification Mark

Reprinted from the Online Certifications Directory with permission from Underwriters Laboratories Inc.
Copyright © 2011 Underwriters Laboratories Inc.®



Note: Systems with Nonmetallic Through Penetrant(s) have not been evaluated with a pressure differential of 50 Pa between the exposed and unexposed surfaces as required by the National Building Code of Canada.

System No. C-AJ-8216

May 02, 2012

ANSI/UL1479 (ASTM E814)

F Rating – 2 Hr

T Rating – 0 Hr

CAN/ULC S115

F Rating – 2 Hr

FT Rating – 0 Hr

FH Rating – 2 Hr

FTH Rating – 0 Hr

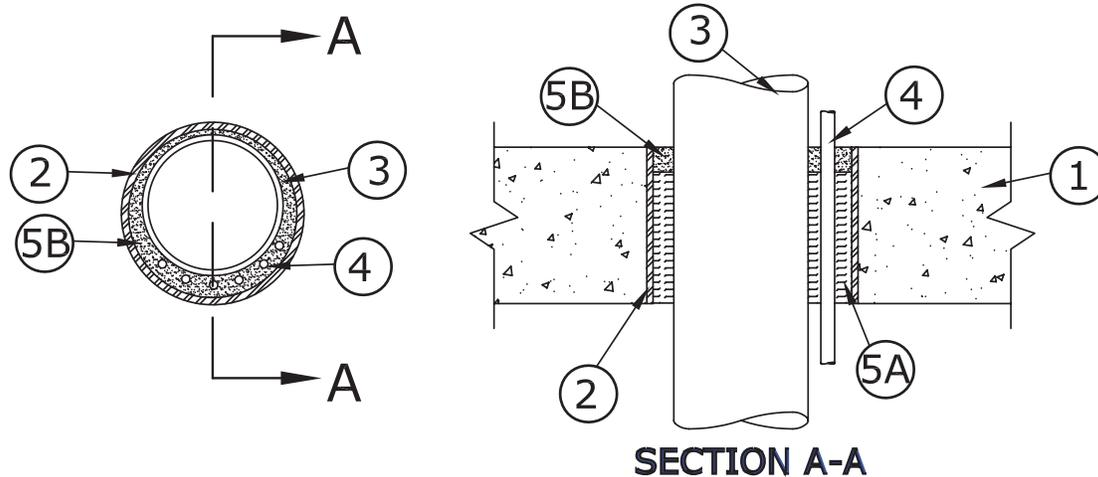

SECTION A-A

- Floor or Wall Assembly** – Min 2-1/2 in. (64 mm) thick reinforced lightweight or normal weight (100-150 pcf or 1600-2400 kg/m³) concrete floor or min 3 in. (76 mm) reinforced lightweight or normal weight concrete wall. Wall may also be constructed of any UL Classified **Concrete Blocks***. Max diameter of opening is 8 in. (203 mm).
See **Concrete Blocks (CAZT)** category in the Fire Resistance Directory for names of manufacturers.
 - Metallic Sleeve** – (Optional) - Nom 8 in. (203 mm) diam (or smaller) Schedule 40 (or heavier) steel sleeve cast or grouted into floor or wall assembly, flush with floor or wall surfaces or extending a max of 3 in. (76 mm) above floor or beyond both surfaces of wall.
 - Sheet Metal Sleeve** – (Optional, Not Shown) – Max 6 in. (152 mm) diam, min No. 26 ga galv steel sleeve provided with a No. 26 ga galv steel square flange spot welded to the sleeve at approx mid-height, or flush with bottom of sleeve in floors, and sized to be a min of 2 in. (51 mm) larger than the sleeve diam. The sleeve is to be cast in place and may extend a max of 4 in. (102 mm) below the bottom of the floor and a max of 1 in. (25 mm) above the top surface of the concrete floor.
 - Sheet Metal Sleeve** – (Optional, Not Shown) – Max 8 in. (203 mm) diam, min No. 24 ga galv steel sleeve provided with a No. 24 ga galv steel square flange spot welded to the sleeve at approx mid-height, or flush with bottom of sleeve in floors, and sized to be a min of 2 in. (51 mm) larger than the sleeve diam. The sleeve is to be cast in place and may extend a max of 4 in. (102 mm) below the bottom of the floor and a max of 1 in. (25 mm) above the top surface of the concrete floor.
 - Steel Tube** – Nom 6 in. (152 mm) diam (or smaller) No. 16 ga steel tube installed eccentrically within the opening. The annular space between the tube and the periphery of the opening shall be min 1/4 in. (6 mm) to max 1 3/4 in. (45 mm). Tube to be rigidly supported on both sides of floor or wall assembly.
 - Cables** – Max of six nom 3/8 in. (10 mm) diam two pair No. 22 AWG foil shielded plenum rated communication cables with polyvinyl chloride (PVC) insulation and jacket. Min separation between cables and periphery of opening shall be 1/4 in. (6 mm). Separation between cables and tube shall be min 0 in. (point contact) to max 1 in. (25 mm). Cables to be rigidly supported on both sides of floor or wall assembly.
 - Firestop System** – The firestop system shall consist of the following:
 - Packing Material** – Min 2 in. (51 mm) thickness of min 4 pcf (64 kg/m³) mineral wool batt insulation firmly packed into opening as a permanent form. Packing material to be recessed from top surface of floor or from both surfaces of wall to accommodate the required thickness of fill material.
 - Forming Material*** – As an alternate to the packing material (Item 5A), nom 4 in. (102 mm) wide strips of min 1/2 in. (13 mm) thick compressible mat cut in half lengthwise to a nom 2 in. (51 mm) width to be stacked to a thickness greater than the width of the annular space and compression-fitted, edge-first, to fill the annular space to a min 2 in. (51 mm) depth. As an option, the strips of min 1/2 in. (13 mm) thick compressible mat may be folded in half, lengthwise, and stacked to a thickness greater than the width of the annular space and compression-fitted, edge-first, to fill the annular space to a min 2 in. (51 mm) depth. Top of forming material to be recessed from top surface of floor or from both surfaces of wall as necessary to accommodate the required thickness of caulk fill material.
- 3M COMPANY**
3M FIRE PROTECTION PRODUCTS – Fire Barrier Packing Material PM-4
- Fill, Void or Cavity Material* – Sealant** – Min 1/2 in. (13 mm) thickness of fill material applied within the annulus, flush with top surface of floor or with both surfaces of wall.
3M COMPANY
3M FIRE PROTECTION PRODUCTS – IC 15WB+ Sealant, CP 25WB+ Sealant or FB 3000 WT Sealant

*Bearing the UL Classification Mark

Reprinted from the Online Certifications Directory with permission from UL
© 2013 UL LLC



System No. C-AJ-8217

February 20, 2014

ANSI/UL1479 (ASTM E814)
 F Ratings — 2 Hr
 T Rating — 1/4 Hr
 L Rating at Ambient - Less than 1 CFM/sq ft
 L Rating at 400 F - Less than 1 CFM/sq ft

CAN/ULC S115
 F Ratings — 2 Hr
 FT Rating — 1/4 Hr
 FH Ratings — 2 Hr
 FTH Rating — 1/4 Hr
 L Rating at Ambient - Less than 1 CFM/sq ft
 L Rating at 400 F - Less than 1 CFM/sq ft

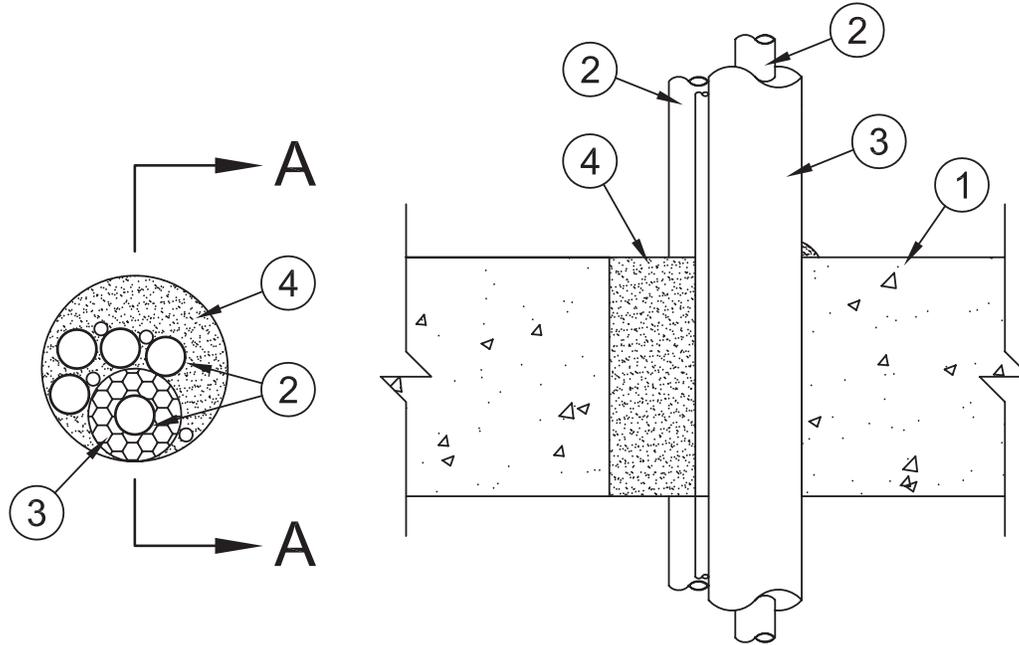

SECTION A-A

System tested with a pressure differential of 2.5 Pa between the exposed and the unexposed surfaces with the higher pressure on the exposed side.

1. **Floor or Wall Assembly** – Min 2-1/2 in. (64 mm) thick lightweight or normal weight (100-150 pcf or 1600-2400 kg/m³) concrete. Max diam of opening 6 in. (152 mm).
2. **Through Penetrants** – A max of five pipes, conduits or tubes and a max of four cables to be installed within the opening. Annular space between the penetrants and the periphery of the opening shall be min 0 in. (point contact) to max 3-1/4 in. (83 mm). Penetrants to be rigidly supported on both sides of floor or wall assembly. The following types and sizes of penetrants may be used:
 - A. **Metallic Pipes** – A max of four metallic pipes, conduits or tubing may be used. The following types and sizes may be used:
 - A1. **Steel Pipe** – Nom 1 in. (25 mm) diam (or smaller) Schedule 5 (or heavier) steel pipe.
 - A2. **Conduit** – Nom 1 in. (25 mm) diam (or smaller) electrical metallic tubing or rigid steel conduit.
 - A3. **Copper Tubing** – Nom 1 in. (25 mm) diam (or smaller) Type L (or heavier) copper tubing.
 - A4. **Copper Pipe** – Nom 1 in. (25 mm) diam (or smaller) Regular (or heavier) copper pipe.
 - B. **Nonmetallic Pipes** – A max of one nonmetallic pipe or conduit may be used. The following types and sizes of nonmetallic pipes or conduits may be used:
 - B1. **Polyvinyl Chloride (PVC) Pipe** – Nom 1 in. (25 mm) diam (or smaller) Schedule 40 solid core PVC pipe for use in closed (process or supply) or vented (drain, waste or vent) piping system.
 - B2. **Rigid Nonmetallic Conduit+** – Nom 1 in. (25 mm) diam (or smaller) Schedule 40 PVC conduit installed in accordance with the National Electrical Code (NFPA No. 70.)
 - C. **Cables** – A max of four cables may be used. Max 4/C No. 18 AWG (or smaller) thermostat cables.
3. **Tube Insulation – Plastics++** – Nom 1/2 in. (13 mm) thick acrylonitrile butadiene/polyvinyl chloride (AB/PVC) flexible foam furnished in the form of tubing.
 See **Plastics** (QMFZ2) category in the Plastics Recognized Component Directory for names of manufacturers. Any Recognized Component tube insulation material meeting the above specifications and having a UL94 Flammability Classification of 94-5VA may be used.
4. **Fill, Void or Cavity Material* – Foam** – Min 2-1/2 in. (64 mm) thickness of fill material applied within the annulus, flush with top surface of floor or both surfaces of wall. At any point contact location, a minimum 1/2 in. bead of fill material is required on the top surface of the floor or both sides of a wall assembly.

3M COMPANY – Fire Barrier Rated Foam, FIP 1-Step

*Bearing the UL Classification Mark

+Bearing the UL Listing Mark

++Bearing the UL Recognized Component Mark

Reprinted from the Online Certifications Directory with permission from UL

© 2014 UL LLC





UL System No. C-AJ-8231
XHEZ – Through-penetration Firestop Systems
XHEZ7 – Through-penetration Firestop Systems Certified for Canada

June 20, 2017

| ANSI/UL1479 (ASTM E814) | CAN/ULC S115 |
|-------------------------|-------------------|
| F Rating – 2 Hr | F Rating – 2 Hr |
| T Rating – 0 Hr | FT Rating – 0 Hr |
| | FH Rating – 2 Hr |
| | FTH Rating – 0 Hr |

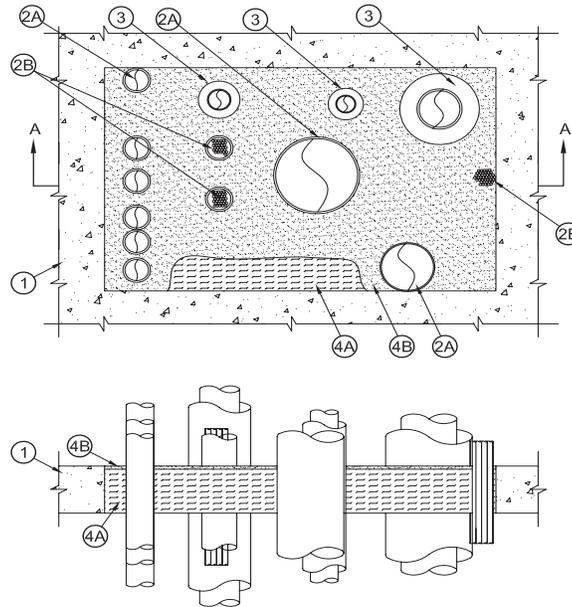

1. **Floor or Wall Assembly** – Min 4-1/2 in. (114 mm) thick reinforced lightweight or normal weight (100–150 pcf or 1600–2400 kg/m³) concrete floor. Min 5 in. (127 mm) thick reinforced lightweight or normal weight (100–150 pcf or 1600–2400 kg/m³) concrete wall. Wall may also be constructed of any UL Classified **Concrete Blocks***. Max size of opening is 1440 in.² (9,290 cm²) with a max dimension of 48 in. (1219 mm). See **Concrete Blocks** (CAZT) in the Fire Resistance Directory for names of manufacturers.
2. **Through-Penetrant** – One cable tray and/or one or more pipes, tubes or cable bundles may be installed within the opening. The total number of through-penetrants is dependent on the size of the opening and the types and sizes of the penetrants. Any combination of the penetrants described below may be used provided that the following parameters relative to the annular spaces are maintained. The annular space between cable tray and all other penetrants shall be min 3 in. (76 mm). The annular space between individual cables and cable bundles shall be a min 1/2 in. (13 mm). The annular space between individual cables and cable bundles and other penetrants shall be a min 1/2 in. (13 mm) except that a min 2 in. (51 mm) shall be maintained between the cables and copper pipes and tubes greater than a nom 3 in. (76 mm) diameter and steel and iron pipes and conduits greater than a nom 4 in. (102 mm) diam. The annular space between metallic pipes, conduit and tubes and insulated pipes and tubes shall be a min 2 in. (51 mm). The annular space between nom 3 in (76mm) diameter (and smaller) copper pipes and tubes and between nom 4 in (102mm) diameter (and smaller) steel and iron pipes and conduits shall be min 1/2 in. (13 mm). The annular space between nom 2 in. (51 mm) diameter (and smaller) metallic pipes and conduits shall be min 0 in. (point contact). The annular space between insulated penetrants or the cable tray and the periphery of opening shall be min 1/2 in. (13 mm). The annular space between all other penetrants and the periphery of opening shall be min 0 in. (point contact). A max annular space in the system shall be 17-1/2 in. (445 mm) for FB-3000WT sealant (Item 4B) and 12 in. (305 mm) for CP 25WB+ sealant (Item 4A). Penetrants to be rigidly supported on both sides of floor or wall assembly. The following types and sizes of penetrants may be used.
 - A. **Metallic Pipes** – The following types of metallic pipes, tubes or conduits may be used:
 1. **Copper Tubing** – Nom 6 in. (152 mm) diameter (or smaller) Type L (or heavier) copper tube.
 2. **Copper Pipe** – Nom 6 in. (152 mm) diameter (or smaller) Regular (or heavier) copper pipe.
 3. **Steel Pipe** – Nom 24 in. (610 mm) diameter (or smaller) Schedule 40 (or heavier) steel pipe.
 4. **Iron Pipe** – Nom 24 in. (610 mm) diameter (or smaller) cast or ductile iron pipe.
 5. **Conduit** – Nom 4 in. (102 mm) diameter (or smaller) electric metallic tubing (EMT) or nom 6 in. (152 mm) diameter (or smaller) rigid steel conduit.

- B. Cables Bundles** – Max 4 in. (102 mm) diameter tightly bundled cables. Any combination of the following types and sizes of cables may be used:
1. Max 500 kcmil single copper or aluminum conductor power cable with thermoplastic insulation and polyvinyl chloride (PVC) jacket.
 2. Max 300 pair No. 24 AWG copper conductor telecommunication cables with PVC insulation and jacket material.
 3. Max 7/C copper conductor No. 12 AWG multi-conductor power and control cables with PVC or cross-linked polyethylene (XLPE) insulation and PVC jacket.
 4. Multiple fiber optical communication cables jacketed with PVC and having a max outside diameter of 1/2 in.
 5. Max 3/C No. – 12 AWG steel clad cable with copper conductors and PVC insulation material.
- C. Individual Cables** – (Not shown) – Any of the following types and sizes of individual (non-bundled) cables may be used:
1. Max 3/C No. 2/0 AWG (or smaller) copper conductor PVC jacketed aluminum clad or steel clad TECK 90 cable.
 2. **Through Penetrating Product*** – Any cables, **Armored Cable+** or **Metal Clad Cable+** currently Classified under the **Through Penetrating Product** category.
See **Through Penetrating Product** (XHLY) category in the Fire Resistance Directory for names of manufacturers.
 3. Max 500 kcmil single copper or aluminum conductor power cable with thermoplastic insulation and polyvinyl chloride (PVC) jacket.
 4. Max 300 pair No. 24 AWG copper conductor telecommunication cables with PVC insulation and jacket material.
 5. Max 7/C copper conductor No. 12 AWG multi-conductor power and control cables with PVC or cross-linked polyethylene (XLPE) insulation and PVC jacket.
 6. Multiple fiber optical communication cables jacketed with PVC and having a max outside diameter of 1/2 in.
 7. Max 3/C No. 12 AWG steel clad cable with copper conductors and PVC insulation material.
 8. Max 4C/750 kcmil (or smaller) aluminum or copper conductor metal clad cable with aluminum or steel armor, with or without PVC jacket.
- D. Cable Tray*** – (Not shown) – Max 24 in. (610 mm) wide by 6 in. (152 mm) deep open-ladder steel or aluminum cable tray. Aggregate cross-sectional area of cable tray to be max 40 percent of the cross-sectional area of the cable tray based on a max 3 in. cable loading depth. Any combination of the types and sizes of cables described in Item 2B may be used. Cable tray to be rigidly supported on both sides of floor or wall assembly.
- 3. Pipe Insulation** – (Optional) – Pipes and tubes of the sizes noted below may be provided with one of the following types of pipe insulations:
- A. Pipe Covering*** – Nom 1-1/2 in. (38 mm) thick (or thinner) hollow cylindrical heavy density glass fiber units jacketed on the outside with an all service jacket for pipes with a nom diameter of 8 in. (203 mm) (or smaller) or tubes with a nom diameter of 4 in. (102 mm) (or smaller). Longitudinal joints sealed with metal fasteners or factory-applied self-sealing lap tape. Transverse joints secured with metal fasteners or with butt tape supplied with the product.
See **Pipe and Equipment Covering – Materials** (BRGU) category in the Building Materials Directory for names of manufacturers. Any pipe covering material meeting the above specifications and bearing the UL Classification Marking with a Flame Spread Index of 25 or less and a Smoke Developed Index of 50 or less may be used.
- B. Pipe Covering*** – Nom 2 in. (51 mm) thick (or thinner) hollow cylindrical heavy density glass fiber units jacketed on the outside with an all service jacket for pipes or tubes with a nom diameter of 2 in. (51 mm) (or smaller). Longitudinal joints sealed with metal fasteners or factory-applied self-sealing lap tape. Transverse joints secured with metal fasteners or with butt tape supplied with the product.
See **Pipe and Equipment Covering – Materials** (BRGU) category in the Building Materials Directory for names of manufacturers. Any pipe covering material meeting the above specifications and bearing the UL Classification Marking with a Flame Spread Index of 25 or less and a Smoke Developed Index of 50 or less may be used.
- C. Tube Insulation-Plastics+** – Nom 1 in. (25 mm) thick (or thinner) acrylonitrile butadiene/polyvinyl chloride (AB/PVC) flexible foam furnished in the form of tubing for pipes or tubes with a nom diameter of 2 in. (51 mm) (or smaller).
See **Plastics** (QMFZ2) category in the Plastics Recognized Component Directory for names of manufacturers. Any Recognized Component tube insulation material meeting the above specifications and having a UL 94 Flammability Classification of 94-5VA may be used.
- 4. Firestop System** – The firestop system shall consist of the following:
- A. Packing Materials** – Min 4 in. (102 mm) thickness of 4 pcf (64 kg/m³) mineral wool batt insulation tightly packed into the opening as a permanent form. Packing material to be recessed from top surface of floor or both surfaces of wall to accommodate the required thickness of fill material.
- B. Fill, Void or Cavity Material - Sealant*** – Min 1/2 in. (13 mm) thickness of fill material applied within the annulus flush with the top surface of the floor or both surfaces of the wall.

3M COMPANY – CP 25 WB+ or FB-3000 WT

*Indicates such products shall bear the UL or cUL Certification Mark for jurisdictions employing the UL or cUL Certification (such as Canada), respectively.
Reprinted from the Online Certifications Directory with permission from UL©



System No. C-AJ-8251

March 16, 2016

| ANSI/UL1479 (ASTM E814) | CAN/ULC S115 |
|-------------------------|---------------------|
| F Rating — 3 Hr | F Rating — 3 Hr |
| T Rating — 1/4 Hr | FT Rating — 1/4 Hr |
| | FH Rating — 3 Hr |
| | FTH Rating — 1/4 Hr |

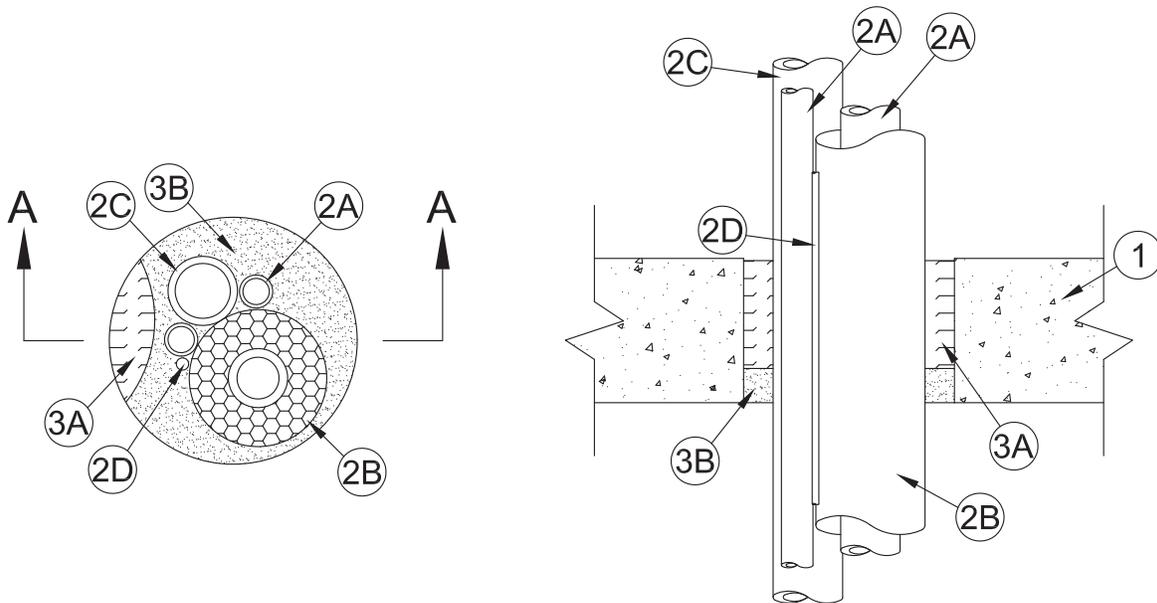

SECTION A-A

System tested with a pressure differential of 2.5 Pa between the exposed and the unexposed surfaces with the higher pressure on the exposed side.

- Floor or Wall Assembly** — Min 4-1/2 in. (114 mm) thick floor, or min 5-1/2 in. (140 mm) thick wall, of reinforced lightweight or normal weight (100-150 pcf or 1600-2400 kg/m³) concrete. Wall may also be constructed of any UL Classified **Concrete Blocks***. Floor may also be constructed of any min 6 in. (152 mm) thick hollow-core **Precast Concrete Units***. Max diam of opening is 4-1/2 in. (114 mm).

See **Concrete Blocks (CAZT)** or **Precast Concrete Units (CFTV)** categories in the Fire Resistance Directory for names of manufacturers.

- Air Conditioning (AC) Line Set** — One AC line set installed within opening. The AC line set consists of two metallic pipes or tubes (Item 2A), tubing insulation (Item 2B), one nonmetallic pipe (Item 2C) and two thermostat cables (Item 2D). The space between the AC line set and the periphery of the opening shall be min 1/4 in. (6 mm) to max 1-1/4 in. (32 mm). The AC line set penetrants shall be tightly bundled and rigidly supported on both sides of the floor or wall assembly.

A. Metallic Pipe — A max of three pipes or tubes to be installed in each AC line set. Two of the pipes may exceed nom 1/2 in. (13 mm) in diam. The following types and sizes of through metallic pipe may be used:

- Copper Pipe** — Nom 1 in. (25 mm) diam (or smaller) Regular (or heavier) copper pipe.
- Copper Tube** — Nom 1 in. (25 mm) diam (or smaller) Type L (or heavier) copper tube.

B. Tube Insulation — Plastics# — Nom 1/2 in. (13 mm) thick acrylonitrile butadiene/polyvinyl chloride (AB/PVC) flexible foam furnished in the form of tubing. The tube insulation shall be installed on one 1 in. (25 mm) diam (or smaller) pipe or tube in each single AC one of the metallic pipes (Item 2A).

See **Plastics (QMFZ2)** category in the Plastics Recognized Component Directory for names of manufacturers. Any Recognized Component tube insulation meeting the above specifications and having a UL 94 Flammability Classification of 945VA may be used.

C. Nonmetallic Pipe — A max of one nonmetallic drain pipe to be installed in each AC line set. The following types and sizes of nonmetallic pipe may be used:

- Polyvinyl Chloride (CPVC) Pipe** — Nom 1 in. (25 mm) diam (or smaller) Schedule 40 solid core PVC pipe.
- Chlorinated Polyvinyl Chloride (CPVC) Pipe** — Nom 1 in. (25 mm) diam (or smaller) SDR 13.5 CPVC pipe.

D. Cable — Two 8/C No. 12 AWG (or smaller) thermostat cables with polyvinyl chloride (PVC) insulation and jacket materials.

- Firestop System** — The firestop system shall consist of the following items:

A. Packing Material — Min 3-1/2 in. (89 mm) thickness of min 4 pcf (64 kg/m³) mineral wool batt insulation tightly packed into opening. Packing material to be installed flush with top surface of floor and recessed from bottom surface of floor to accommodate the required thickness of fill material. In walls, packing material to be recessed from both surfaces of wall to accommodate the required thickness of fill material.

A1. Forming Material* — As an alternate to the packing material in Item 3A, nom 3-1/2 in. (89 mm) wide strips of min 1/2 in. (13 mm) thick compressible mat to be stacked to a thickness greater than the width of the annular space and compression-fitted, edge-first, to fill the annular space to a min 3-1/2 in. (89 mm) depth. Forming material to be recessed from bottom surface of floor or from both surfaces of wall to accommodate the required thickness of fill material.

3M COMPANY 3M FIRE PROTECTION PRODUCTS — Fire Barrier Packing Material

System No. C-AJ-8251 *continued*

B. Fill, Void or Cavity Materials* — Min 1 in. (25 mm) thickness of fill material applied within the annulus, flush with bottom surface of floor or with both surfaces of wall.

3M COMPANY 3M FIRE PROTECTION PRODUCTS — IC 15WB+ Sealant, CP 25WB+ Sealant or FB 3000 WT Sealant. CP 25WB+ not suitable for use with CPVC pipes

* Indicates such products shall bear the UL or cUL Certification Mark for jurisdictions employing the UL or cUL Certification (such as Canada), respectively.



Through Penetrations

Combos

8000 Series

Concrete

CAJ

System No. C-AJ-8255

June 09, 2016

| ANSI/UL1479 (ASTM E814) | CAN/ULC S115 |
|---|---|
| F Rating — 2 Hr | F Rating — 2 Hr |
| T Ratings — 1/4 and 1/2 Hr (See Item 2A) | FT Ratings — 1/4 and 1/2 Hr (See Item 2A) |
| L Rating At Ambient — Less Than 1 CFM/sq ft | FH Rating — 2 Hr |
| L Rating At 400 F — Less Than 1 CFM/sq ft | FTH Ratings — 1/4 and 1/2 Hr (See Item 2A) |
| | L Rating At Ambient — Less Than 1 CFM/sq ft |
| | L Rating At 400 F — Less Than 1 CFM/sq ft |

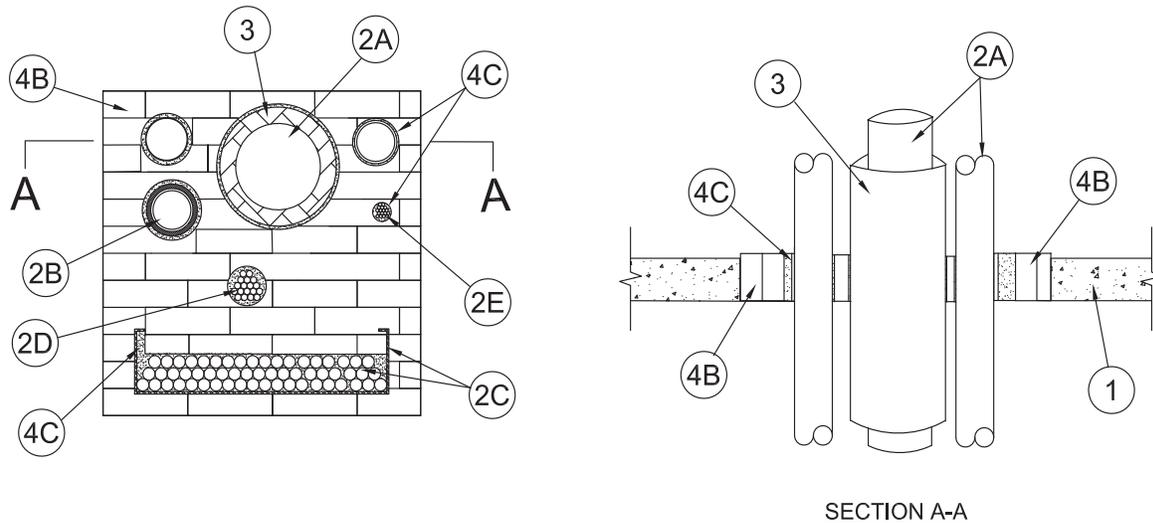

System tested with a pressure differential of 2.5 Pa between the exposed and the unexposed surfaces with the higher pressure on the exposed side.

- Floor or Wall Assembly** — Min 4-1/2 in. (114 mm) thick reinforced lightweight or normal weight (100-150 pcf or 1600-2400 kg/m³) concrete floor. Min 5 in. (127 mm) thick reinforced lightweight or normal weight (100-150 pcf or 1600-2400 kg/m³) concrete wall. Wall may also be constructed of any UL Classified **Concrete Blocks***. Max size of opening is 900 in.² (5806 cm²) with a max dimension of 30 in. (762 mm).

See **Concrete Blocks (CAZT)** category in the Fire Resistance Directory for names of manufacturers.

- Through Penetrants** — One cable tray and one or more pipes, tubes or cable bundles may be installed within the opening. The total number of through-penetrants is dependent on the size of the opening and the types and sizes of the penetrants. Any combination of the penetrants described below may be used provided that the following parameters relative to the annular spaces are maintained. The annular space between penetrants shall be min 3/4 in. (19 mm) to max 9-1/2 in. (241 mm) except for the following: the annular space between cable tray and cable bundle and all other penetrants shall be min 3 in. (76 mm); the annular space between metallic penetrants and insulated penetrants shall be a min 2 in. (51 mm); the annular space between metallic penetrants and non-metallic penetrants (Item 2B) shall be a min 2 in. (51 mm) and the annular space between nonmetallic penetrants shall be min 4 in. (102 mm). The annular space between penetrants and the periphery of opening shall be min 3/4 in. (19 mm) to max 14 in. (356 mm). Penetrants to be rigidly supported on both sides of floor or wall assembly. The following types and sizes of penetrants may be used.

A. Metallic Penetrants — One or more metallic pipe, conduit or tubing may be installed within the opening. The following types and sizes of metallic pipes, conduits or tubing may be used:

- Steel Pipe** — Nom 8 in. (203 mm) diam (or smaller) Schedule 40 (or heavier) steel pipe.
- Iron Pipe** — Nom 8 in. (203 mm) diam (or smaller) cast or ductile iron pipe.
- Conduit** — Nom 4 in. (102 mm) diam (or smaller) steel electrical metallic tubing or nom 6 in. (152 mm) diam (or smaller) steel conduit.
- Copper Tubing** — Nom 4 in. (102 mm) diam (or smaller) Type L (or heavier) copper tubing.
- Copper Pipe** — Nom 4 in. (102 mm) diam (or smaller) Regular (or heavier) copper pipe.

The hourly T, FT and FTH Rating is 1/2 hr except that when copper pipe/tube (Items 2A, 4 and/or 5) is used, the hourly T, FT and FTH Rating is 1/4 hr.

B. Nonmetallic Pipe — One or more nonmetallic pipes may be installed within the firestop system. The following types and sizes of nonmetallic pipes, conduits or tubing may be used:

- Polyvinyl Chloride (PVC) Pipe** — Nom 4 in. (102 mm) diam (or smaller) solid core Schedule 40 PVC pipe for use in closed (process or supply) or vented (drain, waste or vent) piping systems.
- Chlorinated Polyvinyl Chloride (CPVC) Pipe** — Nom 4 in. (102 mm) diam (or smaller) SDR 13.5 CPVC pipe for use in closed (process or supply) piping systems.

C. Cable Tray* — Max 24 in. (610 mm) wide by 6 in. (152 mm) deep open-ladder steel or aluminum cable tray. Aggregate cross-sectional area of cable tray to be max 45 percent of the cross-sectional area of the cable tray based on a max 4 in. (102 mm) cable loading depth. Any combination of the types and sizes of cables described below may be used.

- Max 1/C, 750 kcmil (or smaller) copper conductor cable with cross-linked polyethylene (XLPE) insulation and polyvinyl chloride

Through Penetrations

Combos

8000 Series

Concrete

CAJ

System No. C-AJ-8255 *continued*

Through Penetrations

(PVC) jacket.

2. Max 7/C No. 12 AWG (or smaller) copper conductor power and control cables with cross-linked polyethylene (XLPE) insulation or polyvinyl chloride (PVC) jacket.
3. Max 3/C No. 2/0 AWG (or smaller) copper conductor SER cable with polyvinyl chloride (PVC) insulation and jacket.
4. Max 3/C No. 2/0 AWG (or smaller) copper conductor PVC jacketed aluminum clad or steel clad TECK 90 cable.
5. Max 300 pair (or smaller) No. 22 AWG copper conductor telephone cable with PVC insulation and jacket materials.
6. Max 110/125 fiber optic (F.O.) cable with PVC insulation and jacket.
7. Max 3/C (with ground) No. 14 AWG (or smaller) nonmetallic sheathed (Romex) cable with PVC insulation and jacket materials.
8. Max RG/U (or smaller) coaxial cable with fluorinated ethylene (FE) or PVC insulation and jacket material.
9. Max 4 pair No. 24 AWG (or smaller) copper conductor Cat 5e or Cat 6 telephone cable with PVC insulation and jacket materials.
10. **Through Penetrating Product*** — Any cables, **Armored Cable+** or **Metal Clad Cable+** currently Classified under the Through Penetrating Product category. See **Through Penetrating Product (XHLY)** category in the Fire Resistance Directory for names of manufacturers.

11. Max three conductor No. 12 AWG (or smaller) MC (BX) copper cable with polyvinyl chloride insulation and jacket materials.

D. **Cable Bundle** — Max 3 in. (76 mm) diam tightly bundled cables may be installed within the opening. Any combination of the types and sizes of cables listed in Item 2C may be used.

E. **Cable Bundle** — Max 1-1/2 in. (38 mm) diam tightly bundled 110/125 fiber optic (F.O.) cables (with PVC insulation and jacket) may be installed within the opening.

3. **Pipe Covering Material*** — **Fiberglass Insulation** — (Optional) — May be installed on metallic penetrant Items 2A1 and 2A2. Nom 1-1/2 in. (38 mm) thick hollow cylindrical heavy density (min 3.5 pcf) glass fiber units jacketed on the outside with an all service jacket. Longitudinal joints sealed with metal fasteners or factory-applied self-sealing lap tape. Transverse joints secured with metal fasteners or with butt tape supplied with the product.

See **Pipe and Equipment Covering — Materials (BRGU)** category in the Building Materials Directory for names of manufacturers. Any pipe covering material meeting the above specifications and bearing the UL Classification Marking with a Flame Spread Index of 25 or less and a Smoke Developed Index of 50 or less may be used.

4. **Firestop System** — The firestop system shall consist of the following:

A. **Fill, Void or Cavity Materials*** — **Wrap Strip** — (Not Shown) — Used with each Item 2B nonmetallic penetrant. Min 3/16 in. (5 mm) thick intumescent material supplied in 2-1/2 in. (64 mm) wide strips. Single layer of wrap strip, pre-cut to fit penetrant OD, tightly wrapped around nonmetallic pipe and secured with the adhesive closure tab. Wrap strip to be installed within the opening such that the edge of the wrap strip layer is flush with bottom surface of floor. For wall assemblies, wrap strip is to be installed on both sides of wall and installed in the wall such that the wrap strip is flush with both surfaces of wall.

3M COMPANY 3M FIRE PROTECTION PRODUCTS — Tuck-In Wrap Strip WS 200, WS 300 or WS 400

B. **Fill, Void or Cavity Material*** — Blocks installed with 5 in. (127 mm) dimension projecting through opening flush with bottom surface of floor or centered in wall. In solid concrete floors or walls thicker than 5 in. (127 mm), the fire block can be installed flush with top or bottom surface of floor or flush with one side of wall. In concrete block walls, fire block to fill the entire thickness of wall opening unless concrete block is solid filled. Blocks to be firmly packed to fill the opening area between and around all penetrants. Blocks can be cut to fit around penetrants and within smaller annular spaces.

3M COMPANY 3M FIRE PROTECTION PRODUCTS — 3M™ Fire Barrier Block B258, 3M™ Fire Barrier Plank PK39

C. **Fill, Void or Cavity Materials*** — **Foam** — Fill material to be forced between blocks and periphery of opening to the max extent possible. Fill material to be injected in-between blocks and penetrants to the full depth of the blocks, as well as in any visible voids/openings between blocks (Item 4B). In addition, foam shall be injected to the maximum extent possible within the interstices between all cables in the cable tray and cable bundles.

3M COMPANY 3M FIRE PROTECTION PRODUCTS — Fire Barrier Rated Foam, FIP 1-Step

* Indicates such products shall bear the UL or cUL Certification Mark for jurisdictions employing the UL or cUL Certification (such as Canada), respectively.

+ Bearing the UL Recognized Component Marking



Combos

8000 Series

Concrete

CAJ



UL System No. C-AJ-8275
XHEZ – Through-penetration Firestop Systems
XHEZ7 – Through-penetration Firestop Systems Certified for Canada

June 29, 2017

| ANSI/UL1479 (ASTM E814) | CAN/ULC S115 |
|-------------------------|-------------------|
| F Rating – 2 Hr | F Rating – 2 Hr |
| T Rating – 0 Hr | FT Rating – 0 Hr |
| | FH Rating – 2 Hr |
| | FTH Rating – 0 Hr |

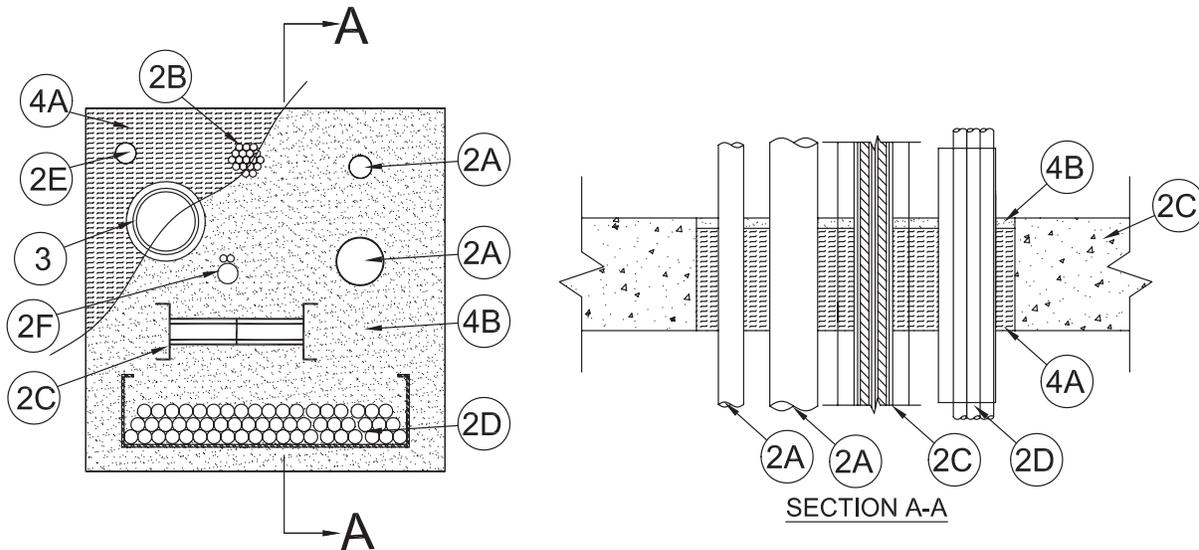

1. Floor or Wall Assembly – Min 4-1/2 in. (114 mm) thick reinforced lightweight or normal weight (100-150 pcf or 1600-2400 kg/m³) concrete floor. Min 5 in. (127 mm) thick reinforced lightweight or normal weight (100-150 pcf or 1600-2400 kg/m³) concrete wall. Wall may also be constructed of any UL Classified solid core Concrete Blocks*. Max size of opening is 1024 in.² (0.66 m²) with a max dimension of 32 in. (813 mm).

See **Concrete Blocks** (CAZT) in the Fire Resistance Directory for names of manufacturers.

2. Through-Penetrant – The total number of through-penetrants installed in the opening is dependent on the size of the opening and the types and sizes of the penetrants. Any combination of the penetrants described below may be used provided that the parameters specified are maintained. The annular space between all penetrants and the periphery of opening shall be min 0 in. (point contact) unless otherwise noted below for the specific penetrants. A max annular space in the system shall be 17-1/2 in. (445 mm) for FB-3000WT sealant and 12 in. (305 mm) for CP 25WB+ sealant. Penetrants to be rigidly supported on both sides of floor or wall assembly. The following types and sizes of penetrants may be used.

A. Metallic Pipes – The following types of metallic pipes, tubes or conduits may be used. The annular space between metallic pipes, conduit and tubes and insulated pipes and tubes shall be a min 2 in. (51 mm). The annular space between nom 3 in (76 mm) diam (and smaller) copper pipes and tubes and between nom 4 in (102 mm) diam (and smaller) steel and iron pipes and conduits shall be min 1/2 in. (13 mm). The annular space between nom 2 in. (51 mm) diam (and smaller) metallic pipes and conduits shall be min 0 in. (point contact).

- 1. Copper Tubing** – Nom 6 in. (152 mm) diam (or smaller) Type L (or heavier) copper tube.
- 2. Copper Pipe** – Nom 6 in. (152 mm) diam (or smaller) Regular (or heavier) copper pipe.
- 3. Steel Pipe** – Nom 24 in. (610 mm) diam (or smaller) Schedule 40 (or heavier) steel pipe and nom 12 in. (305 mm) diam (or smaller) Schedule 10 (or heavier) steel pipe.
- 4. Iron Pipe** – Nom 24 in. (610 mm) diam (or smaller) cast or ductile iron pipe.
- 5. Conduit** – Nom 4 in. (102 mm) diam (or smaller) electric metallic tubing (EMT) or nom 6 in. (152 mm) diam (or smaller) rigid steel conduit.

- B. Cables Bundles** – Max 4 in. (102 mm) diam tightly bundled cables. The annular space between cable bundles and other penetrants shall be a min 1/2 in. (13 mm) except that a min 2 in. (51 mm) shall be maintained between the cables and copper pipes and tubes greater than a nom 3 in. (76 mm) diam and steel and iron pipes and conduits greater than a nom 4 in. (102 mm) diam. Any combination of the following types and sizes of cables may be used:
1. Max 1000 kcmil single copper or aluminum conductor power cable with thermoplastic insulation and polyvinyl chloride (PVC) jacket.
 2. Max 300 pair No. 24 AWG copper conductor telecommunication cables with PVC insulation and jacket material.
 3. Max 7/C copper conductor No. 12 AWG multi-conductor power and control cables with PVC or cross-linked polyethylene (XLPE) insulation and PVC jacket.
 4. Multiple fiber optical communication cables jacketed with PVC and having a max outside diameter of 1/2 in.
 5. Max 3/C No. - 12 AWG steel clad cable with copper conductors and PVC insulation material.
 6. Max RG/U coaxial cables with fluorinated ethylene jacket and insulation.
 7. Max 4/C with ground No. 2/O AWG Metal-Clad Cable+.
- C. Busway+** – Nom 23 in. (584 mm) wide by 4.5 in. (114 mm) deep (or smaller) "I" shaped aluminum and steel enclosure containing factory mounted copper bars rated for 600 V, 5000A or aluminum bars rated 600V, 4000A. A maximum of one busway to be installed within the opening. The annular space between the busway and the periphery of the opening shall be min 2 in. (51 mm). Busway spaced min 6 in. (152 mm) from all other penetrants. Busway to be rigidly supported on both sides of wall assembly. The busway shall bear the UL Listing Mark and shall be installed in accordance with the National Electrical Code, NFPA 70. When Busway installed within opening, the FB-3000WT sealant (Item 4B) shall be used.
- D. Cable Tray*** – Max 24 in. (610 mm) wide by 6 in. (152 mm) deep open-ladder steel or aluminum cable tray. A maximum of two cable trays may be installed within the opening. Aggregate cross-sectional area of cables in cable tray to be max 40 percent of the cross-sectional area of the cable tray based on a max 3 in. cable loading depth. The annular space between cable trays shall be a min of 4 in. (102 mm). The annular space between cable tray and all other penetrants shall be min 3 in. (76 mm). Any combination of the types and sizes of cables described in Item 2B may be used. Cable tray to be rigidly supported on both sides of floor or wall assembly.
- E. Nonmetallic Penetrants *** – One or more nonmetallic pipes, conduits or tubes may be installed within the opening. Annulus between penetrants and periphery of opening is min 2 in. (51 mm). Separation between nonmetallic penetrants is min 4 in. (102 mm). Separation between nonmetallic penetrants and other types of penetrants is min 6 in. (152 mm). Penetrants rigidly supported on both sides of floor or wall assembly. The following types and sizes of nonmetallic pipes, conduits or tubing may be used:
- E1. Polyvinyl Chloride (PVC) Pipe** – Nom 2 in. (51 mm) diam (or smaller) solid or cellular core Schedule 40 PVC pipe for use in closed (process or supply) or vented (drain, waste or vent) piping systems.
 - E2. Chlorinated Polyvinyl Chloride (CPVC) Pipe** – Nom 2 in. (51 mm) diam (or smaller) solid or cellular core Schedule 40 PVC pipe for use in closed (process or supply) or vented (drain, waste or vent) piping systems.
 - E3. Rigid Nonmetallic Conduit+** – Nom 2 in. (51 mm) diam (or smaller) Schedule 40 PVC conduit installed in accordance with the National Electrical Code (NFPA 70).
 - E4. Electrical Nonmetallic Tubing (ENT)+** – Nom 1 in. (25 mm) diam (or smaller) corrugated wall ENT formed of polyvinyl chloride (PVC) installed in accordance with the National Electrical Code (NFPA 70).
- F. Air Conditioning (AC) Line Set *** – One or more AC line sets installed within opening. Each AC line set consists of two pipes or tubes, tubing insulation and a thermostat cable as specified below. The space between the AC line sets shall be min 2 in. (51 mm). The AC line sets shall be spaced min 6 in. from uninsulated metallic penetrants. The AC line set penetrants shall be tightly bundled shall be rigidly supported on both sides of the floor or wall assembly.
- F1. Metallic Pipe** – One of the pipes may exceed nom 1/2 in. (13 mm) in diam. The following types and sizes of metallic pipe may be used:
 - a. Copper Pipe** – Nom 1 in. (25 mm) diam (or smaller) Regular (or heavier) copper pipe.
 - b. Copper Tube** – Nom 1 in. (25 mm) diam (or smaller) Type L (or heavier) copper tube.
 - F2. Tube Insulation — Plastics#** – Nom 1/2 in. (13 mm) thick acrylonitrile butadiene/polyvinyl chloride (AB/PVC) flexible foam furnished in the form of tubing. The tube insulation shall be installed on one 1 in. (25 mm) diam (or smaller) pipe or tube in each single AC line set.
See **Plastics** (QMFZ2) category in the Plastics Recognized Component Directory for names of manufacturers. Any Recognized Component tube insulation meeting the above specifications and having a UL 94 Flammability Classification of 945VA may be used.
 - F3. Cable** – Max 4 pair No. 18 AWG (or smaller) thermostat cable with polyvinyl chloride (PVC) insulation and jacket materials.
- G. Steel Duct *** – (Not Shown) Nom 12 in. (305 mm) diameter (or smaller) No. 24 GA (or heavier) steel duct installed within opening when opening contains no cables or cable tray. A max of two steel ducts may be installed within the through-opening. Ducts to be spaced min 4 in. (102 mm) apart and min 8 in. (203 mm) from insulated penetrants and nonmetallic penetrants. Steel ducts to be rigidly supported on both sides of floor or wall assembly.

3. **Pipe Insulation** – (Optional) – Pipes and tubes of the sizes noted below may be provided with one of the following types of pipe insulations:

A. Pipe Covering* – Nom 1-1/2 in. (38 mm) thick (or thinner) hollow cylindrical heavy density glass fiber units jacketed on the outside with an all service jacket for steel and iron pipes with a nom diam of 8 in. (203 mm) (or smaller) or copper tubes and pipes with a nom diam of 4 in. (102 mm) (or smaller). Longitudinal joints sealed with metal fasteners or factory-applied self-sealing lap tape. Transverse joints secured with metal fasteners or with butt tape supplied with the product.

See **Pipe and Equipment Covering – Materials** (BRGU) category in the Building Materials Directory for names of manufacturers. Any pipe covering material meeting the above specifications and bearing the UL Classification Marking with a Flame Spread Index of 25 or less and a Smoke Developed Index of 50 or less may be used.

B. Pipe Covering* – Nom 2 in. (51 mm) thick (or thinner) hollow cylindrical heavy density glass fiber units jacketed on the outside with an all service jacket for pipes or tubes with a nom diam of 2 in. (51 mm) (or smaller). Longitudinal joints sealed with metal fasteners or factory-applied self-sealing lap tape. Transverse joints secured with metal fasteners or with butt tape supplied with the product.

See **Pipe and Equipment Covering – Materials** (BRGU) category in the Building Materials Directory for names of manufacturers. Any pipe covering material meeting the above specifications and bearing the UL Classification Marking with a Flame Spread Index of 25 or less and a Smoke Developed Index of 50 or less may be used.

C. Tube Insulation-Plastics+ – Nom 1 in. (25 mm) thick (or thinner) acrylonitrile butadiene/polyvinyl chloride (AB/PVC) flexible foam furnished in the form of tubing for pipes or tubes with a nom diam of 2 in. (51 mm) (or smaller).

See **Plastics** (QMFZ2) category in the Plastics Recognized Component Directory for names of manufacturers. Any Recognized Component tube insulation material meeting the above specifications and having a UL 94 Flammability Classification of 94-5VA may be used.

4. **Firestop System** – The firestop system shall consist of the following:

A. Packing Materials – Min 4 in. (102 mm) thickness of 4 pcf (64 kg/m³) mineral wool batt insulation tightly packed into the opening as a permanent form. Packing material to be recessed from top surface of floor or both surfaces of wall to accommodate the required thickness of fill material.

B. Fill, Void or Cavity Material - Sealant* – Min 1/2 in. (13 mm) thickness of fill material applied within the annulus flush with the top surface of the floor or both surfaces of the wall. Additional fill material forced into interstices of grouped cables and grouped cables within cable trays, and to fill any voids evident in the firestop system. When Busway (Item 2C) is installed within opening, the FB-3000WT sealant shall be used.

3M COMPANY – CP 25 WB+ or FB-3000 WT



*Indicates such products shall bear the UL or cUL Certification Mark for jurisdictions employing the UL or cUL Certification (such as Canada), respectively.

Reprinted from the Online Certifications Directory with permission from UL©

System No. C-BJ-8004

May 18, 2005

F Ratings – 2 and 4 Hr (See Item 4)

T Ratings – 0, 3/4, 1, 1-1/2 and 2 Hr (See Items 2, 3, 4 and 8)

L Rating At Ambient – 76 CFM/sq ft

L Rating At 400 F – 7 CFM/sq ft

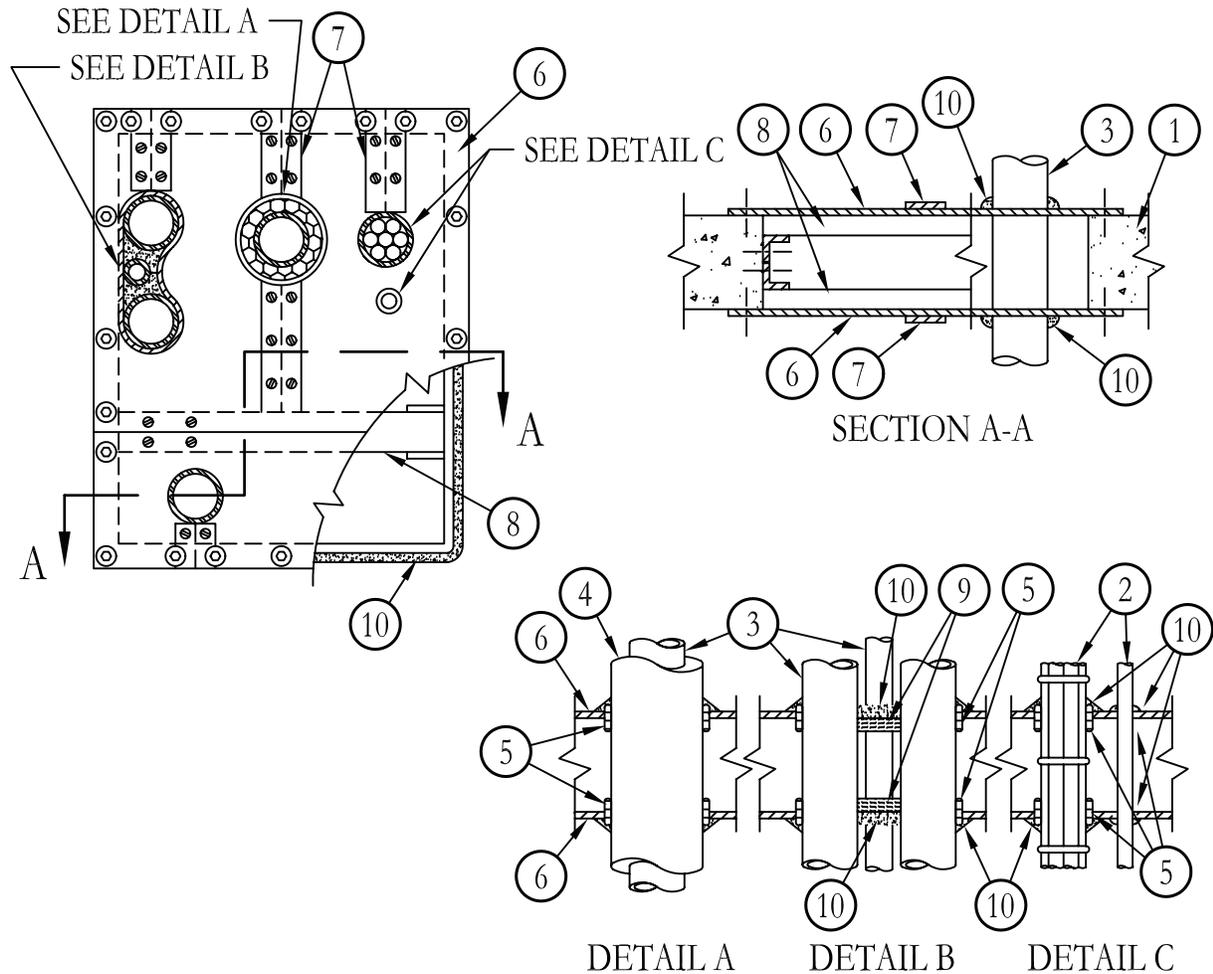

- Floor or Wall Assembly** – Min 5-1/2 in. (140 mm) thick lightweight or normal weight (100-150 pcf or 1600-2400 kg/m³) concrete. Wall may also be constructed of any UL Classified **Concrete Blocks***. Max area of opening 1500 sq in. (9677 cm²) with max dimension of 50 in. (1270 mm).

See **Concrete Blocks** (CAZT) category in the Fire Resistance Directory for names of manufacturers.

- Cables** – Individual cable or tightly-bound circular bundle of cables having a max bundle diam of 3 in. (76 mm). Min spacing between individual cables and/or cable bundles or between cables and pipe (Item 3) is 6 in. (152 mm). Cable rigidly supported on both sides of floor or wall assembly. The following types and sizes of copper conductor cables may be used:
 - Max 100 pair No. 24 AWG telephone cable; polyvinyl chloride (PVC) insulation and jacket materials. **When max 100 pr telephone cable is used, T Rating is 1-1/2 hr.**
 - Max 25 pr No. 24 AWG telephone cable; PVC insulation and jacket materials. **When max 25 pr telephone cable is used, T Rating is 2 hr.**
 - Max No. 12 AWG multi conductor power and control cable; PVC or cross-linked polyethylene insulation, PVC jacket. **When max No. 12 AWG multi conductor cable is used, T Rating is 2 hr.**

When an individual cable of the types listed above is installed in a max 1 in. (25 mm) diam through opening in the intumescent sheets (Item 6) and when only caulk fill material (Item 10) is used around the base of the cable at its egress from the intumescent sheet, the T Rating is 1 hr.

- Pipe or Conduit** – Nom 12 in. (305 mm) diam (or smaller) Schedule 10 (or heavier) steel pipe, nom 6 in. (152 mm) diam (or smaller) steel conduit, nom 4 in. (102 mm) diam (or smaller) steel EMT or nom 4 in. (102 mm) diam (or smaller) Type L (or heavier) copper pipe. Pipe, conduit or EMT rigidly supported on both sides of floor or wall assembly. **When max 4 in. (102 mm) diam steel pipe, conduit or EMT is used, T Rating is 3/4 hr. When max 2 in. (51 mm) diam steel pipe, conduit or EMT is used, T Rating is 1-1/2 hr. When copper pipe is used or when steel pipe or conduit larger than 4 in. (102 mm) is used, T Rating is 0 hr.**

System No. C-BJ-8004 *continued*

Through Penetrations

Combos

8000 Series

Concrete

CBJ

- Pipe covering** (Optional) – Nom 1 in. or 2 in. (25 mm or 51 mm) thick hollow cylindrical heavy density (min 3.5 pcf or 56 kg/m³) glass fiber units jacketed on the outside with an all service jacket. Longitudinal joints sealed with metal fasteners or factory-applied self-sealing lap tape. Transverse joints secured with metal fasteners or with butt strip tape supplied with the product. **When nom 1 in. (25 mm) thick pipe covering is used on max 12 in. (305 mm) diam steel pipe, T Rating is 3/4 hr. When nom 1 in. (25 mm) thick pipe covering is used on max 4 in. (102 mm) diam steel pipe, T Rating is 1-1/2 hr. When nom 1 in. (25 mm) thick pipe covering is used on max. 4 in. (102 mm) diam copper pipe, T rating is 1 hr. When nom 2 in. (51 mm) thick pipe covering is used, F Rating is 2 hr and T Rating is 1 hr.**

See **Pipe and Equipment Covering – Materials*** (BRGU) category in the Building Materials Directory for names of manufacturers. Any pipe covering material meeting the above specifications and bearing the UL Classification Marking with a Flame Spread Index of 25 or less and a Smoke Developed Index of 50 or less may be used.

- Fill, Void or Cavity Materials* – Wrap Strip** – Nom 1/4 in. (6 mm) thick intumescent elastomeric material faced on one side with aluminum foil, supplied in nom 2 in. (51 mm) wide by 24 in. (610 mm) long strips. Single layer of wrap strip tightly-wrapped around each cable bundle, each copper pipe, each steel pipe or conduit larger than 4 in. (102 mm) diam and each pipe with nom 1 in. (25 mm) thick pipe covering material. Two layers of wrap strip required on each pipe with nom 2 in. (51 mm) thick pipe covering material. Wrap strip layer(s) installed with foil side exposed and secured in place with steel wire ties. When tight grouping of steel pipes, conduits or EMT does not readily permit tight installation of the intumescent sheet (Item 6) around the individual pipes, conduits or EMT, the grouping of steel pipes conduits or EMT shall be wrapped with a single piece of wrap strip drawn in between the individual pipes using steel wires so as to follow the contours of the pipe grouping as tightly as possible. Wrap strip to extend approx 7/8 in. (22 mm) beyond each face of the intumescent sheet (Item 6) on both sides of the floor or wall assembly. Wrap strip layer not required on individual nom 4 in. (102 mm) diam (or smaller) steel pipe, conduit or EMT.

3M COMPANY – FS-195+

- Fill, Void or Cavity Materials* – Intumescent Sheet** – Rigid aluminum foil-faced sheet with galv steel sheet backer. Sheet cut to tightly follow the contours of the individual pipes, conduits and EMT and the contours of the wrap strip (Item 5) on the cable bundles, pipes, insulated pipes and grouped pipes, conduits and EMT. Sheets to lap a min of 2 in. (51 mm) on the floor or wall surface on all sides of the opening on both sides of the floor or wall assembly. Sheet to be installed with the galv steel sheet backer exposed (aluminum foil facing against floor or wall surface) and secured to floor or wall surface with min 3/16 in. diam by 1-1/4 in. (5 mm by 32 mm) long steel masonry fasteners with min 1-1/4 in. (32 mm) diam steel washers. Max spacing of fasteners not to exceed 6 in. (152 mm) with additional fasteners located on each side of butted seams or slits made to permit installation of the sheet around the individual penetrating items.

3M COMPANY – CS-195+

- Steel Cover Strip** – Min 2 in. (51 mm) wide strip of min 0.020 in. (0.51 mm) thick (No. 26 ga) galv steel centered over butted seams of adjoining intumescent sheets and over entire length of each slit made in intumescent sheet (Item 6) to permit installation about the penetrating items(s). Prior to installation of the steel strip, the seam of slit in the intumescent sheet shall be covered with a nom 1/4 in. (6 mm) diam bead of caulk (Item 10). Steel cover strip secured to galv steel sheet backer of intumescent sheet with steel sheet metal screws or steel rivets spaced max 3 in. (76 mm) OC on each side of seam or slit.
- Support Channel** – When area of through opening exceeds 750 sq in. (4838 cm²), an intermediate support channel shall be installed on each side of floor or wall assembly, flush with floor or wall surface. Support channels to be min 1-5/8 in. by 1-5/8 in. (41 mm by 41 mm) and formed of min 0.093 in. (2.4 mm) thick (No. 12 ga) painted or galv steel. Ends of steel channel bolted or welded to steel angles anchored to inside walls of through opening. When steel support channels are centered beneath butted seams of intumescent sheets, no steel cover strip (Item 7), is required over butted seam. Intumescent sheets secured to steel support channels with steel sheet metal screws in conjunction with min 1-1/4 in. (32 mm) diam steel fender washers. When support channel is used beneath butted seam of intumescent sheets, fasteners spaced max 3 in. (76 mm) OC on each side of butted seam. When support channel is located away from intumescent sheet seam, fasteners spaced max 6 in. (152 mm) OC. Prior to installation of the intumescent sheet(s), a nom 1/4 in. (6 mm) diam continuous bead of caulk (Item 10) shall be applied as a gasket over the steel support channel. **When steel support channels are used, T Rating is 1-1/2 hr.**
- Packing Material** – When tightly-grouped steel pipes, conduits or EMT are encircled with a contoured wrap of wrap strip (Item 5), the interstices between the pipes within the wrap strip shall be firmly packed with a nom 1 in. (25 mm) thickness of mineral wool batt insulation. Packing material to be recessed 1 in. (25 mm) from edge of wrap strip on each side of floor or wall assembly.
- Fill, Void or Cavity Materials* – Caulk or Sealant** – Generous application of caulk to be applied around the base of the individual cables, pipes, conduits, EMT and contour applied wrap strips at their egress from the intumescent sheet on both sides of the floor or wall assembly. An additional bead of caulk shall be applied to the exposed edges of the wrap strip at its interface with the grouped pipes, insulated steel pipe and cable bundle on both sides of floor or wall assembly. An additional 1/4 in. (6 mm) diam bead of caulk shall be applied to edge of intumescent sheet at its interface with floor or wall surface around entire perimeter. When tightly-grouped steel pipes, conduits, or EMT are encircled with a contoured wrap of wrap strip (Item 5), a min 1 in. (25 mm) thickness of caulk shall be applied over the packing material (Item 9) to completely fill the cavity within the wrap strip on each side of the floor or wall assembly.

3M COMPANY– CP 25WB+, IC 15WB+ caulk or FB-3000 WT sealant.

*Bearing the UL Classification Mark

Reprinted from the Online Certifications Directory with permission from Underwriters Laboratories Inc.
Copyright © 2010 Underwriters Laboratories Inc.®



System No. C-BJ-8005

May 18, 2005

F Rating – 4 Hr

T Ratings – 3/4, 1 and 1-1/2 Hr (See Items 2, 3 and 6)

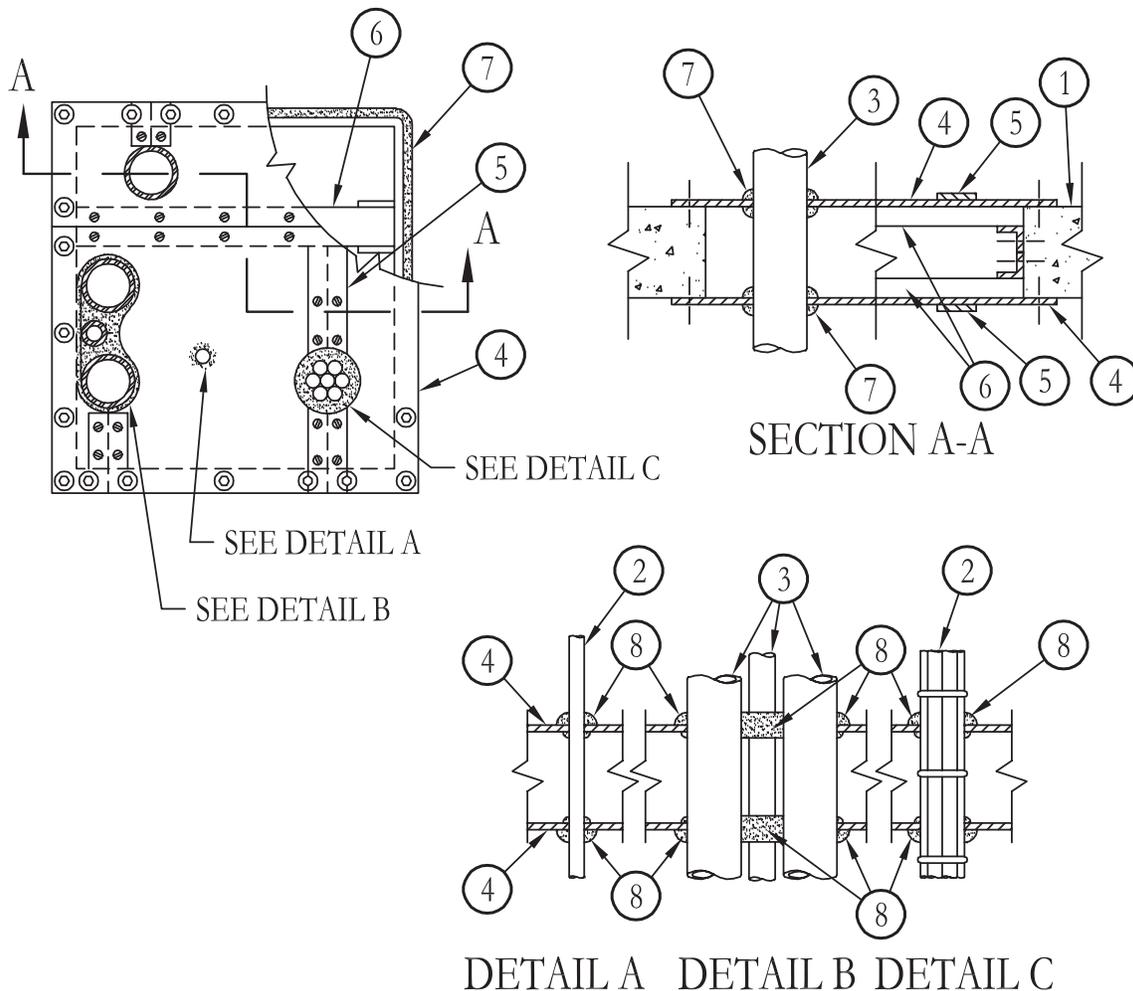

1. **Floor or Wall Assembly** – Min 8 in. (203 mm) thick normal weight (min 140 pcf or 2242 kg/m³) concrete. Wall may also be constructed of any UL Classified **Concrete Blocks***. Max area of opening 1500 sq in. (9677 cm²) with max dimension of 50 in. (1270 mm). See **Concrete Blocks** (CAZT) category in the Fire Resistance Directory for names of manufacturers.
2. **Cables** – Individual cables or tightly-bound circular bundle of cables having a max bundle diam of 3 in. (76 mm) Min spacing between individual cables and/or cable bundles or between cables and pipe (Item 3) is 6 in. (152 mm). Cables rigidly supported on both sides of floor or wall assembly. The following types and sizes of copper conductor cables may be used:
 - A. Max 100 pair No. 24 AWG telephone cable; polyvinyl chloride insulation and jacket materials. **When max 100 pair telephone cable is used, T Rating is 1 hr.**
 - B. Max 25 pair No. 24 AWG telephone cable; polyvinyl chloride insulation and jacket materials. **When max 25 pair telephone cable is used, T Rating is 1-1/2 hr.**
 - C. Max No. 12 AWG multi conductor power and control cables; polyvinyl chloride or cross-linked polyethylene insulation, polyvinyl chloride jacket. **When max No. 12 AWG multi conductor cable is used, T Rating is 1 hr.**

When an individual cable of the types listed above is installed in a max 1 in. (25 mm) diam through opening in the intumescent sheets (Item 4), the T Rating is 1-1/2 hr.
3. **Steel Pipe or Conduit** – Nom 4 in. (102 mm) diam (or smaller) Schedule 5S (or heavier) steel pipe, steel conduit or steel EMT. Pipe, conduit or EMT rigidly supported on both sides of floor or wall assembly. **When max 4 in. (102 mm) diam steel pipe, conduit or EMT is used, T Rating is 3/4 hr.). When max 2 in. (51 mm) diam steel pipe, conduit or EMT is used, T Rating is 1-1/2 hr.**
4. **Fill, Void or Cavity Materials*** – **Intumescent Sheet** – Rigid aluminum foil-faced sheet with galv steel sheet backer. Sheet cut to tightly follow the contours of individual pipes, conduits or EMT. For cable bundles and for tightly-grouped steel pipes, conduits and EMT, the intumescent sheet shall be cut to tightly follow the contours of the individual cable, cable bundle or pipe group but with a nom 1/4 in. to 3/8 in. (6 mm to 10 mm) wide annular space maintained between the penetrating item and the edges of the cutout in the intumescent sheet. Sheets to lap a min of 2 in. (51 mm) on the floor or wall surface on all sides of through opening on both sides of the floor or wall assembly. Sheet to be installed with the galv steel sheet backer exposed (aluminum foil facing against floor or wall surface) and secured to floor or wall surface with min 3/16 in. diam by 1-1/4 in. (10 mm to 32 mm) long steel masonry fasteners with min 1-1/4 in. (32 mm) diam steel washers. Max spacing of fasteners not to exceed 6 in. (152 mm) with additional fasteners located on each side of butted seams or slits made to permit installation of the sheet around individual penetrating items.

3M COMPANY – CS-195+

System No. C-BJ-8005 *continued*

Through Penetrations

Compos

8000 Series

Concrete

CBJ

5. **Steel Cover Strip** – Min 2 in. (51 mm) wide strip of min 0.020 in. (0.51 mm) thick galv steel centered over butted seams of adjoining intumescent sheets and over entire length of each slit made in intumescent sheet (Item 4) to permit installation about the penetrating item(s). Prior to installation of the steel strip, the seam or slit in the intumescent sheet shall be covered with a nom 1/4 in. (6 mm) diam bead of caulk (Item 7). Steel cover strip secured to galv steel sheet backer of intumescent sheet with steel sheet metal screws or steel rivets spaced max 3 in. (76 mm) O.C. on each side of seam or slit.
6. **Support Channel** – When area of through opening exceeds 750 sq in. (4838 cm²), an intermediate support channel shall be installed on each side of floor or wall assembly, flush with floor or wall surface. Support channels to be min 1-5/8 in. by 1-5/8 in. (41 mm by 41 mm) and formed of min 0.093 in. (2.4 mm) thick (No. 12 gauge) painted or galv steel. Ends of steel channel bolted or welded to steel angles anchored to inside walls of through opening. When steel support channels are centered beneath butted seams of intumescent sheets, no steel cover strip (Item 5) is required over butted seam. Intumescent sheets secured to steel support channels with steel sheet metal screws in conjunction with min 1-1/4 in. (32 mm) diam steel fender washers. When support channel is used beneath butted seam of intumescent sheets, fasteners spaced max 3 in. (76 mm) O.C. on each side of butted seam. When support channel is located away from intumescent sheet seam, fasteners spaced max 6 in. (152 mm) O.C. Prior to installation of the intumescent sheet(s), a nom 1/4 in. (6 mm) diam continuous bead of caulk (Item 7) shall be applied as a gasket over the support channel. **When support channel is used, T Rating is 1-1/2 hr.**
7. **Fill, Void or Cavity Material* – Caulk or Sealant** – Generous application of caulk to be applied around the base of the individual steel pipes, conduits or EMT at their egress from the intumescent sheet on both sides of the floor or wall assembly. An additional 1/4 in. (6 mm) diam bead of caulk shall be applied to edge of intumescent sheet at its interface with floor or wall surface around entire perimeter.
3M COMPANY– CP 25WB+, IC 15WB+ caulk or FB-3000 WT sealant.
8. **Fill, Void or Cavity Materials* – Putty** – Moldable putty material kneaded by hand and packed into nom 1/4 in. to 3/8 in. (6 mm to 10 mm) annular space between individual cable, cable bundle or pipe group and edges of cutout in intumescent sheet on both sides of floor or wall assembly. Putty material to be “domed” min 1 in. (25 mm) beyond intumescent sheet around perimeter of individual cable, cable bundle or pipe group on both sides of floor or wall assembly. Interstices between pipes in pipe group to be tightly-packed with a min 1-1/4 in. (32 mm) thickness of putty material on both sides of floor or wall assembly.
3M COMPANY – MP+ Stix

*Bearing the UL Classification Mark

Reprinted from the Online Certifications Directory with permission from Underwriters Laboratories Inc.
Copyright © 2010 Underwriters Laboratories Inc.®



System No. F-A-8001

September 07, 2004

(Formerly System No. 152)

F Rating – 2 Hr

T Rating – 0 Hr

L Rating At Ambient – 2 CFM/sq ft

L Rating At 400 F – Less Than 1 CFM/sq ft

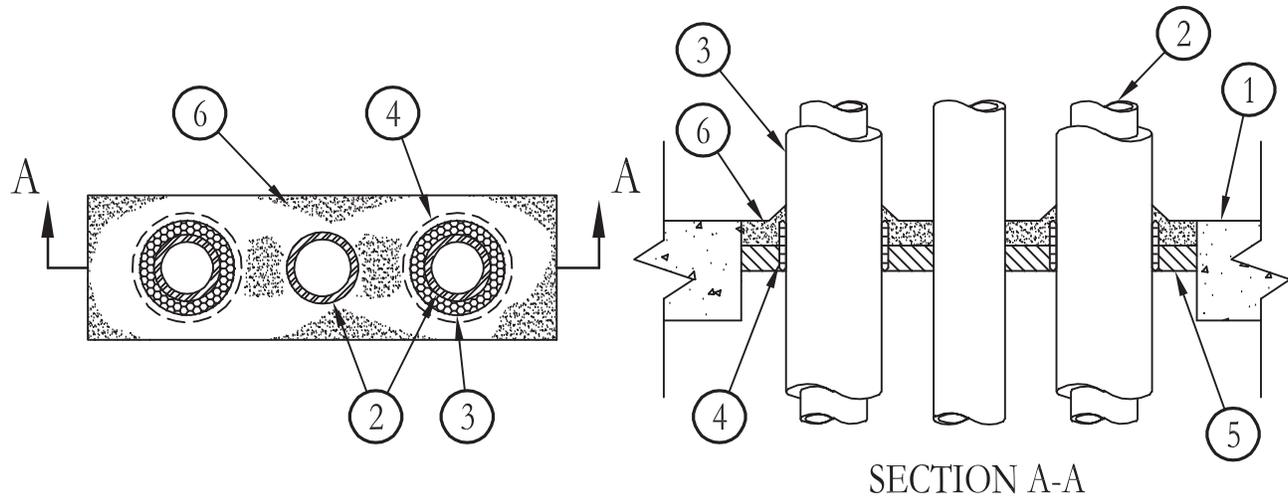

SECTION A-A

- Floor Assembly** – Min 4-1/2 in. thick lightweight or normal weight (100-150 pcf) concrete. Max area of opening 192 sq in. with max length of 24 in. and max width of 8 in.
- Pipe or Conduit** – Nom 4 in. diam (or smaller) Type L (or heavier) copper tubing, Schedule 10 (or heavier) steel pipe, steel conduit or steel EMT to be installed with a min clearance of 1 in. and a max clearance of 2 in. from the periphery of the opening. A min separation of 1 in. shall be maintained between adjacent pipes. When pipes, conduits or tubings are provided with pipe covering (Item 3) or pipe insulation (Item 3A), a min 1/4 in. clearance between pipe covering or insulation and the periphery of the opening shall be maintained. A min 1/2 in. separation shall be maintained between insulated pipes, conduits and tubings of nom 3 in. diam (or smaller). A min 1 in. clearance shall be maintained between insulated pipes, conduits or tubings of greater than nom 3 in. diam. A min 1 in. clearance shall be maintained between any insulated pipe, conduit or tubing and any uninsulated pipe, conduit or tubing. Pipes, conduits or tubing to be rigidly supported on both sides of floor assembly.
- Pipe Covering** (Optional) – Nom 1/2 in. to 1 in. thick hollow cylindrical heavy density glass fiber units jacketed on the outside with an all service jacket. Longitudinal joints sealed with metal fasteners or factory-applied self-sealing lap tape. Transverse joints secured with metal fasteners or with butt strip tape supplied with the product.

See **Pipe and Equipment Covering – Materials*** (BRGU) category in Building Materials Directory for names of manufacturers. Any pipe covering material meeting the above specifications and bearing the UL Classification Marking with a Flame Spread Index of 25 or less and a Smoke Development Index of 50 or less may be used.

- Pipe Insulation – Plastics** (Optional) – As an alternate to Item 3, nom 3/4 in. thick acrylonitrile butadiene/polyvinyl chloride (AB/PVC) flexible foam furnished in the form of tubing with skin may be used on steel pipes.

See **Plastics** (QMFZ2) category in the Recognized Component Directory for names of manufacturers. Any Recognized Component tube insulation material meeting the above specifications and having UL94 Flammability Classification of 94-5VA may be used.

- Fill, Void or Cavity Materials* – Wrap Strip** – Nom 1/4 in. thick intumescent elastomeric material faced on one side with aluminum foil, supplied in 2 in. wide strips. Nom 2 in. wide strip tightly-wrapped around pipe insulation (Item 3 or 3A) with the foil side exposed and slid into through opening such that the top edge is flush with the top surface of the floor. The wrap strip layer shall be secured in place with min No. 18 gauge galv steel tie wire. Wrap strip material is required only when pipe insulation is used.

3M COMPANY – FS-195+

- Packing Material** – Min 1 in. thick mineral wool batt material insulation firmly packed into opening as a permanent form with its top surface recessed min 1 in. from top surface of floor.
- Fill, Void or Cavity Materials* – Caulk or Sealant** – Applied to fill through opening to a min depth of 1 in., flush with top surface of floor, with a min 1/8 in. thickness of caulk applied over top edge of wrap strip layer (Item 4) on insulated pipe.

3M COMPANY – CP 25WB+ caulk or FB-3000 WT sealant.

*Bearing the UL Classification Marking

Reprinted from the Online Certifications Directory with permission from Underwriters Laboratories Inc.
Copyright © 2010 Underwriters Laboratories Inc.®



System No. F-A-8007

January 09, 2007

F Rating – 3 Hr

T Rating – 0 Hr

L Rating at Ambient – Less Than 1 CFM/sq ft (See Items 3 and 5A)

L Rating at 400° F – Less Than 1 CFM/sq ft (See Items 3 and 5A)

W Rating – Class 1 (See Items 3, 4B and 5A)

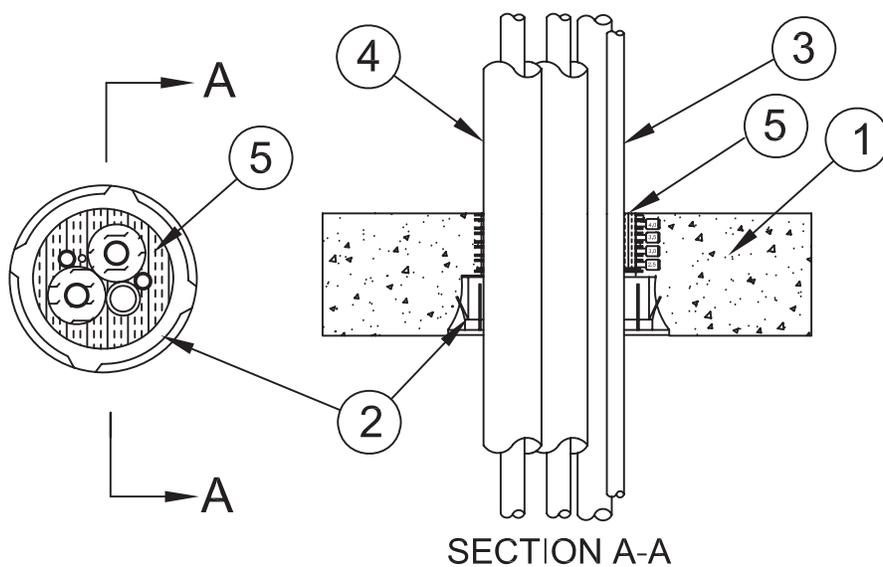

1. **Floor Assembly** – Min 4-1/2 in. (114 mm) thick reinforced lightweight or normal weight (100-150 pcf or 1600-2400 kg/m³) concrete.
2. **Firestop Device*** – Cast in place firestop device permanently embedded during concrete placement or grouted in concrete assembly in accordance with accompanying installation instructions. The device may be trimmed flush with top surface of floor or may project up to a max 3-1/2 in. (89 mm) above top surface of floor.
3M COMPANY – 3M Fire Barrier Cast-In Device 2MCID, 3MCID, 4MCID
- 2A. **Firestop Device – Height Adapter*** – (Not Shown) – For use in floors greater than 8 in. (203 mm) thick. Adapter snaps onto top of firestop device (Item 2).
3M COMPANY – 3M Fire Barrier Cast-In Device Height Adapter, 2HA, 3HA, 4HA
3. **Through Penetrants** – Pipes, tubing or cable to be bundled within the opening. A min 1/4 in. (6 mm) annular space shall be maintained between uninsulated metallic pipes and cable (Item 3C). The annular space between uninsulated metallic pipes and other penetrants shall be min 0 in. (0 mm, point contact) to max 2 in. (51 mm). The space between penetrants and periphery of opening shall be min 0 in. (0 mm, point contact) to max 2 in. (51 mm). **When W or L Ratings are required, the space between penetrants and the space between the penetrants and the inside of the firestop device (Item 2 or 2A) shall be min 1/4 in. (6 mm).** Penetrants to be rigidly supported on both sides of floor assembly. The following types and sizes of penetrants may be used:
 - A. **Metallic Pipes** – The following types and sizes of metallic pipes, conduits or tubing may be used:
 1. **Copper Tubing** – Nom 1 in. (25 mm) diam (or smaller) Type L (or heavier) copper tubing.
 2. **Copper Pipe** – Nom 1 in. diam (or smaller) Regular (or heavier) copper pipe. All pipes or tubing larger than nom 1/2 in. (25 mm) diam shall be provided with pipe covering (Item 4).
 - B. **Polyvinyl Chloride (PVC) Pipe** – A max of one PVC nom 1 in. (25 mm) diam (or smaller) Schedule 40 solid core PVC pipe for use in closed (process or supply) or vented (drain, waste or vent) piping system.
 - C. **Cables** – A max of two cable, max 8/C No. 18 AWG (or smaller) thermostat cable; XLPE or PVC insulation with XLPE or PVC jacket.
4. **Pipe Covering** – The following types and sizes of pipe coverings may be used with the metallic pipes:
 - A. **Pipe Covering** – Max 3/4 in. (19 mm) thick hollow cylindrical heavy density glass fiber units jacketed on the outside with an all service jacket. Longitudinal joints sealed with metal fasteners or factory-applied self-sealing lap tape. Transverse joints secured with metal fasteners or with butt tape supplied with product.
See **Pipe and Equipment Covering – Materials** (BRGU) category in the Building Materials Directory for names of manufacturers. Any pipe covering material meeting the above specifications and bearing the UL Classification Marking with a Flame Spread Index of 25 or less and a smoke Developed Index of 50 or less may be used.
 - B. **PVC Jacket++** – (Optional, Not Shown) – An additional PVC jacket, supplied in sheet form, shall be tightly wrapped around the all service jacket on the pipe covering (Item 4A) with the longitudinal seam continuously sealed using the self-sealing lap tape or adhesive supplied with the jacket. The jacket is to be nom 48 in. (1.22 m) wide by nom 20 or 30 mil (0.5 or 0.8 mm) thick. The jacket shall extend downward into and/or through the opening from a point 36 to 40 in. (0.91 to 1.02 m) above the top surface of the floor assembly. **The PVC jacket must be used for the W Rating to apply.**
See **Plastics** (QMFZ2) category in the Plastics Recognized Component Directory for names of manufacturers. Any Recognized Component plastic material meeting the above specifications and having a UL 94 Flammability Classification of 94-5VA may be used.

System No. F-A-8007 *continued*

- C. **Tube Insulation – Plastics+** – Max 3/4 in. (19 mm) thick acrylonitrile butadiene/polyvinyl chloride (AB/PVC) flexible foam furnished in the form of tubing.

See **Plastics** (QMFZ2) category in the Plastics Recognized Component Directory for names of manufacturers. Any Recognized Component tube insulation material meeting the above specifications and having a UL 94 Flammability Classification of 94-5A may be used.

5. **Packing Material** – Min 2 in. (51 mm) thickness of min 4 pcf (64 kg/m³) mineral wool batt insulation firmly packed within annulus, flush with the top surface of floor.
- 5A. **Fill, Void or Cavity Materials – Sealant, Caulk or Putty*** – (Optional, Not Shown) - As an option, the packing material (Item 5) may be reduced in thickness by 1/4 to 1/2 in. (6 to 13 mm) and recessed from the top surface of floor to accommodate a 1/4 to 1/2 in. (6 to 13 mm) thickness of sealant, caulk or putty, installed within annulus, flush with the top surface of floor. For W and L Ratings, a min 1/4 in. (6 mm) bead of sealant is required at the device/concrete interface on the top surface of the floor and a min 1/4 in. (6 mm) depth of sealant is required atop a min 1-3/4 in. (44 mm) thickness of mineral wool packing material inside the firestop device (Item 2 or 2A).

3M COMPANY – FB-1000 NS sealant, FB-1003 SL sealant, FB-3000 WT sealant, CP 25WB+ caulk, FireDam 150+ caulk, IC 15WB+ caulk or MP+ putty

(**Note:** W and L Ratings apply only when FB-1000 NS, FB-1003 SL or FB-3000 WT sealants are used.)

*Bearing the UL Classification Mark

++ - Bearing the UL Recognized Component Mark

Reprinted from the Online Certifications Directory with permission from Underwriters Laboratories Inc.
Copyright © 2010 Underwriters Laboratories Inc.®



Note: This system was tested with a pressure differential of 50 Pa between the exposed and unexposed surfaces with the higher pressure on the exposed side.

Through Penetrations

Compos

8000 Series

Concrete

FA

System No. F-A-8010

January 09, 2007

F Rating – 2 Hr

T Rating – 0 Hr

L Rating at Ambient – Less Than 1 CFM/sq ft (See Items 3 and 5A)

L Rating at 400° F – Less Than 1 CFM/sq ft (See Items 3 and 5A)

W Rating – Class 1 (See Items 3 and 5A)

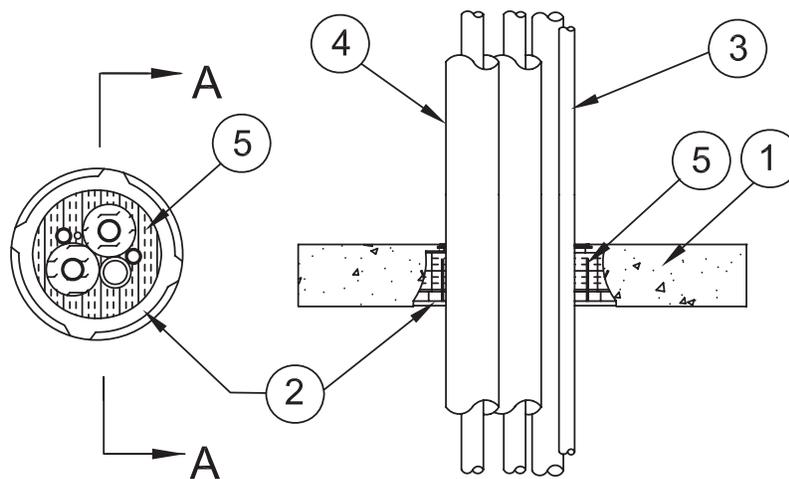

SECTION A-A

- Floor Assembly** – Min 2-1/2 in. (64 mm) thick reinforced lightweight or normal weight (100-150 pcf or 1600-2400 kg/m³) concrete.
- Firestop Device*** – Cast in place firestop device permanently embedded during concrete placement or grouted in concrete assembly in accordance with accompanying installation instructions. The device may be trimmed flush with top surface of floor or may project up to a max 3-1/2 in. (89 mm) above top surface of floor.
3M COMPANY – 3M Fire Barrier Cast-In Device 2PCID, 3PCID, 4PCID
- Through Penetrants** – Pipes, tubing or cable to be bundled within the opening. The annular space between penetrants shall be min 0 in. (0 mm, point contact) to max 1 in. (25 mm). The space between penetrants and periphery of opening shall be min 0 in. (0 mm, point contact) to max 1 in. (25 mm). **When W or L Ratings are required, the space between penetrants and the space between the penetrants and the inside of the firestop device shall be min 1/4 in. (6 mm).** Penetrants to be rigidly supported on both sides of floor assembly. The following types and sizes of penetrants may be used:
 - Metallic Pipes** – A max of four pipes or tubes installed within opening. The following types and sizes of metallic pipes, conduits or tubing may be used:
 - Copper Tubing** – Nom 1 in. (25 mm) diam (or smaller) Type L (or heavier) copper tubing.
 - Copper Pipe** – Nom 1 in. (25 mm) diam (or smaller) Regular (or heavier) copper pipe. All pipes or tubing larger than nom 1/2 in. (13 mm) diam shall be provided with pipe covering (Item 4).
 - Polyvinyl Chloride (PVC) Pipe** – A max of one nom 1 in. (25 mm) diam (or smaller) Schedule 40 solid core PVC pipe for use in closed (process or supply) or vented (drain, waste or vent) piping systems.
 - Cables** – A max of two, max 8/C No. 18 AWG (or smaller) thermostat cables; XLPE or PVC insulation with XLPE or PVC jacket.
- Tube Insulation – Plastics+** – Nom 1/2 in. (13 mm) thick (or less) acrylonitrile butadiene/polyvinyl chloride (AB/PVC) flexible foam furnished in the form of tubing.
See **Plastics** (QMFZ2) category in the Plastics Recognized Component Directory for names of manufacturers. Any Recognized Component tube insulation material meeting the above specifications and having a UL 94 Flammability Classification of 94-5A may be used.
- Packing Material** – Min 2 in. (51 mm) thick of min 4 pcf (64 kg/m³) mineral wool batt insulation firmly packed within annulus, flush with the top surface of floor.
- Fill, Void or Cavity Materials – Sealant, Caulk or Putty*** – (Optional, Not Shown) – As an option, the packing material (Item 5) may be reduced in thickness by 1/4 to 1/2 in. (6 to 13 mm) and recessed from the top surface of floor to accommodate a 1/4 to 1/2 in. (6 to 13 mm) thickness of sealant, caulk or putty, installed within annulus, flush with the top surface of floor. For W and L Ratings, a min 1/4 in. (6 mm) bead of sealant is required at the device/concrete interface on the top surface of the floor and a min 1/4 in. (6 mm) depth of sealant is required atop a min 1-3/4 in. (44 mm) thickness of mineral wool packing material inside the firestop device (Item 2).

3M COMPANY – FB-1000 NS sealant, FB-1003 SL sealant, FB-3000 WT sealant, CP 25WB+ caulk, FireDam 150+ caulk, IC 15WB+ caulk or MP+ putty

(Note: W and L Ratings apply only when FB-1000 NS, FB-1003 SL or FB-3000 WT sealants are used.)

*Bearing the UL Classification Mark

++ - Bearing the UL Recognized Component Mark

Reprinted from the Online Certifications Directory with permission from Underwriters Laboratories Inc.

Copyright © 2010 Underwriters Laboratories Inc.®



Note: This system was tested with a pressure differential of 50 Pa between the exposed and unexposed surfaces with the higher pressure on the exposed side.

System No. F-A-8014

October 07, 2010

F Rating – 3 Hr

T Ratings – 1/4, 1/2 and 3 Hr (See Item 2)

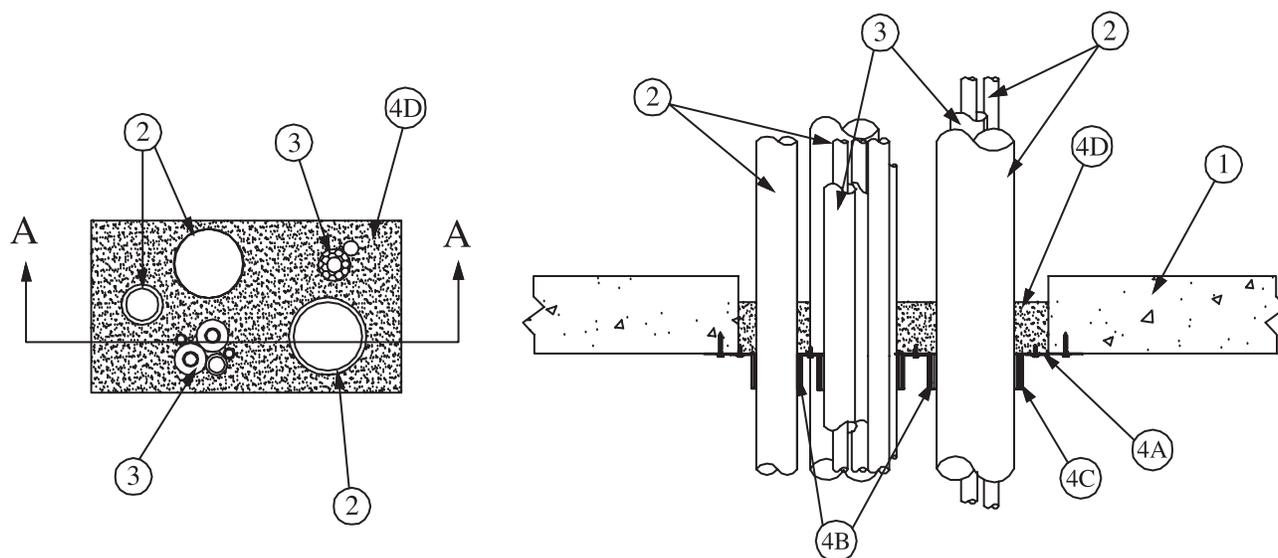

SECTION A-A

1. **Floor Assembly** – Min 4-1/2 in. (114 mm) thick reinforced lightweight or normal weight (100-150 pcf or 1600-2400 kg/m³) concrete. Max size of opening shall be 180 in² (1161 cm²) with a max dimension of 18 in. (457 mm).
2. **Through Penetrants** – Penetrants to be rigidly supported on both sides of floor assembly. Any combination of the following penetrants may be used:
 - A. **Steel Duct** – Nom 4 in. (102 mm) (or smaller) 30 gauge (or heavier) steel duct installed concentrically or eccentrically within opening. The annular space between duct and periphery of opening shall be min 1/4 in. (6 mm) to max 4 in. (102 mm). The annular space between duct and other penetrant shall be min 2 in. (51 mm).
 - B. **Nonmetallic Pipes** – Nonmetallic pipe or conduit installed concentrically or eccentrically within opening. The annular space between nonmetallic pipe or conduit and periphery of opening shall be min 2 in. (51 mm) to max 4 in. (102 mm). The annular space between nonmetallic pipe or conduit and other penetrant shall be min 2 in. (51 mm). The following types and sizes of nonmetallic pipes or conduits may be used:
 1. **Polyvinyl Chloride (PVC) Pipe** – Nom 4 in. (102 mm) diam (or smaller) Schedule 40 solid core or cellular core PVC pipe for use in vented (drain, waste or vent) piping system.
 2. **Acrylonitrile Butadiene Styrene (ABS) Pipe** – Nom 4 in. (102 mm) diam (or smaller) Schedule 40 solid core or cellular core ABS pipe for use in vented (drain, waste or vent) piping systems.
 3. **Fire Retardant Polypropylene (FRPP) Pipe** – Nom 4 in. (102 mm) diam (or smaller) Schedule 40 FRPP pipe for use in vented (drain, waste or vent) piping system.
 - C. **Double HVAC Line Set** – Pipes, tubing or cable to be tightly bundled within the opening. The annular space between the line set bundle and periphery of opening shall be min 1 in. (25 mm) to max 4 in. (102 mm). The annular space between the line set bundle and other penetrants shall be a min 2 in. (51 mm). The following types and sizes of penetrants may be used:
 1. **Metallic Pipes** – A max of four pipes or tubes installed within opening. The following types and sizes of metallic pipes, conduits or tubing may be used:
 1. **Copper Tubing** – Nom 3/4 in. (19 mm) diam (or smaller) Type L (or heavier) copper tubing.
 2. **Copper Pipe** – Nom 3/4 in. (19 mm) diam (or smaller) Regular (or heavier) copper pipe.
 All pipes or tubing larger than nom 1/2 in. (13 mm) diam shall be provided with tube insulation (Item C4).
 2. **Polyvinyl Chloride (PVC) Pipe** – A max of one nom 1 in. (25 mm) diam (or smaller) Schedule 40 solid core or cellular core PVC pipe for use in closed (process or supply) or vented (drain, waste or vent) piping systems.
 3. **Cables** – A max of two, max 8/C No. 18 AWG (or smaller) thermostat cables; XLPE or PVC insulation with XLPE or PVC jacket.
 4. **Tube Insulation-Plastics+** – Nom 1/2 in. (13 mm) thick (or less) acrylonitrile butadiene/polyvinyl chloride (AB/PVC) flexible foam furnished in the form of tubing.
See **Plastics** (QMFZ2) category in the Plastics Recognized Component Directory for names of manufacturers. Any Recognized Component tube insulation material meeting the above specifications and having a UL 94 Flammability Classification of 94-5A may be used.
 - D. **Single HVAC Line Set** – Pipes, tubing or cable to be bundled within the opening. The annular space between the line set penetrants shall be min 0 in. (0 mm) (point contact) to max 1 in. (25 mm). The annular space between the line set bundle and periphery of opening shall be min 1 in. (25 mm) to max 4 in. (102 mm). The annular space between the line set bundle and other penetrants shall be a min 2 in. (51 mm). The following types and sizes of penetrants may be used:

System No. F-A-8014 *continued*

1. **Metallic Pipes** – A max of two pipes or tubes installed within opening. The following types and sizes of metallic pipes, conduits or tubing may be used:
 - A. **Copper Tubing** – Nom 3/4 in. (19 mm) diam (or smaller) Type L (or heavier) copper tubing.
 - B. **Copper Pipe** – Nom 3/4 in. (19 mm) diam (or smaller) Regular (or heavier) copper pipe.All pipes or tubing larger than nom 1/2 in. (13 mm) diam shall be provided with pipe covering (Item D4).
2. **Cables** – One max 8/C No. 18 AWG (or smaller) thermostat cables; XLPE or PVC insulation with XLPE or PVC jacket.
3. **Tube Insulation-Plastics+** – Nom 1/2 in. (13 mm) thick (or less) acrylonitrile butadiene/polyvinyl chloride (AB/PVC) flexible foam furnished in the form of tubing.

See **Plastics** (QMFZ2) category in the Plastics Recognized Component Directory for names of manufacturers. Any Recognized Component tube insulation material meeting the above specifications and having a UL 94 Flammability Classification of 94-5A may be used.

The hourly T Rating for the firestop system is 1/4 Hr for penetrants A and C, 1/2 Hr for penetrants B1, B2, and D and 3 for penetrants B3.

3. **Firestop System** – The firestop system shall consist of the following:
 - A. **Forms** – Min 24 gauge (or heavier) galv sheet metal cut to the contour of the penetrants and secured to the underside of the floor with min 3/16 in. (4.8 mm) diam by min 1-1/4 in. (32 mm) steel masonry anchors as a permanent form.
 - B. **Fill, Void or Cavity Material*** – **Wrap Strip** – Nom 1/8 in. (3.2 mm) thick intumescent material supplied in 2 in. (51 mm) wide strips. Wrap strip tightly wrapped around nonmetallic pipes or conduits (Item 2B) and around the double HVAC line set (Item 2C) below floor. The top edge of the wrap strips shall be tightly butted to the underside of the sheet metal form (Item 3A). For nom 2 in. (51 mm) diam (and smaller) pipes, two layers are required. For nom 2-1/2 in. (64 mm) to 3 in. (76 mm) diam pipes, three layers are required. For nom 3-1/2 in. (89 mm) and 4 in. (102 mm) diam pipes, four layers are required. For the double HVAC line set, three layers are required. Wrap strip layers temporarily held in position using aluminum foil tape, steel wire tie, or equivalent. Wrap strip not used for penetrants 2A and 2D.
3M COMPANY – Ultra GS
 - C. **Steel Collar** – Nom 2 in. (51 mm) deep collar with 1-1/4 in. (32 mm) wide by 2 in. (51 mm) long anchor tabs and min 1/2 in. (13 mm) long tabs to retain wrap strip layers. Coils of precut 0.016 in. (0.41 mm) thick (28 gauge) galv sheet steel available from wrap strip manufacturer. As an alternate, collar may be field-fabricated from min 0.016 in. (0.41 mm) thick (28 gauge) galv sheet steel in accordance with instruction sheet supplied by wrap strip manufacturer. Steel collar, with anchor tabs bent outward 90 deg, wrapped tightly around wrap strip layers with min 1 in. (25 mm) overlap at seam. Anchor tabs to be pressed tightly against floor or wall surface(s), and collar to be compressed around wrap strip layers using a min 1/2 in. (13 mm) wide by 0.028 in. (0.71 mm) thick stainless steel band clamp at the collar midheight. Collar to be secured to sheet metal form with min No. 10 by min 1/2 in. (13 mm) long steel sheet metal screws in conjunction with min 1-1/4 in. (32 mm) diam steel washers. Min of four screws, symmetrically located, for nom 2 in. diam (and smaller) pipes and for the double HVAC line set. Min six screws, symmetrically located, for nom 2-1/2 and 3 in. (64 and 76 mm) diam pipes. Min eight screws, symmetrically located, for nom 3 and 3-1/2 in. (76 and 89 mm) diam pipes.
 - D. **Fill, Void or Cavity Material*** – **Mortar** – Mortar to be mixed with water in accordance with the manufacturer's instructions. Min 3 in. (76 mm) thickness of mortar applied within the annulus.
3M COMPANY – 3M Fire Barrier Mortar

+Bearing the UL Recognized Component Mark

*Bearing the UL Classification Mark

Reprinted from the Online Certifications Directory with permission from Underwriters Laboratories Inc.
Copyright © 2011 Underwriters Laboratories Inc.®



Note: This system was tested with a pressure differential of 50 Pa between the exposed and unexposed surfaces with the higher pressure on the exposed side.

System No. F-A-8015

October 07, 2010

F Rating – 3 Hr

T Ratings – 1/2, 3/4 and 3 Hr (See Item 2)

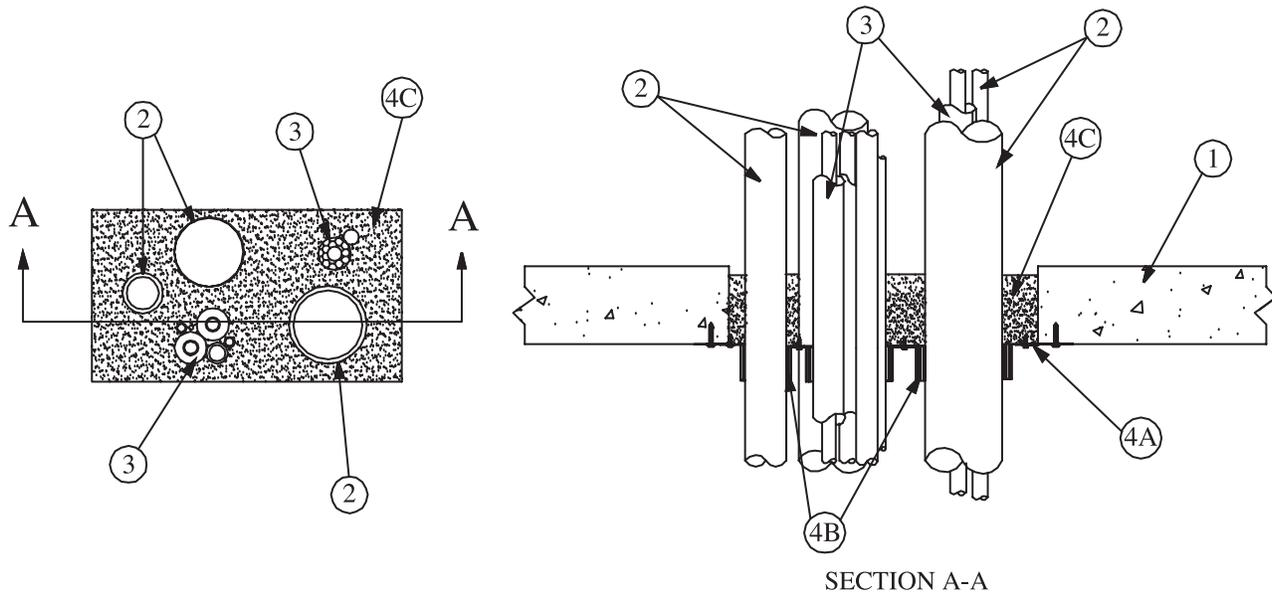

SECTION A-A

1. **Floor Assembly** – Min 4-1/2 in. (114 mm) thick reinforced lightweight or normal weight (100-150 pcf or 1600-2400 kg/m³) concrete. Max size of opening shall be 180 in² (1161 cm²) with a max dimension of 18 in. (457 mm).
2. **Through Penetrants** – Penetrants to be rigidly supported on both sides of floor assembly. Any combination of the following penetrants may be used:
 - A. **Steel Duct** – Nom 4 in. (102 mm) (or smaller) 30 gauge (or heavier) steel duct installed concentrically or eccentrically within opening. The annular space between duct and periphery of opening shall be min 1/4 in. (6 mm) to max 4 in. (102 mm). The annular space between duct and other penetrant shall be min 2 in. (51 mm).
 - B. **Nonmetallic Pipes** – Nonmetallic pipe or conduit installed concentrically or eccentrically within opening. The annular space between nonmetallic pipe or conduit and periphery of opening shall be min 2 in. (51 mm) to max 4 in. (102 mm). The annular space between nonmetallic pipe or conduit and other penetrant shall be min 2 in. (51 mm). The following types and sizes of nonmetallic pipes or conduits may be used:
 1. **Polyvinyl Chloride (PVC) Pipe** – Nom 4 in. (102 mm) diam (or smaller) Schedule 40 solid core or cellular core PVC pipe for use in vented (drain, waste or vent) piping system.
 2. **Acrylonitrile Butadiene Styrene (ABS) Pipe** – Nom 4 in. (102 mm) diam (or smaller) Schedule 40 solid core or cellular core ABS pipe for use in vented (drain, waste or vent) piping systems.
 3. **Fire Retardant Polypropylene (FRPP) Pipe** – Nom 4 in. (102 mm) diam (or smaller) Schedule 40 FRPP pipe for use in vented (drain, waste or vent) piping system.
 - C. **Double HVAC Line Set** – Pipes, tubing or cable to be tightly bundled within the opening. The annular space between the line set bundle and periphery of opening shall be min 1 in. (25 mm) to max 4 in. (102 mm). The annular space between the line set bundle and other penetrants shall be a min 2 in. (51 mm). The following types and sizes of penetrants may be used:
 1. **Metallic Pipes** – A max of four pipes or tubes installed within opening. The following types and sizes of metallic pipes, conduits or tubing may be used:
 1. **Copper Tubing** – Nom 3/4 in. (19 mm) diam (or smaller) Type L (or heavier) copper tubing.
 2. **Copper Pipe** – Nom 3/4 in. (19 mm) diam (or smaller) Regular (or heavier) copper pipe.
All pipes or tubing larger than nom 1/2 in. (13 mm) diam shall be provided with tube insulation (Item C4).
 2. **Polyvinyl Chloride (PVC) Pipe** – A max of one nom 1 in. (25 mm) diam (or smaller) Schedule 40 solid core or cellular core PVC pipe for use in closed (process or supply) or vented (drain, waste or vent) piping systems.
 3. **Cables** – A max of two, max 8/C No. 18 AWG (or smaller) thermostat cables; XLPE or PVC insulation with XLPE or PVC jacket.
 4. **Tube Insulation-Plastics+** – Nom 1/2 in. (13 mm) thick (or less) acrylonitrile butadiene/polyvinyl chloride (AB/PVC) flexible foam furnished in the form of tubing.
See **Plastics (QMFZ2)** category in the Plastics Recognized Component Directory for names of manufacturers. Any Recognized Component tube insulation material meeting the above specifications and having a UL 94 Flammability Classification of 94-5A may be used.

System No. F-A-8015 *continued*

D. **Single HVAC Line Set** – Pipes, tubing or cable to be bundled within the opening. The annular space between the line set penetrants shall be min 0 in. (0 mm) (point contact) to max 1 in. (25 mm). The annular space between the line set bundle and periphery of opening shall be min 1 in. (25 mm) to max 4 in. (102 mm). The annular space between the line set bundle and other penetrants shall be a min 2 in. (51 mm). The following types and sizes of penetrants may be used:

1. **Metallic Pipes** – A max of two pipes or tubes installed within opening. The following types and sizes of metallic pipes, conduits or tubing may be used:

A. **Copper Tubing** – Nom 3/4 in. (19 mm) diam (or smaller) Type L (or heavier) copper tubing.

B. **Copper Pipe** – Nom 3/4 in. (19 mm) diam (or smaller) Regular (or heavier) copper pipe.

All pipes or tubing larger than nom 1/2 in. (13 mm) diam shall be provided with pipe covering (Item D4).

2. **Cables** – One max 8/C No. 18 AWG (or smaller) thermostat cables; XLPE or PVC insulation with XLPE or PVC jacket.

3. **Tube Insulation-Plastics+** – Nom 1/2 in. (13 mm) thick (or less) acrylonitrile butadiene/polyvinyl chloride (AB/PVC) flexible foam furnished in the form of tubing.

See **Plastics** (QMFZ2) category in the Plastics Recognized Component Directory for names of manufacturers. Any Recognized Component tube insulation material meeting the above specifications and having a UL 94 Flammability Classification of 94-5A may be used.

The hourly F Rating for the firestop system is 1/4 Hr for penetrants A and C, 1/2 Hr for penetrants B1, B2, and D and 3 for penetrants B3.

3. **Firestop System** – The firestop system shall consist of the following:

A. **Forms** – Min 24 gauge (or heavier) galv sheet metal cut to the contour of the penetrants and secured to the underside of the floor with min 3/16 in. (4.8 mm) diam by min 1-1/4 in. (32 mm) steel masonry anchors as a permanent form.

B. **Fill, Void or Cavity Material*** – **Wrap Strip** – Nom 1/8 in. (3.2 mm) thick intumescent material supplied in 2 in. (51 mm) wide strips. Wrap strip tightly wrapped around nonmetallic pipes or conduits (Item 2B) and around the double HVAC line set (Item 2C) below floor. The top edge of the wrap strips shall be tightly butted to the underside of the sheet metal form (Item 3A). For nom 2 in. (51 mm) diam (and smaller) pipes, two layers are required. For nom 2-1/2 in. (64 mm) to 3 in. (76 mm) diam pipes, three layers are required. For nom 3-1/2 in. (89 mm) and 4 in. (102 mm) diam pipes, four layers are required. For the double HVAC line set, three layers are required. Wrap strip layers temporarily held in position using aluminum foil tape, steel wire tie, or equivalent. Wrap strip not used for penetrants 2A and 2D.

3M COMPANY – Ultra GS

C. **Steel Collar** – Nom 2 in. (51 mm) deep collar with 1-1/4 in. (32 mm) wide by 2 in. (51 mm) long anchor tabs and min 1/2 in. (13 mm) long tabs to retain wrap strip layers. Coils of precut 0.016 in. (0.41 mm) thick (28 gauge) galv sheet steel available from wrap strip manufacturer. As an alternate, collar may be field-fabricated from min 0.016 in. (0.41 mm) thick (28 gauge) galv sheet steel in accordance with instruction sheet supplied by wrap strip manufacturer. Steel collar, with anchor tabs bent outward 90 deg, wrapped tightly around wrap strip layers with min 1 in. (25 mm) overlap at seam. Anchor tabs to be pressed tightly against floor or wall surface(s), and collar to be compressed around wrap strip layers using a min 1/2 in. (13 mm) wide by 0.028 in. (0.71 mm) thick stainless steel band clamp at the collar midheight. Collar to be secured to sheet metal form with min No. 10 by min 1/2 in. (13 mm) long steel sheet metal screws in conjunction with min 1-1/4 in. (32 mm) diam steel washers. Min of four screws, symmetrically located, for nom 2 in. diam (and smaller) pipes and for the double HVAC line set. Min six screws, symmetrically located, for nom 2-1/2 and 3 in. (64 and 76 mm) diam pipes. Min eight screws, symmetrically located, for nom 3 and 3-1/2 in. (76 and 89 mm) diam pipes.

D. **Fill, Void or Cavity Material*** – **Mortar** – Mortar to be mixed with water in accordance with the manufacturer's instructions. Min 3 in. (76 mm) thickness of mortar applied within the annulus.

3M COMPANY – 3M Fire Barrier Mortar

+Bearing the UL Recognized Component Mark

*Bearing the UL Classification Mark

Reprinted from the Online Certifications Directory with permission from Underwriters Laboratories Inc.

Copyright © 2011 Underwriters Laboratories Inc.®



Note: This system was tested with a pressure differential of 50 Pa between the exposed and unexposed surfaces with the higher pressure on the exposed side.

System No. F-B-8001

May 18, 2005
F Rating – 2 Hr
T Rating – 0 Hr

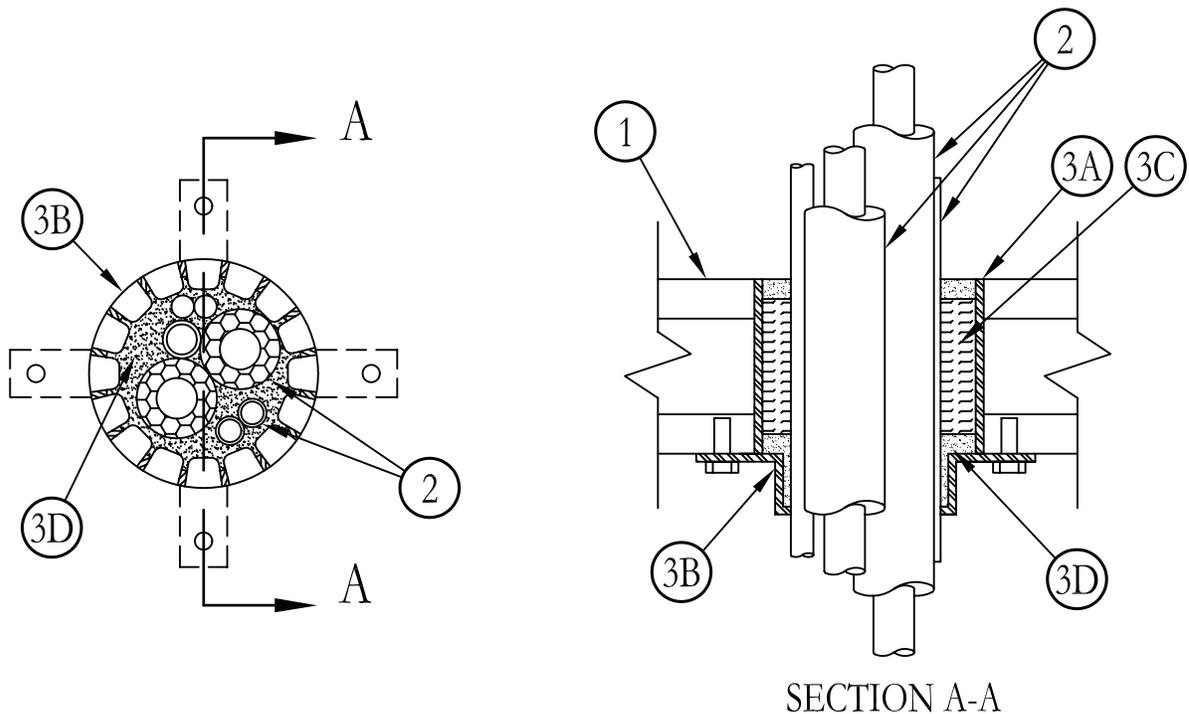

SECTION A-A

1. **Floor Assembly** – Min 8 in. (203 mm) thick UL Classified hollow-core **Precast Concrete Units*** or min 8 in. (203 mm) thick reinforced lightweight or normal weight (100-150 pcf or 1600-2400 kg/m³) concrete. Max diam of opening is 4-1/2 in. (114 mm).
See **Precast Concrete Units** (CFTV) categories in the Fire Resistance Directory for names of manufacturers.
2. **Through Penetrants** – Pipes, conduits, tubing or cables to be bundled within the opening such that the aggregate cross-sectional area of penetrants in opening to be min 42 percent to max 54 percent of the cross-sectional area of the opening in floor or wall. A min 1/4 in. (6 mm) annular space shall be maintained around uninsulated metallic pipes. The space between penetrants and periphery of opening shall be min 1/4 in. (6 mm). Penetrants to be rigidly supported on both sides of floor or wall assembly. The following types and sizes of penetrants may be used:
 - A. **Metallic Pipes** – The following types and sizes of metallic pipes, conduits or tubing may be used:
 - A1. **Steel Pipe** – Nom 3/4 in. (19 mm) diam (or smaller) Schedule 5 (or heavier) steel pipe.
 - A2. **Conduit** – Nom 3/4 in. (19 mm) diam (or smaller) electrical metallic tubing or steel conduit.
 - A3. **Copper Tubing** – Nom 3/4 in. (19 mm) diam (or smaller) Type L (or heavier) copper tubing.
 - A4. **Copper Pipe** – Nom 3/4 in. (19 mm) diam (or smaller) Regular (or heavier) copper pipe.
 All pipes, conduits or tubing larger than nom 1/2 in. (13 mm) diam shall be provided with pipe covering (Item 3).
 - B. **Nonmetallic Pipes** – A max of one nonmetallic pipe or conduit may be used. A min 1/4 in. (6 mm) space must be maintained between uninsulated metallic pipes and nonmetallic pipes or conduits. The following types and sizes of nonmetallic pipes or conduits may be used:
 - B1. **Polyvinyl Chloride (PVC) Pipe** – Nom 1-1/4 in. (32 mm) diam (or smaller) Schedule 40 solid core PVC pipe for use in closed (process or supply) or vented (drain, waste or vent) piping system.
 - B2. **Chlorinated Polyvinyl Chloride (CPVC) Pipe** – Nom 1-1/4 in. (32 mm) diam (or smaller) SDR13.5 CPVC pipe for use in closed (process or supply) piping systems.
 - B3. **Rigid Nonmetallic Conduit**⁺⁺ – Nom 1-1/4 in. (32 mm) diam (or smaller) Schedule 40 PVC conduit installed in accordance with Article 347 of the National Electrical Code (NFPA No. 70.)
 - C. **Cables** – Max two 8/C No. 12 AWG multiconductor power and control cables; XLPE or PVC insulation with XLPE or PVC jacket.
 - D. **Pipe Covering** – The following types and sizes of pipe coverings may be used with the metallic pipes:
 - D1. **Tube Insulation – Plastics**⁺⁺⁺ – Nom 1/2 in. (13 mm) thick acrylonitrile butadiene/polyvinyl chloride (AB/PVC) flexible foam furnished in the form of tubing. Tubing to be discontinuous from top of caulk or putty (Item 3D) at bottom and top sides of floor.
See **Plastics**⁺⁺⁺ (QMFZ2) category in the Plastics Recognized Component Directory for names of manufacturers. Any Recognized Component tube insulation material meeting the above specifications and having a UL94 Flammability Classification of 94-5VA may be used.

System No. F-B-8001 *continued*

D2. **Pipe Covering*** – Nom 1/2 in. (13 mm) thick hollow cylindrical heavy density (min 3.5 pcf or 56 kg/m³) glass fiber units jacketed on the outside with an all service jacket. Longitudinal joints sealed with metal fasteners or factory-applied self-sealing lap tape. Transverse joints secured with metal fasteners or with butt tape supplied with the product.

See **Pipe and Equipment Covering – Materials*** (BRGU) category in the Building Materials Directory for names of manufacturers. Any pipe covering material meeting the above specifications and bearing the UL Classification Marking with a Flame Spread Index of 25 or less and a Smoke Developed Index of 50 or less may be used.

3. **Firestop System** – The details of the firestop system shall be as follows:

- A. **Steel Sleeve** – Min 28 gauge galv steel sleeve friction-fitted into opening with a min 2 in. (51 mm) overlap. Sleeve may be recessed a max of 1/2 in. (13 mm) below the top surface of floor or installed flush with top surface of floor. Not required for solid floors.
- B. **Firestop Device*** – Firestop device consisting of a steel collar lined with intumescent material and provided with steel clips for attachment to underside of floor or both sides of wall in accordance with accompanying installation instructions. The following firestop devices are to be used, dependent on the max opening size:

| Max Opening Size In. (mm) | Firestop Device |
|---------------------------|-----------------|
| 3-1/2 (89) | PPD 3 |
| 4-1/2 (114) | PPD 4 |

3M COMPANY

- C. **Packing Material** – Min 6-3/8 in. (162 mm) thickness of nom 4 pcf (64 kg/m³) (or heavier) mineral-wool batt insulation or ceramic (alumina silica) fiber blanket firmly packed into opening as a permanent form. Packing material to be recessed from top and bottom surfaces of floor as required to accommodate the required thickness of fill material (Item 3D).
- D. **Fill, Void or Cavity Materials* – Caulk, Sealant or Putty** – When PPD 3 firestop device is used, min 1 in. (25 mm) thickness of caulk or putty applied to completely fill annular space inside of firestop device and between penetrants, flush with the bottom surface of floor and extending downward. When PPD 4 firestop device is used, min 2 in. (51 mm) thickness of caulk or putty applied to completely fill annular space inside of firestop device and between penetrants, flush with the bottom surface of floor and extending downward. Min 5/8 in. (16 mm) thickness of caulk or putty applied within annular space between penetrants and periphery of opening flush with bottom surface of floor. Min 3/4 (19 mm) in thickness of caulk or putty applied to completely fill annular space, flush with top surface of floor.

3M COMPANY – CP 25WB+, IC 15WB+ caulk, FB-3000 WT sealant or MP+ Stix putty.
(Note: CP 25WB+ not suitable for use with CPVC pipes.)

*Bearing the UL Classification Marking

++Bearing the UL Listing Mark

+++Bearing the UL Recognized Component Marking

Reprinted from the Online Certifications Directory with permission from Underwriters Laboratories Inc.
Copyright © 2010 Underwriters Laboratories Inc.®



Note: This system was tested with a pressure differential of 50 Pa between the exposed and unexposed surfaces with the higher pressure on the exposed side.

System No. F-B-8005

May 18, 2005
 F Rating – 2 Hr
 T Rating – 1/2 Hr

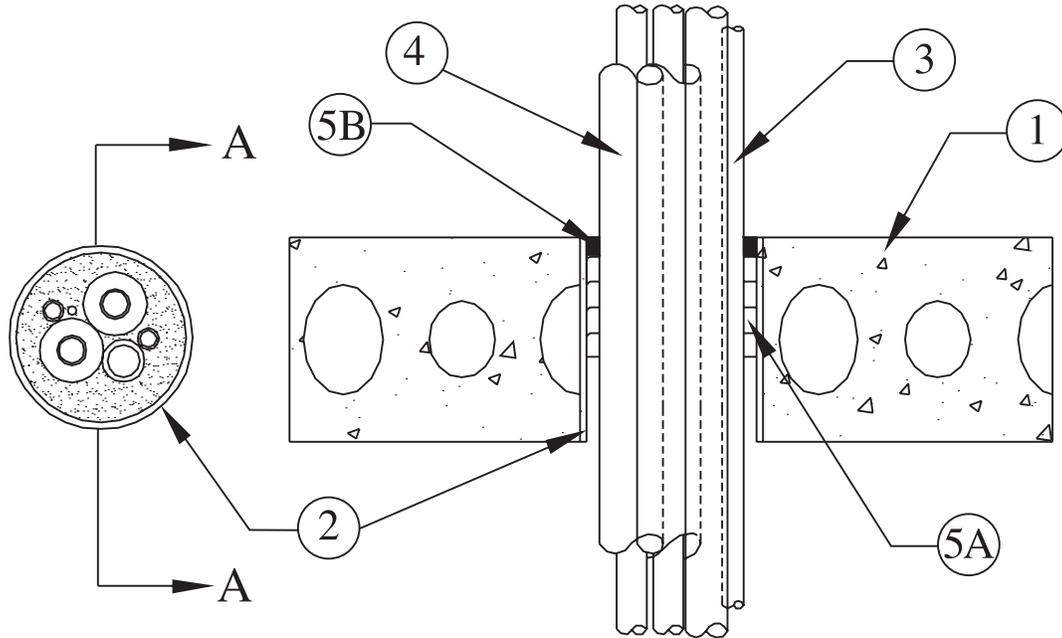

SECTION A-A

1. **Floor Assembly** – Min 6 in. (152 mm) thick UL Classified hollow-core Precast Concrete Units* or min 6 in. (152 mm) thick reinforced lightweight or normal weight (100-150 pcf or 1600 - 2400 kg/m³) concrete. Max diam of opening is 5 in. (127 mm).
 See **Precast Concrete Units** (CFTV) categories in the Fire Resistance Directory for names of manufacturers.
2. **Steel Sleeve** – Cylindrical sleeve fabricated from min 0.018 in. (4.6 mm) thick galv sheet steel and having a min 2 in. (51 mm) lap along the longitudinal seam. Length of steel sleeve to be equal to thickness of floor. Sleeve installed flush with top and bottom surfaces of floor by coiling the sheet steel to a diam smaller than the through opening, inserting the coil through the opening and releasing the coil.
3. **Through Penetrants** – Pipes, tubing or cable to be bundled within the opening. The annular space between penetrants shall be min 0 in. (0 mm) (point contact) to max 1 in. (25 mm). The space between penetrants and sleeve shall be min 1/2 in. (13 mm) to max 1 in. (25 mm). Penetrants to be rigidly supported on both sides of floor assembly. The following types and sizes of penetrants may be used:
 - A. **Metallic Pipes** – A max of four pipes or tubes installed within opening. The following types and sizes of metallic pipes, conduits or tubing may be used:
 1. **Copper Tubing** – Nom 1 in. (25 mm) diam (or smaller) Type L (or heavier) copper tubing.
 2. **Copper Pipe** – Nom 1 in. (25 mm) diam (or smaller) Regular (or heavier) copper pipe.
 All pipes or tubing larger than nom 1/2 in. (13 mm) diam shall be provided with pipe covering (Item 4).
 - B. **Polyvinyl Chloride (PVC) Pipe** – A max of one nom 1 in. (25 mm) diam (or smaller) Schedule 40 solid core PVC pipe for use in closed (process or supply) or vented (drain, waste or vent) piping systems.
 - C. **Cables** – A max of two, max 8/C No. 18 AWG (or smaller) thermostat cables; XLPE or PVC insulation with XLPE or PVC jacket.
4. **Tube Insulation-Plastics+** – Nom 1/2 in. (13 mm) thick (or less) acrylonitrile butadiene/polyvinyl chloride (AB/PVC) flexible foam furnished in the form of tubing.
 See **Plastics** (QMFZ2) category in the Plastics Recognized Component Directory for names of manufacturers. Any Recognized Component tube insulation material meeting the above specifications and having a UL 94 Flammability Classification of 94-5A may be used.
- 5A. **Packing Material** – Min 3 in. (76 mm) thick of min 4 pcf (64 kg/m³) mineral wool batt insulation firmly packed within annulus and recessed from the top surface of floor to accommodate the required thickness of fill material.
- 5B. **Fill, Void or Cavity Materials – Caulk, Sealant or Putty*** – Min 1/2 in. (13 mm) thickness of caulk or putty, installed within annulus, flush with the top surface of floor.

3M COMPANY– CP 25WB+, IC 15WB+ caulk, FB-3000 WT sealant or MP+ putty.

*Bearing the UL Classification Mark

++Bearing the UL Recognized Component Mark

Reprinted from the Online Certifications Directory with permission from Underwriters Laboratories Inc.

Copyright © 2010 Underwriters Laboratories Inc.®



Note: This system was tested with a pressure differential of 50 Pa between the exposed and unexposed surfaces with the higher pressure on the exposed side.

System No. F-B-8006

May 18, 2005
F Rating – 2 Hr
T Rating – 1/4 Hr

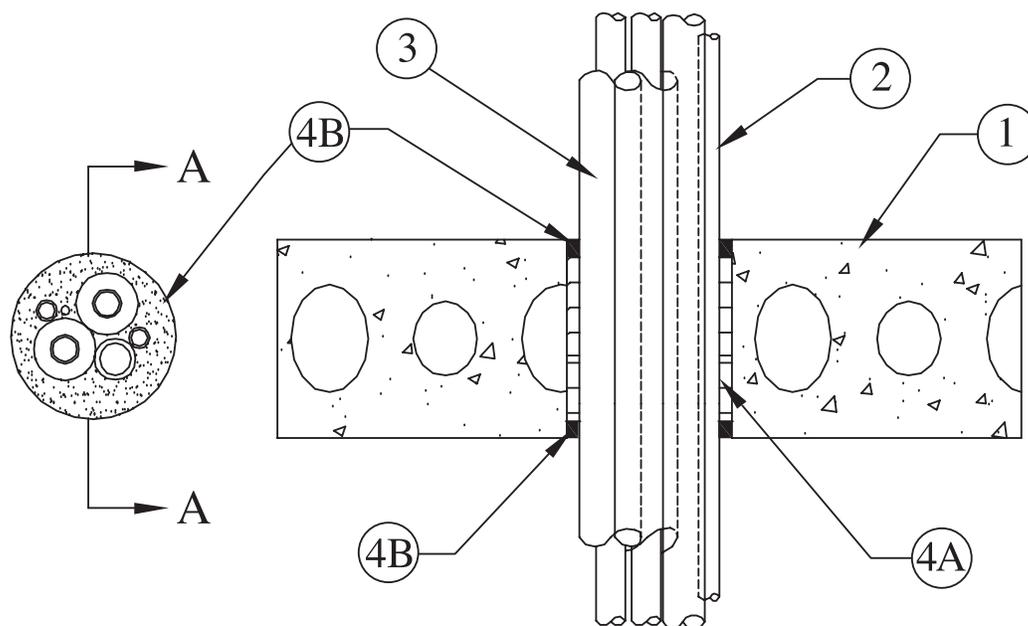

SECTION A-A

1. **Floor Assembly** - Min 6 in. (152 mm) thick UL Classified hollow-core Precast Concrete Units* or min 6 in. (152 mm) thick reinforced lightweight or normal weight (100-150 pcf or 1600 - 2400 kg/m³) concrete. Max diam of opening is 5 in. (127 mm).
See **Precast Concrete Units** (CFTV) categories in the Fire Resistance Directory for names of manufacturers.
2. **Through Penetrants** – Pipes, tubing or cable to be bundled within the opening. The annular space between penetrants shall be min 0 in. (0 mm) (point contact) to max 1 in. (25 mm). The space between penetrants and periphery of opening shall be min 1/2 in. (13 mm) to max 1 in. (25 mm). Penetrants to be rigidly supported on both sides of floor assembly. The following types and sizes of penetrants may be used:
 - A. **Metallic Pipes** – A max of four pipes or tubes installed within opening. The following types and sizes of metallic pipes, conduits or tubing may be used:
 1. **Copper Tubing** - Nom 1 in. (25 mm) diam (or smaller) Type L (or heavier) copper tubing.
 2. **Copper Pipe** - Nom 1 in. (25 mm) diam (or smaller) Regular (or heavier) copper pipe.
 All pipes or tubing larger than nom 1/2 in. (13 mm) diam shall be provided with pipe covering (Item 4).
 - B. **Polyvinyl Chloride (PVC) Pipe** - A max of one nom 1 in. (25 mm) diam (or smaller) Schedule 40 solid core PVC pipe for use in closed (process or supply) or vented (drain, waste or vent) piping systems.
 - C. **Cables** – A max of two, max 8/C No. 18 AWG (or smaller) thermostat cables; XLPE or PVC insulation with XLPE or PVC jacket.
3. **Tube Insulation-Plastics+** – Nom 1/2 in. (13 mm) thick (or less) acrylonitrile butadiene/polyvinyl chloride (AB/PVC) flexible foam furnished in the form of tubing.
See **Plastics** (QMFZ2) category in the Plastics Recognized Component Directory for names of manufacturers. Any Recognized Component tube insulation material meeting the above specifications and having a UL 94 Flammability Classification of 94-5A may be used.
4. **Firestop System** – The firestop system shall consist of the following:
 - A. **Packing Material** – Min 5 in. (127 mm) thickness of min 4 pcf (64 kg/m³) mineral wool batt insulation firmly packed within annulus and recessed from the top and bottom surfaces of floor to accommodate the required thickness of fill material.
 - B. **Fill, Void or Cavity Materials – Caulk* or Sealant** – Min 1/2 in. (13 mm) thickness of caulk installed within annulus, flush with the top and bottom surfaces of floor.
3M COMPANY– CP 25WB+, IC 15WB+ caulk or FB-3000 WT sealant.

*-Bearing the UL Classification Mark

+-Bearing the UL Recognized Component Mark

Reprinted from the Online Certifications Directory with permission from Underwriters Laboratories Inc.
Copyright © 2010 Underwriters Laboratories Inc.®



Note: This system was tested with a pressure differential of 50 Pa between the exposed and unexposed surfaces with the higher pressure on the exposed side.

System No. W-J-8019

May 19, 2005

F Ratings – 1 & 2 Hr (See Item 1)

T Ratings – 1/2 Hr (See Item 1)

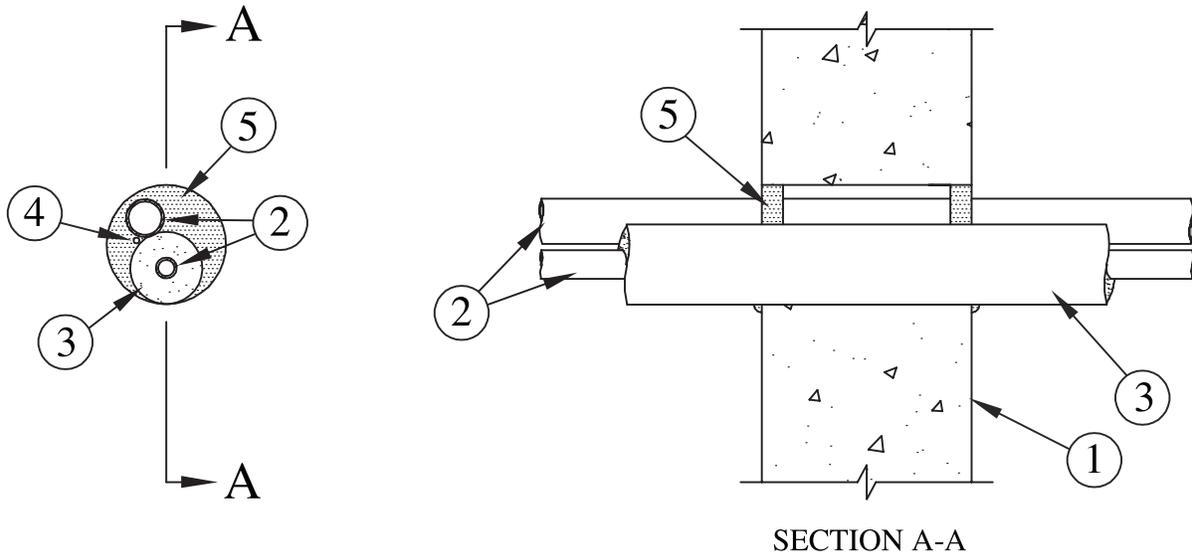

1. **Wall Assembly** – Min 6 in. (152 mm) thick reinforced lightweight or normal weight (100-150 pcf or 1600-2400 kg/m³) concrete wall. Wall may also be constructed of any UL Classified **Concrete Blocks***. Max diam of opening is 5 in. (127 mm).
See **Concrete Blocks** (CAZT) category in the Fire Resistance Directory for names of manufacturers.
2. **Through Penetrants** – A max of two pipes or tubes and one cable installed eccentrically or concentrically within the opening. Annular space between penetrants and periphery of opening to be min 0 in. (point contact) to max 1-1/2 in. (0 mm to max 38 mm). Separation between penetrants to be min 0 in. (point contact) to max 1-1/2 in. (0 mm to max 38 mm). Penetrants to be rigidly supported on both sides of the wall. The following types and sizes of penetrants may be used:
 - A. **Copper Tubing** – Nom 1 in. (25 mm) diam (or smaller) Type L (or heavier) copper tubing.
 - B. **Copper Pipe** – Nom 1 in. (25 mm) diam (or smaller) Regular (or heavier) copper pipe.
 - C. **Steel Pipe** – Nom 1 in. (25 mm) diam (or smaller) Schedule 5 (or heavier) steel pipe.
 - D. **Cables** – Max 7/C No. 12 AWG multiconductor power and control cables; XLPE or PVC insulation with XLPE or PVC jacket.
3. **Tube Insulation-Plastics**+ – Nom 3/4 in. (19 mm) thick (or less) acrylonitrile butadiene/polyvinyl chloride (AB/PVC) flexible foam furnished in the form of tubing. The tube insulation may be installed on a max of one pipe or tube. Annular space between the tube insulation and periphery of opening to be min 0 in. (point contact) to max 1-1/2 in. (0 mm to max 38 mm). Space between insulated and uninsulated penetrants to be 0 in. (point contact) to max 1-1/2 in. (0 mm to max 38 mm).
See **Plastics** (QMFZ2) category in the Plastics Recognized Component Directory for names of manufacturers. Any Recognized Component tube insulation material meeting the above specifications and having a UL 94 Flammability Classification of 94-5A may be used.
4. **Cables** – Max two 7/C (or less) No. 12 AWG (or smaller) multiconductor power and control cables with XLPE or PVC insulation with XLPE or PVC jacket. Cables to be spaced min 0 in. (point contact) to max 1 in. (0 mm to max 25 mm). from the insulated through penetrants and min 1/2 in. to max 1 in. (13 mm to max 25 mm) from non-insulated through penetrants. The space between the cables and the periphery of the opening shall be min 0 in. (point contact) to max 1 in. (0 mm to max 25 mm). Cables to be rigidly supported on both sides of wall assembly.
5. **Fill, Void or Cavity Material*** – **Caulk or Sealant** – Min 5/8 in. (16 mm) thickness of caulk applied within annulus, flush with both surfaces of wall. Min 1/4 in. (6 mm) diam bead of caulk applied to penetrant/wall interface at point contact location on both sides of wall.
3M COMPANY– CP 25WB+, IC 15WB+ caulk or FB-3000 WT sealant

* Bearing the UL Classification Marking

Reprinted from the Online Certifications Directory with permission from Underwriters Laboratories Inc.
Copyright © 2010 Underwriters Laboratories Inc.®



System No. W-J-8025

May 19, 2005
F Ratings – 2 Hr
T Ratings – 3/4 Hr

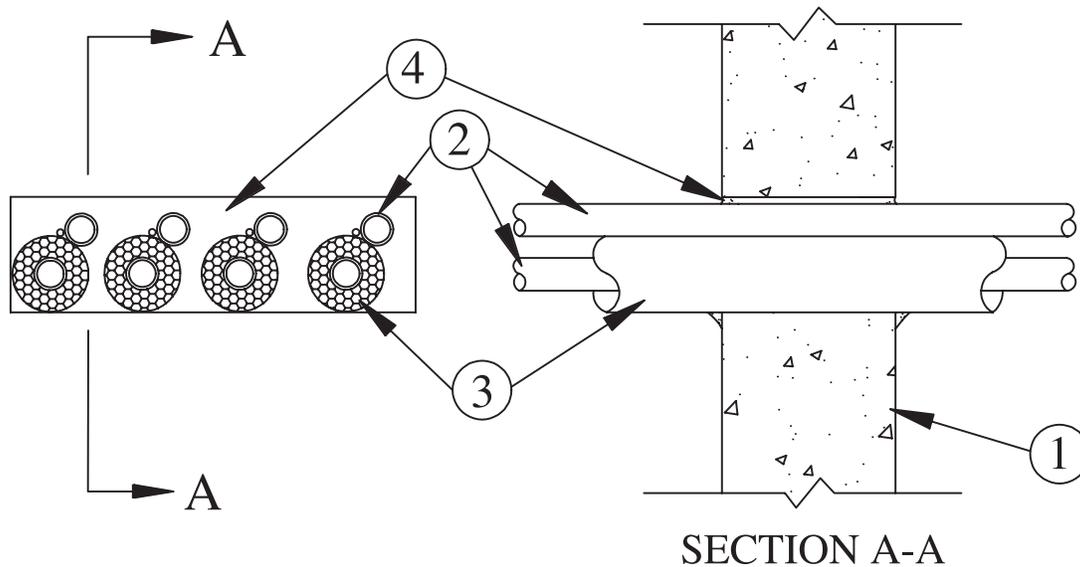

1. **Wall Assembly** – Min 6 in. (152 mm) thick reinforced lightweight or normal weight (100-150 pcf or 1600-2400 kg/m³) concrete wall. Wall may also be constructed of any UL Classified **Concrete Blocks***. Max area of opening is 58 sq in. (375 sq cm) with a max dimension of 14-1/2 in. (368 mm).

See **Concrete Blocks** (CAZT) category in the Fire Resistance Directory for names of manufacturers.

2. **Through Penetrants** – A max of eight pipes or tubes and four cables installed eccentrically or concentrically within the opening. Annular space between penetrants and periphery of opening to be min 0 in. (point contact) to max 1-1/2 in. (0 mm to max 38 mm). Separation between penetrants to be min 0 in. (point contact) to max 1-1/2 in. (0 mm to max 38 mm). Penetrants to be rigidly supported on both sides of the wall. The following types and sizes of penetrants may be used:

- A. **Copper Tubing** – Nom 1 in. (25 mm) diam (or smaller) Type L (or heavier) copper tubing.
- B. **Copper Pipe** – Nom 1 in. (25 mm) diam (or smaller) Regular (or heavier) copper pipe.
- C. **Steel Pipe** – Nom 1 in. (25 mm) diam (or smaller) Schedule 5 (or heavier) steel pipe.
- D. **Cables** – Max 7/C No. 12 AWG multiconductor power and control cables; XLPE or PVC insulation with XLPE or PVC jacket.

3. **Tube Insulation – Plastics+** – Nom 3/4 in. (19 mm) thick (or less) acrylonitrile butadiene/polyvinyl chloride (AB/PVC) flexible foam furnished in the form of tubing. The tube insulation may be installed on a max of four pipes or tubes. Annular space between the tube insulation and periphery of opening to be min 0 in. (point contact) to max 1-1/2 in. (0 mm to max 38 mm). Space between insulated and uninsulated penetrants to be 0 in. (point contact) to max 1-1/2 in. (0 mm to max 38 mm).

See **Plastics** (QMFZ2) category in the Plastics Recognized Component Directory for names of manufacturers. Any Recognized Component tube insulation material meeting the above specifications and having a UL 94 Flammability Classification of 94-5A may be used.

4. **Fill, Void or Cavity Material* – Caulk or Sealant** – Min 5/8 in. (16 mm) thickness of caulk applied within annulus, flush with both surfaces of wall. Min 1/4 in. (6 mm) diam bead of caulk applied to gypsum board/penetrant interface at point contact location on both sides of wall.

3M COMPANY– CP 25WB+, IC 15WB+ caulk or FB-3000 WT sealant

* Bearing the UL Classification Marking

Reprinted from the Online Certifications Directory with permission from Underwriters Laboratories Inc.
Copyright © 2010 Underwriters Laboratories Inc.®



System No. W-J-8042

September 20, 2011

ANSI/UL1479 (ASTM E814)

F Rating – 2 Hr

T Rating – 3/4 Hr

CAN/ULC S115

F Rating – 2 Hr

FT Rating – 3/4 Hr

FH Rating – 2 Hr

FTH Rating – 3/4 Hr

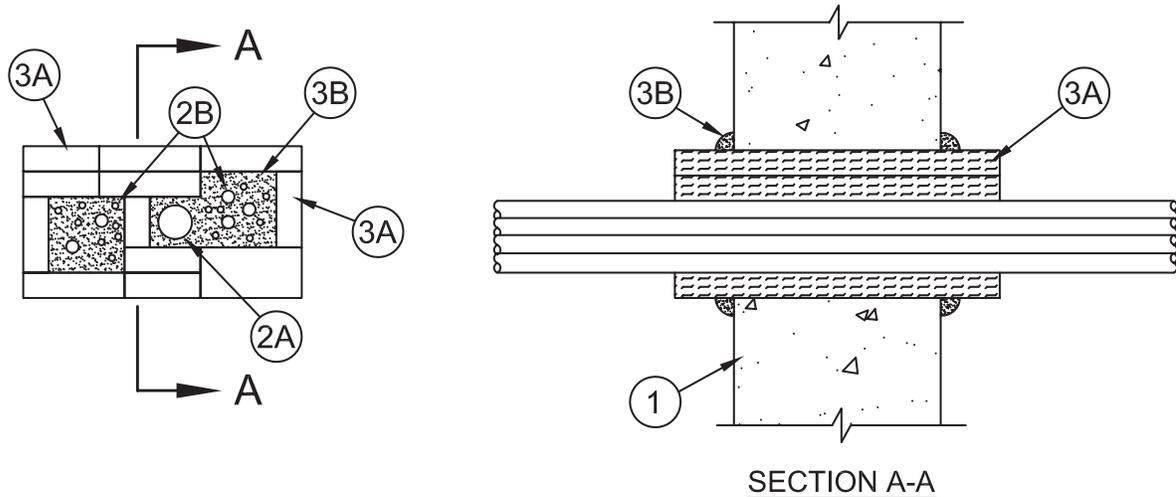
**SECTION A-A**

1. **Wall Assembly** – Min 6 in. (152 mm) thick reinforced lightweight or normal weight (100-150 pcf or 1600 - 2400 kg/m³) concrete. Wall may also be constructed of any UL Classified **Concrete Blocks***. Max size of opening to be 8 in. (114 mm) high by 16 in. (406 mm) wide. See **Concrete Blocks (CAZT)** category in the Fire Resistance Directory for names of manufacturers.
2. **Through-Penetrants** – Max two cables bundles and one optical fiber raceway as described below. Through penetrants to be rigidly supported on both sides of wall assembly. The following types and sizes of through-penetrants may be used:
 - A. **Nonmetallic Penetrant** – One nonmetallic raceway as described in a single line item below.
 - A1. **Optical Fiber/Communications/Signaling/Coaxial Cable Raceways+–** Nom 1-1/4 in. (32 mm) diam (or smaller) plenum rated raceways installed in accordance with the National Electrical Code (NFPA No. 70). Raceway to be positioned in the center of the wall opening.
See **Optical Fiber/Communications/Signaling/Coaxial Cable Raceway (QAZM)** category in the Electrical Construction Equipment Directory for names of manufacturers.
 - B. **Cables** – Cables installed in a max of two bundles having a max bundle diam of 4 in. (102 mm). Cable bundles to be positioned in the middle of wall opening and a min of 2-1/2 in. (64 mm) from opening edge to center of bundle. Any combination of the following types and sizes of cables may be used:
 - B1. Max 2/C No. 18 AWG copper conductor thermostat cable with polyvinyl chloride (PVC) insulation and jacket materials.
 - B2. Max 4 pair No. 24 AWG copper conductor Cat 5e or Cat 6 telephone cable with PVC insulation and jacket materials.
 - B3. Max 100 pair No. 24 AWG copper conductor telephone cable with PVC insulation and jacket materials.
 - B4. Max 7/C No. 12 AWG copper conductor power and control cables with XLPE or PVC insulation with XLPE or PVC jacket.
 - B5. Max 48 MM62.5 micron fiber optic cables with having a min FT-6 rating.
 - B6. Max 62.5/125 micron fiber optic cables with having a min Riser rating.
 - B7. Max 3/C (with ground) No. 12 AWG (or smaller) nonmetallic sheathed (Romex) cable with PVC insulation and jacket materials.
 - B8. Max 1/C No. 8 AWG copper conductor cable with PVC insulation and nylon jacket materials.
 - B9. Max 12 core No. 26 AWG shielded multi coax cable with foam high density polyethylene insulation and PVC jacket.
 - B10. Max 48 MM62.5 micron fiber optic cables with having a min FT-6 rating.
 - B11. Max 62.5/125 micron fiber optic cables with having a min Riser rating.
 - B12. Max 1/C 3/0 AWG copper conductor cable with PVC insulation and jacket materials.
 - B13. Max three copper conductors (with ground) No. 12 AWG **Metal Clad Cable+**.
 - B14. Max four copper conductors No. 2 AWG **Metal Clad Cable+**.
 - B15. Max 1/C 2/0 AWG non halogen copper conductor cable.
 - B16. Max 300 pair No. 24 AWG copper conductor telephone cable with PVC insulation and jacket materials.
 - B17. Max 30 pair No. 22 copper conductor shielded switchboard cable with PVC insulation and jacket materials.
 - B18. Max RG/6 (or smaller) coaxial cable with fluorinated ethylene (FE) or PVC insulation and jacket materials.
 - B19. Max 7/C No. 12 AWG copper conductors with PVC insulation and jacket materials.

System No. W-J-8042 *continued*

B20. Max 4 pair No. 23 AWG copper conductor Cat 6 telephone cable with PVC insulation and jacket materials.

B21. Max three copper conductors (with ground) No. 12 AWG steel **Armored Cable+**.

B22. Max 04-02 2.5M fiber optic cables having a max diameter of 0.450 in. (11.4 mm).

B23. Max 1/C No. 350 kcmil copper conductors with PVC insulation and fabric jacket materials.

B24. Max 3/C with ground No. 2/0 AWG aluminum conductor SER cable with cross linked polyethylene (XLPE) insulation and PVC jacket.

B25. Max nom 0.75 in. diam water tight conduit.

3. **Firestop System** – The firestop system shall consist of the following:

- A. **Fill, Void or Cavity Materials* – Pillows** – Max 9 in. (229 mm) long by 6 in. (152 mm) wide by 2 and 3 in. (51 and 76 mm) thick plastic covered pillows tightly-packed to fill annular space between the cable bundles, raceway and periphery of opening and the annular space between the cable bundles and raceway installed within the opening. Pillows installed with 9 in. (229 mm) dimension projecting through wall and centered within the opening.

3M COMPANY

3M FIRE PROTECTION PRODUCTS – Fire Barrier Pillow or Fire Barrier Self-Locking Pillow

- B. **Fill, Void or Cavity Materials* – Putty** – Moldable putty material, installed within voids around penetrants and pillows to a min thickness of 1 in. (25 mm) on both sides of wall.

3M COMPANY

3M FIRE PROTECTION PRODUCTS – MP+ Moldable Putty

*Bearing the UL Classification Mark

+ Bearing the UL Listing Mark

Reprinted from the Online Certifications Directory with permission from Underwriters Laboratories Inc.

Copyright © 2011 Underwriters Laboratories Inc.®



Note: This system was tested with a pressure differential of 50 Pa between the exposed and unexposed surfaces with the higher pressure on the exposed side.

Through Penetrations

Combos

8000 Series

Concrete

WJ

System No. W-J-8052

June 26, 2014

ANSI/UL1479 (ASTM E814)

F Rating — 2 Hr

T Rating — 0

CAN/ULC S115

F Rating — 2 Hr

FT Rating — 0

FH Rating — 2 Hr

FTH Rating — 0

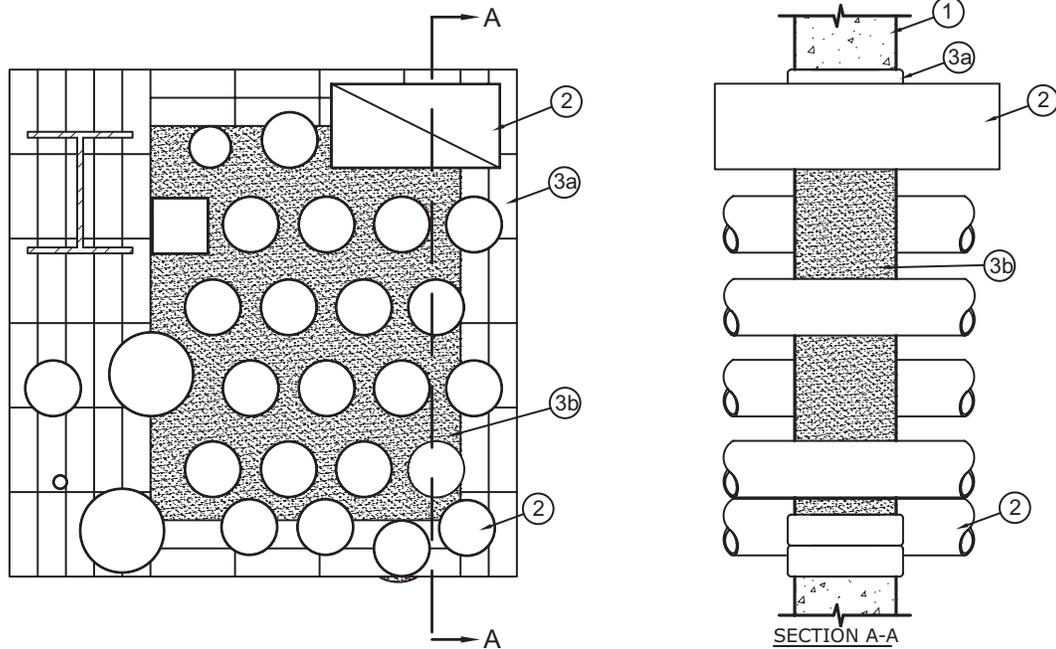

1. **Wall Assembly** — Min 6 in. (152 mm) thick reinforced lightweight or normal weight (100-150 pcf or 1600-2400 kg/m³) concrete. Wall may also be constructed of any UL Classified Concrete Blocks*. Max size of opening to be 36 in. (914 mm) high by 36 in. (914 mm) wide. See **Concrete Blocks (CAZT)** category in the Fire Resistance Directory for names of manufacturers.
2. **Through-Penetrant** — One or more pipes, conduit, tubes, ducts, or steel members to be installed within the opening. The total number of through-penetrants is dependent on the size of the opening and the types and sizes of the penetrants. Any combination of the penetrants described below may be used provided that the following parameters relative to the annular spaces and the spacing between the through penetrants are maintained. The separation between the penetrants shall be min 1/2 in. (12 mm) to max 3 in. (76 mm). The annular space between penetrants and the periphery of opening shall be min 1/2 in. (12 mm) to max 6 in. (152 mm). Pipes, conduit tubes, ducts, or steel members to be rigidly supported on both sides of wall assembly. The following types and sizes of pipes, conduit tubes, ducts, or steel members may be used.
 - A. **Conduit** — Max 20, nom 4 in. (102 mm) diam (or smaller) electrical metallic tubing (EMT) or ridged steel conduit.
 - B. **Pipe** — Max 1, nom 6 in. (152 mm) diam (or smaller) Schedule 10 (or heavier) steel pipe.
 - C. **Duct** — Max 1, nom 6 in. by 12 in. (or smaller) No 26 gauge (or heavier) steel duct.
 - D. **Duct** — Max 1, nom 4 in. diam (or smaller) No. No 28 gauge (or heavier) steel duct.
 - E. **Pipe** — Max 1, nom 3 in. (76 mm) diam (or smaller) service weight (or heavier) cast iron soil pipe.
 - F. **Beam** — Max 1, W8 x 15 (or smaller) steel beam.
 - G. **Tube Steel** — Max 1, nom 4 in. square (or smaller) 0.25 in. (or heavier) steel tube.
 - H. **Pipe** — Max 1, nom 6 in. diam (or smaller) type L (or heavier) copper pipe.
 - I. **Conduit** — Max 1, nom 1 in. (102 mm) diam (or smaller) electrical metallic tubing (EMT) or ridged steel conduit.
 - J. **Pipe** — Max 1, nom 4 in. diam (or smaller) Schedule 40 (or heavier) steel pipe.
3. **Firestop System** — The details of the firestop system shall be as follows:
 - A. **Fill, Void or Cavity Materials*** — **Pillows** — Max 9 in. (229 mm) long by 6 in. (152 mm) wide by 2 and 3 in. (51 and 76 mm) thick plastic covered pillows tightly-packed to fill annular space between penetrants and periphery of opening. Pillows installed with 9 in. (229 mm) dimension projecting through wall and centered within the opening.
3M COMPANY 3M FIRE PROTECTION PRODUCTS — Fire Barrier Pillow or Fire Barrier Self-Locking Pillows
 - B. **Fill, Void or Cavity Material*** — **Foam** — Applied around and between all round interior penetrants, and between round penetrants, rectangular penetrants, and pillows where the annular space is 3 in. or less. Foam to be applied the entire depth of, and flush with both surfaces of wall. After installation of pillows (Item 3A) all voids within the opening shall be filled with a min 1 in. (25 mm) thickness foam.
3M COMPANY 3M FIRE PROTECTION PRODUCTS — Fire Barrier Rated Foam, FIP 1-Step

*Bearing the UL Classification Mark

Reprinted from the Online Certifications Directory with permission from UL

© 2014 UL LLC



Combos • Gypsum

| 3M UL Systems | "F" Rating | 3M Product | Through Penetrant Details |
|---------------|------------|---|---|
| W-L-8002 | 2 | 3M™ Fire Barrier Sealant CP 25WB+ 3M™ Fire Barrier Sealant IC 15WB+ 3M™ Fire Barrier Sealant FD 150+ 3M™ Fire Barrier Composite Sheet CS-195+ 3M™ Fire Barrier Wrap Strips FS-195+ 3M™ Expantrol™ Flexible Intumescent Strip E-FIS 3M™ Fire Barrier Water Tight Sealant 3000 WT | 2" steel, 2" EMT, 2" copper, 2" rigid steel conduit, 2" or 2" schedule 40PVC. All may be closed or vented. Framed opening max 22-1/2" wide and 8" high. If PVC included, must maintain 2" between PVC and nearest metal pipe. Min 1" between pipe/conduit and periphery of opening. Metallic pipes in close proximity can be commonly wrapped. 2 hour F Rating. Also known as WL8002. |
| W-L-8010 | 1, 2 | 3M™ Fire Barrier Sealant CP 25WB+ 3M™ Fire Barrier Sealant IC 15WB+ 3M™ Fire Barrier Wrap Strips FS-195+ | 2" steel, EMT, copper: 1" fiberglass, 3/4" AB/PVC flexible foam. Also referred as WL8010. |
| W-L-8018 | 1, 2 | 3M™ Fire Barrier Sealant CP 25WB+ 3M™ Fire Barrier Sealant IC 15WB+ 3M™ Fire Barrier Moldable Putty Stix MP+ | 1" copper, 1 comm cable: 3/4" AB/PVC insulation. Also referred as WL8018. |
| W-L-8021 | 1, 2 | 3M™ Fire Barrier Sealant CP 25WB+ 3M™ Fire Barrier Sealant IC 15WB+ 3M™ Fire Barrier Wrap Strips FS-195+ | 3/4" steel pipe, EMT, conduit, copper tubing or pipe, 1/4" PVC, CPVC or PVC conduit, or 7 conductor, 12 AWG power cable, 1/2" fiberglass insulation. Also referred as WL8021. |
| W-L-8022 | 1, 2 | 3M™ Fire Barrier Water Tight Sealant 1000 NS | 585 sq. in. maximum opening, 6" steel pipe, copper tubing or pipe, 4" EMT or steel conduit, 1-1/2" mineral fiber insulation. Also referred as WL8022. |
| W-L-8033 | 1, 2 | 3M™ FireDam™ Spray 200 | Various steel, cable trays, insulated pipes see systems. Also referred as WL8033. |
| W-L-8034 | 1, 2 | 3M™ Fire Barrier Sealant CP 25WB+ 3M™ Fire Barrier Moldable Putty Stix MP+ 3M™ FireDam™ Spray 200 | Various steel, cable trays, insulated pipes see systems. Also referred as WL8034. |
| W-L-8039 | 1, 2 | 3M™ Fire Barrier Sealant CP 25WB+ 3M™ Fire Barrier Sealant IC 15WB+ | Multiple 1" copper tubing or pipe, steel, 7/C 12 gauge, 3/4" AB/PVC flexible foam. Also referred as WL8039. |
| W-L-8049 | 1, 2 | 3M™ Fire Barrier Sealant CP 25WB+ 3M™ Fire Barrier Sealant IC 15WB+ | Max. (4) AC line sets through max. 58 sq. in. with max. dimension of 14-1/2". Also referred as WL8049. |
| W-L-8069 | 1, 2, 3, 4 | 3M™ Fire Barrier Pass-Through Products 3M™ Fire Barrier Water Tight Sealant 3000 WT 3M™ Fire Barrier Sealant CP 25WB+ 3M™ Fire Barrier Sealant IC 15WB+ 3M™ Fire Barrier Moldable Putty Stix MP+ | Square device: max area 56-1/4 sq. in. w/max dimension 12-1/2 in. Round device: max opening 4-1/2 in. One or more penetrants each device w/ concentric or eccentric installation. Max 3 in. steel, max 3 in. iron, max 3 in. copper, max 1/2 in. AB/PVC, 1 in. PVC (closed or vented), 1 in. CPVC (closed), 1 in. RNC, 1 in. ENT, 1 in. raceway. AC line set. Max 6 sq. devices ganged. 1 & 2 hour F. Also known as WL8069. |
| W-L-8077 | 1, 2 | 3M™ Fire Barrier Pillows 3M™ Fire Barrier Self-Locking Pillows 3M™ Fire Barrier Moldable Putty Stix MP+ | Max two max 4 in. diam cable bundles, max one non-metallic optical fiber raceway. Max opening 8 in. x 16 in. Framed opening. See system for cable descriptions. 1 & 2 hour F Rating. Also known as WL8077. |
| W-L-8097 | 1, 2 | 3M™ Fire Barrier Water Tight Sealant 3000 WT 3M™ Fire Barrier Sealant CP 25WB+ 3M™ Fire Barrier Sealant IC 15WB+ | Max 6 in. steel tube, max six 3/8 in. diam two pair 22 AWG communication cables. Optional sleeve. U400, V400 or W400 series gypsum wallboard assembly. Max 7 in. opening. Min 1/4 in. to max 1-3/4 in. annular space. Penetrant spacing point contact to max 1 in. 1 and 2 hour F rating. Also known as WL8097. |
| W-L-8100 | 1, 2 | 3M™ Fire Barrier Pillows 3M™ Fire Barrier Self-Locking Pillows 3M™ Fire Barrier Rated Foam FIP 1-Step | 1 or 2 hour fire rated gypsum wallboard/stud assembly constructed to U400, V400, or W400 designs with max 36 in. by 36 in. opening. Max 20, nom 4 in. EMT or steel conduit. Nom 6 in. Sch. 10 steel pipe. Nom 6 in. by 12 in. 26 ga steel duct. Nom 4 in. 28 ga steel duct. Nom 3 in. service weight cast iron pipe. Max W8 x 15 steel beam. Nom 4 in. sq. steel tube. Nom 6 in. type L copper pipe. Nom 1 in. E |
| W-L-8102 | 1, 2 | 3M™ Fire Barrier Sealant CP 25WB+ 3M™ Fire Barrier Water Tight Sealant 3000 WT | Maximum 3 in. metallic penetrants and maximum 2 in. plastic penetrants with fiberglass or AB/PVC insulation or cables penetrating a maximum 182 sq. in. opening in a gypsum wallboard assembly |
| W-L-8106 | 1, 2 | 3M™ Fire Barrier Block 3M™ Fire Barrier Plank 3M™ Fire Barrier Rated Foam FIP 1-Step 3M™ Fire Barrier Tuck-In Wrap Strips | Gypsum wallboard assembly with max 8 in. Steel or Iron pipe, max 4 in. Copper pipe, copper Tubing, and Conduit. Nominal 1-1/2 in. Fiberglass insularion on metallic penetrants. Max 4 in. PCV and CPVC, Cable Tray and Cable Bundle penetrating a concrete wall or floor through a 900 sq. in. opening with a max 30 in. dimension. |
| W-L-8107 | 1, 2 | 3M™ Fire Barrier Sealant CP 25WB+ 3M™ Fire Barrier Sealant IC 15WB+ 3M™ Fire Barrier Water Tight Sealant 3000 WT | Grouping of steel beams penetrating a gypsum wallboard assembly together. |
| W-L-8109 | 1, 2 | 3M™ Fire Barrier Sealant CP 25WB+ 3M™ Fire Barrier Water Tight Sealant 3000 WT | Metallic pipes and conduits, cable bundles, cable trays, aluminum and steel busway, PVC/CPVC pipes, AC linesets, steel ducts, and insulated pipes penetrating a gypsum wallboard assembly. Max. 1024 square inch opening, max. 32 inch dimension. |

System No. W-L-8002

May 19, 2005

F Rating – 2 Hr

T Ratings – 0, 1 and 1-1/2 Hr (See Item 2)

L Rating At Ambient – 2 CFM/sq ft

L Rating At 400 F – less than 1 CFM/sq ft

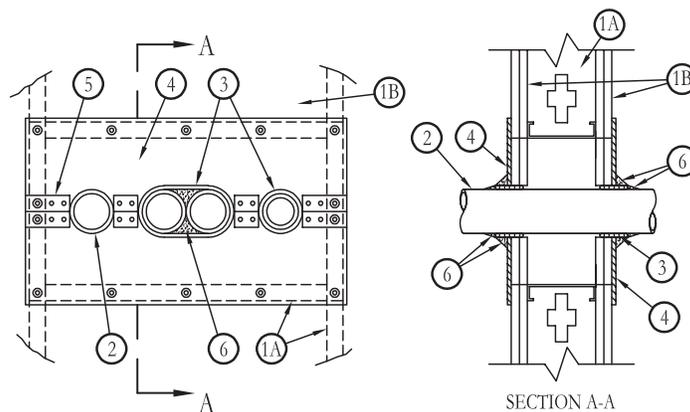

- Wall Assembly** – The Fire-rated gypsum board/steel stud wall assembly shall be constructed of the materials and in the manner described in the individual U400 or V400 Series Wall and Partition Design in the UL Fire Resistance Directory and shall include the following construction features:
 - Steel Studs** – Steel studs to be min 3-5/8 in. (92 mm) deep and spaced max 24 in. (610 mm) OC. The opening in the wall to accommodate the pipes and/or conduits (Item 2) shall be framed on all sides using lengths of steel stud installed between the vertical studs and screw-attached to the steel studs at each end. The framed opening in the wall shall be max 22-1/2 in. (572 mm) wide and 8 in. (203 mm) high.
 - Gypsum Board*** – Two layers of nom 5/8 in. (16 mm) thick gypsum board, as specified in the individual Wall and Partition Design.
- Pipe or Conduit** – Nom 2 in. (51 mm) diam (or smaller) Schedule 10 (or heavier) steel pipe, rigid steel conduit, steel EMT, Type L (or heavier) copper pipe or Schedule 40 polyvinyl chloride (PVC) pipe. Pipes may be for closed (process or supply) or vented (drain, waste or vent) piping systems. When PVC pipes are included in same opening with metallic pipes or conduits, a min separation of 2 in. (51 mm) shall be maintained between PVC pipe and nearest metal pipe. A min separation of 1 in. (25 mm) shall be maintained between pipe or conduit and periphery of opening. Pipes and conduits to be rigidly supported on both sides of wall assembly. **When copper pipe is used, T Rating is 0 hr. When steel pipe is used, T Rating is 1 hr. When PVC pipe is used, T Rating is 1-1/2 hr.**
- Fill, Void or Cavity Materials* – Wrap Strip** – Nom 1/4 in. (6 mm) thick intumescent elastomeric material faced on one side with aluminum foil, supplied in nom 2 in. (51 mm) wide strips. Nom 2 in. (51 mm) wide wrap strip tightly-wrapped around each PVC pipe (foil side exposed) and secured in place with steel wire ties. When two metallic pipes or conduits are in close proximity or in contact with one another such that the intumescent sheet (Item 4) can not readily be cut to follow their contours, a nom 2 in. (51 mm) wide wrap strip shall be tightly-wrapped around the two pipes and secured with steel wire ties. Wrap strips to project approx 7/8 in. (22 mm) beyond each face of the intumescent sheet (Item 4) on each side of wall. When diam of circular cutout in intumescent sheet is max 1/4 in. (6 mm) larger than diam of metallic pipe or conduit, no wrap strip is required on pipe or conduit.

3M COMPANY – FS-195+
- Fill, Void or Cavity Materials* – Intumescent Sheet** – Rigid aluminum foil-faced sheet with galv sheet steel backer. Sheets cut to tightly-follow the contours of the individual metallic pipe or conduit or the wrap strip (Item 3) on the PVC pipe or grouped metallic pipes. Sheets cut to lap a min of 2 in. (51 mm) on the wall on all sides of the opening on both sides of the wall. Prior to installation, a min 1/4 in. (6 mm) diam bead of caulk (Item 6) shall be applied as a gasket approx 1 in. (25 mm) from and on all sides of the through opening. Sheet to be installed with the galv steel sheet backer exposed (aluminum foil facing against wall surface) and secured to steel framing, through gypsum board layers, with min 1/4 in. (6 mm) diam by 2-1/4 in. (57 mm) long steel screws in conjunction with min 1-1/4 in. (32 mm) diam steel fender washers. Max spacing of fasteners not to exceed 6 in. (152 mm) with additional fasteners located on each side of butted seams or slits made to permit installation of the sheet around the pipes or conduits.

3M COMPANY – CS-195+
- Steel Cover Strip** – Min 2 in. (51 mm) wide strip of min 0.020 in. (0.51 mm) thick (26 gauge) galv steel centered over entire length of each butted seam or slit made in the intumescent sheet (Item 4). Prior to installation of the steel strip, the seam or slit in the intumescent sheet shall be covered with a nom 1/4 in. (6 mm) diam bead of caulk (Item 6). Steel cover strip secured to galv steel sheet backer of intumescent sheet with steel sheet metal screws or steel rivets spaced max 3 in. (76 mm) OC on each side of seam or slit.
- Fill, Void or Cavity Materials* – Caulk or Sealant** – Generous application of caulk to be applied around base of pipe or wrap strip at its egress from the intumescent sheet on each side of wall. An additional bead of caulk shall be applied to the exposed edge of each wrap strip layer. When two metallic pipes or conduits are grouped tightly together and enclosed in a single wrap strip, pieces of mineral wool batt packing material shall be installed inside wrap strip layer and a min 1 in. (25 mm) depth of caulk shall be installed to fill all interstices between the pipes within the confines of the wrap strip.

3M COMPANY – CP 25WB+, IC 15WB+, FireDam 150+ caulk or FB-3000 WT sealant

*Bearing the UL Classification Marking

Reprinted from the Online Certifications Directory with permission from Underwriters Laboratories Inc.

Copyright © 2010 Underwriters Laboratories Inc.®



Note: Systems with Nonmetallic Through Penetrant(s) have not been evaluated with a pressure differential of 50 Pa between the exposed and unexposed surfaces as required by the National Building Code of Canada.

System No. W-L-8010

May 19, 2005

F Ratings – 1 & 2 Hr (See Item 1)

T Ratings – 1/4, 3/4, 1, 1-1/2 and 1-3/4 Hr (See Items 2 & 3)

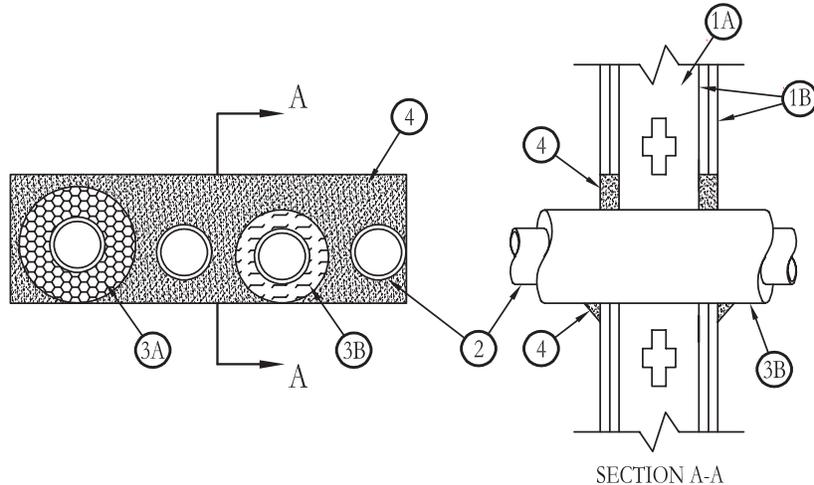

SECTION A-A

- Wall Assembly** – The 1 or 2 hr fire-rated gypsum board/stud wall assembly shall be constructed of the materials and in the manner specified in the individual U300, U400 or V400 Series Wall and Partition Designs in the UL Fire Resistance Directory and shall include the following construction features:

- Studs** – Wall framing may consist of either wood studs or steel channel studs. Wood studs to consist of nom 2 in. by 4 in. (51 mm to max 102 mm) lumber spaced 16 in. (406 mm) OC. Steel studs to be min 3-5/8 in. (92 mm) wide and spaced max 24 in. (610 mm) OC.
- Gypsum Board*** – Nom 5/8 in. (16 mm) thick gypsum board, as specified in the individual Wall and Partition Design. Max area of opening is 65-1/4 sq in. (421 cm²) with max dimension of 14-1/2 in. (368 mm).

The hourly F Rating of the firestop system is equal to the hourly fire rating of the wall assembly.

- Through Penetrants** – A max of four pipes, conduits or tubing to be installed within the opening. The space between pipes, conduits or tubing shall be min 1/2 in. to max 1-5/16 in. (13 mm to max 33 mm). The space between pipes, conduits or tubing and periphery of opening shall be min 1-3/16 in. (30 mm) for uninsulated copper tubes and copper pipes (Items 2C and 2D) and 0 in. (point contact) for insulated copper tubes and copper pipes and uninsulated steel pipes and conduit (Item 2B). The space between pipes, conduits or tubing and periphery of opening shall be max 1-5/16 in. (33 mm). Pipe, conduit or tubing to be rigidly supported on both sides of floor or wall assembly. The following types and sizes of metallic pipes, conduits or tubing may be used:

- Steel Pipe** – Nom 2 in. (51 mm) diam (or smaller) Schedule 5 (or heavier) steel pipe.
- Conduit** – Nom 2 in. (51 mm) diam (or smaller) steel electrical metallic tubing or steel conduit.
- Copper Tubing** – Nom 2 in. (51 mm) diam (or smaller) Type L (or heavier) copper tubing.
- Copper Pipe** – Nom 2 in. (51 mm) diam (or smaller) Regular (or heavier) copper pipe.

When uninsulated steel pipe or conduit is used, T Rating is 3/4 hr and 1-1/2 hr for 1 and 2 hr rated assemblies, respectively.

When uninsulated copper tubing or pipe is used, T Rating is 1/4 hr for both 1 and 2 hr rated assemblies.

- Pipe Covering*** (Optional) – Nom 1 in. (25 mm) hollow cylindrical heavy density glass fiber units jacketed on the outside with an all service jacket. Longitudinal joints sealed with metal fasteners or factory-applied self-sealing lap tape. Transverse joints secured with metal fasteners or with butt tape supplied with the product.

See **Pipe and Equipment Covering – Materials*** (BRGU) category in the Building Materials Directory for names of manufacturers. Any pipe covering material meeting the above specifications and bearing the UL Classification Marking with a Flame Spread Index of 25 or less and a Smoke Developed Index of 50 or less may be used.

When pipe covering is used on all through penetrants, T Rating is 1 hr and 1-3/4 hr for 1 and 2 hr rated assemblies, respectively.

- Tube Insulation – Plastics#** (Optional) – Nom 3/4 in. (19 mm) thick acrylonitrile butadiene/polyvinyl chloride (AB/PVC) flexible foam furnished in the form of tubing.

See **Plastics** (QMFZ2) category in the Recognized Component Directory for names of manufacturers. Any Recognized Component tube insulation material meeting the above specifications and having a UL94 Flammability Classification of 94-5VA may be used.

When tube insulation is used on all through penetrants, T Rating is 3/4 hr and 1-1/2 hr for 1 and 2 hr rated assemblies, respectively.

- Fill, Void or Cavity Material* – Caulk or Sealant** – Min 5/8 in. or 1-1/4 in. (16 mm or 32 mm) thickness of fill material, for 1 or 2 hr walls, respectively, applied within the annulus, flush with both surfaces of wall. At point contact locations, a min 1/2 in. (13 mm) diam bead of fill material shall be applied at the wall/pipe and wall/pipe insulation interface on both surfaces of wall.

3M COMPANY– CP 25WB+, IC 15WB+ caulk or FB-3000 WT sealant

- Fill, Void or Cavity Materials* – Wrap Strip** (Not Shown) – Min one layer of 2 in. (51 mm) wide, nom 1/4 in. (6 mm) thick intumescent elastomeric material faced on one side with aluminum foil, required only when tube insulation (Item 3B) is used in 2 hr rated assemblies. Wrap strip tightly wrapped around tube insulation (foil side exposed) within the opening on both sides of the wall, flush with both surfaces of the wall assembly.

3M COMPANY – FS-195+

#Bearing the UL Recognized Component Mark

*Bearing the UL Classification Marking

Reprinted from the Online Certifications Directory with permission from Underwriters Laboratories Inc.

Copyright © 2010 Underwriters Laboratories Inc.®



System No. W-L-8018

May 19, 2005

F Rating - 1 and 2 Hr (See Item 1)

T Rating - 0 and 3/4 Hr (See Item 1)

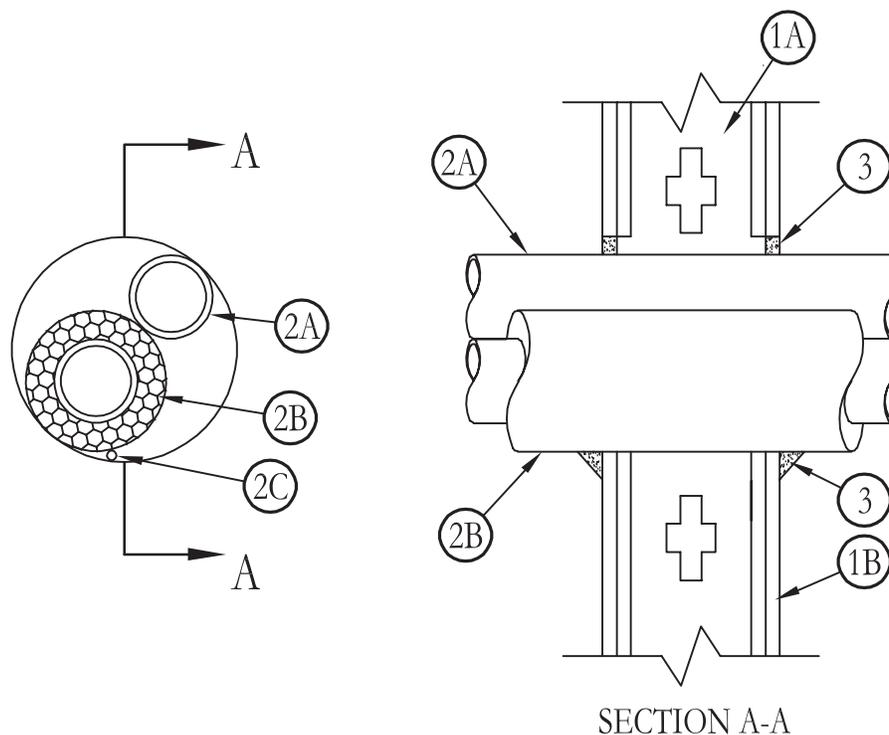

1. **Wall Assembly** – The 1 or 2 hr fire rated gypsum board/stud wall assembly shall be constructed of the materials and in the manner specified in the individual U400 or V400 Series Wall and Partition Design in the UL Fire Resistive Directory and shall include the following construction features.

- A. **Studs** – Wall framing may consist of either wood studs or steel channel studs. Wood studs to consist of nom 2 in. by 4 in. (51 mm by 102 mm) lumber spaced 16 in. (406 mm) OC. Steel studs to be min 2-1/2 in. (64 mm) wide steel channel studs spaced max 24 in. (610 mm) OC.
- B. **Gypsum Board*** – Thickness, type, number of layers and fasteners as required in the individual Wall and Partition Design. Max diam of opening is 4 in. (102 mm).

The hourly F Rating of the firestop system is equal to the hourly rating of the wall assembly. The hourly T Rating of the firestop system is 0 and 3/4 Hr for 1 and 2 Hr rated assemblies, respectively.

2. **Through Penetrants** – Penetrants to be installed either concentrically or eccentrically within the firestop system. The annular space between penetrants shall be min 0 in. (point contact) to max 1-1/2 in. (0 mm to max 38 mm). The annular space between penetrants and periphery of opening shall be min 0 in. (point contact) to max 1-1/4 in. (0 mm to max 32 mm). Penetrants to be rigidly supported on both sides of wall assembly. The following types and sizes of penetrants may be used:

- A. **Metallic Pipes** – Max two metallic pipes or tubing. The following types and sizes of metallic pipes or tubing may be used:

A1. **Copper Tubing** – Nom 1 in. (25 mm) diam (or smaller) Type M (or heavier) copper tube.

A2. **Copper Pipe** – Nom 1 in. (25 mm) diam (or smaller) Regular (or heavier) copper pipe.

- B. **Tube Insulation*** – **Plastics+** – Nom 3/4 in. (19 mm) thick acrylonitrile butadiene/polyvinyl chloride (AB/PVC) flexible foam furnished in the form of tubing. Tube insulation required for all copper tubes and pipes greater than nom 3/4 in. (19 mm) diam. See **Plastics** (QMFZ2) category in the Recognized Component Directory for names of manufacturers. Any Recognized Component tube insulation material meeting the above specifications and having a UL 94 Flammability Classification of 94-5VA may be used.

- C. **Cables** – Max one 2/C No. 18 AWG (or smaller) control cable with polyvinyl chloride (PVC) insulation and jacket. Cable to be rigidly supported on both sides of floor or wall assembly.

3. **Fill, Void or Cavity Materials*** – **Caulk, Sealant or Putty** – Min 5/8 in. (16 mm) thickness of fill material applied within the annulus, flush with both surfaces of the wall. Min 1/2 in. (13 mm) diam bead of fill material applied to the wallboard/penetrant interface at point contact location on both surfaces of wall.

3M COMPANY – CP 25WB+, IC 15WB+ caulk, FB-3000 WT sealant or MP+ Stix putty

*Bearing the UL Classification Marking

+Bearing the UL Recognized Component Mark

Reprinted from the Online Certifications Directory with permission from Underwriters Laboratories Inc.
Copyright © 2010 Underwriters Laboratories Inc.®



System No. W-L-8021

May 19 2005

F Ratings – 1 or 2 Hr (See Item 1)

T Ratings – 1/4, 3/4, 1, 1-1/4 & 2 Hr (See Items 2 & 3)

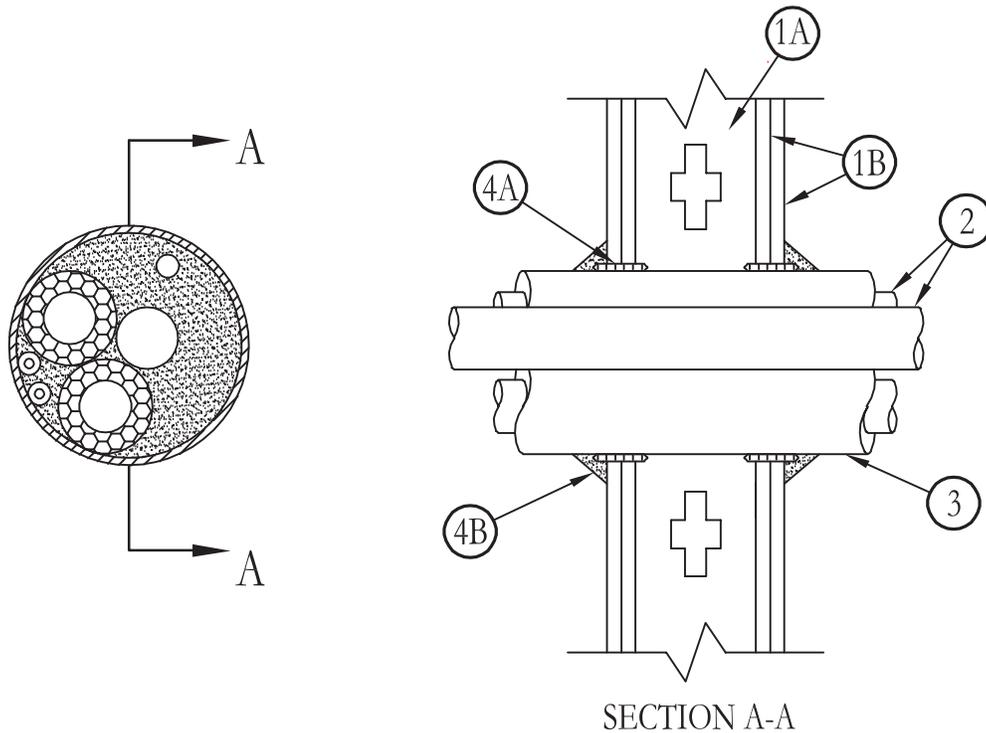

- Wall Assembly** – The 1 or 2 hr fire-rated gypsum board/stud wall assembly shall be constructed of the materials and in the manner specified in the individual U300, U400 or V400 Series Wall and Partition Designs in the UL Fire Resistance Directory and shall include the following construction features:

- Studs** – Wall framing may consist of either wood studs or steel channel studs. Wood studs to consist of nom 2 in. by 4 in. (51 mm to max 102 mm) lumber spaced 16 in. (406 mm) OC. Steel studs to be min 3-5/8 in. (92 mm) wide and spaced max 24 in. (610 mm) OC.
- Gypsum Board*** – Nom 5/8 in. (16 mm) thick gypsum board, as specified in the individual Wall and Partition Design. Max diam of opening is 4-1/2 in. (114 mm).

The hourly F Rating of the firestop system is equal to the hourly fire rating of the wall assembly.

- Through Penetrants** – Pipes, conduits, tubing or cables to be bundled within the opening such that the aggregate cross-sectional area of penetrants in opening to be max 54 percent of the cross-sectional area of the opening in wall assembly. A min 1/4 in. (6 mm) annular space shall be maintained around uninsulated metallic pipes. The annular space between penetrants and periphery of opening shall be min 1/4 in. to max 1 in. (6 mm to max 25 mm). Penetrants to be rigidly supported on both sides of floor or wall assembly. The following types and sizes of penetrants may be used:

- Metallic Pipes** – The following types and sizes of metallic pipes, conduits or tubing may be used:
 - Steel Pipe** – Nom 3/4 in. (19 mm) diam (or smaller) Schedule 5 (or heavier) steel pipe.
 - Conduit** – Nom 3/4 in. (19 mm) diam (or smaller) steel electrical metallic tubing or steel conduit.
 - Copper Tubing** – Nom 3/4 in. (19 mm) diam (or smaller) Type L (or heavier) copper tubing.
 - Copper Pipe** – Nom 3/4 in. (19 mm) diam (or smaller) Regular (or heavier) copper pipe.
- Nonmetallic Pipes** – A max of one nonmetallic pipe or conduit may be used. The following types and sizes of nonmetallic pipes or conduits may be used:
 - Polyvinyl Chloride (PVC) Pipe** – Nom 1-1/4 in. (32 mm) diam (or smaller) Schedule 40 solid core PVC pipe for use in closed (process or supply) or vented (drain, waste or vent) piping system.
 - Chlorinated Polyvinyl Chloride (CPVC) Pipe** – Nom 1-1/4 in. (32 mm) diam (or smaller) SDR13.5 CPVC pipe for use in closed (process or supply) piping systems.
 - Rigid Nonmetallic Conduit++** – Nom 1-1/4 in. (32 mm) diam (or smaller) Schedule 40 PVC conduit installed in accordance with Article 347 of the National Electrical Code (NFPA No. 70).
- Cables** – Max 7/C No. 12 AWG multi conductor power and control cables; XLPE or PVC insulation with XLPE or PVC jacket.

T Rating when uninsulated metallic pipes are used is 1/4 hr for both 1 and 2 hr rated assemblies. T Rating when cables are used is 3/4 hr for 1 and 2 hr rated assemblies. T Ratings when nonmetallic pipes are used are 1 and 2 hr for 1 and 2 hr rated assemblies, respectively.

System No. W-L-8021 *continued*

3. **Pipe Covering** – The following types and sizes of pipe coverings may be used with the metallic pipes:
- A. **Tube Insulation – Plastics+** – Nom 5/8 in. (16 mm) thick (or smaller) acrylonitrile butadiene/polyvinyl chloride (AB/PVC) flexible foam furnished in the form of tubing with skin may be used.
See **Plastics+** (QMFZ2) category in the Recognized Component Directory for names of manufacturers. Any Recognized Component tube insulation material meeting the above specifications and having a UL 94 Flammability Classification of 94-5VA may be used.
- B. **Pipe Covering*** – Nom 1/2 in. (13 mm) thick hollow cylindrical heavy density glass fiber units jacketed on the outside with an all service jacket. Longitudinal joints sealed with metal fasteners or factory-applied self-sealing lap tape. Transverse joints secured with metal fasteners or with butt tape supplied with the product. The annular space between the insulated pipe and the edge of the through opening shall be min 1/4 in. to max 1 in. (6 mm to max 25 mm).
See **Pipe and Equipment Covering – Materials*** (BRGU) category in the Building Materials Directory for names of manufacturers. Any pipe covering material meeting the above specifications and bearing the UL Classification Marking with a Flame Spread Index of 25 or less and a Smoke Developed Index of 50 or less may be used.

T Rating when insulated pipes are used is 3/4 hr and 1-1/4 hr for 1 and 2 hr rated assemblies, respectively.

4. **Firestop System** – The details of the firestop system shall be as follows:
- A. **Fill, Void or Cavity Materials* – Wrap Strip** – Min one layer of 2 in. (51 mm) wide, nom 1/4 in. (6 mm) thick intumescent elastomeric material faced on one side with aluminum foil. Wrap strip tightly wrapped around penetrant bundle (foil side exposed) and recessed within the opening on both sides of the wall such that approximately 1/2 in. (13 mm) of wrap strip extends beyond both surfaces of the wall assembly. Wrap strip held in place with foil tape.
3M COMPANY – FS-195+
- B. **Fill, Void or Cavity Material* – Caulk or Sealant** – Min 5/8 in. (16 mm) thickness of caulk, applied within the annulus between wrap strip and periphery of opening, flush with both surfaces of wall. Min 1 in. (25 mm) thickness of caulk, applied within the annulus between penetrants and between penetrants and wrap strip, flush with outer edge of wrap strip on both sides of wall. Min 1/2 in. (13 mm) diam bead of caulk applied at the wall/wrap strip interface on both surfaces of wall. Min 1/4 in. (6 mm) diam bead of caulk applied along the outer edge of the wrap strip on both sides of wall.
3M COMPANY – CP 25WB+, IC 15WB+ caulk or FB-3000 WT sealant
(Note: CP 25WB+ not suitable for use with CPVC pipes.)

*Bearing the UL Classification Marking

Reprinted from the Online Certifications Directory with permission from Underwriters Laboratories Inc.
Copyright © 2010 Underwriters Laboratories Inc.®



Note: This system was tested with a pressure differential of 50 Pa between the exposed and unexposed surfaces with the higher pressure on the exposed side.

System No. W-L-8022

September 07, 2004

F Ratings – 1 & 2 Hr (See Item 1)

T Ratings – 0, 1 & 1-1/4 Hr (See Item 2)

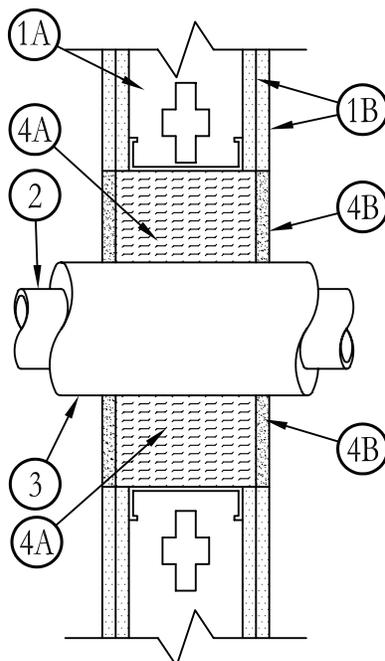
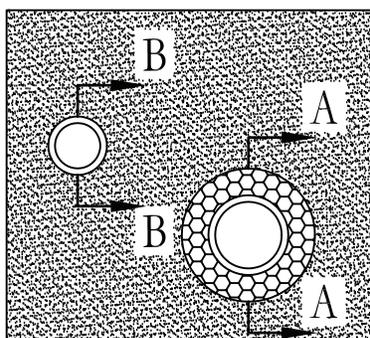

SECTION A-A
FIRESTOP
CONFIGURATION A

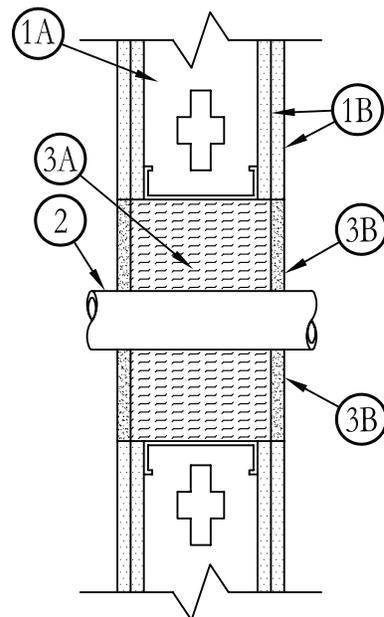

SECTION B-B
FIRESTOP
CONFIGURATION B

- Wall Assembly** – The 1 or 2 Hr fire-rated gypsum wallboard/stud wall assembly shall be constructed of the materials and in the manner specified in the individual U300 or U400 Series Wall and Partition Designs in the UL Fire Resistance Directory and shall include the following construction features:
 - Studs** – Wall framing may consist of either wood studs or steel channel studs. Wood studs to consist of nom 2 by 4 in. lumber spaced 16 in. OC. Steel studs to be min 3-1/2 in. wide and spaced max 24 in. OC for 1 Hr rated walls. Steel studs to be min 2-1/2 in. wide and spaced max 24 in. OC for 2 Hr rated walls.
 - Gypsum Board*** – One or two layers of nom 5/8 in. thick gypsum wallboard, as specified in the individual Wall and Partition Design. Max area of opening is 585 sq in. with max dimensions of 21 in. wide by 27-7/8 in. high.

The hourly F Rating of the firestop system is equal to the hourly rating of the wall.

- Through Penetrants** – The total number of through-penetrants is dependent on the size of the opening and types and sizes of the penetrants. Any combination of the penetrants described for the two firestop configurations below may be used provided that the following parameters relative to the annular spaces and the spacings between the pipes are maintained. The T Ratings for the various configurations are also shown below. Where multiple T Ratings are shown, additional details are provided within the description of the specific configuration:

| Firestop Config | T Rating Hr | Annular Space to Edge of Opening In. | | Min Spacing Between Configurations | |
|-----------------|-------------|--------------------------------------|-----|------------------------------------|-------------|
| | | Min | Max | Adjacent Config | Spacing In. |
| A1, 1-1/4 | 2 | 11-3/8 | B | 5-3/4 | |
| B0 | 3-1/4 | 7 | A | 5-3/4 | |

Firestop Configuration A

- Through Penetrants** – Metallic pipe, conduit or tubing installed within the firestop system. Pipe, conduit or tubing to be rigidly supported on both sides of wall assembly. The following types of pipe, conduit or tubing may be used:
 - Steel Pipe** – Nom 6 in. diam (or smaller) Schedule 30 (or heavier) steel pipe.
 - Copper Tubing** – Nom 6 in. diam (or smaller) Type L (or heavier) copper tubing.
 - Copper Pipe** – Nom 6 in. diam (or smaller) Regular (or heavier) copper pipe.
 - Conduit** – Nom 4 in. diam (or smaller) electrical metallic tubing (EMT) or steel conduit.

The T Rating is 1-1/4 Hr for nom 6 in. diam and smaller pipes. The T Rating is 1 Hr for pipes larger than nom 6 in. diam.

System No. W-L-8022 *continued*

3. **Pipe Covering*** – Nom 1 or 1-1/2 in. thick hollow cylindrical heavy density (min 7.0 pcf) mineral fiber units with an all service jacket. Longitudinal joints sealed with metal fasteners or factory-applied self-sealing lap tape. Transverse joints secured with metal fasteners or with butt tape supplied with the product.

See **Pipe and Equipment Covering – Materials*** (BRGU) category in the Building Materials Directory for names of manufacturers. Any pipe covering meeting the above specifications and bearing the UL Classification Marking with a Flame Spread Index of 25 or less and a Smoke Developed Index of 50 or less may be used.

4. **Firestop System** – The firestop system shall consist of the following:
- A. **Packing Material** – Min 4 in. thickness of min 4 pcf mineral wool batt insulation packed at 50 percent compression into opening as a permanent form. Packing material to be recessed from both surfaces of wall as required to accommodate the required thickness of fill material.
 - B. **Fill, Void or Cavity Material* – Sealant** – Min 3/8 in. thickness of fill material applied within the annular space between the pipe covering and the periphery of the opening, flush with both surfaces of wall.
3M COMPANY – FB-1000 NS or FB-3000 WT sealant

Firestop Configuration B

2. **Through Penetrants** – Metallic pipe, conduit or tubing installed within the firestop system. Pipe, conduit or tubing to be rigidly supported on both sides of wall assembly. The following types of pipe, conduit or tubing may be used:
- A. **Steel Pipe** – Nom 4 in. diam (or smaller) Schedule 5 (or heavier) steel pipe.
 - B. **Copper Tubing** – Nom 3 in. diam (or smaller) Type L (or heavier) copper tubing.
 - C. **Copper Pipe** – Nom 3 in. diam (or smaller) Regular (or heavier) copper pipe.
 - D. **Conduit** – Nom 4 in. diam (or smaller) electrical metallic tubing (EMT) or steel conduit.
3. **Firestop System** – The firestop system shall consist of the following:
- A. **Packing Material** – Min 4 in. thickness of min 4 pcf mineral wool batt insulation packed at 50 percent compression into opening as a permanent form. Packing material to be recessed from both surfaces of wall as required to accommodate the required thickness of fill material.
 - B. **Fill, Void or Cavity Material* – Sealant** – Min 3/8 in. thickness of fill material applied within the annular space between the pipe covering and the periphery of the opening, flush with both surfaces of wall.
3M COMPANY – FB-1000 NS or FB-3000 WT sealant

*Bearing the UL Classification Marking

Reprinted from the Online Certifications Directory with permission from Underwriters Laboratories Inc.
Copyright © 2010 Underwriters Laboratories Inc.®



System No. W-L-8033

January 31, 2006

F Ratings – 1 or 2 Hr (See Item 1b)

T Ratings – 0, 1 and 2 Hr (See Item 2)

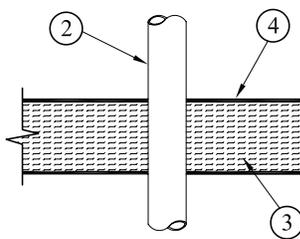
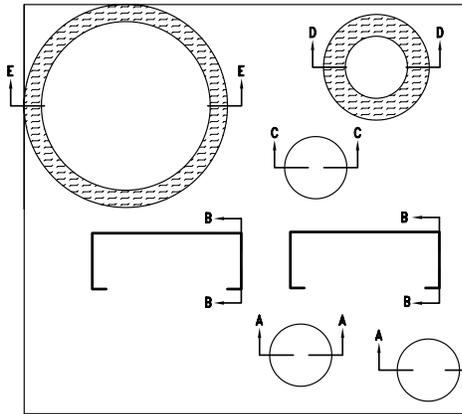
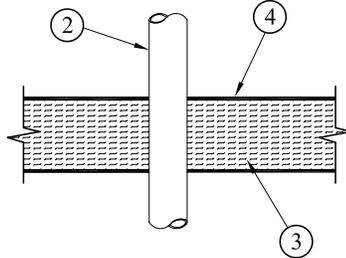
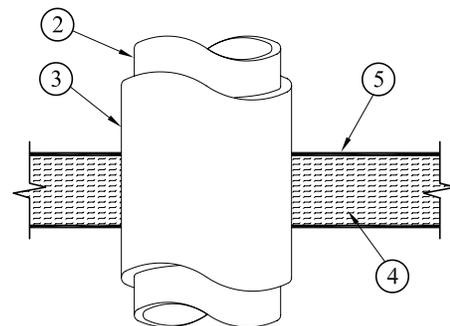
SECTION A-A
FIRESTOP
CONFIGURATION ASECTION B-B
FIRESTOP
CONFIGURATION B

SECTION E-E

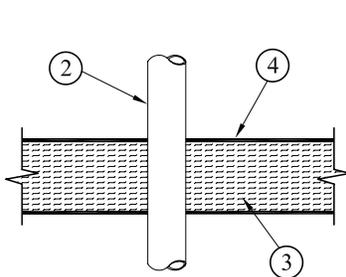
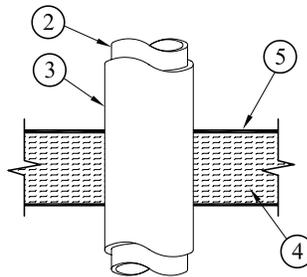
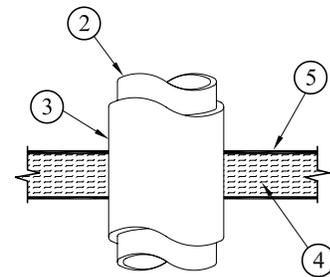
SECTION C-C
FIRESTOP
CONFIGURATION CSECTION D-D
FIRESTOP
CONFIGURATION DSECTION E-E
FIRESTOP
CONFIGURATION E

- Wall Assembly** – The 1 or 2 h fire-rated gypsum wallboard/stud wall assembly shall be constructed of the materials and in the manner specified in the individual U300, U400 and V400 Series Wall and Partition Designs in the UL Fire Resistance Directory and shall include the following construction features:

- Studs** – Wall framing may consist of either wood studs or steel channel studs. Wood studs to consist of nom 2 by 4 in. (51 by 102 mm) lumber spaced 16 in. (406 mm) OC. Steel studs to be min 3-5/8 in. (92 mm) wide and spaced max 24 in. (610 mm) OC.
- Gypsum Board** – One or two layers of nom 5/8 in. (16 mm) thick gypsum board as specified in the individual Wall and Partition Design. Max area of opening is 9 sq ft (0.84 m²) with max dimension of 36 in. (914 mm).

The hourly F Rating of the firestop system is equal to the hourly rating of the wall.

- Through Penetrants** – A max of five firestop configurations may be installed within the opening. The space between firestop configurations shall be min 5-3/4 in. (146 mm) to max 7 in. (178 mm). The space between firestop configurations and periphery of opening shall be min 0 in. (0 mm, point contact) to max 8 in. (203 mm). Conduit, tubing or cable tray to be rigidly supported on both sides of wall assembly. The T rating of the system is dependent on the firestop configuration as shown in the table below. The firestop system may consist of any single or combination of the following firestop configurations detailed herein:

| Firestop Configuration | T Rating |
|------------------------|----------------------|
| A, B, C | 0 |
| D | 0 and 1 (see item 3) |
| E | 0 and 2 (see item 3) |

System No. W-L-8033 *continued*

Firestop Configuration A

2. **Steel Conduit** – Nom 4 in. (102 mm) diam (or smaller) electrical metallic steel conduit. A max of two pipes to be installed within the firestop system. Conduit to be min 6 in. (152 mm) from other penetrants and edge of opening and rigidly supported on both sides of wall assembly.
3. **Forming Material** – Min 4 in. (102 mm) thickness of min 4 pcf (64 kg/m³) density mineral wool insulation compressed min 50 percent into the opening as a permanent form and recessed from both wall surfaces as required to accommodate the required thickness of fill material.
4. **Fill, Void or Cavity Material*** – Material spray-applied or brushed over the mineral wool forming material to a min 1/16 in. (1.6 mm) dry thickness (min 1/8 in. or 3.2 mm wet thickness) flush with both sides of wall assembly. Additional material is sprayed to a min height of 1/2 in. (13 mm) on penetrating items and to overlap both surfaces of wall by min 1/2 in. (13 mm).

3M COMPANY – FireDam™ Spray 200

Firestop Configuration B

2. **Cable Trays** – Max 12 in. (305 mm) wide by max 3-1/2 in. (89 mm) deep solid-back or open ladder galvanized steel cable tray with channel-shaped side rails formed of min 0.050 in. (1.3 mm) thick steel. Cable trays are provided with min. 0.050 in. (1.3 mm) thick steel rungs spaced a max of 12 in. (305 mm) OC or min 0.050 in. (1.3 mm) thick steel solid back. The cable tray is to be installed min 2-1/2 in. (64 mm) and max 8 in. (203 mm) from edge of opening and min 6 in. (152 mm) from any other cable tray or pipe. A max of two cable trays is permitted per opening.
3. **Forming Material** – Min 4 in. (102 mm) thickness of min 4 pcf (64 kg/m³) density mineral wool insulation compressed min 50 percent into the opening as a permanent form and recessed from both wall surfaces as required to accommodate the required thickness of fill material.
4. **Fill, Void or Cavity Material*** – Material spray-applied or brushed over the mineral wool forming material to a min 1/16 in. (1.6 mm) dry thickness (min 1/8 in. or 3.2 mm wet thickness) flush with both sides of wall assembly. Additional material is sprayed to a min height of 1/2 in. (13 mm) on penetrating items and to overlap both surfaces of wall by min 1/2 in. (13 mm).

3M COMPANY – FireDam™ Spray 200

Firestop Configuration C

2. **Copper Tubing** – Nom 4 in. (102 mm) diam (or smaller) Type M (or heavier) copper tubing. One tube to be installed within the firestop system. Tube to be min 6 in. (152 mm) from other penetrants and edge of opening and rigidly supported on both sides of wall assembly.
3. **Forming Material** – Min 4 in. (102 mm) thickness of min 4 pcf (64 kg/m³) density mineral wool insulation compressed min 50 percent into the opening as a permanent form and recessed from both wall surfaces as required to accommodate the required thickness of fill material.
4. **Fill, Void or Cavity Material*** – Material spray-applied or brushed over the mineral wool forming material to a min 1/16 in. (1.6 mm) dry thickness (min 1/8 in. or 3.2 mm wet thickness) flush with top both sides of wall assembly. Additional material is sprayed to a min height of 1/2 in. (13 mm) on penetrating items and to overlap both surfaces of wall by min 1/2 in. (13 mm).

3M COMPANY – FireDam™ Spray 200

Firestop Configuration D

2. **Copper Tubing** – Nom 4 in. (102 mm) diam (or smaller) Type M (or heavier) copper tubing. Copper tube to be wrapped with pipe covering material (Item 3), and rigidly supported on both sides of wall assembly. One pipe to be installed within the opening.
3. **Pipe Covering*** – Nom 1-1/2 in. (38 mm) thick hollow cylindrical mineral wool pipe insulation, min density 4 pcf (64 kg/m³). The pipe insulation is covered with an all service jacket. Longitudinal joints sealed with factory applied self-sealing lap tape. Transverse joints secured with butt tape supplied with the product. T rating is 0 hr when pipe covering is not used.

IIG MINWOOL L L C – High Temperature Pipe Insulation 1200, High Temperature Pipe Insulation BWT or High Temperature Pipe Insulation Thermaloc

4. **Forming Material** – Min 4 in. (102 mm) thickness of min 4 pcf (64 kg/m³) density mineral wool insulation compressed min 50 percent into the opening as a permanent form and recessed from both wall surfaces as required to accommodate the required thickness of fill material.
5. **Fill, Void or Cavity Material*** – Material spray-applied or brushed over the mineral wool forming material to a min 1/16 in. (1.6 mm) dry thickness (min 1/8 in. or 3.2 mm wet thickness) flush with both sides of wall assembly. Additional material is sprayed to a min height of 1/2 in. (13 mm) on penetrating items and to overlap both surfaces of wall by min 1/2 in. (13 mm).

3M COMPANY – FireDam™ Spray 200

Firestop Configuration E

2. **Steel Pipe** – Nom 16 in. (406 mm) diam (or smaller) Schedule 30 (or heavier) steel pipe. Pipe to be wrapped with pipe covering material (Item 3), and rigidly supported on both sides of wall assembly. One pipe to be installed within the opening.
3. **Pipe Covering*** – Nom 1-1/2 in. (38 mm) thick hollow cylindrical mineral wool pipe insulation, min density 4 pcf (64 kg/m³). The pipe insulation is covered with an all service jacket. Longitudinal joints sealed with factory applied self-sealing lap tape. Transverse joints secured with butt tape supplied with the product. T rating is 0 hr when pipe covering is not used.

IIG MINWOOL L L C – High Temperature Pipe Insulation 1200, High Temperature Pipe Insulation BWT or High Temperature Pipe Insulation Thermaloc

4. **Forming Material** – Min 4 in. (102 mm) thickness of min 4 pcf (64 kg/m³) density mineral wool insulation compressed min 50 percent into the opening as a permanent form and recessed from both wall surfaces as required to accommodate the required thickness of fill material.
5. **Fill, Void or Cavity Material*** – Material spray-applied or brushed over the mineral wool forming material to a min 1/16 in. (1.6 mm) dry thickness (min 1/8 in. or 3.2 mm wet thickness) flush with both sides of wall assembly. Additional material is sprayed to a min height of 1/2 in. (13 mm) on penetrating items and to overlap both surfaces of wall by min 1/2 in. (13 mm).

3M COMPANY – FireDam™ Spray 200

*Bearing the UL Classification Mark

Reprinted from the Online Certifications Directory with permission from Underwriters Laboratories Inc.
Copyright © 2010 Underwriters Laboratories Inc.®



System No. W-L-8034

January 31, 2006

F Ratings – 1 or 2 Hr (See Item 1b)

T Rating – 0 Hr

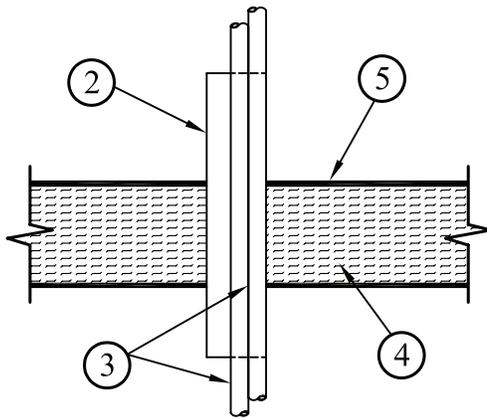
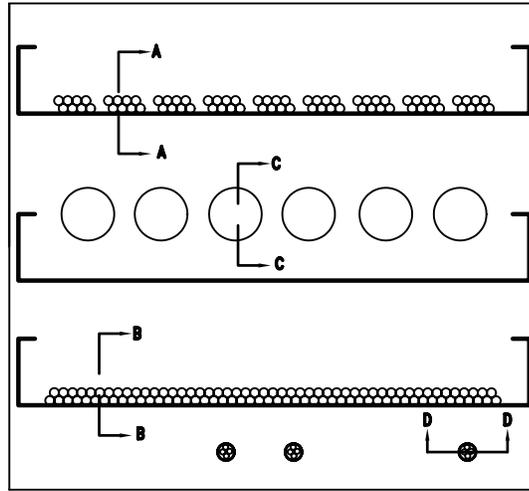

SECTION A-A
FIRESTOP
CONFIGURATION A

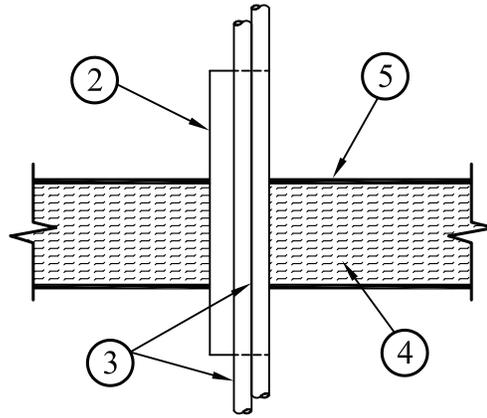

SECTION B-B
FIRESTOP
CONFIGURATION B

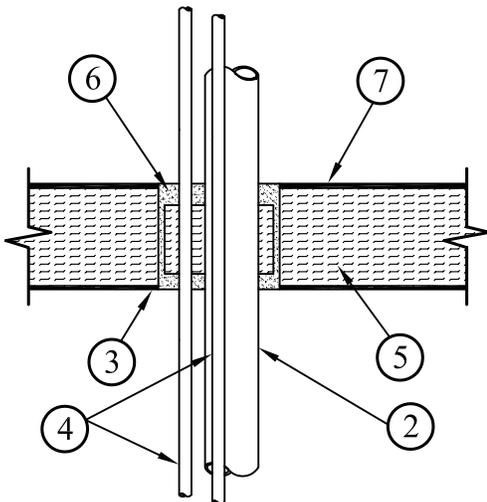

SECTION C-C
FIRESTOP
CONFIGURATION C

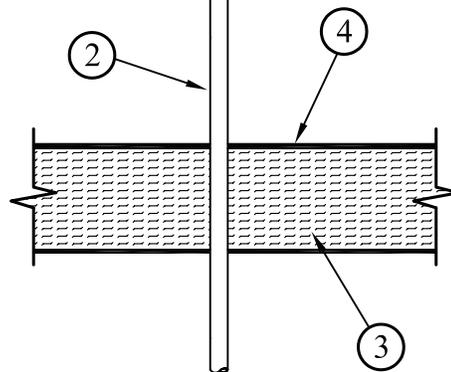

SECTION D-D
FIRESTOP
CONFIGURATION D

System No. W-L-8034 *continued*

1. **Wall Assembly** – The 1 or 2 hr fire-rated gypsum wallboard/stud wall assembly shall be constructed of the materials and in the manner specified in the individual U300, U400 or V400 Series Wall and Partition Designs in the UL Fire Resistance Directory and shall include the following construction features:
 - A. **Studs** – Wall framing may consist of either wood studs or steel channel studs. Wood studs to consist of nom 2 by 4 in. (51 by 102 mm) lumber spaced 16 in. (406 mm) OC. Steel studs to be min 3-5/8 in. (92 mm) wide and spaced max 24 in. (610 mm) OC.
 - B. **Gypsum Board** – One or two layers of nom 5/8 in. (16 mm) thick gypsum board as specified in the individual Wall and Partition Design. Max area of opening is 9 sq ft (0.84 m²) with max dimension of 36 in. (914 mm).

The hourly F Rating of the firestop system is equal to the hourly rating of the wall.

2. **Through Penetrants** – A max of four firestop configurations may be installed within the opening. The space between firestop configurations shall be min 5-3/4 in. (146 mm) to max 7 in. (178 mm). The space between firestop configurations and periphery of opening shall be min 0 in. (0 mm, point contact) to max 8 in. (203 mm). Pipe conduit, tubing or cable tray to be rigidly supported on both sides of wall assembly. The firestop system may consist of any single or combination of the following firestop configurations detailed herein:

Firestop Configuration A

2. **Cable Tray** – Max 36 in. (914 mm) wide by max 3-1/2 in. (89 mm) deep solid-back or open ladder galvanized steel cable tray with channel-shaped side rails formed of min 0.050 in. (1.3 mm) thick steel. Cable trays are provided with min. 0.050 in. (1.3 mm) thick steel rungs spaced a max of 12 in. (305 mm) OC or min 0.050 in. (1.3 mm) thick steel solid back. The cable tray is to be installed min 3/4 in. (19 mm) and max 6 in. (152 mm) from edge of opening and min 6 in. (152 mm) from any other cable tray or penetrants. One cable tray per opening.
3. **Cables** – Aggregate cross-sectional area of cables in cable trays to be max 40 percent of the cable tray based on a max 3 in. (76 mm) cable loading depth within the cable tray. Any combination of the following types and sizes of copper conductor cables may be used.
 - A. Max ten pieces of 2/C No.14 AWG cable with XLPE jacket and insulation
 - B. Max twenty pieces of 4/C No.14 AWG cable with XLPE jacket and insulation.
 - C. Max six pieces of 3/C No. 2 AWG cable with XLPE jacket and insulation.
 - D. Max six pieces of 4/C No. 6 AWG cable with XLPE jacket and insulation.
 - E. Max four pieces of 1/C 500MCM cable with XLPE jacket and insulation.
 - F. Max four pieces of 3/C 350 MCM cable with XLPE jacket and insulation.
 - G. Max four pieces of 1/C 750 MCM cable with XLPE jacket and insulation.
 - H. Max. ten pieces of 25 pair No 24 AWG Data Twist Communication cable.
4. **Forming Material** – Min 4 in. (102 mm) thickness of min 4 pcf (64 kg/m³) density mineral wool insulation compressed min 50 percent into the opening in between cables and cable tray as a permanent form and recessed from both wall surfaces as required to accommodate the required thickness of fill material.
5. **Fill, Void or Cavity Material*** – Material spray-applied or brushed over the mineral wool forming material to a min 1/16 in. (1.6 mm) dry thickness (min 1/8 in. or 3.2 mm wet thickness) flush with both sides of wall assembly. Additional material is sprayed to a min height of 1/2 in. (13 mm) on penetrating items and to overlap both surfaces of wall by min 1/2 in. (13 mm).

3M COMPANY – FireDam™ Spray 200
6. **Fill, void or Cavity Material* – Caulk or Sealant** – (Not shown) Caulk or sealant material installed to completely fill all the voids between cables and cable tray prior to the installation of the forming material (Item 4).

3M COMPANY – CP 25WB+ or FB-3000 WT Sealant

Firestop Configuration B

2. **Cable Trays** – Max 36 in. (914 mm) wide by max 2-1/2 in. (64 mm) deep solid-back or open ladder galvanized steel cable tray with channel-shaped side rails formed of min 0.050 in. (1.3 mm) thick steel. Cable trays are provided with min. 0.050 in. (1.3 mm) thick steel rungs spaced a max of 12 in. (305 mm) OC or min 0.050 in. (1.3 mm) thick steel solid back. The cable tray is to be installed min 3/4 in. (19 mm) and max 8 in. (203 mm) from edge of opening and min 6 in. (152 mm) from any other cable tray or pipe. One cable tray to be installed in the opening.
3. **Cables** – Aggregate cross-sectional area of cables in cable trays to be max 25 percent of the cable tray based on a max 3 in. (76 mm) cable loading depth within the cable tray. Any combination of the following types and sizes of copper conductor cables may be used.
 - A. Max ten pieces of 4/C No.6 AWG cable with XLPE jacket and insulation.
 - B. Max six pieces of 3/C No.2 AWG cable with XLPE jacket and insulation.
 - C. Max four pieces of 1/C 500 MCM cable with XLPE jacket and insulation.
 - D. Max ten pieces of 200 pair No. 24 AWG telephone cable.
4. **Forming Material** – Min 4 in. (102 mm) thickness of min 4 pcf (64 kg/m³) density mineral wool insulation compressed min 50 percent into the opening and between cables as a permanent form and recessed from both wall surfaces as required to accommodate the required thickness of fill material.
5. **Fill, Void or Cavity Material*** – Material spray-applied or brushed over the mineral wool forming material to a min 1/16 in. (1.6 mm) dry thickness (min 1/8 in. or 3.2 mm wet thickness) flush with both sides of wall assembly. Additional material is sprayed to a min height of 1/2 in. (13 mm) on penetrating items and to overlap both surfaces of wall by min 1/2 in. (13 mm).

3M COMPANY – FireDam™ Spray 200
6. **Fill, Void or Cavity Material* – Caulk or Sealant** – (Not shown) – Caulk or sealant material installed to completely fill all the voids between cables and cable tray prior to the installation of forming material (Item 4).

3M COMPANY – CP 25WB+ or FB-3000 WT Sealant

System No. W-L-8034 *continued*

Firestop Configuration C

2. **Cable Tray** – Max 36 in. (914 mm) wide by max 3-1/2 in. (89 mm) deep solid-back or open ladder galvanized steel cable tray with channel-shaped side rails formed of min 0.050 in. (1.3 mm) thick steel. Cable trays are provided with min. 0.050 in. (1.3 mm) thick steel rungs spaced a max of 12 in. (305 mm) OC or min 0.050 in. (1.3 mm) thick steel solid back. The cable tray is to be installed min 3/4 in. (19 mm) and max 8 in. (203 mm) from edge of opening and min 6 in. (152 mm) from any other cable tray or pipe. One cable tray to be installed in the opening.
3. **Nonmetallic Sleeve** – Nom 4 in. (102 mm) diam (or smaller) Schedule 40 PVC pipe. Sleeve installed with a nom 2 in. (51 mm) projection on both surfaces of wall. A max of six nonmetallic sleeves to be installed within the cable tray with a min of 1 in. (25 mm) between sleeves and from back of cable tray.
4. **Pipes, Conduit and Cables** – The following pipes, conduits and cables are installed within the nonmetallic sleeves (Item 3):
 - A. Max three pieces of 1 in. (25 mm) diam Schedule 40 nonmetallic conduit installed as a bundle and centered within nonmetallic sleeve. Max three pieces of Type 62.5/12.5 mm Fiber Optic cable can be installed in each nonmetallic conduit.
 - B. Nom 2 in. (51 mm) diam electrical metallic tube (EMT) centered within nonmetallic sleeve. One pipe max per opening.
 - C. Max nine pieces of Type 62.5/12.5 mm Fiber Optic cable installed as a bundle and centered within sleeve.
 - D. Max seven pieces of 2/C No. 14 AWG cable with XLPE jacket and insulation installed as a bundle and centered within sleeve.
 - E. Max seven pieces of 25 pairs No. 24 AWG DataTwist communication cable installed as a bundle and centered within sleeve.
 - F. Max three pieces of 200 pairs No. 24 AWG Telephone cable installed as a bundle and centered within sleeve.
5. **Forming Material** – Min 4 in. (102 mm) thickness of min 4 pcf (64 kg/m³) density mineral wool insulation compressed min 50 percent into the opening and within nonmetallic sleeve (Item 3) as a permanent form and recessed from both wall surfaces as required to accommodate the required thickness of fill material.
6. **Fill, Void or Cavity Material*** – Moldable putty material, installed within each of the nonmetallic sleeves (Item 4) to a min thickness of 1 in. (25 mm) on both sides of sleeve, flush with both surfaces of wall. Additional material is installed to form a min 1/4 in. (6 mm) high crown around the cables.

3M COMPANY – MP+ Moldable Putty
7. **Fill, Void or Cavity Material*** – Material spray-applied or brushed over the mineral wool forming material (Item 5) to a min 1/16 in. (1.6 mm) dry thickness (min 1/8 in. or 3.2 mm wet thickness) flush with both sides of wall assembly. Additional material is sprayed to a min height of 1/2 in. (13 mm) on penetrating items and to overlap both surfaces of wall by min 1/2 in. (13 mm).

3M COMPANY – FireDam™ Spray 200
8. **Fill, Void or Cavity Material*** – Ultra GS Intumescent Wrap – (Not shown) - Three layers of material wrapped around the Fiber Optic cable bundle (Item 4C) at mid depth of the wall prior to installation of the MP+ Moldable Putty (Item 6).

3M COMPANY – Ultra GS Intumescent Wrap

Firestop Configuration D

2. **Cables** – The following types of cable to be installed within the opening with min 4-3/8 in. (111 mm) between cables, edge of opening and other penetrants.
 - A. Max one piece of 3/C No. 6 AWG GP1 armored cable with XLPE jacket and insulation.
 - B. Max one piece of 3/C No. 2 AWG cable with XLPE jacket and insulation.
 - C. Max one piece of nom 1-1/4 in. (32 mm) diam Carlon Plenum Guard Optical Fiber Raceway with a max of three pieces of Type 62.5/12.5mm Fiber Optic cable.
3. **Forming Material** – Min 4 in. (102 mm) thickness of min 4 pcf (64 kg/m³) density mineral wool insulation compressed min 50 percent into the opening and between cables as a permanent form and recessed from both wall surfaces of wall as required to accommodate the required thickness of fill material.
4. **Fill, Void or Cavity Material*** – Material spray-applied or brushed over the mineral wool forming material to a min 1/16 in. (1.6 mm) dry thickness (min 1/8 in. or 3.2 mm wet thickness) flush with top surface of both sides of wall assembly. Additional material is sprayed to a min height of 1/2 in. (13 mm) on penetrating items and to overlap both surfaces of wall by min 1/2 in. (13 mm).

3M COMPANY – FireDam™ Spray 200

*Bearing the UL Classification Mark

Reprinted from the Online Certifications Directory with permission from Underwriters Laboratories Inc.
Copyright © 2010 Underwriters Laboratories Inc.®



System No. W-L-8039

May 19, 2005

F Ratings – 1 & 2 Hr (See Item 1)

T Ratings – 0 & 1/2 Hr (See Item 1)

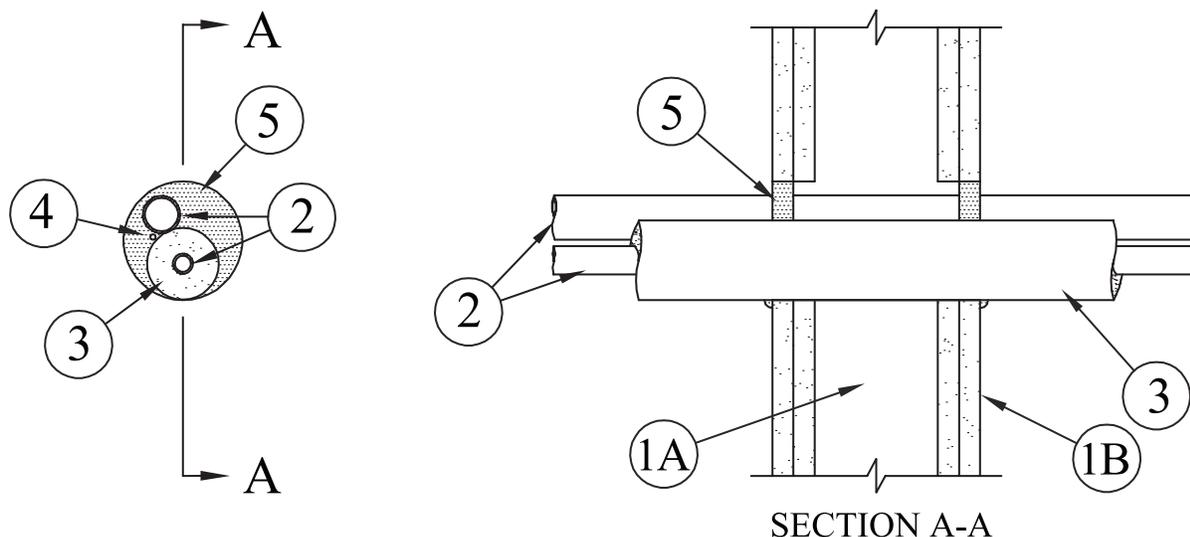

1. **Wall Assembly** – The 1 or 2 hr fire rated gypsum board/stud wall assembly shall be constructed of the materials and in the manner described in the individual U300, U400 or V400 Series Wall or Partition Design in the UL Fire Resistance Directory and shall include the following construction features:

- A. **Studs** – Wall framing may consist of either wood studs or steel channel studs. Wood studs to consist of nom 2 in. by 4 in. (51 mm by 102 mm) lumber spaced 16 in. (406 mm) OC. Steel studs to be min 3-1/2 in. (89 mm) wide spaced max 24 in. (610 mm) OC.
- B. **Gypsum Board*** – The gypsum board type, thickness, number of layers, fastener type and sheet orientation shall be as specified in the individual U300 or U400 Series Design in the UL Fire Resistance Directory. Max diam of opening is 4 in. (102 mm)

The hourly F Rating of the firestop system is equal to the hourly fire rating of the wall assembly in which it is installed. The hourly T Rating is 0 and 1/2 Hr for 1 and 2 Hr rated assemblies, respectively.

2. **Through Penetrants** – A max of two pipes or tubes and one cable installed eccentrically or concentrically within the opening. Annular space between penetrants and periphery of opening to be min 0 in. (point contact) to max 1-1/2 in. (0 mm to max 38 mm). Separation between penetrants to be min 0 in. (point contact) to max 1-1/2 in. (0 mm to max 38 mm). Penetrants to be rigidly supported on both sides of the wall. The following types and sizes of penetrants may be used:
 - A. **Copper Tubing** – Nom 1 in. (25 mm) diam (or smaller) Type L (or heavier) copper tubing.
 - B. **Copper Pipe** – Nom 1 in. (25 mm) diam (or smaller) Regular (or heavier) copper pipe.
 - C. **Steel Pipe** – Nom 1 in. (25 mm) diam (or smaller) Schedule 5 (or heavier) steel pipe.
 - D. **Cables** – Max 7/C No. 12 AWG multiconductor power and control cables; XLPE or PVC insulation with XLPE or PVC jacket.
3. **Tube Insulation-Plastics+** – Nom 3/4 in. (19 mm) thick (or less) acrylonitrile butadiene/polyvinyl chloride (AB/PVC) flexible foam furnished in the form of tubing. The tube insulation may be installed on a max of one pipe or tube. Annular space between the tube insulation and periphery of opening to be min 0 in. (point contact) to max 1-1/2 in. (0 mm to max 38 mm). Space between insulated and uninsulated penetrants to be 0 in. (point contact) to max 1-1/2 in. (0 mm to max 38 mm).

See **Plastics** (QMFF22) category in the Plastics Recognized Component Directory for names of manufacturers. Any Recognized Component tube insulation material meeting the above specifications and having a UL 94 Flammability Classification of 94-5A may be used.

4. **Cables** – Max two 7/C (or less) No. 12 AWG (or smaller) multiconductor power and control cables with XLPE or PVC insulation with XLPE or PVC jacket. Cables to be spaced min 0 in. (point contact) to max 1 in. (0 mm to max 25 mm) from the insulated through penetrants and min 1/2 in. to max 1 in. (13 mm to max 25 mm) from non-insulated through penetrants. The space between the cables and the periphery of the opening shall be min 0 in. (point contact) to max 1 in. (0 mm to max 25 mm). Cables to be rigidly supported on both sides of wall assembly.
5. **Fill, Void or Cavity Material* – Caulk or Sealant** – Min 5/8 in. (16 mm) thickness of caulk applied within annulus, flush with both surfaces of wall. Min 1/4 in. (6 mm) diam bead of caulk applied to gypsum board/penetrant interface at point contact location on both sides of wall.

3M COMPANY– CP 25WB+, IC 15WB+ caulk or FB-3000 WT sealant

* Bearing the UL Classification Marking

Reprinted from the Online Certifications Directory with permission from Underwriters Laboratories Inc.

Copyright © 2010 Underwriters Laboratories Inc.®



System No. W-L-8049

May 19, 2005

F Ratings – 1 & 2 Hr (See Item 1)

T Ratings - 3/4 Hr

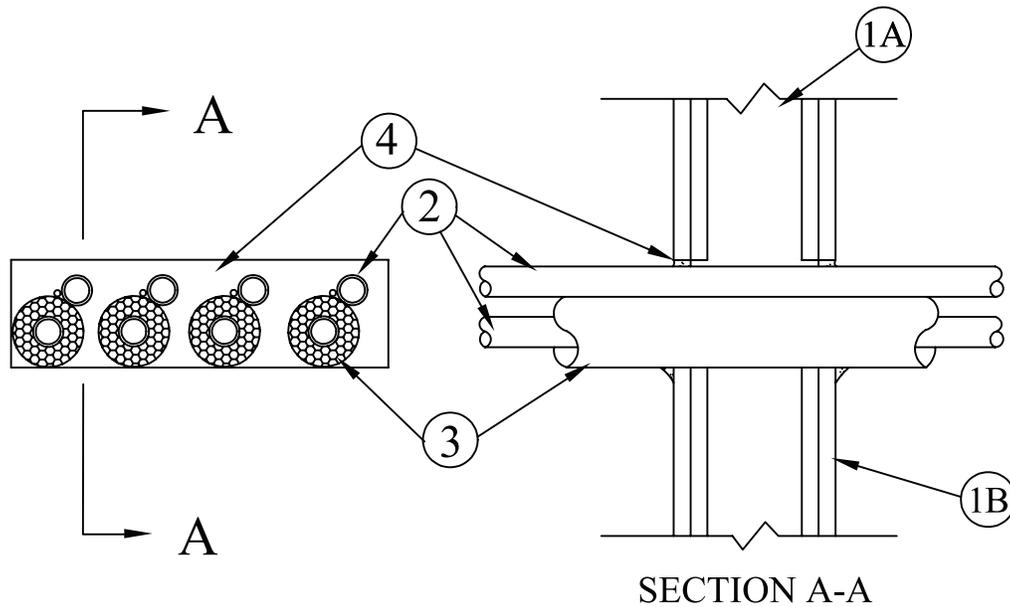

- Wall Assembly** – The 1 or 2 hr fire rated gypsum board/stud wall assembly shall be constructed of the materials and in the manner described in the individual U300, U400 or V400 Series Wall or Partition Design in the UL Fire Resistance Directory and shall include the following construction features:
 - Studs** – Wall framing may consist of either wood studs or steel channel studs. Wood studs to consist of nom 2 in. by 4 in. (50 mm by 102 mm) lumber spaced 16 in. (405 mm) OC. Steel studs to be min 3-1/2 in. (89 mm) wide spaced max 24 in. (610 mm) OC.
 - Gypsum Board*** – The gypsum board type, thickness, number of layers, fastener type and sheet orientation shall be as specified in the individual U300 or U400 Series Design in the UL Fire Resistance Directory. Max area of opening is 58 sq in. (375 sq cm) with a max dimension of 14-1/2 in. (368 mm).

The hourly F Rating of the firestop system is equal to the hourly fire rating of the wall assembly in which it is installed. The hourly T Rating of the firestop system is 0 and 3/4 Hr for 1 and 2 Hr rated assemblies, respectively.
- Through Penetrants** – A max of eight pipes or tubes and four cables installed eccentrically or concentrically within the opening. Annular space between penetrants and periphery of opening to be min 0 in. (point contact) to max 1-1/2 in. (0 mm to max 38 mm). Separation between penetrants to be min 0 in. (point contact) to max 1-1/2 in. (0 mm to max 38 mm). Penetrants to be rigidly supported on both sides of the wall. The following types and sizes of penetrants may be used:
 - Copper Tubing** – Nom 1 in. (25 mm) diam (or smaller) Type L (or heavier) copper tubing.
 - Copper Pipe** – Nom 1 in. (25 mm) diam (or smaller) Regular (or heavier) copper pipe.
 - Steel Pipe** – Nom 1 in. (25 mm) diam (or smaller) Schedule 5 (or heavier) steel pipe.
 - Cables** – Max 7/C No. 12 AWG multiconductor power and control cables; XLPE or PVC insulation with XLPE or PVC jacket.
- Tube Insulation – Plastics+** – Nom 3/4 in. (19 mm) thick (or less) acrylonitrile butadiene/polyvinyl chloride (AB/PVC) flexible foam furnished in the form of tubing. The tube insulation may be installed on a max of four pipes or tubes. Annular space between the tube insulation and periphery of opening to be min 0 in. (point contact) to max 1-1/2 in. (0 mm to max 38 mm). Space between insulated and uninsulated penetrants to be 0 in. (point contact) to max 1-1/2 in. (0 mm to max 38 mm).
See **Plastics (QMFZ2)** category in the Plastics Recognized Component Directory for names of manufacturers. Any Recognized Component tube insulation material meeting the above specifications and having a UL 94 Flammability Classification of 94-5A may be used.
- Fill, Void or Cavity Material* – Caulk or Sealant** – Min 5/8 in. (16 mm) thickness of caulk applied within annulus, flush with both surfaces of wall. Min 1/4 in. (6 mm) diam bead of caulk applied to gypsum board/penetrant interface at point contact location on both sides of wall.

3M COMPANY– CP 25WB+, IC 15WB+ caulk or FB-3000 WT sealant

*Bearing the UL Classification Marking

Reprinted from the Online Certifications Directory with permission from Underwriters Laboratories Inc.
Copyright © 2010 Underwriters Laboratories Inc.®



System No. W-L-8069

June 23, 2015

F Ratings — 1, 2, 3 and 4 Hr (See Item 1)

T Rating — 0 Hr

L Rating At Ambient — 4 CFM/sq ft. (See Item 3B)

L Rating At 400 F — Less Than 1 CFM/sq ft. (See Item 3B)

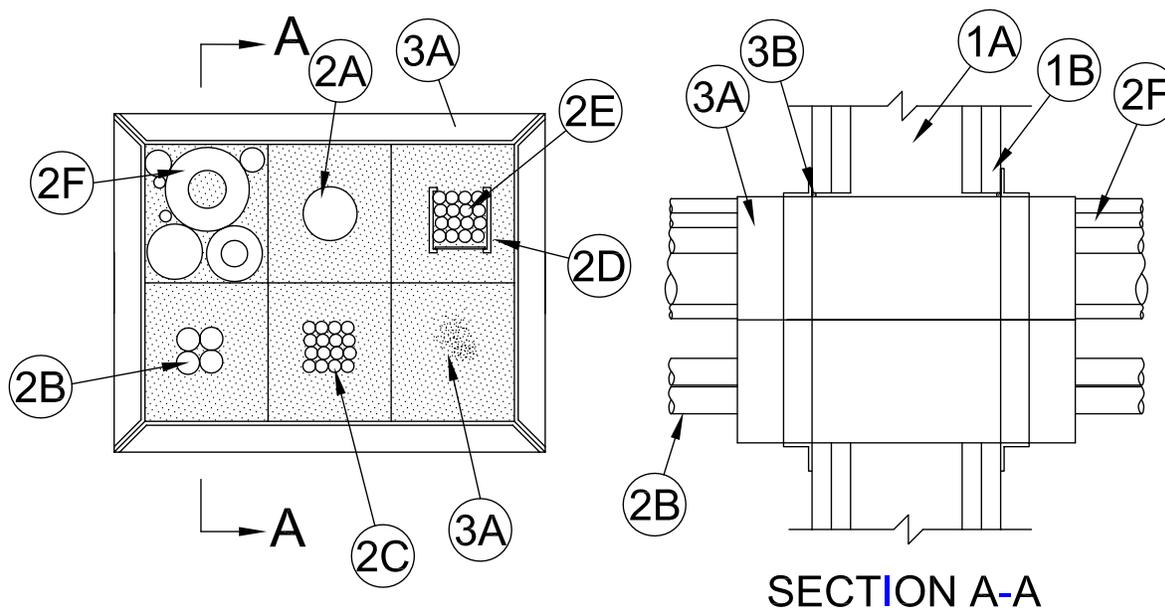

- Wall Assembly** — The 1, 2, 3 or 4 hr fire rated gypsum board/stud wall assembly shall be constructed of the materials and in the manner described in the individual U300, U400 or V400 Series Wall and Partition Design in the UL Fire Resistance Directory and shall include the following construction features:

- Studs** — Wall framing may consist of either wood or steel channel studs. Wood studs to consist of nom 2 by 4 in. (51 by 102 mm) lumber spaced 16 in. (406 mm) OC. Steel studs to be min 3-1/2 in. (89 mm) wide spaced max 24 in. (610 mm) OC.
- Gypsum Board*** — The gypsum board type, thickness, number of layers, fastener type and sheet orientation shall be as specified in the individual Wall and Partition Design in the UL Fire Resistance Directory. Max area of opening is 98.5 in.² (635 cm²) with a max dimension of 12-1/8 in. (308 mm) for square devices. Max diam of opening is 2-1/4 in. (57 mm) for nom 2 in. (51 mm) round devices and 4-1/4 in. (108 mm) for 4 in. (102 mm) round devices.

The hourly F Rating of the firestop system is equal to the hourly fire rating of the wall assembly in which it is installed.

- Through-Penetrants** — One or more metallic pipes, conduits or tubes, nonmetallic pipes, conduits or tubes, cables, cables within cable trays, and miscellaneous combinations of penetrants, as described below, may be installed within each firestop device (Item 3A) as further specified below. Through penetrants to be rigidly supported on both sides of wall assembly. The following types and sizes of through-penetrants may be used:

- Metallic Penetrants** — One or more metallic pipe, tubing or conduit may be installed concentrically or eccentrically within each firestop device (Item 3A). If multiple through penetrants are installed within the firestop device, a min 1/4 in. (6 mm) annular space is required between the through penetrants. Through penetrants to be rigidly supported on both sides of floor or wall assembly. The following types and sizes of through penetrants may be used:
 - Steel Pipe** — Nom 3 in. (76 mm) diam (or smaller) Schedule 10 (or heavier) steel pipe.
 - Iron Pipe** — Nom 3 in. (76 mm) diam (or smaller) cast or ductile iron pipe.
 - Copper Tubing** — Nom 3 in. (76 mm) diam (or smaller) Type L (or heavier) copper tube.
 - Copper Pipe** — Nom 3 in. (76 mm) diam (or smaller) Regular (or heavier) copper pipe.
 - Conduit** — Nom 3 in. (76 mm) diam (or smaller) steel electrical metallic tubing (EMT) or rigid steel conduit.
 - Through-Penetrating Product* - Flexible Metal Piping** — Nom 1-1/4 in. (32 mm) diam (or smaller) steel flexible metal piping.

OMEGA FLEX INC — TracPipe Flexible Gas Piping

- Nonmetallic Penetrants** — One or more nonmetallic pipes, conduits or tubes, as described in a single line item below, may be installed within each firestop device (Item 3A):

- Polyvinyl Chloride (PVC) Pipe** — One nom 2 in. (51 mm) diam (or smaller) Schedule 40 solid core PVC pipe for use in closed (process or supply) or vented (drain, waste or vent) piping systems.
- Rigid Nonmetallic Conduit+** — One nom 2 in. (51 mm) diam (or smaller) Schedule 40 PVC conduit installed in accordance with the National Electrical Code (NFPA No. 70).

See **Rigid Nonmetallic, Schedule 40 and 80 PVC Conduit (DZYR)** category in the Electrical Construction Equipment Directory for names of manufacturers.

- Chlorinated Polyvinyl Chloride (CPVC) Pipe** — One nom 2 in. (51 mm) diam (or smaller) SDR11 CPVC pipe for use in closed (process or supply) piping systems.
- Crosslinked Polyethylene (PEX) Tubing** — One nom 2 in. (51 mm) diam (or smaller) SDR 9 PEX tubing for use in closed (process or supply) piping systems.
- Electrical Nonmetallic Tubing (ENT)+** — Max four nom 1-1/4 in. (32 mm) diam (or smaller) ENT installed in accordance with the National Electrical Code (NFPA No. 70).

System No. W-L-8069 *continued*

See **Electrical Nonmetallic Tubing** (FKHU) category in the Electrical Construction Equipment Directory for names of manufacturers.

- B6. **Optical Fiber/Communications/Signaling/Coaxial Cable Raceways+** — Max four nom 1-1/4 in. (32 mm) diam (or smaller) plenum rated raceways installed in accordance with the National Electrical Code (NFPA No. 70).

See **Optical Fiber/Communications/Signaling/Coaxial Cable Raceway** (QAZM) category in the Electrical Construction Equipment Directory for names of manufacturers.

- B7. **Acrylonitrile Butadiene Styrene (ABS) Pipe** — Nom 2 in. (51 mm) diam (or smaller) Schedule 40 cellular core ABS for use in closed (process or supply) or vented (drain, waste or vent) piping systems.

C. **Cables** — The cable loading within the loading area of each firestop device module may represent a 0 to 100 percent visual fill. The min bundle diam shall be 1/2 in. (13 mm) if a single firestop device (Item 3A) is installed in the opening. If multiple firestop devices are ganged together, there is no min bundle size. Any combination of the following types and sizes of cables may be used:

- C1. Max 2/C No. 18 AWG copper conductor thermostat cable with polyvinyl chloride (PVC) insulation and jacket materials.
- C2. Max 4 pair No. 24 AWG copper conductor Cat5e or Cat 6 telephone cable with PVC insulation and jacket materials.
- C3. Max RG/U (or smaller) coaxial cable with foam high density polyethylene insulation and PVC jacket materials.
- C4. Max 3/C (with ground) No. 14 AWG (or smaller) nonmetallic sheathed (Romex) cable with PVC insulation and jacket materials.
- C5. Max 1/C No. 8 AWG copper conductor cable with PVC insulation and nylon jacket materials.
- C6. Max 12 core No. 26 AWG shielded multi coax cable with foam high density polyethylene insulation and PVC jacket.
- C7. Max 48MM62.5 micron fiber optic cables with having a min FT-6 rating.
- C8. Max 62.5/125 micron micron fiber optic cables with having a min Riser rating.
- C9. Max 1/C 3/0 AWG copper conductor cable with PVC insulation and jacket materials.
- C10. Max three copper conductors (with ground) No. 12 AWG **Metal Clad Cable+**.
- C11. Max four copper conductors No. 2 AWG **Metal Clad Cable+**.

AFC CABLE SYSTEMS INC

- C12. Max 1/C 2/0 AWG non halogen copper conductor cable.
- C13. Max 300 pair No. 24 AWG copper conductor telephone cable with PVC insulation and jacket materials.
- C14. Max 30 pair No. 22 copper conductor shielded switchboard cable with PVC insulation and jacket materials.
- C15. Max RG/6 (or smaller) coaxial cable with fluorinated ethylene (FE) or PVC insulation and jacket materials.
- C16. Max RG/U (or smaller) coaxial cable with fluorinated ethylene (FE) or PVC insulation and jacket materials.
- C17. Max 7/C No. 12 AWG copper conductors with PVC insulation and jacket materials.
- C18. Max 4 pair No. 23 AWG copper conductor Cat 6 telephone cable with PVC insulation and jacket materials.
- C19. Max three copper conductors (with ground) No. 12 AWG steel Armored Cable+.
- C20. Max 04-02 2 5M fiber optic cables having a max diameter of 0.450 in. (11.4 mm).
- C21. Max 1/C No. 750 kcmil copper conductors with PVC insulation and fabric jacket materials.
- C22. Max 3/C with ground No. 2/0 AWG aluminum conductor SER cable with cross linked polyethylene (XLPE) insulation and PVC jacket.

D. **Cable Tray*** — Nom 2 in. (51 mm) wide by 2 in. (51 mm) high (or smaller) welded wire basket cable tray formed from min 0.23 in. (5.8 mm) thick steel wires in the longitudinal direction and 0.19 in. (4.8 mm) wires in the transverse direction. Transverse wires shall be spaced max 4 in. (102 mm) OC. One cable tray may be installed within each firestop device (Item 4A). When installed within the 4 by 4 by 10 in. (64 by 64 by 254 mm) firestop device, the annular space between the cable tray and the periphery of the device shall be min 1/2 in. (13 mm) to max 1-1/2 in. (38 mm). The cables described in Item E below may be installed within the cable tray.

E. **Cables** — Cable fill within cable tray shall be a nom 2 in. (100 % visual fill). If three or more firestop devices (Item 4A) are ganged together, the cable fill may be less than 2 in. Any combination of the following types and sizes of cables may be used within the cable tray:

- E1. Max 4 pair No. 23 AWG copper conductor Cat5e or Cat 6 telephone cable with PVC insulation and jacket materials.

F. **Mixed Penetrants** — One of the following groupings of mixed penetrants may be installed within each firestop device:

F1. **Air Conditioning (AC) Line Set** — One or more AC line set, consisting of multiple metallic pipes, tube insulation, nonmetallic pipes and cables bundled within firestop device in any combination unless otherwise noted.

- 1. **Copper Tubing** — Nom 3/4 in. (19 mm) diam (or smaller) Type L (or heavier) copper tube.
- 2. **Tube Insulation - Plastic++** — Nom 1/2 in. (13 mm) thick (or smaller) acrylonitrile butadiene/polyvinyl chloride (AB/PVC) flexible foam furnished in the form of tubing with skin may be used on the copper tubes. If multiple insulated through penetrants are installed within the firestop device, the insulated through penetrants may be bundled together.

See **Plastics+** (QMFZ2) category in the Plastics Recognized Component Directory for names of manufacturers. Any Recognized Component tube insulation material meeting the above specifications and having a UL 94 Flammability Classification of 94-5VA may be used.

- 3. **Polyvinyl Chloride (PVC) Pipe** — One nom 1 in. (25 mm) diam (or smaller) Schedule 40 solid core PVC pipe for use in closed (process or supply) or vented (drain, waste or vent) piping systems.
- 4. **Thermostat Cable** — Max 2/C No. 18 AWG copper conductor thermostat cable with polyvinyl chloride (PVC) insulation and jacket materials.
- F2. **Mixed Grouping** — One or more metallic pipes, nonmetallic pipes and cables bundled within firestop device in any combination unless otherwise noted.
 - 1. **Copper Tubing** — Nom 1 in. (25 mm) diam (or smaller) Type L (or heavier) copper tube.
 - 2. **Electrical Nonmetallic Tubing (ENT)+** — One nom 1-1/4 in. (32 mm) diam (or smaller) ENT installed in accordance with Article 362 of the National Electrical Code (NFPA No. 70).

See **Electrical Nonmetallic Tubing** (FKHU) category in the Electrical Construction Equipment Directory for names of manufacturers.

- 3. **Optical Fiber/Communications/Signaling/Coaxial Cable Raceways+** — One nom 1-1/4 in. (32 mm) diam (or smaller) plenum rated raceway installed in accordance with the National Electrical Code (NFPA No. 70).

Through Penetrations

Compos

8000 Series

Gypsum

W-L

System No. W-L-8069 *continued*

See **Optical Fiber/Communications/Signaling/Coaxial Cable Raceway (QAZM)** category in the Electrical Construction Equipment Directory for names of manufacturers.

4. **Power Cable** — Max 1/C No. 750 kcmil copper conductors with PVC insulation and fabric jacket materials.
5. **Thermostat Cable** — Max 2/C No. 18 AWG copper conductor thermostat cable with polyvinyl chloride (PVC) insulation and jacket materials.

F3. **Mixed Grouping** — One or more flexible metal pipes and a max of two nonmetallic tubes or raceways bundled within firestop device in any combination.

1. **Through-Penetrating Product* - Flexible Metal Piping** — Nom 1-1/4 in. (32 mm) diam (or smaller) steel flexible metal piping.

OMEGA FLEX INC — TracPipe Flexible Gas Piping

2. **Electrical Nonmetallic Tubing (ENT)+** — Two nom 1-1/4 in. (32 mm) diam (or smaller) ENT installed in accordance with Article 362 of the National Electrical Code (NFPA No. 70).

See **Electrical Nonmetallic Tubing (FKHU)** category in the Electrical Construction Equipment Directory for names of manufacturers.

3. **Optical Fiber/Communications/Signaling/Coaxial Cable Raceways+** — Two nom 1-1/4 in. (32 mm) diam (or smaller) plenum rated raceway installed in accordance with the National Electrical Code (NFPA No. 70).

See **Optical Fiber/Communications/Signaling/Coaxial Cable Raceway (QAZM)** category in the Electrical Construction Equipment Directory for names of manufacturers.

3. **Firestop System** — The firestop system shall consist of the following:

- A. **Firestop Device*** — A max of six square firestop devices may be ganged together for 1 and 2 hr rated assemblies. A max of three square firestop devices may be ganged together for 3 and 4 hr rated assemblies. As an alternate, one round device may be centered in a round opening. Each device consists of a nom 2-1/2 by 2-1/2 by 10 in. (64 by 64 by 254 mm), a nom 4 by 4 by 10 in. (102 by 102 by 254 mm), a nom 2 in. (51 mm) diam by 10 in. (254 mm) or a nom 4 in. (102 mm) diam by 10 in. (254 mm) powder coated steel transit incorporating internal intumescent material, foam plugs and mounting flanges. Firestop device(s) to be installed within opening with ends projecting an equal distance beyond each surface of wall assembly in accordance with the accompanying installation instructions. The annular space between device(s) and periphery of opening shall be min 0 in. (0 mm, point contact) to max 1/8 in. (3 mm). Firestop device(s) secured in place by means of fill material (Item 3B) and steel split mounting flanges sized to accommodate the firestop device. Steel split mounting flanges installed on both sides of wall after installation of fill material, and secured together with supplied steel set screws. Nom 1 in. (25 mm) thick foam plugs cut to accommodate the through penetrants and installed flush with each end of device on both sides of wall assembly. The foam plug in one or both ends of the device is optional except when L Rating is required (See Item 3B).

3M COMPANY — 3M Fire Barrier Pass-Through Device

- B. **Fill, Void or Cavity Materials* - Putty or Caulk** — Min 1/8 in. (3 mm) bead of fill material shall be applied at interface of gypsum board and firestop devices immediately prior to the installation of the mounting flanges. As an option, foam plugs may be recessed into device and the recess filled with putty or caulk flush with the ends of the device. L Rating applies only when fill material is applied at interface of gypsum board and device(s) prior to mounting flanges and with both ends of firestop device(s) filled with nominal 1/8 in. (3.2 mm) of Moldable Putty+.

3M COMPANY — Moldable Putty+, CP 25WB+, IC 15WB+, 3000 WT. CP 25WB+ not suitable for use with CPVC pipes.

+ Bearing the UL Listing Mark

++ Bearing the UL Recognized Component Mark

* Bearing the UL Classification Mark

Through Penetrations

Combos

8000 Series

Gypsum

WL

System No. W-L-8077

September 20, 2011

ANSI/UL1479 (ASTM E814)

F Ratings – 1 and 2 Hr (See Item 1)

T Ratings – 0 and 3/4 Hr (See Item 1)

CAN/ULC S115

F Ratings – 1 and 2 Hr (See Item 1)

FT Ratings – 0 and 3/4 Hr (See Item 1)

FH Ratings – 1 and 2 Hr (See Item 1)

FTH Ratings – 0 and 3/4 Hr (See Item 1)

System tested with a pressure differential of 2.5 Pa between the exposed and the unexposed surfaces with the higher pressure on the exposed side.

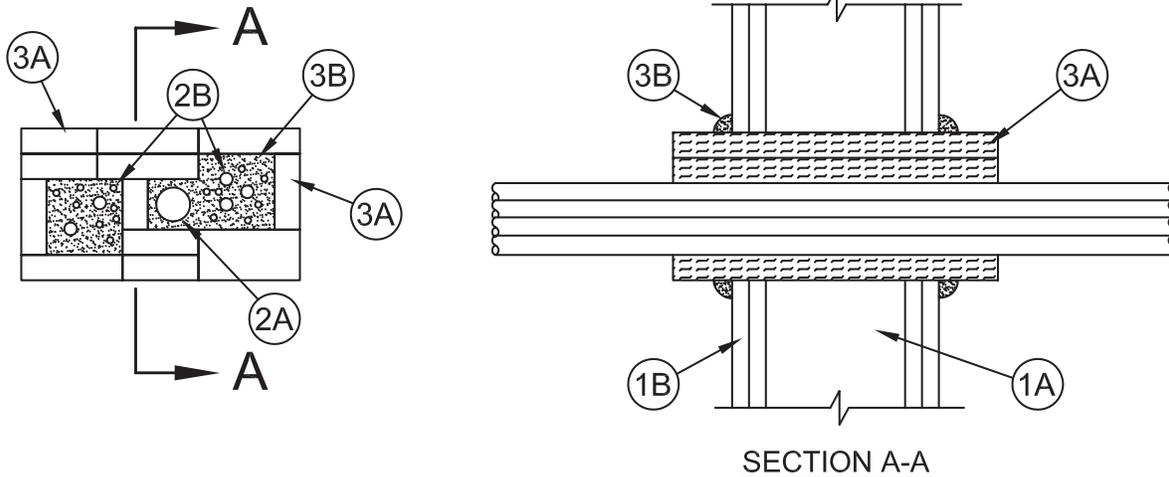

1. **Wall Assembly** – The 1 or 2 hr fire rated gypsum board/stud wall assembly shall be constructed of the materials and in the manner described in the individual U300, U400, V400 or W400 Series Wall and Partition Design in the UL Fire Resistance Directory and shall include the following construction features:

- A. **Studs** – Wall framing may consist of either wood or steel channel studs. Wood studs to consist of nom 2 by 4 in. (51 by 102 mm) lumber spaced 16 in. (406 mm) OC. Steel studs to be min 3-1/2 in. (89 mm) wide spaced max 24 in. (610 mm) OC.
- B. **Gypsum Board*** – The gypsum board type, thickness, number of layers, fastener type and sheet orientation shall be as specified in the individual Wall and Partition Design in the UL Fire Resistance Directory. Max size of framed opening to be 8 in. (114 mm) high by 16 in. (406 mm) wide.

The hourly F and FH Ratings of the firestop system are equal to the hourly fire rating of the wall assembly in which it is installed. The hourly T, FT and FTH Ratings are 0 Hr or 3/4 Hr when the fire rating of the wall assembly in which it is installed is 1 Hr or 2 Hr, respectively.

2. **Through-Penetrants** – Max two cables bundles and one optical fiber raceway as described below. Through penetrants to be rigidly supported on both sides of wall assembly. The following types and sizes of through-penetrants may be used:
 - A. **Nonmetallic Penetrant** – One nonmetallic raceway as described in a single line item below.
 - A1. **Optical Fiber/Communications/Signaling/Coaxial Cable Raceways+** – Nom 1-1/4 in. (32 mm) diam (or smaller) plenum rated raceways installed in accordance with the National Electrical Code (NFPA No. 70). Raceway to be positioned in the center of the wall opening.
See **Optical Fiber/Communications/Signaling/Coaxial Cable Raceway (QAZM)** category in the Electrical Construction Equipment Directory for names of manufacturers.
 - B. **Cables** – Cables installed in a max of two bundles having a max bundle diam of 4 in. (102 mm). Cable bundles to be positioned in the middle of wall opening and a min of 2-1/2 in. (64 mm) from opening edge to center of bundle. Any combination of the following types and sizes of cables may be used:
 - B1. Max 2/C No. 18 AWG copper conductor thermostat cable with polyvinyl chloride (PVC) insulation and jacket materials.
 - B2. Max 4 pair No. 24 AWG copper conductor Cat 5e or Cat 6 telephone cable with PVC insulation and jacket materials.
 - B3. Max 100 pair No. 24 AWG copper conductor telephone cable with PVC insulation and jacket materials.
 - B4. Max 7/C No. 12 AWG copper conductor power and control cables with XLPE or PVC insulation with XLPE or PVC jacket.
 - B5. Max 48 MM62.5 micron fiber optic cables with having a min FT-6 rating.
 - B6. Max 62.5/125 micron fiber optic cables with having a min Riser rating.
 - B7. Max 3/C (with ground) No. 12 AWG (or smaller) nonmetallic sheathed (Romex) cable with PVC insulation and jacket materials.
 - B8. Max 1/C No. 8 AWG copper conductor cable with PVC insulation and nylon jacket materials.
 - B9. Max 12 core No. 26 AWG shielded multi coax cable with foam high density polyethylene insulation and PVC jacket.
 - B10. Max 48 MM62.5 micron fiber optic cables with having a min FT-6 rating.

System No. W-L-8077 *continued*

- B11. Max 62.5/125 micron fiber optic cables with having a min Riser rating.
- B12. Max 1/C 3/0 AWG copper conductor cable with PVC insulation and jacket materials.
- B13. Max three copper conductors (with ground) No. 12 AWG **Metal Clad Cable+**.
- B14. Max four copper conductors No. 2 AWG **Metal Clad Cable+**.
- B15. Max 1/C 2/0 AWG non halogen copper conductor cable.
- B16. Max 300 pair No. 24 AWG copper conductor telephone cable with PVC insulation and jacket materials.
- B17. Max 30 pair No. 22 copper conductor shielded switchboard cable with PVC insulation and jacket materials.
- B18. Max RG/6 (or smaller) coaxial cable with fluorinated ethylene (FE) or PVC insulation and jacket materials.
- B19. Max 7/C No. 12 AWG copper conductors with PVC insulation and jacket materials.
- B20. Max 4 pair No. 23 AWG copper conductor Cat 6 telephone cable with PVC insulation and jacket materials.
- B21. Max three copper conductors (with ground) No. 12 AWG steel **Armored Cable+**.
- B22. Max 04-02 2.5M fiber optic cables having a max diameter of 0.450 in. (11.4 mm).
- B23. Max 1/C No. 350 kcmil copper conductors with PVC insulation and fabric jacket materials.
- B24. Max 3/C with ground No. 2/0 AWG aluminum conductor SER cable with cross linked polyethylene (XLPE) insulation and PVC jacket.
- B25. Max nom 0.75 in. diam water tight conduit.

3. **Firestop System** – The firestop system shall consist of the following:

- A. **Fill, Void or Cavity Materials* – Pillows** – Max 9 in. (229 mm) long by 6 in. (152 mm) wide by 2 and 3 in. (51 and 76 mm) thick plastic covered pillows tightly-packed to fill annular space between the cable bundles, raceway and periphery of opening and the annular space between the cable bundles and raceway installed within the opening. Pillows installed with 9 in. (229 mm) dimension projecting through wall and centered within the opening.

3M COMPANY

3M FIRE PROTECTION PRODUCTS – Fire Barrier Pillow or Fire Barrier Self-Locking Pillow

- B. **Fill, Void or Cavity Materials* – Putty** – Moldable putty material, installed within voids around penetrants and pillows to a min thickness of 1 in. (25 mm) on both sides of wall.

3M COMPANY

3M FIRE PROTECTION PRODUCTS – MP+ Moldable Putty

*Bearing the UL Classification Mark

+ Bearing the UL Listing Mark

Reprinted from the Online Certifications Directory with permission from Underwriters Laboratories Inc.

Copyright © 2011 Underwriters Laboratories Inc.®



Note: Systems with Nonmetallic Through Penetrant(s) have not been evaluated with a pressure differential of 50 Pa between the exposed and unexposed surfaces as required by the National Building Code of Canada.

System No. W-L-8097

May 02, 2012

ANSI/UL1479 (ASTM E814)

F Ratings – 1 and 2 Hr (See Item 1)

T Rating – 0 Hr

CAN/ULC S115

F Ratings – 1 and 2 Hr (See Item 1)

FT Rating – 0 Hr

FH Ratings – 1 and 2 Hr (See Item 1)

FTH Rating – 0 Hr

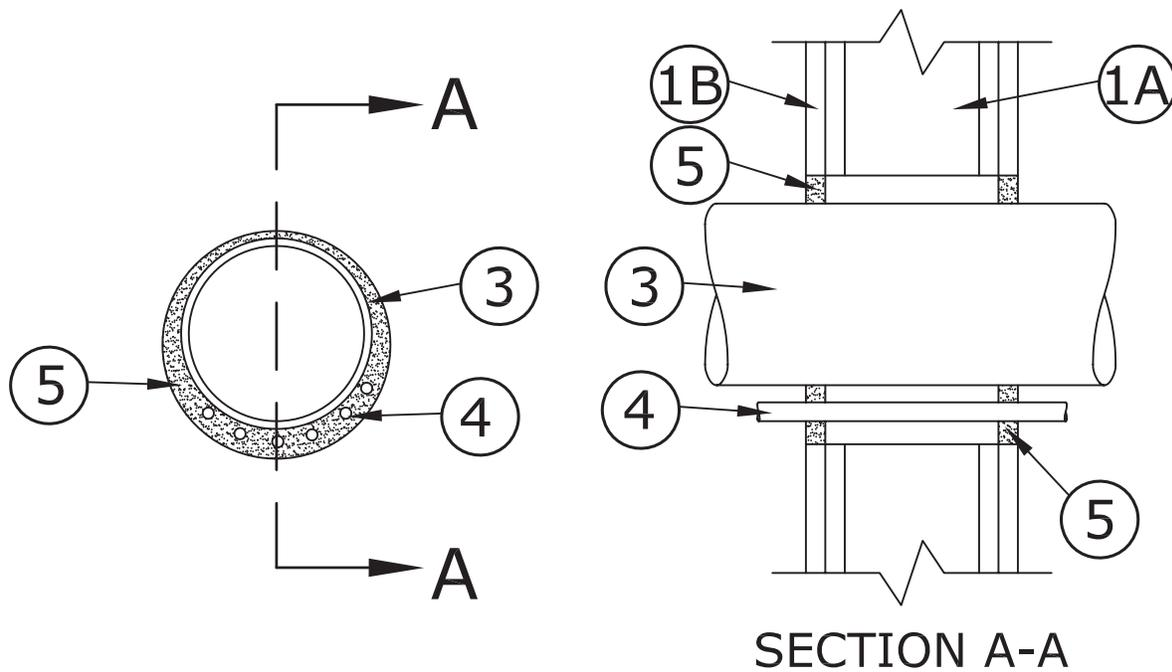

1. **Wall Assembly** – The 1 or 2 hr fire rated gypsum board/stud wall assembly shall be constructed of the materials and in the manner specified in the individual U300, U400, V400 or W400 Series Wall and Partition Designs in the UL Fire Resistance Directory and shall include the following construction features.

- A. **Studs** – Wall framing shall consist of either wood studs or steel channel studs. Wood studs to consist of nom 2 by 4 in. (51 by 102 mm) lumber spaced 16 in. (406 mm) OC. Steel studs to be min 3-1/2 in. (89 mm) wide and spaced max 24 in. (610 mm) OC.
- B. **Gypsum Board*** – One or two layers of nom 5/8 in. (16 mm) thick gypsum board as specified in the individual Wall and Partition Design. Max diam of opening is 7 in. (178 mm).

The hourly F and FH Ratings of the firestop system are equal to the hourly rating of the wall assembly.

2. **Steel Sleeve** – (Optional, Not Shown) – Cylindrical sleeve fabricated from min 0.018 in. (0.46 mm) thick (No. 28 gauge) galv sheet steel and having a min 1 in. (25 mm) lap along the longitudinal seam. Length of sleeve to be equal to or max 2 in. (51 mm) greater than the thickness of wall. Ends of sleeve to be flush with or extend max 1 in. (25 mm) beyond each surface of wall.
3. **Steel Tube** – Nom 6 in. (152 mm) diam (or smaller) No. 16 ga steel tube installed eccentrically within the opening. The tube may be installed at an angle not greater than 45 degrees from perpendicular. The annular space between the tube and the periphery of the opening shall be min 1/4 in. (6 mm) to max 3/4 in. (19 mm). Tube to be rigidly supported on both sides of wall assembly.
4. **Cables** – Max six nom 3/8 in (10 mm) diam two pair No. 22 AWG foil shielded communication cables with polyvinyl chloride (PVC) insulation and jacket. The cables may be installed at an angle not greater than 45 degrees from perpendicular in line with steel tube (Item 3). Min separation between cables and periphery of opening shall be 1/4 in. (6 mm). Separation between cables and tube shall be min 0 in. (point contact) to max 1 in. (25 mm). Cables to be rigidly supported on both sides of wall assembly.
5. **Fill, Void or Cavity Material* – Sealant** – Min 5/8 in. (16 mm) thickness of fill material applied within annulus, flush with each surface of the wall assembly. When optional steel sleeve projects beyond wall surfaces a min 1/4 in. (6 mm) diam bead of caulk applied to gypsum board/steel sleeve interface on both sides of wall.

3M COMPANY

3M FIRE PROTECTION PRODUCTS – IC 15WB+ Sealant, CP 25WB+ Sealant or FB 3000 WT Sealant

*Bearing the UL Classification Mark

Reprinted from the Online Certifications Directory with permission from UL

© 2013 UL LLC



System No. W-L-8100

June 26, 2014

ANSI/UL1479 (ASTM E814)

F Ratings — 1 and 2 Hr (See Item 1)

T Rating — 0

CAN/ULC S115

F Ratings — 1 and 2 Hr (See Item 1)

FT Rating — 0

FH Ratings — 1 and 2 Hr (See Item 1)

FTH Rating — 0

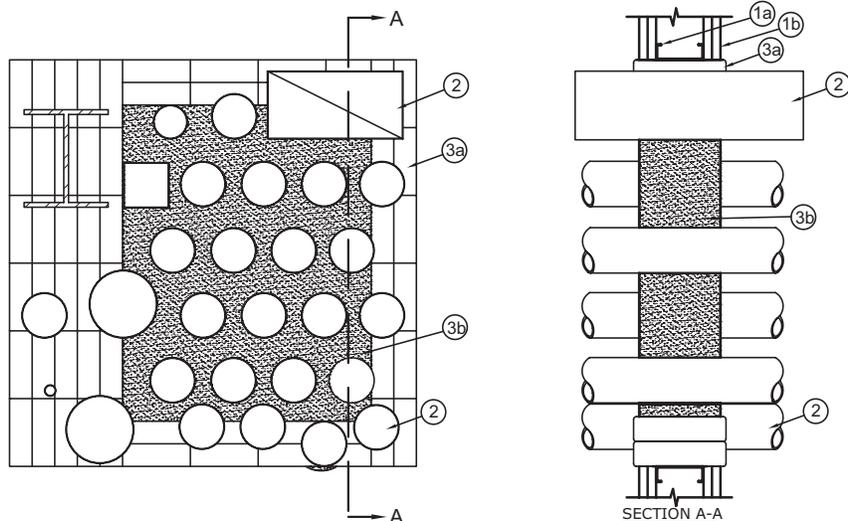

1. **Wall Assembly** — The 1 or 2 hr fire rated gypsum board/stud wall assembly shall be constructed of the materials and in the manner described in the individual U400, V400 or W400 Series Wall and Partition Design in the UL Fire Resistance Directory and shall include the following construction features:

- A. **Studs** — Steel studs to be min 3-1/2 in. (89 mm) wide spaced max 24 in. (610 mm) OC. Additional studs used to completely frame the opening.
- B. **Gypsum Board*** — The gypsum board type, thickness, number of layers, fastener type and sheet orientation shall be as specified in the individual Wall and Partition Design in the UL Fire Resistance Directory. Max size of framed opening to be 36 in. (914 mm) high by 36 in. (914 mm) wide.

The hourly F and FH Ratings of the firestop system are equal to the hourly fire rating of the wall assembly in which it is installed.

2. **Through-Penetrant** — One or more pipes, conduit, tubes, ducts, or steel members to be installed within the opening. The total number of through-penetrants is dependent on the size of the opening and the types and sizes of the penetrants. Any combination of the penetrants described below may be used provided that the following parameters relative to the annular spaces and the spacing between the through penetrants are maintained. The separation between the penetrants shall be min 1/2 in. (12 mm) to max 3 in. (76 mm). The annular space between penetrants and the periphery of opening shall be min 1/2 in. (12 mm) to max 6 in. (152 mm). Pipes, conduit tubes, ducts, or steel members to be rigidly supported on both sides of wall assembly. The following types and sizes of pipes, conduit tubes, ducts, or steel members may be used.
 - A. **Conduit** — Max 20, nom 4 in. (102 mm) diam (or smaller) electrical metallic tubing (EMT) or ridged steel conduit.
 - B. **Pipe** — Max 1, nom 6 in. (152 mm) diam (or smaller) Schedule 10 (or heavier) steel pipe.
 - C. **Duct** — Max 1, nom 6 in. by 12 in. (or smaller) No 26 gauge (or heavier) steel duct.
 - D. **Duct** — Max 1, nom 4 in. diam (or smaller) No. No 28 gauge (or heavier) steel duct.
 - E. **Pipe** — Max 1, nom 3 in. (76 mm) diam (or smaller) service weight (or heavier) cast iron soil pipe.
 - F. **Beam** — Max 1, W8 x 15 (or smaller) steel beam.
 - G. **Tube Steel** — Max 1, nom 4 in. square (or smaller) 0.25 in. (or heavier) steel tube.
 - H. **Pipe** — Max 1, nom 6 in. diam (or smaller) type L (or heavier) copper pipe.
 - I. **Conduit** — Max 1, nom 1 in. (102 mm) diam (or smaller) electrical metallic tubing (EMT) or ridged steel conduit.
 - J. **Pipe** — Max 1, nom 4 in. diam (or smaller) Schedule 40 (or heavier) steel pipe.

3. **Firestop System** — The details of the firestop system shall be as follows:

- A. **Fill, Void or Cavity Materials* — Pillows** — Max 9 in. (229 mm) long by 6 in. (152 mm) wide by 2 and 3 in. (51 and 76 mm) thick plastic covered pillows tightly-packed to fill annular space between penetrants and periphery of opening. Pillows installed with 9 in. (229 mm) dimension projecting through wall and centered within the opening.

3M COMPANY 3M FIRE PROTECTION PRODUCTS — Fire Barrier Pillow or Fire Barrier Self-Locking Pillows

- B. **Fill, Void or Cavity Material* — Foam** — Applied around and between all round interior penetrants, and between round penetrants, rectangular penetrants, and pillows where the annular space is 3 in. or less. Foam to be applied the entire depth of, and flush with both surfaces of wall. After installation of pillows (Item 3A) all voids within the opening shall be filled with a min 1 in. (25 mm) thickness foam.

3M COMPANY 3M FIRE PROTECTION PRODUCTS — Fire Barrier Rated Foam, FIP 1-Step

*Bearing the UL Classification Mark

Reprinted from the Online Certifications Directory with permission from UL

© 2014 UL LLC





UL System No. W-L-8102
XHEZ – Through-penetration Firestop Systems
XHEZ7 – Through-penetration Firestop Systems Certified for Canada

June 20, 2017

| ANSI/UL1479 (ASTM E814) | CAN/ULC S115 |
|------------------------------------|-------------------------------------|
| F Rating – 1 and 2 Hr (See Item 1) | F Rating – 1 and 2 Hr (See Item 1) |
| T Rating – 0 Hr | FT Rating – 0 Hr |
| | FH Rating – 1 and 2 Hr (See Item 1) |
| | FTH Rating – 0 Hr |

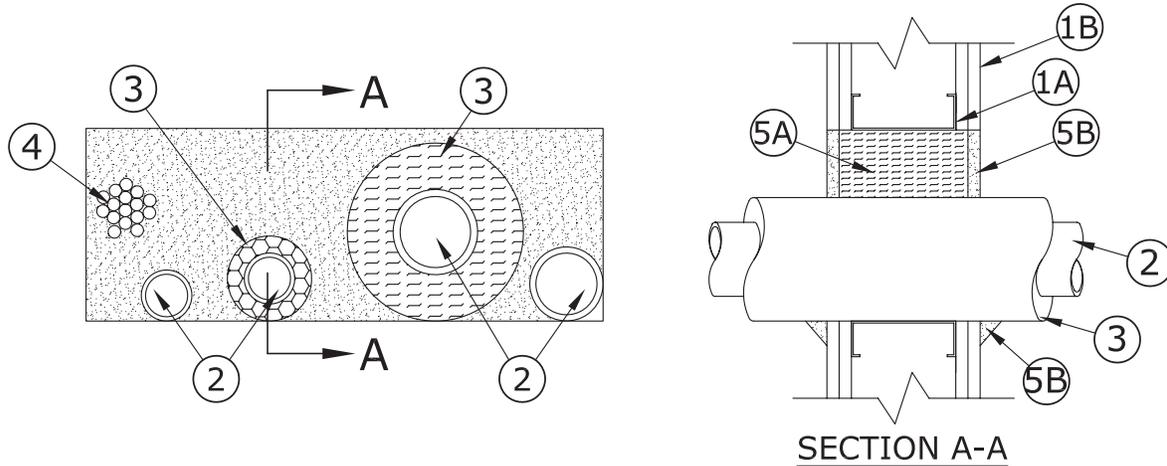

System tested with a pressure differential of 2.5 Pa between the exposed and the unexposed surfaces with the higher pressure on the exposed side.

1. Wall Assembly – The 1 or 2 hr fire-rated gypsum board/stud wall assembly shall be constructed of the materials and in the manner specified in the individual U300, U400, V400 or W400 Series Wall and Partition Designs in the UL Fire Resistance Directory and shall include the following construction features:

- A. Studs** – Wall framing may consist of either wood studs or channel shaped steel studs. Wood studs to consist of nom 2 by 4 in. (51 by 102 mm) lumber spaced max 16 in. (406 mm) OC. Steel studs to be min 3-1/2 in. (89 mm) wide and spaced max 24 in. (610 mm) OC. Additional framing members shall be installed in stud cavity containing through-penetrating item to form a rectangular box around the penetrants.
- B. Gypsum Board*** – 5/8 in. (16 mm) thick with square or tapered edges. The gypsum board type, thickness, number of layers, fastener type and sheet orientation shall be as specified in the individual U300, U400, V400 or W400 Wall and Partition Design. If the through penetrants are installed in a wood stud/gypsum board assembly, the max area of opening is 116 in.² (748 cm²). with max dimension of 14-1/2 in. (368 mm). If the through penetrants are installed in a steel stud/gypsum board assembly, max area of opening is 182 in². (1174 cm²) with max dimension of 22-3/4 in. (578 mm) wide.

The hourly F Rating of the firestop system is equal to the hourly fire rating of the wall assembly in which it is installed.

2. Through-Penetrant – One or more pipes, conduit or tubes to be installed within the opening. The total number of through-penetrants is dependent on the size of the opening and the types and sizes of the penetrants. Any combination of the penetrants described below may be used provided that the following parameters relative to the annular spaces and the spacing between the through penetrants are maintained. The separation between the penetrants shall be min 1 in. (25 mm) to max 22 in. (560 mm). The annular space between penetrants and the periphery of opening shall be min 0 in. (0 mm, point contact) to max 22 in. (560 mm). Pipes, conduit or tubes to be rigidly supported on both sides of wall assembly. The following types and sizes of pipes, conduit or tubes may be used.

- A. Copper Tubing** – Nom 3 in. (76 mm) diam (or smaller) Type L (or heavier) copper tube.
- B. Copper Pipe** – Nom 3 in. (76 mm) diam (or smaller) Regular (or heavier) copper pipe.
- C. Steel Pipe** – Nom 3 in. (76 mm) diam (or smaller) Schedule 10 (or heavier) steel pipe.
- D. Iron Pipe** – Nom 3 in. (76 mm) diam (or smaller) cast or ductile iron pipe.

- E. Conduit** – Nom 3 in. (76 mm) diam (or smaller) electric metallic tubing (EMT) or rigid steel conduit.
 - F. Polyvinyl Chloride (PVC) Pipe** – Nom 2 in. (51 mm) diam (or smaller) Schedule 40 cellular or solid core PVC pipe for use in closed (process or supply) or vented (drain, waste, or vent) piping systems.
 - G. Chlorinated Polyvinyl Chloride (CPVC) Pipe** – Nom 2 in. (51 mm) diam (or smaller) SDR 13.5 CPVC pipe for use in closed (process or supply) piping systems.
 - H. Rigid Nonmetallic Conduit (RNC)+** – Nom 2 in. (51 mm) diam (or smaller) Schedule 40 PVC conduit installed in accordance with the National Electrical Code (NFPA No. 70).
 - I. Cross Linked Polyethylene Tubing** – Nom 1 in. (25 mm) diam (or smaller) cross-linked polyethylene tubing for use in closed (process or supply) piping systems.
- 3. Pipe Insulation** – One or more metallic penetrants (pipe or tubing) may be insulated with the following types of pipe coverings. The annular space between the insulated penetrants and the periphery of the opening shall be min 0 in. (0 mm, point contact) to max 5 in. (127 mm). The separation between the insulated penetrants and the other penetrants shall be a min 1 in. (25 mm) to max 22 in. (560 mm):
- A. Pipe Covering*** – Min 1 in. (25 mm) to max 2 in. (51 mm) thick hollow cylindrical heavy density min 3.5 pcf (56 kg/m³) glass fiber units jacketed on the outside with an all service jacket. Longitudinal joints sealed with metal fasteners or factory-applied self-sealing lap tape. Transverse joints secured with metal fasteners or with butt tape supplied with the product.

See **Pipe and Equipment Covering - Materials** (BRGU) category in the Building Materials Directory for names of manufacturers. Any pipe covering material meeting the above specifications and bearing the UL Classification Marking with a Flame Spread Index of 25 or less and a Smoke Developed Index of 50 or less may be used.
 - B. Tube Insulation-Plastics+** – Min 1/2 in. (13 mm) to max 3/4 in. (19 mm) thick acrylonitrile butadiene/polyvinyl chloride (AB/PVC) flexible foam furnished in the form of tubing.

See **Plastics+** (QMFZ2) category in the Plastics Recognized Component Directory for names of manufacturers. Any Recognized Component tube insulation material meeting the above specifications and having a UL 94 Flammability Classification of 94-5VA may be used.
 - C. Pipe Covering Materials*** – Min 1 in. (25 mm) to max 2 in. (51 mm) thick unfaced mineral fiber pipe insulation having a nom density of 3.5 pcf (56 kg/m³) or heavier and sized to fit the outside diam of pipe or tube. Pipe insulation secured with min 18 SWG steel wire spaced 12 in. (305 mm) OC.

INDUSTRIAL INSULATION GROUP L L C – High Temperature Pipe Insulation 1200, High Temperature Pipe Insulation BWT and High Temperature Pipe Insulation Thermaloc
 - C1. Sheathing Material** – (Not shown) – Optional, used in conjunction with Item 3C. Foil-scrim-kraft or all service jacket material shall be wrapped around the outer circumference of the pipe covering material (Item 3B) with the kraft side exposed. Longitudinal joints sealed with metal fasteners.

See **Sheathing Materials** (BVDV) category in the Building Materials Directory for names of manufacturers. Any sheathing material meeting the above specifications and bearing the UL Classification Marking with a Flame Spread value of 25 or less and a Smoke Developed value of 50 or less may be used.
 - D. Pipe Covering Materials*** – Cellular Glass Insulation – Nom 1-1/2 to 3 in. (38 to 76 mm) thick cellular glass units sized to the outside diam of the steel pipe and supplied in nom 24 in. (610 mm) long half sections or nom 18 in. (457 mm) long segments. Pipe insulation installed on pipe in accordance with the manufacturer's instructions.

PITTSBURGH CORNING CORP – FOAMGLAS
 - E. Pipe Insulation - Foamed Plastic*** – Nom 1 in. (25 mm) thick polyisocyanurate foamed plastic units jacketed with an all service jacket. Longitudinal joints sealed with self-sealing lap tape. Transverse joints secured with butt tape. Nom 1/2 (13 mm) wide stainless steel band clamp to be secured around pipe insulation 1 in. (25 mm) from both surfaces of wall.

See **Foamed Plastic** (BRYX) category in the Building Materials Directory for names of manufacturers. Any foamed plastic pipe covering material meeting the above specifications and bearing the UL Classification Marking with a Flame Spread Index of 25 or less may be used.
- 4. Cables** – One max 4 in. (102 mm) diam bundle of cables installed within the opening and rigidly supported on both surfaces of wall. The annular space between the tightly-bundled cables and the periphery of the opening shall be min 0 in. (0 mm, point contact) to max 5 in. (127 mm). The separation between the cable bundle and the other penetrants shall be min 1 in. (25 mm) to max 22 in. (560 mm). Any combination of the following types and sizes of cables may be used:
- A.** Max 25 pair No. 24 AWG telephone cable with polyvinyl chloride (PVC) insulation and jacket.
 - B.** Max 7/C No. 12 AWG copper conductor power and control cable with PVC or cross-linked polyethylene (XLPE) insulation and PVC jacket.
 - C.** Multiple fiber optical communication cable jacketed with PVC and having a max outside diam of 1/2 in. (13 mm).
 - D.** Max 3/C No. 8 AWG with bare aluminum ground, PVC insulated steel Metal-Clad+ Cable currently Classified under the Through Penetrating Product* (XHLY) category.
 - E.** Max 3/C (with ground) No. 12 AWG (or smaller) nonmetallic sheathed (Romex) cable with PVC insulation and jacket materials.
 - F.** RG/U coaxial cable with polyethylene (PE) insulation and polyvinyl chloride (PVC) jacket having a max outside diam of 1/2 in. (13 mm).

5. Firestop System – The firestop system shall consist of the following:

- A. Packing Material** – In 2 hr fire rated wall assemblies, min 4-3/4 in. (121 mm) thickness of min 4 pcf (64 kg/m³) mineral wool batt insulation firmly packed into opening as a permanent form. In 1 hr fire rated wall assemblies, min 3-1/2 in. (89 mm) thickness of min 4 pcf (64 kg/m³) mineral wool batt insulation firmly packed into opening as a permanent form. Packing material recessed from both surfaces of the wall to accommodate the required thickness of fill material.
- B. Fill, Void or Cavity Material* – Sealant** – Min 5/8 in. (16 mm) thickness of fill material applied within annulus, flush with both surfaces of wall. At the point contact location between through penetrants and gypsum board, a min 1/4 in. (6 mm) diam bead of fill material shall be applied at the gypsum board/through penetrant interface on both surfaces of wall.

3M COMPANY 3M FIRE PROTECTION PRODUCTS – CP 25WB+ caulk or FB-3000 WT sealant



*Indicates such products shall bear the UL or cUL Certification Mark for jurisdictions employing the UL or cUL Certification (such as Canada), respectively.

Reprinted from the Online Certifications Directory with permission from UL©

System No. W-L-8106

June 09, 2016

| ANSI/UL1479 (ASTM E814) | CAN/ULC S115 |
|---|---|
| F Ratings — 1 and 2 Hr (See Item 1) | F Ratings — 1 and 2 Hr (See Item 1) |
| T Ratings — 1/4 and 1/2 Hr (See Item 2) | FT Ratings — 1/4 and 1/2 Hr (See Item 2) |
| L Rating At Ambient — Less Than 1 CFM/sq ft | FH Ratings — 1 and 2 Hr (See Item 1) |
| L Rating At 400 F — Less Than 1 CFM/sq ft | FTH Ratings — 1/4 and 1/2 Hr (See Item 2) |
| | L Rating At Ambient — Less Than 1 CFM/sq ft |
| | L Rating At 400 F — Less Than 1 CFM/sq ft |

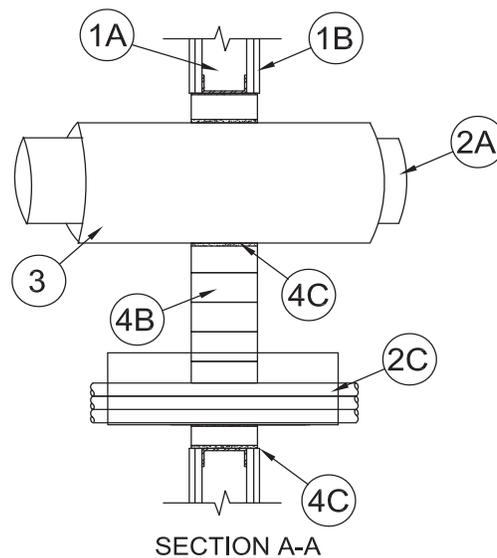
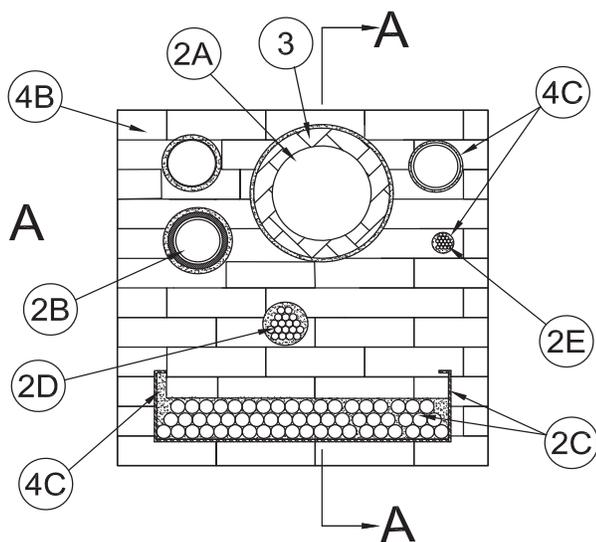

System tested with a pressure differential of 2.5 Pa between the exposed and the unexposed surfaces with the higher pressure on the exposed side.

1. **Wall Assembly** — The 1 or 2 hr fire-rated gypsum board/stud wall assembly shall be constructed of the materials and in the manner specified in the individual U300, U400, V400 or W400 Series Wall and Partition Designs in the UL Fire Resistance Directory and shall include the following construction features:

- A. **Studs** — Wall framing to consist of wood studs or channel shaped steel studs. Wood studs to consist of nom 2 by 4 in. (51 by 102 mm) lumber spaced 16 in. (406 mm) OC. Steel studs to be min 3-1/2 in. (89 mm) wide and spaced max 24 in. (610 mm) OC. Additional studs shall be used to completely frame the opening.
- B. **Gypsum Board*** — The gypsum board type, thickness, number of layers, fastener type and sheet orientation shall be as specified in the individual Wall and Partition Design in the UL Fire Resistance Directory. Max area of opening is 900 in.² (5806 cm²) with a max dimension of 30 in. (762 mm).

The hourly F and FH Ratings of the firestop system are equal to the hourly fire rating of the wall assembly in which it is installed.

2. **Through Penetrants** — One cable tray and one or more pipes, tubes or cable bundles may be installed within the opening. The total number of through-penetrants is dependent on the size of the opening and the types and sizes of the penetrants. Any combination of the penetrants described below may be used provided that the following parameters relative to the annular spaces are maintained. The annular space between penetrants shall be min 3/4 in. (19 mm) to max 9-1/2 in. (241 mm) except for the following: the annular space between cable tray and cable bundle and all other penetrants shall be min 3 in. (76 mm); the annular space between metallic penetrants and insulated penetrants shall be a min 2 in. (51 mm); the annular space between metallic penetrants and non-metallic penetrants (Item 2B) shall be a min 2 in. (51 mm) and the annular space between nonmetallic penetrants shall be min 4 in. (102 mm). The annular space between penetrants and the periphery of opening shall be min 3/4 in. (19 mm) to max 14 in. (356 mm). Penetrants to be rigidly supported on both sides of wall assembly. The types and sizes of penetrants specified below may be used.

The hourly T, FT and FTH Rating for the firestop system is 1/2 hr except that when uninsulated metallic penetrants (Item 2A) are used, the hourly T, FT and FTH Rating is 1/4 hr.

A. **Metallic Penetrants** — One or more metallic pipe, conduit or tubing may be installed within the opening. The following types and sizes of metallic pipes, conduits or tubing may be used:

- 1. **Steel Pipe** — Nom 8 in. (203 mm) diam (or smaller) Schedule 40 (or heavier) steel pipe.
- 2. **Iron Pipe** — Nom 8 in. (203 mm) diam (or smaller) cast or ductile iron pipe.
- 3. **Conduit** — Nom 4 in. (102 mm) diam (or smaller) steel electrical metallic tubing or nom 6 in. (152 mm) diam (or smaller) steel conduit.
- 4. **Copper Tubing** — Nom 4 in. (102 mm) diam (or smaller) Type L (or heavier) copper tubing.
- 5. **Copper Pipe** — Nom 4 in. (102 mm) diam (or smaller) Regular (or heavier) copper pipe.

B. **Nonmetallic Pipe** — One or more nonmetallic pipes may be installed within the firestop system. The following types and sizes of nonmetallic pipes, conduits or tubing may be used:

- 1. **Polyvinyl Chloride (PVC) Pipe** — Nom 4 in. (102 mm) diam (or smaller) solid core Schedule 40 PVC pipe for use in closed (process or supply) or vented (drain, waste or vent) piping systems.

System No. W-L-8106 *continued*

Through Penetrations

Combos

8000 Series

Gypsum

W/L

2. **Chlorinated Polyvinyl Chloride (CPVC) Pipe** — Nom 4 in. (102 mm) diam (or smaller) SDR 13.5 CPVC pipe for use in closed (process or supply) piping systems.

C. **Cable Tray*** — Max 24 in. (610 mm) wide by 6 in. (152 mm) deep open-ladder steel or aluminum cable tray. Aggregate cross-sectional area of cable tray to be max 45 percent of the cross-sectional area of the cable tray based on a max 4 in. (102 mm) cable loading depth. Any combination of the types and sizes of cables described below may be used.

1. Max 1/C, 750 kcmil (or smaller) copper conductor cable with cross-linked polyethylene (XLPE) insulation and polyvinyl chloride (PVC) jacket.

2. Max 7/C No. 12 AWG (or smaller) copper conductor power and control cables with cross-linked polyethylene (XLPE) insulation or polyvinyl chloride (PVC) jacket.

3. Max 3/C No. 2/0 AWG (or smaller) copper conductor SER cable with polyvinyl chloride (PVC) insulation and jacket.

4. Max 3/C No. 2/0 AWG (or smaller) copper conductor PVC jacketed aluminum clad or steel clad TECK 90 cable.

5. Max 300 pair (or smaller) No. 22 AWG copper conductor telephone cable with PVC insulation and jacket materials.

6. Max 110/125 fiber optic (F.O.) cable with PVC insulation and jacket.

7. Max 3/C (with ground) No. 14 AWG (or smaller) nonmetallic sheathed (Romex) cable with PVC insulation and jacket materials.

8. Max RG/U (or smaller) coaxial cable with fluorinated ethylene (FE) or PVC insulation and jacket material.

9. Max 4 pair No. 24 AWG (or smaller) copper conductor Cat 5e or Cat 6 telephone cable with PVC insulation and jacket materials.

10. **Through Penetrating Product*** — Any cables, **Armored Cable+** or **Metal Clad Cable+** currently Classified under the Through Penetrating Product category. See **Through Penetrating Product (XHLY)** category in the Fire Resistance Directory for names of manufacturers.

11. Max three conductor No. 12 AWG (or smaller) MC (BX) copper cable with polyvinyl chloride insulation and jacket materials.

D. **Cable Bundle** — Max 3 in. (76 mm) diam tightly bundled cables may be installed within the opening. Any combination of the types and sizes of cables listed in Item 2C may be used.

E. **Cable Bundle** — Max 1-1/2 in. (38 mm) diam tightly bundled 110/125 fiber optic (F.O.) cables (with PVC insulation and jacket) may be installed within the opening.

3. **Pipe Covering Material*** — **Fiberglass Insulation** — (Optional) — May be installed on metallic penetrant Items 2A1 and 2A2. Nom 1-1/2 in. (38 mm) thick hollow cylindrical heavy density (min 3.5 pcf) glass fiber units jacketed on the outside with an all service jacket. Longitudinal joints sealed with metal fasteners or factory-applied self-sealing lap tape. Transverse joints secured with metal fasteners or with butt tape supplied with the product.

See **Pipe and Equipment Covering** — Materials (BRGU) category in the Building Materials Directory for names of manufacturers. Any pipe covering material meeting the above specifications and bearing the UL Classification Marking with a Flame Spread Index of 25 or less and a Smoke Developed Index of 50 or less may be used.

4. **Firestop System** — The firestop system shall consist of the following:

A. **Fill, Void or Cavity Materials*** — **Wrap Strip** — (Not Shown) — Used with each nonmetallic penetrant (Item 2B). Min 3/16 in. (5 mm) thick intumescent material supplied in 2-1/2 in. (64 mm) wide strips. Single layer of wrap strip, pre-cut to fit penetrant OD, tightly wrapped around nonmetallic pipe and secured with the adhesive closure tab. Wrap strip to be installed within the opening at each side such that the edge of the wrap strip layer is flush with both surfaces of wall.

3M COMPANY 3M FIRE PROTECTION PRODUCTS — Tuck-In Wrap Strip WS 200, WS 300 or WS 400

B. **Fill, Void or Cavity Material*** — Blocks installed with 5 in. (127 mm) dimension projecting through opening and centered in wall such that it is recessed max 1/2 in. (13 mm) from each surface of wall. Blocks to be firmly packed to fill the opening area between and around all penetrants. Blocks can be cut to fit around penetrants and within smaller annular spaces.

3M COMPANY 3M FIRE PROTECTION PRODUCTS — 3M™ Fire Barrier Block B258, 3M™ Fire Barrier Plank PK39

C. **Fill, Void or Cavity Materials*** — **Foam** — Fill material to be forced between blocks and periphery of opening to the max extent possible. Fill material to be injected in-between blocks and penetrants to the full depth of the blocks, as well as in any visible voids/openings between blocks (Item 4B). In addition, foam shall be injected to the maximum extent possible within the interstices between all cables in the cable tray and cable bundles.

3M COMPANY 3M FIRE PROTECTION PRODUCTS — Fire Barrier Rated Foam, FIP 1-Step

* Indicates such products shall bear the UL or cUL Certification Mark for jurisdictions employing the UL or cUL Certification (such as Canada), respectively.

+ Bearing the UL Recognized Component Marking





UL System No. W-L-8107
XHEZ – Through-penetration Firestop Systems
XHEZ7 – Through-penetration Firestop Systems Certified for Canada

April 25, 2017

| ANSI/UL1479 (ASTM E814) | CAN/ULC S115 |
|-------------------------------------|--------------------------------------|
| F Ratings – 1 and 2 Hr (See Item 1) | F Ratings – 1 and 2 Hr (See Item 1) |
| T Rating – 1/2 Hr | FT Rating – 1/2 Hr |
| | FH Ratings – 1 and 2 Hr (See Item 1) |
| | FTH Rating – 1/2 Hr |

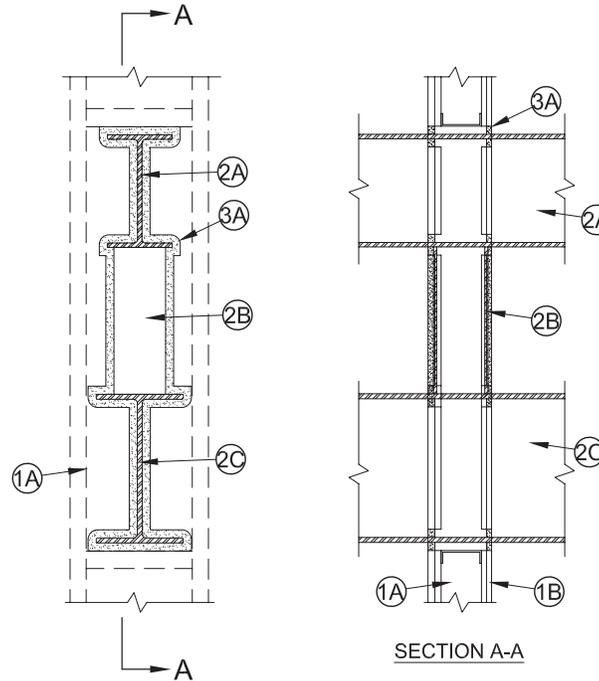

1. Wall Assembly – The 1 or 2 hr fire rated gypsum board/stud wall assembly shall be constructed of the materials and in the manner specified in the individual U400 or V400 Series Wall and Partition Designs in the UL Fire Resistance Directory and shall include the following construction features:

- A. Studs** – Wall framing shall consist of steel channel studs. Steel studs to be min 3-1/2 in. (89 mm) wide and spaced max 24 in. (610 mm) OC. Additional stud members shall be used to frame a rectangular opening around the through penetrant. The width of the framed opening shall be maximum 2 in. (51 mm) greater than the largest beam (Item 2) width. The height of the framed opening shall be maximum 2 in. (51 mm) greater than the total height of the beam (Item 2) stack.
- B. Gypsum Board*** – One or two layers of gypsum board, as specified in the individual Wall and Partition Design. Gypsum board shall be secured to the studs framing the opening, and within the framed opening, the gypsum board shall be cut to contour, to the profile of the through penetrant with a min 3/4 in. (19 mm) to max 1 in. (25 mm) annular space provided between gypsum board and the periphery of the through penetrant.

The hourly F Rating of the firestop system is equal to the hourly fire rating of the wall assembly in which it is installed.

2. Through Penetrants – A grouping of through penetrants consisting of maximum three stacked service support beams shall be installed within the firestop system, centered within the framed opening. Steel beams are intended as service supports and are to be rigidly supported on both sides of wall assembly. Beams shall be connected together at the periphery of the mating edges with min 1 in. (25 mm) long fillet welds spaced max 4 in. (102 mm) on center. The following types and sizes of beams may be used, stacked in the specific configuration depicted above. An annular space of min 3/4 in. (19 mm) to max 1 in. (25 mm) is required between the steel beam service supports and the periphery of the gypsum board opening.

- A.** W14 (or smaller) x 48 (or heavier) steel beam service support passing through the opening, perpendicular to wall.
- B.** W6 (or smaller) x 25 (or heavier) steel beam service support. A 20 in. (508 mm) length (or smaller) is centered within the thickness of the wall and oriented parallel to wall studs with web penetrating the opening and the exposed face of the flanges located flush (+1/2 in. or 13 mm, - 0 in.) with both sides of wall.
- C.** W18 (or smaller) x 76 (or heavier) steel beam service support passing through the opening, perpendicular to wall.

UL System No. W-L-8107 (cont.)

3. Firestop System – The firestop system shall consist of the following items:

A. Fill, Void or Cavity Material* - Sealant – Min 5/8 in. (16 mm) thickness of fill material applied to completely fill the annular space around steel beam service supports, flush with each surface of wall.

3M COMPANY 3M FIRE PROTECTION PRODUCTS – IC 15WB+ Sealant, CP 25WB+ Sealant or FB 3000 WT Sealant

Through Penetrations

Combos

8000 Series

WL



*Indicates such products shall bear the UL or cUL Certification Mark for jurisdictions employing the UL or cUL Certification (such as Canada), respectively.

Reprinted from the Online Certifications Directory with permission from UL©

| ANSI/UL1479 (ASTM E814) | CAN/ULC S115 |
|-------------------------------------|--------------------------------------|
| F Ratings – 1 and 2 Hr (See Item 1) | F Ratings – 1 and 2 Hr (See Item 1) |
| T Rating – 0 Hr | FT Rating – 0 Hr |
| | FH Ratings – 1 and 2 Hr (See Item 1) |
| | FTH Rating – 0 Hr |

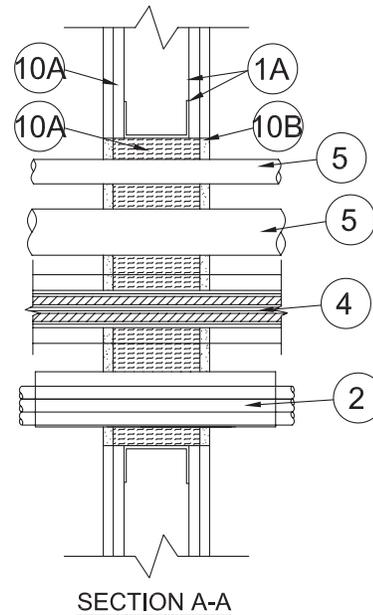
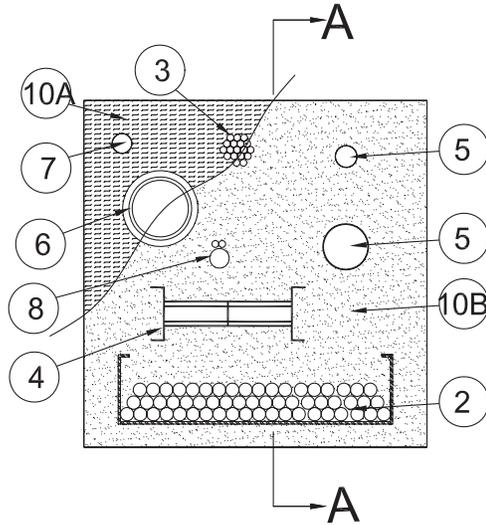

System tested with a pressure differential of 2.5 Pa between the exposed and the unexposed surfaces with the higher pressure on the exposed side.

1. Wall Assembly – The 1 or 2 h fire-rated gypsum wallboard/stud wall assembly shall be constructed of the materials and in the manner specified in the individual U300, U400, V400 or W400 Series Wall and Partition Designs in the UL Fire Resistance Directory and shall include the following construction features:

- A. Studs** – Wall framing may consist of either wood studs or steel channel studs. Wood studs to consist of nom 2 by 4 in. (51 by 102 mm) lumber spaced 16 in. (406 mm) OC. Steel studs to be min 3-5/8 in. (92 mm) wide and spaced max 24 in. (610 mm) OC. Additional stud framing members shall be used to frame all sides of opening.
- B. Gypsum Board** – One or two layers of nom 5/8 in. (16 mm) thick gypsum board as specified in the individual Wall and Partition Design. Max area of opening is 1024 in² (0.66 m²) with max dimension of 32 in. (813 mm). When wood studs are used, interior of through opening to be lined with sheets of gypsum board around entire periphery to a total thickness of 5/8 in. (16 mm) or 1-1/4 in. (32 mm) for 1 or 2 hr wall assemblies, respectively.

The hourly F Rating of the firestop system is equal to the hourly rating of the wall.

- 2. Cable Tray** – Max 24 in. (610 mm) wide by max 4 in. (102 mm) deep open ladder cable tray with channel-shaped side rails formed from min 0.060 in. (1.5 mm) thick (No. 16 MSG) galv steel or min 0.060 in. (1.5 mm) thick aluminum with rungs spaced max 9 in. (229 mm) OC. A max of two cable trays may be installed within the opening, with a min vertical separation of 6 in. (152 mm). Annulus between the cable tray and the periphery of the opening is min 3/4 in. (19 mm) to max 22 in. (559 mm) for FB-3000WT sealant and 12 in. (305 mm) for CP 25WB+ sealant. Separation between cable tray and metallic or nonmetallic penetrants is min 6 in. (152 mm). Aggregate cross-sectional area of cables in cable tray not to exceed 40 percent of the cross-sectional area of the cable tray based on a max 3 in. (76 mm) cable loading depth within tray. Any combination of the cable types specified in Item 3 may be used.
- 3. Cables** – Max 4 in. (102 mm) diam tightly bundled cables. The annular space between cable bundles and other penetrants shall be a min 6 in. (152 mm). Any combination of the following types and sizes of copper conductor cables may be used.
 - A.** Max 2/C No.14 AWG cable with XLPE jacket and insulation.
 - B.** Max 2/C No.14 AWG cable with XLPE jacket and insulation.
 - C.** Max 3/C No. 2 AWG cable with XLPE jacket and insulation.

- D. Max 4/C No. 6 AWG cable with XLPE jacket and insulation.
- E. Max 1000 kcmil single-conductor copper or aluminum power cable; cross-linked polyethylene insulation.
- F. Max 3/C 350 MCM cable with XLPE jacket and insulation.
- G. Max 1/C 750 MCM cable with XLPE jacket and insulation.
- H. Max. 25 pair No 24 AWG Data Twist Communication cable.
- I. Max 400 pair No. 24 AWG telephone cable.
- J. Max 7/C - No. 12 AWG cable with PVC-nylon insulation and PVC jacket.
- K. Max RG/U coaxial cables with plenum rated or fluorinated ethylene jacket and insulation.
- L. Multiple fiber optical communication cable jacketed with PVC and having a max outside diam of 5/8 in. (16 mm).

M. Through Penetrating Product* — Any cables, **Armored Cable+** or **Metal Clad Cable+** currently Classified under the **Through Penetrating Product** category. See Through Penetrating Product (XHLY) category in the Fire Resistance Directory for names of manufacturers

4. **Busway+** – Nom 23 in. (584 mm) wide by 4.5 in. (114 mm) deep (or smaller) "I" shaped aluminum and steel enclosure containing factory mounted copper bars rated for 600 V, 5000A or aluminum bars rated 600V, 4000A. A maximum of one busway to be installed within the opening. The annular space between the busway and the periphery of the opening shall be min 2 in. (51 mm) to max 22 in. (559 mm). Busway spaced min 6 in. (152 mm) from all other penetrants. Busway to be rigidly supported on both sides of wall assembly. The busway shall bear the UL Listing Mark and shall be installed in accordance with the National Electrical Code, NFPA 70. When Busway (Item 10B) is used in the opening, the FB-3000WT sealant shall be used.
 5. **Metallic Penetrants** – One or more metallic pipes, conduits or tubes to be installed within the opening. Annulus between penetrants is min 0 in. (point contact) to max 22 in. (559 mm) for FB-3000WT sealant and 12 in. (305 mm) for CP 25WB+ sealant, except that when the nom pipe diam exceeds 3 in. (76 mm), the minimum annular space between metallic penetrants and between metallic penetrants and other types of penetrants is 6 in. (152 mm). Annulus between penetrants and periphery of opening is 0 in. (point contact) to max 22 in. (559 mm) for FB-3000WT sealant and 12 in. (305 mm) for CP 25WB+ sealant except that the min annular space to periphery of opening is 3 in. (76 mm) when nom pipe diam exceeds 3 in. (76 mm). Penetrants rigidly supported on both sides of wall assembly. The following types and sizes of metallic pipes, conduits or tubing may be used:
 - A. **Steel Pipe** – Nom 12 in. (305 mm) diam (or smaller) Schedule 10 (or heavier) steel pipe.
 - B. **Iron Pipe** – Nom 12 in. (305 mm) diam (or smaller) cast or ductile iron pipe.
 - C. **Conduit** – Nom 6 in. (152 mm) diam (or smaller) rigid steel conduit, nom 4 in. (102 mm) diam (or smaller) electrical metallic tubing (EMT), or nom 4 in. (102 mm) diam (or smaller) steel Flexible Metal Conduit#.
 - D. **Copper Tube** – Nom 6 in. (152 mm) diam (or smaller) Regular (or heavier) copper pipe or Type L (or heavier) copper tube.
 - E. **Copper Pipe** – Nom 6 in. (152 mm) diam (or smaller) Regular (or heavier) copper pipe or Type L (or heavier) copper tube.
 6. **Pipe Insulation** – One or more max 3 in. (76 mm) diam (or smaller) metallic penetrants (pipe or tubing) may be insulated with the following types of pipe coverings. The annular space between the insulated penetrants and the periphery of the opening shall be min 0 in. (point contact) to max 5 in. (127 mm). The separation between the insulated penetrants and the other penetrants shall be a min 6 in. (152 mm) to max 22 in. (559 mm) for FB-3000WT sealant and 12 in. (305 mm) for CP 25WB+ sealant:
 - A. **Pipe Covering*** – Min 1 in. (25 mm) to max 2 in. (51 mm) thick hollow cylindrical heavy density min 3.5 pcf (56 kg/m³) glass fiber units jacketed on the outside with an all service jacket. Longitudinal joints sealed with metal fasteners or factory-applied self-sealing lap tape. Transverse joints secured with metal fasteners or with butt tape supplied with the product.

See **Pipe and Equipment Covering - Materials** (BRGU) category in the Building Materials Directory for names of manufacturers. Any pipe covering material meeting the above specifications and bearing the UL Classification Marking with a Flame Spread Index of 25 or less and a Smoke Developed Index of 50 or less may be used.
 - B. **Tube Insulation-Plastics+** – Min 1/2 in. (13 mm) to max 3/4 in. (19 mm) thick acrylonitrile butadiene/polyvinyl chloride (AB/PVC) flexible foam furnished in the form of tubing.

See **Plastics+** (QMFZ2) category in the Plastics Recognized Component Directory for names of manufacturers. Any Recognized Component tube insulation material meeting the above specifications and having a UL 94 Flammability Classification of 94-5VA may be used.
 - C. **Pipe Covering Materials*** – Min 1 in. (25 mm) to max 2 in. (51 mm) thick unfaced mineral fiber pipe insulation having a nom density of 3.5 pcf (56 kg/m³) or heavier and sized to fit the outside diam of pipe or tube. Pipe insulation secured with min 18 SWG steel wire spaced 12 in. (305 mm) OC.

See **Plastics+** (QMFZ2) category in the Plastics Recognized Component Directory for names of manufacturers. Any Recognized Component tube insulation material meeting the above specifications and having a UL 94 Flammability Classification of 94-5VA may be used.
- INDUSTRIAL INSULATION GROUP L L C** – High Temperature Pipe Insulation 1200, High Temperature Pipe Insulation BWT and High Temperature Pipe Insulation Thermaloc

C1. Sheathing Material – (Not shown) – Optional, used in conjunction with Item 6C. Foil-scrim-kraft or all service jacket material shall be wrapped around the outer circumference of the pipe covering material (Item 3B) with the kraft side exposed. Longitudinal joints sealed with metal fasteners.

See **Sheathing Materials** (BVDV) category in the Building Materials Directory for names of manufacturers. Any sheathing material meeting the above specifications and bearing the UL Classification Marking with a Flame Spread value of 25 or less and a Smoke Developed value of 50 or less may be used.

D. Pipe Covering Materials* – Cellular Glass Insulation – Nom 1-1/2 to 3 in. (38 to 76 mm) thick cellular glass units sized to the outside diam of the steel pipe and supplied in nom 24 in. (610 mm) long half sections or nom 18 in. (457 mm) long segments. Pipe insulation installed on pipe in accordance with the manufacturer's instructions.

PITTSBURGH CORNING CORP – FOAMGLAS

E. Metal Jacket – Used in conjunction with Item 6D. Min 12 in. (305 mm) long jacket formed from min 0.010 in. (0.25 mm) thick aluminum sheet cut to wrap tightly around the pipe insulation with a min 2 in. (51 mm) lap and secured using bands and seals of a similar material or min No. 18 AWG steel tie wire. Bands or steel tie wire to be located within 2 in. (51 mm) of each end of the jacket and spaced max 10 in. (254 mm) OC. Jacket installed with edge abutting surface of fill material on both surfaces of wall.

F. Pipe Insulation - Foamed Plastic* – Nom 1 in. (25 mm) thick polyisocyanurate foamed plastic units jacketed with an all service jacket. Longitudinal joints sealed with self-sealing lap tape. Transverse joints secured with butt tape. Nom 1/2 (13 mm) wide stainless steel band clamp to be secured around pipe insulation 1 in. (25 mm) from both surfaces of wall.

See **Foamed Plastic** (BRYX) category in the Building Materials Directory for names of manufacturers. Any foamed plastic pipe covering material meeting the above specifications and bearing the UL Classification Marking with a Flame Spread Index of 25 or less may be used.

7. Nonmetallic Penetrants – One or more nonmetallic pipes, conduits or tubes may be installed within the opening. Annulus between penetrants and periphery of opening is min 1 in. (25 mm) to max 22 in. (559 mm) for FB-3000WT sealant and 12 in. (305 mm) for CP 25WB+ sealant. Separation between metallic and nonmetallic penetrants is min 6 in. (152 mm). Penetrants rigidly supported on both sides of wall assembly. The following types and sizes of nonmetallic pipes, conduits or tubing may be used:

A. Polyvinyl Chloride (PVC) Pipe – Nom 2 in. (51 mm) diam (or smaller) solid or cellular core Schedule 40 PVC pipe for use in closed (process or supply) or vented (drain, waste or vent) piping systems.

B. Chlorinated Polyvinyl Chloride (CPVC) Pipe – Nom 2 in. (51 mm) diam (or smaller) SDR13.5 CPVC pipe for use in closed (process or supply) or vented (drain, waste or vent) piping systems.

C. Rigid Nonmetallic Conduit+ – Nom 2 in. (51 mm) diam (or smaller) Schedule 40 PVC conduit installed in accordance with the National Electrical Code (NFPA 70).

D. Electrical Nonmetallic Tubing (ENT)+ – Nom 2 in. (51 mm) diam (or smaller) corrugated wall ENT formed of polyvinyl chloride (PVC) installed in accordance with the National Electrical Code (NFPA 70).

E. Cross Linked Polyethylene Tubing – Nom 1 in. (25 mm) diam (or smaller) cross-linked polyethylene tubing for use in closed (process or supply) or vented (drain, waste or vent) piping systems.

8. Air Conditioning (AC) Line Set – One or more AC line sets installed within opening. Each AC line set consists of two pipes or tubes, tubing insulation and a thermostat cable as described below. The space between the AC line sets shall be min 2 in. (51 mm). The space between the AC line sets and the periphery of the opening shall be min 0 in. (point contact) to max 22 in. (559 mm) for FB-3000WT sealant and 12 in. (305 mm) for CP 25WB+ sealant. The AC line sets shall be spaced min 6 in. (152 mm) from uninsulated metallic penetrants and shall be rigidly supported on both sides of the wall assembly.

8A. Metallic Pipes – A max of two pipes or tubes to be installed in each AC line set. The following types and sizes of metallic pipes or tubing may be used:

A. Steel Pipe – Nom 1 in. (25 mm) diam (or smaller) Schedule 5 (or heavier) steel pipe.

B. Iron Pipe – Nom 1 in. (25 mm) diam (or smaller) cast or ductile iron pipe.

C. Copper Pipe – Nom 1 in. (25 mm) diam (or smaller) Regular (or heavier) copper pipe.

D. Copper Tube – Nom 1 in. (25 mm) diam (or smaller) Type L (or heavier) copper tube.

8B. Tube Insulation - Plastics# – Nom 3/4 in. (19 mm) thick acrylonitrile butadiene/polyvinyl chloride (AB/PVC) flexible foam furnished in the form of tubing. Tube insulation required for all copper tubes and pipes greater than nom 3/4 in. (19 mm) diam.

See **Plastics** (QMFZ2) category in the Recognized Component Directory for names of manufacturers. Any Recognized Component tube insulation material meeting the above specifications and having a UL 94 Flammability Classification of 94-5VA may be used.

8C. Cables – Max one 2/C No. 18 AWG (or smaller) control cable with polyvinyl chloride (PVC) insulation and jacket. Cable to be rigidly supported on both sides of wall assembly.

9. Steel Duct – (Not Shown) – Nom 12 in. (305 mm) diam (or smaller) No. 26 gauge (or heavier) spiral wound or long seam galv steel duct may be installed within opening when opening contains no cables or cable tray. The duct shall be constructed and reinforced in accordance with SMACNA construction standards. A max of two steel ducts may be installed within the opening. Ducts to be spaced min 4 in. (102 mm) apart and min 8 in. (203 mm) from insulated penetrants and nonmetallic penetrants. Annulus between the steel duct and the periphery of the opening shall be min 0 in. (point contact) to max 22 in. (559 mm) for FB-3000WT sealant and 12 in. (305 mm) for CP 25WB+ sealant. Steel ducts to be rigidly supported on both sides of wall assembly.

10. Firestop System – The firestop system shall consist of the following items:

- A. **Packing Material** – Min 4 in. (102 mm) thickness (2 hr walls) or min 3-1/2 in. (89 mm) thickness (1 hr walls) of min 4 pcf (64 kg/m³) mineral wool batt insulation compressed min 50 percent and tightly packed into opening between and around all penetrants as a permanent form, to full depth of the wall. Packing material recessed from both surfaces of wall to accommodate the required thickness of fill material.
- B. **Fill, Void or Cavity Materials*-Sealant** – Min 5/8 in. (16 mm) depth of fill material applied within the annulus, flush with both surfaces of the wall assembly. Additional fill material forced into interstices of all grouped cables, grouped penetrants, and grouped cables within cable trays. At point contact locations between through penetrants and gypsum board, a min 1/2 in. (13 mm) diam bead of fill material shall be applied at through penetrant/gypsum board interface on both surfaces of the wall. When Busway (Item 4) is used in the opening, the FB-3000WT sealant shall be used.

3M COMPANY — CP 25 WB+ or FB-3000WT (CP 25WB+ not suitable for use with CPVC pipes)

Through Penetrations

Combos

8000 Series

WL



*Indicates such products shall bear the UL or cUL Certification Mark for jurisdictions employing the UL or cUL Certification (such as Canada), respectively.

Reprinted from the Online Certifications Directory with permission from UL©

Combos • Wood Frame Floor/Ceiling

| 3M UL Systems | "F" Rating | 3M Product | Through Penetrant Details |
|---------------|------------|--|--|
| F-C-8012 | 1 | 3M™ Fire Barrier Sealant CP 25WB+ 3M™ Fire Barrier Sealant IC 15WB+ 3M™ Fire Barrier Wrap Strips FS-195+ 3M™ Fire Barrier Moldable Putty Stix MP+ 3M™ Fire Barrier Water Tight Sealant 3000 WT | Bundle min 42% to max 54% of area: 3/4" steel pipe, 3/4" steel EMT, 3/4" steel conduit, 3/4" copper pipe, 3/4" copper tubing. One non-metallic: 1-1/4" PVC (closed or vented). 1-1/4" SDR 13.5 CPVC (closed) 1-1-1/4" ENT. 7/c 12 AWG cables. 1/2" AB/PVC insulation, 1/2" glass fiber insulation. Max diam of opening 4-1/2". Min 1/2" annular. 1 hour F Rating. Also referred as FC8012. |
| F-C-8013 | 1 | 3M™ Fire Barrier Sealant CP 25WB+ 3M™ Fire Barrier Sealant IC 15WB+ 3M™ Fire Barrier Sealant FD 150+ 3M™ Fire Barrier Ultra Plastic Pipe Device 3M™ Fire Barrier Moldable Putty Stix MP+ 3M™ Fire Barrier Water Tight Sealant 3000 WT | Bundle of all penetrants min 42% to max 54%: 3/4" steel pipe, 3/4" steel EMT, 3/4" steel conduit. 3/4" copper tubing. 1-1/4" PVC (closed or vented), 1-1/4" SDR 13.5 CPVC (closed or vented), 1-1/4" ENT. 7/C 12 AWG cables. Nom 1/2" AB/PVC insulation, 1/2" glass fiber insulation. Max diam of opening 4-1/2". Min 1/4" annular. 1 hour F Rating. Optional chase wall. Also referred as FC8013. |
| F-C-8020 | 1 | 3M™ Fire Barrier Sealant CP 25WB+ 3M™ Fire Barrier Sealant IC 15WB+ 3M™ Fire Barrier Sealant FD 150+ 3M™ Fire Barrier Moldable Putty Stix MP+ 3M™ Fire Barrier Wrap Ultra GS 3M™ Fire Barrier Water Tight Sealant 3000 WT | Bundle of penetrants min 40% to max 54% of opening: 1-1/4" PVC (closed or vented), 1-1/4" SDR 13.5 CPVC (closed). 7/c with ground No. 12 AWG cable. Nom 5/8" AB/PVC insulation. Max diam of opening 4-1/2". Chase wall optional. Steel collar required. Min 1/4" to max 1/2" annular. Also known as FC8020. |
| F-C-8024 | 1 | 3M™ Fire Barrier Sealant CP 25WB+ 3M™ Fire Barrier Sealant IC 15WB+ 3M™ Fire Barrier Water Tight Sealant 3000 WT | Multiple metallic: 3/4" steel pipe, 3/4" steel EMT, 3/4" steel conduit, 3/4" copper tubing, 3/4" copper pipe. One nonmetallic: 1-1/2" PVC (closed or vented), 1-1/2" SDR 13.5 CPVC (closed), 1-1/2" RNC. 7/C No. 12 AWG power & control cables. Max diam of opening 5". Concentric or eccentric installation. See system for spacing & annular requirements. Chase wall optional. 1 hour F Rating. Also known as FC8024. |
| F-C-8047 | 1 | 3M™ Fire Barrier Sealant CP 25WB+ 3M™ Fire Barrier Sealant IC 15WB+ 3M™ Fire Barrier Water Tight Sealant 3000 WT | 2" Steel Pipe, 2" Iron Pipe, 2" Copper Pipe, 2" Conduit, Cables, 2" PVC, CPVC, RNC, ENT, PEX penetrating a floor/ceiling assembly. Opening max 43-1/2 sq. in. with max width of 3" and max length of 14-1/2". |
| F-E-8001 | 1 | 3M™ Fire Barrier Sealant CP 25WB+ 3M™ Fire Barrier Sealant IC 15WB+ 3M™ Fire Barrier Sealant FD 150+ 3M™ Fire Barrier Wrap Strips FS-195+ 3M™ Fire Barrier Moldable Putty Stix MP+ 3M™ Fire Barrier Water Tight Sealant 3000 WT | Min 42% to max 54% bundle: 3/4" steel pipe, 3/4" steel EMT, 3/4" steel conduit, 3/4" copper tubing, 3/4" copper pipe. Metallic larger than 1/2" must be insulated: 1/2" AB/PVC insulation, 1/2" glass fiber insulation. Max 1 Nonmetallic: 1-1/4" PVC (closed or vented), -1/4" SDR 13.5 CPVC (closed), 1-1/4" ENC. 7/C No. 12 AWG cable Max diam of opening 4-1/2". Min 1/4" annular. 1 hour F. Also known as FE8001. |
| F-E-8002 | 1 | 3M™ Fire Barrier Sealant CP 25WB+ 3M™ Fire Barrier Sealant IC 15WB+ 3M™ Fire Barrier Sealant FD 150+ 3M™ Fire Barrier Moldable Putty Stix MP+ 3M™ Fire Barrier Water Tight Sealant 3000 WT | Min 42% to max 54% bundle: 3/4" steel pipe, 3/4" steel EMT, 3/4" steel conduit, 3/4" copper tubing, 3/4" copper pipe. Metallic larger than 1/2" must be insulated: 1/2" AB/PVC insulation, 1/2" glass fiber insulation. Max 1: 1-1/4" PVC (closed or vented), -1/4" SDR 13.5 CPVC (closed), 1-1/4" ENC. 7/C No. 12 AWG cable Max diam of opening 4-1/2". Min 1/4" annular. 1 hour F. Also known as FE8002. |
| F-E-8005 | 1 | 3M™ Fire Barrier Sealant CP 25WB+ 3M™ Fire Barrier Sealant IC 15WB+ 3M™ Fire Barrier Water Tight Sealant 3000 WT | One or more metallic: 3/4" steel pipe, 3/4" steel EMT, 3/4" steel conduit, 3/4" copper pipe, 3/4" copper tubing. One nonmetallic: 1-1/2" PVC (closed or vented), 1-1/2" SDR 13.5 CPVC (closed), 1-1/2" RNC. 3/4" AB/PVC insulation. Max 2 7/C No. 12 AWG. Max diam of opening 5". Concentric or eccentric installation. Point contact to max 1" annular. 1 hour F Rating. Also known as FE8005. |

System No. F-C-8012

May 19, 2005

F Rating – 1 Hr

T Rating – 1 Hr

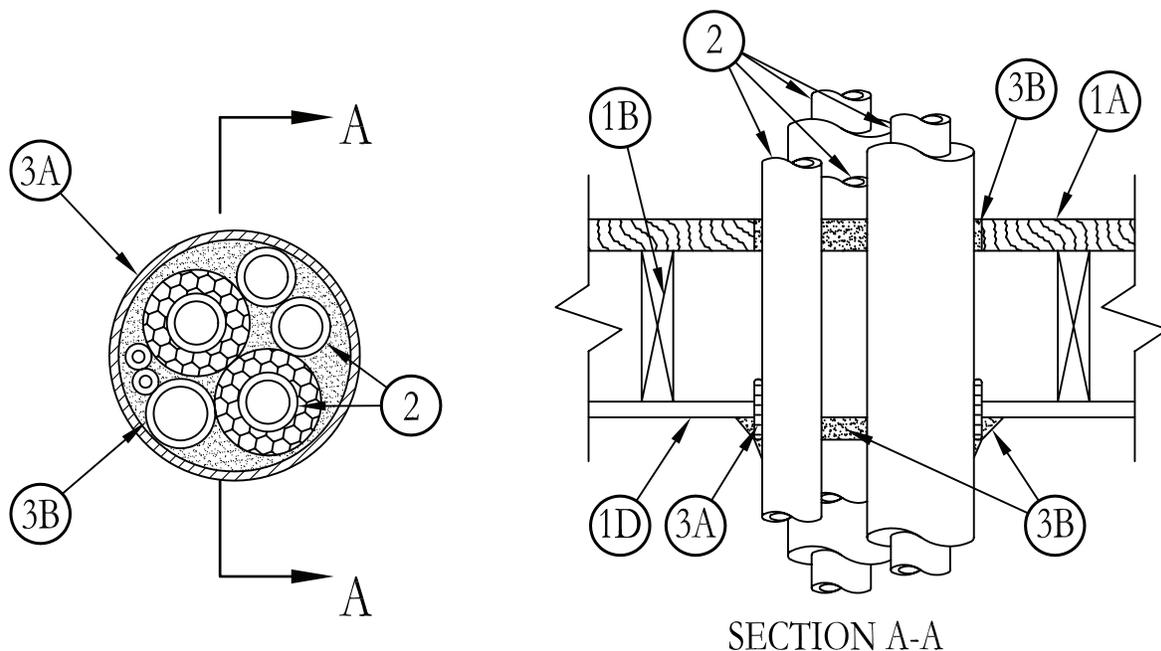

1. **Floor-Ceiling Assembly** – The 1 hr fire-rated solid or trussed lumber joist floor-ceiling assembly shall be constructed of the materials and in the manner specified in the individual L500 Series Floor-Ceiling Designs in the UL Fire Resistance Directory, as summarized below:
 - A. **Flooring System** – Lumber or plywood subfloor with finish floor of lumber, plywood or **Floor Topping Mixture*** as specified in the individual Floor-Ceiling Design. Max diam of floor opening is 4-1/2 in. (114 mm).
 - B. **Joists** – Nom 10 in. (254 mm) deep (or deeper) lumber, steel or combination lumber and steel joists, trusses or **Structural Wood Members*** with bridging as required and with ends firestopped.
 - C. **Gypsum Board*** – Nom 4 ft (122 cm) wide by 5/8 in. (16 mm) thick as specified in the individual Floor-Ceiling Design. Wallboard nailed to wood joists. Max diam of ceiling opening is 4-1/2 in. (114 mm).
- 1.1 **Chase Wall** – (Optional, not shown) – The through penetrants (Item 2) may be routed through a 1 hr fire-rated single, double or staggered wood stud/gypsum wallboard chase wall constructed of the material and in the manner specified in the individual U300 Series Wall and Partition Designs in the UL Fire Resistance Directory and shall include the following construction features:
 - A. **Studs** – Nom 2 in. by 6 in. (51 mm by 152 mm) or double nom 2 in. by 4 in. (51 mm by 102 mm) lumber studs.
 - B. **Sole Plate** – Nom 2 in. by 6 in. (51 mm by 152 mm) 1 or parallel 2 in. by 4 in. (51 mm by 102 mm) lumber plates, tightly butted.
 - C. **Top Plate** – The double top plate shall consist of two nom 2 in. by 6 in. (51 mm by 152 mm) or two sets of parallel 2 in. by 4 in. (51 mm by 102 mm) lumber plates, tightly butted. Max diam of opening is 4-1/2 in. (114 mm).
 - D. **Gypsum Board*** – Thickness, type, number of layers and fasteners shall be as specified in individual Wall and Partition Design.
2. **Through Penetrants** – Pipes, conduits, tubing or cables to be bundled within the opening such that the aggregate cross-sectional area of penetrants in opening to be min 42 percent to max 54 percent of the cross-sectional area of the opening in floor-ceiling. A min 1/4 in. (6 mm) annular space shall be maintained around uninsulated metallic pipes. The space between penetrants and periphery of opening shall be min 1/4 in. (6 mm). Penetrants to be rigidly supported on both sides of floor or wall assembly. The following types and sizes of penetrants may be used:
 - A. **Metallic Pipes** – The following types and sizes of metallic pipes, conduits or tubing may be used:
 - A1. **Steel Pipe** – Nom 3/4 in. (19 mm) diam (or smaller) Schedule 5 (or heavier) steel pipe.
 - A2. **Conduit** – Nom 3/4 in. (19 mm) diam (or smaller) steel electrical metallic tubing or steel conduit.
 - A3. **Copper Tubing** – Nom 3/4 in. (19 mm) diam (or smaller) Type L (or heavier) copper tubing.
 - A4. **Copper Pipe** – Nom 3/4 in. (19 mm) diam (or smaller) Regular (or Heavier) copper pipe.All pipes, conduits or tubing larger than nom 1/2 in. (13 mm) diam shall be provided with pipe covering (Item 2D).
 - B. **Nonmetallic Pipes** – A max of one nonmetallic pipe or conduit may be used. A min 1/4 in. (6 mm) space shall be maintained between uninsulated metallic pipes and nonmetallic pipes or conduits. The following Types and sizes of nonmetallic pipes or conduits may be used:
 - B1. **Polyvinyl Chloride (PVC) Pipe** – Nom 1-1/4 in. (32 mm) diam (or smaller) Schedule 40 solid core PVC pipe for use in closed (Process or supply) or vented (drain, waste or vent) piping system.
 - B2. **Chlorinated Polyvinyl Chloride (CPVC) Pipe** – Nom 1-1/4 in. (32 mm) diam (or smaller) SDR13.5 CPVC pipe for use in closed (process or supply) piping systems.
 - B3. **Rigid Nonmetallic Conduit++** – Nom 1-1/4 in. (32 mm) diam (or smaller) Schedule 40 PVC conduit installed in accordance with Article 347 of the National Electrical Code (NFPA No. 70).

System No. F-C-8012 *continued*

- C. **Cables** – Max 7/C No. 12 AWG multiconductor power and control cables; XLPE or PVC insulation with XLPE or PVC jacket.
- D. **Pipe Covering** – The following types and sizes of pipe coverings may be used with the metallic pipes:
- D1. **Tube Insulation – Plastics+** – Nom 1/2 in. (13 mm) thick acrylonitrile butadiene/polyvinyl chloride (AB/PVC) flexible foam furnished in the form of tubing.
See **Plastics+** (QMFZ2) category in the Recognized Component Directory for names of manufacturers. Any Recognized Component tube insulation material meeting the above specifications and having a UL 94 Flammability Classification of 94-5VA may be used.
- D2. **Pipe Covering*** – Nom 1/2 in. (13 mm) thick hollow cylindrical heavy (min 3.5 pcf or 56 kg/m³) density glass fiber units jacketed on the outside with an all service jacket. Longitudinal joints sealed with metal fasteners or factory-applied self-sealing lap tape. Transverse joints secured with metal fasteners or with but tape supplied with the product.
See **Pipe and Equipment Covering – Materials** (BRGU) category in the Building Materials Directory for names of manufacturers. Any pipe covering material meeting the above specifications and bearing the UL Classification Marking with a Flame Spread Index of 25 or less and a Smoke Developed Index of 50 or less may be used.
3. **Firestop System** – The details of the firestop system shall be as follows:
- A. **Fill, Void or Cavity Materials* – Wrap Strip** – Nom 1/4 in. (6 mm) thick intumescent material supplied in 2 in. (51 mm) wide strips. One wrap strip tightly wrapped around perimeter of penetrants (foil side exposed) and held in position using two steel wire ties. Wrap strip recessed into opening such that 3/4 in. to 1 in. (19 mm to 51 mm) extends below the bottom surface of the gypsum wallboard ceiling or top plate when optional chase wall is used.
3M COMPANY – FS-195+
- B. **Fill, Void or Cavity Materials* – Caulk, Sealant or Putty** – Min 3/4 in. (19 mm) thickness of caulk or putty applied to completely fill annular space inside of wrap strip and between penetrants, flush with the bottom surface of ceiling and extending downward. Min 5/8 in. (16 mm) thickness of caulk or putty applied within annular space between wrap strip and periphery of opening flush with bottom surface of ceiling or top plate. Min 1/2 in. (13 mm) crown of caulk or putty applied around the perimeter of the wrap strip at its interface with the gypsum wallboard ceiling or top plate. Min 3/4 in. (19 mm) thickness of caulk or putty applied to completely fill annular space, flush with top surface of floor.
3M COMPANY – CP 25WB+, IC 15WB+ caulk, FB-3000 WT sealant or MP+ Stix putty.
(Note: CP 25WB+ not suitable for use with CPVC pipes.)

*Bearing the UL Classification Mark

++Bearing the UL Listing Mark

Reprinted from the Online Certifications Directory with permission from Underwriters Laboratories Inc.
Copyright © 2010 Underwriters Laboratories Inc.®



Note: Systems with Nonmetallic Through Penetrant(s) have not been evaluated with a pressure differential of 50 Pa between the exposed and unexposed surfaces as required by the National Building Code of Canada.

Through Penetrations

Compos

8000 Series

Floor/Ceiling

FC

System No. F-C-8013

November 20, 2009

F Rating – 1 Hr

T Rating – 1 Hr

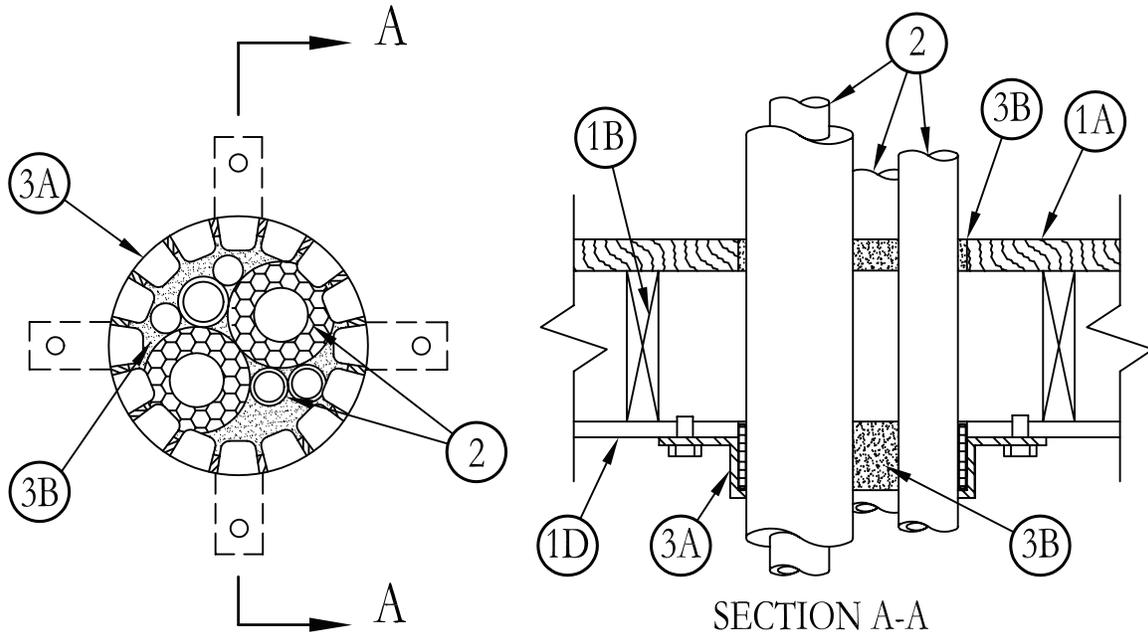

1. **Floor-Ceiling Assembly** – The 1 hr fire-rated solid or trussed lumber joist floor-ceiling assembly shall be constructed of the materials and in the manner specified in the individual L500 Series Floor-Ceiling Designs in the UL Fire Resistance Directory, as summarized below:
 - A. **Flooring System** – Lumber or plywood subfloor with finish floor of lumber, plywood or **Floor Topping Mixture*** as specified in the individual Floor-Ceiling Design. Max diam of floor opening is 4-1/2 in. (114 mm).
 - B. **Joists** – Nom 10 in. (254 mm) deep (or deeper) lumber, steel or combination lumber and steel joists, trusses or **Structural Wood Members*** with bridging as required and with ends firestopped.
 - C. **Gypsum Board*** – Nom 4 ft (122 cm) wide by 5/8 in. (16 mm) thick as specified in the individual Floor-Ceiling Design. Gypsum board nailed to wood joists. Max diam of ceiling opening is 4-1/2 in. (114 mm).
- 1.1 **Chase Wall** – (Optional, not shown) – The through penetrants (Item 2) may be routed through a 1 hr fire-rated single, double or staggered wood stud/gypsum board chase wall constructed of the material and in the manner specified in the individual U300 Series Wall and Partition Designs in the UL Fire Resistance Directory and shall include the following construction features:
 - A. **Studs** – Nom 2 by 6 in. (51 by 152 mm) or double nom 2 by 4 in. (51 by 102 mm) lumber studs.
 - B. **Sole Plate** – Nom 2 by 6 in. (51 by 152 mm) or parallel 2 by 4 in. (51 by 102 mm) lumber plates, tightly butted.
 - C. **Top Plate** – The double top plate shall consist of two nom 2 by 6 in. (51 by 152 mm) or two sets of parallel 2 by 4 in. (51 by 102 mm) lumber plates, tightly butted. Max diam of opening is 4-1/2 in. (114 mm).
 - D. **Gypsum Board*** – Thickness, type, number of layers and fasteners shall be as specified in individual Wall and Partition Design.
2. **Through Penetrants** – Pipes, conduits, tubing or cables to be bundled within the opening such that the aggregate cross-sectional area of penetrants in opening to be min 42 percent to max 54 percent of the cross-sectional area of the opening in floor-ceiling. A min 1/4 in. (6 mm) annular space shall be maintained around uninsulated metallic pipes. The space between penetrants and periphery of opening shall be min 1/4 in. (6 mm). Penetrants to be rigidly supported on both sides of floor or wall assembly. The following types and sizes of penetrants may be used:
 - A. **Metallic Pipes** – The following types and sizes of metallic pipes, conduits or tubing may be used:
 - A1. **Steel Pipe** – Nom 3/4 in. (19 mm) diam (or smaller) Schedule 5 (or heavier) steel pipe.
 - A2. **Conduit** – Nom 3/4 in. (19 mm) diam (or smaller) electrical metallic tubing or steel conduit.
 - A3. **Copper Tubing** – Nom 3/4 in. (19 mm) diam (or smaller) Type L or heavier) copper tubing.**All Pipes, conduits or tubing larger than nom 1/2 in. (13 mm) diam shall be provided with pipe covering (Item 3).**
 - B. **Nonmetallic Pipes** – A max of one nonmetallic pipe or conduit may be used. A min 1/4 in. (6 mm) space must be maintained between uninsulated metallic pipes and nonmetallic pipes or conduits. The following types and sizes of nonmetallic pipes or conduits may be used:
 - B1. **Polyvinyl Chloride (PVC) Pipe** – Nom 1-1/4 in. (32 mm) diam (or smaller) Schedule 40 solid core PVC pipe for use in closed (process or supply) or vented (drain, waster or vent) piping system.
 - B2. **Chlorinated Polyvinyl Chloride (CPVC) Pipe** – Nom 1-14 in. (32 mm) diam (or smaller) SDR13.5 CPVC pipe for use in closed (process or supply) piping systems.
 - B3. **Rigid Nonmetallic Conduit++** – Nom 1-1/4 in. (32 mm) diam (or smaller) Schedule 40 PVC conduit installed in accordance with Article 347 of the National Electrical Code (NFPA No. 70).
 - C. **Cables** – Max 7/C No. 12 AWG multiconductor power and control cables; XLPE or PVC insulation with XLPE or PVC jacket.

System No. F-C-8013 *continued*

D. **Pipe Covering** – The following types and sizes of pipe coverings may be used with the metallic pipes:

D1. **Tube Insulation – Plastics+** – Nom 1/2 in. (13 mm) thick acrylonitrile butadiene/polyvinyl chloride (AB/PVC) flexible foam furnished in the form of tubing.

See **Plastics+** (QMFZ2) category in the Recognized Component Directory for names of manufacturers. Any Recognized Component tube insulation material meeting the above specifications and having a UL 94 Flammability Classification of 94-5VA may be used.

D2. **Pipe Covering*** – Nom 1/2 in. (13 mm) thick hollow cylindrical heavy density (min 3.5 pcf or 56 kg/m³) glass fiber units jacketed on the outside with an all service jacket. Longitudinal joints sealed with metal fasteners or factory-applied self sealing lap tape. Transverse joints secured with metal fasteners or with butt tape supplied with the product.

See **Pipe and Equipment Covering – Materials** (BRGU) category in the Building Materials Directory for names of manufacturers. Any pipe covering material meeting the above specifications and bearing the UL Classification Marking with a Flame Spread Index of 25 or less and a Smoke Developed Index of 50 or less may be used.

3. **Firestop System** – The details of the firestop system shall be as follows:

A. **Firestop Device*** – Firestop device consisting of a steel collar lined with intumescent material and provided with steel clips for attachment to underside of ceiling or top plate when optional chase wall is used in accordance with accompanying installation instructions. The following firestop devices are to be used, dependent on the max opening size:

| Max Opening Size, In. (mm) | Firestop Device |
|----------------------------|-----------------|
| 3-1/2 (89 mm) | PPD 3 |
| 4-1/2 (114 mm) | PPD 4 |

3M COMPANY

B. **Fill, Void or Cavity Materials*** – **Caulk, Sealant or Putty** – Min 5/8 in. (16 mm) thickness of caulk or putty applied within annular space between penetrants and periphery of opening flush with bottom surface of ceiling or top plate. Additionally, when PPD 3 firestop device is used, min 1 in. (25 mm) thickness of caulk or putty applied to completely fill annular space inside of firestop device and between penetrants, flush with the bottom surface of ceiling or top plate and extending downward. When PPD 4 firestop device is used, min 2 in. (51 mm) thickness of caulk or putty applied to completely fill annular space inside of firestop device and between penetrants, flush with the bottom surface of ceiling or top plate and extending downward. Min 3/4 in. (19 mm) thickness of caulk or putty applied to completely fill annular space, flush with top surface of floor.

3M COMPANY – CP 25WB+caulk, MP+putty, IC 15WB caulk, FireDam 150+caulk or FB-3000 WT sealant.

(Note: CP 25WB+ and FireDam 150+ not suitable for use with CPVC pipes.)

*Bearing the UL Classification Mark

Reprinted from the Online Certifications Directory with permission from Underwriters Laboratories Inc.

Copyright © 2010 Underwriters Laboratories Inc.®



Note: Systems with Nonmetallic Through Penetrant(s) have not been evaluated with a pressure differential of 50 Pa between the exposed and unexposed surfaces as required by the National Building Code of Canada.

System No. F-C-8020

November 20, 2009

F Rating – 1 Hr

T Rating – 1/2 Hr

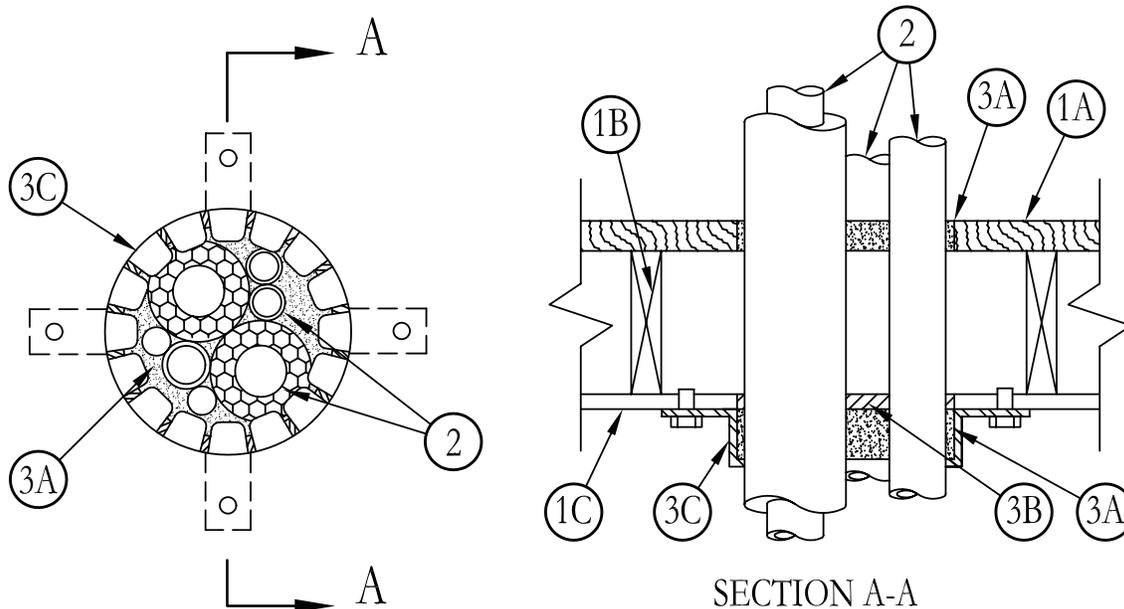

1. **Floor-Ceiling Assembly** – The 1 hr fire-rated solid or trussed lumber joist floor-ceiling assembly shall be constructed of the materials and in the manner specified in the individual L500 series Floor-Ceiling Design in the UL Fire Resistance Directory. The general construction details of floor-ceiling assembly are summarized below:
 - A. **Floor System** – Lumber or plywood subfloor with finish floor of lumber, plywood or **Floor Topping Mixture*** as specified in the individual floor-ceiling design. Max diam of opening is 4-1/2 in. (114 mm).
 - B. **Wood Joists** – Nom 10 in. (254 mm) deep (or deeper) lumber, steel or combination lumber and steel joists, trusses or **Structural Wood Members*** with bridging as required and with ends firestopped.
 - C. **Gypsum Board*** – Nom 5/8 in. (16 mm) thick as specified in the individual floor-ceiling design.
- 1.1 **Chase Wall** – (Optional, not shown)–The through penetrants (Item 2) may be routed through a fire-rated single, double or staggered wood stud/gypsum wallboard chase wall having a fire rating consistent with that of the floor-ceiling assembly. The chase wall shall be constructed of the materials and in the manner specified in the individual U300 series Wall and Partition Design in the UL Fire Resistance Directory and shall include the following construction features:
 - A. **Studs** – Nom 2 by 6 in. (51 by 152 mm) or double nom 2 by 4 in. (51 by 102 mm) lumber studs.
 - B. **Sole Plate** – Nom 2 by 6 in. (51 by 152 mm) or parallel 2 by 4 in. (51 by 102 mm) lumber plates, tightly butted.
 - C. **Top Plate** – The double top plate shall consist of two nom 2 by 6 in. (51 by 152 mm) or two sets of parallel 2 by 4 in. (51 by 102 mm) lumber plates, tightly butted. Max diam of opening is 4-1/2 in. (114 mm).
 - D. **Gypsum Board*** – Thickness, type, number of layers and fasteners shall be as specified in individual wall and partition design.
2. **Through Penetrants** – Pipes, conduits, tubing and cables to be bundled within the opening such that the aggregate cross-sectional area of penetrants in opening to be min 40 percent to max 54 percent of the cross-sectional area of the opening in floor-ceiling assembly. A min 1/4 in. (6 mm) annular space shall be maintained around uninsulated metallic pipes. The annular space between penetrants and periphery of opening shall be min 1/4 in. (6 mm) to max 1/2 in. (13 mm). Penetrants to be rigidly supported on both sides of floor or wall assembly. The following types and sizes of penetrants may be used:
 - A. **Metallic Pipes** – The following type and size of metallic tubing may be used:
 - A1. **Copper Tubing** – Nom 3/4 in. (19 mm) diam (or smaller) Type L copper tubing.
 - A2. **Copper Pipe** – Nom 3/4 in. (19 mm) diam (or smaller) Regular (or heavier) copper pipe.**All pipes and tubing greater than nom 1/2 in. (13 mm) diam shall be provided with pipe covering (Item 2D).**
 - B. **Nonmetallic Pipes** – A max of one nonmetallic pipe may be used. A min 1/4 in. (6 mm) space must be maintained between uninsulated metallic pipes and nonmetallic pipes. The following type and size of nonmetallic pipe may be used:
 - A1. **Polyvinyl Chloride (PVC) Pipe** – Nom 1-1/4 in. (32 mm) diam (or smaller) Schedule 40 solid core PVC pipe for use in closed (process or supply or vented (drain, waste or vent) piping system.
 - A2. **Chlorinated Polyvinyl Chloride (CPVC) Pipe** – Nom 1-1/4 in. (32 mm) diam (or smaller) SDR 13.5 CPVC pipe for use in closed (process or supply) piping system.
 - C. **Cables** – Max 7/C with ground No. 12 AWG (or smaller) multiconductor power or control cable with PVC insulation and jacket materials.
 - D. **Pipe Covering – Tube Insulation – Plastics+** – Nom 5/8 in. (16 mm) thick acrylonitrile butadiene/polyvinyl chloride (AB/PVC) flexible foam furnished in the form of tubing.

See **Plastics** (QMfZ2) category in the Recognized Component Directory for names of manufacturers. Any Recognized Component tube insulation material meeting the above specifications and having a UL 94 Flammability Classification of 94-5VA may be used.

System No. F-C-8020 *continued*

3. **Firestop System** – The firestop system shall consist of the following::
- A. **Fill, Void or Cavity Materials* – Putty, Sealant or Caulk** – Min 5/8 in. (16 mm) thickness of putty or caulk applied to completely fill annular space and interstices between penetrants flush with the bottom surface of the ceiling or top plate. Min 3/4 in. (19 mm) thickness of putty or caulk applied to completely fill annular space and interstices between penetrants flush with the top surface of the floor or sole plate. An additional 1/2 in. (13 mm) diam bead of putty or caulk to be installed around the outside of steel collar (Item 3C) at the collar/gypsum board interface
- 3M COMPANY** – MP+ putty, CP 25WB+ caulk, IC 15WB+ caulk, FireDam 150+ caulk or FB-3000 WT.
(Note: CP 25WB+ and FireDam 150+ not suitable for use with CPVC pipes.)
- B. **Fill, Void or Cavity Materials* – Wrap Strip** – Min three continuous layers of 2 in. (51 mm) wide wrap strip installed around penetrants and tightly butted against the bottom of the ceiling.
- 3M COMPANY** – Ultra GS
- C. **Steel Collar** – Nom 2 in. (51 mm) deep collar with 1-1/4 in. (32 mm) wide by 2 in. (51 mm) long anchor tabs and min 3/4 in. (19 mm) long tabs to retain wrap strip layers. Coils of precut min 0.016 in. (.41 mm) thick (28 gauge) galv sheet steel are available from wrap strip manufacturer. As an alternate, collar may be field fabricated from min 0.016 in. (.41 mm) thick (28 gauge) galv sheet steel in accordance with instruction sheet supplied by wrap strip manufacturer. Steel collar, with anchor tabs bent outward 90 degrees, wrapped tightly around wrap strip layers with min 1 in. (25 mm) overlap at the seam. A min 1/2 in. (13 mm) wide by min 0.028 in. (.71 mm) thick stainless steel band clamp secured around collar at midheight. As an alternate to the band clamp, collar may be fastened together along the overlapping seam with three No. 6 by 3/8 in. (152 by 10 mm) long self-tapping steel screws. Collar secured to gypsum lboard ceiling using 3/16 in. (5 mm) diam steel toggle bolts in conjunction with 1-1/4 in. (32 mm) diam steel fender washers. Collar secured to top plate when chase wall is used using min 1 in. (25 mm) long No. 12 (or larger) steel wood screws in conjunction with 1-1/4 in. (32 mm) diam steel fender washers. Wrap strip retainer tabs to be bent 90 degrees toward pipe to lock wrap strip layers in position. Min of four symmetrically located anchors required.

*Bearing the UL Classification Mark

+Bearing the UL Recognized Component Marking

Reprinted from the Online Certifications Directory with permission from Underwriters Laboratories Inc.
Copyright © 2010 Underwriters Laboratories Inc.®



Note: Systems with Nonmetallic Through Penetrant(s) have not been evaluated with a pressure differential of 50 Pa between the exposed and unexposed surfaces as required by the National Building Code of Canada.

Through Penetrations

Compos

8000 Series

Floor/Ceiling

FC

System No. F-C-8024

May 19, 2005
F Rating – 1 Hr
T Rating – 1/4 Hr

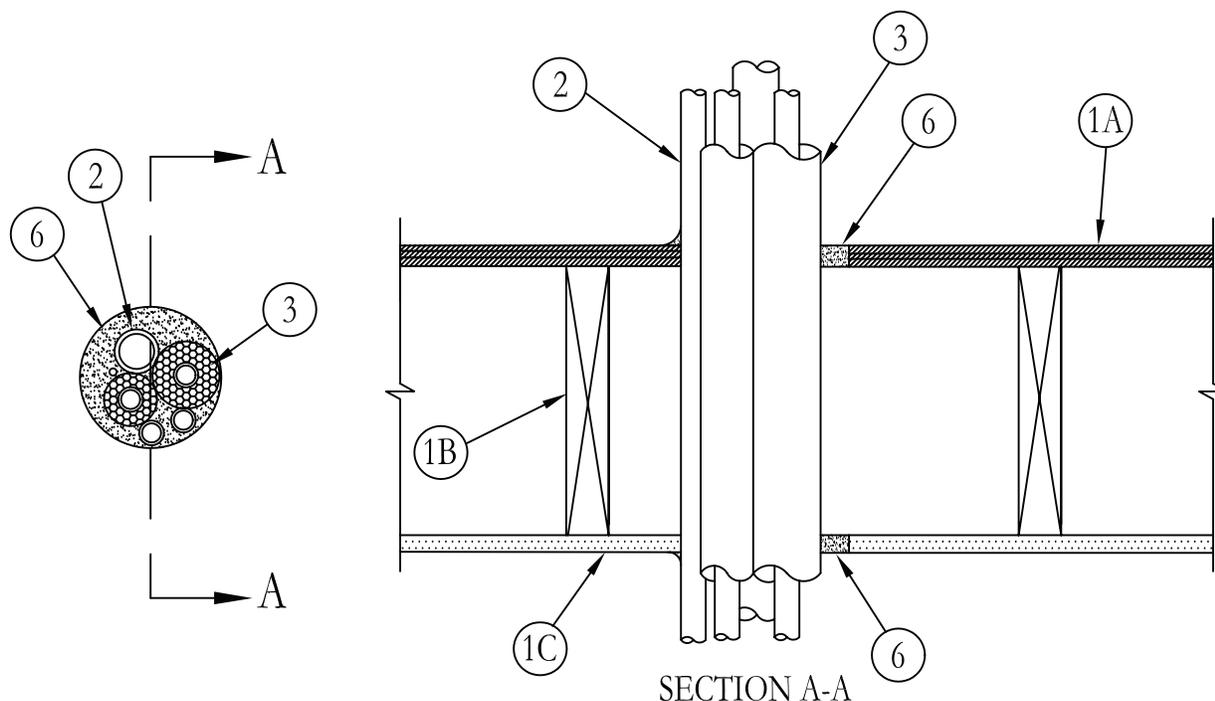

1. **Floor-Ceiling Assembly** – The 1 hr fire-rated solid or trussed lumber joist floor-ceiling assembly shall be constructed of the materials and in the manner specified in the individual L500 Series Floor-Ceiling Designs in the UL Fire Resistance Directory. The general construction details of the floor-ceiling assembly are summarized below:
 - A. **Flooring System** – Lumber or plywood subfloor with finish floor of lumber, plywood or **Floor Topping Mixture*** as specified in the individual Floor-Ceiling Design. Max diam of opening is 5 in. (127 mm).
 - B. **Wood Joists** – Nom 10 in. (254 mm) deep (or deeper) lumber, steel or combination lumber and steel joists, trusses or **Structural Wood Members*** with bridging as required and with ends firestopped.
 - C. **Gypsum Board*** – Nom 4 ft (122 mm) wide by 5/8 in. (16 mm) thick as specified in the individual Floor-Ceiling Design. Max diam of opening is 5 in. (127 mm).
- 1.1 **Chase Wall** (Optional, not shown) – The through penetrants (Item No. 2) may be routed through a fire-rated single, double or staggered wood stud/gypsum board chase wall having a fire rating consistent with that of the floor-ceiling assembly. The chase wall shall be constructed of the materials and in the manner specified in the individual U300 Series Wall and Partition Designs in the UL Fire Resistance Directory and shall include the following construction features:
 - A. **Studs** – Nom 2 in. by 6 in. (51 mm by 152 mm) or double nom 2 in. by 4 in. (51 mm by 102 mm) lumber studs.
 - B. **Sole Plate** – Nom 2 in. by 6 in. (51 mm by 152 mm) or parallel 2 in. by 4 in. (51 mm by 102 mm) lumber plates, tightly butted. Max diam of opening is 5 in. (127 mm).
 - C. **Top Plate** – The double top plate shall consist of two nom 2 in. by 6 in. (51 mm by 152 mm) or two sets of parallel 2 in. by 4 in. (51 mm by 102 mm) lumber plates, tightly butted. Max diam of opening is 5 in. (127 mm).
 - D. **Gypsum Board*** – Thickness, type, number of layers and fasteners shall be as specified in individual Wall and Partition Design.
2. **Through Penetrants** – One or more metallic pipes, conduits or tubing to be installed concentrically or eccentrically within opening. Pipes, conduits or tubing to be spaced min 0 in. (point contact) to max 1 in. (0 mm to max 25 mm) apart. The space between the pipes, conduits or tubing and the periphery of the opening shall be min 0 in. (point contact) to max 1 in. (0 mm to max 25 mm). Penetrants to be rigidly supported on both sides of floor-ceiling assembly. The following types and sizes of metallic pipe, conduits or tubing may be used:
 - A. **Steel Pipe** – Nom 3/4 in. (19 mm) diam (or smaller) Schedule 5 (or heavier) steel pipe.
 - B. **Conduit** – Nom 3/4 in. (19 mm) diam (or smaller) steel electrical metallic tubing or steel conduit.
 - C. **Copper Tubing** – Nom 3/4 in. (19 mm) diam (or smaller) Type L (or heavier) copper tubing.
 - D. **Copper Pipe** – Nom 3/4 in. (19 mm) diam (or smaller) Regular (or heavier) copper pipe.
3. **Tube Insulation-Plastics+** – Nom 3/4 in. (19 mm) thick (or less) acrylonitrile butadiene/polyvinyl chloride (AB/PVC) flexible foam furnished in the form of tubing. The annular space between the insulated penetrant and the periphery of the opening shall be min 0 in. (point contact) to max 1 in. (0 mm to max 25 mm).
See **Plastics** (QMFZ2) category in the Recognized Component Directory for names of manufacturers. Any Recognized Component tube insulation material meeting the above specifications and having a UL 94 Flammability Classification of 94-5A may be used.

Through Penetrations

Combos

8000 Series

Floor/Ceiling

FC

System No. F-C-8024 *continued*

Through Penetrations

Compos

8000 Series

Floor/Ceiling

FC

4. **Nonmetallic Pipes** – One nonmetallic pipe or conduit to be installed within the firestop system. Pipe or conduit to be spaced min 0 in. (point contact) to max 1 in. (0 mm to max 25 mm) from the insulated through penetrants and min 1/2 in. to max 1 in. (13 mm to max 25 mm) from non-insulated through penetrants. The space between the pipe or conduit and the periphery of the opening shall be min 0 in. (point contact) to max 1 in. (0 mm to max 25 mm). Pipe or conduit to be rigidly supported on both sides of floor-ceiling assembly. One of the following types and sizes of nonmetallic through penetrants may be used:
 - A. **Polyvinyl Chloride (PVC) Pipe** – Nom 1-1/2 in. (38 mm) diam (or smaller) Schedule 40 solid-core PVC pipe for use in closed (process or supply) or vented (drain, waste or vent) piping systems.
 - B. **Chlorinated Polyvinyl Chloride (CPVC) Pipe** – Nom 1-1/2 in. (38 mm) diam (or smaller) SDR13.5 CPVC pipe for use in closed (process or supply) piping systems.
 - C. **Rigid Nonmetallic Conduit**++ – Nom 1-1/2 in. (38 mm) diam (or smaller) Schedule 40 solid-core PVC conduit installed in accordance with Article 347 of the National Electrical Code (NFPA No. 70).
5. **Cables** – Max two 7/C (or less) No. 12 AWG (or smaller) multiconductor power and control cables with XLPE or PVC insulation with XLPE or PVC jacket. Cables to be spaced min 0 in. (point contact) to max 1 in. (0 mm to max 25 mm) from the insulated through penetrants and min 1/2 in. to max 1 in. (13 mm to max 25 mm) from non-insulated through penetrants. The space between the cables and the periphery of the opening shall be min 0 in. (point contact) to max 1 in. (0 mm to max 25 mm). Cables to be rigidly supported on both sides of the floor-ceiling assembly.
6. **Fill, Void or Cavity Materials* – Caulk or Sealant** – Min 3/4 in. (19 mm) thickness of caulk applied within annulus, flush with top surface of floor or sole plate. Min 5/8 in. (16 mm) thickness of caulk applied within annulus, flush with bottom surface of ceiling or top plate. Min 1/4 in. (6 mm) diam bead of caulk applied at point contact locations at penetrant/floor interface on top surface of floor or sole plate and at penetrant/ceiling or top plate interface.

3M COMPANY – CP 25WB+, IC 15WB+ caulk or FB-3000 WT sealant

(Note: CP 25WB+ not suitable for use with CPVC pipes.)

*Bearing the UL Classification Marking

+Bearing the UL Recognized Component Marking

++Bearing the UL Listing Mark

Reprinted from the Online Certifications Directory with permission from Underwriters Laboratories Inc.

Copyright © 2010 Underwriters Laboratories Inc.®



Note: This system was tested with a pressure differential of 50 Pa between the exposed and unexposed surfaces with the higher pressure on the exposed side.

System No. F-C-8047

October 05, 2015

| ANSI/UL1479 (ASTM E814) | CAN/ULC S115 |
|---|--|
| F Rating — 1 Hr | F Rating — 1 Hr |
| T Ratings — 1/2 and 1 Hr (See Item 2) | FT Ratings — 1/2 and 1 Hr (See Item 2) |
| L Rating At Ambient — Less Than 1 CFM/ft ² | FH Rating — 1 Hr |
| L Rating At 400 F — Less Than 1 CFM/ft ² | FTH Ratings — 1/2 and 1 Hr (See Item 2) |
| | L Rating At Ambient — Less Than 5.1 L/s/m ² |
| | L Rating At 400 F — Less Than 5.1 L/s/m ² |

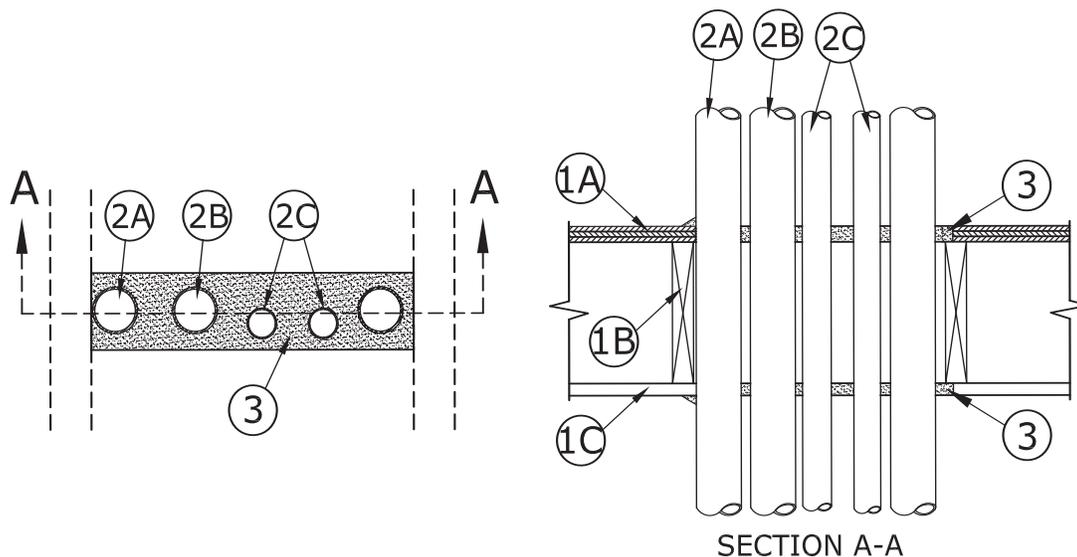

1. **Floor-Ceiling Assembly** — The 1 hr fire-rated wood joist floor-ceiling assembly shall be constructed of the materials and in the manner specified in the individual L500 Designs in the UL Fire Resistance Directory, as summarized below:
 - A. **Flooring System** — Lumber or plywood subfloor with finish floor of lumber, plywood or **Floor Topping Mixture*** as specified in the individual Floor-Ceiling Design. Max area of rectangular opening cut in flooring is 43-1/2 sq in. (0.028 m²) with a max width dimension of 3 in. (76 mm) and with a max length dimension of 14-1/2 in. (368 mm). Longer dimension of rectangular opening to be perpendicular to wood joist direction.
 - B. **Wood Joists** — Nom 10 in. (254 mm) deep (or deeper) lumber, steel or combination lumber and steel joists, trusses or **Structural Wood Members*** with bridging as required and with ends firestopped.
 - C. **Gypsum Board*** — Thickness, type, number of layers and fasteners as required in the individual Floor-Ceiling Design. Max area of rectangular opening cut in gypsum board ceiling is 43-1/2 sq in. (0.028 m²) with a max width dimension of 3 in. (76 mm) and with a max length dimension of 14-1/2 in. (368 mm).
 - 1A. **Chase Wall** — (Optional, Not Shown) - The through penetrants (Item 2) may be routed through a 1 hr fire rated single, double or staggered wood stud/gypsum board chase wall. Depth of chase wall stud cavity to be min 1/2 in. (13 mm) greater than width of opening cut in sole and top plates to accommodate the through penetrants. The chase wall shall be constructed of the materials and in the manner specified in the individual U300 Series Wall and Partition Designs in the UL Fire Resistance Directory and shall include the following construction features:
 - A. **Studs** — Nom 2 by 4 in. (51 by 102 mm), 2 by 6 in. (51 by 152 mm) or double nom 2 by 4 in. (51 by 102 mm) lumber studs.
 - B. **Sole Plate** — Nom 2 by 4 in. (51 by 102 mm), 2 by 6 in. (51 by 152 mm) or parallel 2 by 4 in. (51 by 102 mm) lumber plates, tightly butted. Max area of rectangular opening cut in sole plate is 43-1/2 sq in. (0.028 m²) with a max width dimension of 3 in. (76 mm) and with a max length dimension of 14-1/2 in. (368 mm).
 - C. **Top Plate** — The double top plate shall consist of two nom 2 by 4 in. (51 by 102 mm), two nom 2 by 6 in. (51 by 152 mm) or two sets of parallel 2 by 4 in. (51 by 102 mm) lumber plates, tightly butted. Max area of rectangular opening cut in top plate is 43-1/2 sq in. (0.028 m²) with a max width dimension of 3 in. (76 mm) and with a max length dimension of 14-1/2 in. (368 mm).
 - D. **Gypsum Board*** — Thickness, type, number of layers and fasteners shall be as specified in the individual Wall and Partition Design.
2. **Through Penetrants** — One or more metallic or nonmetallic pipes, conduits, tubing or cables to be installed either concentrically or eccentrically within the opening. Min separation between penetrants to be 1 in. (25 mm). Annular space between the penetrants and the periphery of the opening shall be min 0 in. (point contact) to max 1 in. (25 mm). Penetrants to be rigidly supported on both sides of floor-ceiling assembly. The following types and sizes of through penetrants may be used:
 - A. **Metallic Penetrants** — The following types and sizes of metallic pipes, conduits or tubes may be used:
 - A1. **Steel Pipe** — Nom 2 in. (51 mm) diam (or smaller) Schedule 5 (or heavier) steel pipe.
 - A2. **Iron Pipe** — Nom 2 in. (51 mm) diam (or smaller) cast or ductile iron pipe.

System No. F-C-8047 *continued*

- A3. **Copper Pipe or Tubing** — Nom 2 in. (51 mm) diam (or smaller) Type L (or heavier) copper tube or Regular (or heavier) copper pipe.
- A4. **Conduit** — Nom 2 in. (51 mm) diam (or smaller) rigid steel conduit, electrical metallic tubing (EMT) or flexible steel or aluminum conduit.
- B. **Nonmetallic Penetrants** — The following types and sizes of nonmetallic pipes, conduits or tubes may be used:
- B1. **Polyvinyl Chloride (PVC) Pipe** — Nom 2 in. (51 mm) diam (or smaller) Schedule 40 solid or cellular core PVC pipe for use in closed (process or supply) or vented (drain, waste or vent) piping systems.
- B2. **Chlorinated Polyvinyl Chloride (CPVC) Pipe** — Nom 2 in. (51 mm) diam (or smaller) SDR11 CPVC pipe for use in closed (process or supply) or vented (drain, waste or vent) piping systems.
- B3. **Rigid Nonmetallic Conduit (RNC)+** — Nom 2 in. (51 mm) diam (or smaller) Schedule 40 PVC conduit installed in accordance with the National Electrical Code (NFPA 70).
- B4. **Electrical Nonmetallic Tubing (ENT)+** — Nom 2 in. (51 mm) diam (or smaller) PVC tubing installed in accordance with the National Electrical Code (NFPA 70).
- B5. **Cross Linked Polyethylene (PEX) Tubing** — Nom 2 in. (51 mm) diam (or smaller) SDR 9 PEX tubing for use in closed (process or supply) or vented (drain, waste or vent) piping systems.
- C. **Cables** — Max 2 in. (52 mm) diam cable bundle installed eccentrically or concentrically within opening. Annular space between cable bundle and periphery of opening to be min 0 in. (point contact) to max 1 in. Cable bundle to be rigidly supported on both sides of wall. The following types and sizes of cables may be used:
- C1. Max 200 pair No. 22 AWG (or smaller) copper conductor with polyvinyl chloride (PVC) insulation and jacketing material.
- C2. Max 1/C No. 350 kcmil (or smaller) copper conductor cable with cross-linked polyethylene (XLPE) or PVC jacket.
- C3. Max 7/C No. 12 AWG (or smaller) copper conductor power and control cables with XLPE or PVC insulation with XLPE or PVC jacket.
- C4. Max 3/C No. 4/0 AWG (or smaller) copper or aluminum conductor SER cables with XLPE or PVC insulation and jacket.
- C5. Max 4/C No. 2/0 AWG (or smaller) copper conductor, aluminum clad or steel clad TECK 90 cable with or without PVC jacketed.
- C6. Max 110/125 fiber optic (F.O.) cable with PVC insulation and jacket.
- C7. Max 3/C with ground No. 8 AWG (or smaller) copper conductor NM cable with PVC insulation and jacket.
- C8. Max RG/U coaxial cable with fluorinated ethylene insulation and jacket.
- C9. Max 4 pair No. 24 AWG (or smaller) copper conductor data cable with HyLar jacket and insulation.
- C10. **Through Penetrating Product*** — Any cables, **Armored Cable+** or **Metal Clad Cable+** currently Classified under the Through Penetrating Product category.

See **Through Penetrating Product** (XHLY) category in the Fire Resistance Directory for names of manufacturers.

The T, FT and FTH Ratings are 1 hr unless copper pipe or tube is used. When copper pipe or tube is used, the hourly T, FT and FTH Ratings are 1/2 hr.

3. **Fill, Void or Cavity Material* - Sealant** — Min 3/4 in. (19 mm) thickness of fill material applied within the annulus, flush with the top surface of the floor or chase wall sole plate. Min 5/8 in. (16 mm) thickness of fill material applied within the annulus, flush with bottom surface of gypsum board ceiling or chase wall top plate. Min 1/4 in. (6 mm) diam bead of fill material applied at point contact location on the top surface of floor or chase wall sole plate and at the penetrant/ceiling or penetrant/chase wall top plate interface.

3M COMPANY 3M FIRE PROTECTION PRODUCTS — CP 25WB+ caulk, IC 15WB+ caulk or FB-3000 WT sealant

*** Indicates such products shall bear the UL or cUL Certification Mark for jurisdictions employing the UL or cUL Certification (such as Canada), respectively.**

+Bearing the UL Listing Mark

Reprinted from the Online Certifications Directory with permission from UL
© 2015 UL LLC



System No. F-E-8001

November 20, 2009

F Rating – 1 Hr

T Rating – 1 Hr

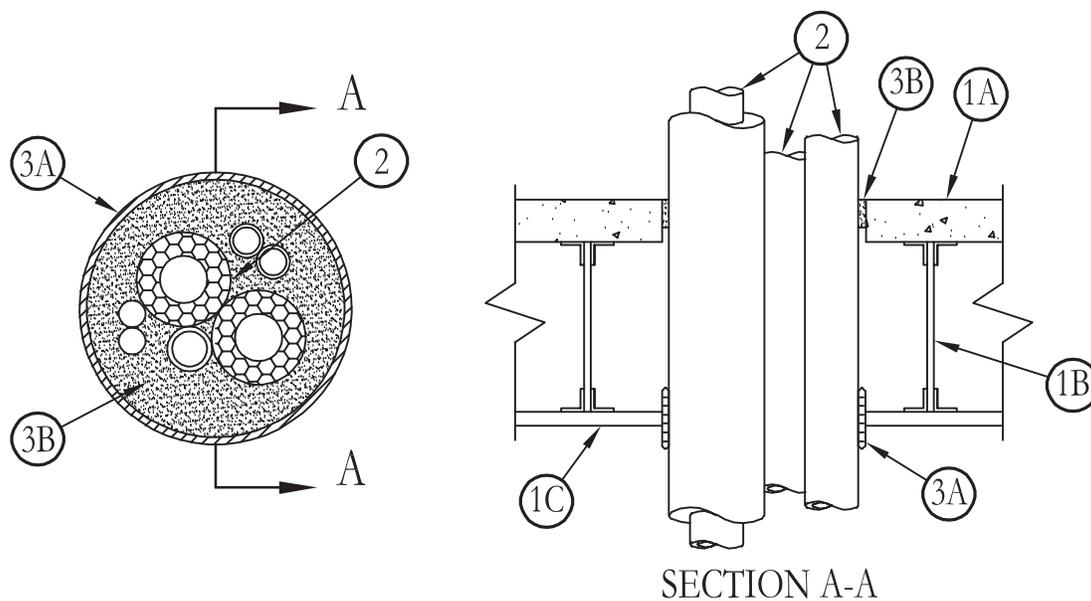

1. **Floor-Ceiling Assembly** – The 1 hr fire rated concrete and steel joist Floor-Ceiling assembly shall be constructed of the materials and in the manner described in the individual G500 Series Design in the UL Fire Resistance Directory, as summarized below.
 - A. **Flooring** – Lightweight or normal weight (100-150 pcf or 1600-2400 kg/m³) concrete as specified in the individual G500 Series Design. Max diam of opening is 4-1/2 in. (114 mm).
 - B. **Joists** – Steel Joists or **Structural Steel Members*** as specified in the individual G500 Series Design.
 - C. **Gypsum Board*** – Min 5/8 in. (16 mm) thick, screw-attached to furring channels as specified in the individual G500 Series Design. Max diam of opening is 4-1/2 in. (114 mm).
2. **Through Penetrants** – Pipes, conduits, tubing or cables to be bundled within the opening such that the aggregate cross-sectional area of penetrants in opening to be min 42 percent to max 54 percent of the cross-sectional area of the opening in floor-ceiling. A min 1/4 in. (6 mm) annular space shall be maintained around uninsulated metallic pipes. The space between penetrants and periphery of opening shall be min 1/4 in. (6 mm). Penetrants to be rigidly supported on both sides of floor assembly. The following types and sizes of penetrants may be used.
 - A. **Metallic Pipes** – The following types and sizes of metallic pipes, conduits or tubing may be used:
 - A1. **Steel Pipe** – Nom 3/4 in. (19 mm) diam (or smaller) Schedule 5 (or heavier) steel pipe.
 - A2. **Conduit** – Nom 3/4 in. (19 mm) diam (or smaller) steel electrical metallic tubing or steel conduit.
 - A3. **Copper Tubing** – Nom 3/4 in. (19 mm) diam (or smaller) Type L (or heavier) copper tubing.
 - A4. **Copper Pipe** – Nom 3/4 in. (19 mm) diam (or smaller) Regular (or heavier) copper pipe.**All pipes, conduits or tubing larger than nom 1/2 in. (13 mm) diam shall be provided with pipe covering (Item 2D).**
 - B. **Nonmetallic Pipes** – A max of one nonmetallic pipe or conduit may be used. A min 1/4 in. (6 mm) space shall be maintained between uninsulated metallic pipes and nonmetallic pipes or conduits. The following types and sizes of nonmetallic pipes or conduits may be used:
 - B1. **Polyvinyl Chloride (PVC) Pipe** – Nom 1-1/4 in. (32 mm) diam (or smaller) Schedule 40 solid core PVC pipe for use in closed (process or supply) or vented (drain, waste or vent) piping systems.
 - B2. **Chlorinated Polyvinyl Chloride (CPVC) Pipe** – Nom 1-1/4 in. (32 mm) diam (or smaller) SDR13.5 CPVC pipe for use in closed (process or supply) piping systems.
 - B3. **Rigid Nonmetallic Conduit** – Nom 1-1/4 in. (32 mm) diam (or smaller) Schedule 40 PVC conduit installed in accordance with the National Electrical Code (NFPA No. 70).
 - C. **Cables** – Max 7/C No. 12 AWG multiconductor power and control cables; XLPE or PVC insulation with XLPE or PVC jacket.
 - D. **Pipe Covering** – The following types and sizes of pipe coverings may be used with the metallic pipes:
 - D1. **Tube Insulation – Plastics** – Nom 1/2 in. (13 mm) thick acrylonitrile butadiene/polyvinyl chloride (AB/PVC) flexible foam furnished in the form of tubing.
See **Plastics** (QMFZ2) category in the Plastics Recognized Component Directory for names of manufacturers. Any Recognized Component tube insulation material meeting the above specifications and having a UL 94 Flammability Classification of 94-5VA may be used.
 - D2. **Pipe Covering*** – Nom 1/2 in. (13 mm) thick hollow cylindrical heavy density (min 3.5 pcf or 56 kg/m³) glass fiber units jacketed on the outside with an all service jacket. Longitudinal joints sealed with metal fasteners or factory-applied self-sealing lap tape. Transverse joints secured with metal fasteners or with butt tape supplied with the product.
See **Pipe and Equipment Covering – Materials** (BRGU) category in the Building Materials Directory for names of manufacturers. Any pipe covering material meeting the above specifications and bearing the UL Classification Marking with a Flame Spread Index of 25 or less and a Smoke Developed Index of 50 or less may be used.

System No. F-E-8001 *continued*

3. **Firestop System** – The details of the firestop system shall be as follows:

- A. **Fill, Void or Cavity Materials* – Wrap Strip** – Min 1/4 in. (6 mm) thick intumescent material supplied in 2 in. (51 mm) wide strips. One wrap strip tightly wrapped around perimeter of penetrants (foil side exposed) and held in position using two steel wire ties. Wrap strip recessed into opening such that 3/4 to 1 in. (19 to 51 mm) extends below the bottom surface of the gypsum wallboard ceiling.
3M COMPANY – FS-195+
- B. **Fill, Void or Cavity Materials* – Caulk, Sealant or Putty** – Min 3/4 in. (19 mm) thickness of caulk or putty applied within annular space inside of wrap strip and between penetrants, flush with the bottom surface of ceiling and extending downward. Min 5/8 in. (16 mm) thickness of caulk or putty applied within annular space between wrap strip and periphery of opening flush with bottom surface of ceiling. Min 1/2 in. (13 mm) diam bead of caulk or putty applied around the perimeter of the wrap strip at interface with the gypsum wallboard ceiling. Min 3/4 in. (19 mm) thickness of caulk or putty applied within annular space, flush with top surface of floor.
3M COMPANY – CP 25WB+ caulk, MP+ putty, IC 15WB caulk, FireDam 150+ caulk or FB-3000 WT sealant.
(Note: CP 25WB+ and FireDam 150+ not suitable for use with CPVC pipes.)

*Bearing the UL Classification Mark

++Bearing the UL Listing Mark

+++Bearing the UL Recognized Component Marking

Reprinted from the Online Certifications Directory with permission from Underwriters Laboratories Inc.
Copyright © 2010 Underwriters Laboratories Inc.®



Note: Systems with Nonmetallic Through Penetrant(s) have not been evaluated with a pressure differential of 50 Pa between the exposed and unexposed surfaces as required by the National Building Code of Canada.

Through Penetrations

Compos

8000 Series

Floor/Ceiling

FE

System No. F-E-8002

November 20, 2009

F Rating – 1 Hr

T Rating – 1 Hr

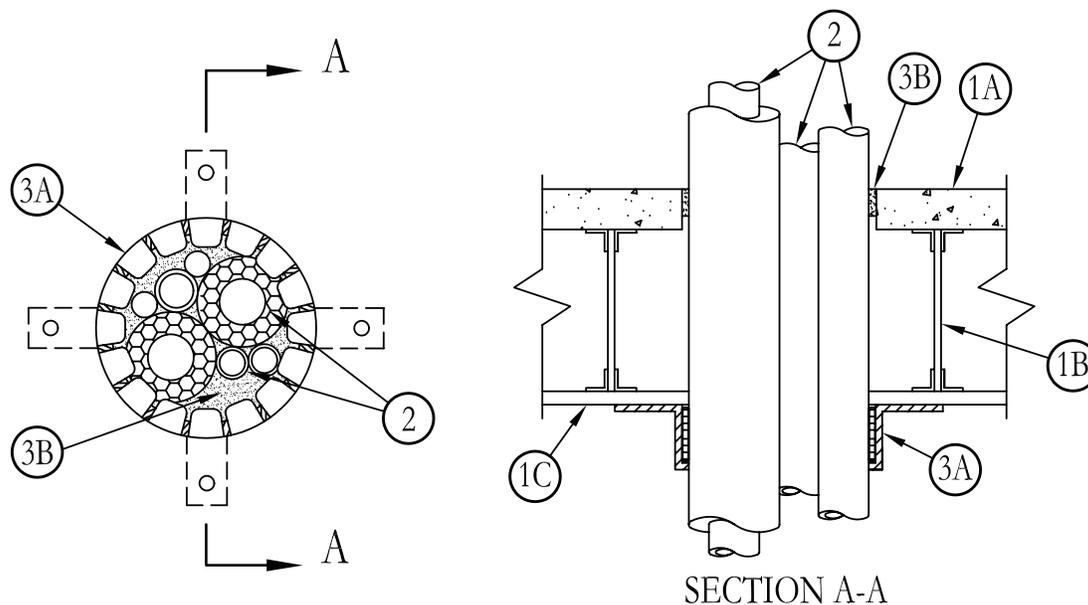

1. **Floor-Ceiling Assembly** – The 1 hr fire rated concrete and steel joist Floor-Ceiling assembly shall be constructed of the materials and in the manner described in the individual G500 Series Design in the UL Fire Resistance Directory, as summarized below:
 - A. **Flooring** – Lightweight or normal weight (100-150 pcf or 1600-2400 kg/m³) concrete as specified in the individual G500 Series Design. Max diam of opening is 4-1/2 in. (114 mm).
 - B. **Joists** – Steel Joists or **Structural Steel Members*** as specified in the individual G500 Series Design.
 - C. **Gypsum Board*** – Min 5/8 in. (16 mm) thick, screw-attached to furring channels as specified in the individual G500 Series Design. Max diam of opening is 4-1/2 in. (114 mm).
2. **Through Penetrants** – Pipes, conduits, tubing or cables to be bundled within the opening such that the aggregate cross-sectional area of penetrants in opening to be min 42 percent to max 54 percent of the cross-sectional area of the opening in floor-ceiling. A min 1/4 in. (6 mm) annular space shall be maintained around uninsulated metallic pipes. The space between penetrants and periphery of opening shall be min 1/4 in. (6 mm). Penetrants to be rigidly supported on both sides of floor assembly. The following types and sizes of penetrants may be used:
 - A. **Metallic Pipes** – The following types and sizes of metallic pipes, conduits or tubing may be used:
 - A1. **Steel Pipe** – Nom 3/4 in. (19 mm) diam (or smaller) Schedule 5 (or heavier) steel pipe.
 - A2. **Conduit** – Nom 3/4 in. (19 mm) diam (or smaller) steel electrical metallic tubing or steel conduit.
 - A3. **Copper Tubing** – Nom 3/4 in. (19 mm) diam (or smaller) Type L (or heavier) copper tubing.**All pipes, conduits or tubing larger than nom 1/2 in. (13 mm) diam shall be provided with pipe covering (Item 2D).**
 - B. **Nonmetallic Pipes** – A max of one nonmetallic pipe or conduit may be used. A min 1/4 in. (6 mm) space shall be maintained between uninsulated metallic pipes and nonmetallic pipes or conduits. The following types and sizes of nonmetallic pipes or conduits may be used:
 - B1. **Polyvinyl Chloride (PVC) Pipe** – Nom 1-1/4 in (32 mm) diam (or smaller) Schedule 40 solid core PVC pipe for use in closed (process or supply) or vented (drain, waste or vent) piping systems.
 - B2. **Chlorinated Polyvinyl Chloride (CPVC) Pipe** – Nom 1-1/4 in. (32 mm) diam (or smaller) SDR13.5 CPVC pipe for use in closed (process or supply) piping systems.
 - B3. **Rigid Nonmetallic Conduit++** – Nom 1-1/4 in. (32 mm) diam (or smaller) Schedule 40 PVC conduit installed in accordance with the National Electrical Code (NFPA No. 70).
 - C. **Cables** – Max 7/C No. 12 AWG multiconductor power and control cables; XLPE or PVC insulation with XLPE or PVC jacket.
 - D. **Pipe Covering** – The following types and sizes of pipe coverings may be used with the metallic pipes:
 - D1. **Tube Insulation – Plastics+++** – Nom 1/2 in. (13 mm) thick acrylonitrile butadiene/polyvinyl chloride (AB/PVC) flexible foam furnished in the form of tubing.
See **Plastics+++** (QMFZ2) category in the Plastics Recognized Component Directory for names of manufacturers. Any Recognized Component tube insulation material meeting the above specifications and having a UL 94 Flammability Classification of 94-5VA may be used.
 - D2. **Pipe Covering*** – Nom 1/2 in. (13 mm) thick hollow cylindrical heavy density (min 3.5 pcf or 56 kg/m³) glass fiber units jacketed on the outside with an all service jacket. Longitudinal joints sealed with metal fasteners or factory-applied self-sealing lap tape. Transverse joints secured with metal fasteners or with butt tape supplied with the product.
See **Pipe and Equipment Covering – Materials** (BRGU) category in the Building Materials Directory for names of manufacturers. Any pipe covering material meeting the above specifications and bearing the UL Classification Marking with a Flame Spread Index of 25 or less and a Smoke Developed Index of 50 or less may be used.

System No. F-E-8002 *continued*

3. **Firestop System** – The details of the firestop system shall be as follows:

- A. **Firestop Device*** – Firestop device consisting of a steel collar lined with intumescent material and provided with steel clips for attachment to underside of ceiling in accordance with accompanying installation instructions. The following firestop devices are to be used, dependent on the max opening size.

| Max Opening Size, In. (mm) | Firestop Device |
|----------------------------|-----------------|
| 3-1/2 (89 mm) | PPD 3 |
| 4-1/2 (114 mm) | PPD 4 |

3M COMPANY

- B. **Fill, Void or Cavity Materials*** – **Caulk, Sealant or Putty** – Min 5/8 in. (16 mm) thickness of caulk or putty applied within annular space between penetrants and periphery of opening flush with bottom surface of ceiling. Additionally, when PPD 3 firestop device is used, min 1 in. (25 mm) thickness of caulk or putty applied to completely fill annular space inside of firestop device and between penetrants, flush with the bottom surface of ceiling and extending downward. When PPD 4 firestop device is used, min 2 in. (51 mm) thickness of caulk or putty applied to completely fill annular space inside of firestop device and between penetrants, flush with the bottom surface of ceiling and extending downward. Min 3/4 in. (19 mm) thickness of caulk or putty applied within annular space, flush with top surface of floor.

3M COMPANY – CP 25WB+ caulk, MP+ putty, IC 15WB+ caulk, FireDam 150+ caulk or FB-3000 WT sealant.

(Note: CP 25WB+ and FireDam 150+ not suitable for use with CPVC pipes.)

*Bearing the UL Classification Mark

++Bearing the UL Listing Mark

+++Bearing the UL Recognized Component Mark

Reprinted from the Online Certifications Directory with permission from Underwriters Laboratories Inc.
Copyright © 2010 Underwriters Laboratories Inc.®



Note: Systems with Nonmetallic Through Penetrant(s) have not been evaluated with a pressure differential of 50 Pa between the exposed and unexposed surfaces as required by the National Building Code of Canada.

System No. F-E-8005

May 18, 2005
F Rating – 1 Hr
T Rating – 1/4 Hr

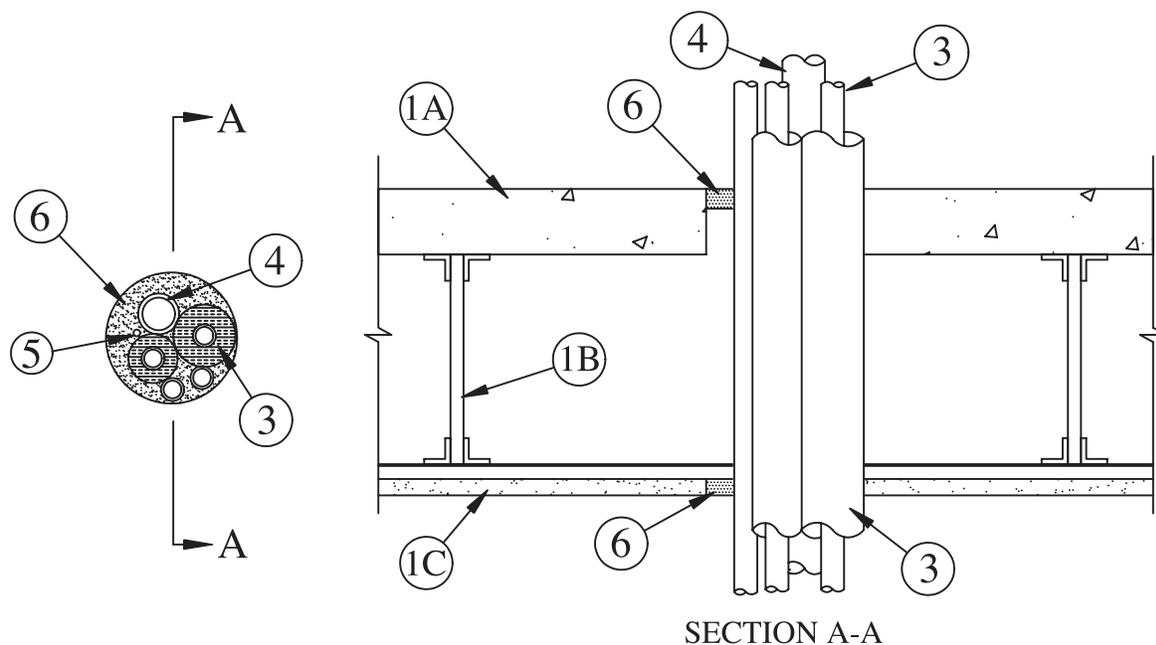

- Floor-Ceiling Assembly** – The 1 hr fire rated concrete and steel joist Floor-Ceiling assembly shall be constructed of the materials and in the manner described in the individual G500 Series Design in the UL Fire Resistance Directory, as summarized below:
 - Flooring** – Normal or Lightweight concrete as specified in the individual G500 Series Design. Max diam of opening is 5 in. (127 mm).
 - Joists** – Steel joists or **Structural Steel Members*** as specified in the individual G500 Series Design.
 - Gypsum Board*** – Min 5/8 in. (16 mm) thick, screw-attached to furring channels as specified in the individual G500 Series Design. Max diam of opening is 5 in. (127 mm).
- Through Penetrants** – One or more metallic pipes, conduits or tubing to be installed concentrically or eccentrically within opening. Pipes, conduits or tubing to be spaced min 0 in. (point contact) to max 1 in. (0 mm to max 25 mm) apart. The space between the pipes, conduits or tubing and the periphery of the opening shall be min 0 in. (point contact) to max 1 in. (0mm to max 25 mm). Penetrants to be rigidly supported on both sides of floor-ceiling assembly. The following types and sizes of metallic pipe, conduits or tubing may be used:
 - Steel Pipe** – Nom 3/4 in. (19 mm) diam (or smaller) Schedule 5 (or heavier) steel pipe.
 - Conduit** – Nom 3/4 in. (19 mm) diam (or smaller) electrical metallic tubing or steel conduit.
 - Copper Tubing** – Nom 3/4 in. (19 mm) diam (or smaller) Type L (or heavier) copper tubing.
 - Copper Pipe** – Nom 3/4 in. (19 mm) diam (or smaller) Regular (or heavier) copper pipe.
- Tube Insulation-Plastics+** – Nom 3/4 in. (19 mm) thick (or less) acrylonitrile butadiene/polyvinyl chloride (AB/PVC) flexible foam furnished in the form of tubing. The annular space between the insulated penetrant and the periphery of the opening shall be min 0 in. (point contact) to max 1 in. (0 mm to max 25 mm).

See **Plastics** (QMFZ2) category in the Plastics Recognized Component Directory for names of manufacturers. Any Recognized Component tube insulation material meeting the above specifications and having a UL 94 Flammability Classification of 94-5A may be used.
- Nonmetallic Pipes** – One nonmetallic pipe or conduit to be installed within the firestop system. Pipe or conduit to be spaced min 0 in. (point contact) to max 1 in. (0 mm to max 25 mm) from the insulated through penetrants and min 1/2 in. to max 1 in. (13 mm to max 25 mm) from non-insulated through penetrants. The space between the pipe or conduit and the periphery of the opening shall be min 0 in. (point contact) to max 1 in. (0 mm to max 25 mm). Pipe or conduit to be rigidly supported on both sides of floor-ceiling assembly. One of the following types and sizes of nonmetallic through penetrants may be used:
 - Polyvinyl Chloride (PVC) Pipe** – Nom 1-1/2 in. (38 mm) diam (or smaller) Schedule 40 solid-core PVC pipe for use in closed (process or supply) or vented (drain, waste or vent) piping systems.
 - Chlorinated Polyvinyl Chloride (CPVC) Pipe** – Nom 1-1/2 in. (32 mm) diam (or smaller) SDR13.5 CPVC pipe for use in closed (process or supply) piping systems.
 - Rigid Nonmetallic Conduit++** – Nom 1-1/2 in. (38 mm) diam (or smaller) Schedule 40 solid-core PVC conduit installed in accordance with Article 347 of the National Electrical Code (NFPA No. 70).
- Cables** – Max two 7/C (or less) No. 12 AWG (or smaller) multiconductor power and control cables with XLPE or PVC insulation with XLPE or PVC jacket. Cables to be spaced min 0 in. (point contact) to max 1 in. (0 mm to max 25 mm) from the insulated through penetrants and min 1/2 in. to max 1 in. (13 mm to max 25 mm) from non-insulated through penetrants. The space between the cables and the periphery of the opening shall be min 0 in. (point contact) to max 1 in. (0 mm to max 25 mm). Cables to be rigidly supported on both sides of the floor-ceiling assembly.

System No. F-E-8005 *continued*

6. **Fill, Void or Cavity Materials* – Caulk or Sealant** – Min 3/4 in. (19 mm) thickness of caulk applied within annulus, flush with top surface of floor. Min 5/8 in. (16 mm) thickness of caulk applied within annulus, flush with bottom surface of ceiling. Min 1/4 in. (6 mm) diam bead of caulk applied at point contact locations at penetrant/floor interface on top surface of floor and at penetrant/ceiling interface.

3M COMPANY – CP 25WB+, IC 15WB+ caulk or FB-3000 WT sealant
(Note: CP 25WB+ not suitable for use with CPVC pipes.)

- *Bearing the UL Classification Marking
- +Bearing the UL Recognized Component Marking
- ++Bearing the UL Listing Mark

Reprinted from the Online Certifications Directory with permission from Underwriters Laboratories Inc.
Copyright © 2010 Underwriters Laboratories Inc.®



Note: This system was tested with a pressure differential of 50 Pa between the exposed and unexposed surfaces with the higher pressure on the exposed side.

Through Penetrations

Combos

8000 Series

Floor/Ceiling

FC

3M Firestop Systems

Through Penetrations

Intertek

PH

Horizontal Assemblies

PV

Vertical Assemblies

PHV

Horizontal and Vertical Assemblies

The current version of the Design Listings can be found on Intertek's website at <https://bpdirectory.intertek.com>.

Horizontal Assemblies (Floors)

Through Penetrations • Horizontal Assemblies (Floors)

| 3M Systems | "F" Rating | 3M Product | Application Details |
|---------------|------------|---|--|
| 3M/PH 60-02 | 1 | 3M™ Fire Barrier Sealant FD 150+ | Max. 4" Copper, Steel/Cast, EMT Max. 1-1/2" BX Cables, Electrical Cables through a 1 hour rated wood floor/ceiling assembly |
| 3M/PH 60-03 | 1 | 3M™ Fire Barrier Sealant FD 150+ 3M™ FirePlug™ 3M™ Firestrap™ | Max. 3" PVC, ABS, ccABS, Max 2" PVC-Thin wall through a 1 hour rated wood floor/ceiling assembly |
| 3M/PH 60-04 | 1 | 3M™ Fire Barrier Sealant IC 15WB+ | Max. 4" PVC, ABS, ccABS, Max 2" Kitec, PVC-Thin wall, Max. 1" PEX through a 1 hour rated wood floor/ceiling assembly |
| 3M/PH 60-05 | 1 | 3M™ Fire Barrier Water Tight Sealant 3000 WT | Max. 4" Steel/Cast pipe, Max. 2" CPVC, Copper pipe, Max. 1-1/2" PVC, ABS, EMT, Electrical, Max 1/2" BX Cables through a 1 hour rated wood floor/ceiling assembly |
| 3M/PH 60-07 | 1 | 3M™ Fire Barrier Water Tight Sealant 1003 SL 3M™ Fire Barrier Water Tight Sealant 1000 NS 3M™ Fire Barrier Water Tight Sealant 3000 WT | Max. 4" Steel/Cast pipe, Max. 2" CPVC, PVC, Copper pipe, Max. 1-1/2" EMT, Electrical, Max 1/2" BX Cables through a 1 hour rated wood floor/ceiling assembly |
| 3M/PH 120-01 | 2 | 3M™ Fire Barrier Cast in Devices for Plastic Pipes | Max. 6" XFR,CPVC, Max. 4" PVC, RNC-PVC, ccABS, ABS through a 2 hour rated concrete floor assembly, min. 4-1/2" thick |
| 3M/PH 120-02 | 2 | 3M™ RC-1 Collar System 3M™ Interam™ Ultra GS Wrap 3M™ Fire Barrier CP-25WB+ Caulk 3M™ Fire Barrier IC 15WB+ Sealant 3M™ Moldable Putty+ (MPS2) 3M™ Interam PPD 3M™ Fire Barrier RC Pack 3M™ Interam™ Ultra PPD-1.5 | Max. 4" ccPVC, PVC, CPVC, aaABS, ABS, FRPP, Max. 2" PVC – Thin wall through a 2 hour rated concrete floor assembly, min. 2 1/2" thick, hollow core, or Q-deck |
| 3M/PH 120-03 | 2 | 3M™ Fire Barrier Cast in Devices for Plastic Pipes 3M™ Metal Deck Adapter | Max. 4" PVC, XFR, RNC-PVC, ccABS, ABS through a 2 hour rated concrete floor assembly, min. 2-1/2" thick, or Q-deck |
| 3M/PH 120-04 | 2 | 3M™ Fire Barrier Cast in Devices for Plastic Pipes 3M™ Tub Box (TB) Adapter | Max. 2" PVC, XFR, ccABS, ABS through a 2 hour rated concrete floor assembly, min. 4-1/2" thick |
| 3M/PH 120-05 | 1, 2 | 3M™ Interam™ Ultra PPD 3M™ Fire Barrier RC Pack 3M™ Ultra Fast Anchors 3M™ Interam™ Ultra PPD-1.5 3M™ Fire Barrier Sealant FD 150+ 3M™ FirePlug™ 3M™ Firestrap™ 3M™ Fire Barrier Sealant CP-25WB+ 3M™ Fire Barrier Sealant IC 15WB+ | Max. 4" ccPVC, PVC, CPVC, ccABS, ABS, FRPP, Max. 2" PVC – Thin wall through a 1 or 2 hour rated wood floor/ceiling assembly |
| 3M/PH 120-06 | 2 | 3M™ Fire Barrier Cast in Devices for Plastic Pipes 3M™ Fire Barrier Cast in Tub Box (TB) Adapter 3M™ Fire Barrier Cast in Device Height Adapter | Max. 4" FRPP through a 2 hour rated concrete floor assembly, min. 4-1/2" thick |
| 3M/PH 120-07 | 2 | 3M™ Fire Barrier Cast in Devices for Plastic Pipes | Blank opening through a 2 hour rated concrete floor assembly, min. 2-1/2" thick, or Q-deck |
| 3M/PH 120-08 | 2 | 3M™ FireStrap™ 3M™ Fire Barrier Sealant CP-25WB+ 3M™ Fire Barrier Sealant IC 15WB+ 3M™ Fire Barrier Sealant FD 150+ | Max. 3" ccABS, Max. 2" ABS, PVC, PVC – Thin wall through a 2 hour rated concrete floor assembly, min. 2-1/2" thick, or Q-deck |
| 3M/PH 120-09 | 2 | 3M™ FireStrap™ 3M™ Fire Barrier Mortar 3M™ Fire Barrier Sealant CP-25WB+ 3M™ Fire Barrier Sealant IC 15WB+ | Max. 3" PVC, Max. 2" UPP through a 2 hour rated concrete floor assembly, min. 4-1/2" thick |
| 3M/PH 120-10 | 2 | 3M™ Fire Barrier Water Tight Sealant 1000 NS 3M™ Fire Barrier Water Tight Sealant 1003 SL | Nominal 1" PEX installed in 1-1/2" infloor PVC conduit in a 2 hour rated concrete floor assembly, min. 4-1/2" thick |
| 3M/PH 120-16 | 2 | 3M™ FireStrap™ 3M™ Fire Barrier Mortar 3M™ Fire Barrier Sealant CP-25WB+ 3M™ Fire Barrier Sealant IC 15WB+ 3M™ Fire Barrier Sealant FD 150+ | Max. 3" PVC, ccABS, ABS through a 2 hour rated concrete floor assembly, min. 4-1/2" thick. Penetrants must run in chase wall assembly beneath opening |
| FS 530 F | 3 | 3M™ Fire Barrier Silicone Sealant 2000+ | 3 hour concrete floor. Max. 24" sch 10 steel pipe, max. 5" EMT or conduit, max. 6" copper pipe. Min. 1/2" depth of fill material. Also referred to as FS530F. |
| 3MU/PV 180-03 | 3 | 3M™ Fire Barrier Silicone Sealant 2000+ | 3 hour concrete floor. Max. 24" sch 10 steel pipe, max. 5" EMT or conduit, max. 6" copper pipe. Min. 1/4" depth of fill material. Also referred to as FS531F. |

Horizontal Assemblies (Floors)

| 3M Systems | "F" Rating | 3M Product | Application Details |
|---------------|------------|---|---|
| FS 532 F | 2 | 3M™ Fire Barrier Silicone Sealant 2000+ | 2 hour concrete floor. Max. 24" sch 10 steel pipe, max. 5" EMT or conduit, max. 6" copper pipe. Max. 1" thick glass fiber insulation. Min. 1/2" depth of fill material. Also referred to as FS532F. |
| 3MU/PV 180-04 | 3 | 3M™ Fire Barrier Silicone Sealant 2000+ | 3 hour concrete floor. Max. 24" sch 10 steel pipe, max. 5" EMT or conduit, max. 6" copper pipe. Max. 1" thick glass fiber insulation. Min. 1/4" depth of fill material. Also referred to as FS533F. |
| 3MU/BI 120-04 | 2 | 3M™ Fire Barrier™ Duct Wrap 615 3M™ Fire Barrier™ Duct Wrap 615+ | 4 in. cast iron or 2 in. copper through a concrete floor. T ratings using Fire Barrier Duct Wrap 615+ |
| 3MU/BI 120-05 | 1, 2 | 3M™ Fire Barrier™ Duct Wrap 615 3M™ Fire Barrier™ Duct Wrap 615+ | 4 in. to max 8 in. Steel, copper, cast iron, EMT through a concrete floor or wall. T ratings using Fire Barrier Duct Wrap 615+ |

3M CANADA CO. – London, On Canada

DESIGN NO. 3M/PH 60-02

October 02, 2006

HORIZONTAL (FLOOR)

RATINGS – See Below

TEST PRESSURE DIFFERENTIAL – 2.5 Pa (0.01 in. of water) MINIMUM

| Penetrating Item | Max. Pipe/Cable Size | Max. Opening Size | Annular Spacing | CAN/ULC-S115 F, FH, FTH | ASTM-E814 F, FT |
|-------------------|----------------------|-------------------|-----------------|-------------------------|-----------------|
| Copper | 4" | 5" | 0 - 7/8" | 1 Hr | 1 Hr |
| Steel/Cast | 4" | 5" | 0 - 7/8" | 1 Hr | 1 Hr |
| EMT | 4" | 5" | 0 - 7/8" | 1 Hr | 1 Hr |
| BX Cable | 1-1/2" | 1-1/2" | 0 - 1-1/4" | 1 Hr | 1 Hr |
| Electrical Cables | 1-1/2" | 1-1/2" | 0 - 1-1/4" | 1 Hr | 1 Hr |

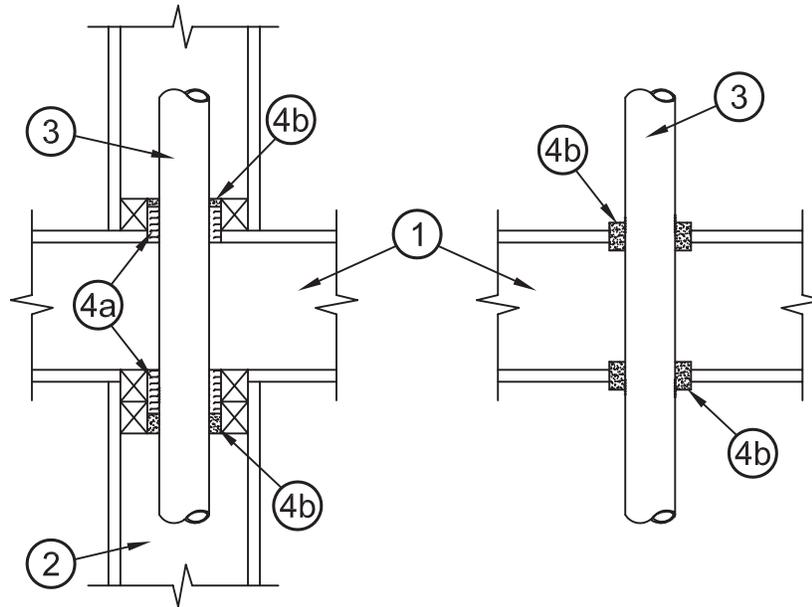

- Floor/Ceiling Assembly** – Code conforming 1 hour rated floor / ceiling assembly, framed with minimum nominal 2" x 10" solid sawn or manufactured wood joists, topping optional (not shown).
- Chase Wall** – Rated or non-rated wood or steel stud gypsum wallboard assembly.
- Penetrants** – (See table of ratings) Ratings achieved will equal that of floor/ceiling assembly. Cables - May consist of 12 AWG, minimum of one to maximum seven cables, 100 pair 22 AWG, maximum 3 conductor with ground No. 2 AWG aluminum SER cable, Maximum three conductor No. 12 AWG, MC (BX) copper cable or coaxial cable.
- Firestop System Components:**
 - Forming Material** – If the top or bottom plate has been cut out to prepare a rectangular opening, sheet metal strips shall be nailed to the sides of the plates to form a confined space in which to install 4 pcf mineral wool, compressed 25%.
 - *3M FireDam 150+ Caulk** – Applied flush with top surface of the sole plate to a depth of 3/4" within the annulus. Minimum 5/8" inch thickness of fill material applied flush with the bottom surface of the ceiling or top plate. Minimum 1/2" diameter bead of caulk applied at the penetrant/floor or sole plate interface at point contact location on the top surface of floor or sole plate and at the penetrant/ceiling or top plate interface at point contact location.

Note: Metric conversion factor, inches x 25.4 = mm.

*Components bearing the Warnock Hersey Certification Mark.

This material was extracted and drawn by 3M Fire Protection Products from the 2006 Warnock Hersey Directory of Listed Products

Through Penetrations

Horizontal

1 Hour

PH

3M CANADA CO. – London, On Canada

DESIGN NO. 3M/PH 60-03

July 26, 2006

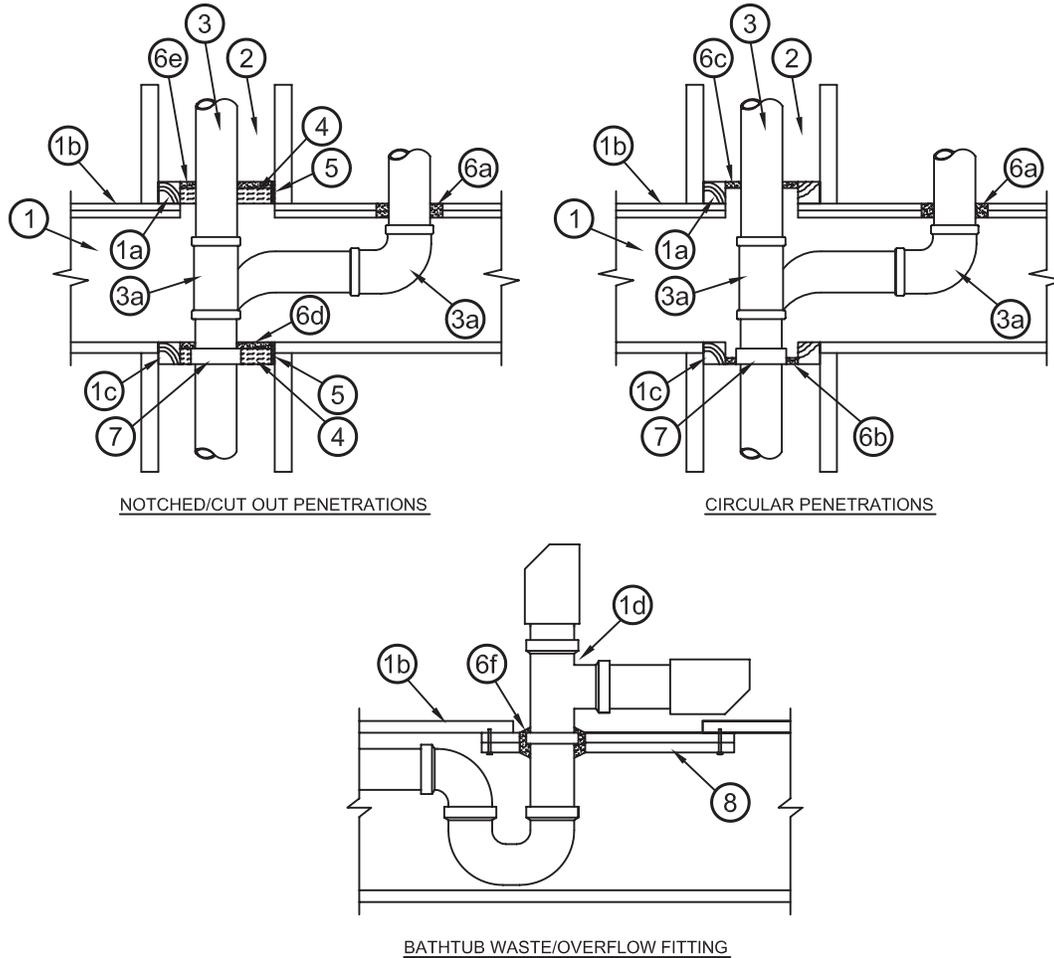
HORIZONTAL (FLOOR); RATINGS – SEE TABLE BELOW
TEST PRESSURE DIFFERENTIAL – 50 Pa (0.20" OF WATER)

NOTCHED/CUT OUT PENETRATIONS

CIRCULAR PENETRATIONS

BATHTUB WASTE/OVERFLOW FITTING

Table of Ratings

| Penetrant | Max. Pipe Diameter (ID) | CAN/ULC-S115 F, FH, FT, FTH |
|-----------------|-------------------------|--------------------------------|
| PVC | 3" | 1 Hr |
| ccABS | 3" | 1 Hr |
| ABS | 3" | 1 Hr |
| PVC - Thin Wall | 2" | 1 Hr |

Openings: Branch piping penetrations not passing through a sole plate shall be installed in circular penetrations. Top and sole plate penetrations may be notched, cut out, or circular as detailed in the size range chart.

| Pipe ID | Top & Sole Plate Penetrations | | Branch Piping Penetrations |
|---------|-------------------------------|-----------------|----------------------------|
| | Circular | Notched/Cut Out | Circular |
| 1-1/2" | 2-1/2" | 4-1/2" x 3-1/2" | 2-1/2" |
| 2" | 3" | 4-1/2" x 3-1/2" | 3" |
| 3" | 4-1/2" | 5-1/2" x 5-1/2" | 4-1/2" |

1. **Floor/Ceiling Assembly:** Code conforming 1 hour fire-rated floor/ceiling assembly, framed with nominal 2" x 10" solid sawn or manufactured wood joists, topping optional (not shown).
 - a) Sole Plate: Nominal 2 x 4 or 2 x 6 solid sawn wood.
 - b) Sub-flooring: Minimum 5/8" wood panel sheathing.
 - c) Top Plate: Single or Double Top Plate, nominal 2 x 4, 2 x 6 or double plate system.
 - d) Bathtub Waste/Overflow Fitting: Maximum opening in wood flooring (Item 1b) 8" x 12" (see Item 8).

Design No. PH 60-03 *continued*

2. **Wall Assembly:** Code conforming 1 hour fire-rated or non fire-rated gypsum wallboard assembly with wood framing members.
3. **Penetrants:** (See Table of Ratings above) Schedule 40, ccABS, ABS, PVC pipes for DWV (Drain, Waste and Vent) or Closed (Process and Supply) piping systems and PVC – Thin Wall Vacuum Tubing (nominal 2" diameter). Penetrants must be contained within a wall assembly. Ratings achieved will equal that of floor/ceiling assembly.
 - a) Tee's, Elbows and Couplings: Branch piping and connections are permitted within the assembly.
4. **Forming Material:** Required for notched or cut out openings, mineral wool, 4 pcf, tightly packed, nominal 1" thickness, recessed 1/4" from the top surface of the sole or top plates, not required for circular openings.
5. **Sheet Metal Strip:** Nominal 1-1/2" width, minimum 30 gauge thickness, secured with wallboard screws, applied to notched or cut out openings in sole and top plates, to act as a retainer for the forming material (Item 4).
6. **Sealant:** *3M™ FireDam 150+ Caulk applied as follows:
 - Sub-Flooring Penetrations
 - a) Circular Openings: Apply a 5/8" thickness of caulk within the annular space flush with the floor surface.
 - Circular Openings
 - b) Top Plate: Apply a 1/4" thickness of caulk, within the annular space, flush with the bottom surface of the top plate.
 - c) Sole Plate: Apply a 1/4" thickness of caulk, within the annular space, flush with the top surface of the sole plate.
 - Notched or Cut Out Penetrations
 - d) Top Plate: Apply a 1/4" thickness of caulk, over mineral wool forming material, within the annular space flush with the top or bottom (not shown) surface of the top plate.
 - e) Sole Plate: Apply a 1/4" thickness of caulk, over mineral wool forming material, within the annular space flush with the top surface of the top plate.
 - f) Sealant - *3M™ FireDam 150+ Caulk: Apply within the annular space around the penetrant to the full thickness of the Gypsum Wallboard Patch.

Sheet Metal Strip: Apply a 1/4" bead of caulk on the outside of the strip at the floor interface for notched or cut out penetrations in the sole plate.
7. ***3M™ FirePlug™:** Install flush within the opening to the bottom surface of the single or double top plate. Pipes with an ID 2" or smaller use *3M™ FirePlug™ 2" and for pipes ID 3" use *3M™ FirePlug™ 3". Alternate: *3M™ Firestrap™ : Appropriately sized for the pipe ID may be used in the installation. The *3M™ Firestrap™ 1-1/2" should be used for PVC thin wall Vacuum Tubing nominal 2" diameter.
8. **Gypsum Wallboard Patch:** Two pieces of gypsum wallboard, sized 4" larger than the cutout opening in the flooring, screw-attached to bottom of flooring concentric with cutout. Diameter of opening through both layers of the gypsum wallboard patch is 2-1/2" for 1-1/2" diameter pipes and 3" for 2" diameter pipes.

Note: Metric conversion factor, inches x 25.4 = mm.

*Components bearing the Warnock Hersey Certification Mark.

This material was extracted and drawn by 3M Fire Protection Products from the 2006 Warnock Hersey Directory of Listed Products

Through Penetrations

Horizontal

1 Hour

PH

3M CANADA CO. – London, On Canada

DESIGN NO. 3M/PH 60-04

July 26, 2006

HORIZONTAL (FLOOR); RATINGS – SEE TABLE BELOW
TEST PRESSURE DIFFERENTIAL – 50 Pa (0.20" OF WATER)

Table of Ratings

| Penetrant | Max. Pipe Diameter (ID) | CAN/ULC-S115 F, FH, FT, FTH |
|-------------------|-------------------------|--------------------------------|
| PVC | 4" | 1 Hr |
| ccABS | 4" | 1 Hr |
| ABS | 4" | 1 Hr |
| PVC - Thin Wall | 2" | 1 Hr |
| Kitec® (PE-AL-PE) | 2" | 1 Hr |
| PEX | 1" | 1 Hr |

Openings: Branch piping penetrations not passing through a sole plate shall be installed in circular penetrations. Top and sole plate penetrations may be notched, cut out, or circular as detailed in the size range chart.

| Pipe ID | Top & Sole Plate Penetrations | | Branch Piping Penetrations | Gypsum Wallboard Patch |
|---------|-------------------------------|-----------------|----------------------------|------------------------|
| | Circular Opening | Notched Opening | | Circular Opening |
| 1" | 2" | 2"x4" | 2" | NA |
| 1-1/2" | 2-1/2" | 3"x4-1/2" | 2-1/2" | 2-1/2" |
| 2" | 3" | 3"x4-1/2" | 3" | 3" |
| 3" | 4-1/2" | 3-1/2"x4-1/2" | 4-1/2" | 4-1/2" |
| 4" | 5" | NA | 5" | 5" |

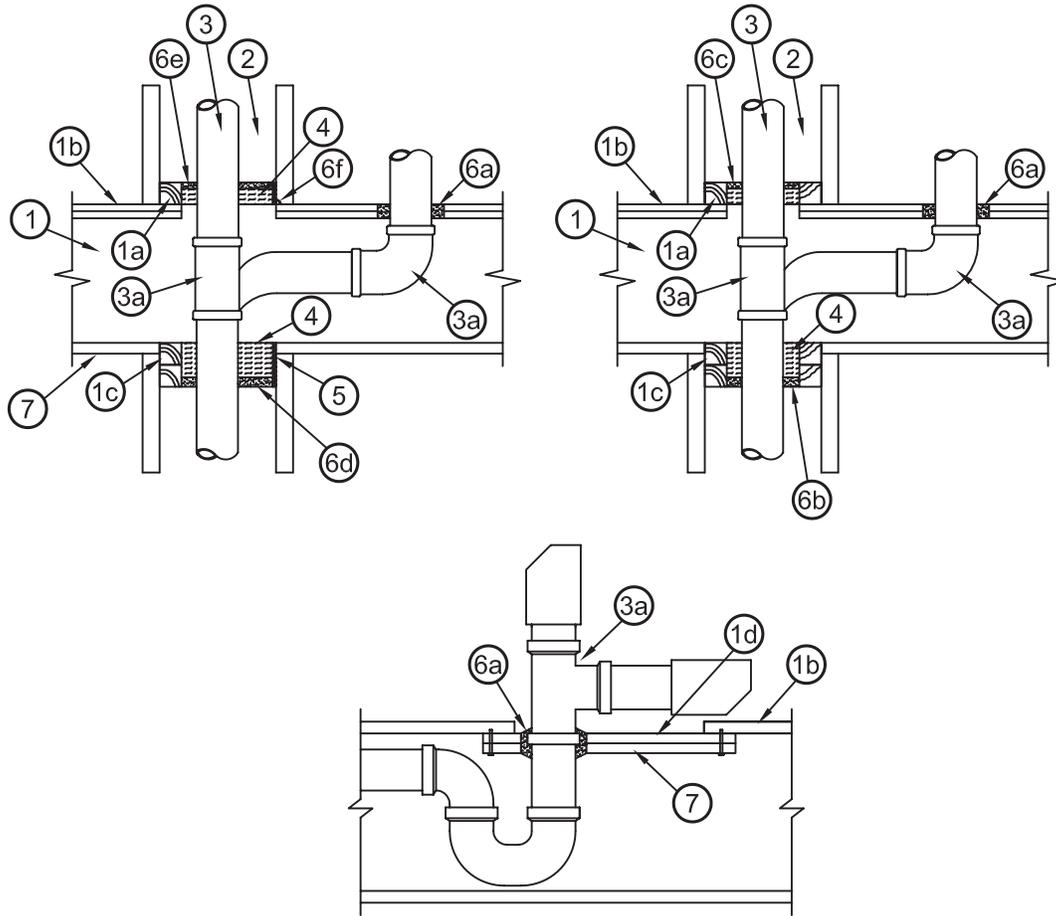
Design No. PH 60-04 *continued*

1. **Floor / Ceiling Assembly:** Code conforming 1 hour fire-rated floor/ceiling assembly, framed with nominal 2" x 10" solid sawn or manufactured wood joists, topping optional (not shown).
 - 1a) Sole Plate: Nominal 2 x 4 or 2 x 6 solid sawn wood.
 - 1b) Sub-flooring: Minimum 5/8" wood panel sheathing
 - 1c) Top Plate: Double Top Plate, nominal 2 x 4, 2 x 6 or double plate system.
 - 1d) Bathtub Waste/Overflow: Maximum opening in wood flooring (Item 1b) 8" x 12", (see Item 7).
2. **Wall Assembly:** Code conforming 1 hour fire-rated gypsum wallboard assembly with wood framing members.
3. **Penetrants:** (See also table of ratings) Schedule 40, ccABS, ABS and PVC pipes for use in DWV (Drain, Waste and Vent) or Closed (Process and Supply) piping systems, PVC –Thin Wall Vacuum Tubing (nominal 2" Diameter); Kitec® PE-AL-PE Polyethylene/Aluminum/Polyethylene Composite Pressure Pipe and PEX pipes for use in (Process and Supply) piping systems. Penetrants must be contained within a 1 hour fire-rated gypsum wallboard assembly. Ratings achieved will equal that of floor/ceiling assembly.
 - 3a) Tee's, Elbows and Couplings: Branch piping and connections are permitted within the assembly.

Firestop System Components:

4. **Forming Material:** Mineral wool, 4 pcf, tightly packed, nominal 1" thickness, recessed 3/4" from the top surface of the sole plate and bottom surface of the top plates.
5. **Sheet Metal Strip:** Nominal 1-1/2" width, minimum 30 gauge thickness, secured with wallboard screws, applied to notched or cut out openings in sole and top plates, to act as a retainer for the forming material (Item 4). Apply a 1/4" bead of 3M™ Fire Barrier IC 15WB+ Sealant, on the outside of the strip at the floor interface (Item 6f).
6. **Sealant:** *3M™ Fire Barrier IC 15WB+ Sealant – apply as follows:
 - Sub-Flooring Penetrations
 - 6a) Circular Openings: Apply a 5/8" thickness of sealant within the annular space flush with the floor surface.
 - Circular Openings
 - 6b) Top Plate: Apply a 3/4" thickness of caulk, within the annular space flush with the bottom surface of the top plate.
 - 6c) Sole Plate: Apply a 3/4" thickness of caulk, within the annular space, flush with the top surface of sole plate.
 - Notched Penetrations
 - 6d) Top Plate: Apply a 3/4" thickness of sealant, over mineral wool forming material, within the annular space flush with the bottom surface of the top plate.
 - 6e) Sole Plate: Apply a 3/4" thickness of sealant, over mineral wool forming material, within the annular space flush with the top surface of the sole plate.
7. **Gypsum Wallboard Patch:** Two pieces of gypsum wallboard, sized 4" larger than the cutout opening in the flooring, screw-attached to bottom of flooring concentric with cutout.

Note: Metric conversion factor, inches x 25.4 = mm.

*Components bearing the Warnock Hersey Certification Mark.

This material was extracted and drawn by 3M Fire Protection Products from the 2006 Warnock Hersey Directory of Listed Products

3M CANADA CO – London, ON Canada

DESIGN NO. 3M/PH 60-05

July 26, 2006

HORIZONTAL (FLOOR)

RATINGS – SEE TABLE BELOW

TEST PRESSURE DIFFERENTIAL – 50 PA (0.20" OF WATER) MINIMUM

| Penetrating Items | Max. Pipe/ Cable Size* | Max. Opening Size* | Min.-Max. Annular Spacing* | Ratings | |
|-------------------|---------------------------|-----------------------|----------------------------------|----------------------------|--------------------|
| | | | | CAN/ULC-S115 F, FH, FTH | ASTM-E814 F, FT |
| CPVC | 2" | 3-1/4" | 1/4" - 3/8" | 1 Hour | 1 Hour |
| PVC | 1-1/2" | 3" | 1/4" - 1/2" | 1 Hour | 1 Hour |
| ABS | 1-1/2" | 3" | 1/4" - 1/2" | 1 Hour | 1 Hour |
| Copper | 2" | 3" x 3" | 1/8" - 1-1/2" | 1 Hour | 1 Hour |
| Steel/Cast | 4" | 5-1/2" x 6" | 1/8" - 1-1/2" | 1 Hour | 1 Hour |
| EMT | 1-1/2" | 3" x 3" | 0 - 1-1/2" | 1 Hour | 1 Hour |
| BX Cable | 1/2" | 1" | 1/4" | 1 Hour | 1 Hour |
| Electrical** | 1-1/2"*** | 2" | 1/4" - 1/2" | 1 Hour | 1 Hour |

* To convert inches to mm, multiply by 25.4

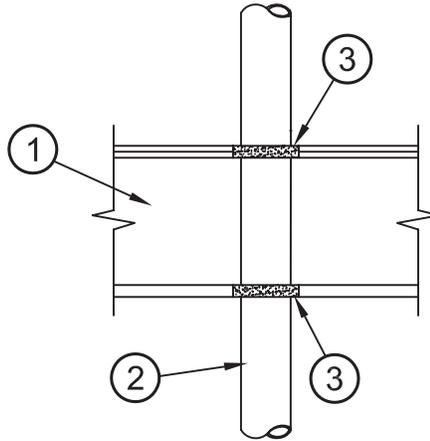

- Floor/Ceiling Assembly** – Wood framed one hour rated assembly with or without concrete topping.
- Penetrating Items** – See Table of Ratings.
Maximum 1-1/2 in. I.D. PVC, 1-1/2 in. I.D. ABS, 2 in. I.D. CPVC, 2 in. PVC Vacuum Tubing, 2 in. I.D. Copper, 4 in. I.D. Steel/Cast, 1-1/2 in. I.D. EMT, and 1/2 in. I.D. BX Cable, through-penetrations, process and supply, or DWV applications.
** For electrical cable or wire penetrations, maximum eight penetrations including loomex, telephone, COAX and detector cables (#18 AWG FT-14 or smaller) or up to one power cable or smaller NMD 90 4 conductor, aluminum or copper.
- Firestop Sealant** – 3M™ Fire Barrier 3000 intumescent silicone sealant. The full depth of the floor and ceiling membranes shall be filled with sealant.

This material was extracted and drawn by 3M Fire Protection Products from the 2006 Warnock Hersey Directory of Listed Products

3M CANADA CO – London, ON Canada

DESIGN NO. 3M/PH 60-07

October 18, 2006

HORIZONTAL (FLOOR)

RATINGS – SEE TABLE BELOW

TEST PRESSURE DIFFERENTIAL – 50 PA (0.20" OF WATER) MINIMUM

| Penetrating Items | Max. Pipe/Cable Size* | Max. Opening Size* | Min.-Max. Annular Spacing* | Ratings | |
|-------------------|-----------------------|--------------------|----------------------------|-------------------------|-----------------|
| | | | | CAN/ULC-S115 F, FH, FTH | ASTM-E814 F, FT |
| CPVC/PVC | 2" | 3" | 1/4" - 1" | 1 Hour | 1 Hour |
| PEX | 1" | 2" | 1/4" - 1/2" | 1 Hour | 1 Hour |
| Copper | 2" | 3" x 3" | 1/8" - 1-1/2" | 1 Hour | 1 Hour |
| Steel/Cast | 4" | 5-1/2" x 6" | 1/8" - 1-1/2" | 1 Hour | 1 Hour |
| EMT | 1-1/2" | 3" x 3" | 0 - 1-1/2" | 1 Hour | 1 Hour |
| BX Cable | 1/2" | 1" | 1/4" | 1 Hour | 1 Hour |
| Electrical** | 1-1/2" ** | 2" | 1/4" - 1/2" | 1 Hour | 1 Hour |

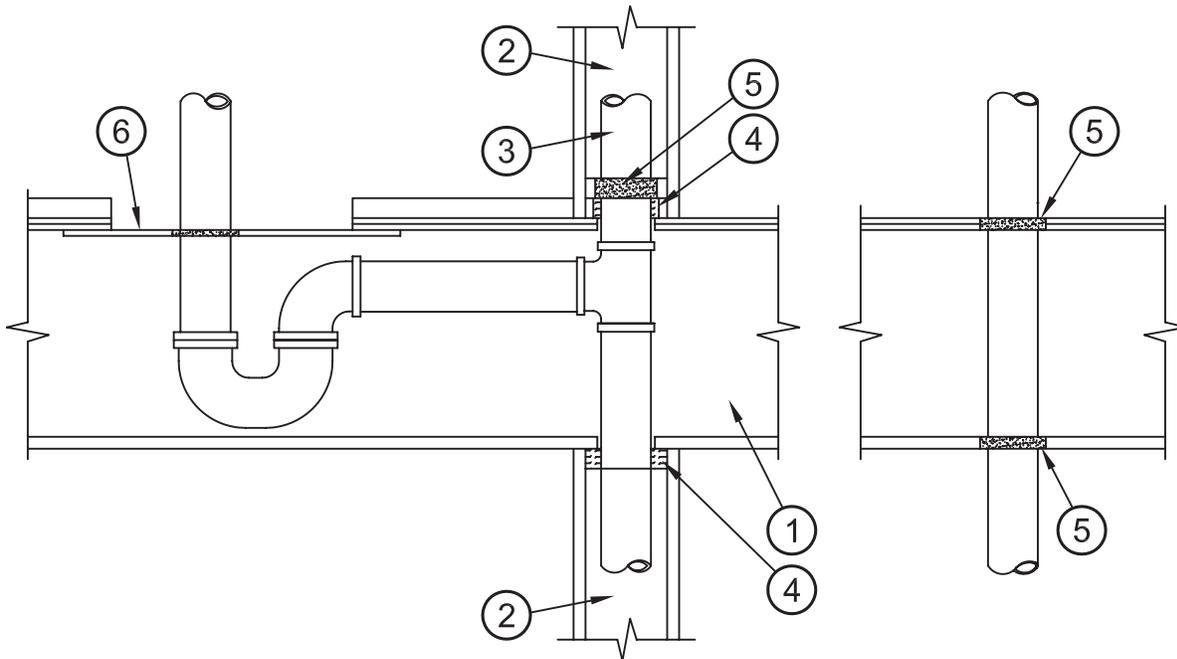

- Floor/Ceiling Assembly** – Wood framed one hour rated assembly with or without concrete topping.
- Wall Assembly** – Rated or unrated gypsum wallboard faced wall assembly with wood stud or steel stud framing members.
- Penetrating Items** – See Table of Ratings. 2 in. PVC vacuum tubing may be used.
 ** For electrical cable or wire penetrations, maximum eight penetrations including loomex, telephone, COAX and detector cables (#18 AWG FT-14 or smaller) or up to one power cable or smaller NMD 90 4 conductor, aluminum or copper.
 For piping (metal and plastic), maximum three penetrations, maintaining minimum annular spacing and minimum 1/2 in. spacing between penetrating items.
For Penetrations of Ceiling Membrane Only: Maximum 1-1/2 in. I.D. steel, EMT, copper, and CPVC pipe in a maximum 2-1/4 in. diameter hole, or 1/2 in. I.D. PEX in a maximum 1-1/8 in. diameter hole.
- Mineral Wood Insulation** – Nominal 4 pcf or greater density mineral wool insulation packed into annular space for full depth of membrane. Mineral wool may be omitted for 1/2 in. PEX or 1/2 in. copper penetrations of the floor surface only when annular space does not exceed 1/4 in.
- Firestop Sealant** – 3M™ Fire Barrier 1003 silicone sealant self leveling or 3M™ Fire Barrier 1000 silicone sealant no sag, applied on top of the mineral wool fill on the bottom plate only to a depth of 3/8 in. For 1/2 in. PEX and 1/2 in. copper penetrating the floor surface only, the sealant shall be applied the full depth of the sub-floor (5/8 in. minimum). Where the annular space is less than 1/4 in., a 1/4 in. crown bead of caulk is to be applied above the floor level. For penetrations of ceiling membrane only, caulk to full depth of gypsum wallboard membrane using 3M™ Fire Barrier 1000 silicone sealant no sag or 3M™ Fire Barrier 3000 WT intumescent silicone sealant. For 2 in. vacuum tubing, 3M™ Fire Barrier 3000 WT intumescent silicone sealant is required.
- 1-1/2" Steel or Copper Tub or Shower Drain** – May be firestopped by sealing a maximum 10 in. by 10 in. floor opening with 5/8 in. Type X gypsum wallboard fastened with at least 4 screws and a perimeter bead of 3M™ Fire Barrier 1000 silicone sealant no sag applied to the full depth of the annular space and to the perimeter of the wallboard.

Note: Metric conversion factor, inches x 25.4 = mm.

*Components bearing the Warnock Hersey Certification Mark.

This material was extracted and drawn by 3M Fire Protection Products from the 2006 Warnock Hersey Directory of Listed Products

3M CANADA CO – London, ON Canada

DESIGN NO. 3M/PH 120-01

February 06, 2006

HORIZONTAL (FLOOR);

RATINGS – SEE BELOW

TEST PRESSURE DIFFERENTIAL – 50 Pa (0.20" OF WATER).

| Penetrant | Max. Pipe ID | CAN/ULC-S115 | | | |
|------------|--------------|--------------|------|------|------|
| | | F | FT | FH | FTH |
| PVC | 4" | 2 Hr | 2 Hr | 2 Hr | 2 Hr |
| System XFR | 6" | 2 Hr | 2 Hr | 2 Hr | 2 Hr |
| RNC - PVC | 4" | 2 Hr | 2 Hr | 2 Hr | 2 Hr |
| ccABS | 4" | 2 Hr | 1 Hr | 2 Hr | 1 Hr |
| ABS | 4" | 2 Hr | 1 Hr | 2 Hr | 1 Hr |
| CPVC | 6" | 2 Hr | 2 Hr | 2 Hr | 2 Hr |

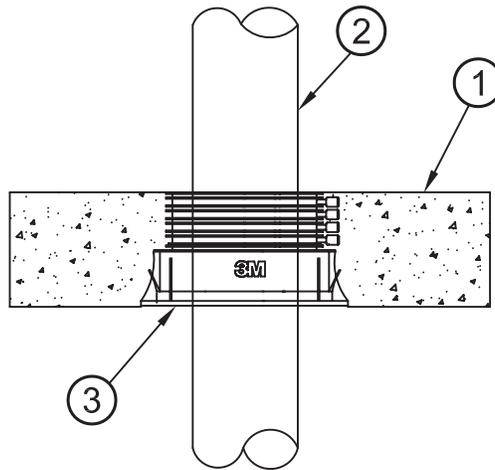

- Floor Assembly:** Code conforming 2 hour fire-rated assembly, minimum 4-1/2" thickness, normal or low density cast concrete.
- Penetrant:** (See table above) Schedule 40, ccABS, ABS, PVC, CPVC, System XFR pipes for DWV (Drain Waste and Vent) or Closed (Process and Supply) piping systems and RNC – PVC (Rigid Non-Metallic Conduit), ratings achieved will equal that of floor assembly. Pipe is inserted from the floor side.
- Firestop System Components:**
 *3M™ Fire Barrier Plastic Cast in Device (PCID): The device is secured to the deck forming membrane, permanently embedded during concrete placement or grouted in concrete assembly in accordance with accompanying installation instructions. The device may be trimmed flush with top surface of the floor or may project up to a maximum of 3-1/2" above the top surface of the floor. Other ancillary products such as 3M™ Tub Box Adapter (TB) and 3M™ Height Adapter (HA) may be attached to the device when required.

3M™ PCID Size Chart

| Device | Nominal Pipe ID |
|-----------|-----------------|
| 3M™ 2PCID | 1-1/2" |
| 3M™ 2PCID | 2" |
| 3M™ 3PCID | 3" |
| 3M™ 4PCID | 4" |
| 3M™ 6PCID | 6" |

Note: Metric conversion factor, inches x 25.4 = mm.

*Components bearing the Warnock Hersey Certification Mark.

This material was extracted and drawn by 3M Fire Protection Products from the 2006 Warnock Hersey Directory of Listed Products

Through Penetrations

Horizontal

2 Hour

PH

3M CANADA CO – London, ON Canada

DESIGN NO. 3M/PH 120-02

July 26, 2006

HORIZONTAL (FLOOR),

RATINGS – See Below,

MAXIMUM OPENING – See Item 3

TEST PRESSURE DIFFERENTIAL – 50 Pa (0.20" OF WATER)

| Penetrant | Pipe Size | CAN/ULC-S115 CAN4-S115 F, FH, FT, FTH | ASTM-E814 F, T |
|-----------------|-------------|---|-------------------|
| ccPVC | 1-1/2" - 4" | 2 Hr | 2 Hr |
| PVC | 1-1/2" - 4" | 2 Hr | 2 Hr |
| CPVC | 1-1/2" - 4" | 2 Hr | 2 Hr |
| ccABS | 1-1/2" - 4" | 2 Hr | 2 Hr |
| ABS | 1-1/2" - 4" | 2 Hr | 2 Hr |
| FRPP | 1-1/2" - 4" | 2 Hr | 2 Hr |
| PVC - Thin Wall | 2" | 2 Hr | 2 Hr |

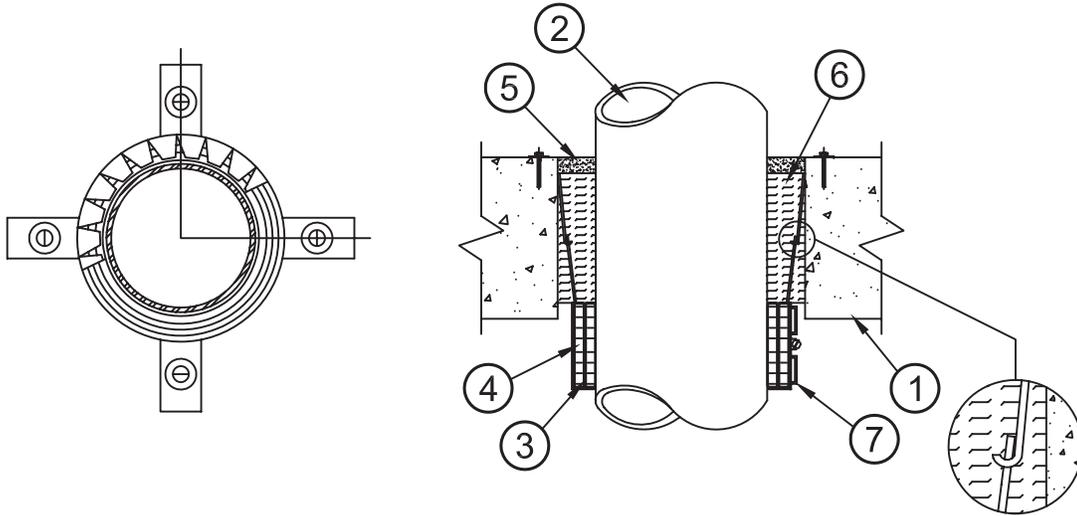

- Floor/Assembly:** Code conforming 2 hour fire-rated floor or wall assembly, minimum 2-1/2" thick, normal or low density cast concrete, hollow core concrete or Q-Deck.
- Penetrant:** (See table of ratings) Schedule 40, PVC, ccPVC, CPVC, ccABS, ABS and FRPP pipes for use in DWV (Drain, Waste and Vent) or Closed (Process and Supply) piping systems and PVC - Thin Wall Vacuum Tubing (2" diameter), ratings achieved equal that of floor assembly.
- Firestop System Components:**
 - *3M™ RC-1 Collar System – A length of steel collar (Item 3) is applied over the *3M™ Interam™ Ultra GS Wrap (Item 4). The steel collar is secured with self tapping screws or a stainless steel hose clamp (Item 7). Anchoring tabs are extended to the top of the floor and secured to the floor surface with masonry anchors. Anchoring tab extenders may be cut from the 3M™ Fire Barrier RC-1 Restricting Collar by cutting the width of the collar from the anchor tab (large tab) through to the retaining tab (smaller tapered tab), the extender is hooked to the anchor tab as shown.
 - Apply 1/4" thickness of *3M™ Fire Barrier CP-25WB+ Caulk, *3M™ Fire Barrier IC 15WB+ Sealant or *3M™ Moldable Putty+ (MPS2) (Item 5) flush with the floor surface over 4 pcf mineral wool (Item 6) forming material. CPVC Pipe - use only *3M™ Fire Barrier IC 15 WB+ Sealant.
 - (Alternate Method - Not Shown): *3M™ Interam™ Ultra PPD or 3M™ Fire Barrier RC Pack sized according to pipe ID, secured flush with underside of floor, annular space 1/4".
 - For PVC - Thin Wall Vacuum Tubing (2" diameter) use *3M™ Interam™ Ultra PPD-1.5.

| Pipe ID | Max. Opening | Anchors Required | *3M™ Interam™ Ultra GS Layers |
|---------|--------------|------------------|-------------------------------|
| 1-1/2" | 3" | 2 | 2 |
| 2" | 4" | 2 | 2 |
| 3" | 5" | 3 | 3 |
| 4" | 6" | 4 | 4 |

Note: Metric conversion factor, inches x 25.4 = mm.

*Components bearing the Warnock Hersey Certification Mark.

This material was extracted and drawn by 3M Fire Protection Products from the 2006 Warnock Hersey Directory of Listed Products

3M CANADA CO – London, ON Canada

DESIGN NO. 3M/PH 120-03

July 26, 2006

HORIZONTAL (FLOOR);

RATINGS – SEE TABLE BELOW

TEST PRESSURE DIFFERENTIAL – 50 Pa (0.20" OF WATER)

| Penetrant | Max. Pipe ID | CAN/ULC-S115 | | | |
|------------|--------------|--------------|------|------|------|
| | | F | FT | FH | FTH |
| PVC | 4" | 2 Hr | 2 Hr | 2 Hr | 2 Hr |
| System XFR | 4" | 2 Hr | 2 Hr | 2 Hr | 2 Hr |
| RNC - PVC | 4" | 2 Hr | 2 Hr | 2 Hr | 2 Hr |
| ccABS | 4" | 2 Hr | 1 Hr | 2 Hr | 1 Hr |
| ABS | 4" | 2 Hr | 1 Hr | 2 Hr | 1 Hr |

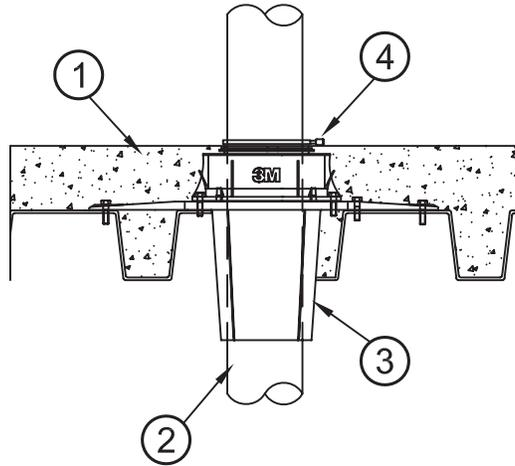

- Floor Assembly:** Code conforming 2 hour fire-rated assembly, minimum 2-1/2" concrete thickness, Q Deck or Fluted Deck, normal or low density cast concrete.
- Penetrant:** (See table above) Schedule 40, ccABS, ABS, PVC, System XFR pipes for use in DWV (Drain Waste and Vent) or Closed (Process and Supply) piping systems and RNC - PVC (Rigid Non-Metallic Conduit), ratings achieved will equal that of floor assembly. Pipe is inserted from the floor side.
- Firestop System Components:** *3M™ MDA (Metal Deck Adapter): The adapter is positioned in the metal deck opening and secured to the metal deck ribs creating a horizontal flat surface to permit mounting of the appropriately sized *3M™ PCID.
- Firestop System Components:** *3M™ Fire Barrier Plastic Cast in Device (PCID): The device is attached to the 3M™ Metal Deck Adapter (MDA) by inserting the base of the device into the locking tabs of 3M™ MDA. The device and adapter are permanently embedded during concrete placement or grouted in concrete assembly in accordance with accompanying installation instructions. The device may be trimmed flush with top of the floor or may project up to a maximum of 3-1/2" above the top surface of the floor.

3M™ PCID Size Chart

| Device | Nominal Pipe ID | Adapter |
|-----------|-----------------|----------|
| 3M™ 2PCID | 1-1/2" | 3M™ 2MDA |
| 3M™ 2PCID | 2" | 3M™ 2MDA |
| 3M™ 3PCID | 3" | 3M™ 3MDA |
| 3M™ 4PCID | 4" | 3M™ 4MDA |

Note: Metric conversion factor, inches x 25.4 = mm.

*Components bearing the Warnock Hersey Certification Mark.

This material was extracted and drawn by 3M Fire Protection Products from the 2006 Warnock Hersey Directory of Listed Products

Through Penetrations

Horizontal

2 Hour

PH

3M CANADA CO – London, ON Canada

DESIGN NO. 3M/PH 120-04

July 26, 2006

HORIZONTAL (FLOOR); RATINGS – SEE TABLE BELOW
TEST PRESSURE DIFFERENTIAL – 50 Pa (0.20" OF WATER)

| Penetrant | Max. Pipe ID | CAN/ULC-S115 | | | |
|------------|--------------|--------------|------|------|------|
| | | F | FT | FH | FTH |
| PVC | 2" | 2 Hr | 2 Hr | 2 Hr | 2 Hr |
| System XFR | 2" | 2 Hr | 2 Hr | 2 Hr | 2 Hr |
| ccABS | 2" | 2 Hr | 1 Hr | 2 Hr | 1 Hr |
| ABS | 2" | 2 Hr | 1 Hr | 2 Hr | 1 Hr |

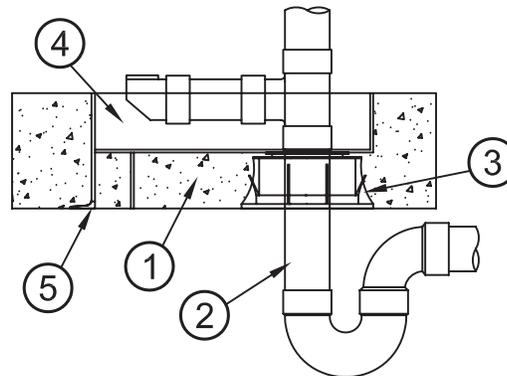

- Floor Assembly:** Code conforming 2 hour, fire-rated floor assembly, minimum 4-1/2" concrete thickness, normal or low density cast concrete.
- Penetrant:** (See table above) Schedule 40, ccABS, ABS, PVC, System XFR pipes for use in DWV (Drain Waste and Vent) or Closed (Processed and Supply) piping systems, ratings achieved will equal that of floor assembly. Branch pipe and couplings shown may vary according to actual application. Pipe is inserted from the floor side.
- Firestop System Components:** *3M™ Fire Barrier Plastic Cast in Device (PCID): The device is secured to the deck forming membrane, permanently embedded during concrete placement or grouted in concrete assembly in accordance with accompanying installation instructions. The device may be trimmed flush with top surface of the floor.
- 3M™ Tub Box (TB) Adapter:** Adjust leg length for concrete thickness, insert legs (Item 5) into the 3M™ 2TB connect 3M™ 2TB to the *3M™ 2PCID, secure legs to the deck forming membrane.

3M™ PCID Size Chart

| Device | Nominal Pipe ID | Tub Box Adapter |
|-----------|-----------------|-----------------|
| 3M™ 2PCID | 1-1/2" | 3M™ 2TB |
| 3M™ 2PCID | 2" | 3M™ 2TB |

Note: Metric conversion factor, inches x 25.4 = mm.

*Components bearing the Warnock Hersey Certification Mark.

This material was extracted and drawn by 3M Fire Protection Products from the 2006 Warnock Hersey Directory of Listed Products

3M CANADA CO – London, ON Canada

DESIGN NO. 3M/PH 120-05

July 26, 2006

HORIZONTAL (FLOOR)

RATINGS – SEE BELOW

ANNULAR SPACE – 1/4" MAXIMUM THROUGH GYPSUM CEILING and AT SINGLE OR DOUBLE TOP PLATES;

ANNULAR SPACE – 1/2" MAXIMUM THROUGH WOOD FLOOR

TEST PRESSURE DIFFERENTIAL – 50 Pa (0.20" OF WATER)

| Penetrant | Pipe Size | CAN/ULC-S115 CAN4-S115 F, FH, FT, FTH | ASTM-E814 F, T |
|-----------------|-------------|---|-------------------|
| ccPVC | 1-1/2" - 4" | 1 & 2 Hr | 1 & 2 Hr |
| PVC | 1-1/2" - 4" | 1 & 2 Hr | 1 & 2 Hr |
| CPVC | 1-1/2" - 4" | 1 & 2 Hr | 1 & 2 Hr |
| ccABS | 1-1/2" - 4" | 1 & 2 Hr | 1 & 2 Hr |
| ABS | 1-1/2" - 4" | 1 & 2 Hr | 1 & 2 Hr |
| FRPP | 1-1/2" - 4" | 1 & 2 Hr | 1 & 2 Hr |
| PVC - Thin Wall | 2" | 1 & 2 Hr | 1 & 2 Hr |

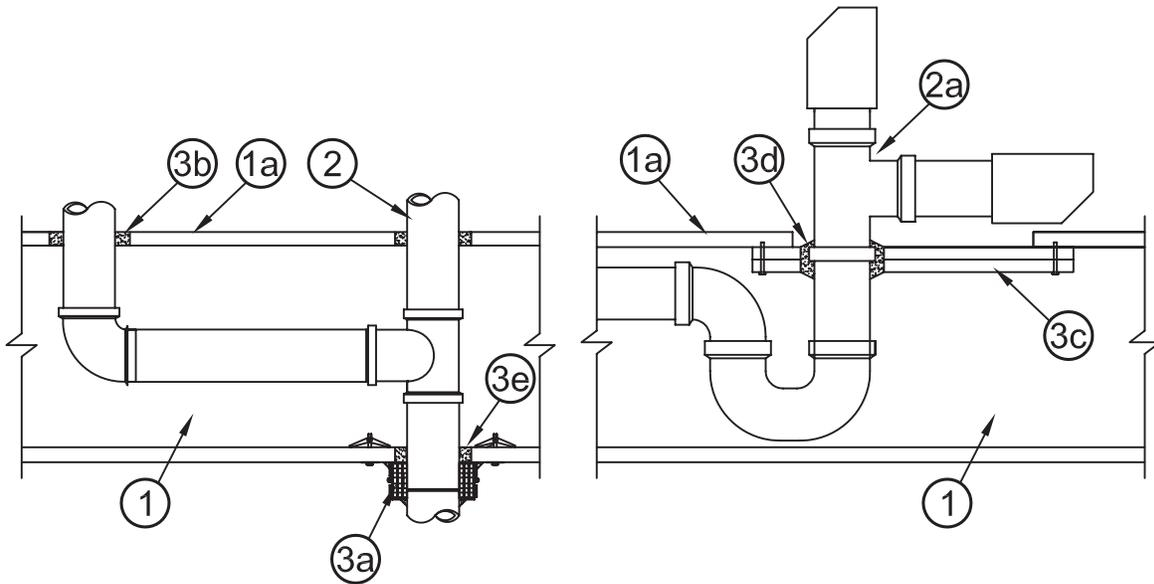

- Floor/Ceiling Assembly:** Code conforming 1 or 2 hour fire-rated floor/ceiling assembly, framed with minimum nominal 2" x 10" solid sawn or manufactured wood joists, topping optional (not shown).
Chase Wall (Optional - Not Shown): 1 or 2 hour fire-rated or non fire-rated wood or steel stud gypsum wallboard assembly, when used, install the firestop system as detailed in (Item 3) to the underside of single and double top plates.
 - Flooring System: Maximum rectangular cutout, 8" x 12", in flooring to accommodate the Bathtub Waste/Overflow Fitting (Item 2a).
- Penetrant:** (See also table of ratings) Schedule 40, PVC, ccPVC, CPVC, ABS, ccABS and FRPP for use in DWV (Drain, Waste and Vent) or Closed (Process and Supply) piping systems and Thin Wall Vacuum Tubing (nominal 2" diameter), branch piping, Tee's, Couplings and Elbows Optional within assembly. Ratings achieved will equal that of floor/ceiling assembly.
 - Bathtub Waste/Overflow Fitting: Maximum pipe diameter 2", any of the pipe types detailed above may be used, see Item 3c Gypsum Wallboard Patch.
- Firestop System Component:**
 - *3M™ Interam™ Ultra PPD or *3M™ Fire Barrier RC Pack: Sized appropriately for pipe secured with *3M™ Ultrafast™ Anchors or 1-1/2" toggle bolts over fender washers, use 1-1/4" drywall screws and fender washers for single and double top plates. Use *3M™ Interam™ Ultra PPD-1.5 for nominal 2" diameter Thin Wall PVC Vacuum Tubing.

| Pipe ID | Anchors Required |
|---------|------------------|
| 1-1/2" | 2 |
| 2" | 2 |
| 3" | 3 |
| 4" | 4 |

Design No. PH 120-05 continued

- b) Sealant: *3M™ Fire Barrier CP-25WB+ Caulk, *3M™ Fire Barrier IC 15WB+ Sealant or *3M™ FireDam 150+ Caulk or *3M™ Moldable Putty+ (MPS2), to fill the annular space to a minimum depth of 5/8" at the wood floor.
- c) Gypsum Wallboard Patch: Two pieces of gypsum wallboard, sized 4" larger than the cutout opening in the flooring, screw-attached to bottom of flooring concentric with cutout. Diameter of opening through both layers of the Gypsum Wallboard Patch is maximum 2-1/2" for 1-1/2" diameter pipes and maximum 3" for 2" diameter pipes.
- d) Sealant: *3M™ Fire Barrier CP-25WB+ Caulk, *3M™ Fire Barrier IC 15WB+ Sealant, *3M™ FireDam 150+ Caulk or *3M™ Moldable Putty (MPS2) applied within the annular space around the penetrant to the full thickness of the Gypsum Wallboard Patch.
- e) Sealant: *3M™ Fire Barrier CP-25WB+ Caulk, *3M™ Fire Barrier IC 15WB+ Sealant, *3M™ FireDam 150+ Caulk or *3M™ Moldable Putty+ (MP2S), to fill the annular space at the pipe penetration as a smoke seal, however, it is not required to achieve stated ratings.

Note: CPVC Pipe - use only *3M™ Fire Barrier IC 15WB+ Sealant

Note: Metric conversion factor, inches x 25.4 = mm.

*Components bearing the Warnock Hersey Certification Mark.

This material was extracted and drawn by 3M Fire Protection Products from the 2006 Warnock Hersey Directory of Listed Products

Through Penetrations

Horizontal

1, 2 Hour

PH

3M CANADA CO – London, ON Canada

DESIGN NO. 3M/PH 120-06

July 26, 2006

HORIZONTAL (FLOOR); RATINGS – SEE BELOW

TEST PRESSURE DIFFERENTIAL – 2.5 Pa (0.01" OF WATER)

Design conforms to NBC 1995, reference clause 3) of 3.1.5.15 "Combustible Piping Materials".

| Penetrant | Max. Pipe ID | CAN/ULC-S115 | | | |
|-----------|--------------|--------------|------|------|------|
| | | F | FT | FH | FTH |
| FRPP | 4" | 2 Hr | 2 Hr | 2 Hr | 2 Hr |

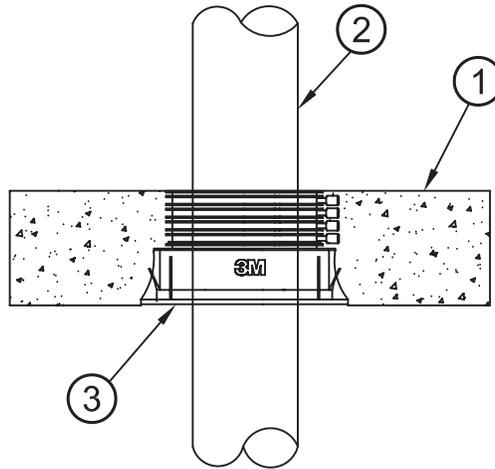

- Floor/Ceiling Assembly:** Code conforming 2 hour fire-rated floor assembly, nominal 4-1/2" thickness, normal or low density cast concrete.
- Penetrant:** (See table above) Schedule 40, FRPP pipes for DWV (Drain, Waste and Vent) or Closed (Process and Supply) piping systems, ratings achieved will equal that of floor assembly. Pipe is inserted from the floor side.
- Firestop System Component:** *3M™ Fire Barrier Plastic Cast in Device (PCID): The device is secured to the deck forming membrane, permanently embedded during concrete placement or grouted in concrete assembly in accordance with accompanying installation instructions. The device may be trimmed flush with top surface of the floor or may project up to a maximum of 3-1/2" above the top surface of floor. Other ancillary products such as 3M™ Tub Box (TB) Adapter and 3M™ Height Adapter (HA) may be attached to the device when required.

3M™ PCID Size Chart

| Device | Nominal Pipe ID |
|-----------|-----------------|
| 3M™ 2PCID | 1-1/2" |
| 3M™ 2PCID | 2" |
| 3M™ 3PCID | 3" |
| 3M™ 4PCID | 4" |

Note: Metric conversion factor, inches x 25.4 = mm.

*Components bearing the Warnock Hersey Certification Mark.

This material was extracted and drawn by 3M Fire Protection Products from the 2006 Warnock Hersey Directory of Listed Products

Through Penetrations

Horizontal

2 Hour

PH

3M CANADA CO – London, ON Canada

DESIGN NO. 3M/PH 120-07

July 26, 2006

HORIZONTAL (FLOOR); RATINGS – SEE TABLE BELOW
TEST PRESSURE DIFFERENTIAL – 50 Pa (0.20" OF WATER)

| Max. Device Size | CAN/ULC-S115 | | | |
|------------------|--------------|------|---------------------------|---------------------------|
| | F | FT | FH | FTH |
| 4" | 2 Hr | 0 Hr | 0 Hr or 2 Hr (see Item 2) | 0 Hr or 2 Hr (see Item 2) |

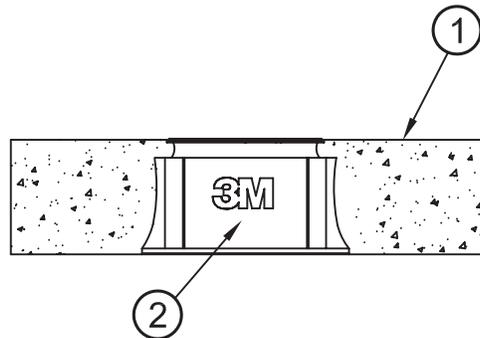

- Floor Assembly:** Code conforming 2 hour fire-rated floor assembly, minimum 2-1/2" thickness (Q-Deck or Fluted Deck), normal or low density cast concrete.
- Firestop System Components:**
*3M™ Fire Barrier Plastic Cast in Device (PCID): The device (2", 3" or 4" diameter) is secured to the deck forming membrane, permanently embedded during concrete placement or grouted in concrete assembly in accordance with accompanying installation instructions. The device may be trimmed flush with top surface of the floor or may project up to a maximum of 3-1/2" above the top surface of floor. H rating of 2 hours is achieved by attaching a Steel Plate, 24 gauge (or heavier), diameter 2" larger than the floor opening, secured with masonry anchors, to the floor surface, over the 3M™ PCID.

Penetrating Item: Not Required.

Note: Metric conversion factor, inches x 25.4 = mm.

*Components bearing the Warnock Hersey Certification Mark.

This material was extracted and drawn by 3M Fire Protection Products from the 2006 Warnock Hersey Directory of Listed Products

3M CANADA CO – London, ON Canada

DESIGN NO. 3M/PH 120-08

July 26, 2006

HORIZONTAL (FLOOR),

RATINGS – SEE BELOW, HOLE SIZE – SEE ITEM 3

TEST PRESSURE DIFFERENTIAL – 50 Pa (0.20" OF WATER)

| Penetrant | Max. Pipe ID | CAN/ULC-S115 | | | |
|-----------------|--------------|--------------|------|------|------|
| | | F | FT | FH | FTH |
| PVC | 2" | 2 Hr | 2 Hr | 2 Hr | 2 Hr |
| ccABS | 3" | 2 Hr | 2 Hr | 2 Hr | 2 Hr |
| ABS | 2" | 2 Hr | 2 Hr | 2 Hr | 2 Hr |
| PVC - Thin Wall | 2" | 2 Hr | 1 Hr | 2 Hr | 1 Hr |

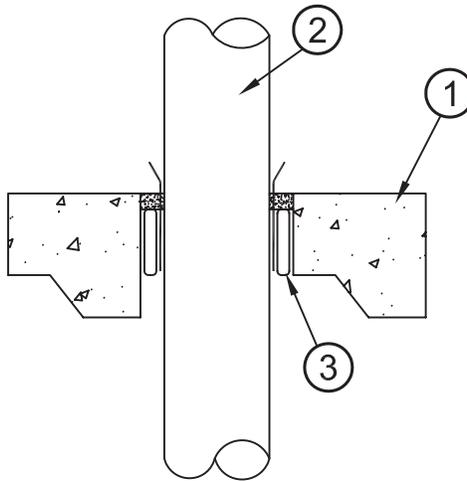

- Floor Assembly:** Code conforming 2 hour fire-rated floor assembly, nominal 2-1/2" thick concrete, Q Deck or Fluted Deck, normal or low density cast concrete.
- Penetrant:** (See table of ratings) Schedule. 40, ccABS, ABS, PVC pipes for use in DWV (Drain, Waste and Vent) or Closed (Process and Supply) piping systems and PVC-Thin Wall Vacuum Tubing (nominal 2" diameter), ratings achieved will equal that of floor assembly.
- Firestop System Component:** *3M™ FireStrap™ : Install within opening 1/2" below the floor surface of the concrete according to the manufacturer's instructions.
Use *3M™ FireStrap™ 1-1/2" for PVC - Thin Wall Vacuum Tubing (nominal 2" diameter).

| Pipe ID | Hole Size |
|---------|-----------|
| 1-1/2" | 2-1/2" |
| 2" | 3" |
| 3" | 4-1/2" |

- Sealant:** *3M™ Fire Barrier CP-25WB+ Caulk, *3M™ Fire Barrier IC 15WB+ Sealant or *3M™ FireDam 150+ Caulk, applied to 1/2" thickness flush with the floor surface.

Note: Metric conversion factor, inches x 25.4 = mm.

*Components bearing the Warnock Hersey Certification Mark.

This material was extracted and drawn by 3M Fire Protection Products from the 2006 Warnock Hersey Directory of Listed Products

Through Penetrations

Horizontal

2 Hour

PH

3M CANADA CO – London, ON Canada

DESIGN NO. 3M/PH 120-09

July 27, 2006

HORIZONTAL (FLOOR), RATINGS – SEE BELOW, HOLE SIZE – SEE ITEM 3
 TEST PRESSURE DIFFERENTIAL – 50 Pa (0.20" OF WATER)

| Penetrant | Max. Pipe ID | CAN/ULC-S115 F, FT |
|---------------------------|--------------|-----------------------|
| UPP (Ultra Polypropylene) | 2" | 2 Hr |
| PVC | 3" | F: 2 Hr, T: 30 Min. |

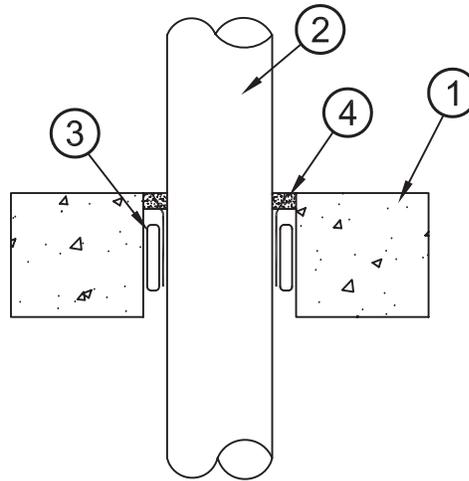

- Floor or Wall Assembly:** Code conforming 2 hour fire-rated floor assembly, nominal 4-1/2" thickness, reinforced lightweight or normal weight concrete.
- Penetrant:** (See table of ratings) Schedule 40 PVC pipes for use in DWV (Drain, Waste and Vent) or Closed (Process and Supply) piping systems. Rating achieved will equal that of floor assembly.
- Firestop System Components:** * 3M™ FireStrap™ : Install within opening, projecting 1/4" below ceiling surface for solid concrete floor applications, according to the manufacturers instructions. To reduce hole size to the size listed, back fill with *3M™ Fire Barrier Mortar Use 3M™ Firestrap™ 1-1/2" for PVC - Thin Wall Vacuum Tubing (nominal 2" diameter).

| Pipe ID | Hole Size |
|---------|-----------|
| 1-1/2" | 2-1/2" |
| 2" | 3" |
| 3" | 4-1/2" |

Sealant: *3M™ Fire Barrier CP-25WB+ Caulk or *3M™ Fire Barrier IC 15WB+ Sealant, applied to 1/4" thickness flush with the floor surface. Firestop System is applied to both sides for wall applications.

Note: Metric conversion factor, inches x 25.4 = mm.

*Components bearing the Warnock Hersey Certification Mark.

This material was extracted and drawn by 3M Fire Protection Products from the 2006 Warnock Hersey Directory of Listed Products

3M CANADA CO – London, ON Canada

DESIGN NO. 3M/PH 120-10

July 26, 2006

HORIZONTAL (FLOOR)

RATINGS: 2 HOURS F, FT, FTH

TESTING STANDARDS: ASTM – E814, ULC-S115-M95

TEST PRESSURE DIFFERENTIAL – 2.5 PA (0.01" OF WATER) MINIMUM

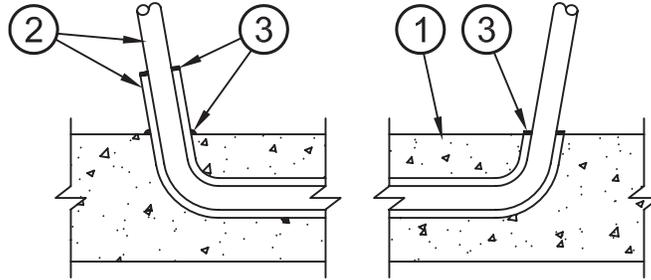

1. **Floor Assembly** – 2 Hour rated concrete floor assembly, minimum 4-1/2 in. thickness.
2. **Penetrating Items** – Nominal 1 in. PEX tubing installed in 1-1/2 in. PVC conduit. Conduit may be cut flush with top of slab or allowed to extend to 8 in. above slab.
3. **Firestop Sealant** – Minimum 1/4 in. depth bead of 3M™ Fire Barrier 1000 silicone sealant no sag shall be installed around PEX tubing to seal annular space. A bead is also required around 1-1/2 in. PVC conduit if it extends above the slab. 3M™ Fire Barrier 1003 silicone sealant self leveling may be used around PEX tubing if the annular space is packed with a small amount of mineral wool insulation.

Note: Metric conversion factor, inches x 25.4 = mm.

*Components bearing the Warnock Hersey Certification Mark.

This material was extracted and drawn by 3M Fire Protection Products from the 2006 Warnock Hersey Directory of Listed Products

Through Penetrations

Horizontal

2 Hour

PH

3M CANADA CO. – London, On Canada

DESIGN NO. 3M/PH 120-16

September 08, 2006

HORIZONTAL (FLOOR); RATINGS – SEE BELOW; HOLE SIZE – SEE ITEM 3
 TEST PRESSURE DIFFERENTIAL – 50 Pa (0.20" OF WATER)

| Penetrant | Max. Pipe ID | CAN/ULC-S115 F, FH, FT, FTH |
|-----------|--------------|--------------------------------|
| PVC | 3" | 2 Hr |
| ccABS | 3" | 2 Hr |
| ABS | 3" | 2 Hr |

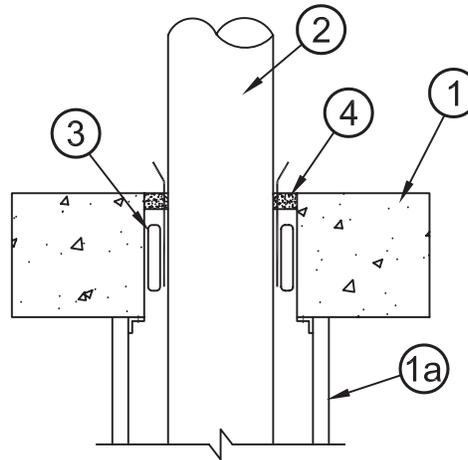

- Floor Assembly:** Code conforming 2 hour fire-rated floor assembly, nominal 4-1/2" thickness, normal or low density cast concrete.
 - Wall Assembly:** Gypsum wallboard assembly, constructed with rated or non-rated wallboard, nominal 3-1/2" deep steel studs. Steel ceiling track is secured to the underside of the floor assembly.
- Penetrant:** (See table above) Nominal 3" diameter or smaller, Schedule 40, ccABS, ABS, PVC pipes for use in DWV (Drain, Waste and Vent) or Closed (Process and Supply) piping systems. Penetrants must be contained within a wall assembly, ratings achieved will equal that of floor assembly.
- Firestop System Components:** *3M FireStrap™ : Install within opening, recessed 1-1/4" from either surface, according to the manufacturer's instructions. To reduce hole diameter to the size listed, back fill with *3M™ Fire Barrier Mortar.

| Pipe ID | Hole Size |
|---------|--------------|
| 1-1/2" | 2-1/2" to 3" |
| 2" | 3" to 3-1/2" |
| 3" | 4-1/2" to 5" |

- Sealant:** *3M™ Fire Barrier CP-25WB+ Caulk, *3M™ Fire Barrier IC 15WB+ Sealant or *3M™ FireDam 150+ Caulk, applied to 1/2" thickness flush with the floor surface.

Note: Metric conversion factor, inches x 25.4 = mm.

*Components bearing the Warnock Hersey Certification Mark.

This material was extracted and drawn by 3M Fire Protection Products from the 2006 Warnock Hersey Directory of Listed Products

Design No. FS 530 F

August 1, 2003

FIRE PENETRATION SEAL (Mechanical)

Penetrating Item Type A

T-Rating - 0 hr

F-Rating - 3 hr

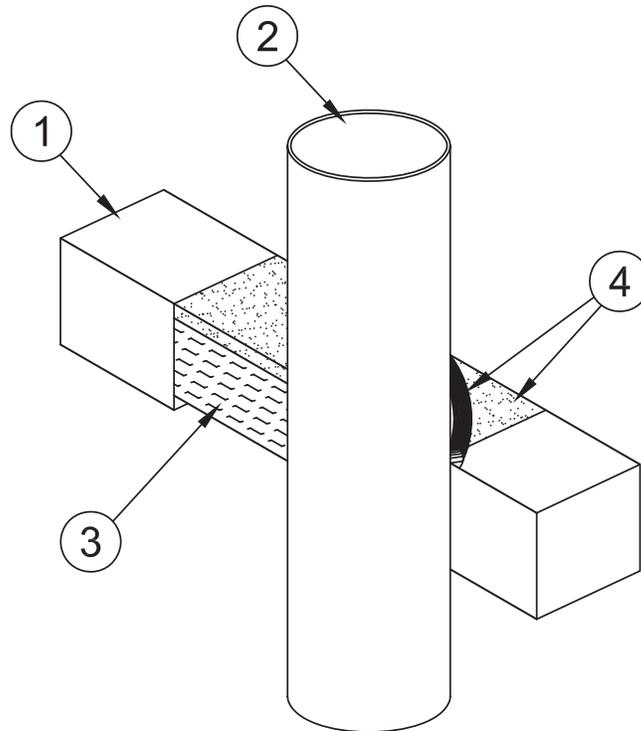

1. FLOOR ASSEMBLY: The three-hour “F-rated” floor/ceiling assembly shall consist of min. 4-1/2 in. thick lightweight or normal-weight (100-150 pcf) reinforced concrete. Max. diameter of penetration opening is to be 1/4 in. (min.) to 3-1/4 in. (max.) larger than the penetrating item.
2. PENETRATING ITEM: One metallic pipe, conduit or tubing to be installed either concentrically or eccentrically within the through opening. The penetrating item is to be rigidly supported on both sides of the floor or wall assembly. An annular space of min. 0 in. (point contact) to max. 3-1/4 in. is required within the fire stop system. The following types and sizes of metallic pipes, conduit or tubing may be used:
 - A. Steel Pipe: Schedule 10 (or heavier) nom. 24 in. diameter (or smaller) steel pipe.
 - B. Conduit: Nom. 4 in. diameter (or smaller) electrical metallic tubing or steel conduit.
 - C. Copper Tubing: Type L (or heavier) nom. 6 in. diameter (or smaller) copper tubing.
 - D. Copper Pipe: Nom. 6 in. diameter (or smaller) Regular (or heavier) copper pipe.
3. PACKING MATERIAL: Nom. 3 in. depth of 4 pcf mineral wool batt insulation, tightly and permanently packed into the opening. Surface of packing material is to be recessed from the top surface of the floor or both surfaces of the wall assembly, as required to accommodate the necessary depth of caulk fill material (Item 4).
4. FILL, VOID OR CAVITY MATERIAL: Min. 1/2 in. depth of sealant fill material is to be applied to the recess around the top surface of the floor through-penetration opening or both faces of the wall through-penetration. An additional min. 1/2 in. diameter bead of sealant material is to be applied around the outer perimeter of the through opening, at the penetrating item to concrete interface.

Listed Manufacturer:**3M –****Firestopping****Firestopping Sealant****3M Fire Barrier™ 2000 Silicone Joint Sealant****3M Fire Barrier™ 2003 Silicone Joint Sealant****3M Fire Barrier™ 2000+ Silicone Joint Sealant**

This material was extracted and drawn by 3M Fire Protection Products from the 2010 Product Directory, © Intertek



Design Number 3MU/PV 180-03

August 1, 2003
3M Company
Formerly Design No. FS 531 F
FIRE PENETRATION SEAL (Mechanical)
Penetrating Item Type A
T-Rating - 0 hr
F-Rating - 3 hr

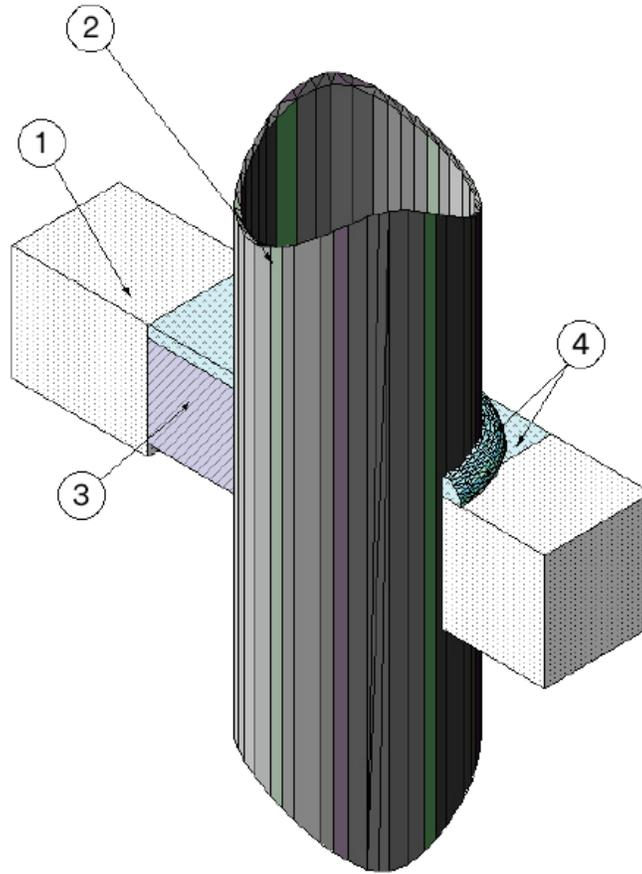

- FLOOR ASSEMBLY:** The three-hour "F- rated" floor/ceiling assembly shall consist of min. 4-1/2 in. thick lightweight or normal-weight (100-150 pcf) reinforced concrete. Max. diameter of penetration opening is to be 15 in.
- PENETRATING ITEM:** One metallic pipe, conduit or tubing to be installed either concentrically or eccentrically within the through opening. The penetrating item is to be rigidly supported on both sides of the floor or wall assembly. An annular space of min. 0 in. (point contact) to max. 2-7/8 in. is required within the fire stop system. The following types and sizes of metallic pipes, conduit or tubing may be used:
 - Steel Pipe:** Schedule 10 (or heavier) nom. 12 in. diameter (or smaller) steel pipe.
 - Conduit:** Nom. 6 in. diameter (or smaller) steel conduit.
 - Conduit:** Nom. 4 in. diameter (or smaller) steel electrical tubing.
 - Copper Tubing:** Type L (or heavier) nom. 6 in. diameter (or smaller) copper tubing.
 - Copper Pipe:** Nom. 6 in. diameter (or smaller) regular (or heavier) copper pipe.
- PACKING MATERIAL:** Nom. 3 in. depth of 4 pcf mineral wool batt insulation, tightly and permanently packed into the opening. Surface of packing material is to be recessed from the top surface of the floor or both surfaces of the wall assembly, as required to accommodate the necessary depth of caulk fill material (Item 4).
- FILL, VOID OR CAVITY MATERIAL:** Min. 1/4 in. depth of sealant fill material is to be applied to the recess around the top surface of the floor through-penetration opening or both faces of the wall through-penetration. An additional min. 1/2 in. diameter bead of sealant material is to be applied around the outer perimeter of the through opening, at the penetrating item to concrete interface.

Listed Manufacturer:

3M
Firestopping
Firestopping Sealant
3M Fire Barrier™ 2000+ Silicone Joint Sealant



Design No. FS 532 F

August 1, 2003

FIRE PENETRATION SEAL (Mechanical)

Penetrating Item Type C

T-Rating-1 hr

F-Rating - 2 hr

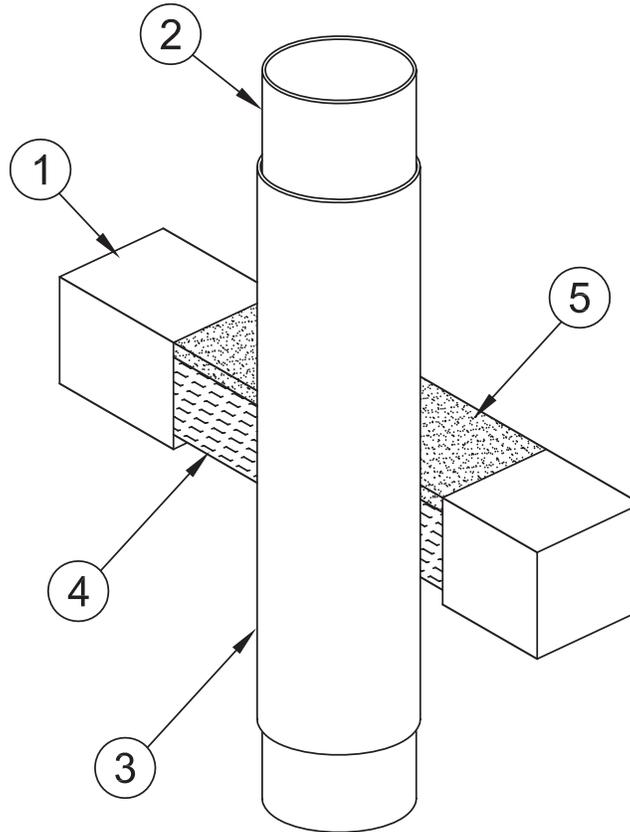

1. FLOOR ASSEMBLY: The fire-rated floor/ceiling assembly shall consist of min. 4-1/2 in. thick lightweight or normal-weight (100-150 pcf) reinforced concrete. Max. diameter of penetration opening is to be 32 in.
2. PENETRATING ITEM: One metallic pipe, conduit or tubing to be installed either concentrically or eccentrically within the through opening. The penetrating item is to be rigidly supported on both sides of the floor or wall assembly. The following types and sizes of metallic pipes, conduit or tubing may be used:
 - A. Steel Pipe: Schedule 10 (or heavier) nom. 24 in. diameter (or smaller) steel pipe.
 - B. Conduit: Nom. 4 in. diameter (or smaller) steel electrical tubing or steel conduit.
 - C. Copper Tubing: Type L (or heavier) nom. 6 in. diameter (or smaller) copper tubing.
 - D. Copper Pipe: Nom. 6 in. diameter (or smaller) regular (or heavier) copper pipe.
3. PIPE COVERING MATERIALS: Nom. 1 in. thick hollow cylindrical heavy density (min. 3.5 pcf) glass fiber units, jacketed on the outside with an all service jacket. Longitudinal joints shall be tightly butted and sealed with metal fasteners or factory applied self-sealing lap tape. Transverse joints shall be secured with metal fasteners or with butt tape supplied with the product. An annular space of 1/2 in. (min.) to 1-1/2 in. (max.) is required within the fire stop system. Any listed pipe covering material meeting the above specifications with a flame Spread Index of 25 or less and a Smoke Developed Index of 50 or less may be used.
4. PACKING MATERIAL: Nom. 3 in. depth of 4 pcf mineral wool batt insulation, tightly and permanently packed into the opening. Surface of packing material is to be recessed from the top surface of the floor or both surfaces of the wall assembly, as required to accommodate the necessary depth of caulk fill material (Item 5).
5. FILL, VOID OR CAVITY MATERIAL: Min. 1/2 in. depth of sealant fill material is to be applied to the recess around the top surface of the floor through-penetration opening or both faces of the wall through-penetration.

Listed Manufacturer:

3M –

Firestopping**Firestopping Sealant**

3M Fire Barrier™ 2000 Silicone Joint Sealant

3M Fire Barrier™ 2003 Silicone Joint Sealant

3M Fire Barrier™ 2000+ Silicone Joint Sealant

This material was extracted and drawn by 3M Fire Protection Products from the 2010 Product Directory, © Intertek



Design Number 3MU/PV 180-04

August 1, 2003
3M Company
Formerly Design No. FS 533 F
FIRE PENETRATION SEAL (Mechanical)
Penetrating Item Type C
T-Rating - 1 hr
F-Rating - 3 hr

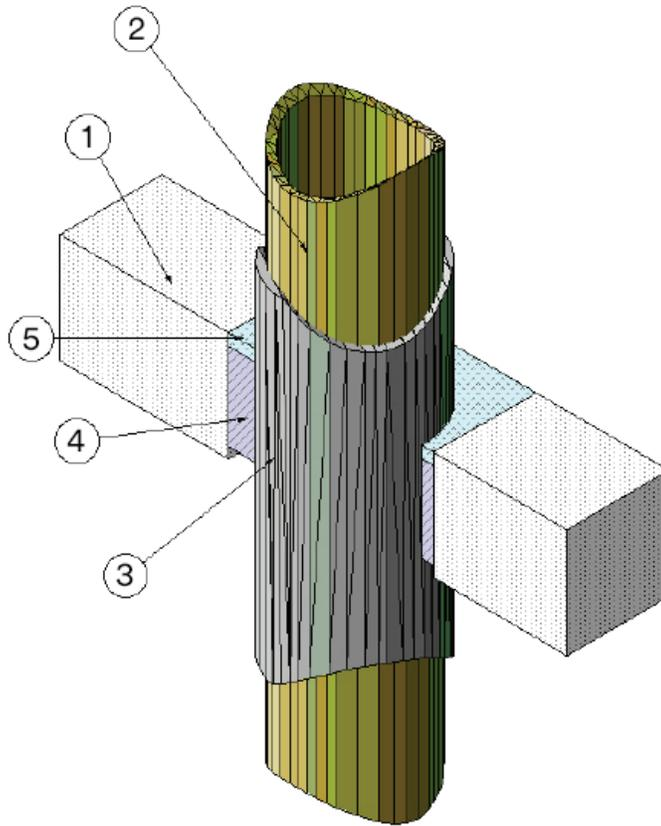

- FLOOR ASSEMBLY:** The fire-rated floor/ceiling assembly shall consist of min. 4-1/2 in. thick lightweight or normal-weight (100-150 pcf) reinforced concrete. Max. diameter of penetration opening is to be 11 in.
- PENETRATING ITEM:** Schedule 10 (or heavier) nom. 6 in. diameter (or smaller) steel pipe to be installed either concentrically or eccentrically within the fire stop system. The pipe is to be rigidly supported on both sides of the floor or wall assembly.
- PIPE COVERING MATERIALS:** Nom. 1 in. thick hollow cylindrical heavy density (min. 3.5 pcf) glass fiber units jacketed on the outside with an all service jacket. Longitudinal joints shall be tightly butted and sealed with metal fasteners or factory applied self-sealing lap tape. Transverse joints shall be secured with metal fasteners or with butt tape supplied with the product. An annular space of 3/4 in. (min.) to 1-5/8 in. (max.) is required within the fire stop system.
- PACKING MATERIAL:** Nom. 3 in. depth of 4 pcf mineral wool batt insulation, tightly and permanently packed into the opening. Surface of packing material is to be recessed from the top surface of the floor or both surfaces of the wall assembly, as required to accommodate the necessary depth of caulk fill material (Item 5).
- FILL, VOID OR CAVITY MATERIAL:** Min. 1/4 in. depth of sealant fill material is to be applied to the recess around the top surface of the floor through-penetration opening or both faces of the wall through-penetration. An additional min. 1/2 in. diameter bead of sealant material is to be applied around the outer perimeter of the through opening, at the penetrating item to concrete interface.

Listed Manufacturer:

3M
Firestopping Firestopping Sealant
3M Fire Barrier™ 2000+ Silicone Joint Sealant



February 14, 2018
 Firestop System
 3M™ Fire Barrier™ 615
 3M™ Fire Barrier™ 615+
 ASTM E814-13a (2017)
 CAN/ULC-S115-11
 Test Pressure Differential – 2.5 Pa (0.01 in. of water)
 Rating1: See Table 1

| Penetrating Item | Max Pipe Diameter | Annular Space | | Rating (minutes) | | | | | |
|------------------|-------------------|---------------|-----------|------------------|-----|--------------|-----|-----|-----|
| | | Min | Max | ASTM E814 | | CAN/ULC S115 | | | |
| | | | | | F | F | FT | FH | FTH |
| Cast Iron | 4 in. | 0 in. | 3-3/8 in. | 120 | 120 | 120 | 120 | 120 | 120 |
| Copper | 2 in. | 0 in. | 1-3/4 in. | 120 | 120 | 120 | 120 | 120 | 120 |

Table 1. Through Penetration Firestop System Installation Details and Ratings

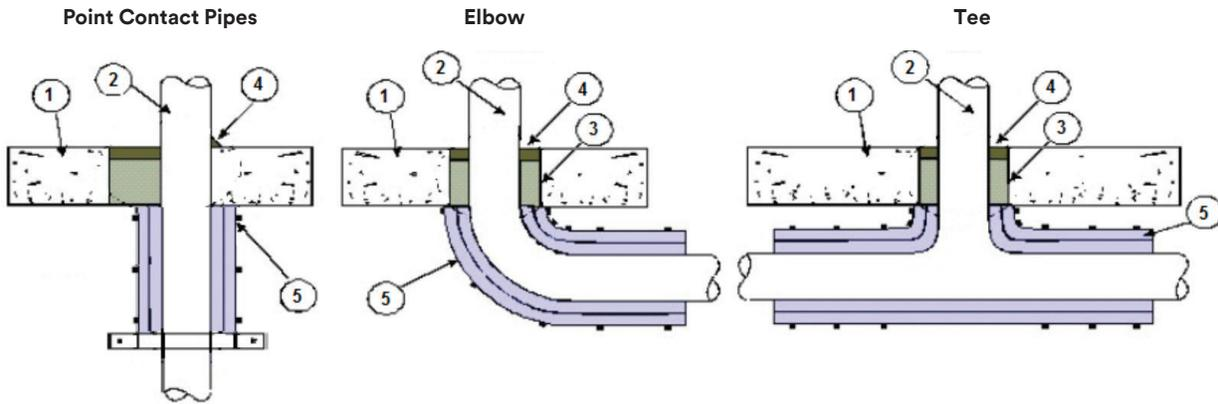

Figure 1. Through Penetration Firestop System

- SUPPORTING CONSTRUCTION:** Refer to Figure 1 and Table 1. Create a round opening in a Code-conforming, 2 hour fire-rated floor/ceiling assembly constructed of min. 8 in. thick lightweight or normal weight reinforced concrete having a nominal density of 100–150 pcf. Size the opening to establish the annular space specified in Table 1. Verify compliance of the supporting construction with its corresponding listed design.
- PENETRATING ITEM:** Refer to Figure 1 and Table 1. Position the pipe in the opening in the supporting construction (Item 1). Establish the annular space between the Penetrating Item and the Supporting Construction (Item 1) as specified in Table 1.
- PACKING MATERIAL:** Tightly pack at min. 50% compression, the annular space with nominal 4 pcf or heavier noncombustible mineral wool insulation to the full depth of the supporting construction (Item 1). Recess the packed insulation a min. of 3/8 in. from the top.
- FILL, VOID OR CAVITY MATERIAL** – Refer to Figure 1 and Table 1. Apply the material listed below, filling the min. 3/8 in. recess created with the packing material (Item 3):

CERTIFIED MANUFACTURER: 3M Company

CERTIFIED PRODUCT: Firestop Sealant

CERTIFIED MODEL: 3M™ Fire Barrier™ 1003 Silicone Self Leveling Sealant or 3M™ Fire Barrier™ 1000 No Sag Silicone Sealant

Apply the material listed above, filling the min. 3/8 in. recess at the top of the supporting construction (Item 1), created with the packing material (Item 3).

- CERTIFIED MANUFACTURER:** 3M Company

CERTIFIED PRODUCT: Duct Wrap

CERTIFIED MODEL: Nominal 6 pcf, 3M™ Fire Barrier™ Duct Wrap 615 and nominal 6 pcf, 3M™ Fire Barrier™ Duct Wrap 615+.

Apply the 3M™ Fire Barrier™ Duct Wrap around the penetrating item (Item 2) projecting from the bottom of the supporting construction (Item 1). Apply two layers of the duct wrap over a min. length of 30 in. starting from the bottom of the supporting construction (Item 1). Seal all seams and cut edges with aluminum foil tape. Use butt joints at all transverse and longitudinal joints and offset the joints between the first and second layers. Use fiber reinforced tape to temporarily secure the duct wrap prior to banding. Secure with 1/2 in. wide, 0.015 in.

3MU/BI 120-04 (cont.)

thick stainless steel banding and 1 in. long stainless steel crimp clamps. Place banding a max. of 1-1/2 in. from any duct wrap edges or outer layer transverse butt joint, and at a max. of 8 in. on center. Tension the banding to hold the duct wrap in place without cutting or damaging the insulation.

- 6. RISER CLAMP:** Use a steel riser clamp on any applications that do not involve a wrapped elbow or tee. Secure the rise clamp to the penetrating item (Item 2) at the end point of the duct wrap (Item 5) to retain the duct wrap tight against the underside of the supporting construction (Item 1).

Through Penetration

Concrete

BI

This material was extracted and drawn by 3M Fire Protection Products from the 2018 Product Directory, © Intertek





Design Number 3MU/BI 120-05

February 14, 2018
 3M Company
 Firestop System
 3M™ Fire Barrier™ 615
 3M™ Fire Barrier™ 615+
 ASTM E814-13a (2017)
 CAN/ULC-S115-11
 Test Pressure Differential – 2.5 Pa (0.01 in. of water)
 Rating1: See Table 1

| Penetrant | Pipe Diameter | Wrap Length | Seams | Layers | CAN/ULC-S115 | | ASTM E814 | |
|-----------|---------------|-------------|-------|--------|--------------|---------|-----------|------|
| | | | | | F, FH | FT, FTH | F | T |
| Steel | 4 in. | 30 in. | None | 1 | 2 Hr | 1 Hr | 2 Hr | 1 Hr |
| Steel | 4 in. | 30 in. | None | 2 | 2 Hr | 2 Hr | 2 Hr | 2 Hr |
| Cast Iron | 4 in. | 30 in. | None | 1 | 2 Hr | 1 Hr | 2 Hr | 1 Hr |
| Cast Iron | 4 in. | 30 in. | None | 2 | 2 Hr | 2 Hr | 2 Hr | 2 Hr |
| EMT/RSC | 4 in. | 30 in. | None | 1 | 2 Hr | 1 Hr | 2 Hr | 1 Hr |
| EMT/RSC | 4 in. | 30 in. | None | 2 | 2 Hr | 2 Hr | 2 Hr | 2 Hr |
| Copper | 4 in. | 36 in. | None | 1 | 2 Hr | 1 Hr | 2 Hr | 1 Hr |
| Copper | 4 in. | 36 in. | None | 2 | 2 Hr | 2 Hr | 2 Hr | 2 Hr |
| Steel | 4 – 8 in. | 36 in. | None | 1 | 2 Hr | 1 Hr | 2 Hr | 1 Hr |
| Steel | 4 – 8 in. | 36 in. | None | 2 | 2 Hr | 2 Hr | 2 Hr | 2 Hr |
| Cast Iron | 4 – 8 in. | 36 in. | None | 1 | 2 Hr | 1 Hr | 2 Hr | 1 Hr |
| Cast Iron | 4 – 8 in. | 36 in. | None | 2 | 2 Hr | 2 Hr | 2 Hr | 2 Hr |

Table 1. Through Penetration Firestop System Installation Details and Ratings

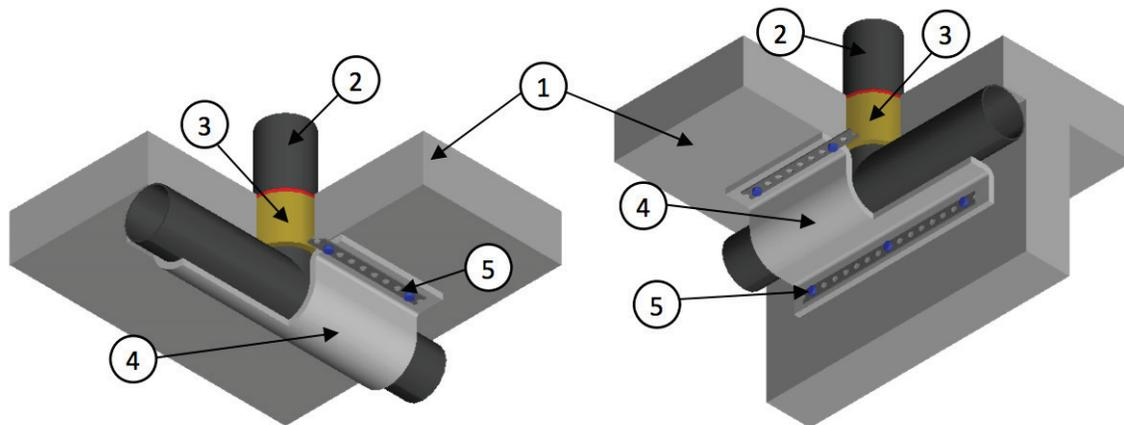

Figure 1. Through Penetration Firestop System

- SUPPORTING CONSTRUCTION:** Refer to Figure 1 and Table 1. Create a round opening in a Code conforming 1 or 2 hour fire-rated floor/ceiling or wall assembly. Use min 2-1/2 in. thick low density cast concrete or min 3.6 in thick low density cast concrete for the 1 hour and 2 hour fire-rated floor-ceiling assemblies respectively. Use min 3.2 in. thick or 4.6 in thick normal weight cast concrete for 1 hour and 2 hour fire-rated floor-ceiling assemblies respectively. Verify compliance of the supporting construction with its corresponding listed design.
- PENETRATING ITEM:** Refer to Figure 1 and Table 1. Install the penetrating item with either a T or elbow configuration ensuring that the section of penetrating item on the exposed side of the system is parallel and directly adjacent to the fire-rated floor/ceiling or wall assembly (Item 1).
- FIRESTOP SYSTEM:** Install an Intertek Certified 3M Fire Protection Product (firestop system) designed and listed to seal the specified penetrating item (Item 2) with an F rating matching the fire resistance of the supporting construction (Item 1). When a specific packing material is referenced in the listed design, as an alternative, use Intertek Certified, min. 4 pcf, mineral wool installed to the full thickness of the floor or wall and tightly packed (min 50% compression). Use an Intertek Certified, 3M sealant, caulk, putty or spray, listed for use with the specified penetrating item (Item 2), and applied as detailed in the corresponding listed design.

3MU/BI 120-05 (cont.)

4. CERTIFIED MANUFACTURER: 3M Company

CERTIFIED PRODUCT: Duct Wrap

CERTIFIED MODEL: Nominal 6 pcf, 3M™ Fire Barrier™ Duct Wrap 615 and nominal 6 pcf, 3M™ Fire Barrier™ Duct Wrap 615+. Install the nominal 1-1/2 in. thick, nominal 6 pcf duct wrap in a “U” shape around the penetrating item (Item 2) and attach to the supporting construction (Item 1) as described below, meeting the application layers and details described in Table 1. Cut edges are to be sealed with aluminum foil tape. Use additional duct wrap material to fill void spaces created between the penetrating item (Item 2), supporting construction (Item 1), and duct wrap. Fill these void spaces to a min. depth of 3 in. from the uninsulated end of the penetrating item (Item 2).

Single Layer: Wrap to be installed in a “U” shape around the penetrating item (Item 2). Ensure that a min. 3 in. flare is present to accommodate securing of the clamping plate (Item 5) on both sides of the penetrating item (Item 2) to the supporting construction (Item 1).

Double Layer: Wrap to be installed in a “U” shape around the penetrating item (Item 2). Wrap around the penetrating item (Item 2) such that a min. 3 in. flare is present to accommodate securing of clamping plate (Item 5) to floor-ceiling and/or wall assembly (Item 1).

5. CLAMPING PLATE: Install min. 1-1/2 in. by 3/16 in. thick steel plate with pre-drilled nominal 1/4 in. diameter holes. Secure the clamping plate with min. 1/4 in. by 2-3/4 in. long steel masonry anchors or Tapcon Fasteners and 1-1/4 in. washers ensuring the fastener passes through the 3M Fire Barrier Duct Wrap 615, 3M Fire Barrier Duct Wrap 615+ (Item 4) at min. 8 in. on center to clamp the wrap material against the supporting construction (Item 1).

Through Penetration

Concrete

BI

This material was extracted and drawn by 3M Fire Protection Products from the 2018 Product Directory, © Intertek



Vertical Assemblies (Wall)

| 3M Systems | "F" Rating | 3M Product | Application Details |
|---------------|------------|--|--|
| 3M/PV 60-01 | 1 | 3M™ Fire Barrier Sealant IC 15WB+ | Max. 2" diameter PVC, ABS, or ccABS fitting through 1 hour rated wall board assembly (on side) |
| 3M/PV 60-02 | 1 | 3M™ Fire Barrier Sealant IC 15WB+ | Max. 2" XFR, PVC, ABS, ccABS, CPVC or Max 1" PEX or Kitec through 1 hour rated wall board assembly |
| 3M/PV 120-01 | 1, 2 | 3M™ Fire Barrier Ultra Plastic Pipe Device 3M™ Fire Barrier Ultra RC Pack 3M™ Fire Barrier Sealant CP-25WB+ 3M™ Fire Barrier Sealant IC 15WB+ 3M™ Fire Barrier Sealant FD 150+ | Max 4" PVC, XFR, FRPP, ABS, ccABS, or Max. 2" PVC – Thin Wall through 1 or 2 hour rated wall board assembly |
| 3M/PV 120-02 | 1, 2 | 3M™ FireStrap™ 3M™ Fireplug™ 3M™ Fire Barrier Sealant CP-25WB+ 3M™ Fire Barrier Sealant IC 15WB+ 3M™ Fire Barrier Sealant FD 150+ | Max. 3" diameter PVC, ABS, ccABS or Max. 2" PVC – Thin wall, XFR through 1 or 2 hour rated wall board assembly or min. 4-1/2" concrete wall or 8" block wall |
| 3M/PV 120-03 | 1, 2 | 3M™ Fire Barrier Wrap Ultra GS 3M™ Fire Barrier RC-1 Restricting Collar 3M™ Fire Barrier Sealant CP-25WB+ 3M™ Fire Barrier Sealant FD 150+ | Max 4" PVC, XFR fitting through 1 or 2 hour rated wall board assembly (one side) |
| 3M/PV 120-04 | 1 | 3M™ Fire Barrier Ultra Plastic Pipe Device 3M™ Fire Barrier Sealant CP-25WB+ 3M™ Fire Barrier Sealant IC 15WB+ 3M™ Fire Barrier Sealant FD 150+ | Max. 6" PVC, XFR through 2 hour rated wall board assembly |
| 3M/PV 120-05 | 1, 2 | 3M™ FireStrap™ 3M™ Fire Barrier Sealant CP-25WB+ 3M™ Fire Barrier Sealant IC 15WB+ 3M™ Fire Barrier Sealant FD 150+ | Max. 3" ccABS, ABS, Max. 2" PVC, PVC – Thin wall through 1 or 2 hour rated wall board assembly |
| 3M/PV 120-06 | 1, 2 | 3M™ FireStrap™ 3M™ Fire Barrier Sealant CP-25WB+ 3M™ Fire Barrier Sealant IC 15WB+ 3M™ Fire Barrier Sealant FD 150+ | Max. 2" PVC, XFR through 1 or 2 hour rated wall board assembly |
| 3M/PV 120-07 | 2 | 3M™ Fire Barrier Wrap Ultra GS 3M™ Fire Barrier Sealant FD 150+ | Max. 4" PVC through 2 hour rated wall board assembly at an angle not greater than 45 degrees from perpendicular. |
| 3M/PV 120-08 | 2 | 3M™ Fire Barrier Water Tight Sealant 1000 NS 3M™ Fire Barrier Sealant IC 15WB+ | Max. 8" Steel, Cast, Max. 6" EMT, Copper pipe, Max. 4" CPVC, PVC (processand supply only) 1/2" BX, 1-3/16 Kitec, 4" Electrical Cable bundle through 1 or 2 hour rated wall board assembly |
| 3MU/PH 120-04 | 3 | 3M™ Fire Barrier 2000+ Silicone Joint Sealant | Schedule 10 or heavier maximum 6 in. diameter (or smaller) steel pipe insulated with 1 in. thick fiberglass insulation with all service jacketing penetrating through a concrete wall assembly. |
| 3MU/PH 120-06 | 2 | 3M™ Fire Barrier Silicone Sealant 2000+ | 2 hour gypsum wall. Max. 24" sch 10 steel pipe, max. 5" EMT or conduit, max. 6" copper pipe. Min. 1-1/4" depth of fill material. Also referred to as FS117W. |
| 3MU/PH 120-07 | 2 | 3M™ Fire Barrier Silicone Sealant 2000+ | 2 hour gypsum wall. Max. 24" sch 10 steel pipe, max. 5" EMT or conduit, max. 6" copper pipe. Max. 1" thick glass fiber insulation. Min. 1-1/4" depth of fill material. Also referred to as FS119W |
| 3MU/PH 120-08 | 2 | 3M™ Fire Barrier Silicone Sealant 2000+ | 2 hour concrete wall. Max. 24" sch 10 steel pipe, max. 5" EMT or conduit, max. 6" copper pipe. Max. 1" thick glass fiber insulation. Min. 1/2" depth of fill material. Also referred to as FS540W. |
| 3MU/PH 120-10 | 2 | 3M™ Fire Barrier Silicone Sealant 2000+ | 2 hour gypsum wall. Max. 24" sch 10 steel pipe, max. 5" EMT or conduit, max. 6" copper pipe. Min. 5/8" depth of fill material. Also referred to as FS118W. |
| 3MU/PH 120-20 | 2 | 3M™ Fire Barrier 2000+ Silicone Joint Sealant | Max 10 in. steel, 6 in. conduit or 6 in. copper pipe penetrating a gypsum wallboard assembly. 3/4 in. annular space required. |
| 3MU/PH 180-01 | 3 | 3M™ Fire Barrier Silicone Sealant 2000+ | 3 hour concrete wall. Max. 24" sch 10 steel pipe, max. 5" EMT or conduit, max. 6" copper pipe. Min. 1/2" depth of fill material. Also referred to as FS538W. |
| 3MU/PH 180-03 | 3 | 3M™ Fire Barrier Silicone Sealant 2000+ | 3 hour concrete wall. Max. 24" sch 10 steel pipe, max. 5" EMT or conduit, max. 6" copper pipe. Min. 1/4" depth of fill material. Also referred to as FS539W. |

3M CANADA CO. – London, On Canada

DESIGN NO. 3M/PV 60-01

October 14, 2005
 VERTICAL (WALL)
 RATINGS – See Table

ANNULAR SPACE and OPENING DIAMETER – See Table Item 3
 TEST PRESSURE DIFFERENTIAL – 50 Pa (0.20 in. of water)

| Penetrant Pipe/Coupling | Maximum Pipe/Coupling ID | ULC-S115-95 CAN4-S115-M F, FH, FT, FTH |
|-------------------------|--------------------------|--|
| PVC | 2" | 1 HR |
| ccABS | 2" | 1 HR |
| ABS | 2" | 1 HR |

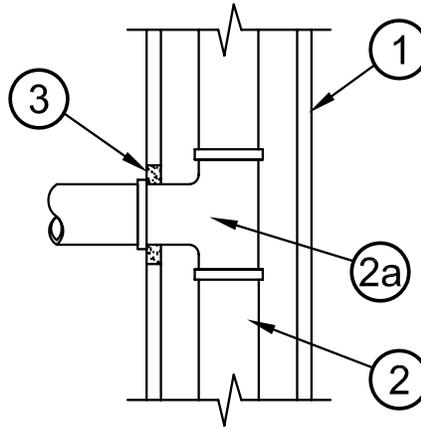

- Wall Assembly:** Code conforming 1 hour fire-rated wall, metal or wood framed gypsum wallboard wall assembly. Ratings achieved will equal that of wall assembly.
- Penetrant:** (See also table of ratings) Penetrant to be located on one side of the wall assembly only. Schedule 40, ABS, ccABS and PVC pipe used in DWV (Drain, Waste or Vent) or Closed (Process and Supply) piping systems.
- Coupling:** Fitting, Coupling, T or Hub, Maximum 2" ID diameter, Schedule 40, PVC, ABS and ccABS.

Firestop System Components:

- Sealant:** *3M™ Fire Barrier IC 15WB+ sealant, apply a 5/8" thickness, around the penetrant, flush with the wall surface. At point contact apply a 5/8" thick bead of sealant at the coupling / gypsum wallboard interface.

| Pipe/Coupling ID | Opening Diameter | Annular Space |
|------------------|------------------|---------------|
| 1-1/2" | 3" | 0" - 3/4" |
| 2" | 3-1/2" | 0" - 3/4" |

Note: metric conversion factor, inches x 25.4 = mm

*Component bearing the Warnock Hersey Certification Mark

This material was extracted and drawn by 3M Fire Protection Products from the 2006 Warnock Hersey Directory of Listed Products

Through Penetrations
Vertical
1 Hour
Warnock Hersey Designs
PV

3M CANADA CO. – London, On Canada

DESIGN NO. 3M/PV 60-02

October 02, 2006

VERTICAL (WALL)

RATINGS – See Below

OPENING DIAMETER – See Tables

TEST PRESSURE DIFFERENTIAL – 50 Pa (0.20 in. of water)

| Penetrant | Maximum Pipe ID | Maximum Opening Diameter | Annular Space | ULC-S115-95 CAN4-S115-M | |
|------------------|-----------------|--------------------------|---------------|----------------------------|---------|
| | | | | F, FH | FT, FTH |
| XFR | 2" | 3" | 0" - 1" | 1 Hr | 1 Hr |
| PVC | 2" | 3" | 1/4" - 3/4" | 1 Hr | 1 Hr |
| CPVC | 2" | 3" | 1/4" - 3/4" | 1 Hr | 1 Hr |
| ABS | 2" | 3" | 1/4" - 3/4" | 1 Hr | 1 Hr |
| ccABS | 2" | 3" | 1/4" - 3/4" | 1 Hr | 1 Hr |
| PEX | 1" | 2" | 1/4" - 3/4" | 1 Hr | 1/4 Hr |
| Kitec (PE-AL-PE) | 1" | 2" | 1/4" - 3/4" | 1 Hr | 1/4 Hr |

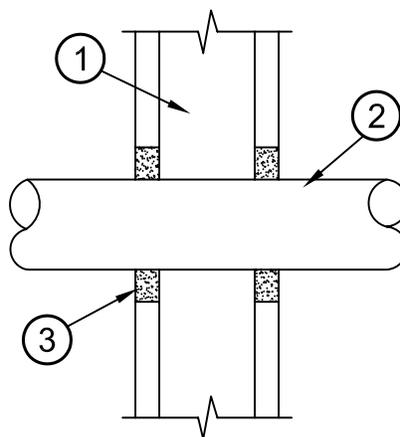

- Wall Assembly:** Code conforming 1 hour fire-rated wall, metal or wood framed gypsum wallboard wall assembly. Ratings achieved will equal that of wall assembly.
- Penetrant:** (See also table of ratings) Schedule 40, CPVC, PVC, ABS and ccABS pipe used in DWV (Drain, Waste or Vent) or Closed (Process and Supply) piping systems. PEX and Kitec (PE-AL-PE) piping used in Closed (Process and Supply) piping systems.

Firestop System Components:

- Sealant:** *3M™ Fire Barrier IC 15 WB+ sealant, apply 5/8" thickness within the annular space, around the penetrant on both sides of the assembly. At point contact a 5/8" thick bead is applied at the wall / penetrant interface.

| Pipe ID | Opening Diameter | Annular Space |
|---------|------------------|---------------|
| 1" | 2" | 1/4" - 3/4" |
| 1-1/2" | 2-1/2" | 1/4" - 3/4" |
| 2" | 3" | 1/4" - 3/4" |

For XFR only

| Pipe ID | Opening Diameter | Annular Space |
|---------|------------------|---------------|
| 1-1/2" | 2-1/2" | 0" - 1" |
| 2" | 3" | 0" - 1" |

Note: Metric conversion factor, inches x 25.4 = mm.

*Component bearing the Warnock Hersey Mark.

This material was extracted and drawn by 3M Fire Protection Products from the 2006 Warnock Hersey Directory of Listed Products

3M CANADA CO. – London, On Canada

DESIGN NO. 3M/PV 120-01

October 02, 2006

VERTICAL (WALL), RATINGS – SEE BELOW, ANNULAR SPACING - 1/4" MAXIMUM
TEST PRESSURE DIFFERENTIAL – 50 Pa (0.20" OF WATER)

| Penetrant | Pipe Size | CAN/ULC-S115 CAN/4-S115 F, FH, FT, FTH | ASTM-E814 F, T |
|-----------------|-------------|--|------------------------|
| PVC | 1-1/2" - 4" | 1 & 2 Hr | 1 & 2 Hr |
| System XFR | 1-1/2" - 4" | 1 & 2 Hr | 1 & 2 Hr |
| CPVC | 1-1/2" - 4" | 1 & 2 Hr | 1 & 2 Hr |
| ccABS | 1-1/2" - 4" | 1 & 2 Hr | 1 & 2 Hr |
| ABS | 1-1/2" - 4" | 1 & 2 Hr | 1 & 2 Hr |
| FRPP | 1-1/2" - 4" | 1 & 2 Hr | 1 & 2 Hr |
| PVC - Thin Wall | 2" | 1 & 2 Hr | 1 & 2 Hr |
| PVDF | 1-1/2" - 4" | F: 1 & 2 Hr T: 0 Hr | F: 1 & 2 Hr T: 0 Hr |

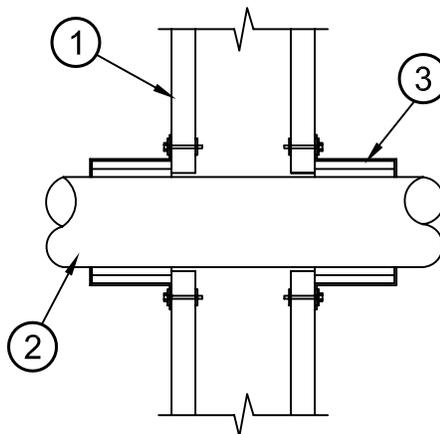

- Wall Assembly:** Code conforming 1 or 2 hour fire-rated wall, metal or wood framed gypsum wallboard, wall assembly.
- Penetrant:** (See table of ratings) Nominal 4" diameter, Schedule 40, ccABS, ABS, PVC, System XFR, CPVC, FRPP, PVDF pipes for use in DWV (Drain, Waste and Vent) or Closed (Process and Supply) piping systems and PVC-Thin Wall Vacuum tubing (nominal 2" diameter), ratings achieved will equal that of the wall assembly.
- Firestop System Components:**
 - *3M™ Interam™ Ultra PPD or *3M™ Fire Barrier Ultra RC Pack, sized appropriately for pipe, secure to wall surface with *3M™ Ultrafast™ Anchors or 3/16" diameter steel toggle bolts (5/8" or 1-1/4" grip) in conjunction with minimum 1-1/2" diameter steel washers.
Use *3M™ Interam™ Ultra PPD-1.5 for 2" PVC-Thin Wall Vacuum Tubing.

3M™ Interam™ Ultra PPD Size Chart

| Device | Nominal Pipe ID | Max. Hole Size |
|---------|-----------------|----------------|
| PPD-1.5 | 1-1/2" | 2-1/2" |
| PPD-2 | 2" | 3" |
| PPD-3 | 3" | 4" |
| PPD-4 | 4" | 5" |

3M™ Fire Barrier Ultra RC Pack Size Chart

| Device | Nominal Pipe ID | Max. Hole Size |
|-----------|-----------------|----------------|
| RC Pack 2 | 2" | 3" |
| RC Pack 3 | 3" | 4" |
| RC Pack 4 | 4" | 5" |

- **Caulk (Optional) – *3M™ Fire Barrier CP-25WB+ Caulk, *3M™ Fire Barrier IC 15WB+ Sealant or *3M™ FireDam 150+ Caulk, to fill the annular space at the pipe penetration as a smoke seal.

CPVC Pipe – use only *3M™ Fire Barrier IC 15WB+ Sealant

Note: Metric conversion factor, inches x 25.4 = mm.

*Components bearing the Warnock Hersey Certification Mark.

**May be used, however, is not required to achieve stated ratings.

This material was extracted and drawn by 3M Fire Protection Products from the 2006 Warnock Hersey Directory of Listed Products

3M CANADA CO. – London, On Canada

DESIGN NO. 3M/PV 120-02

October 02, 2006

VERTICAL (WALL)

RATINGS – See Below

OPENING DIAMETER– See Item 3

TEST PRESSURE DIFFERENTIAL – 50 Pa (0.20 in. of water)

| Penetrant | Maximum Pipe ID | ULC-S115-95 CAN4-S115-M F, FH, FT, FTH |
|-------------------|-----------------|--|
| PVC | 3" | 1 & 2 Hr |
| ccABS | 3" | 1 & 2 Hr |
| ABS | 3" | 1 & 2 Hr |
| PVC - Thin Wall** | 2" | 1 & 2 Hr |
| XFR | 2" | 1 & 2 Hr |

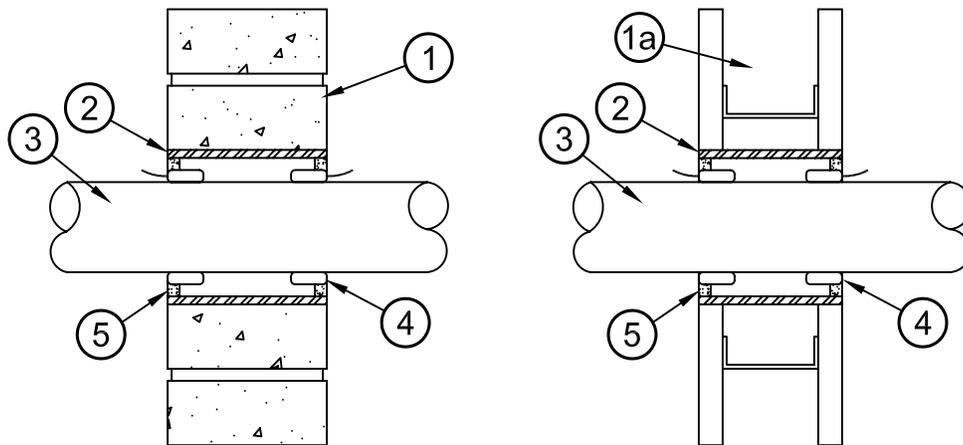

1. **Wall Assembly:** Code conforming 2 HR fire-rated wall assembly, nominal 4-1/2" thickness, normal or low density cast concrete. Wall may also be constructed of nominal 8" thick concrete blocks (filled or unfilled). Ratings achieved will equal that of wall assembly.
- 1A **Wall Assembly:** Code conforming 1 or 2 HR fire-rated wall, metal or wood framed gypsum wallboard wall assembly. Ratings achieved will equal that of wall assembly.
2. **Steel Sleeve:** Minimum 28 gauge galvanized steel, positioned within the opening with a 1" overlap, maximum 4-1/2" diameter, sleeve may be flush with wall surface, or extended up to 1/2" beyond either surface of wall. Sleeve is cast or grouted into masonry walls.
3. **Penetrant:** (See also table of ratings) Schedule 40, ccABS, ABS, PVC and XFR pipes used in DWV (Drain, Waste and Vent) or Closed (Process and Supply) pipe systems and PVC -Thin Wall Vacuum Tubing (nominal 2" Diameter), ratings achieved will equal that of the wall assembly.

Firestop System Components:

4. * 3M™ FireStrap™ or 3M™ FirePlug™ - Install with 1/4" of the firestop exposed outside the surface of the wall assembly within the steel sleeve, according to the manufacturers instructions.
** Use *3M™ FireStrap™ 1-1/2" for PVC -Thin Wall Vacuum Tubing (nominal 2" Diameter)

| Pipe ID | Opening Diameter |
|---------|------------------|
| 1-1/2" | 3" |
| 2" | 3-1/4" |
| 3" | 4-1/2" |

5. **Sealant** - * 3M™ Fire Barrier CP-25WB+ Caulk, *3M™ Fire Barrier IC 15WB+ Sealant or *3M™ FireDam™ 150+ Caulk, apply to seal the space between the device and the steel sleeve and between the steel sleeve and the substrate. Firestop system is applied to both sides of the wall.

Note: Metric conversion factor, inches x 25.4 = mm.

*Component bearing the Warnock Hersey Mark.

This material was extracted and drawn by 3M Fire Protection Products from the 2006 Warnock Hersey Directory of Listed Products

3M CANADA CO. – London, On Canada

DESIGN NO. 3M/PV 120-03

October 02, 2006

VERTICAL (WALL)

RATINGS – See Below

ANNULAR SPACE – 1/4" maximum

TEST PRESSURE DIFFERENTIAL – 50 Pa (0.20 in. of water)

| Fitting (Sch. 40) | Maximum Diameter (ID) | ULC-S115-95 CAN4-S115-M F, FH, FT, FTH |
|-------------------|-----------------------|--|
| PVC | 4" | 1 & 2 Hr |
| System XFR | 4" | 1 & 2 Hr |

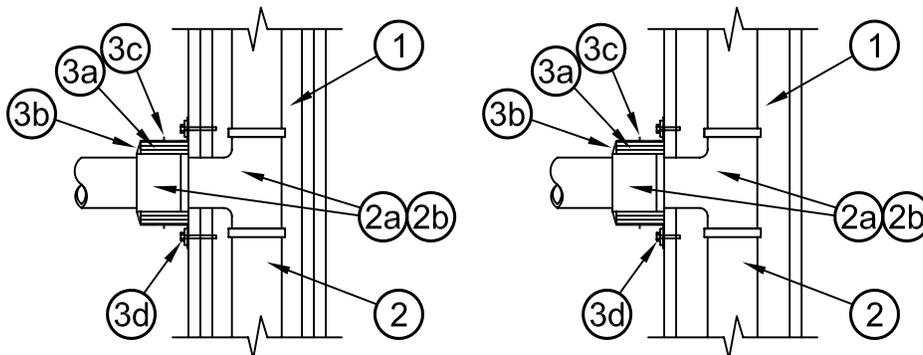

- Wall Assembly:** Code conforming 1 or 2 HR rated wall, metal or wood framed gypsum wallboard wall assembly. Penetrant to be located on one side of the wall assembly only. Ratings achieved will equal that of wall assembly.
- Penetrant:** (See also table of ratings) Maximum 4" ID, Sch. 40, System XFR or PVC Pipe.
 - Maximum 4" diameter, Sch. 40, System XFR, Fitting
 - Maximum 4" diameter, Sch. 40, PVC, Fitting
- Firestop System Components:**
 - * 3M™ Interam™ Ultra GS Wrap Strip, continuous wrap applied tightly to the fitting. Apply the appropriate number of layers as detailed in the table below.
Alternate wrap material: *3M™ Fire Barrier FS-95+ Wrap Strip, applied tightly to the fitting, with butted seams and staggered joints. Apply the appropriate number of layers as detailed in the table below.
 - * 3M™ Fire Barrier RC-1 Collar, anchor tabs bent out at 90°, steel collar wrapped tightly over wrap material (Item 3a) with 1" overlap, secure collar with stainless steel 1/2" Hose Clamp (Item 3c). Secure collar to wall assembly through anchor tabs with 3/16" diameter steel toggle bolts with 1-1/4" diameter washers (Item 3d).

| Fitting | Wrap Layers | Anchors |
|---------|-------------|---------|
| 1-1/2" | 3 | 2 |
| 2" | 3 | 2 |
| 3" | 4 | 4 |
| 4" | 4 | 4 |

** Caulk (Optional) - * 3M™ Fire Barrier CP-25WB+ Caulk or * 3M™ FireDam 150+ Caulk, to fill the annular space at the pipe penetration as a smoke seal.

Note: metric conversion factor, inches x 25.4 = mm

*Component bearing the Warnock Hersey Certification Mark

** May be used, however, is not required to achieve stated ratings

This material was extracted and drawn by 3M Fire Protection Products from the 2006 Warnock Hersey Directory of Listed Products

Through Penetrations

Vertical

1, 2 Hour

Warnock Hersey Designs

PV

3M CANADA CO. – London, On Canada

DESIGN NO. 3M/PV 120-04

October 02, 2006

HORIZONTAL (FLOOR)

RATINGS – See Below

ANNULAR SPACE – 1/4"

TEST PRESSURE DIFFERENTIAL – 50 Pa (0.20 in. of water)

| Penetrant | Pipe ID | ULC-S115-95 CAN4-S115-M | | | |
|------------|---------|----------------------------|----------|----------|----------|
| | | F | FH | FT | FTH |
| PVC | 6" | 1-3/4 Hr | 1-3/4 Hr | 1-3/4 Hr | 1-3/4 Hr |
| System XFR | 6" | 1-3/4 Hr | 1-3/4 Hr | 1-3/4 Hr | 1-3/4 Hr |

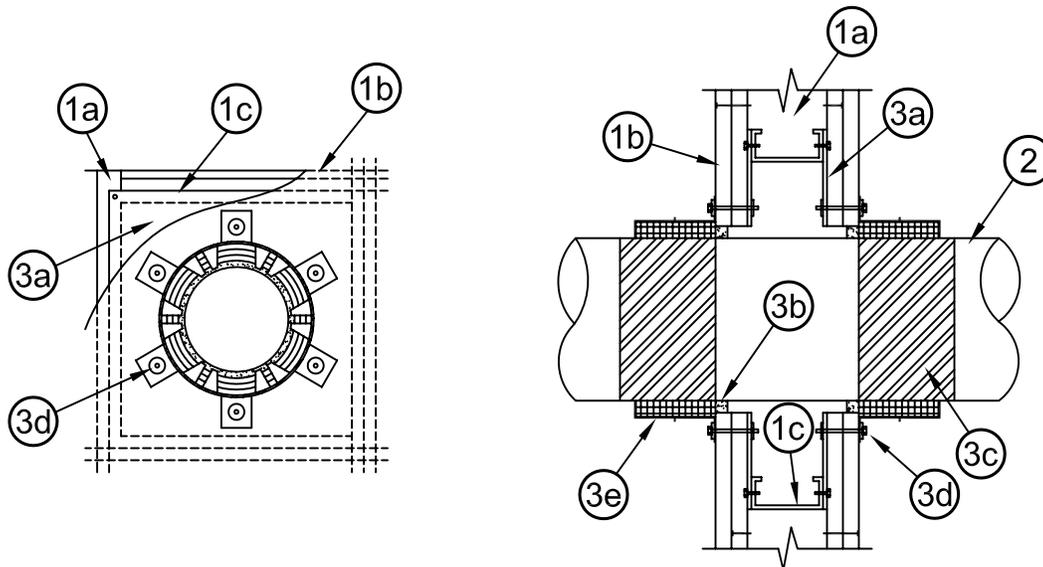

- Wall Assembly:** Code conforming 2 HR fire-rated wall, metal or wood stud (Item 1a) framed gypsum wallboard (Item 1b), wall assembly. Opening is to be framed to create a nominal 16" square compar™ ent with metal or wood studs (Item 1c). Maximum 7" diameter opening.
- Penetrant:** (See also table of ratings) Nominal 6" diameter, Sch. 40, PVC and System XFR pipes used for DWV or Closed (Process and Supply) applications.
- Firestop System Components:**
 - Galvanized Steel Backing:** Minimum 28 gauge galvanized steel sheet, secured to studs and framed compar™ ent with self tapping screws. Sheet may be comprised of 2 sections, with a 7" diameter opening for the pipe (Item 2) forming an overlap or butt seam. A 2" wide cover strip is applied over butted seams and secured with self tapping screws according to the manufacturers instructions.
 - Sealant:** * 3M™ Fire Barrier CP-25WB+ Caulk, *3M™ Fire Barrier IC 15WB+ sealant, or *3M™ FireDam 150+ Caulk, applied within the annular space around the pipe, to a 1/4" thickness flush with the wall surface on both sides.
 - Aluminum Foil Tape:** Pipe is to be covered with aluminum foil tape from the wall interface for a 4" length.
 - * 3M™ Interam™ Ultra PPD-6 wrapped tightly around the pipe, latched and secured with the steel hose clamp, provided. The mounting tabs are fastened with 1/4" diameter hollow dry wall anchors or toggle bolts in conjunction with 1- 1/4" diameter steel fender washers (Item 3d).

Note: Metric conversion factor, inches x 25.4 = mm.

*Component bearing the Warnock Hersey Mark.

This material was extracted and drawn by 3M Fire Protection Products from the 2006 Warnock Hersey Directory of Listed Products

3M CANADA CO. – London, On Canada

DESIGN NO. 3M/PV 120-05

October 02, 2006

VERTICAL (WALL), RATINGS – SEE BELOW, HOLE SIZE – SEE ITEM 3
 TEST PRESSURE DIFFERENTIAL – 50 Pa (0.20" OF WATER)

| Penetrant | Max. Pipe ID | CAN/ULC-S115 F, FH, FT, FTH |
|-----------------|--------------|--------------------------------|
| PVC | 2" | 1 & 2 Hr |
| ccABS | 3" | 1 & 2 Hr |
| ABS | 3" | 1 & 2 Hr |
| PVC - Thin Wall | 2" | 1 & 2 Hr |

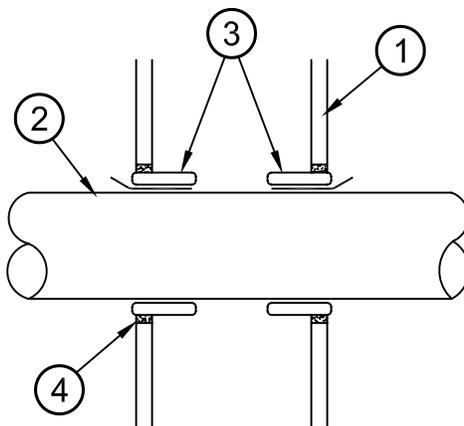

- Wall Assembly:** Code conforming 1 or 2 hour fire-rated wall, nominal 2" x 4" steel/wood framed gypsum wallboard, wall assembly.
- Penetrant:** (See table of ratings) Schedule 40, ccABS, ABS, PVC pipes for use in DWV (Drain, Waste and Vent) or Closed (Process and Supply) piping systems and PVC-Thin Wall Vacuum Tubing (nominal 2" diameter), ratings achieved will equal that of the wall assembly.
- Firestop System Components:** *3M™ FireStrap™ : Install with 1/4" of the firestop exposed outside the surface of the gypsum wall assembly according to the manufacturers instructions.
 Use *3M™ FireStrap™ 1-1/2" for PVC - Thin Wall Vacuum Tubing (nominal 2" diameter).

| Pipe ID | Hole Size |
|---------|-----------|
| 1-1/2" | 2-1/2" |
| 2" | 3" |
| 3" | 4-1/2" |

- Sealant:** *3M™ Fire Barrier CP-25WB+ Caulk, *3M™ Fire Barrier IC 15WB+ Sealant or *3M™ FireDam 150+ Caulk, applied within the annular space between the device (Item 3) and the opening to provide a smoke seal. Firestop system is applied to both sides of the wall.

Note: Metric conversion factor, inches x 25.4 = mm.

*Component bearing the Warnock Hersey Mark.

This material was extracted and drawn by 3M Fire Protection Products from the 2006 Warnock Hersey Directory of Listed Products

Through Penetrations

Vertical

1, 2 Hour

Warnock Hersey Designs

PV

3M CANADA CO. – London, On Canada

DESIGN NO. 3M/PV 120-06

October 02, 2006

VERTICAL (WALL); RATINGS: SEE BELOW; OPENING DIAMETER – SEE ITEM 3
TEST PRESSURE DIFFERENTIAL – 50 Pa (0.20" OF WATER)

| Penetrant | Max. Pipe ID | CAN/ULC-S115 F, FH, FT, FTH |
|------------|--------------|--------------------------------|
| PVC | 2" | 1 & 2 Hr |
| System XFR | 2" | 1 & 2 Hr |

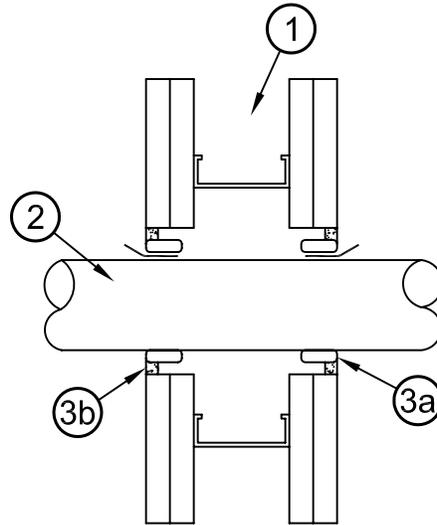

- Wall Assembly:** Code conforming 1 or 2 Hour fire-rated wall, nominal 2" x 4" steel or wood framed gypsum wallboard wall assembly.
- Penetrant:** (See also table of ratings) Schedule 40, PVC and System XFR pipes for use in DWV (Drain, Waste and Vent) or Closed (Process and Supply) piping systems, ratings achieved will equal that of the wall assembly.
- Firestop System Components:**

| Pipe ID | Opening Diameter |
|---------|------------------|
| 1-1/2" | 3" |
| 2" | 3" |

- * 3M™ FireStrap™ or *3M™ FirePlug™: Install with 1/4" of the firestop exposed outside the surface of the gypsum wall assembly according to the manufacturers instructions.
- Sealant: *3M™ Fire Barrier CP-25WB+ Caulk, *3M™ Fire Barrier IC 15WB+ Sealant or *3M™ FireDam 150+ Caulk, seal the annular space between the opening and the firestop device, to 1/4" thickness, flush with the wall surface on both sides of the wall.

Note: Metric conversion factor, inches x 25.4 = mm.

*Component bearing the Warnock Hersey Mark.

This material was extracted and drawn by 3M Fire Protection Products from the 2006 Warnock Hersey Directory of Listed Products

3M CANADA CO. – London, On Canada

DESIGN NO. 3M/PV 120-07

October 02, 2006

VERTICAL (WALL), RATINGS – SEE BELOW, ANNULAR SPACING – 1/4" MAXIMUM
TEST PRESSURE DIFFERENTIAL – 50 Pa (0.20" OF WATER)

| Penetrant | Pipe Size | CAN/ULC-S115 F, FH, FT, FTH | ASTM-E814 F, T |
|-----------|-----------|--------------------------------|-------------------|
| PVC | 4" | 2 Hour | 2 Hour |

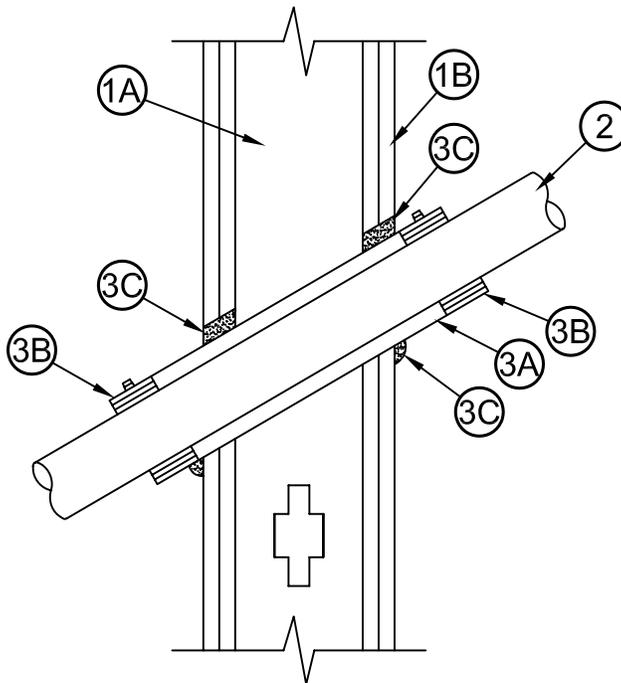

1. **Wall Assembly:** Code conforming 2 hour fire-rated wall, metal or wood framed gypsum wallboard, wall assembly.
 - a) Studs – Wall framing may consist of either wood studs or steel channel studs. Wood studs to consist of nominal 2x4 lumber, spaced 16 in. on centre. Steel studs to be minimum 3-1/2 in. wide and spaced maximum 24 in. on centre.
 - b) Gypsum Wallboard – Thickness, type, number of layers, and fasteners as required in the individual Wall and Partition Design. Diameter of opening is maximum 1/2 in. larger than the outside diameter of metallic sleeve.
2. **Penetrant:** (See table of ratings) Nominal 4" diameter, PVC pipes centred within the firestop system. Pipe to be rigidly supported on both sides of wall assembly. The pipe may be installed at an angle not greater than 45 degrees from perpendicular. Ratings achieved will equal that of the wall assembly.
3. **Firestop System Components:**
 - a) **Metallic Sleeve** – cylindrical sleeve fabricated from minimum 0.019 in. thick (26 gauge) galvanized sheet steel, having a minimum 1 in. lap along the longitudinal seam. Sleeve to extend a minimum of 2 in. beyond both sides of the wall. The inside diameter of the sleeve shall be larger than outside diameter of non-metallic pipe or conduit such that an annular space will be present between the steel sleeve and the pipe around the entire circumference of the pipe to accommodate the layer(s) of wrap strips (Item 3b). The annular space between the outside of the wrap strip layer(s) and the inside of the sleeve shall be minimum 0 in. to maximum 1/4 in. The annular space between the outside of the sleeve and the periphery of the opening shall be minimum 0 in. to maximum 1/2 in.
 - b) **3M™ Interam™ Ultra GS Wrap Strip*** – Nominal 1/2 in. thick intumescent elastomeric material faced on one side with aluminum foil, supplied in 2 in. wide strips. Nominal 2 in. wide strips tightly wrapped around non-metallic pipe (foil side exposed) and slid into sleeve on both sides of wall such that the outer edges of wrap strips are flush with the outer edges of the sleeve. For nominal 4 in. diameter pipes, a minimum of three layers of wrap strip is required. Each layer of wrap strip to be installed with butted seams in successive layers staggered. Wrap strip layers held in position using aluminum foil tape, steel wire tie, or equivalent. A minimum 1/2 in. wide stainless steel hose clamp shall be secured around the outside of the sleeve over the centre of the wrap strips on both ends of the sleeve.
 - c) **3M™ FireDam 150+ Caulk*** – Minimum thickness of 1-1/4 in., applied within annulus between metallic sleeve and periphery of the opening, flush with both surfaces of the wall assembly. At the point contact location between sleeve and gypsum wallboard, a minimum 1/2 in. diameter bead of caulk shall be applied at the sleeve/wallboard interface on both surfaces of the wall assembly. A minimum 1/4 in. bead of caulk shall also be applied over the outer edges of the wrap strips and within the annular space between the wrap strip and sleeve on both sides of the wall.

Note: Metric conversion factor, inches x 25.4 = mm.

*Component bearing the Warnock Hersey Certification Mark.

This material was extracted and drawn by 3M Fire Protection Products from the 2006 Warnock Hersey Directory of Listed Products

3M CANADA CO – London, ON Canada

DESIGN NO. 3M/PV 120-08

October 02, 2006

VERTICAL (WALL)

RATINGS – SEE TABLE BELOW

TEST PRESSURE DIFFERENTIAL – 2.5 PA (0.01" OF WATER) MINIMUM

| Penetrating Items | Maximum Pipe Size (mm)* | Maximum Hole Size (mm)* | Min.-Max. Annular Spacing (mm)* | Ratings | | | |
|-------------------|-------------------------|-------------------------|---------------------------------|--------------|--------|-----------|--------|
| | | | | CAN/ULC-S115 | | ASTM-E814 | |
| | | | | F, FH | FTH | F | FT |
| Conduit | 100 | 150 | 6-38 | 2 Hr | 15 Min | 2 Hr | 15 Min |
| Copper | 100 | 150 | 6-45 | 2 Hr | 15 Min | 2 Hr | 15 Min |
| CPVC** | 50 | 100 | 6-32 | 2 Hr | 2 Hr | 2 Hr | 2 Hr |
| PVC** | 50 | 100 | 3-6 | 2 Hr | 2 Hr | 2 Hr | 2 Hr |
| Steel/Cast | 200 | 255 | 0-38 | 2 Hr | 15 Min | 2 Hr | 15 Min |
| BX | 12.5 | 25 | 6-19 | 2 Hr | 0 | 2 Hr | 0 |
| Elec. XXX | 45% Fill | 100 | 0-64 | 2 Hr | 30 Min | 2 Hr | 30 Min |
| Kitec | 1-3/16" | 2" | 1/2" - 3/4" | 2 Hr | 2 Hr | 2 Hr | 2 Hr |

* - To convert mm to inches, divide by 25.4

** - Process and supply only in Canada

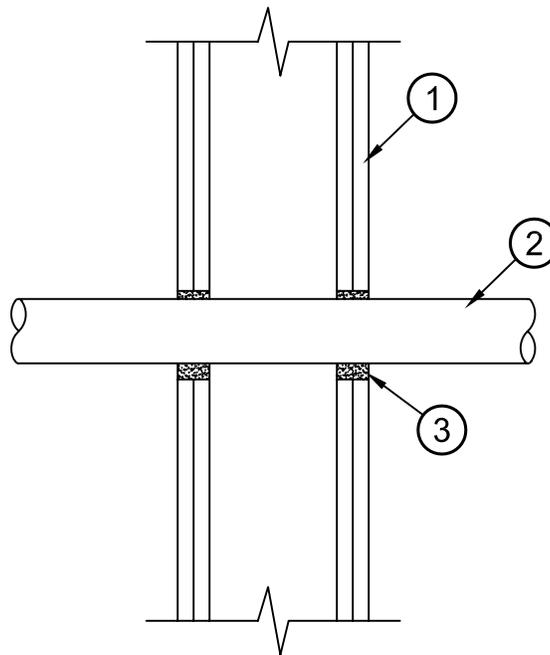

- Wall Assembly** – 1 hour or 2 hour rated wood or steel stud framed gypsum wall assembly. Minimum wall thickness: 115mm (4-1/2") for 1 hour rated walls, 140mm (5-1/2") for 2 hour rated walls. The hourly F rating of the firestop system is equal to the hourly fire rating of the wall assembly in which it is installed.
- Penetrating Items** – Metallic and non-metallic pipe and conduit as described in the table of ratings.
- Firestop Sealant** – 3M™ Fire Barrier 1000 Silicone Sealant No Sag or 3M™ Fire Barrier IC 15 WB+ applied to the full depth of the gypsum wallboard membrane on both sides of the wall. For point contact penetrations, a 12.5mm (1/2") surface bead is required at point of contact location. For Kitec use only 3M™ Fire Barrier IC 15 WB+ applied the full depth of the gypsum wallboard membrane on both sides of the wall.

This material was extracted and drawn by 3M Fire Protection Products from the 2006 Warnock Hersey Directory of Listed Products



Design Number 3MU/PH 120-06

August 1, 2003
3M Company
Formerly Design No. FS 117 W
FIRE PENETRATION SEAL (Mechanical)
Penetrating Item Type A
T-Rating - 0 hr
F-Rating - 2 hr

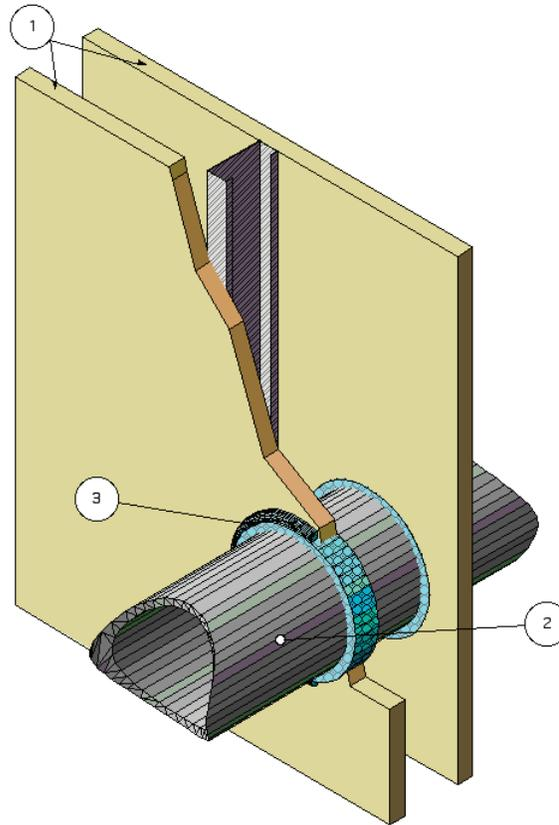

1. **GYPSUM WALL ASSEMBLY:** The framed opening in the wall shall be 4 in. to 6 in. wider and higher than the diameter of the penetrating item such that, when the penetrating item is centered in the opening, a 2 in. to 3 in. clearance is present between the penetrating item and the framing on all four sides. Two-hour fire-rated wall assembly shall include one of the following features:
 - A. Max. diameter of opening in gypsum wallboard layers is to be 25-1/2 in. for steel stud wall assemblies. When steel studs are used and the diameter of the opening exceeds the width of the stud cavity, the opening shall be framed on all sides using lengths of steel stud installed between the vertical studs and screw-attached to the steel studs at each end. Min. 25 GA galvanized steel studs spaced 24 in. o.c. measuring 3-5/8 in. wide with 1-1/4-in. legs. Studs attached with min. #6 × 3/8-in. long steel stud framing screws to channel shaped floor and ceiling runners, measuring 1/2-in. deep by 3-5/8-in wide, which are secured to floor and ceiling with 1-in. concrete fasteners spaced max. 18-in. o.c. Studs and runners covered with two layers of 5/8 in. thick, Type X gypsum wallboard on each face. The base layer of gypsum wallboard fastened to steel studs with #6 1-1/8 in. long bugle head phillips drywall screws 12 in. o.c. The face layer of gypsum wallboard fastened with #6 1-5/8 in. bugle head phillips drywall screws spaced 8 in. o.c. Joint Tape and Compound - vinyl or casein, dry or premixed joint compound applied to face layers of gypsum wallboard in two coats to all exposed screw heads and gypsum wallboard joints. A min. 2-in. wide paper, plastic or fiberglass tape embedded in first layer of compound over joints in gypsum wallboard.
 - B. Max. diameter of opening in gypsum wallboard layers is to be 14-1/2 in. for wood stud wall assemblies. Wood studs are to consist of min. nom. 2 × 4 lumber max. spaced 16 in. o.c. Studs attached with min. 16d common nails to 2 × 4 lumber floor and ceiling runners measuring, which are secured to floor and ceiling with 3-in. concrete fasteners spaced max. 18-in. o.c. Studs and runners covered with two layers of 5/8 in. thick, Type X gypsum wallboard on each face. The base layer of gypsum wallboard fastened to wood studs with #6 1-1/8 in. bugle head phillips drywall screws spaced 12 in. o.c. The face layer of gypsum wallboard fastened with #6 1-5/8 in. bugle head phillips drywall screws spaced 8 in. o.c. Joint Tape and Compound - vinyl or casein, dry or premixed joint compound applied to face layers of gypsum wallboard in two coats to all exposed screw heads and gypsum wallboard joints. A min. 2-in. wide paper, plastic or fiberglass tape embedded in first layer of compound over joints in gypsum wallboard.

Through Penetration

Horizontal

2 Hour

PH

- 2. PENETRATING ITEM:** One metallic pipe, conduit or tubing to be installed concentrically within the through opening. The penetrating item is to be rigidly supported on both sides of the wall assembly. A nom. annular space of 3/4 in. is required within the fire stop system. The following types and sizes of metallic pipes, conduit or tubing may be used:
- A. Steel Pipe:** Schedule 10 (or heavier) nom. 24 in. diameter (or smaller) steel pipe.
 - B. Steel Pipe:** Schedule 5 (or heavier) nom. 4 in. diameter (or smaller) steel pipe.
 - C. Conduit:** Nom. 4 in. diameter (or smaller) electrical metallic tubing or steel conduit.
 - D. Copper Tubing:** Type L (or heavier) nom. 6 in. diameter (or smaller) copper tubing.
- 3. FILL, VOID OR CAVITY MATERIAL:** Min. of 1-1/4 in. thickness of sealant fill material is to be applied within the annulus on both faces of the wall through-penetration. Additional material is to be applied around the outer perimeter of the penetrating item, such that a min. 1/4 in. crown is formed.

Listed Manufacturer:

3M
Firestopping
Firestopping Sealant
3M Fire Barrier™ 2000 Silicone Joint Sealant
3M Fire Barrier™ 2000+ Silicone Joint Sealant





Design Number 3MU/PH 120-07

August 1, 2003
3M Company
Formerly Design No. FS 119 W
FIRE PENETRATION SEAL (Mechanical)
Penetrating Item Type A
T-Rating - 1 hr
F-Rating - 2 hr

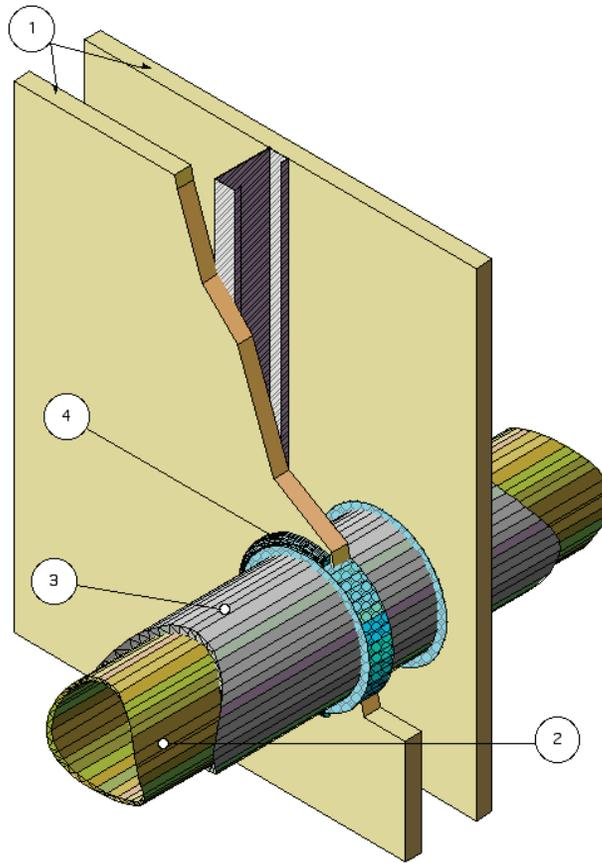

1. **GYPSUM WALL ASSEMBLY:** The framed opening in the wall shall be 7-1/2 in. wider and higher than the diameter of the penetrating item such that, when the penetrating item is centered in the opening, a 3-3/4 in. clearance is present between the penetrating item and the framing on all four sides. Two-hour fire-rated wall assembly shall include one of the following features:
 - A. Max. diameter of opening in gypsum wallboard layers is to be 22-1/2 in. for steel stud wall assemblies. When steel studs are used and the diameter of the opening exceeds the width of the stud cavity, the opening shall be framed on all sides using lengths of steel stud installed between the vertical studs, and screw-attached to the steel studs at each end. Min. 25 GA galvanized steel studs spaced 24 in. o.c. measuring 3-5/8 in. wide with 1-1/4-in. legs. Studs attached with min. #6 × 3/8-in. steel stud framing screws to channel shaped floor and ceiling runners measuring 1/2-in. deep by 3-5/8-in wide, which are secured to floor and ceiling with 1-in. long concrete fasteners spaced max. 18-in. o.c. Studs and runners covered with two layers of 5/8 in. thick, Type X gypsum wallboard on each face. The base layer of gypsum wallboard fastened to steel studs with #6 1-1/8 in. bugle head phillips drywall screws spaced 12 in. o.c. The face layer of gypsum wallboard fastened with #6, 1-5/8 in. long bugle head phillips drywall screws spaced 8 in. o.c. Joint Tape and Compound -vinyl or casein, dry or premixed joint compound applied to face layers of gypsum wallboard in two coats to all exposed screw heads and gypsum wallboard joints. A min. 2-in. wide paper, plastic or fiberglass tape embedded in first layer of compound over joints in gypsum wallboard.
 - B. Max. diameter of opening in gypsum wallboard layers is to be 14-1/2 in. for wood stud wall assemblies. Wood studs are to consist of min. nom. 2 × 4 lumber. spaced 16 in. o.c. Studs attached with min. 16d common nails to 2 × 4 lumber floor and ceiling runners, which are secured to floor and ceiling with 3-in. concrete fasteners spaced max. 18-in. o.c. Studs and runners covered with two layers of 5/8 in. thick, Type X gypsum wallboard on each face. The base layer of gypsum wallboard fastened to wood studs with #6 1-1/8 in. bugle head phillips drywall screws 12 in. o.c. The face layer of gypsum wallboard fastened with #6 1-5/8 in. long bugle head phillips drywall screws spaced 8 in. o.c. Joint Tape and Compound -vinyl or casein, dry or premixed joint compound applied to face layers of gypsum wallboard in two coats to all exposed screw heads and gypsum wallboard joints. A min. 2-in. wide paper, plastic or fiberglass tape embedded in first layer of compound over joints in gypsum wallboard.

Through Penetration

Horizontal

2 Hour

PH

- 2. PENETRATING ITEM:** One metallic pipe, conduit or tubing to be installed either concentrically or eccentrically within the through opening. The penetrating item is to be rigidly supported on both sides of the wall assembly. The following types and sizes of metallic pipes, conduit or tubing may be used:
- A. Steel Pipe:** Schedule 10 (or heavier) nom. 24 in. diameter (or smaller) steel pipe.
 - B. Conduit:** Nom. 4 in. diameter (or smaller) electrical metallic tubing or steel conduit.
 - C. Copper Tubing:** Type L (or heavier) nom. 6 in. diameter (or smaller) copper tubing.
 - D. Copper Pipe:** Nom. 6 in. diameter (or smaller) Regular (or heavier) copper pipe.
- 3. PIPE COVERING MATERIALS:** Nom. 1 in. thick hollow cylindrical heavy density (min. 3.5 pcf) glass fiber units, jacketed on the outside with an all service jacket. Longitudinal joints shall be tightly butted and sealed with metal fasteners or factory applied self-sealing lap tape. Transverse joints shall be secured with metal fasteners or with butt tape supplied with the product. A nom. annular space of 3/4 in. is required within the fire stop system. Any listed pipe covering material meeting the above specifications with a flame Spread Index of 25 or less and a Smoke Developed Index of 50 or less may be used.
- 4. FILL, VOID OR CAVITY MATERIAL:** Min. 1/4-in. depth of sealant fill material is to be applied over the recess of the packing material (4) on both sides of the wall through-penetration opening. The fill material is in direct contact with the steel duct or the insulation. The sealant material overlapped the concrete a nom. 1/4-in.

Listed Manufacturer:

3M
 Firestopping
 Firestopping Sealant
 3M Fire Barrier™ 2000 Silicone Joint Sealant
 3M Fire Barrier™ 2000+ Silicone Joint Sealant





Design Number 3MU/PH 120-08

August 1, 2003
 3M Company
 Formerly Design No. FS 540 W
 FIRE PENETRATION SEAL (Mechanical)
 Penetrating Item Type C
 T-Rating - 1 hr
 F-Rating - 2 hr

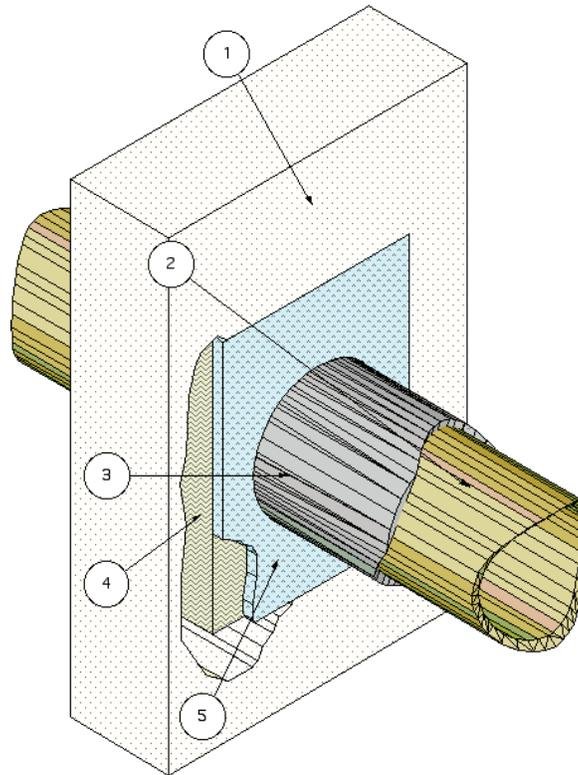

1. **WALL ASSEMBLY:** The fire-rated wall assembly shall consist of min. 4-1/2 in. thick lightweight or normal-weight (100-150 pcf) reinforced concrete. The wall assembly may also be constructed of any similarly rated concrete masonry units. Max. diameter of penetration opening is to be 32 in.
2. **PENETRATING ITEM:** One metallic pipe, conduit or tubing to be installed either concentrically or eccentrically within the through opening. The penetrating item is to be rigidly supported on both sides of the floor or wall assembly. The following types and sizes of metallic pipes, conduit or tubing may be used:
 - A. **Steel Pipe:** Schedule 10 (or heavier) nom. 24 in. diameter (or smaller) steel pipe.
 - B. **Conduit:** Nom. 4 in. diameter (or smaller) steel electrical tubing or steel conduit.
 - D. **Copper Tubing:** Type L (or heavier) nom. 6 in. diameter (or smaller) copper tubing.
 - E. **Copper Pipe:** Nom. 6 in. diameter (or smaller) Regular (or heavier) copper pipe
3. **PIPE COVERING MATERIALS:** Nom. 1 in. thick hollow cylindrical heavy density (min. 3.5 pcf) glass fiber units, jacketed on the outside with an all service jacket. Longitudinal joints shall be tightly butted and sealed with metal fasteners or factory applied self-sealing lap tape. Transverse joints shall be secured with metal fasteners or with butt tape supplied with the product. An annular space of 1/2 in. (min.) to 1-1/2 in. (max.) is required within the fire stop system. Any listed pipe covering material meeting the above specifications with a flame Spread Index of 25 or less and a Smoke Developed Index of 50 or less may be used.
4. **PACKING MATERIAL:** Nom. 3 in. depth of 4 pcf mineral wool batt insulation, tightly and permanently packed into the opening. Surface of packing material is to be recessed from the top surface of the floor or both surfaces of the wall assembly, as required to accommodate the necessary depth of caulk fill material (Item 5).
5. **FILL, VOID OR CAVITY MATERIAL:** Min. 1/2 in. depth of sealant fill material is to be applied to the recess around the top surface of the floor through-penetration opening or both faces of the wall through-penetration.

Listed Manufacturer:

3M
 Firestopping
 Firestopping Sealant
 3M Fire Barrier™ 2000 Silicone Joint Sealant
 3M Fire Barrier™ 2003 Silicone Joint Sealant
 3M Fire Barrier™ 2000+ Silicone Joint Sealant





Design Number 3MU/PH 120-10

August 1, 2003
3M Company
Formerly Design No. FS 118 W
FIRE PENETRATION SEAL (Mechanical)
Penetrating Item Type A
T-Rating - 0 hr
F-Rating - 2 hr

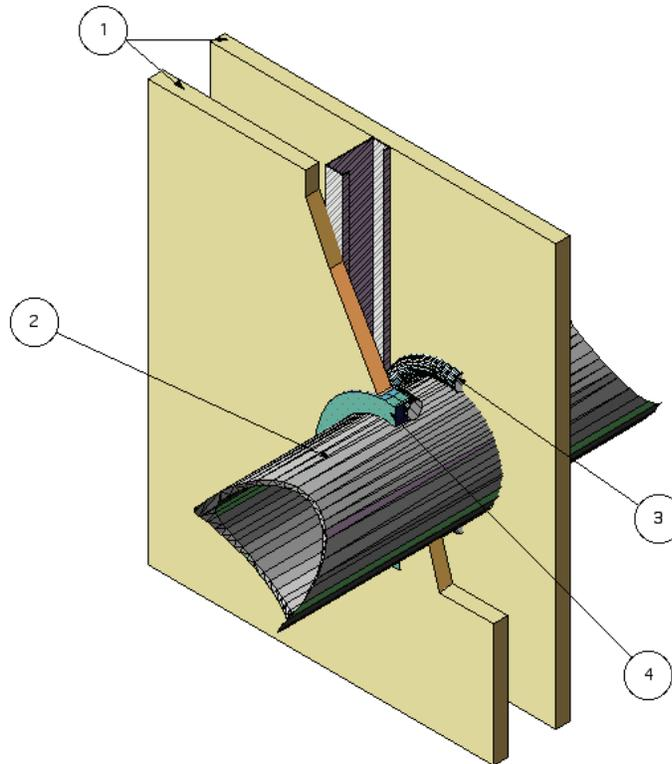

1. **GYPSUM WALL ASSEMBLY:** Max. opening for penetrating item in gypsum wallboard layers is to be 1-1/2 in. larger in diameter than the outside of the penetrating item. Two hour fire-rated wall assembly shall include one of the following features:
 - A. Min. 25 GA galvanized steel studs spaced 24 in. o.c. measuring 3-1/2 in. wide with 18-in. o.c. Studs and runners covered with two layers of 5/8 in. thick, Type X gypsum wallboard on each face. The base layer of gypsum wallboard fastened to steel studs with #6 1-1/8 in. bugle head phillips drywall screws 12 in. o.c. The face layer of gypsum wallboard fastened with #6 1-5/8 in. bugle head phillips drywall screws spaced 8 in. o.c. Joint Tape and Compound - Vinyl or casein, dry or premixed joint compound applied to face layers of gypsum wallboard in two coats to all exposed screw heads and gypsum wallboard joints. A min. 2-in. wide paper, plastic or fiberglass tape embedded in first layer of compound over joints in gypsum wallboard.
 - B. Wood studs are to consist of min. nom. 2 x 4 lumber max. spaced 16 in. o.c. Studs attached with min. 16d common nails to 2 x 4 lumber floor and ceiling runners measuring, which are secured to floor and ceiling with 3-in. concrete fasteners spaced max. 18-in. o.c. Studs and runners covered with two layers of 5/8 in. thick, Type X gypsum wallboard on each face. The base layer of gypsum wallboard fastened to wood studs with #6 1-1/8 in. bugle head phillips drywall screws spaced 12 in. o.c. The face layer of gypsum wallboard fastened with #6 1-5/8 in. bugle head phillips drywall screws spaced 8 in. o.c. Joint Tape and Compound - vinyl or casein, dry or premixed joint compound applied to face layers of gypsum wallboard in two coats to all exposed screw heads and gypsum wallboard joints. A min. 2-in. wide paper, plastic or fiberglass tape embedded in first layer of compound over joints in gypsum wallboard.
2. **PENETRATING ITEM:** One metallic pipe, conduit or tubing to be installed concentrically within the through opening. The penetrating item is to be rigidly supported on both sides of the wall assembly. An annular space of 3/4 in. is required within the fire stop system. The following types and sizes of metallic pipes, conduit or tubing may be used:
 - A. **Steel Pipe:** Schedule 10 (or heavier) nom. 12 in. diameter (or smaller) steel pipe.
 - B. **Conduit:** Nom. 6 in. diameter (or smaller) steel conduit.
 - C. **Conduit:** Nom. 4 in. diameter (or smaller) electrical metallic tubing.
 - D. **Copper Tubing:** Type L (or heavier) nom. 6 in. diameter (or smaller) copper tubing.
 - E. **Copper Pipe:** Nom. 6 in. diameter (or smaller) Regular (or heavier) copper pipe

Through Penetration

Horizontal

2 Hour

PH

- 3. FORMING MATERIAL:** Nom. 1 in. diameter polyethylene backer rod, tightly and permanently friction fit into opening. The forming material is to be recessed from both surfaces of the wall assembly, as required to accommodate the necessary depth of sealant fill material (Item 4).
- 3. FILL, VOID OR CAVITY MATERIAL:** Min. of 5/8 in. thickness of sealant fill material is to be applied within the annulus on both faces of the wall through-penetration.

Listed Manufacturer:

3M
Firestopping
Firestopping Sealant
3M Fire Barrier™ 2000+ Silicone Joint Sealant

Through Penetration

Horizontal

2 Hour

PH





Design Number 3MU/PH 120-20

August 1, 2003
3M Company
Formerly Design No. FS 572 W
FIRE PENETRATION SEAL (Mechanical)
Penetrating Item Steel Duct
ISO 6944
Integrity, Stability, Insulation – 2 Hr.
T-Rating - 2 hr
F-Rating - 2 hr

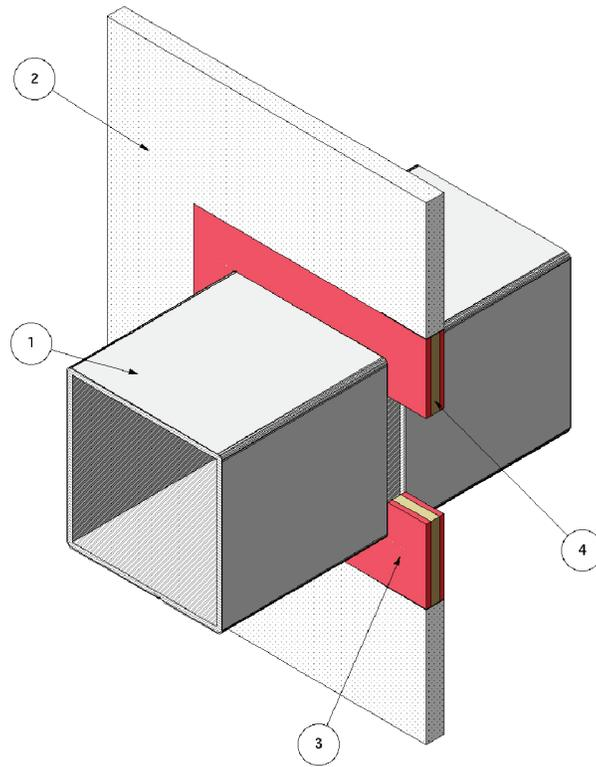

- PENETRATING ITEM:** An airtight round or rectangular steel duct system constructed with the limiting specifications in the table below. Protect duct with two layers of 3M Fire Barrier Duct Wrap 15A or 20A as detailed in systems VAD 529 F, VAD 530 F, or VAD 531 F, VAD 542 F. The insulation abutts the firestop system (3&4) on both sides of the wall.
- WALL ASSEMBLY:** The two-hour fire-rated wall assembly consists of min. 4-1/2 in. thick normal weight (100-150 pcf) reinforced concrete or concrete blocks. Create an opening in the wall assembly in accordance with the applicable specifications in the table below. Position the duct assembly concentrically or eccentrically in the opening so that the annular space ranges from min. 1 in. on one side to max. 2 in. on the other.
- FILL, VOID OR CAVITY MATERIAL:** Min. 1/4-in. depth of sealant fill material is to be applied over the recess of the packing material (4) on both sides of the wall through-penetration opening. The fill material is in direct contact with the steel duct or the insulation. The sealant material overlapped the concrete a nom. 1/4-in.

Listed Manufacturer:

3M
Firestopping
3M Fire Barrier™ 2000+ Silicone Sealant
3M Fire Barrier™ 1000 N/S Silicone Sealant

- FILL, VOID OR CAVITY MATERIAL:** Min. 1/4-in. depth of sealant fill material is to be applied over the recess of the packing material (4) on both sides of the wall through-penetration opening. The fill material is in direct contact with the steel duct or the insulation. The sealant material overlapped the concrete a nom. 1/4-in.

Listed Manufacturer:

3M
Firestopping
3M Fire Barrier™ 2000+ Silicone Sealant
3M Fire Barrier™ 1000 N/S Silicone Sealant

4. **PACKING MATERIAL:** Fill the annular space with scrap 3M Fire Barrier Duct Wrap 15A, 20A, or 4 pcf mineral wool**. Cut the mineral wool into strips. Then compress it approximately 50% and insert it into the opening to fill the entire annular space. Recess the surface of packing material a min. 1/4 in. from both sides of the wall as required to accommodate the necessary depth of caulk fill material. (** Listed with Omega Point Laboratories)

Listed Manufacturer:

3M
 Insulation
 Mineral Wool Blanket
 3M Fire Barrier Duct Wrap 15A
 3M Fire Barrier Duct Wrap 20A

| Max. Duct Area (in ²) | Max. Duct Dimension (in) | Min. Duct Gage Thickness | Max Area of Opening (in ²) | Max Dimension of Opening (in) |
|-----------------------------------|--------------------------|--------------------------|--|-------------------------------|
| 1440 | 60 | 20 GA | 2432 | 70 1/2 |
| 400 | 40 | 24 GA | 1035 | 50 1/2 |
| 144 | 12 | 26 GA | 506 | 22 1/2 |

Through Penetration

Horizontal

2 Hour

PH





Design Number 3MU/PH 180-01

August 1, 2003
 3M Company
 Formerly Design No. FS 538 W
 FIRE PENETRATION SEAL (Mechanical)
 Penetrating Item Type A
 T-Rating - 0 hr
 F-Rating - 3 hr

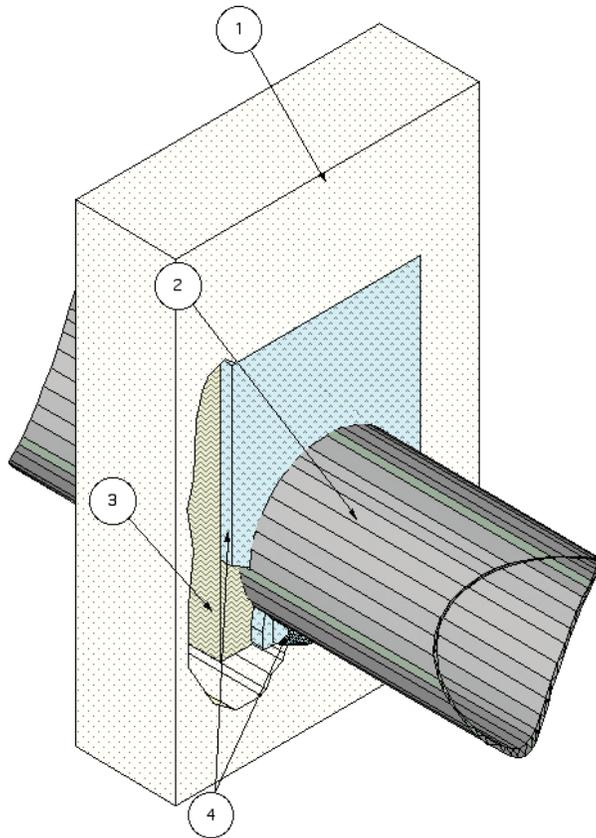

1. **WALL ASSEMBLY:** The fire-rated wall assembly shall consist of min. 4-1/2 in. thick lightweight or normal-weight (100-150 pcf) reinforced concrete. The wall assembly may also be constructed of any similarly rated concrete masonry units. Max. diameter of penetration opening is to be 1/4 in. (min.) to 3-1/4 in. (max.) larger than the penetrating item.
2. **PENETRATING ITEM:** One metallic pipe, conduit or tubing to be installed either concentrically or eccentrically within the through opening. The penetrating item is to be rigidly supported on both sides of the floor or wall assembly. An annular space of min. 0 in. (point contact) to max. 3-1/4 in. is required within the fire stop system. The following types and sizes of metallic pipes, conduit or tubing may be used:
 - A. **Steel Pipe:** Schedule 10 (or heavier) nom. 24 in. diameter (or smaller) steel pipe.
 - B. **Conduit:** Nom. 4 in. diameter (or smaller) steel conduit.
 - C. **Copper Tubing:** Type L (or heavier) nom. 6 in. diameter (or smaller) copper tubing.
 - D. **Copper Pipe:** Nom. 6 in. diameter (or smaller) Regular (or heavier) copper pipe.
4. **PACKING MATERIAL:** Nom. 3 in. depth of 4 pcf mineral wool batt insulation, tightly and permanently packed into the opening. Surface of packing material is to be recessed from the top surface of the floor or both surfaces of the wall assembly, as required to accommodate the necessary depth of caulk fill material (Item 4).
5. **FILL, VOID OR CAVITY MATERIAL:** Min. 1/2 in. depth of sealant fill material is to be applied to the recess around the top surface of the floor through-penetration opening or both faces of the wall through-penetration. An additional min. 1/2 in. diameter bead of sealant material is to be applied around the outer perimeter of the through opening, at the penetrating item to concrete interface.

Listed Manufacturer:

3M
 Firestopping
 Firestopping Sealant
 3M Fire Barrier™ 2000 Silicone Joint Sealant
 3M Fire Barrier™ 2003 Silicone Joint Sealant
 3M Fire Barrier™ 2000+ Silicone Joint Sealant





Design Number 3MU/PH 180-03

August 1, 2003
3M Company
Formerly Design No. FS 539 W
FIRE PENETRATION SEAL (Mechanical)
Penetrating Item Type A
T-Rating - 1 hr
F-Rating - 3 hr

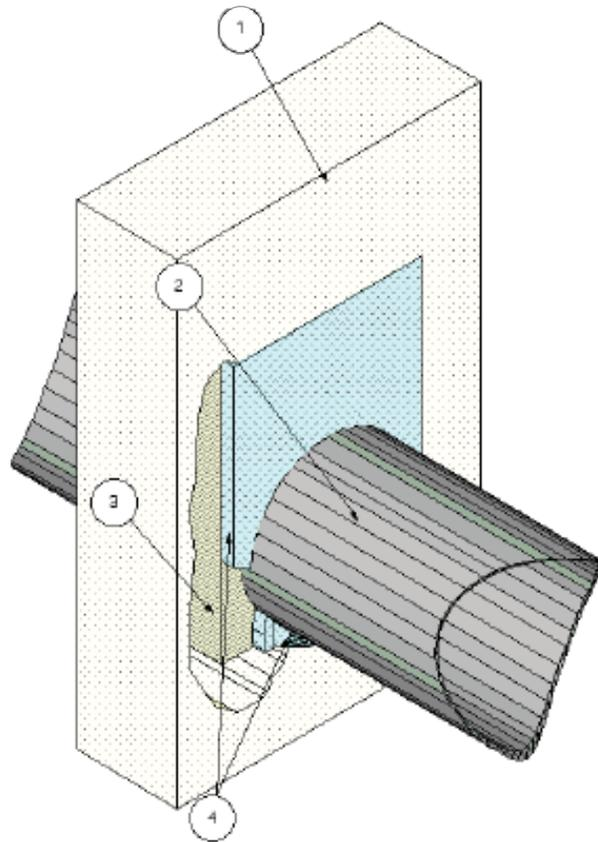

- 1. WALL ASSEMBLY:** The three-hour fire-rated wall assembly shall consist of min. 4-1/2 in. thick lightweight or normal-weight (100-150 pcf) reinforced concrete. The wall assembly may also be constructed of any similarly rated concrete masonry units. Max. diameter of penetration opening is to be 15 in.
- 2. PENETRATING ITEM:** One metallic pipe, conduit or tubing to be installed either concentrically or eccentrically within the through opening. The penetrating item is to be rigidly supported on both sides of the floor or wall assembly. An annular space of min. 0 in. (point contact) to max. 2-7/8 in. is required within the fire stop system. The following types and sizes of metallic pipes, conduit or tubing may be used:
 - A. Steel Pipe:** Schedule 10 (or heavier) nom. 12 in. diameter (or smaller) steel pipe.
 - B. Conduit:** Nom. 6 in. diameter (or smaller) steel conduit.
 - C. Conduit:** Nom. 4 in. diameter (or smaller) steel electrical tubing.
 - D. Copper Tubing:** Type L (or heavier) nom. 6 in. diameter (or smaller) copper tubing.
 - E. Copper Pipe:** Nom. 6 in. diameter (or smaller) Regular (or heavier) copper pipe.
- 4. PACKING MATERIAL:** Nom. 3 in. depth of 4 pcf mineral wool batt insulation, tightly and permanently packed into the opening. Surface of packing material is to be recessed from the top surface of the floor or both surfaces of the wall assembly, as required to accommodate the necessary depth of caulk fill material (Item 4).
- 5. FILL, VOID OR CAVITY MATERIAL:** Min. 1/4 in. depth of sealant fill material is to be applied to the recess around the top surface of the floor through-penetration opening or both faces of the wall through-penetration. An additional min. 1/2 in. diameter bead of sealant material is to be applied around the outer perimeter of the through opening, at the penetrating item to concrete interface.

Listed Manufacturer:

3M
Firestopping
Firestopping Sealant
3M Fire Barrier™ 2000+ Silicone Joint Sealant





Design Number 3MU/PH 180-04

August 1, 2003
3M Company
Formerly Design No. FS 541 W
FIRE PENETRATION SEAL (Mechanical)
Penetrating Item Type C
T-Rating - 1 hr
F-Rating - 3 hr

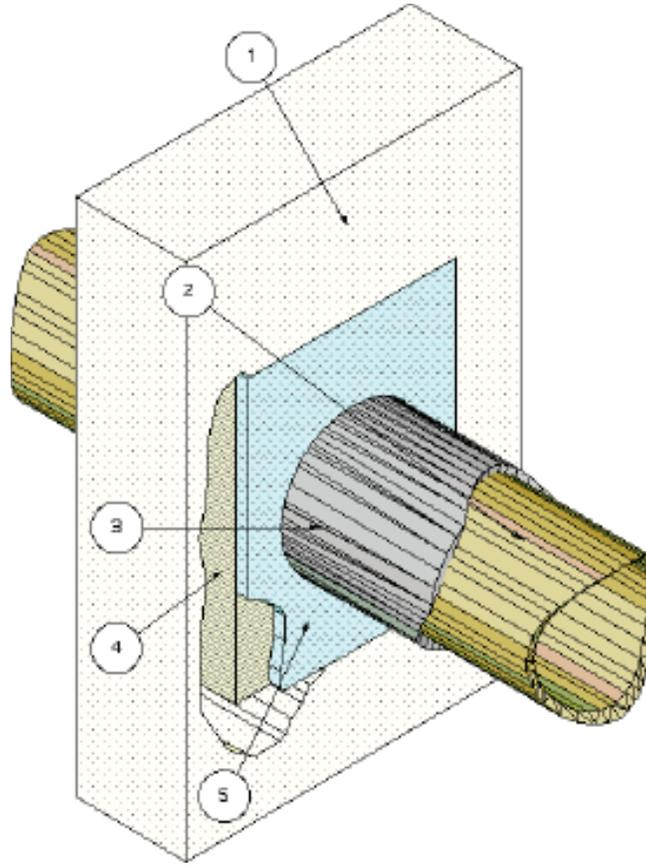

- 1. WALL ASSEMBLY:** The fire-rated wall assembly shall consist of min. 4-1/2 in. thick lightweight or normal-weight (100-150 pcf) reinforced concrete. The wall assembly may also be constructed of any similarly rated concrete masonry units. Max. diameter of penetration opening is to be 11 in.
- 2. PENETRATING ITEM:** Schedule 10 (or heavier) nom. 6 in. diameter (or smaller) steel pipe to be installed either concentrically or eccentrically within the fire stop system. The pipe is to be rigidly supported on both sides of the floor or wall assembly.
- 3. PIPE COVERING MATERIALS:** Nom. 1 in. thick hollow cylindrical heavy density (min. 3.5 pcf) glass fiber units, jacketed on the outside with an all service jacket. Longitudinal joints shall be tightly butted and sealed with metal fasteners or factory applied self-sealing lap tape. Transverse joints shall be secured with metal fasteners or with butt tape supplied with the product. An annular space of 3/4 in. (min.) to 1-5/8 in. (max.) is required within the fire stop system.
- 4. PACKING MATERIAL:** Nom. 3 in. depth of 4 pcf mineral wool batt insulation, tightly and permanently packed into the opening. Surface of packing material is to be recessed from the top surface of the floor or both surfaces of the wall assembly, as required to accommodate the necessary depth of caulk fill material (Item 5).
- 5. FILL, VOID OR CAVITY MATERIAL:** Min. 1/4 in. depth of sealant fill material is to be applied to the recess around the top surface of the floor through-penetration opening or both faces of the wall through-penetration. An additional min. 1/2 in. diameter bead of sealant material is to be applied around the outer perimeter of the through opening, at the penetrating item to concrete interface.

Listed Manufacturer:

3M
Firestopping
Firestopping Sealant
3M Fire Barrier™ 2000+ Silicone Joint Sealant



Horizontal or Vertical Assemblies (Floor or Walls)

| 3M Systems | "F" Rating | 3M Product | Application Details |
|---------------|------------|--|---|
| 3M/PHV 60-01 | 1 | 3M™ Fire Barrier Sealant CP-25WB+ 3M™ Fire Barrier Sealant IC 15WB+ | Nominal 1/2" PEX through a 1 hour rated wood floor/ceiling assembly or 1 hour wall board assembly |
| 3M/PHV 120-01 | 2 | 3M™ Fire Barrier Mortar | Max. 8" Steel pipe, 3" Copper tubing, Bus Ducts, Pipe insulation, cable trays and support channel through a 2 hour rated concrete floor/wall assembly, min. 4" thick. |
| 3M/PHV 120-02 | 2 | 3M™ FireStrap™ 3M™ Fireplug™ 3M™ Fire Barrier Mortar 3M™ Fire Barrier Sealant CP-25WB+ 3M™ Fire Barrier Sealant IC 15WB+ 3M™ Fire Barrier Sealant FD 150+ | Max. 2" PVC, XFR through a 2 hour rated concrete floor assembly, min. 2-1/2" thick, or Q-deck, or a 2 hour rated floor/wall assembly min. 4 1/2" thick concrete, hollow core, or 8" concrete block (wall only) |
| 3M/PHV 120-03 | 2 | 3M™ Fire Barrier Ultra Plastic Pipe Device 3M™ Fire Barrier Ultra RC Pack 3M™ Fire Barrier Ultra Plastic Pipe Device-1.5 3M™ Fire Barrier Plastic Pipe Device-6 3M™ Fire Barrier Sealant CP-25WB+ 3M™ Fire Barrier Sealant IC 15WB+ 3M™ Fire Barrier Sealant FD 150+ | Max. 6" PVC, XFR, Max. 4" CPVC, ccABS, ABS, FRPP Max. 2" PVC – Thin wall through a 2 hour rated floor/wall assembly min. 4-1/2" thick concrete, hollow core, or 8" concrete block (wall only) |
| 3M/PHV 120-04 | 1, 2 | 3M™ Fire Barrier Ultra Plastic Pipe Device-2 3M™ Fire Barrier Ultra RC Pack 2 3M™ Fire Barrier Wrap Ultra GS 3M™ Fire Barrier RC-1 Restricting Collar 3M™ Fire Barrier Sealant CP-25WB+ | Max. 3 – 1" PEX through 2 hour rated floor or wall assembly, min. 2-1/2" thick concrete, hollow core, or Q-deck. 1 or 2 hour rated wall board assembly, or 1 or 2 hour rated wood floor/ceiling assembly |
| 3M/PHV 120-05 | 2 | 3M™ FireMaster® Duct Wrap | 2 hour FT rating for Max. 4" Steel, Cast, EMT, or Copper through a 1 or 2 hour rated floor or wall assembly, nominal 2-1/2" concrete or hollow core |
| 3M/PHV 120-06 | 2 | 3M™ FireMaster® Duct Wrap | 2 hour FT rating for Max. 4" Steel, Cast, EMT, or Copper through a 1 or 2 hour rated floor or wall assembly, nominal 2-1/2" concrete or hollow core. 2 or 3 sided system. |
| 3M/PHV 120-07 | 2 | 3M™ Fire Barrier Sealant CP-25WB+ 3M™ Fire Barrier Sealant IC 15WB+ 3M™ Fire Barrier Sealant FD 150+ 3M™ Fire Barrier Ultra RC Pack 3M™ Fire Barrier Ultra Plastic Pipe Device 3M™ Fire Barrier Wrap Ultra GS 3M™ Fire Barrier RC-1 Restricting Collar | Max. 4" PVC, XFR through 2 hour rated floor or wall assembly, min. 4 -1/2" thick concrete, or hollow core or 2 hour rated wall board assembly. |
| 3M/PHV 120-08 | 2 | 3M™ FireStrap™ 3M™ Fire Barrier Mortar 3M™ Fire Barrier Sealant CP-25WB+ 3M™ Fire Barrier Sealant IC 15WB+ 3M™ FireDam 150+ Caulk | Max. 3" ABS, ccABS, Max. 2" PVC, PVC – Thin wall through 2 hour rated floor or wall assembly, min. 4-1/2" thick concrete, or hollow core, or 8" concrete block (wall only) |
| 3M/PHV 120-09 | 2 | 3M™ FireDam Spray 200 3M™ Fire Barrier Water Tight Sealant 1000 NS 3M™ Fire Barrier Water Tight Sealant 1003 SL | Multiple penetrating items including metal pipes, insulated pipes, cable trays, MI cable through 2 hour rated floor or wall assembly, min. 4-1/2" thick concrete, or 8" concrete block (wall only) |
| 3M/PHV 120-10 | 2 | 3M™ Fire Barrier RC-1 Restricting Collar 3M™ Fire Barrier Wrap Strips FS-195+ 3M™ Fire Barrier Sealant CP-25WB+ 3M™ Fire Barrier Sealant IC 15WB+ | Max. 4" ccPVC, PVC, CPVC, ccABS, ABS, FRPP through 2 hour rated floor or wall assembly, min. 2-1/2" thick concrete, Q-deck, or hollow core concrete or 8" concrete block (wall only) or 1 or 2 hour rated wall board assembly or a 1 or 2 hour rated wood floor/ceiling assembly |
| 3M/PHV 120-11 | 1, 2 | 3M™ Fire Barrier Wrap Ultra GS 3M™ Fire Barrier Sealant CP-25WB+ 3M™ Moldable Putty+ Pads and Sticks | Max. 1" PEX through 2 hour rated floor or wall assembly, min. 2-1/2" thick concrete, Q-deck, or hollow core concrete or 8" concrete block (wall only) or 1 or 2 hour rated wall board assembly or a 1 or 2 hour rated wood floor/ceiling assembly |
| 3M/PHV 120-12 | 2 | 3M™ Fire Barrier Sealant IC 15WB+ | Max. 2" PVC, Max. 1" PEX, Kitec through 2 hour rated floor or wall assembly, min. 4-1/2" thick concrete, or 8" concrete block (wall only) |
| 3M/PHV 120-13 | 1, 2 | 3M™ Fire Barrier Sealant CP-25WB+ 3M™ Fire Barrier Wrap Strips FS-195+ | Max. 2" ENT through 2 hour rated floor or wall assembly, min. 4-1/2" thick concrete, or hollow core or 8" concrete block (wall only) or 1 or 2 hour rated wall board assembly. |
| 3M/PHV 120-14 | 90 Min | 3M™ Fire Barrier Sealant IC 15WB+ | Max. 1-3/16" through 2 hour rated floor or wall assembly, min. 4-1/2" thick concrete floor, min. 6 1/2" concrete walls. |
| 3M/PHV 120-15 | 2 | 3M™ Fire Barrier Wrap Strips FS-195+ 3M™ Fire Barrier RC-1 Restricting Collar 3M™ Fire Barrier Sealant CP-25WB+ | Max. 8" PVC through 2 hour rated floor or wall assembly, min. 4-1/2" thick concrete, or hollow core or 8" concrete block (wall only). |

Horizontal or Vertical Assemblies (Floor or Walls)

| 3M Systems | "F" Rating | 3M Product | Application Details |
|---------------|------------|---|---|
| 3M/PHV 120-16 | 2 | 3M™ Fire Barrier Sealant CP-25WB+ 3M™ Fire Barrier Wrap Ultra GS | Max. 4" steel, Max. 2" copper pipe through 2 hour rated floor or wall assembly, min. 4-1/2" thick concrete, or 8" concrete block (wall only). |
| 3M/PHV 120-17 | 1, 2 | 3M™ FireStrap™ 3M™ Fire Barrier Mortar 3M™ Fire Barrier Sealant CP-25WB+ 3M™ Fire Barrier Sealant IC 15WB+ 3M™ Fire Barrier Sealant FD 150+ | Max. 3" FRPP 2 hour rated floor or wall assembly, min. 4 1/2" thick concrete, or hollow core or 8" concrete block (wall only) or 1 or 2 hour rated wall board assembly. |
| 3M/PHV 120-18 | 2 | 3M™ Fire Barrier Water Tight Sealant 1000 NS 3M™ Fire Barrier Water Tight Sealant 1003 SL | Max. 8" steel or cast pipe through 2 hour rated floor or wall assembly, min. 4-1/2" thick concrete. |
| 3M/PHV 120-19 | 2 | 3M™ Fire Barrier Water Tight Sealant 1000 NS 3M™ Fire Barrier Water Tight Sealant 1003 SL | Max. 8" Steel, Cast, Max. 4" EMT, Copper pipe, Max. 2" CPVC, PVC (process and supply only), Glass pipe 1/2" BX, 6" Electrical Cable bundle through 2 hour rated floor or wall assembly, min. 4-1/2" thick concrete. |
| 3M/PHV 120-20 | 2 | 3M™ Fire Barrier Sealant IC 15WB+ | Max. 2" XFR through 2 hour rated floor or wall assembly, min. 4-1/2" thick concrete, or 8" concrete block (wall only) |

3M CANADA CO. – London, On Canada

DESIGN NO. 3M/PHV 60-01

October 02, 2006

HORIZONTAL OR VERTICAL (FLOOR OR WALL),
 RATINGS – SEE BELOW, MAXIMUM HOLE SIZE – 1-1/2" DIAMETER
 TEST PRESSURE DIFFERENTIAL – 50 Pa (0.20" OF WATER)

| Penetrant | Max. Pipe Size | CAN/ULC-S115 CAN4-S115 F, FT, FTH | ASTM-E814 F, T |
|-----------|----------------|---|-------------------|
| PEX | 1/2" | 1 Hr | 1 Hr |

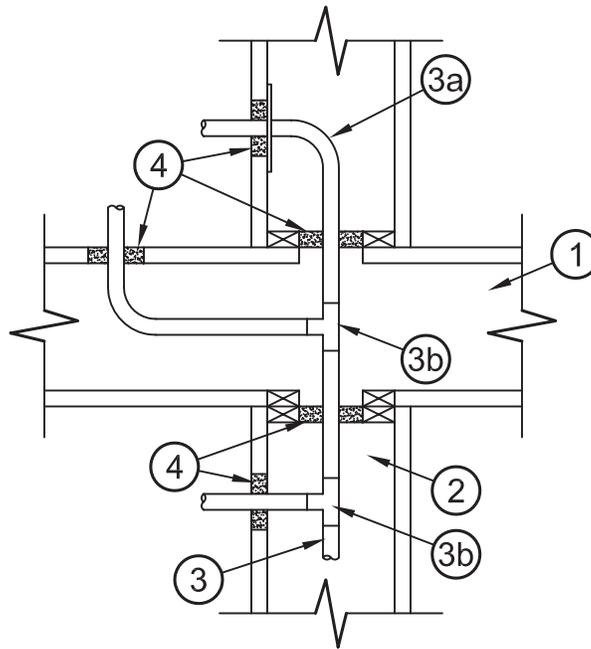

- Floor/Ceiling Assembly:** Code conforming 1 hour fire-rated floor/ceiling assembly, framed with minimum nominal 2" x 10" solid sawn or manufactured wood joists, topping optional (not shown).
- Chase Wall:** Code conforming 1 hour fire-rated wood or steel stud gypsum wallboard assembly, install the firestop system as detailed in (Item 4) to the underside of the double top plate.
- Penetrant:** (See table of ratings) Nominal 1/2" ID, PEX Pipe, including 90° Metal Turnouts (Item 3a) and Tee's (Item 3b) for use in Closed (Process and Supply) piping systems, ratings achieved will equal that of floor or wall assembly.
- Firestop System Component:** *3M™ Fire Barrier CP-25WB+ Caulk or *3M™ Fire Barrier IC 15WB+ Sealant fill the annular space to a minimum depth of 5.8"

Note: Metric conversion factor, inches x 25.4 = mm.

*Components bearing the Warnock Hersey Certification Mark.

This material was extracted and drawn by 3M Fire Protection Products from the 2006 Warnock Hersey Directory of Listed Products

Through Penetrations

Horizontal/Vertical

1 Hour

PHV

3M CANADA CO. – London, On Canada

DESIGN NO. 3M/PHV 120-01

July 26, 2006

HORIZONTAL OR VERTICAL (FLOOR OR WALL),
 RATINGS – SEE BELOW, ANNULAR SPACING – 1/4" MINIMUM,
 NO MAXIMUM
 TEST PRESSURE DIFFERENTIAL – 2.5 Pa (0.01" OF WATER)

| Penetration Material | Size | CAN/ULC-S115 | | ASTM-E814 | |
|--|---------------------------------------|--------------|------------|---------------|------------|
| | | F/FH | FT/FTH | F | T |
| Copper Tubing, Type L or DWV | 1/2" - 3" | 2 Hr | 0 minutes | 2 Hr | 0 minutes |
| EMT Steel Conduit | 1/2" - 4" | 2 Hr | 1 Hr | 2 Hr | 1 Hr |
| Steel Pipe Sch. 10S or Heavier | 1/2" - 8" | 2 Hr | 1 Hr | 2 Hr | 1 Hr |
| Steel U-Channel Supports | 1-5/8" x 3-1/4" max. | 2 Hr | 1 Hr | 2 Hr | 1 Hr |
| Cable Tray, Steel or Aluminum 10S or Heavier Ladder Type | 36" x 6" | 2 Hr | 50 minutes | 2 Hr | 50 minutes |
| Bus Duct Assembly | Max. 111.3" ² | 2 Hr | 2 Hr | 2 Hr | 2 Hr |
| Pipe Insulation | Various (See Item 4) | 2 Hr | 2 Hr | 2 Hr <td 2 Hr | |
| No Penetrant | 12" x 12" Rectangular or 12" Diameter | 2 Hr | 2 Hr | 2 Hr | 2 Hr |

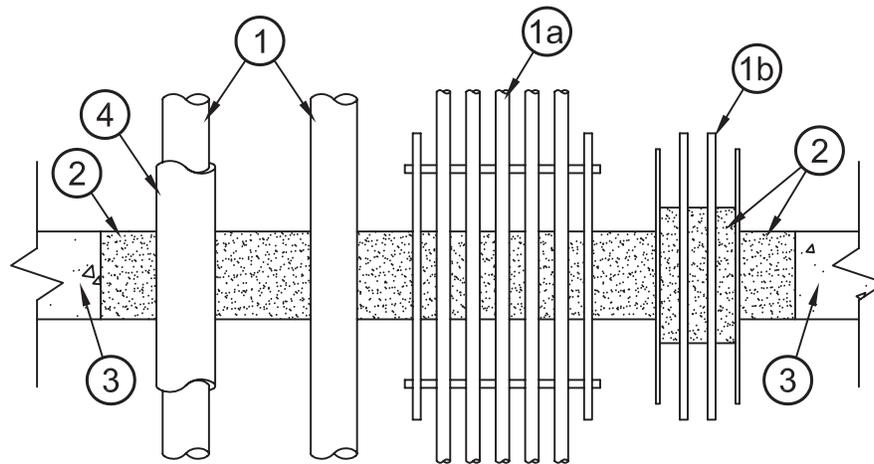

- Penetrations:** As per table of ratings; maximum number of penetrants is not limited. Penetrant spacing is limited only by good structural practice for complete mortar penetration except bus ducts or cable trays which shall be spaced a minimum of 4" apart. Steel U-Channel supports may penetrate at angles up to 45° from perpendicular.
 - Cable trays have a maximum fill of 45% by area, (100% visual fill) of Control, Communication or Power Cables of any type or size, including Mineral Insulated (MI) cable.
 - Bus ducts may contain Copper conductors (4500 A maximum) or aluminum conductors (3400 A maximum) and be internally firestopped with 3M™ Fire Barrier Mortar 8" in depth, centered in wall or floor. Conductors to be suitably insulated at location of contact with mortar.
 - No Penetrant (Not Shown): Maximum opening size is 12" x 12" rectangular or 12" diameter.
- Filler Material:** *3M™ Fire Barrier Mortar, minimum depth 4", minimum depth 8" in bus ducts.
 - Slip Cover: 1/8" thick ceramic paper blankets may be used to wrap moving pipes within 3M™ Fire Barrier Mortar as a bond breaker to prevent mechanical damage. Blankets must be securely held on pipes and/or pipe covering by suitable tapes or wire.
- Floor or Wall:** Concrete slab, or concrete block wall with a minimum density of 100 lbs/ft³ density minimum depth as necessary for required fire resistance rating but not less than 4". Maximum size of opening 22.7 sq. ft., maximum length 8 ft.
- Pipe Insulation** (Optional): For steel pipe, 1" to 6" pre-molded calcium silicate or rockwool, or 6" perlite based insulation with minimum 0.016" thick aluminum jacket, or minimum 0.010" thick steel or stainless steel jacket. For copper pipe a minimum 1" rockwool pipe wrap insulation with foil scrim craft jacket. All insulation and jacketing must be securely fastened.

Note: Metric conversion factor, inches x 25.4 = mm.

Refer to 3M literature for complete installation information.

*Component bearing the Warnock Hersey Certification Mark.

This material was extracted and drawn by 3M Fire Protection Products from the 2006 Warnock Hersey Directory of Listed Products

3M CANADA CO. – London, On Canada

DESIGN NO. 3M/PHV 120-02

July 26, 2006

HORIZONTAL (FLOOR); RATINGS – SEE BELOW; ANNULAR SPACE – SEE ITEM 3
TEST PRESSURE DIFFERENTIAL – 50 Pa (0.20" OF WATER)

| Penetrant | Max. Pipe ID | CAN/ULC-S115 | | | |
|------------|--------------|--------------|------|------|------|
| | | F | FH | FT | FT |
| PVC | 2" | 2 Hr | 2 Hr | 0 Hr | 0 Hr |
| System XFR | 2" | 2 Hr | 2 Hr | 0 Hr | 0 Hr |

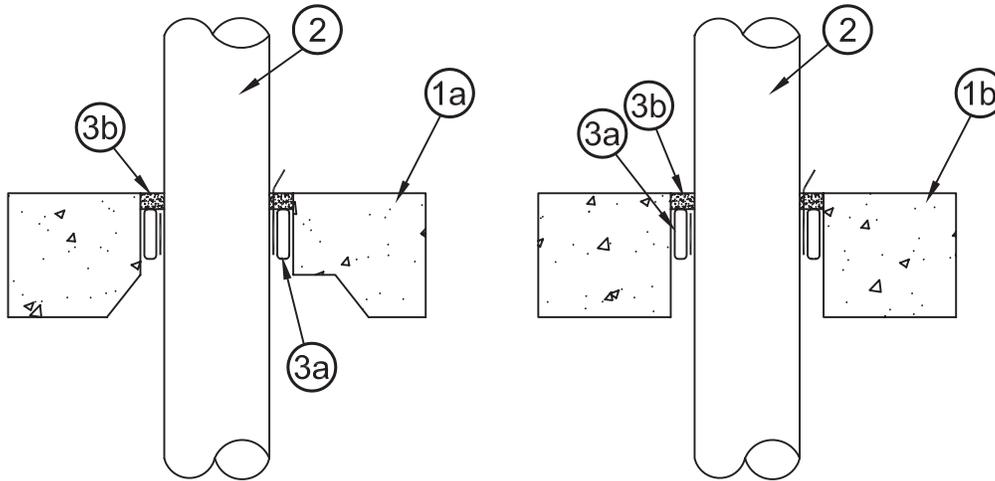

1. **Floor Assembly:** Code conforming 2 Hour fire-rated floor assembly, nominal 2-1/2" concrete, Q Deck or Fluted Deck, normal or low density cast concrete.
 - 1b. **Floor or Wall Assembly:** Code conforming 2 Hour fire-rated floor or wall assembly, nominal 4-1/2" thickness, normal or low density cast concrete or Hollow Core Concrete (not shown). Wall may also be constructed of nominal 8" thick concrete blocks (filled or unfilled).
2. **Penetrant** – (See also table of ratings) Nominal 2" diameter, Schedule 40, PVC and System XFR pipes for use in DWV (Drain, Waste and Vent) or Closed (Process and Supply) piping systems, ratings achieved will equal that of floor or wall assembly.
3. **Firestop System Components:**
 - a. *3M™ FireStrap™ or *3M™ FirePlug™ : Install within opening, recessed 1/4" from the floor surface, according to the manufacturers instructions. For Hollow Core Concrete install on the underside flush with the bottom surface, and apply sealant (Item 3b) on floor side, 1/2" thickness over 1" thickness of tightly packed, 4 PCF, mineral wool, recessed 1/2" from the floor surface, according to the manufacturers instructions. For walls install firestop system flush to the surface on both sides. To reduce hole diameter to the size listed, back fill with *3M™ Fire Barrier Mortar or non-shrink grout.

| Pipe ID | Hole Size |
|---------|-----------|
| 1-1/2" | 3" |
| 2" | 3" |

- b. **Sealant:** *3M™ Fire Barrier CP-25WB+ Caulk, *3M™ Fire Barrier IC 15WB+ Sealant, or *3M™ FireDam 150+ Caulk, applied to seal the annular space between the opening and the firestop device (Item 3a), to a 1/4" thickness flush with the floor or wall surface. Firestop system is applied to both sides for wall applications.

Note: Metric conversion factor, inches x 25.4 = mm.

*Components bearing the Warnock Hersey Certification Mark.

This material was extracted and drawn by 3M Fire Protection Products from the 2006 Warnock Hersey Directory of Listed Products

Through Penetrations

Horizontal/Vertical

2 Hour

PHV

3M CANADA CO. – London, On Canada

DESIGN NO. 3M/PHV 120-03

July 26, 2006

HORIZONTAL OR VERTICAL (FLOOR OR WALL), RATINGS – SEE BELOW, ANNULAR SPACE – 1/4" MAXIMUM
TEST PRESSURE DIFFERENTIAL – 50 Pa (0.20" OF WATER)

| Penetrant | Pipe Size | CAN/ULC-S115 CAN4-S115 F, FH, FT, FTH | ASTM-E814 F, T |
|-----------------|-------------|---|-------------------|
| PVC | 1-1/2" - 6" | 2 Hr | 2 Hr |
| System XFR | 1-1/2" - 6" | 2 Hr | 2 Hr |
| CPVC | 1-1/2" - 4" | 2 Hr | 2 Hr |
| ccABS | 1-1/2" - 4" | 2 Hr | 2 Hr |
| ABS | 1-1/2" - 4" | 2 Hr | 2 Hr |
| FRPP | 1-1/2" - 4" | 2 Hr | 2 Hr |
| PVC - Thin Wall | 2" | 2 Hr | 2 Hr |

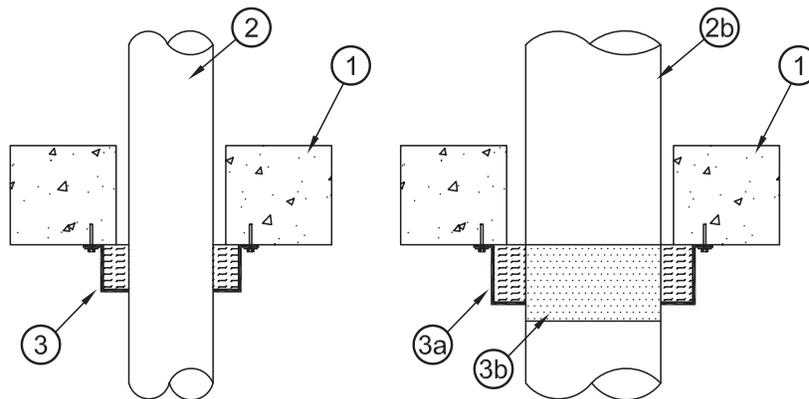

- Floor or Wall Assembly:** Code conforming 2 hour fire-rated floor or wall assembly, nominal 4-1/2" thickness normal or low density cast concrete, or hollow core concrete. Wall may also be constructed of nominal 8" thick concrete blocks (filled or unfilled). Hollow Core Concrete (Not Shown): Seal the annular space at pipe penetration on the floor side with a 1/4" thickness of *3M™ CP-25WB+ Caulk, *3M™ Fire Barrier IC 15 WB+ Sealant or *3M™ FireDam™ 150+ Caulk, flush with floor surface. Caulk is applied over 1" thickness of mineral wool.
- Penetrant:** (See table of ratings) Nominal 4" diameter, Schedule 40, ccABS, ABS, PVC, System XFR, CPVC and FRPP pipes for use in DWV (Drain, Waste and Vent) or Closed (Process and Supply) piping systems, and PVC - Thin Wall Vacuum Tubing (nominal 2" diameter), ratings achieved will equal that of floor or wall assembly.
 - Nominal 6" diameter, Schedule 40, PVC and System XFR pipe.
- Firestop System Component:** *3M™ Interam™ Ultra PPD or *3M™ Fire Barrier Ultra RC Pack: Sized appropriately for pipe diameter, secured with *3M™ Ultrafast™ Anchors or steel masonry anchors 1/4" diameter x 1-1/4" long over fender washers. To reduce opening size backfill annular space with a non-shrink grout. Use *3M™ Interam™ Ultra PPD-1.5 for PVC - Thin Wall Vacuum Tubing (nominal 2" diameter).
 - *3M™ Interam™ PPD-6: Installed onto the pipe (Item 2b) over aluminum foil tape (Item 3b), secured with steel masonry anchors 1/4" diameter x 1-1/4" long over fender washers.

3M™ Interam™ Ultra PPD Size Chart

| Device | Nominal Pipe ID | Max. Hole Size |
|---------|-----------------|----------------|
| PPD-1.5 | 1-1/2" | 2-1/2" |
| PPD-2 | 2" | 3" |
| PPD-3 | 3" | 4" |
| PPD-4 | 4" | 5" |
| PPD-6 | 6" | 7" |

3M™ Ultra RC Pack Size Chart

| Device | Nominal Pipe ID | Max. Hole Size |
|-----------|-----------------|----------------|
| RC Pack 2 | 2" | 3" |
| RC Pack 3 | 3" | 4" |
| RC Pack 4 | 4" | 5" |

- Aluminum Foil Tape: Wrap pipe with one layer of tape covering 4" of pipe length.

**Sealant (Optional): *3M™ CP-25WB+ Caulk, *3M™ Fire Barrier IC 15 WB+ Sealant or *3M™

FireDam™ 150+ Caulk to fill the annular space at the pipe penetration as a smoke seal.

CPVC Pipe - Use only *3M™ Fire Barrier IC 15 WB+ Sealant.

Note: Metric conversion factor, inches x 25.4 = mm.

*Components bearing the Warnock Hersey Certification Mark.

**May be used, however, is not require to achieve ratings.

This material was extracted and drawn by 3M Fire Protection Products from the 2006 Warnock Hersey Directory of Listed Products

3M CANADA CO. – London, On Canada

DESIGN NO. 3M/PHV 120-04

October 02, 2006

HORIZONTAL or VERTICAL (FLOOR or WALL)

RATINGS – See Below

MAXIMUM HOLE SIZE – 3" diameter

TEST PRESSURE DIFFERENTIAL – 50 Pa (0.20 in. of water) MINIMUM

| Design | Penetrant | Pipe Size Maximum | CAN/ULC-S115 CAN4-S115-M | | ASTM-E814 | |
|--------|-----------|-------------------|-----------------------------|----------|-----------|------|
| | | | F & FH | FT & FTH | F | T |
| A | PEX | 1" | 2 Hr | 0 Hr | 2 Hr | 0 Hr |
| B & C | PEX | 1" | 1 & 2 Hr | 0 Hr | 1 & 2 Hr | 0 Hr |

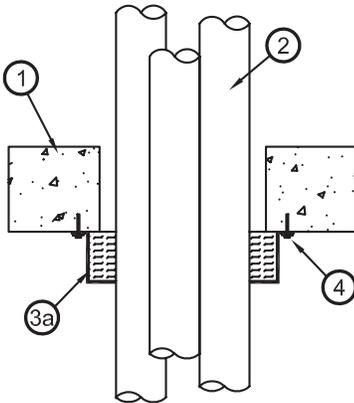

DESIGN A

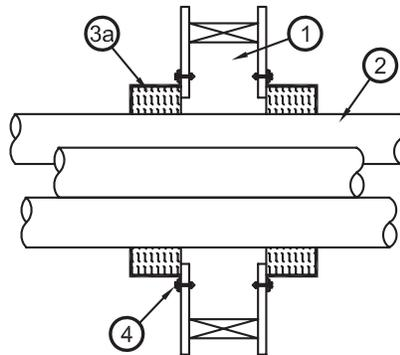

DESIGN B

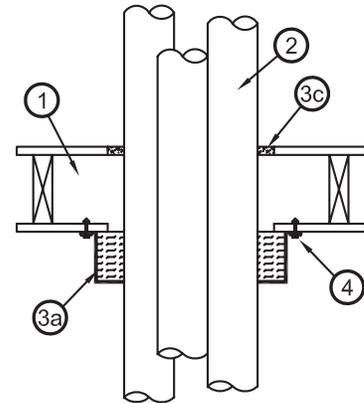

DESIGN C

- Design A:** Code conforming 2 HR rated floor or wall assembly, minimum 2-1/2" normal or low density cast concrete, hollow core concrete or Q-Deck. Wall may also be constructed of nominal 8" thick concrete blocks (filled or unfilled).

Design B: Code conforming 1 or 2 HR rated wall, nominal 2" x 4" steel / wood framed gypsum wallboard, wall assembly.

Design C: Code conforming 1 or 2 HR rated floor / ceiling assembly, framed with nominal 2" x 10" solid sawn or manufactured wood joists, topping optional (not shown).
- Penetrant** (See also table of ratings) – PEX Pipes, maximum of three (3) nominal 1" diameter or smaller, ratings will equal that of the floor or wall assembly.
- Firestop System Components:**

 - *3M™ Interam™ Ultra PPD-2 or *3M™ Fire Barrier Ultra RC Pack 2 attach to fire rated substrate, underside for floors and both sides in wall applications.
 - (Alternate Method - Not Shown) Wrap the pipe bundle continuously to form two layers of *3M™ Interam™ Ultra GS Material Apply a length of *3M™ Fire Barrier RC-1 Collar, with a 1" overlap, secured with a stainless steel hose clamp, fasten to substrate with the appropriate fasteners.
Attach the firestop to the fire rated substrate at the underside for floors; both sides in wall applications.
 - *3M Fire Barrier CP-25WB+ Caulk - Apply to a thickness of 5/8" between the pipes and the interior face of the *3M™ Interam™ Ultra PPD-2 or *3M™ Fire Barrier Ultra RC Pack 2.

Note: Design C, apply *3M Fire Barrier CP-25WB+ Caulk, to the annular space in the wood floor membrane or the sole plate.
- Fasteners:** As detailed with 1-1/4" diameter fender washers.

Design A - Concrete: 1/4" x 1-1/4" steel masonry fasteners, wedge anchors or Tapcon®.

Design B - Gypsum: 1/4" diameter hollow dry wall anchors, length as required for substrate thickness

Design C - Wood: 1-1/4" long dry wall screws

Note: metric conversion factor, inches x 25.4 = mm

* Component bearing the Warnock Hersey Certification Mark

This material was extracted and drawn by 3M Fire Protection Products from the 2006 Warnock Hersey Directory of Listed Products

Through Penetrations

Horizontal/Vertical

1, 2 Hour

PHV

3M CANADA CO. – London, On Canada

DESIGN NO. 3M/PHV 120-05

July 26, 2006

SINGLE and MULTIPLE PENETRATIONS, HORIZONTAL OR VERTICAL (FLOOR/CEILING AND WALLS)
TEST PRESSURE DIFFERENTIAL – 2.5 Pa (0.01" OF WATER)

| Penetrant | Pipe Size Diameter | Length Wrapped | Seams | Layers | CAN/ULC-S115 CAN4-S115 | | ASTM-E814 | |
|-----------|--------------------|----------------|------------|--------|---------------------------|---------|-----------|------|
| | | | | | F, FH | FT, FTH | F | T |
| Steel | 4" | 30" | Overlap 3" | 1 | 2 Hr | 1 Hr | 2 Hr | 1 Hr |
| Steel | 4" | 30" | Butt | 2 | 2 Hr | 2 Hr | 2 Hr | 2 Hr |
| Cast Iron | 4" | 30" | Overlap 3" | 1 | 2 Hr | 1 Hr | 2 Hr | 1 Hr |
| Cast Iron | 4" | 30" | Butt | 2 | 2 Hr | 2 Hr | 2 Hr | 2 Hr |
| EMT/RSC | 4" | 30" | Overlap 3" | 1 | 2 Hr | 1 Hr | 2 Hr | 1 Hr |
| EMT/RSC | 4" | 30" | Butt | 2 | 2 Hr | 2 Hr | 2 Hr | 2 Hr |
| Copper | 4" | 36" | Overlap 3" | 1 | 2 Hr | 1 Hr | 2 Hr | 1 Hr |
| Copper | 4" | 36" | Butt | 2 | 2 Hr | 2 Hr | 2 Hr | 2 Hr |
| Steel | Over 4" to 8" | 36" | Overlap 3" | 1 | 2 Hr | 1 Hr | 2 Hr | 1 Hr |
| Steel | Over 4" to 8" | 36" | Butt | 2 | 2 Hr | 2 Hr | 2 Hr | 2 Hr |
| Cast Iron | Over 4" to 8" | 36" | Overlap 3" | 1 | 2 Hr | 1 Hr | 2 Hr | 1 Hr |
| Cast Iron | Over 4" to 8" | 36" | Butt | 2 | 2 Hr | 2 Hr | 2 Hr | 2 Hr |

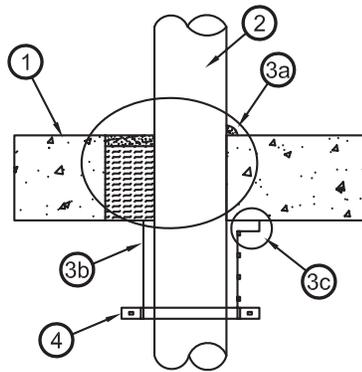

POINT CONTACT PIPES

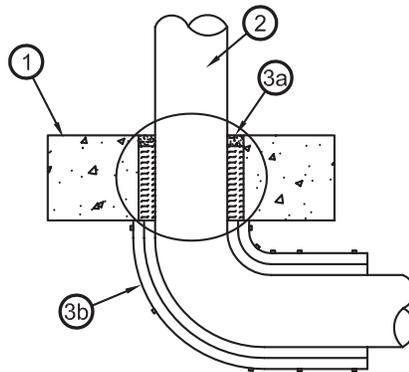

ELBOW

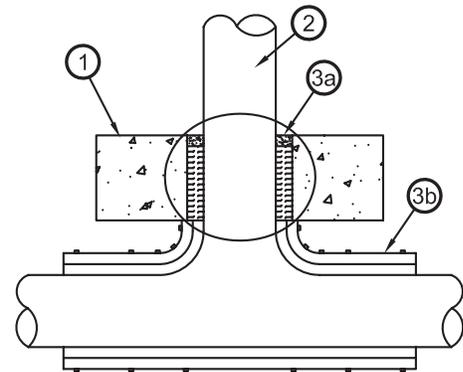

TEE

- Floor or Wall Assembly:** Code conforming 1 hour or 2 hour fire-rated floor or wall assembly, nominal 2-1/2" thick, normal or low density cast concrete, or hollow core concrete and block walls. F rating will equal that of floor or wall fire resistance rating.
- Penetrant:** (See table of ratings) Nominal 8" diameter or smaller, Steel (Schedule 10 and heavier) and Cast Iron pipes, nominal 4" diameter or smaller EMT, Rigid Steel Conduit and Copper Pipe or Tubing.
- Firestop System Component:**

- Firestop Design: Installed a listed 3M™ Fire Protection products design to seal the penetrant. Firestop Forming Material: Substitute listed material with 4 pcf mineral wool, installed to the full thickness of the floor or wall. Apply the listed 3M™ sealant, caulk, putty or spray as detailed in the design.
- *3M™ FireMaster® Duct Wrap is wrapped around the pipe to meet the application layers as detailed in the table. Seams and cut edges are sealed with aluminum foil tape. Secure with 1/2" wide stainless steel banding at 8" intervals, at the fire separation, within 1-1/2" on both sides of longitudinal butt seams and at the end of the wrapped pipe length.
- Point Contact Pipes: *3M™ Firemaster® Duct Wrap must be flared out onto the floor or wall substrate a minimum of 1".

Wrap Methods:

Single Layer: *3M™ FireMaster® Duct Wrap is wrapped around the pipe, transverse seams overlapped 3" longitudinal seams are butted together.

Double Layer: *3M™ FireMaster® Duct Wrap is wrapped around the pipe with one layer forming a butt seam for transverse and longitudinal seams, secure with fiber reinforced tape or similar material. Second layer covers the first layer, with transverse and longitudinal butt seams, offset from those of the first layer.

- (Not Shown) Floor Applications - install the *3M™ FireMaster® Duct Wrap to the underside of the floor.

Wall Applications – install the *3M™ FireMaster® Duct Wrap to both sides of the wall

- Riser Clamp:** Vertical pipe, floor penetration applications that involve a wrapped (item 3b) pipe length that does not include an elbow or tee. To retain the material (Item 3b) in position against the underside of the floor (to prevent slippage or sag), a steel Riser Clamp is secured to the pipe at the end point of the material (Item 3b) wrapped length of pipe.

Note: Metric conversion factor, inches x 25.4 = mm.

*Components bearing the Warnock Hersey Certification Mark.

This material was extracted and drawn by 3M Fire Protection Products from the 2006 Warnock Hersey Directory of Listed Products

| Penetrant | Pipe Size Diameter | Length Wrapped | Seams | Layers | CAN/ULC-S115 CAN4-S115 | | ASTM-E814 | |
|-----------|--------------------|----------------|------------|--------|---------------------------|---------|-----------|------|
| | | | | | F, FH | FT, FTH | F | T |
| Steel | 4" | 30" | Overlap 3" | 1 | 2 Hr | 1 Hr | 2 Hr | 1 Hr |
| Steel | 4" | 30" | Butt | 2 | 2 Hr | 2 Hr | 2 Hr | 2 Hr |
| Cast Iron | 4" | 30" | Overlap 3" | 1 | 2 Hr | 1 Hr | 2 Hr | 1 Hr |
| Cast Iron | 4" | 30" | Butt | 2 | 2 Hr | 2 Hr | 2 Hr | 2 Hr |
| EMT/RSC | 4" | 30" | Overlap 3" | 1 | 2 Hr | 1 Hr | 2 Hr | 1 Hr |
| EMT/RSC | 4" | 30" | Butt | 2 | 2 Hr | 2 Hr | 2 Hr | 2 Hr |
| Copper | 4" | 36" | Overlap 3" | 1 | 2 Hr | 1 Hr | 2 Hr | 1 Hr |
| Copper | 4" | 36" | Butt | 2 | 2 Hr | 2 Hr | 2 Hr | 2 Hr |
| Steel | Over 4" to 8" | 36" | Overlap 3" | 1 | 2 Hr | 1 Hr | 2 Hr | 1 Hr |
| Steel | Over 4" to 8" | 36" | Butt | 2 | 2 Hr | 2 Hr | 2 Hr | 2 Hr |
| Cast Iron | Over 4" to 8" | 36" | Overlap 3" | 1 | 2 Hr | 1 Hr | 2 Hr | 1 Hr |
| Cast Iron | Over 4" to 8" | 36" | Butt | 2 | 2 Hr | 2 Hr | 2 Hr | 2 Hr |

⑤ THREE SIDED SYSTEM

⑥ TWO SIDED SYSTEM

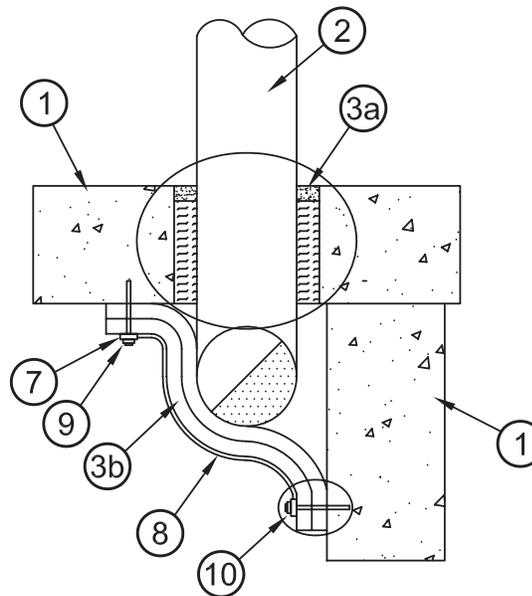
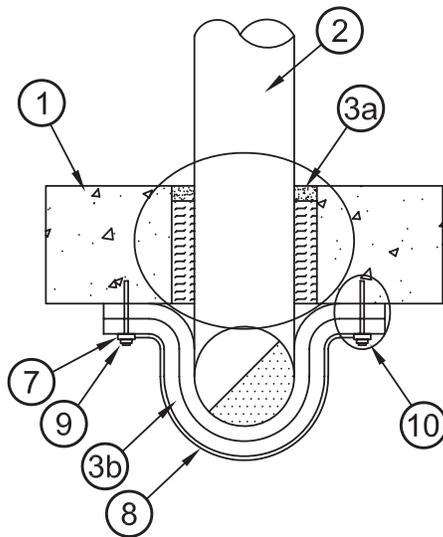

- 1. Floor or Wall Assembly:** Code conforming 1 or 2 hour fire-rated floor or wall assembly, nominal 2-1/2" thick, normal or low density cast concrete, or hollow core concrete. F rating will equal that of floor or wall fire resistance rating.
- 2. Penetrant:** (See table of ratings) Nominal 8" diameter or smaller Steel (Schedule 10 and heavier) or Cast Iron pipe, nominal 4" diameter EMT, Rigid Steel Conduit and Copper Pipe or Tubing.
- 3. Firestop System Components:**
 - Firestop Design: Installed a listed 3M™ Fire Protection Product design to seal the penetrant. Firestop Forming Material: Substitute listed material with 4 pcf mineral wool, installed to the full thickness of the floor or wall. Apply the listed 3M™ sealant, caulk, putty or spray as detailed in the design. fl
 - *3M™ FireMaster® Duct Wrap is wrapped in a "U" shape around the pipe and attached to the substrate as detailed in Items 5 and 6 to meet the application layers as detailed in the table, seams and cut edges are sealed with aluminum foil tape, secure with 1/2" wide stainless steel banding (Item 8) at " intervals, at the fire separation and the end of the wrap length of pipe.
 - (Not Shown) At the wrapped end point, *3M™ FireMaster® Duct Wrap is positioned into the space between the concrete slab and the pipe to fill all void spaces to a depth of 3".
 - (Not Shown) Floor Applications - install the *3M™ FireMaster® Duct Wrap to the underside of the floor.
Wall Applications – install the *3M™ FireMaster® Duct Wrap to both sides of the wall

Design No. PHV 120-06 *continued*

Through Penetrations

Horizontal/Vertical

2 Hour

PHV

4. **Wrap Methods:**

- a) Single Layer (Not shown): *3M™ FireMaster® Duct Wrap is wrapped in a “U” shape around the pipe, longitudinal seams overlapped 3”.
- b) Double Layer: *3M™ FireMaster® Duct Wrap is wrapped in a “U” shape around the pipe, butt longitudinal seams on both layers. Exterior layer seams are offset from those of the inner layer seams.

- 5. **Three-Sided Wrap Method:** *3M™ FireMaster® Duct Wrap is wrapped around the pipe such that a minimum flare of 3” (Item 10) is attached to the substrate, secured with a Clamping Plate (Item 7) to the underside of the floor slab or wall on both sides of the pipe.
- 6. **Two-Sided Wrap Method:** *3M™ FireMaster® Duct Wrap is wrapped around the pipe such that a minimum overlap of 3” (Item 10) onto the substrate, is secured with a Clamping Plate (Item 7) to the underside of the floor slab and wall.
- 7. **Clamping Plate:** Minimum 1-1/2" x 3/16" thick steel plate with pre-drilled nominal 1/4" diameter holes at 8" o.c. used to clamp the wrap material against the bottom of the floor slab and surface of the wall. Fasten stainless steel banding (Item 8) to the clamping plates with tails that will permit mating at the mid point of the pipe, prior to securing to substrate. Secure the clamping plate with steel masonry anchors (Item 9) or Tapcon Fasteners (Item 9) passing through the *3M™ FireMaster® Duct Wrap.

Note: Metric conversion factor, inches x 25.4 = mm.
*Component bearing the Warnock Hersey Certification Mark.

This material was extracted and drawn by 3M Fire Protection Products from the 2006 Warnock Hersey Directory of Listed Products

July 26, 2006

HORIZONTAL (FLOOR); RATINGS: SEE BELOW; OPENING SIZE: SEE CHART (ITEM 3b)
TEST PRESSURE DIFFERENTIAL – 50 Pa (0.20" OF WATER)

| Penetrant | Size | DESIGN A CAN/ULC-S115 | | DESIGN B CAN/ULC-S115 | |
|------------|-------------|--------------------------|----------|--------------------------|--------|
| | | F/FH | FT/FTH | F/FH | FT/FTH |
| PVC | 1-1/2" - 4" | 2 Hr | 1-1/2 Hr | 2 Hr | 2 Hr |
| System XFR | 1-1/2" - 4" | 2 Hr | 1-1/2 Hr | 2 Hr | 2 Hr |

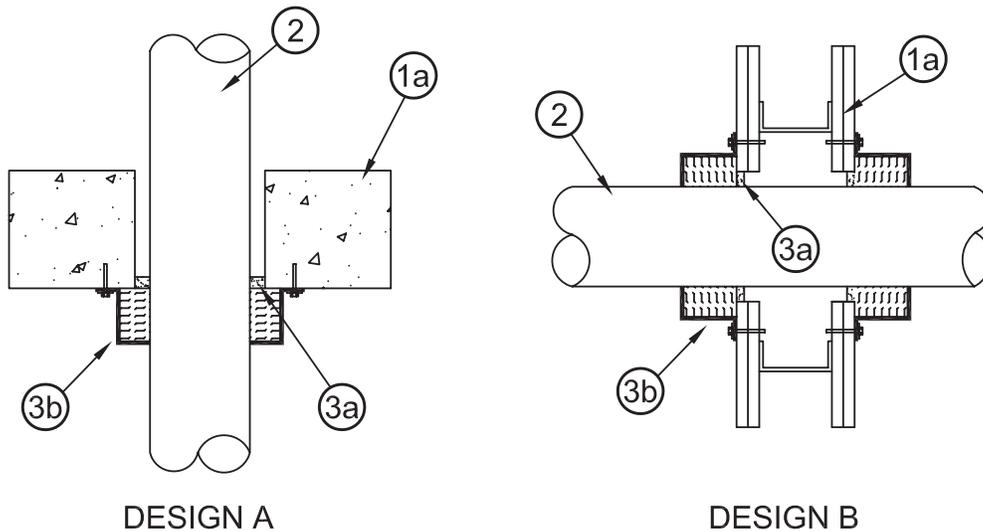

Design A

- Floor or Wall Assembly:** Code conforming 2 hour fire-rated floor or wall assembly, nominal 4-1/2" thick, normal or low density cast concrete or hollow core concrete. Wall may also be constructed of nominal 8" thick concrete blocks (filled or unfilled).

Design B

- Wall Assembly:** Code conforming 2 Hour fire-rated wall, metal or wood framed gypsum wallboard, wall assembly.
- Penetrant:** (See also table of ratings) Nominal 4" diameter, Schedule, 40, PVC and System XFR pipes, used for DWV (Drain, Waste and Vent) or Closed (Process and Supply) pipe systems, ratings achieved will equal that of wall assembly.
- Firestop System Components:**
 - Sealant: *3M™ Fire Barrier CP-25WB+ Caulk, *3M™ Fire Barrier IC 15WB+ Sealant or *3M™ FireDam 150+ Caulk, apply a 1/4" thickness of sealant to fill the annular space at the pipe penetration, prior to the installation of the firestop device (Item 3b).
 - *3M™ Ultra RC Pack or *3M™ Interam™ Ultra PPD, device to be installed on underside of floors and both sides of walls and latched around pipe.

Anchors

Masonry: Secure firestop device with 1/4" diameter by 1-1/4" long steel anchors, Tapcon® or equalvalant fasteners in conjunction with 1-1/4" diameter, steel fender washers. Gypsum Wallboard: Secure firestop device with 1/4" diameter, hollow dry wall anchors or steel toggle bolts in conjunction with 1-1/4" diameter, steel fender washers.

| Pipe ID | Max. Opening | *3M™ Ultra Rc Pack or *3M™ Interam™ Ultra PPD | Ultra GS Wrap Layers | Fasteners |
|---------|--------------|---|----------------------|-----------|
| 1-1/2" | 2-1/2" | 2 | 1 | 2 |
| 2" | 3" | 2 | 1 | 2 |
| 3" | 4" | 3 | 2 | 3 |
| 4" | 5" | 4 | 3 | 4 |

Alternate (not shown)

Wrap Strip: *3M™ Interam™ Ultra GS Wrap Strip, nominal 1/8" thick intumescent material supplied in 2" wide strips. Wrap strip is tightly wrapped around pipe with continuous layers and butted tightly against floor or wall surface. Wrap strip layers temporarily held in position using aluminum foil tape, steel wire tie, or equivalent

Steel Collar: *3M™ Fire Barrier RC-1 Collar, nominal 2" wide with 1-1/4" by 2" anchor tabs and minimum 1/2" long tabs to retain wrap strip layers. Steel collar, with anchor tabs bent outward 90, wrapped tightly over wrap strip layers with 1" overlap at seam. Anchor tabs to be pressed tightly against wall surfaces, and collar to be compressed around wrap strip layers, secure with 1/2" wide stainless steel hose clamp at the middle of collar. Collar to be secured to floor or wall surfaces as detailed in (Item 3b).

Note: Metric conversion factor, inches x 25.4 = mm.

*Components bearing the Warnock Hersey Certification Mark.

This material was extracted and drawn by 3M Fire Protection Products from the 2006 Warnock Hersey Directory of Listed Products

3M CANADA CO. – London, On Canada

DESIGN NO. 3M/PHV 120-08

May 12, 2007

HORIZONTAL OR VERTICAL (FLOOR OR WALL), RATINGS – SEE BELOW, HOLE SIZE – SEE ITEM 3
TEST PRESSURE DIFFERENTIAL – 50 Pa (0.20" OF WATER)

| Penetrant | Max. Pipe ID | CAN/ULC-S115 F, FH, FT, FTH |
|-----------------|--------------|--------------------------------|
| PVC | 2" | 2 Hr |
| ccABS | 3" | 2 Hr |
| ABS | 3" | 2 Hr |
| PVC - Thin Wall | 2" | 2 Hr |

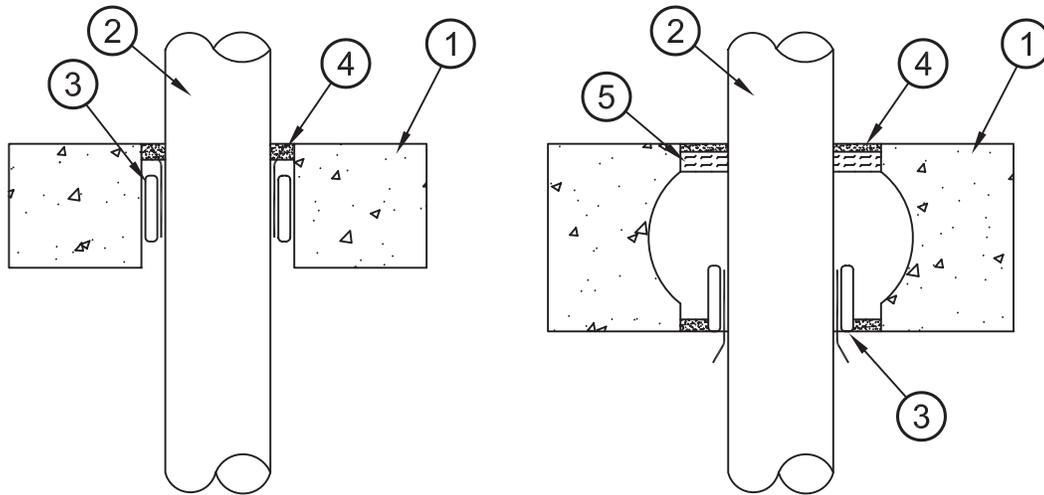

Hollow Core Concrete Floor Applications

- Floor or Wall Assembly:** Code conforming 2 hour fire-rated floor or wall assembly, nominal 4-1/2" thickness, normal or low density cast concrete, or hollow core concrete. Wall may also be constructed of nominal 8" thick concrete blocks (filled or unfilled).
- Penetrant:** (See table of ratings) Schedule 40, ccABS, ABS, PVC pipes for use in DWV (Drain, Waste and Vent) or Closed (Process and Supply) piping systems and PVC-Thin Wall Vacuum Tubing (nominal 2" diameter), ratings achieved will equal that of floor or wall assembly.
- Firestop System Components:** * 3M™ FireStrap™: Install within opening, recessed 1-1/4" from either surface for solid concrete floor applications, according to the manufacturers instructions. For Hollow Core Concrete install on the underside, flush with the bottom surface, according to the manufacturers instructions. For Walls install firestop system flush to the surface on both sides. To reduce hole size to the size listed, back fill with *3M™ Fire Barrier Mortar

Use 3M™ Firestrap™ 1-1/2" for PVC - Thin Wall Vacuum Tubing (nominal 2" diameter).

| Pipe ID | Hole Size |
|---------|-----------|
| 1-1/2" | 2-1/2" |
| 2" | 3" |
| 3" | 4-1/2" |

- Sealant:** *3M™ Fire Barrier CP-25WB+ Caulk, *3M™ Fire Barrier IC 15WB+ Sealant or *3M™ FireDam 150+ Caulk, applied to 1/2" thickness flush with the floor or wall surface. Firestop System is applied to both sides for wall applications.
- Forming Material:** Minimum 1" thickness of mineral wool, 4 pcf, tightly packed around the pipe, recessed 1/2" from the floor or wall surface.

Note: Metric conversion factor, inches x 25.4 = mm.

*Components bearing the Warnock Hersey Certification Mark.

This material was extracted and drawn by 3M Fire Protection Products from the 2006 Warnock Hersey Directory of Listed Products

3M CANADA CO. – London, On Canada

DESIGN NO. 3M/PHV 120-09

July 26, 2006

HORIZONTAL or VERTICAL (FLOOR or WALL)

TEST PRESSURE DIFFERENTIAL – 2.5 Pa (0.01 in. of water)

| Penetrant | | | | CAN/ULC-S115 CAN4-S115 | | ASTM-E814 | |
|-----------------------|------------|---|---------------------------------|---------------------------|----------|---------------|----------|
| Item | Type | Size | Pipe Insulation Mineral Wool | F, FH | FT, FTH | F | T |
| Cable Tray | Steel | 36" x 4" | - | 2 Hr | 0 Hr | 2 Hr | 0 Hr |
| Cable Tray | Aluminum | 36" x 4" | - | 2 Hr | 0 Hr | 2 Hr | 0 Hr |
| Sleeve | PVC | 4" Diameter | - | 2 Hr | 1-1/2 Hr | 2 Hr | 1-1/2 Hr |
| Sleeve | PE | 2" Diameter | - | 2 Hr | 0 Hr | 2 Hr | 0 Hr |
| Sleeve | EMT | 4" Diameter | - | 2 Hr | 0 Hr | 2 Hr | 0 Hr |
| Pipe | Steel | 16" Diameter | - | 2 Hr | 0 Hr | 2 Hr | 0 Hr |
| Pipe | Iron | 16" Diameter | - | 2 Hr | 0 Hr | 2 Hr | 0 Hr |
| Pipe | Copper | 4" Diameter | - | 2 Hr | 0 Hr | 2 Hr | 0 Hr |
| Insulated Pipe | Steel | 16" Diameter | 1-1/2" | 2 Hr | 2 Hr | 2 Hr | 2 Hr |
| Insulated Pipe | Iron | 16" Diameter | 1-1/2" | 2 Hr | 2 Hr | 2 Hr | 2 Hr |
| Insulated Pipe | Copper | 4" Diameter | 1-1/2" | 2 Hr | 2 Hr | 2 Hr | 2 Hr |
| Conduit | EMT | 4" Diameter | - | 2 Hr | 0 Hr | 2 Hr | 0 Hr |
| Conduit | Flex Metal | 4" Diameter | - | 2 Hr | 0 Hr | 2 Hr <td 0 Hr | |
| MI Cable | Copper | 16 AWG-500 KCMIL | - | 2 Hr | 0 Hr | 2 Hr | 2 Hr |
| U-Channel Supports | Steel | 1-5/8" x 3-1/4" Max | - | 2 Hr | 1 Hr | 2 Hr | 2 Hr |
| No Penetrant | Blank | 6" x 10" Rectangular or 10" Diameter | - | 2 Hr | 2 Hr | 2 Hr | 2 Hr |

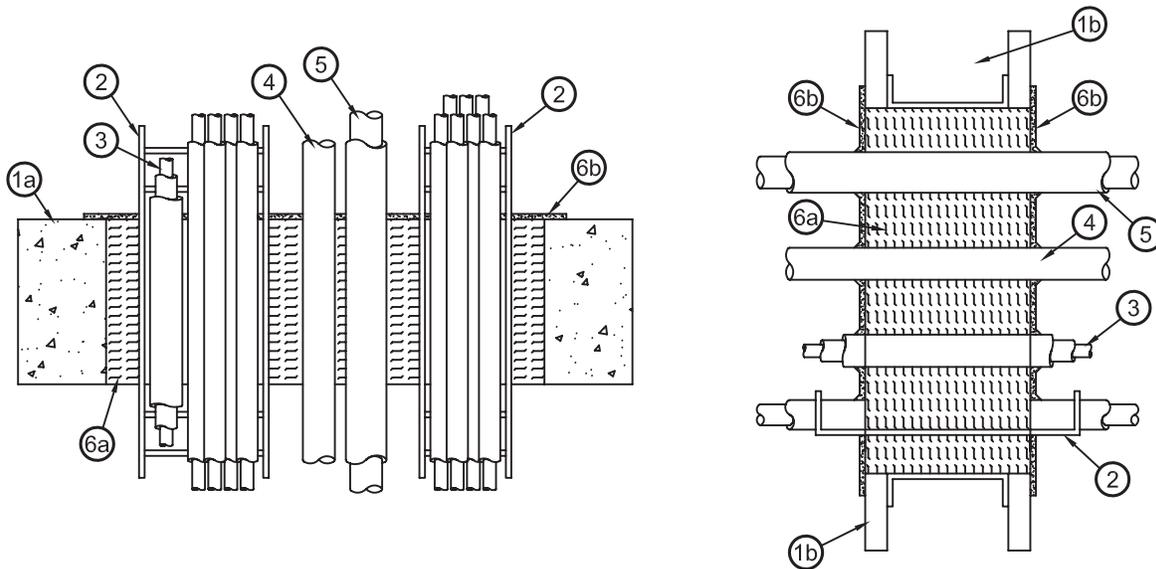

1. Floor or Wall Assembly:

- 1a. **Concrete** – Floor or wall, minimum depth or thickness as necessary for required rating of fire separation but not less than 4-1/2", normal-density or lightweight concrete. Wall may also be constructed of nominal 8" thick concrete blocks. For openings in concrete block wall, concrete or mortar shall be used to create a solid surround to the opening. The penetrant or penetrants are to be installed a minimum 3/4" to a maximum 18" from the periphery of the opening and 1/2" apart, PVC and ENT Sleeves spaced 1" apart, and cable trays as noted.

Opening Size: Maximum 24 square feet with maximum dimension of 8 ft.

- 1b. **Gypsum** – Code conforming 1 or 2 HR rated wall, nominal 2" x 4" steel / wood framed gypsum wallboard wall assembly. Stud framing to create a solid surround to the opening. The penetrant or penetrants are to be installed a minimum 3/4" to a maximum 18" from the periphery of the opening and 1/2" apart, PVC and ENT Sleeves spaced 1" apart, and cable trays as noted.

Opening Size – Maximum 9 sq. feet with maximum dimension of 3 ft.

Penetrants:

Any single or multiple combinations of the detailed penetrants may be installed in the opening. The spacing between penetrants and the opening must be maintained as detailed.

Blank Openings, pack with mineral wool as detailed in (Item 6a), flush with the surface of the floor or wall and apply 3M™ FireDam™ Spray 200 as detailed in (Item 6b)

Through Penetrations

Horizontal/Vertical

2 Hour

PHV

Design No. PHV 120-09 *continued*

Through Penetrations

Horizontal/Vertical

2 Hour

PHV

2. **Cable Trays:**

Maximum 36" wide steel, aluminum or stainless steel cable tray solid back or ladder type. Maximum fill 40% by area (100% visual fill). Control, communication or power cables. Cable trays to be spaced 6" apart.

T-Rating - 0 HR or 1-1/2 HR with 12 AWG cables.

Cables:

(Not Shown) Communication or power cables, Armored Cable or Metal Clad Cable, or Mineral Insulated Cable, single or in bundles and installed with rigid support on both sides of opening.

3. **Sleeve:**

PVC or ENT Sleeve – Nominal 4" diameter (or smaller) to contain control, communication or power cables or left blank.

Corrugated Wall Sleeve – Nominal 2" diameter (or smaller) ENT (PVC) or Polyethylene (PE) tubing, to contain control, communication or power cables or left blank. *3M™ Moldable Putty+ installed within the end of the sleeve, around and between the cables or cable bundle, to a 1" thickness, applied over mineral wool packed to a thickness of 3-1/2" for 4-1/2" thick concrete floors, 6" for 8" thick block walls, 2-3/4" for 1 hour rated gypsum wallboard assemblies and 4" for 2 hour rated gypsum wallboard assemblies. Apply *3M™ Moldable Putty+ flush to the surface on both sides of wall applications.

T-Rating – 0 HR for ENT Sleeve

T-Rating 1-1/2 HR for PVC Sleeve

4. **Metallic Pipes:**

Steel or Iron Pipe – Nominal 16" diameter (or smaller) Schedule 10 or heavier pipe

Copper Pipe or Tubing – Nominal 4" diameter (or smaller)

Conduit – EMT nominal 4" diameter (or smaller) steel tubing

Flexible Metal Conduit – Nominal 4" diameter (or smaller) jacketed or non-jacketed, steel conduit.

T-Rating – 0 HR.

5. **a. Insulated Metallic Pipes:**

Steel or Iron Pipe – Nominal 16" diameter (or smaller) schedule 10 or heavier

Copper Pipe or Tubing – Nominal 4" diameter (or smaller).

Nominal 1-1/2" thick, mineral wool pipe wrap insulation, to be applied to the pipes, extending a minimum 2" on either side of the fire separation thickness, butting up to glass fiber pipe insulation.

T-Rating is 1 HR or 2 HR dependent upon F-Rating of substrate.

b. U-Channel Steel Supports: May penetrate at angles up to 45 degree from perpendicular.

6. **Firestop Components:**

6a. **Mineral Wool** – minimum 4 pcf density, compressed 33%, minimum 4" depth, applied flush with top of floor or both sides of wall.

6b. ***3M™ FireDam Spray 200; *3M™ Fire Barrier 1000 Silicone Sealant No Sag and *3M™ 1003 Silicone Sealant Self Leveling** – Spray or brush, or pour or caulk over mineral wool, 1/8" wet thickness (1/16" dry thickness) of spray material overlapping onto the floor, wall, and penetrants 1/2". Apply to both sides of wall assemblies.

Note: metric conversion factor, inches x 25.4 = mm

*Component bearing the Warnock Hersey Certification Mark

This material was extracted and drawn by 3M Fire Protection Products from the 2006 Warnock Hersey Directory of Listed Products

July 26, 2006

HORIZONTAL (FLOOR), RATINGS – SEE BELOW, ANNULAR SPACING – 1/4" MAXIMUM
TEST PRESSURE DIFFERENTIAL – 50 Pa (0.20" OF WATER)

| Penetrant/Coupling | Pipe Size/ Coupling | DESIGN A | | DESIGN B & C | |
|--------------------|------------------------|--------------------------------|-------------------|--------------------------------|-------------------|
| | | CAN/ULC-S115 F, FH, FT, FTH | ASTM-E814 F, T | CAN/ULC-S115 F, FH, FT, FTH | ASTM-E814 F, T |
| ccPVC | 1-1/2" - 4" | 2 Hr | 2 Hr | 1 & 2 Hr | 1 & 2 Hr |
| PVC | 1-1/2" - 4" | 2 Hr | 2 Hr | 1 & 2 Hr | 1 & 2 Hr |
| CPVC | 1-1/2" - 4" | 2 Hr | 2 Hr | 1 & 2 Hr | 1 & 2 Hr |
| ccABS | 1-1/2" - 4" | 2 Hr | 2 Hr | 1 & 2 Hr | 1 & 2 Hr |
| ABS | 1-1/2" - 4" | 2 Hr | 2 Hr | 1 & 2 Hr | 1 & 2 Hr |
| FRPP | 1-1/2" - 4" | 2 Hr | 2 Hr | 1 & 2 Hr | 1 & 2 Hr |

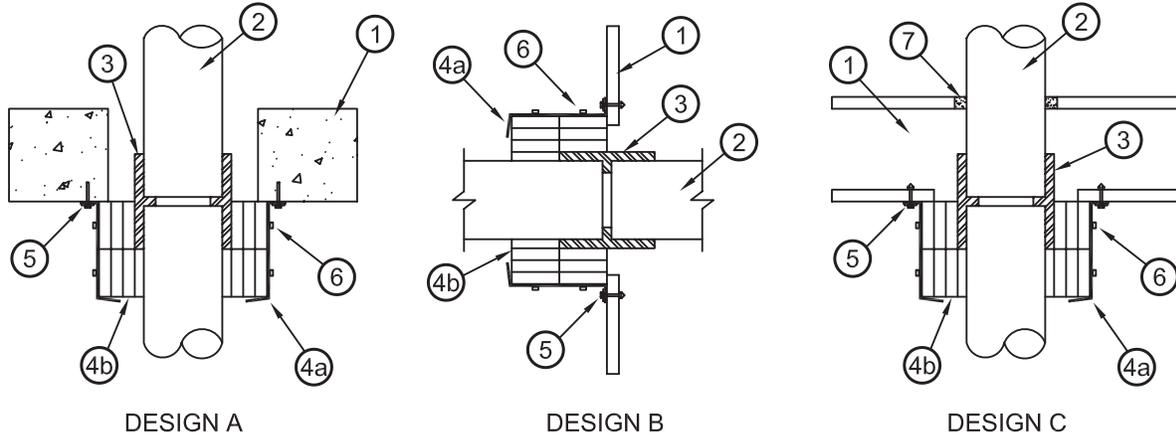

1. Floor or Wall Assembly:

Design A: Code conforming 2 hour fire-rated floor or wall assembly, nominal 2-1/2" thickness, normal or low density cast concrete, hollow core concrete or Q-Deck. Wall may also be constructed of nominal 8" thick concrete blocks (filled or unfilled).

Design B: Code conforming 1 or 2 hour fire-rated wall, nominal 2" x 4" steel/wood framed gypsum wallboard, wall assembly.

Design C: Code conforming 1 or 2 hour fire-rated floor/ceiling assembly, framed with nominal 2" x 10" solid sawn or manufactured wood joists, topping optional (not shown).

2. **Penetrant:** (See table of ratings) Nominal 4" diameter, Schedule 40, ccPVC, PVC, CPVC, ABS, ccABS, and FRPP pipe with couplings for use in DWV (Drain, Waste and Vent) or Closed (Process and Supply) piping systems, ratings achieved will equal that of substrate assembly.
3. **Coupling/Fitting:** Manufactured of a material similar to that of the pipe.
4. **Firestop System Components:**

- a) *3M™ Fire Barrier RC-1 Collar, cut to length 1" larger than OD of wrapped pipe and secured in place with a hose clamp. The second collar mounting tabs are placed under the hose clamp (Item 6) of the first collar and bent over to lock in place.
- b) *3M™ Fire Barrier FS-195+ Wrap Strip wrapped around coupling and pipe with butted seams staggered. Stack: Each stack consists of layers of Wrap Strip (Item 4b) covered with a Collar (Item 4a). The first stack is secured to the substrate with an appropriate fastener (Item 5). The second stack, if required is attached to the first stack by placing the mounting tabs under the hose clamp of the first stack and bending over the mounting tab.

| Pipe ID/Coupling | First Stack - Layers | Second Stack - Layer |
|------------------|----------------------|----------------------|
| 1-1/2" or 2" | 2 | Not Required |
| 3" or 4" | 3 | 4 |

5. **Fasteners:** As detailed with 1-1/4" diameter fender washers.

Design A – Concrete: 1/3" x 1-1/4" steel masonry fasteners, wedge anchors or Tapcon©.

Design B – Gypsum: 1/4" diameter hollow dry wall anchors, length as required for substrate thickness

Design C – Wood: 1-1/4" long dry wall screws.

6. **Hose Clamp:** 1/2" wide stainless steel hose clamp or equivalent, sized appropriately.

7. **Sealant:** *3M™ Fire Barrier CP-25WB+ Caulk, *3M™ Fire Barrier IC 15WB+ Sealant, fill annular space around pipe to 3/4" thickness through wood floor or sole plate (not shown).

CPVC Pipe - use only *3M™ Fire Barrier IC 15WB+ Sealant

Note: metric conversion factor, inches x 25.4 = mm

*Component bearing the Warnock Hersey Certification Mark

This material was extracted and drawn by 3M Fire Protection Products from the 2006 Warnock Hersey Directory of Listed Products

3M CANADA CO. – London, On Canada

DESIGN NO. 3M/PHV 120-11

July 26, 2006

HORIZONTAL OR VERTICAL (FLOOR OR WALL), RATINGS – SEE BELOW, MAXIMUM HOLE SIZE - 1- 1/2" DIAMETER
TEST PRESSURE DIFFERENTIAL – 50 Pa (0.20" OF WATER)

| Design | Penetrant | Pipe Size | CAN/ULC-S115 | | ASTM-E814 | |
|--------|-----------|-----------|--------------|----------|-----------|----------|
| | | | F, FH | FT, FTH | F | T |
| A | PEX | 1" | 2 Hr | 0 Hr | 2 Hr | 0 Hr |
| B | PEX | 1" | 1 & 2 Hr | 0 Hr | 1 & 2 Hr | 0 Hr |
| C | PEX | 1" | 1 & 2 Hr | 1 & 2 Hr | 1 & 2 Hr | 1 & 2 Hr |

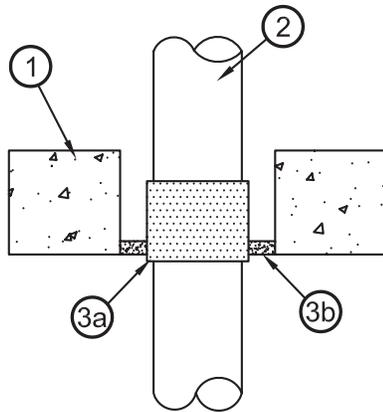

DESIGN A

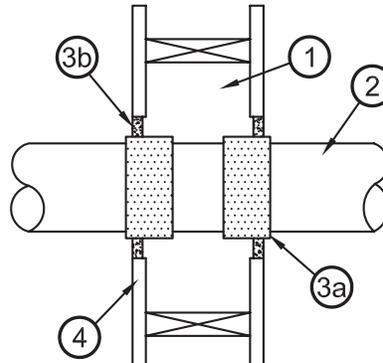

DESIGN B

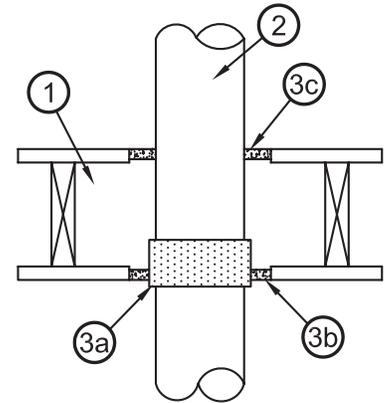

DESIGN C

1. Floor or Wall Assembly:

Design A: Code conforming 2 hour fire-rated floor or wall assembly, minimum 2-1/2" normal or low density cast concrete, hollow core concrete or Q-Deck. Wall may also be constructed of nominal 8" thick concrete blocks (filled or unfilled).

Design B: Code conforming 1 or 2 hour fire-rated wall, nominal 2" x 4" steel/wood framed gypsum wallboard, wall assembly.

Design C: Code conforming 1 or 2 hour fire-rated floor/ceiling assembly, framed with nominal 2" x 10" solid sawn or manufactured wood joists, topping optional (not shown).

2. Penetrant: (See table of ratings) One nominal 1" diameter (or smaller) PEX Pipe installed within the opening, for use in Closed (Process and Supply) piping systems, ratings achieved will equal that of substrate assembly.

3. Firestop System Components:

- *3M™ Interam™ Ultra GS Strip installed within the opening, wrapped tightly around the pipe with butted seam, 1/4" of the wrap strip projects beyond the fire separation plane. A 3" wide adhesive backed aluminum foil tape, cut 1" longer than the wrap strip, is applied to the surface of the wrap strip to secure it to the pipe. System is applied to both sides in wall applications.
- **Caulk or Putty (Optional) - *3M™ Fire Barrier CP-25WB+ Caulk or *3M™ Moldable Putty+ (MPS2), to fill the annular space at the pipe penetration as a smoke seal.
- Caulk or Putty - *3M™ Fire Barrier CP-25WB+ Caulk or *3M™ MPS2, to fill the annular space at the pipe penetration through the wood floor membrane.

Note: Metric conversion factor, inches x 25.4 = mm.

*Components bearing the Warnock Hersey Certification Mark.

**May be used, however, is not required to achieve stated ratings.

This material was extracted and drawn by 3M Fire Protection Products from the 2006 Warnock Hersey Directory of Listed Products

3M CANADA CO. – London, On Canada

DESIGN NO. 3M/PHV 120-12

July 26, 2006

HORIZONTAL or VERTICAL (FLOOR or WALL)

RATINGS and OPENING DIAMETER – SEE TABLE

TEST PRESSURE DIFFERENTIAL – 50 Pa (0.20 in. of water)

| Penetrant | Maximum Pipe ID | Maximum Opening Diameter | Annular Space | ULC-S115-95 CAN/ULC-S115 | |
|-------------------|-----------------|--------------------------|---------------|-----------------------------|---------|
| | | | | F, FH | FT, FTH |
| PVC | 2" | 3" | 1/4" - 3/4" | 2 Hr | 1/3 Hr |
| Kitec® - PE-AL-PE | 1" | 2-1/2" | 1/2" - 3/4" | 2 Hr | 3/4 Hr |
| PEX | 1" | 2" | 1/4" - 3/4" | 2 Hr | 1/4 Hr |

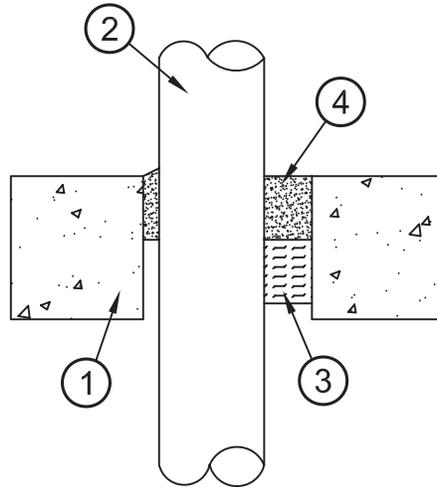

1. **Floor or Wall Assembly** – Code conforming 2 Hour fire-rated floor or wall assembly, nominal 4-1/2" thickness, normal or low density cast concrete. Wall may also be constructed of nominal 8" thick concrete blocks (filled or unfilled). Ratings achieved will equal that of floor or wall assembly.
- 1a **Steel Sleeve** (Optional, not shown) – For use with PVC Pipes only, minimum 0.028 wall thickness (or heavier) galvanized steel sleeve cast or grouted into floor or wall assembly. Sleeve may extend a maximum of 1/2" beyond either surface of floor or wall assembly.
2. **Penetrant** – (See also table of ratings) Schedule 40, PVC pipe for use in DWV (Drain, Waste and Vent) or Closed (Process and Supply) piping systems. PEX and Kitec® – PE-AL-PE, pipes for use in Closed (Process and Supply) piping systems.

Firestop System Components:

3. **Forming Material** – Mineral wool, 2" thickness, 4pcf, tightly packed around the penetrant recessed from the floor or wall surface.
4. **Sealant** –
 - PVC Pipes** – *3M™ Fire Barrier IC 15WB+ Sealant apply to 2" thickness, within the annular space around the penetrant, over the forming material, flush with the floor or wall surface.
 - Kitec® (PE-AL-PE) and PEX Pipes** – *3M™ Fire Barrier IC 15WB+ Sealant apply to 1" thickness, within the annular space around the penetrant, over the forming material, flush with the floor or wall surface.
 For wall applications apply firestop system to both surfaces.

Note: metric conversion factor, inches x 25.4 = mm

*Component bearing the Warnock Hersey Certification Mark

This material was extracted and drawn by 3M Fire Protection Products from the 2006 Warnock Hersey Directory of Listed Products

Through Penetrations

Horizontal/Vertical

2 Hour

PHV

3M CANADA CO. – London, On Canada

DESIGN NO. 3M/PHV 120-13

July 27, 2006

HORIZONTAL or VERTICAL (FLOOR or WALL)

RATINGS – See Below

HOLE SIZE – See Item 3

TEST PRESSURE DIFFERENTIAL – 2.5 Pa (0.01 in. of water) MINIMUM

| Penetrant | Design | Maximum ENT Diameter | ULC-S115-95 CAN/ULC-S115 | | ASTM-E814 | |
|-------------------------------------|--------|----------------------|-----------------------------|---------|-----------|------|
| | | | F, FH | FT, FTH | F | T |
| Electrical Nonmetallic Tubing (ENT) | A | 1" | 2 Hr | 2 Hr | 2 Hr | 2 Hr |
| Electrical Nonmetallic Tubing (ENT) | B | 2" | 2 Hr | 2 Hr | 2 Hr | 2 Hr |
| Electrical Nonmetallic Tubing (ENT) | C | 1" | 1 Hr | 0 Hr | 1 Hr | 0 Hr |
| Electrical Nonmetallic Tubing (ENT) | C | 1" | 2 Hr | 0 Hr | 2 Hr | 0 Hr |

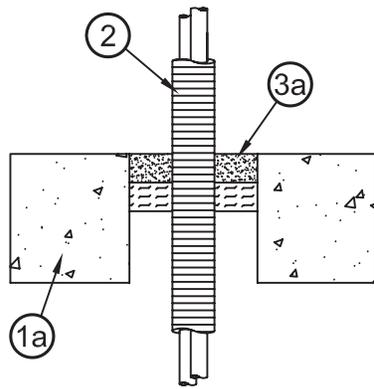

Design A

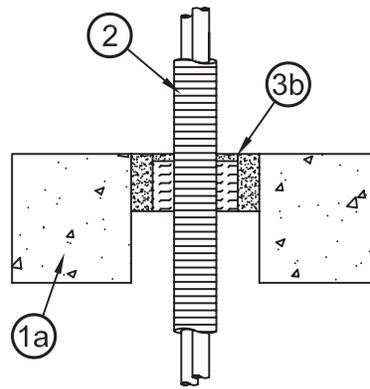

Design B

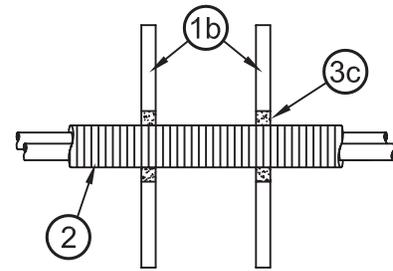

Design C

1. Floor or Wall Assembly:

Design A and B: Code conforming 2 HR rated floor or wall assembly, nominal 4-1/2" minimum normal or low density cast concrete, or hollow core concrete. Wall may also be constructed of nominal 8" thick concrete blocks (filled or unfilled)

Design C: Code conforming 1 or 2 HR rated wall, nominal 2" x 4" steel/wood framed gypsum wallboard, wall assembly.

2. Penetrant – (See also table of ratings) Electrical Nonmetallic Tubing (ENT) - Corline®, PVC corrugated wall tubing, ratings achieved will equal that of floor or wall assembly.

3. Firestop System Components:

Design A: apply 1" thickness of *3M™ Fire Barrier CP-25WB+ Caulk over 1" thickness Mineral Wool 4pcf, forming material .

Design B: apply 2 layers of *3M™ Fire Barrier FS-195+ Wrap Strip around tubing, secure with reinforced fiber tape or tie wire, fill remaining annular space to a 2" depth with * 3M™ Fire Barrier CP-25WB+ Caulk.

Design C: apply *3M™ Fire Barrier CP-25WB+ Caulk to seal annular space, for 1 hour assemblies 5/8" thickness and for 2 hour assemblies 1-1/4" thickness.

| | Pipe ID | Annular Space |
|----------|-------------|---------------|
| Design A | 1/2" - 1" | 1/2" - 5/8" |
| Design B | 1-1/2" - 2" | 1" |
| Design C | 1" | 0" - 7/8" |

Wall Assemblies – apply firestop detail to both sides of wall.

Note: metric conversion factor, inches x 25.4 = mm

*Component bearing the Warnock Hersey Certification Mark

This material was extracted and drawn by 3M Fire Protection Products from the 2006 Warnock Hersey Directory of Listed Products

3M CANADA CO. – London, On Canada

DESIGN NO. 3M/PHV 120-14

July 27, 2006

HORIZONTAL (FLOOR) or VERTICAL (WALL)
 RATINGS and OPENING DIAMETER – SEE TABLE BELOW
 TEST PRESSURE DIFFERENTIAL – 50 Pa (0.20 in. of water)

| Penetrant | Maximum Pipe ID | Maximum Opening Size | Annular Space | CAN/ULC-S115-95 | |
|-----------|-----------------|----------------------|---------------|-----------------|---------|
| | | | | F, FH | FT, FTH |
| Kitec | 1-3/16" | 2" | 3/8" | 90 MIN | 30 MIN |

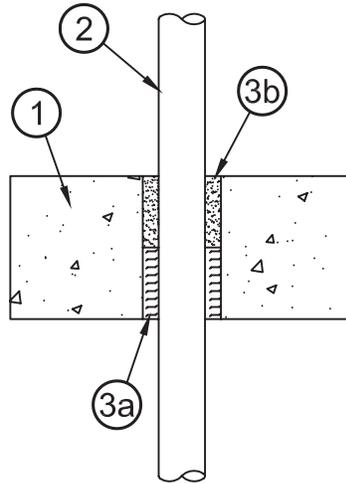

1. **Floor or Wall Assembly:** Code conforming 2 hour fire-rated floor or wall assembly; minimum 4-1/2" concrete thickness, reinforced lightweight or normal weight concrete for floors, minimum 6-1/2" concrete thickness for walls. Ratings achieved will equal that of floor or wall assembly.
2. **Penetrant:** (See table above) 1-3/16" Kitec process and supply pipe.
3. **Firestop System Components:**
 - a) Firestop Forming Material – 4 pcf mineral wool, insulated to a thickness of 2-1/2", spaced to allow for 2" sealant thickness on top of forming for floors, or on each side of forming for walls.
 - b) Firestop Sealant – *3M™ Fire Barrier IC 15WB+ Sealant; fill annular space around pipe to a depth of 2". For wall penetrations sealant is required on both sides of wall.

Note: metric conversion factor, inches x 25.4 = mm

*Component bearing the Warnock Hersey Certification Mark

This material was extracted and drawn by 3M Fire Protection Products from the 2006 Warnock Hersey Directory of Listed Products

Through Penetrations

Horizontal/Vertical

90 Minute

PHV

3M CANADA CO. – London, On Canada

DESIGN NO. 3M/PHV 120-15

July 26, 2006

HORIZONTAL OR VERTICAL (FLOOR OR WALL), RATINGS – SEE BELOW, ANNULAR SPACING - 1/2" MAXIMUM
TEST PRESSURE DIFFERENTIAL – 50 Pa (0.20" OF WATER)

| Penetrant | Pipe Size Max. | CAN/ULC-S115 F, FH, FT, FTH | ASTM-E814 F, T |
|-----------|-------------------|--------------------------------|-------------------|
| PVC | 8" | 2 Hr | 2 Hr |

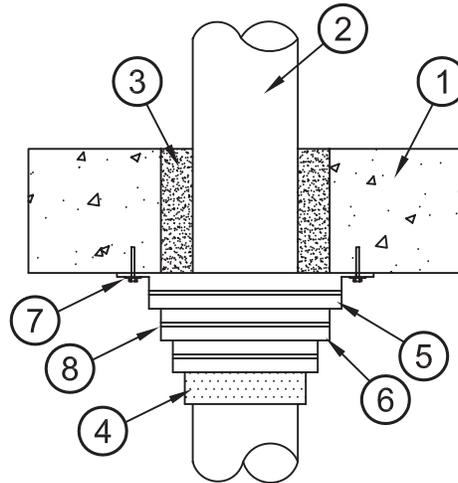

- Floor or Wall Assembly:** Code conforming 2 hour fire-rated floor or wall assembly, nominal 4-1/2" thick, normal or low density cast concrete, or hollow core concrete. Wall may also be constructed of nominal 8" thick concrete blocks (filled or unfilled).
- Penetrant:** (See table of ratings) Schedule 40, nominal 8" diameter PVC pipe for use in DWV (Drain, Waste and Vent) or Closed (Process and Supply) piping systems, ratings achieved will equal that of floor or wall assembly.

Firestop System Components:

- Non-Shrink Grout:** The annular space between the pipe and the opening shall be filled with a non-shrink grout to the fill thickness of the substrate.
- Aluminum Foil Tape:** Cover the pipe for an 8" length beginning at the substrate with an adhesive backed aluminum foil tape.
- *3M™ Fire Barrier FS-195+ Wrap Strip:** (Not shown) Three stacks formed in a "telescope" fashion of nominal 2" wide wrap strips, wrapped around the pipe with butted seams in successive layers staggered. The first stack is butted to the substrate consisting of five layers, the middle stack four layers and bottom stack three layers of wrap strip. Wrap strips are held in position using aluminum foil tape, filament tape, steel wire tie or equivalent.
- *3M™ Fire Barrier RC-1 Collar:** Wrap the steel collar around the top stack of wrap strip with a 1" overlap seam. The anchor tabs are bent outward 90° and secured to the substrate with minimum 1/4" diameter by minimum 1-1/2" long steel expansion bolts or equivalent in conjunction steel fender washers, minimum 1-1/4" diameter (Item 7) in each anchor tab. Secure the steel collars in place with a stainless steel band clamp or hose clamp (Item 8). Each successive stack is covered with a steel collar positioned with the anchor tabs extending under the stainless steel band clamp or hose clamp and bent over to lock it in place. The stainless steel band clamps or hose clamps are mechanically interlocked using steel screws. The bottom fingers of the steel collar are bent 90° towards the pipe.

*3M™ Fire Barrier CP-25WB+ Caulk: (Not shown) Apply a 1/4" bead of caulk around the pipe at the substrate and wrap strip interface.

Note: metric conversion factor, inches x 25.4 = mm

*Component bearing the Warnock Hersey Certification Mark

This material was extracted and drawn by 3M Fire Protection Products from the 2006 Warnock Hersey Directory of Listed Products

3M CANADA CO. – London, On Canada

DESIGN NO. 3M/PHV 120-16

October 02, 2006

HORIZONTAL OR VERTICAL (FLOOR OR WALL), RATINGS – SEE BELOW, ANNULAR SPACE - 0" (POINT CONTACT) TO 1-1/2"

TEST PRESSURE DIFFERENTIAL – 2.5 Pa (0.01" OF WATER)

| Penetrant | Max. Pipe Diameter | Max. Opening Diameter | CAN/ULC-S115 | | ASTM-E814 | |
|-------------|--------------------|-----------------------|--------------|---------|-----------|------|
| | | | F, FH | FT, FTH | F | T |
| Steel Pipe | 4" | 8" | 2 Hr | 2 Hr | 2 Hr | 2 Hr |
| Copper Pipe | 2" | 5" | 2 Hr | 2 Hr | 2 Hr | 2 Hr |

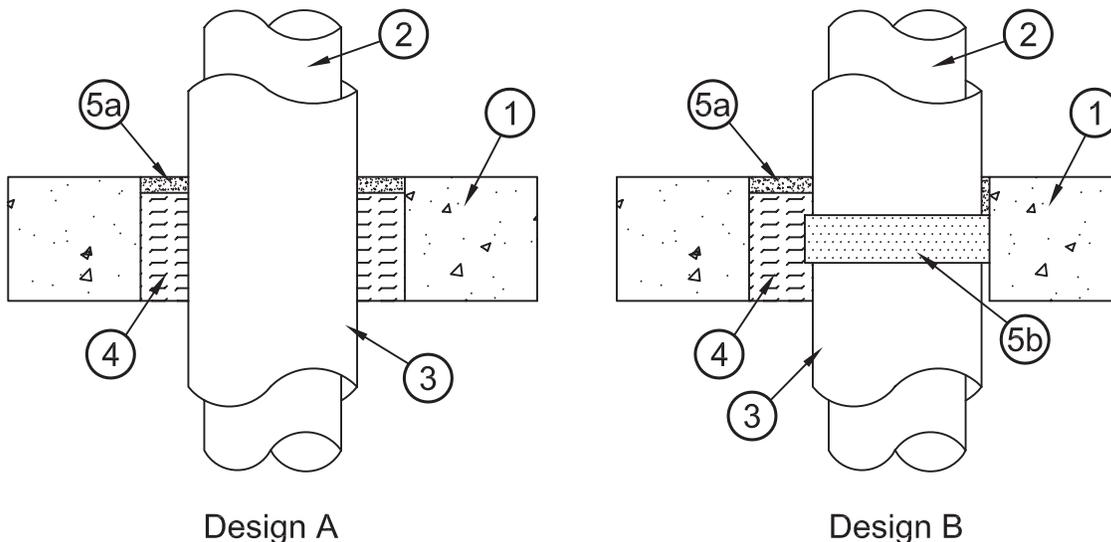

- Floor or Wall Assembly:** Code conforming 2 hour fire-rated floor or wall assembly, nominal 4-1/2" thick, normal or low density cast concrete. Wall may be constructed of nominal 8" thick concrete blocks (filled or unfilled).
- Penetrant:** (See table of ratings) Steel Pipe nominal 4" diameter (or smaller), or Copper Pipe nominal 2" diameter (or smaller).
- Pipe Insulation:** Nominal 1" thick Kookphen® K, rigid phenolic insulation. Ratings achieved will equal that of floor or wall assembly.
- Forming Material:** Minimum 4" thickness of 4 pcf mineral wool batt insulation, compressed and firmly packed into the opening as a permanent form. Material to be recessed 1/2" from the top surface of floor or from both surfaces of wall.
- Firestop System Components:**
Design A: *3M™ Fire Barrier CP-25WB+ Caulk applied over forming material to a minimum depth of 1/2". For wall applications firestop system is applied to both sides.
Design B: *3M™ Fire Barrier Ultra GS Intumescent Wrap Strip taped around the entire perimeter of the insulation (Item 3). Floor applications strip to be centered within the floor thickness. For wall applications wrap strip is recessed 1" from the surface on both sides.

Note: Metric conversion factor, inches x 25.4 = mm.

*Components bearing the Warnock Hersey Certification Mark.

This material was extracted and drawn by 3M Fire Protection Products from the 2006 Warnock Hersey Directory of Listed Products

Through Penetrations

Horizontal/Vertical

2 Hour

PHV

3M CANADA CO. – London, On Canada

DESIGN NO. 3M/PHV 120-17

October 02, 2006

HORIZONTAL / VERTICAL (FLOOR / WALL); RATINGS – SEE TABLE BELOW; HOLE SIZE - SEE ITEM 3
TEST PRESSURE DIFFERENTIAL – 2.5 Pa (0.01" OF WATER)

| Penetrant | Design | Max. Pipe ID | CAN/ULC-S115 F & FH, FT & FTH |
|-----------|--------|--------------|----------------------------------|
| FRPP | A | 3" | 2 Hr |
| FRPP | B | 3" | 2 Hr |
| FRPP | C | 3" | 1 Hr |
| FRPP | C | 3" | 2 Hr |

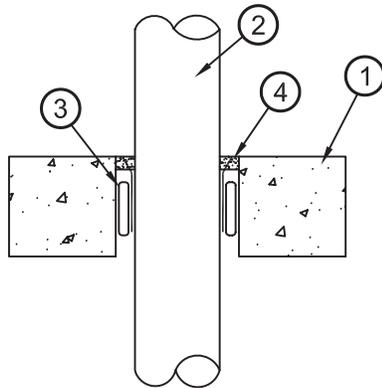

Design A

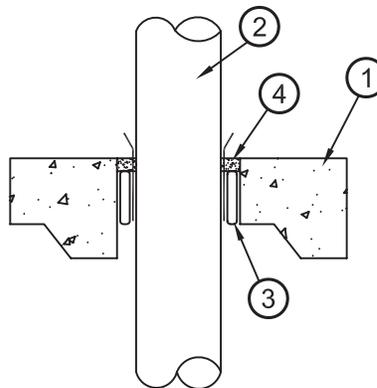

Design B

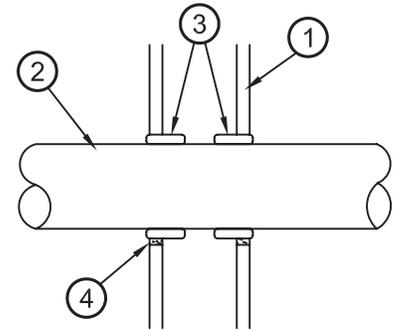

Design C

1. Floor/Wall Assembly:

Design A: Code conforming 2 hour fire-rated floor or wall assembly, nominal 4-1/2" thick, normal or low density cast concrete, or hollow core concrete. Wall may also be constructed of nominal 8" thick concrete blocks (filled or unfilled).

Design B: Code conforming 2 hour fire-rated floor assembly, nominal 2-1/2" concrete or Q Deck or Fluted Deck, normal or low density cast concrete.

Design C: Code conforming 1 or 2 hour fire-rated wall, nominal 2" x 4" steel/wood framed gypsum wallboard, wall assembly.

2. Penetrant (See table above): Schedule 40, FRPP (Fire-Rated Polypropylene Pipe) pipe for use in DWV (Drain, Waste and Vent) or Closed (Process and Supply) piping systems, ratings achieved will equal that of floor/wall assembly.

3. Firestop System Components:

Design A: *3M™ FireStrap™ : Install within opening, recessed 1-1/4" from either surface, according to the manufacturer's instructions. For Walls, apply firestop system to both sides. To reduce the opening diameter to the size listed, backfill with *3M™ Fire Barrier Mortar. Firestop is installed on both sides of the wall.

Design B: *3M™ FireStrap™ : Install within opening 1/2" below the floor surface of the concrete according to the manufacturer's instructions.

Design C: *3M™ FireStrap™ : Install with 1/4" of the firestop exposed outside the surface of the gypsum wall assembly according to the manufacturer's instructions.

| Pipe ID | Opening Size |
|---------|--------------|
| 1-1/2" | 2-1/2" |
| 2" | 3" |
| 3" | 4-1/2" |

4. Sealant: *3M™ Fire Barrier CP-25WB+ Caulk, *3M™ Fire Barrier IC 15WB+ Sealant or *3M™ FireDam 150+ Acrylic Caulk to fill the annular space at the pipe penetration as a smoke seal.

Note: Metric conversion factor, inches x 25.4 = mm.

*Components bearing the Warnock Hersey Certification Mark.

Design conforms to NBC 1995, reference clause 3) of 3.1.5.15 "Combustible Piping Material".

This material was extracted and drawn by 3M Fire Protection Products from the 2006 Warnock Hersey Directory of Listed Products

3M CANADA CO – London, ON Canada

DESIGN NO. 3M/PHV 120-18

October 02, 2006

HORIZONTAL (FLOOR) OR VERTICAL (WALL)

RATINGS: 2 HOURS F, FT, FTH

TESTING STANDARDS: ASTM – E814, ULC-S115-M95

TEST PRESSURE DIFFERENTIAL – 2.5 PA (0.01" OF WATER) MINIMUM

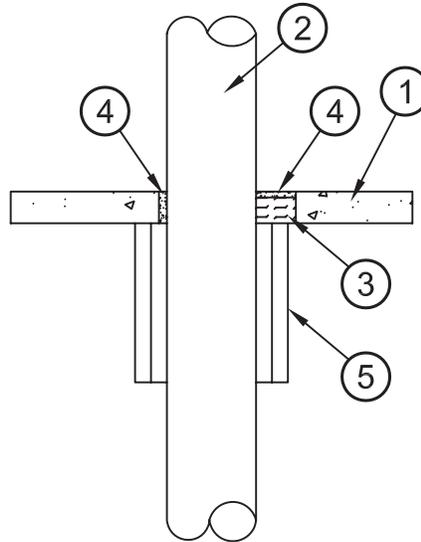

1. **Floor and Wall Assembly** – 2 Hour rated concrete with minimum 4-1/2 in. thickness. Maximum 12 in. hole size.
2. **Penetrating Items** – Maximum 8 in. steel or cast iron Sch 10 or heavier, centered or offset in hole. Annular space: point contact to 3-3/8 in.
3. **Mineral Wool** – Nominal 4 PCF mineral wool insulation tightly packed around the penetrating item to a depth of 4 in. minimum.
4. **Firestop Sealant** – 3/8 in. depth bead of *3M™ Fire Barrier 1000 Silicone Sealant No Sag or *3M™ 1003 Silicone Silicone Sealant Self Leveling installed on the mineral wool. For wall assemblies, 3/8 in. depth of *3M™ Fire Barrier 1000 Silicone Sealant No Sag sealant shall be installed on both sides of the wall assembly.
5. **Pipe Insulation** – To provide a 2 Hour T Rating, pipe shall be wrapped on both sides of a wall assembly on the underside of a floor/ceiling assembly with 2 layers of mineral wool for pipe insulation, 1 in. thickness, foil jacketed insulation for a length of 24 in. Joints shall be staggered and overlapped 2 in., and sealed with aluminum foil tape. The insulation shall be tightly butted to the underside of the slab and secured with stainless steel bands or screw clamps every 8 in. The integrity of the design is not compromised when the pipe penetration includes fittings or clamps, as long as the insulation thickness remains constant at 2 in.

This material was extracted and drawn by 3M Fire Protection Products from the 2006 Warnock Hersey Directory of Listed Products

Through Penetrations

Horizontal/Vertical

2 Hour

PHV

3M CANADA CO – London, ON Canada

DESIGN NO. 3M/PHV 120-19

October 02, 2006

HORIZONTAL OR VERTICAL (FLOOR OR WALL)

RATINGS – SEE TABLE BELOW

TEST PRESSURE DIFFERENTIAL – 2.5 PA (0.01" OF WATER) MINIMUM

| Penetrating Items | Maximum Pipe Size* | Maximum Hole Size* | Min.-Max. Annular Spacing* | Ratings | | | |
|------------------------------------|--------------------|--------------------|----------------------------|--------------|---------|-----------|--------|
| | | | | CAN/ULC-S115 | | ASTM-E814 | |
| | | | | F, FH | FT, FTH | F | FT |
| Glass | 2" | 3" | 1/4" - 1/2" | 2 Hr | 80 Min | 2 Hr | 80 Min |
| Steel/Cast Iron Sch. 10 or heavier | 8" | 12" | 0" - 3-3/8" | 2 Hr | 26 Min | 2 Hr | 26 Min |
| Copper | 4" | 6" | 0" - 1-3/4" | 2 Hr | 15 Min | 2 Hr | 15 Min |
| Conduit | 4" | 6" | 0" - 1-1/2" | 2 Hr | 15 Min | 2 Hr | 15 Min |
| CPVC** | 2" | 4" | 0" - 1-1/2" | 2 Hr | 15 Min | 2 Hr | 15 Min |
| PVC** | 2" | 4" | 0" - 1-1/2" | 2 Hr | 15 Min | 2 Hr | 15 Min |
| BX | 1/2" | 2" | 0" - 1-1/2" | 2 Hr | 15 Min | 2 Hr | 15 Min |
| EL XXX | 45% Fill | 6" | 1/4" - 1/2" | 2 Hr | 15 Min | 2 Hr | 15 Min |

* - To convert to mm, multiply by 2.54

** - Process and supply pipe only in Canada

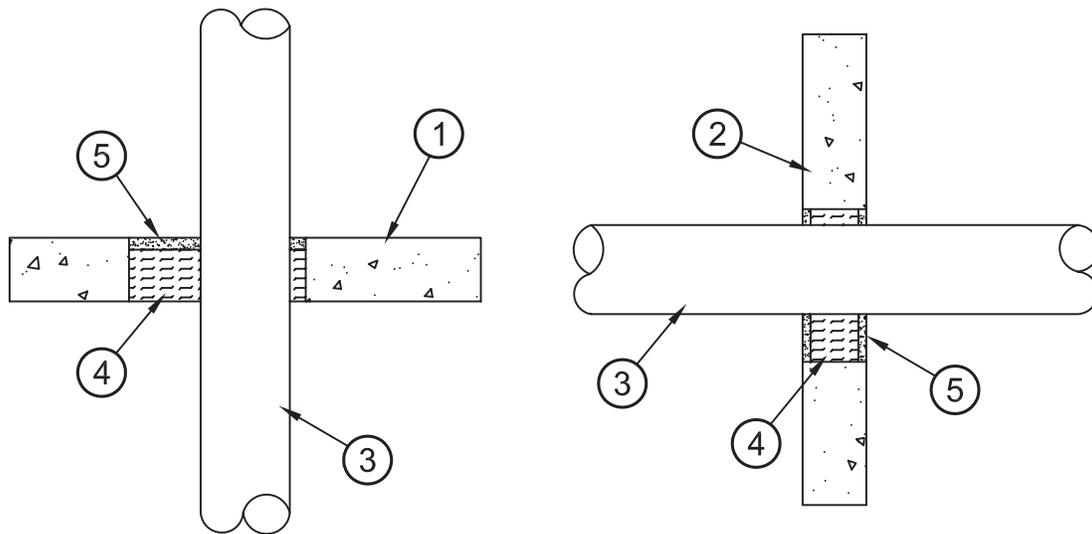

- Floor/Ceiling Assembly** – Minimum 4-1/2 in. thick concrete slab, two hour rated floor/ ceiling assembly.
- Wall Assembly** – Minimum 5 in. thick concrete slab, or minimum 8 in. concrete block, two hour rating wall assembly.
- Penetrating Items** – See Table of Ratings.
 - Electrical Penetrations** – Maximum 8 cables spaced 1/8 in. minimum apart.
 - Metal Pipes** – Maximum 3 penetrating items spaced 1/8 in. minimum apart.
- Mineral Wool Packing** – Nominal 4 PCF or heavier density mineral wool insulation, tightly packed around the penetrating item to a depth of 4 in. minimum.
- Firestop Sealant** – *3M™ 1003 Silicone Sealant Self Leveling for floor/ceiling penetrations or *3M™ Fire Barrier 1000 Silicone Sealant No Sag for floor or wall penetrations, applied to a depth of 3/8 in. for floor penetrations on top of the mineral wool packing, and to a depth of 3/8 in. on both sides of a wall assembly.

This material was extracted and drawn by 3M Fire Protection Products from the 2006 Warnock Hersey Directory of Listed Products

3M CANADA CO. – London, On Canada

DESIGN NO. 3M/PHV 120-20

October 02, 2006

HORIZONTAL or VERTICAL (FLOOR or WALL)
 RATINGS and OPENING DIAMETER – SEE TABLE
 TEST PRESSURE DIFFERENTIAL – 50 Pa (0.20 in. of water)

| Penetrant | Maximum Pipe ID | Maximum Opening Diameter | Annular Space | ULC-S115-95 CAN/ULC-S115-M | |
|-----------|-----------------|--------------------------|---------------|-------------------------------|---------|
| | | | | F, FH | FT, FTH |
| XFR | 2" | 3" | 1/4" - 3/4" | 2 Hr | 1/2 Hr |

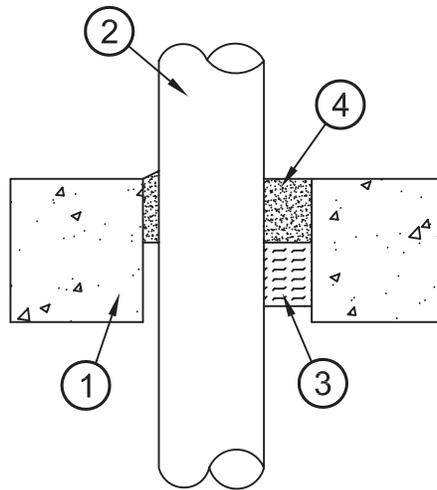

1. **Floor or Wall Assembly** – Code conforming 2 Hour fire-rated floor or wall assembly, nominal 4-1/2" thickness, normal or low density cast concrete. Wall may also be constructed of nominal 8" thick concrete blocks (filled or unfilled). Ratings achieved will equal that of floor or wall assembly
- 1a **Steel Sleeve** (Optional, not shown) – Minimum 0.028 wall thickness (or heavier) galvanized steel sleeve cast or grouted into floor or wall assembly. Sleeve may extend a maximum of 1/2" beyond either surface of floor or wall assembly.
2. **Penetrant** – (See also table of ratings) Schedule 40, XFR pipe for use in DWV (Drain, Waste and Vent) or Closed (Process and Supply) piping systems.

Firestop System Components:

3. **Forming Material** – Mineral wool, 2" thickness, 4pcf, tightly packed around the penetrant recessed from the floor or wall surface.
4. **Sealant** – *3M™ Fire Barrier IC 15WB+ Sealant applied to a 2" thickness, within the annular space around the penetrant, over the forming material, flush with the floor or wall surface. For wall applications apply firestop system to both surfaces.

Note: metric conversion factor, inches x 25.4 = mm

*Component bearing the Warnock Hersey Certification Mark

This material was extracted and drawn by 3M Fire Protection Products from the 2006 Warnock Hersey Directory of Listed Products

Through Penetrations

Horizontal/Vertical

2 Hour

PHV



Through Penetrations

ULC

CAJ

Concrete floors with a minimum thickness less than or equal to 5 inches (127 mm)

Concrete or masonry walls with a minimum thickness less than or equal to 8 inches (203 mm)

CBJ

Concrete floors with a minimum thickness greater than 5 inches (127 mm)

Concrete or masonry walls with a minimum thickness less than or equal to 8 inches (203 mm)

FA

Concrete floors/Steel decks

Concrete or masonry walls with a minimum thickness less than or equal to 8 inches (203 mm)

FC

Floor assemblies

Framed floors

Non-Metallic Pipes

CAJ

Concrete floors with a minimum thickness less than or equal to 5 inches (127 mm)

Concrete or masonry walls with a minimum thickness less than or equal to 8 inches (203 mm)

CBJ

Concrete floors with a minimum thickness greater than 5 inches (127 mm)

Concrete or masonry walls with a minimum thickness less than or equal to 8 inches (203 mm)

FA

Concrete floors/Steel decks

Concrete or masonry walls with a minimum thickness less than or equal to 8 inches (203 mm)

Non-Metallic Pipes • Concrete

| 3M UL Systems | "F" Rating | 3M Product | Through Penetrant Details |
|---------------|------------|--|---|
| C-AJ-2075C | 2 | 3M™ Fire Barrier Water Tight Sealant 3000 WT | Single max. 2 inch nonmetallic pipe penetrating a concrete floor or wall utilizing FB 3000WT Silicone Sealant. |
| C-AJ-2076 | 2 | 3M™ Fire Barrier Water Tight Sealant 3000 WT | Single or multiple max. 2 in. PEX tubing penetrating a max. 4 in. opening in a concrete floor or wall. |
| C-AJ-2641 | 2 | 3M™ Fire Barrier Wrap Ultra GS 3M™ Fire Barrier RC-1 Restricting Collar | Single max. 4 in. nonmetallic pipe penetrating a min. 4.5 in. thick concrete floor or wall. No sealant required. |
| C-AJ-2642 | 2 | 3M™ Fire Barrier Wrap Strips FS-195+ 3M™ Fire Barrier RC-1 Restricting Collar 3M™ Fire Barrier Sealant IC 15WB+ 3M™ Fire Barrier Sealant CP 25WB+ 3M™ Fire Barrier Water Tight Sealant 3000 WT 3M™ Fire Barrier Sealant FD 150+ 3M™ Fire Barrier Moldable Putty+ Pads and Sticks | Single max. 4 in. nonmetallic pipe penetrating a min. 4.5 in. thick concrete floor or wall with a nonmetallic coupling located flush with one surface of the assembly. |
| C-AJ-2662 | 1, 2 | 3M™ Fire Barrier Water Tight Sealant 3000 WT | Single max. 2 in. nonmetallic pipe penetrating a 1 or 2 hour rated concrete floor or wall utilizing FB 3000WT Silicone Sealant. Steel sleeve optional. |
| C-AJ-2669 | 2 | 3M™ Fire Barrier Ultra Plastic Pipe Device | Single max. 2 in. nonmetallic pipe penetrating a max. 9 in. diameter opening in a min. 4.5 in. thick concrete floor or wall. Utilizing packing material, steel cover plate(s), and Ultra Plastic Pipe Device. |
| C-BJ-2007C | 2 | 3M™ Fire Barrier Water Tight Sealant 3000 WT | Single max. 4 in. nonmetallic pipe penetrating a min. 191 mm thick concrete floor or wall utilizing FB 3000WT Silicone Sealant. Tested to Canadian standards. |
| F-A-2212 | 2 | 3M™ Fire Barrier Cast-In Device 2PCID, 3M™ Fire Barrier Cast-In Device 3PCID, 3M™ Fire Barrier Cast-In Device 4PCID, 3M Fire Barrier Cast-In Device Height Adapter, 2HA, 3M Fire Barrier Cast-In Device Height Adapter, 3HA, 3M Fire Barrier Cast-In Device Height Adapter, 4HA, | Single max. 4 in. nonmetallic pipe penetrating a min. 114 mm thick concrete floor through 3M Fire Barrier Cast-In Device |
| F-A-2215 | 2 | 3M™ Fire Barrier Ultra Plastic Pipe Device 3M™ Fire Barrier Water Tight Sealant 3000 WT 3M™ Fire Barrier Sealant CP 25WB+ 3M™ Fire Barrier Sealant IC 15WB+ 3M™ Fire Barrier Water Tight Sealant 1000 NS 3M™ Fire Barrier Water Tight Sealant 1003 SL | Single max. 4 in. nonmetallic pipe penetrating fluted metal deck/ concrete floor assembly. Cover plate bottom side. Ultra PD or RC-1 Collar using Ultra GS Wrap Strip |
| F-A-2218 | 1, 2 | 3M™ Fire Barrier Wrap Ultra GS 3M™ Fire Barrier RC-1 Restricting Collar 3M™ Fire Barrier Sealant IC 15WB+ 3M™ Fire Barrier Sealant CP 25WB+ 3M™ Fire Barrier Water Tight Sealant 3000 WT 3M™ Fire Barrier Water Tight Sealant 1000 NS 3M™ Fire Barrier Water Tight Sealant 1003 SL | Max. 4 inch PVC, RNC, CPVC, or ABS pipe penetrating a concrete floor slab utilizing a Fire Barrier Plastic Cast-In Device. Height Adapter optional for thicker floors. |

System No. C-AJ-2075C

March 27, 2009

F Rating – 2 Hr

FT Rating – 0 and 2 Hr (See Item 1A)

FH Rating – 2 Hr

FTH Rating – 0 and 2 Hr (See Item 1A)

L Rating At Ambient – Less Than 1 CFM/Sq. Ft

L Rating At 400° F – 3 CFM/Sq. Ft

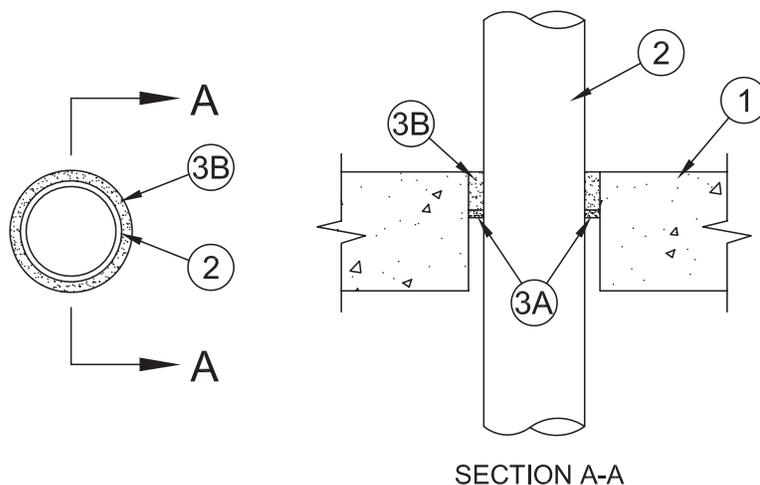

System tested with a pressure differential of 50 Pa between the exposed and the unexposed surfaces with the higher pressure on the exposed side.

1. **Floor or Wall Assembly** – Min 114 mm thick reinforced lightweight or normal weight (100-150 pcf) concrete. Wall may also be constructed of any UL Classified **Concrete Blocks***. Max diam of opening shall be 25 mm larger than the nom size of through-penetrant (Item 2).
See **Concrete Blocks (CAZT)** category in the Fire Resistance Directory for names of manufacturers.
- 1A. **Steel Sleeve** – (optional) – Schedule 40 (or heavier) steel sleeve cast or grouted into floor or wall assembly, flush with both surfaces of floor or wall assembly. The nom size of sleeve shall be 25 mm larger than the nom size of through-penetrant.
The hourly FT and FTH Ratings are 0 Hr when steel sleeve is used, otherwise the hourly FT, FH and FTH Ratings are equal to the hourly F Rating of the assembly.
2. **Through-Penetrant** – One nonmetallic pipe, conduit or tubing to be centered within the firestop system. A nom annular space of 8 mm is required within the firestop system. Pipe, conduit or tubing to be rigidly supported on both sides of floor or wall assembly. The following types and sizes of nonmetallic pipes, conduits or tubing may be used:
 - A. **Polyvinyl Chloride (PVC) Pipe** – Nom 50 mm diam (or smaller) Schedule 40 solid core PVC pipe for use in closed (process or supply) or vented (drain, waste or vent) piping systems.
 - B. **Chlorinated Polyvinyl Chloride (CPVC) Pipe** – Nom 50 mm diam (or smaller) SDR11, SDR13.5 or SDR17 CPVC pipe for use in closed (process or supply) or vented (drain, waste or vent) piping systems.
 - C. **Rigid Nonmetallic Conduit+** – Nom 50 mm diam (or smaller) Schedule 40 PVC conduit installed in accordance with the National Electrical Code (NFPA No. 70).
 - D. **Electrical Nonmetallic Tubing (ENT)+** – Nom 50 mm diam (or smaller) corrugated-wall electrical nonmetallic tubing (ENT) constructed of polyvinyl chloride (PVC) and installed in accordance with the National Electrical Code (NFPA No. 70).
See **Electrical Nonmetallic Tubing (FKHU)** category in the Electrical Construction Materials Directory for names of manufacturers.
 - E. **Flexible Nonmetallic Conduit, Liquid-Tight (FNMC)+** – Nom 50 mm diam (or smaller) corrugated-wall flexible nonmetallic conduit, liquid-tight (FNMC) constructed of polyvinyl chloride (PVC) and installed in accordance with the National Electrical Code (NFPA No. 70).
See **Flexible Nonmetallic Conduit, Liquid-Tight (DXOQ)** category in the Electrical Construction Materials Directory for names of manufacturers.
3. **Firestop System** – The details of the firestop system shall be as follows:
 - A. **Packing Material** – (Optional) – Nom 9.5 mm diam polyethylene backer rod or min 9.5 mm thickness of mineral wool batt insulation firmly packed into opening as a permanent form and recessed from top surface of floor or both surfaces wall as required to accommodate the required thickness of fill material.
 - B. **Fill, Void or Cavity Material* – Sealant** – Min 50 mm thickness of fill material applied within the annulus, flush with top surface of floor or both surfaces wall.

3M COMPANY**3M FIRE PROTECTION PRODUCTS** – FB-3000 WT sealant

*Bearing the UL Classification Mark

+Bearing the UL Listing Mark

Reprinted from the Online Certifications Directory with permission from Underwriters Laboratories Inc.

Copyright © 2010 Underwriters Laboratories Inc.®



Note: Systems with Nonmetallic Through Penetrant(s) have not been evaluated with a pressure differential of 50 Pa between the exposed and unexposed surfaces as required by the National Building Code of Canada.

System No. C-AJ-2076

March 27, 2009

F Rating – 2 Hr

FT Rating – 0 Hr

FH Rating – 2 Hr

FTH Rating – 0 Hr

L Rating At Ambient – Less than 5.1 L/s/m₂

L Rating at 205° C – 15.2 L/s/m²

W Rating – Class 1

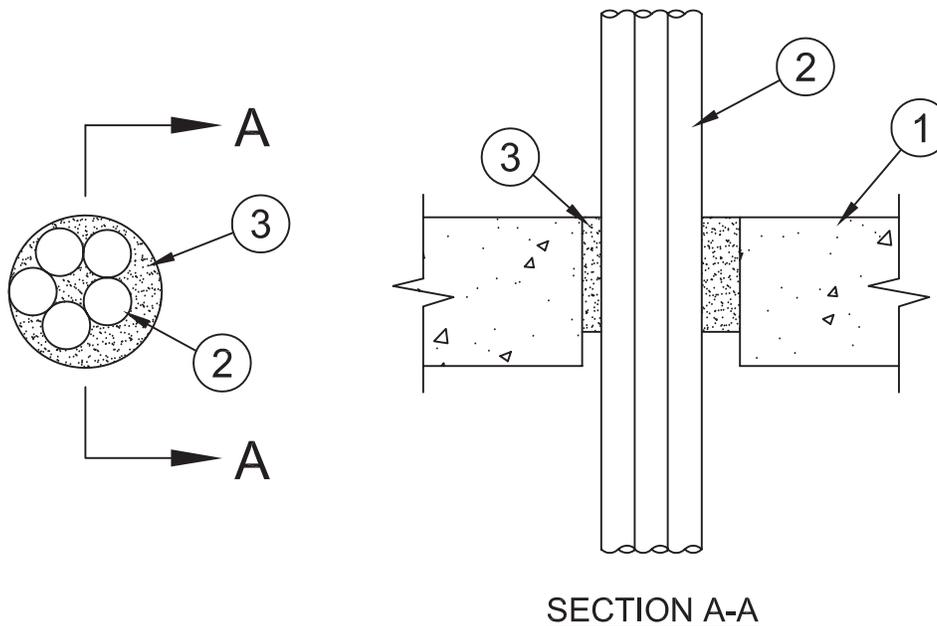

System tested with a pressure differential of 50 Pa between the exposed and the unexposed surfaces with the higher pressure on the exposed side.

- Floor or Wall Assembly** – Min 114 mm thick reinforced lightweight or normal weight (1600 - 2400 kg/m³) concrete floor min 152 mm thick reinforced lightweight or normal weight (1600 - 2400 kg/m³) concrete wall. Wall may also be constructed of any UL Classified **Concrete Blocks***. Max diam of opening is 102 mm.
See **Concrete Blocks (CAZT)** category in the Fire Resistance Directory for names of manufacturers.
- Through-Penetrant** – One or more nonmetallic tubes to be installed either concentrically or eccentrically within the firestop system. Aggregate cross-sectional area of tubes in opening to be max 45 percent of the cross-sectional area of the opening. The annular space between the tubes shall be min 0 mm to max 25 mm. The annular space between the tubes and the edge of the opening shall be min 6 mm to max 25 mm. Tubes to be rigidly supported on both sides of the floor or wall assembly. The following types of tubes may be used:
 - Crosslinked Polyethylene (PEX) Tubing** – Nom 51 mm diam (or smaller) SDR 9 PEX tubing for use in closed (process or supply) or vented (drain, waste or vent) piping systems.
 - Polyethylene/Aluminum/Polyethylene (PE/AL/PE) Tubing** – Nom 19 mm diam (or smaller) PE/AL/PE tubing for use in closed (process or supply) or vented (drain, waste or vent) piping systems.
 - Crosslinked Polyethylene/Aluminum/Crosslinked Polyethylene (PEX/AL/PEX) Tubing** – Nom 19 mm diam (or smaller) SDR 9 PEX tubing for use in closed (process or supply) or vented (drain, waste or vent) piping systems.
- Fill, Void or Cavity Material* – Sealant** – Min 76 mm thickness of fill material applied within the annulus, flush with the top surface of floor or with both sides of wall assembly.

3M COMPANY

3M FIRE PROTECTION PRODUCTS – FB-3000 WT sealant

*Bearing the UL Classification Mark

Reprinted from the Online Certifications Directory with permission from Underwriters Laboratories Inc.

Copyright © 2010 Underwriters Laboratories Inc.®



Note: Systems with Nonmetallic Through Penetrant(s) have not been evaluated with a pressure differential of 50 Pa between the exposed and unexposed surfaces as required by the National Building Code of Canada.

Through Penetrations

Non-Metallic Pipes

2000 Series

Concrete

CAJ

System No. C-AJ-2641

June 23, 2010

F Rating – 2 Hr

FT Ratings – 1-3/4 and 2 Hr (See Item 2)

FH Ratings – 0 and 2 Hr (See Item 2)

FTH Ratings – 0 and 2 Hr (See Item 2)

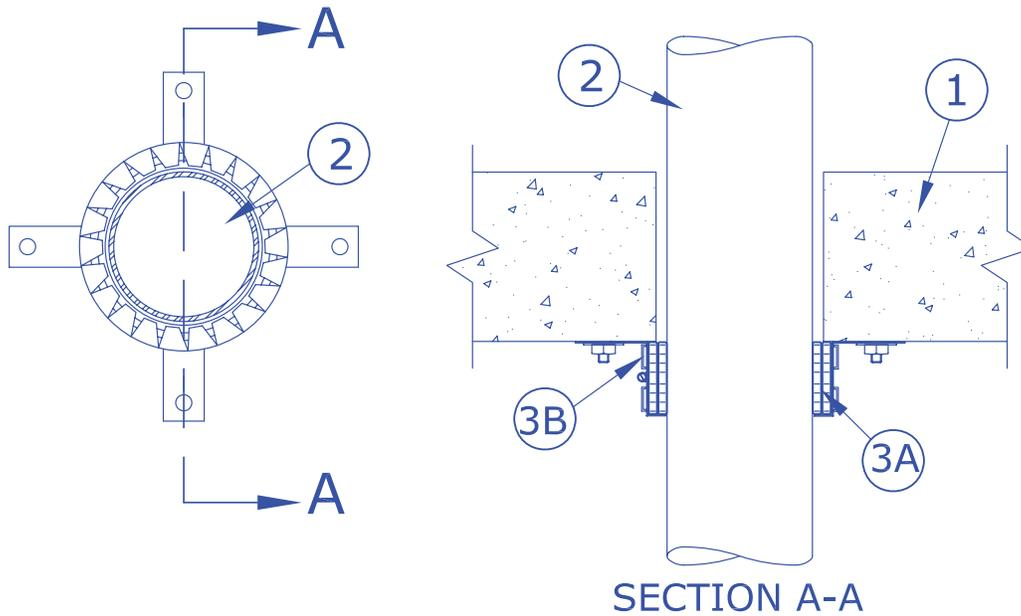

System tested with a pressure differential of 50 Pa between the exposed and the unexposed surfaces with the higher pressure on the exposed side.

1. **Floor or Wall Assembly** – Min 114 mm (4-1/2 in.) thick reinforced lightweight or normal weight (1600 - 2400 kg/m³ or 100-150 pcf) concrete. Wall may also be constructed of any UL Classified **Concrete Blocks***. Diam of opening shall be 25 mm (1 in.) larger than nom pipe diam except that for nom 51 mm (2 in.) diam (and smaller) penetrants, diam of opening shall be 19 mm (3/4 in.) larger than nom pipe diam.

See **Concrete Blocks** (CAZT) category in the Fire Resistance Directory for names of manufacturers.

2. **Through Penetrants** – One nonmetallic pipe or conduit to be centered within opening with a nom annular space between penetrant and periphery of opening of 6 mm (1/4 in.). Penetrant to be rigidly supported on both sides of the floor or wall assembly. The following types and sizes of nonmetallic pipes may be used:
 - A. **Polyvinyl Chloride (PVC) Pipe** – Nom 102 mm (4 in.) diam (or smaller) Schedule 40 solid core or cellular core PVC pipe for use in closed (process or supply) or vented (drain, waste or vent) piping systems.
 - B. **Rigid Nonmetallic Conduit++** – Nom 102 mm (4 in.) diam (or smaller) Schedule 40 PVC conduit installed in accordance with National Electrical Code (NFPA No. 70).
 - C. **Chlorinated Polyvinyl Chloride (CPVC) Pipe** – Nom 102 mm (4 in.) diam (or smaller) SDR13.5 CPVC pipe for use in closed (process or supply) piping systems.
 - D. **Acrylonitrile Butadiene Styrene (ABS) Pipe** – Nom 102 mm (4 in.) diam (or smaller) Schedule 40 solid core or cellular core ABS pipe for use in closed (process or supply) or vented (drain, waste or vent) piping systems.

The FT, FH and FTH Ratings are 2 hr for the cellular core ABS penetrant type. For all other penetrant types, the FT Rating is 1-3/4 hr and the FH and FTH Ratings are 0 hr.

3. **Firestop System** – The firestop system shall consist of the following:
 - A. **Fill, Void or Cavity Materials* – Wrap Strip** – Nom 3.2 mm (1/8 in.) thick intumescent material supplied in 51 mm (2 in.) wide strips. For nom 38 and 51 mm (1-1/2 and 2 in.) diam pipes, one layer is required. For nom 2-1/2 and 3 in. (64 and 76 mm) diam pipes, two layers are required. For nom 3-1/2 and 4 in. (89 and 102 mm) diam pipes, three layers are required. Wrap strip tightly wrapped around nonmetallic pipe and butted tightly against the bottom surface of the floor or both surfaces of the wall. Wrap strip layers temporarily held in position using aluminum foil tape, steel wire tie, or equivalent.

3M COMPANY
3M FIRE PROTECTION PRODUCTS – Ultra GS
 - B. **Steel Collar** – Nom 51 mm (2 in.) deep collar with 32 mm (1-1/4 in.) wide by 51 mm (2 in.) long anchor tabs and min 13 mm (1/2 in.) long tabs to retain wrap strip layers. Coils of precut 0.41 mm (0.016 in.) thick (28 gauge) galv sheet steel available from wrap strip manufacturer. As an alternate, collar may be field-fabricated from min 0.41 mm (0.016 in.) thick (28 gauge) galv sheet steel in accordance with instruction sheet supplied by wrap strip manufacturer. Steel collar, with anchor tabs bent outward 90 degree, wrapped tightly around wrap strip layers with min 25 mm (1 in.) overlap at seam. Anchor tabs to be pressed tightly against floor or wall surface(s), and collar to be compressed around wrap strip layers using a min 13 mm (1/2 in.) wide by 0.71 mm (0.028 in.) thick stainless steel band clamp at the collar midheight. Collar to be secured to floor or wall surface(s) with 6 mm (1/4 in.) diam by min 38 mm (1-1/2 in.) long steel expansion bolts in conjunction with steel nuts and min 32 mm (1-1/4 in.) diam steel fender washers. Min of two, three or four anchor bolts, symmetrically located, for nom 51 mm (2 in.) diam (and smaller), nom 3 in. (76 mm) diam (and smaller) and nom 4 in. (102 mm) diam (and smaller), pipes, respectively.

System No. C-AJ-2641 *continued*

- C. **Firestop Device*** – As an alternate to Items 3A and 3B, firestop device sized for nom diam of penetrant (ie, 4.0 device for nom 102 mm (4 in.) pipes, 3.0 device for nom 76 mm (3 in.) diam pipes and 2.0 device for nom 51 mm (2 in.) diam pipes) shall be used. Firestop device to be installed in accordance with the accompanying installation instructions. Firestop device installed and latched around pipe and secured to the underside of the floor or both sides of wall with 6 mm (1/4 in.) diam by min 38 mm (1-1/2 in.) long steel expansion bolts in conjunction with steel nuts and min 32 mm (1-1/4 in.) diam steel fender washers. Min of two, three or four anchor bolts, symmetrically located, for nom 51, 76 and 102 mm (2, 3 and 4 in.) diam pipes, respectively.

3M COMPANY

3M FIRE PROTECTION PRODUCTS – Ultra RC Pack 2.0, 3.0, 4.0

*Bearing the UL Classification Mark

Reprinted from the Online Certifications Directory with permission from UL
© 2012 UL LLC



Through Penetrations

Non-Metallic Pipes

2000 Series

Concrete

CAJ

System No. C-AJ-2642

June 23, 2010
F Rating – 2 Hr
FT Rating – 0 Hr
FH Rating – 2 Hr
FTH Rating – 0 Hr

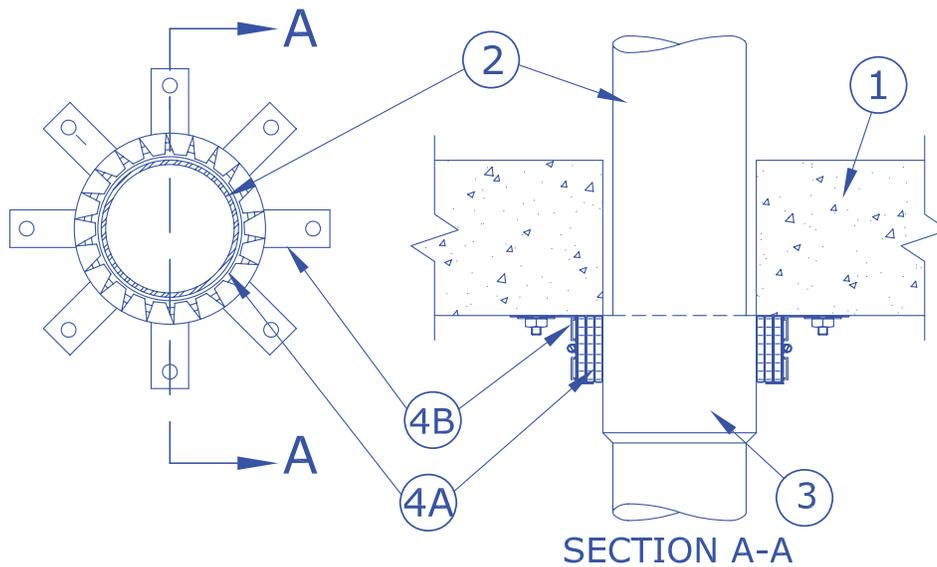

System tested with a pressure differential of 50 Pa between the exposed and the unexposed surfaces with the higher pressure on the exposed side.

- Floor or Wall Assembly** – Min 114 mm (4-1/2 in.) thick lightweight or normal weight (1600 to 2400 kg/m³ or 100 to 150 pcf) concrete. Wall may also be constructed of any UL Classified **Concrete Blocks***. Diam of opening through floor or wall to be 13 to 16 mm (1/2 to 5/8 in.) larger than the outside diam of through-penetrant (Item 2). Max diam of opening is 127 mm (5 in.).
See **Concrete Blocks (CAZT)** category in the Fire Resistance Directory for names of manufacturers.
 - Through Penetrants** – One nonmetallic penetrant centered in the through opening. Penetrant to be rigidly supported on both sides of floor or wall assembly. The following types and sizes of nonmetallic penetrants may be used.
 - Polyvinyl Chloride (PVC) Pipe** – Nom 102 mm (4 in.) diam (or smaller) Schedule 40 solid core PVC pipe for use in closed (process or supply) or vented (drain, waste or vent) piping system.
 - Rigid Nonmetallic Conduit+** – Nom 102 mm (4 in.) diam (or smaller) Schedule 40 PVC conduit installed in accordance with the National Electrical Code (NFPA No. 70).
 - Chlorinated Polyvinyl Chloride (CPVC) Pipe** – Nom 102 mm (4 in.) diam (or smaller) SDR13.5 CPVC pipe for use in closed (process or supply) piping systems.
 - Nonmetallic Pipe Coupling** – Nom 102 mm (4 in.) diam (or smaller) Schedule 40 PVC pipe coupling or nom 102 mm (4 in.) diam (or smaller) SDR13.5 CPVC pipe coupling installed such that the top of the coupling is flush with the bottom surface of the floor assembly, or flush with either side of the wall assembly, and extending outward.
 - Fill, Void or Cavity Materials* – Wrap Strip** – Nom 6 mm (1/4 in.) thick intumescent elastomeric material faced on one side with aluminum foil, supplied in 51 mm (2 in.) wide strips. Min four layers of wrap strips tightly wrapped around nonmetallic pipe coupling (foil side exposed) with the top edges butted against the underside of the floor. In wall assemblies, a min four layers of wrap strips tightly wrapped around nonmetallic pipe coupling (foil side exposed) and butted tightly against outer surface of wall. For the pipe or conduit on the side of the wall opposite the pipe coupling, the wrap strips shall be wrapped tightly around the pipe or conduit and butted tightly against outer surface of wall. For nom 13 mm (1/2 in.) to nom 38 mm (1-1/2 in.) diam pipes or conduits, a min of one layer of wrap strip is required. For nom 51, 64 and 76 mm (2, 2-1/2 and 3 in.) diam pipes or conduits, a min of two layers of wrap strip is required. For nom 89 and 102 mm (3-1/2 and 4 in.) diam pipes or conduits, a min of three layers of wrap strip is required. Each layer of wrap strip to be installed with butted seam, with butted seams in successive layers staggered. Wrap strip layers temporarily held in position using aluminum foil tape, steel wire tie or equivalent.
- 3M COMPANY**
3M FIRE PROTECTION PRODUCTS – FS-195+
- Steel Collar** – Nom 51 mm (2 in.) deep collar with 32 mm (1-1/4 in.) wide by 51 mm (2 in.) long anchor tabs and min 13 mm (1/2 in.) long tabs to retain wrap strip. Coils of precut min 0.41 mm (0.016 in.) thick (28 gauge) galv sheet steel available from wrap strip manufacturer. As an alternate, collar may be field-fabricated from min 0.41 mm (0.016 in.) thick (28 gauge) galv sheet steel in accordance with instruction sheet supplied by wrap strip manufacturer. Collar, with anchor tabs bent outward 90 degrees, wrapped tightly around wrap strip with min 25 mm (1 in.) overlap at seam and compressed around wrap strip(s) using a min 13 mm (1/2 in.) wide by min 0.71 mm (0.028 in.) thick stainless steel band at the collar midheight. Collar anchor tabs pressed tightly against floor or wall surface(s) and secured to floor or wall surface(s) with 6 mm (1/4 in.) diam by min 38 mm (1-1/2 in.) long steel expansion bolts or equivalent in conjunction with steel nuts and min 32 mm (1-1/4 in.) diam steel fender washers. Min of five anchor bolts used for collar installed around pipe coupling. For the collars installed around pipes or conduits in wall assemblies on the side opposite the pipe coupling, a min of two anchor bolts are required for nom 13 to 51 mm (1/2 to 2 in.) pipes or conduits, a min of three anchor bolts for nom 64 and 76 mm (2-1/2 and 3 in.) pipes or conduits and a min of four anchor bolts for nom 89 and 102 mm (3-1/2 and 4 in.) pipes or conduits, symmetrically located. Retainer tabs bent 90 degrees toward pipe to lock wrap strip(s) in position.

System No. C-AJ-2642 *continued*

- C. **Fill, Void or Cavity Materials* – Caulk, Sealant or Putty** – (Optional, not shown) – Bead of caulk or putty may be applied to outer perimeter of steel collar at its interface with floor or wall surface(s). In floor assemblies, a bead of caulk may be used within the annular space on the top side of the floor.

3M COMPANY

3M FIRE PROTECTION PRODUCTS – CP-25WB+ caulk, FB-3000 WT sealant, MP+ Putty, IC 15WB+ caulk or FireDam 150+ caulk.

(**Note:** CP 25WB+ and FireDam 150+ not suitable for use with CPVC pipes.)

*Bearing the UL Classification Mark

Reprinted from the Online Certifications Directory with permission from UL

© 2012 UL LLC



Through Penetrations

Non-Metallic Pipes

2000 Series

Concrete

CAJ

System No. C-AJ-2662

June 11, 2012

F Ratings – 1 and 2 Hr (See Item 1)
FT Ratings – 0, 1 and 2 Hr (See Item 1A)
FH Ratings – 1 and 2 Hr (See Item 1)
FTH Ratings – 0, 1 and 2 Hr (See Item 1A)
L Rating At Ambient – Less Than 1 CFM/Sq Ft
L Rating At 400° F – 5 CFM/Sq. Ft

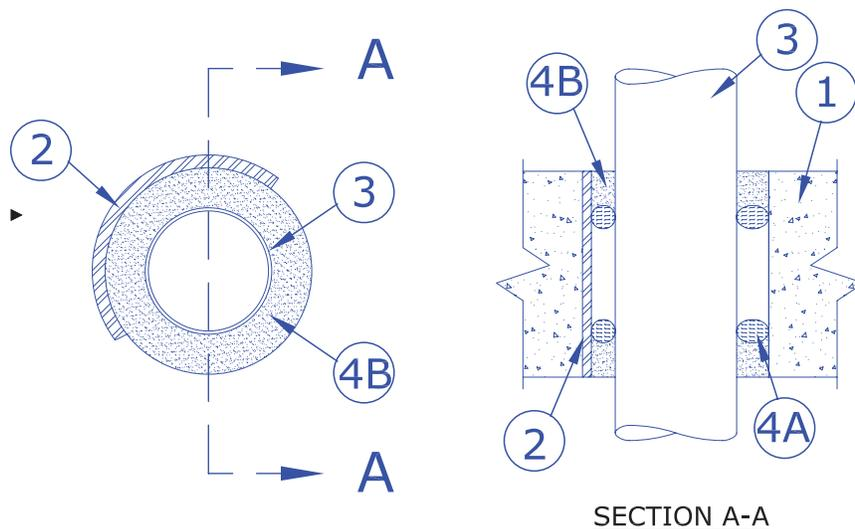

System tested with a pressure differential of 50 Pa between the exposed and the unexposed surfaces with the higher pressure on the exposed side.

- Floor or Wall Assembly** – Min 95 mm (3-3/4 in.) thick reinforced lightweight or normal weight (1600-2400 kg/m³ or 100-150 pcf) concrete for 1 Hr F and FH Ratings. Min 114 mm (4-1/2 in.) thick reinforced lightweight or normal weight (1600-2400 kg/m³ or 100-150 pcf) concrete for 2 Hr F and FH Ratings. Wall may also be constructed of any UL Classified **Concrete Blocks***. Floor may also be constructed of min 152 mm (6 in.) thick UL Classified hollow-core **Precast Concrete Units***. Diam of opening shall be 16 mm (5/8 in.) to 25 mm (1 in.) larger than the outside diam of through-penetrant (Item 2).

See **Concrete Blocks (CAZT)** and **Precast Concrete Units (CFTV)** categories in Fire Resistance Directory for names of manufacturers.

- Steel Sleeve** – (Optional) -Schedule 40 (or heavier) steel sleeve cast or grouted into floor or wall assembly, flush with both surfaces of floor or wall assembly. The nom size of sleeve shall be 25 mm (1 in.) larger than the nom size of through-penetrant.

The hourly FT and FTH Ratings are 0 Hr when steel sleeve is used. Otherwise, the hourly FT and FTH Ratings are equal to the hourly F and FH Ratings of the assembly.

- Through-Penetrant** – One nonmetallic pipe, conduit or tubing to be centered within the firestop system. A min annular space of 8 mm (5/16 in.) is required within the firestop system. Pipe, conduit or tubing to be rigidly supported on both sides of floor or wall assembly. The following types and sizes of nonmetallic pipes, conduits or tubing may be used:
 - Polyvinyl Chloride (PVC) Pipe** – Nom 51 mm (2 in.) diam (or smaller) Schedule 40 solid core PVC pipe for use in closed (process or supply) or vented (drain, waste or vent) piping systems.
 - Chlorinated Polyvinyl Chloride (CPVC) Pipe** – Nom 51 mm (2 in.) diam (or smaller) SDR13.5 or SDR17 CPVC pipe for use in closed (process or supply) or vented (drain, waste or vent) piping systems.
 - Rigid Nonmetallic Conduit+** – Nom 51 mm (2 in.) diam (or smaller) Schedule 40 PVC conduit installed in accordance with the National Electrical Code (NFPA No. 70).
 - Electrical Nonmetallic Tubing (ENT)+** – Nom 51 mm (2 in.) diam (or smaller) corrugated-wall electrical nonmetallic tubing (ENT) constructed of polyvinyl chloride (PVC) and installed in accordance with the National Electrical Code (NFPA No. 70).
 - Flexible Nonmetallic Conduit, Liquid-Tight (FNMC)+** – Nom 51 mm (2 in.) diam (or smaller) corrugated-wall flexible nonmetallic conduit, liquid-tight (FNMC) constructed of polyvinyl chloride (PVC) and installed in accordance with the National Electrical Code (NFPA No. 70).
- Firestop System** – The details of the firestop system shall be as follows:
 - Packing Material** – (Optional) - Nom 10 mm (3/8 in.) diam polyethylene backer rod or min 10 mm (3/8 in.) thickness of mineral wool batt insulation firmly packed into opening as a permanent form and recessed from both surfaces of floor or wall as required to accommodate the required thickness of fill material.
 - Fill, Void or Cavity Material* – Sealant** – Min 16 mm (5/8 in.) thickness of fill material applied within the annulus, flush with both surfaces of the floor or wall, for 1 Hr F and FH Ratings. Min 25 mm (1 in.) thickness of fill material applied within the annulus, flush with both surfaces of the floor or wall, for 2 Hr F and FH Ratings.

3M COMPANY

3M FIRE PROTECTION PRODUCTS – FB-3000 WT sealant

*Bearing the UL Classification Mark

+Bearing the UL Listing Mark

Reprinted from the Online Certifications Directory with permission from UL
© 2012 UL LLC



System No. C-AJ-2669

December 26, 2012

F Rating – 2 Hr

T Rating – 1-1/4 Hr and 1-1/2 Hr (See Item 2)

FH Rating – 0 Hr

FTH Rating – 0 Hr

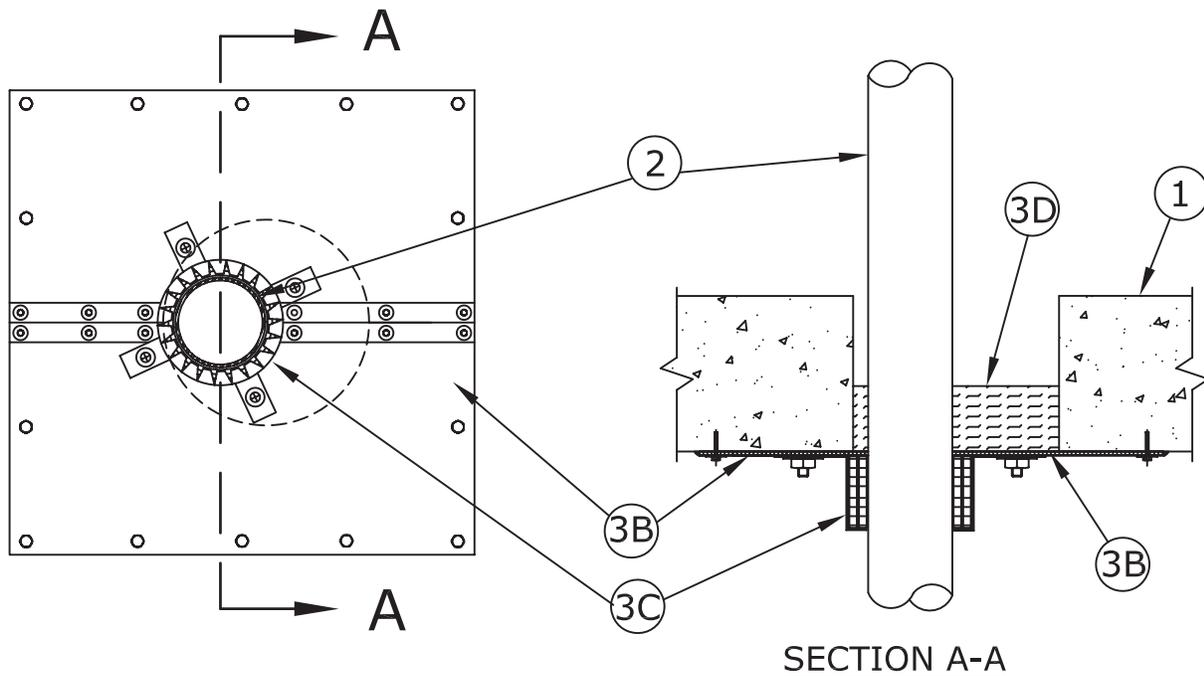

System tested with a pressure differential of 50 Pa between the exposed and the unexposed surfaces with the higher pressure on the exposed side.

- Floor or Wall Assembly** – Min 114 mm (4-1/2 in.) thick reinforced lightweight or normal weight (1600 - 2400 kg/m or 100-150 pcf) concrete. Wall may also be constructed of any UL Classified **Concrete Blocks***. Max diam of opening is 229 mm (9 in.).
See **Concrete Blocks (CAZT)** and **Precast Concrete Units (CFTV)** category in the Fire Resistance Directory for names of manufacturers.
- Through Penetrants** – One nonmetallic pipe or conduit to be installed either concentrically or eccentrically within the firestop system. The annular space between penetrant and periphery of opening shall be min 12.7 mm (1/2 in.) to max 79 mm (3-1/8 in.). Penetrant to be rigidly supported on both sides of floor or wall assembly. The following types and sizes of pipes or conduit may be used:
 - Polyvinyl Chloride (PVC) Pipe** – Nom 51 mm (2 in.) diam (or smaller) Schedule 40 solid core or cellular core PVC pipe for use in closed (process or supply) or vented (drain, waste or vent) piping systems.
 - Chlorinated Polyvinyl Chloride (CPVC) Pipe** – Nom 51 mm (2 in.) diam (or smaller) SDR-11 CPVC pipe for use in closed (process or supply) or vented (drain, waste or vent) piping systems.
 - Rigid Nonmetallic Conduit+** – Nom 51 mm (2 in.) diam (or smaller) Schedule 40 PVC conduit installed in accordance with the National Electric Code (NFPA No. 70).

T Rating is 1-1/2 Hr for Polyvinyl Chloride (PVC) and Rigid Nonmetallic Conduit Pipe. T Rating is 1-1/4 Hr for Chlorinated Polyvinyl Chloride (CPVC) Pipe.

- Firestop System** – The details of the firestop system shall be as follows:
 - Packing Material** – Min 102 mm (4 in.) thickness of min 64 kg/m³ (4 pcf) mineral wool batt insulation firmly packed within the opening. Packing material to be installed on top surface of cover plate, flush with bottom surface of floor or both surfaces of wall.
 - Steel Cover Plate** – Min 18 gauge galv steel cover plate, sized to overlap opening a min of 76 mm (3 in.) on all sides. Opening in plate for penetrant to be sized to the outside diam of penetrant. Plate attached to bottom of floor on both sides of wall with min 5 mm (3/16 in.) by 32 mm (1-1/4 in.) long steel masonry anchors spaced a max of 102 mm (4 in.) OC. Seams in plate covered with min 51 mm (2 in.) wide 28 gauge (or heavier) galv steel and attached to cover plate with No. 10 (or larger) steel screws on each side of seam spaced a max of 76 mm (3 in.) OC.
 - Firestop Device* – Collar** – Collar to be installed in accordance with the accompanying installation instructions. Collar to be installed and latched around pipe and secured to underside of floor or on both sides of wall with 3M Ultra Fast Anchor Straps or with min No. 10 by 19 mm (3/4 in.) long steel screws and min 32 mm (1-1/4 in.) diam steel fender washers. Min of two anchor straps or anchor bolts, symmetrically located, for nom 51 mm (2 in.) diam (and smaller) pipe.

3M COMPANY 3M FIRE PROTECTION PRODUCTS – Ultra PPD 1.5 and 2.0

*Bearing the UL Classification Mark

Reprinted from the Online Certifications Directory with permission from UL

© 2013 UL LLC





UL System No. C-BJ-2007 XHEZC - Firestop Systems

October 04, 2017

F Rating – 2 h

FT Rating – 1-3/4 or 2 h (See Item 1)

FH Rating – 2 h

FTH Rating – 1-3/4 or 2 h (See Item 1)

L Rating At Ambient – Less Than 1 CFM / Sq. Ft

L Rating At 400°F – 3 CFM / Sq. Ft

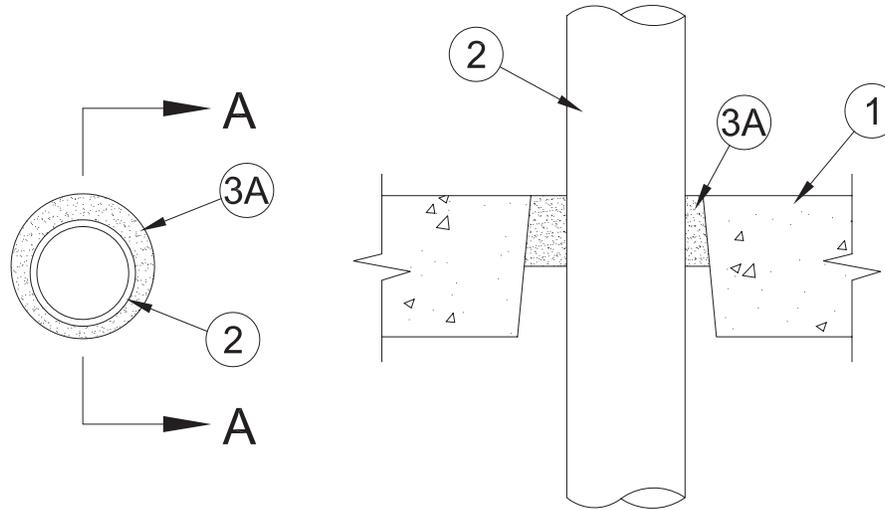

SECTION A-A

System tested with a pressure differential of 50 Pa between the exposed and unexposed surfaces with the higher pressure on the exposed side.

- 1. Floor or Wall Assembly** – Min 191 mm thick reinforced lightweight or normal weight (1600-2400 kg/cu meter or 100-150 pcf) concrete. Opening to be 133 mm (5-1/4 in.) by 165 mm (6-1/2 in.) conical opening with 133 mm (5-1/4 in.) opening on top surface of floor or cored opening with max inside diam of 165 mm (6-1/2 in.), or 159 mm (6-1/4 in.) by 191 mm (7-1/2 in.) conical opening with 159 mm (6-1/4 in.) opening on top surface of floor or cored opening with max inside diam of 191 mm (7-1/2 in.).

FT/FTH Rating is 1 3/4 h for 133 mm by 165 mm conical opening or 165 mm cored opening. FT/FTH Rating is 2 h for 159 mm by 191 mm conical opening or 191 mm cored opening.

- 2. Through Penetrant** – One nom 102 mm (4 in.) diam (or smaller) Schedule 40 solid core polyvinyl chloride - XFR (PVC-XFR) pipe for use in closed (process or supply) or vented (drain, waste or vent) piping systems. Pipe installed concentrically or eccentrically within the firestop system. A nom annular space for 133 mm opening on top side of slab shall be min 8 mm (0.31 in.) to max 11 mm (0.43 in.). A nom annular space for 159 mm opening on top side of slab shall be min 8 mm (0.31 in.) max 37 mm (1.46 in.). Pipe to be rigidly supported on both sides of floor or wall assembly.
- 3. Fill, Void or Cavity Material – Sealant** – Min 76 mm (3 in.) thickness of fill material applied within the annulus, flush with the top surface of floor or both surfaces of wall.

3M COMPANY 3M FIRE PROTECTION PRODUCTS – FB-3000 WT sealant

Through Penetrations
Non-Metallic Pipes
2000 Series
CBJ



*Indicates such products shall bear the UL or cUL Certification Mark for jurisdictions employing the UL or cUL Certification (such as Canada), respectively.

Reprinted from the Online Certifications Directory with permission from UL©

3M Industrial Adhesive and Tapes
Fire Protection Products
3M Center, Building 230-B-S-37
St. Paul, MN 55144-1000

System No. F-A-2212

June 23, 2010

F Rating – 2 Hr

FT Ratings – 1-3/4 and 2 Hr (See Item 3)

FH Ratings – 0 and 2 Hr (See Item 3)

FTH Ratings – 0 and 2 Hr (See Item 3)

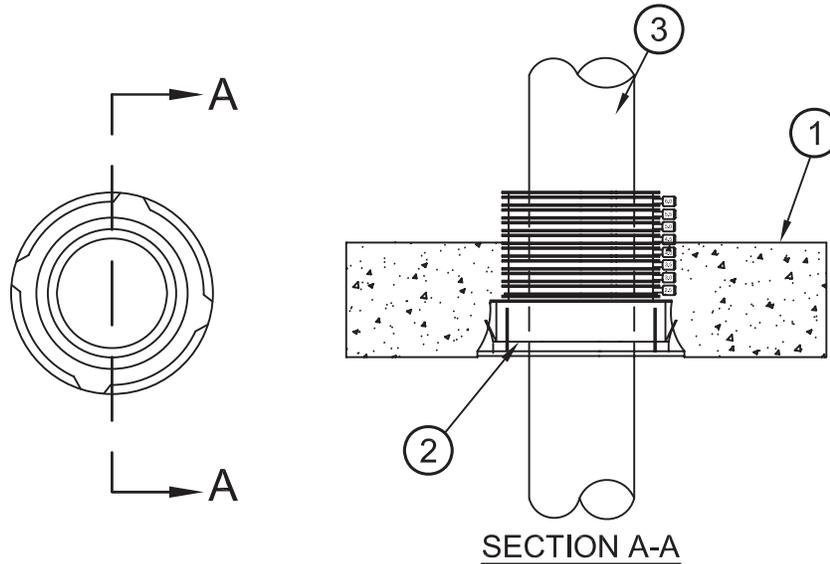

System tested with a pressure differential of 50 Pa between the exposed and the unexposed surfaces with the higher pressure on the exposed side.

1. **Floor Assembly** – Min 114 mm (4-1/2 in.) thick reinforced lightweight or normal weight (1600-2400 kg/m³ or 100-150 pcf) concrete.
2. **Firestop Device*** – Cast in place firestop device permanently embedded during concrete placement or grouted in concrete assembly in accordance with accompanying installation instructions. Firestop device shall be sized for nom diam of penetrant (ie, size 4 device for nom 102 mm (4 in.) pipes, size 3 device for nom 76 mm (3 in.) diam pipes and size 2 device for nom 51 mm (2 in.) diam pipes) shall be used. The device may be trimmed flush with top surface of floor or may project up to a max 89 mm (3-1/2 in.) above top surface of floor.

3M COMPANY

3M FIRE PROTECTION PRODUCTS – 3M Fire Barrier Cast-In Device 2PCID, 3PCID, 4PCID

- 2A. **Firestop Device – Height Adapter*** – (Not Shown) – For use in floors greater than 203 mm (8 in.) thick. Adapter snaps onto top of firestop device (Item 2).

3M COMPANY

3M FIRE PROTECTION PRODUCTS – 3M Fire Barrier Cast-In Device Height Adapter, 2HA, 3HA, 4HA

3. **Through Penetrants** – One nonmetallic pipe or conduit installed within the firestop system. Pipe or conduit to be rigidly supported on both sides of floor assembly. The nom penetrant diam shall match the nom size of the firestop device. The following types of nonmetallic pipes or conduits may be used:
 - A. **Polyvinyl Chloride (PVC) Pipe** – Nom 102 mm (4 in.) diam (or smaller) Schedule 40 solid core or cellular core PVC pipe for use in closed (process or supply) or vented (drain, waste or vent) piping systems.
 - B. **Rigid Nonmetallic Conduit++** – Nom 102 mm (4 in.) diam (or smaller) Schedule 40 PVC conduit installed in accordance with National Electrical Code (NFPA No. 70).
 - C. **Chlorinated Polyvinyl Chloride (CPVC) Pipe** – Nom 102 mm (4 in.) diam (or smaller) SDR13.5 CPVC pipe for use in closed (process or supply) piping systems.
 - D. **Acrylonitrile Butadiene Styrene (ABS) Pipe** – Nom 102 mm (4 in.) diam (or smaller) Schedule 40 solid core or cellular core ABS pipe for use in closed (process or supply) or vented (drain, waste or vent) piping systems.

The FT, FH and FTH Ratings are 2 hr for the cellular core ABS penetrant type. For all other penetrant types, the FT Rating is 1-3/4 hr and the FH and FTH Ratings are 0 hr.

*Bearing the UL Classification Mark

Reprinted from the Online Certifications Directory with permission from UL
© 2012 UL LLC





UL System No. F-A-2215
XHEZ7 - Through-penetration Firestop Systems Certified for Canada

May 23, 2011

F Rating — 2 Hr

FH Rating — 2 Hr

FT Rating — 1-1/2 Hr

FTH Rating — 1-1/2 Hr

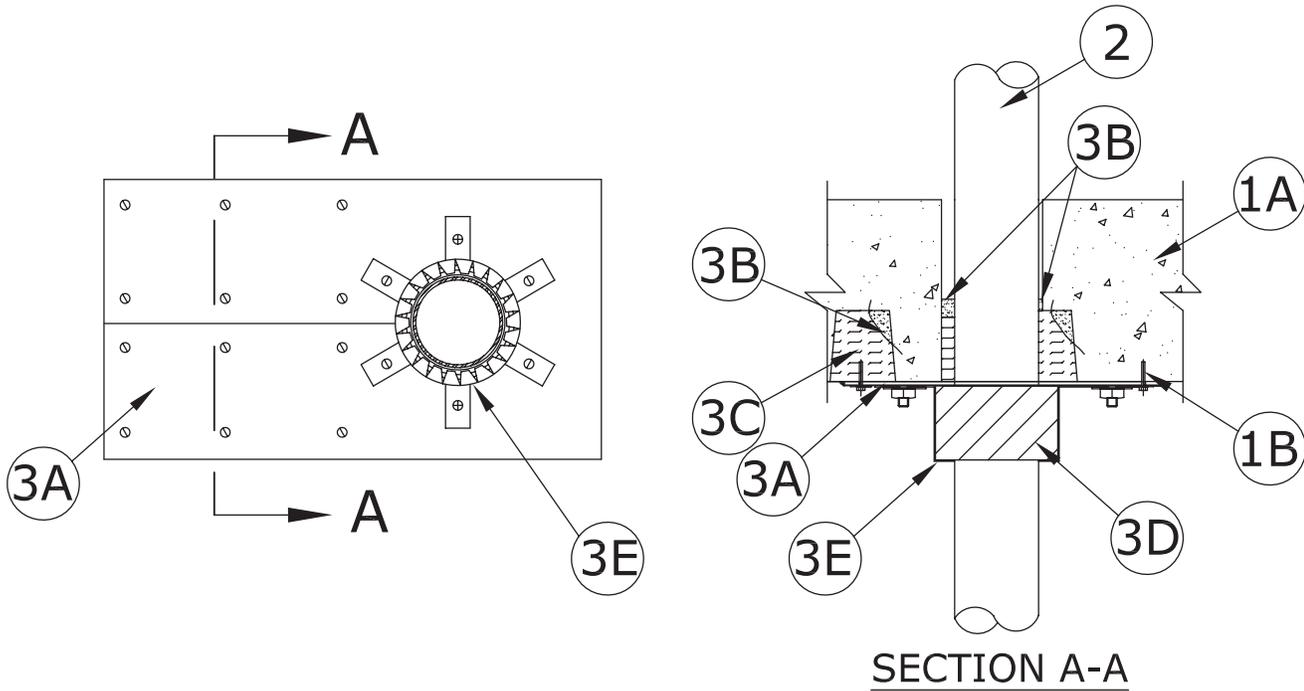

System not tested with a pressure differential of 50 Pa between the exposed and unexposed surfaces.

1. **Floor Assembly** – The fire-rated unprotected concrete and steel floor assembly shall be constructed of the materials and in the manner specified in the individual D900 Series designs in the UL Fire Resistance Directory and as summarized below:
 - A. **Concrete** – Min 3 in. (76 mm) thick reinforced lightweight or normal weight (100-150 pcf or 1600 - 2400 kg/m³) concrete.
 - B. **Welded Wire Fabric** – 6×6-W1.4xW1.4.
 - C. **Steel Floor and Form Units*** – Composite or noncomposite 1-1/2 in. (38 mm) deep fluted galv units as specified in the individual Floor-Ceiling design. Diam of opening through floor to be 1/2 to 5/8 in. (13 to 16 mm) larger than the outside diam of through-penetrant (Item 2). Max diam of opening is 5 in. (127 mm). Composite or noncomposite 1-1/2 in. (38 mm) deep fluted galv units as specified in the individual Floor-Ceiling design. Diam of opening through floor to be 1/2 to 5/8 in. (13 to 16 mm) larger than the outside diam of through-penetrant (Item 2). Max diam of opening is 5 in. (127 mm).
2. **Through Penetrants** – One nonmetallic pipe or conduit to be centered within the opening. Pipe to be rigidly supported on both sides of floor assembly. The following types and sizes of nonmetallic pipes may be used:
 - A. **Polyvinyl Chloride (PVC) Pipe** – Nom 4 in. (102 mm) diam (or smaller) Schedule 40 solid core or cellular core PVC pipe.
 - B. **Rigid Nonmetallic Conduit++** – Nom 4 in. (102 mm) diam (or smaller) Schedule 40 PVC conduit installed in accordance with Article 347 of the National Electrical Code (NFPA No. 70).
 - C. **Acrylonitrile Butadiene Styrene (ABS) Pipe** – Nom 4 in. (102 mm) diam (or smaller) Schedule 40 solid core or cellular core ABS pipe.
 - D. **Fire Retardant Polypropylene (FRPP) Pipe** – Nom 4 in. (102 mm) diam (or smaller) Schedule 40 FRPP pipe.

3. Firestop System – The details of the firestop system shall be as follows:

A. Metal Plate Enclosure – Min 16 ga. galv steel. Width of plate to extend a min of 3 in. (76 mm) beyond both sides of opening. Length of plate (transverse to steel floor unit direction) to extend to steel floor unit valley beyond each side of core-drilled hole with a min lap of 1-1/2 in. (38 mm) on the floor unit valley at each end. Circular cutout in plate to be 1/2 in. (13 mm) larger than the outside diam of through-penetrant. Max diam of opening is 5 in. (127 mm). Plate to be cut in half along the length of plate to permit installation around the nonmetallic pipe. Plate secured to valleys of floor unit using min 1/4 in. (6 mm) diam by 1-3/4 in. (44 mm) long steel expansion bolts, or equivalent. Fasteners to be located approx 1 in. (25 mm) from edges of plate at each corner, at each plate/valley intersection and at both sides of cut made to permit installation around nonmetallic pipe. When plate seam is located beneath the crest of the steel deck, a 2 in. (51 mm) wide 16 ga. galv steel plate to be centered over seam and attached to plate with min No. 10 sheet metal screws, max 3 in. (76 mm) O.C. on both sides of seam.

B. Fill, Void or Cavity Material* – Caulk or Sealant – Min 1/2 in. (13 mm) thickness of caulk applied within annular space, flush with the bottom of the upper portion of the flute. Min 1/2 in. (13 mm) thickness of caulk applied into flutes of steel floor units above metal plate enclosure to completely cover packing material (Item 3C).

3M COMPANY – CP 25 WB+ caulk, FB-3000 WT sealant or IC 15WB+ caulk. (Note: CP 25WB+ not suitable for use with CPVC pipes.)

B1 Fill, Void or Cavity Materials* – Caulk or Sealant – (Optional, Not Shown) - Min 1/4 in. thickness of caulk or sealant applied within annular space, flush with top of floor.

3M COMPANY – CP 25WB+ caulk, FB-3000 WT sealant, FB-1000 NS sealant, FB-1003 SL sealant or IC 15WB+ caulk

C. Packing Material – Min 4 pcf (64 kg/m³) mineral wool batt insulation firmly packed into flutes of steel floor units above metal plate enclosure to completely fill cavities. Packing material to be recessed within flutes from both edges of metal plate enclosure to accommodate the required thickness of fill material. Min 1-1/2 in. (38 mm) thickness of min 4 pcf (64 kg/m³) mineral wool batt insulation firmly packed into annular space, flush with bottom of floor.

D. Fill, Void or Cavity Materials* – Wrap Strip – Nom 1/8 in. (3.2 mm) thick intumescent material supplied in 2 in. (51 mm) wide strips. Wrap strip tightly wrapped around nonmetallic pipe with continuous layers and butted tightly against bottom of metal plate enclosure. The min number of layers required is dependent upon the nom diam of the pipe. For nom 2 in. (51 mm) diam (and smaller) pipes, one layer is required. For nom 2-1/2 and 3 in. (64 and 76 mm) diam pipes, two layers are required. For nom 3-1/2 and 4 in. (89 and 102 mm) diam pipes, three layers are required. Wrap strip layers temporarily held in position using aluminum foil tape, steel wire tie, or equivalent.

3M COMPANY – Ultra GS

E. Steel Collar – Nom 2 in. (51 mm) deep collar with 1-1/4 in. (32 mm) wide by 2 in. (51 mm) long anchor tabs and min 1/2 in. (13 mm) long tabs to retain wrap strip. Coils of precut min 0.016 in. (0.41 mm) thick (28 gauge) galv sheet steel available from wrap strip manufacturer. As an alternate, collar may be field-fabricated from min 0.016 in. thick (0.41 mm) (28 gauge) galv sheet steel in accordance with instruction sheet supplied by wrap strip manufacturer. Collar, with anchor tabs bent outward 90 deg, wrapped tightly around wrap strip with min 1 in. (25 mm) overlap at seam and compressed around wrap strip(s) using a min 1/2 in. (13 mm) wide by min 0.028 in. (0.71 mm) thick stainless steel band at the collar midheight. Collar anchor tabs pressed tightly against metal plate enclosure. Where the anchor tabs are beneath the valley of the steel floor unit, the anchor tabs are to be secured with 1/4 in. (6 mm) diam by min 1-1/2 in. (38 mm) long steel expansion bolts, or equivalent, in conjunction with min 1-1/4 in. (32 mm) diam steel fender washers with one anchor bolt in each anchor tab. Where the anchor tabs are beneath the crest of the steel deck, the anchor tabs are to be secured to the metal enclosure with No. 10 by min 1/2 in. (13 mm) long self-drilling, self-tapping steel screws and min 1-1/4 in. (32 mm) diam steel fender washers. Retainer tabs bent 90 deg toward pipe to lock wrap strip(s) in position.

F. Firestop Device* – (Not Shown) – As an alternate to Items D and E, a Firestop device consisting of a sheet-steel split collar lined with intumescent material may be used. Firestop device to be installed on underside of floor or on both sides of wall in accordance with the accompanying installation instructions.

3M COMPANY – Ultra PPD 1.5, 2.0, 3.0, 4.0.

G. Firestop Device* – As an alternate to Items 3D and 3E, firestop device to be installed in accordance with the accompanying installation instructions. Firestop device to be installed and latched around pipe and secured to the underside of the floor. Collar anchor tabs pressed tightly against metal plate enclosure. Where the anchor tabs are beneath the valley of the steel floor unit, the anchor tabs are to be secured with 1/4 in. (6 mm) diam by min 1-1/4 in. (32 mm) long steel anchor bolts or equivalent in conjunction with 1-1/4 in. (32 mm) diam steel fender washers with one anchor bolt in each anchor tab. Where the anchor tabs are beneath the crest of the metal enclosure with No. 10 by min 1/2 in. (13 mm) long self-drilling, self-tapping steel screws and min 1-1/4 in. (32 mm) diam steel fender washers.

3M COMPANY – Ultra RC Pack 2.0, 3.0, 4.0



*Indicates such products shall bear the UL or cUL Certification Mark for jurisdictions employing the UL or cUL Certification (such as Canada), respectively.

Reprinted from the Online Certifications Directory with permission from UL©

System No. F-A-2218

June 11, 2012

F Rating – 2 Hr

FT Ratings – 1-3/4 and 2 Hr (See Item 2)

FH Ratings – 0 and 2 Hr (See Item 2)

FTH Ratings – 0 and 2 Hr (See Item 2)

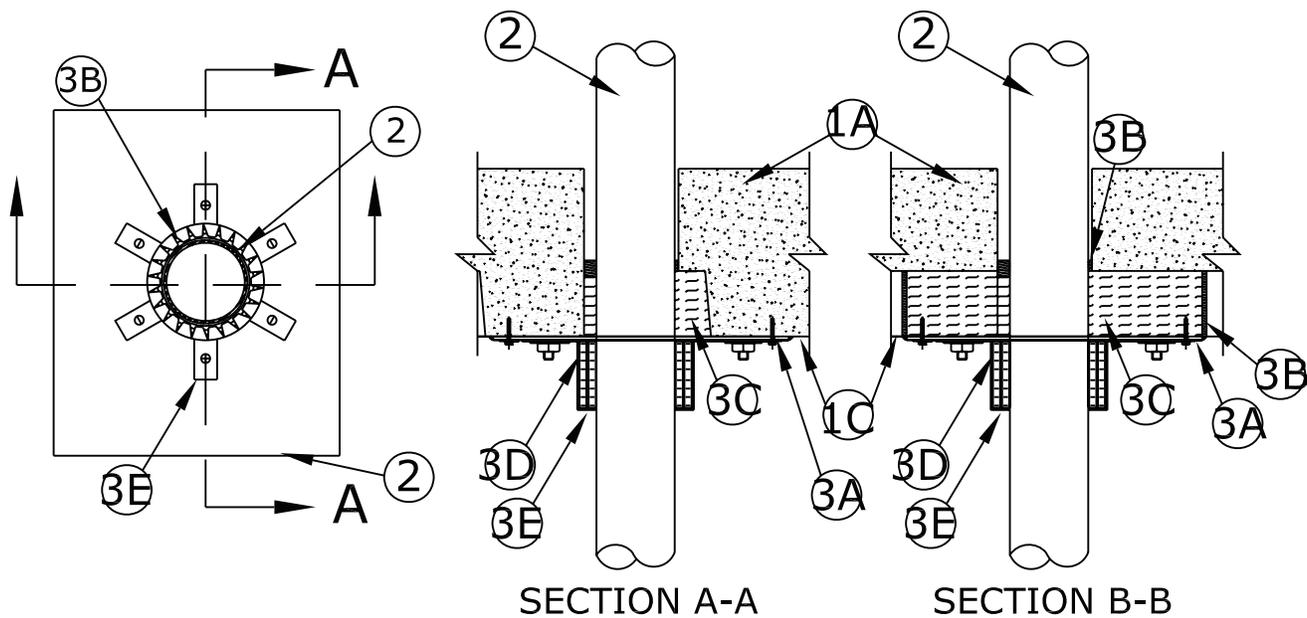

System tested with a pressure differential of 50 Pa between the exposed and the unexposed surfaces with the higher pressure on the exposed side.

- Floor Assembly** – The fire rated unprotected concrete and steel floor assembly shall be constructed of the materials and in the manner specified in the individual D900 Series designs in the UL Fire Resistance Directory and as summarized below:
 - Concrete** – Min 76 mm (3 in.) thick reinforced lightweight or normal weight (1600-2400 kg/m³ or 100-150 pcf) concrete.
 - Welded Wire Fabric** – (Not Shown) – 6x6-W1.4xW1.4.
 - Steel Floor and Form Units*** – Composite or non-composite 38 mm (1 1/2 in.) deep fluted galv units as specified in the individual Floor-Ceiling design. Diam of opening through floor to be 13 to 16 mm (1/2 to 5/8 in.) larger than the outside diam of through-penetrant (Item 2). Max diam of opening is 127 mm (5 in.).
- Through Penetrant** – One nonmetallic pipe or conduit to be centered within opening with a nom annular space between penetrant and periphery of opening of 6 mm (1/4 in.). Penetrant to be rigidly supported on both sides of the floor or wall assembly. The following types and sizes of nonmetallic pipes may be used:
 - Polyvinyl Chloride (PVC) Pipe** – Nom 102 mm (4 in.) diam (or smaller) Schedule 40 solid core or cellular core PVC pipe for use in closed (process or supply) or vented (drain, waste or vent) piping systems.
 - Rigid Nonmetallic Conduit+** – Nom 102 mm (4 in.) diam (or smaller) Schedule 40 PVC conduit installed in accordance with National Electrical Code (NFPA No. 70).
 - Chlorinated Polyvinyl Chloride (CPVC) Pipe** – Nom 102 mm (4 in.) diam (or smaller) SDR13.5 CPVC pipe for use in closed (process or supply) piping systems.
 - Acrylonitrile Butadiene Styrene (ABS) Pipe** – Nom 102 mm (4 in.) diam (or smaller) Schedule 40 solid core or cellular core ABS pipe for use in closed (process or supply) or vented (drain, waste or vent) piping systems.

The FT, FH and FTH Ratings are 2 hr for the cellular core ABS penetrant type. For all other penetrant types, the FT Rating is 1-3/4 hr and the FH and FTH Ratings are 0 hr.

- Firestop System** – The details of the firestop system shall be as follows:
 - Metal Plate Enclosure** – Min 1.5 mm (0.060 in.) thick (16 gauge) galv steel. Width of plate to extend a min of 76 mm (3 in.) beyond both sides of opening. Length of plate (transverse to steel floor unit direction) to extend to steel floor unit valley beyond each side of core-drilled hole with a min lap of 38 mm (1-1/2 in.) on the floor unit valley at each end. Circular cutout in plate to be 13 mm (1/2 in.) larger than the outside diam of through-penetrant. Max diam of opening is 127 mm (5 in.). Plate to be cut in half along the length of plate to permit installation around the nonmetallic pipe. Plate secured to valleys of floor unit using min 6 mm (1/4 in.) diam by 44 mm (1-3/4 in.) long steel expansion bolts, or equivalent. Fasteners to be located approx 25 mm (1 in.) from edges of plate at each corner, at each plate/valley intersection and at both sides of cut made to permit installation around nonmetallic pipe. When plate seam is located beneath the crest of the steel deck, a 51 mm (2 in.) wide min 1.5 mm (0.060 in.) thick (16 gauge) galv steel plate to be centered over seam and attached to plate with min No. 10 sheet metal screws, max 76 mm (3 in.) O.C. on both sides of seam.
 - Fill, Void or Cavity Material* – Caulk or Sealant** – Min 13 mm (1/2 in.) thickness of caulk applied within annular space, flush with the bottom of the upper portion of the flute. Min 13 mm (1/2 in.) thickness of caulk applied into flutes of steel floor units above metal plate enclosure to completely cover packing material (Item 3C).

3M COMPANY

3M FIRE PROTECTION PRODUCTS – CP 25 WB+ caulk, FB-3000 WT sealant or IC 15WB+ caulk. (Note: CP 25WB+ not suitable for use with CPVC pipes.)

System No. F-A-2218 *continued*

B1. **Fill, Void or Cavity Materials* – Caulk or Sealant** – (Optional, Not Shown) – Min 6 mm (1/4 in.) thickness of caulk or sealant applied within annular space, flush with top of floor.

3M COMPANY

3M FIRE PROTECTION PRODUCTS – CP 25WB+ caulk, FB-3000 WT sealant, FB-1000 NS sealant, FB-1003 SL sealant or IC 15WB+ caulk

- C. **Packing Material** – Min 64 kg/m³ (4 pcf) mineral wool batt insulation firmly packed into flutes of steel floor units above metal plate enclosure to completely fill cavities. Packing material to be recessed within flutes from both edges of metal plate enclosure to accommodate the required thickness of fill material. Min 38 mm (1-1/2 in.) thickness of min 64 kg/m³ (4 pcf) mineral wool batt insulation firmly packed into annular space, flush with bottom of floor.
- D. **Fill, Void or Cavity Materials* – Wrap Strip** – Nom 3.2 mm (1/8 in.) thick intumescent material supplied in 51 mm (2 in.) wide strips. Wrap strip tightly wrapped around nonmetallic pipe with continuous layers and butted tightly against bottom of metal plate enclosure. The min number of layers required is dependent upon the nom diam of the pipe. For nom 51 mm (2 in.) diam (and smaller) pipes, one layer is required. For nom 64 and 76 mm (2-1/2 and 3 in.) diam pipes, two layers are required. For nom 89 and 102 mm (3-1/2 and 4 in.) diam pipes, three layers are required. Wrap strip layers temporarily held in position using aluminum foil tape, steel wire tie, or equivalent.

3M COMPANY

3M FIRE PROTECTION PRODUCTS – Ultra GS

- E. **Steel Collar** – Nom 51 mm (2 in.) deep collar with 32 mm (1-1/4 in.) wide by 51 mm (2 in.) long anchor tabs and min 13 mm (1/2 in.) long tabs to retain wrap strip. Coils of precut min 0.41 mm (0.016 in.) thick (28 gauge) galv sheet steel available from wrap strip manufacturer. As an alternate, collar may be field-fabricated from min 0.41 mm (0.016 in.) thick (28 gauge) galv sheet steel in accordance with instruction sheet supplied by wrap strip manufacturer. Collar, with anchor tabs bent outward 90 deg, wrapped tightly around wrap strip with min 1 in. (25 mm) overlap at seam and compressed around wrap strip(s) using a min 13 mm (1/2 in.) wide by min 0.71 mm (0.028 in.) thick stainless steel band at the collar midheight. Collar anchor tabs pressed tightly against metal plate enclosure. Where the anchor tabs are beneath the valley of the steel floor unit, the anchor tabs are to be secured with 6 mm (1/4 in.) diam by min 38 mm (1-1/2 in.) long steel expansion bolts, or equivalent, in conjunction with min 32 mm (1-1/4 in.) diam steel fender washers with one anchor bolt in each anchor tab. Where the anchor tabs are beneath the crest of the steel deck, the anchor tabs are to be secured to the metal enclosure with No. 10 by min 13 mm (1/2 in.) long self-drilling, self-tapping steel screws and min 32 mm (1-1/4 in.) diam steel fender washers. Retainer tabs bent 90 deg toward pipe to lock wrap strip(s) in position.
- F. **Firestop Device*** – (Not Shown) – As an alternate to Items D and E, a Firestop device consisting of a sheet-steel split collar lined with intumescent material may be used. Firestop device to be installed on underside of floor or on both sides of wall in accordance with the accompanying installation instructions.

3M COMPANY

3M FIRE PROTECTION PRODUCTS – Ultra PPD 1.5, 2.0, 3.0, 4.0.

- G. **Firestop Device*** – As an alternate to Items 3D and 3E, firestop device to be installed in accordance with the accompanying installation instructions. Firestop device to be installed and latched around pipe and secured to the underside of the floor. Collar anchor tabs pressed tightly against metal plate enclosure. Where the anchor tabs are beneath the valley of the steel floor unit, the anchor tabs are to be secured with 6 mm (1/4 in.) diam by min 32 mm (1-1/4 in.) long steel anchor bolts or equivalent in conjunction with 32 mm (1-1/4 in.) diam steel fender washers with one anchor bolt in each anchor tab. Where the anchor tabs are beneath the crest of the metal enclosure with No. 10 by min 13 mm (1/2 in.) long self-drilling, self-tapping steel screws and min 32 mm (1-1/4 in.) diam steel fender washers.

3M COMPANY

3M FIRE PROTECTION PRODUCTS – Ultra RC Pack 2.0, 3.0, 4.0

*Bearing the UL Classification Mark

Reprinted from the Online Certifications Directory with permission from UL

© 2012 UL LLC



Through Penetrations

Non-Metallic Pipes

2000 Series

Concrete

FA

Non-Metallic Pipes • Wood Frame Floor/Ceiling

| 3M UL Systems | "F" Rating | 3M Product | Through Penetrant Details |
|---------------|------------|--|--|
| F-C-2395 | 1 | 3M™ Fire Barrier Water Tight Sealant 3000 WT | Max 2 in. CPVC pipe through a Floor/Ceiling Assembly. Pressure Differential of 50PA |
| F-C-2469 | 1 | 3M™ Fire Barrier Water Tight Sealant 3000 WT | Max 2 in. nonmetallic pipe through floor/ceiling assembly. Pressure Differential of 50PA |



UL System No. F-C-2395
XHEZ7 - Through-penetration Firestop Systems Certified for Canada

June 23, 2010

F Rating — 1 Hr
 FT Rating — 1/2 Hr
 FH Rating — 0 Hr
 FTH Rating — 0 Hr

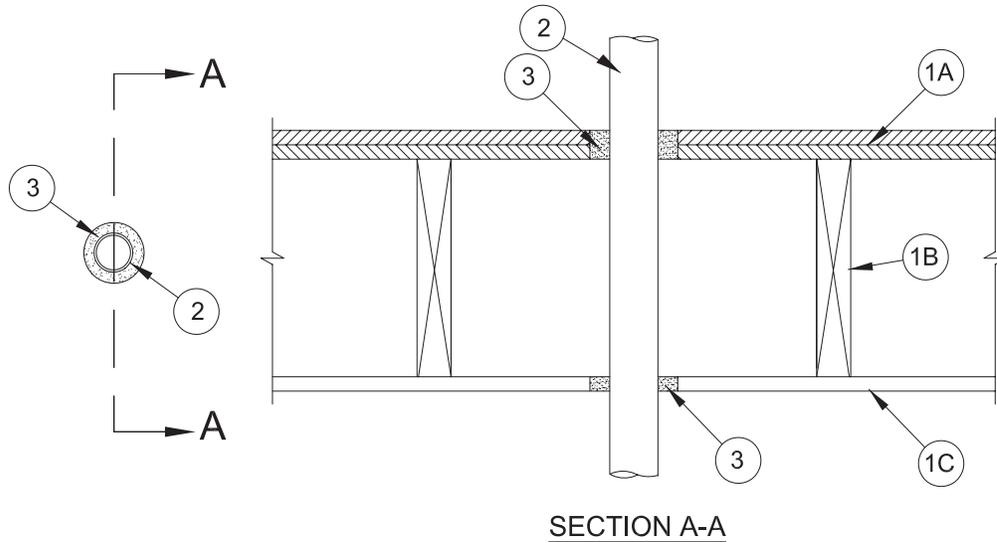

System tested with a pressure differential of 50 Pa between the exposed and the unexposed surfaces with the higher pressure on the exposed side.

- 1. Floor-Ceiling Assembly** – The 1 hr fire-rated solid or trussed lumber joist floor-ceiling assembly shall be constructed of the materials and in the manner specified in the individual L500 Series Floor-Ceiling Designs in the UL Fire Resistance Directory. The general construction details of the floor-ceiling assembly are summarized below:
 - A. Flooring System** – Lumber or plywood subfloor with finish floor of lumber, plywood or **Floor Topping Mixture*** as specified in the individual Floor-Ceiling Design. Diameter of opening shall be 32 mm (1-1/4 in.) larger than the nom diam of penetrant (Item 2).
 - B. Wood Joists** – Nom 254 mm (10 in.) deep (or deeper) lumber, steel or combination lumber and steel joists, trusses or **Structural Wood Members*** with bridging as required and with ends firestopped.
 - C. Gypsum Board*** – Nom 1219 mm (4 ft) wide by 16 mm (5/8 in.) thick as specified in the individual Floor-Ceiling Design. Diameter of opening shall be 32 mm (1-1/4 in.) larger than the nom diam of penetrant (Item 2).
- 1.1. Chase Wall** – (Optional, not shown) – The penetrant (Item No. 2) may be routed through a fire-rated single, double or staggered wood stud/gypsum board chase wall having a fire rating consistent with that of the floor-ceiling assembly. The chase wall shall be constructed of the materials and in the manner specified in the individual U300 Series Wall and Partition Designs in the UL Fire Resistance Directory and shall include the following construction features:
 - A. Studs** – Nom 51 by 152 mm (2 by 6 in.) or double nom 51 by 102 mm (2 by 4 in.) lumber studs.
 - B. Sole Plate** – Nom 51 by 152 mm (2 by 6 in.) or parallel 51 by 102 mm (2 by 4 in.) lumber plates, tightly butted. Diameter of opening shall be 32 mm (1-1/4 in.) larger than the nom diam of penetrant (Item 2).
 - C. Top Plate** – The double top plate shall consist of two nom 51 by 152 mm (2 by 6 in.) or two sets of parallel 51 by 102 mm (2 by 4 in.) lumber plates, tightly butted. Diameter of opening shall be 32 mm (1-1/4 in.) larger than the nom diam of penetrant (Item 2).
 - D. Gypsum Board*** – Thickness, type, number of layers and fasteners shall be as specified in individual Wall and Partition Design.
- 2. Through Penetrant** – One nonmetallic pipe to be centered within the firestop system. Pipe to be rigidly supported on both sides of floor-ceiling assembly. The annular space between pipe and periphery of opening shall be nom 9.5 mm (3/8 in.). The following types and sizes of nonmetallic pipes may be used:
 - A. Chlorinated Polyvinyl Chloride (CPVC) Pipe** – Nom 51 mm (2 in.) diam (or smaller) SDR13.5 CPVC pipe for use in closed (process or supply) or vented (drain, waste or vent) piping systems.
- 3. Fill, Void or Cavity Materials* – Sealant** – Min 19 mm (3/4 in.) thickness of fill material applied within the annulus, flush with top surface of floor. Min 16 mm (5/8 in.) thickness of fill material applied within the annulus, flush with bottom surface of ceiling.

3M COMPANY 3M FIRE PROTECTION PRODUCTS — FB-3000 WT

* Indicates such products shall bear the UL or cUL Certification Mark for jurisdictions employing the UL or cUL Certification (such as Canada), respectively.
 Reprinted from the Online Certifications Directory with permission from UL©





UL System No. F-C-2469
XHEZ7 - Through-penetration Firestop Systems Certified for Canada

May 18, 2018

F Rating — 1 Hr

FT Rating — 0 Hr

FH Rating — 1 Hr

FTH Rating — 0 Hr

Leakage Rating at Ambient — Less Than 1 CFM/ft²

Leakage Rating at 204° C — 5 CFM/ft²

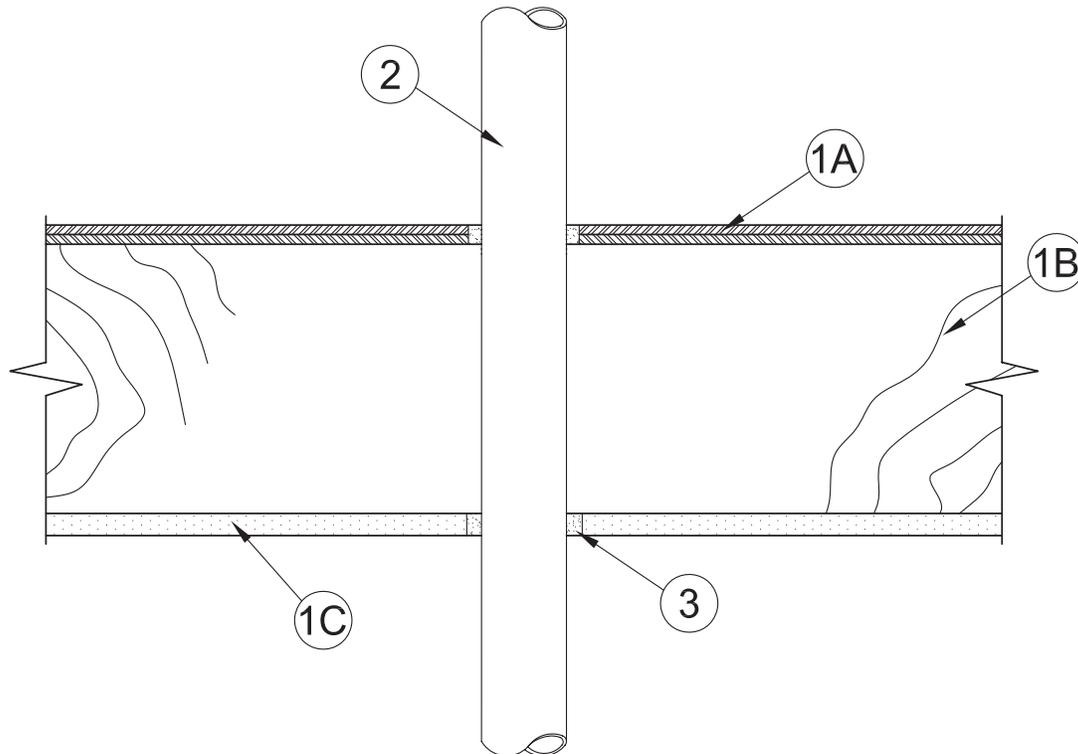

System tested with a pressure difference of 50 Pa between the exposed and unexposed surfaces with the higher pressure on the exposed surface.

1. **Floor Assembly** – The 1 hr fire rated solid or trussed lumber joist floor-ceiling assembly shall be constructed of the materials and in the manner specified in the individual L500 Series Floor-Ceiling Designs in the UL Fire Resistance Directory. The general construction details of the floor-ceiling assembly are summarized below:
 - A. **Flooring System** – Lumber or plywood subfloor with finish floor of lumber, plywood or Floor Topping Mixture* as specified in the individual Floor-Ceiling Design. Diam of opening to be 25 mm (1 in.) larger than nom size of penetrant.
 - B. **Wood Joists** – Nom 254 mm deep (1 in.) (or deeper) lumber, steel or combination lumber and steel joists, trusses or Structural Wood Members* with bridging as required and with ends firestopped.
 - C. **Gypsum Board*** – Min 16 mm (5/8 in.) thick, as specified in the individual Floor-Ceiling Design. Diam of opening to be 25 mm larger than nom size of penetrant.
- 1.1. **Chase Wall** – (Optional) – (Optional, Not Shown) — The through penetrants (Item 2) may be routed through a 1 hr fire-rated single, double or staggered wood stud/gypsum wallboard chase wall constructed of the materials and in the manner specified in the individual U300 Series Wall and Partition Designs in the UL Fire Resistance Directory and shall include the following construction features:
 - A. **Studs** – Nom 51 by 102 mm (2 by 4 in.) (or larger) or double nom 51 by 102 mm (2 by 4 in.) lumber studs.
 - B. **Sole Plate** – Nom 51 by 102 mm (2 by 4 in.) (or larger) or parallel 51 by 102 mm (2 by 4 in.) lumber plates, tightly butted. Diam of opening to be 25 mm (1 in.) larger than nom size of penetrant.
 - C. **Top Plate** – The double top plate shall consist of two nom 51 by 102 mm (2 by 4 in.) (or larger) or two sets of parallel nom 51 by 102 mm (2 by 4 in.) (or larger) lumber plates, tightly butted. Diam of opening to be 25 mm larger than nom size of penetrant.
 - D. **Gypsum Board*** – Thickness, type, number of layers and fasteners shall be as specified in individual Wall and Partition Design.

- 2. Through-Penetrant** – One nonmetallic pipe, conduit or tubing to be centered within the firestop system. Annular spaces between pipe and edge of opening to be min 6 mm and max 10 mm. Pipe to be rigidly supported on both sides of floor-ceiling assembly. The following types and sizes of nonmetallic pipes may be used:
- A. Polyvinyl Chloride (PVC) Pipe** – Nom 51 mm (2 in.) diam (or smaller) Schedule 40 solid or cellular core PVC pipe for use in closed (process or supply) or vented (drain, waste or vent) piping system.
 - B. Chlorinated Polyvinyl Chloride (CPVC) Pipe** – Nom 51 mm (2 in.) diam (or smaller) SDR13.5 CPVC pipe for use in closed (process or supply) piping systems.
 - C. Acrylonitrile Butadiene Styrene (ABS) Pipe** – Nom 51 mm (2 in.) diam (or smaller) Schedule 40 solid or cellular core ABS pipe for use in closed (process or supply) or vented (drain, waste or vent) piping system.
 - D. Rigid Nonmetallic Conduit+** – Nom 51 mm (2 in.) diam (or smaller) Schedule 40 PVC conduit installed in accordance with the National Electrical Code (NFPA No. 70).
 - E. Electrical Nonmetallic Tubing (ENT+)** – Nom 51 mm (2 in.) diam (or smaller) corrugated-wall electrical nonmetallic tubing (ENT) constructed of polyvinyl chloride (PVC) and installed in accordance with the National Electrical Code (NFPA No. 70).
See Electrical Nonmetallic Tubing (FKHU) category in the Electrical Construction Materials Directory for names of manufacturers.
 - F. Flexible Nonmetallic Conduit, Liquid-Tight (FNMC)+** – Nom 51 mm (2 in.) diam (or smaller) corrugated-wall flexible nonmetallic conduit, liquid-tight (FNMC) constructed of polyvinyl chloride (PVC) and installed in accordance with the National Electrical Code (NFPA No. 70).
See Flexible Nonmetallic Conduit, Liquid-Tight (DXOQ) category in the Electrical Construction Materials Directory for names of manufacturers.
 - G. Crosslinked Polyethylene (PEX) Tubing** – Nom 51 mm (2 in.) diam (or smaller) SDR 7.3 or SDR 9 PEX tubing for use in closed (process or supply) piping systems or nom 50 mm diam (or smaller) SDR 9 PEX tubing for use in closed (process or supply) or vented (drain, waste or vent) piping systems.
 - H. Rigid Nonmetallic Conduit+** – Nom 51 mm (2 in.) diam (or smaller) Schedule 40 PVC conduit installed in accordance with the National Electrical Code (NFPA No. 70).
- 3. Fill, Void or Cavity Materials* – Sealant** – Min 19 mm (3/4 in.) thickness of fill material applied within the annulus, flush with top surface of floor or sole plate. Min 16 mm thickness of fill material applied within the annulus, flush with bottom surface of ceiling or lower top plate.
- 3M COMPANY 3M FIRE PROTECTION PRODUCTS** – FB-3000 WT



* Indicates such products shall bear the UL or cUL Certification Mark for jurisdictions employing the UL or cUL Certification (such as Canada), respectively.

Reprinted from the Online Certifications Directory with permission from UL©

Combos

FA

Concrete floors/Steel decks

Concrete or masonry walls with a minimum thickness less than or equal to 8 inches (203 mm)

Combos • Concrete

| 3M UL Systems | "F" Rating | 3M Product | Through Penetrant Details |
|---------------|------------|---|---|
| F-A-8037 | 2 | 3M™ Fire Barrier Mortar 3M™ Fire Barrier Wrap Strips FS-195+ | Min 4-1/2 in. concrete. Max 2 in. steel, max 2 in. iron, max 2 in. conduit, max 2 in. PVC (closed or vented), max 2 in. RNC, max 2 in. CPVC, max 12 in. x 1 in. min 26 gauge steel duct, max 12 in. x 1 in. min 16 ga steel cable tray, max 19% cable fill. |
| F-A-8038 | 2 | 3M™ FireDam™ Spray 200 | Min 4-1/2 in. concrete. Max 2 in. steel, max 2 in. iron, max 2 in. 2 in. conduit, max 12 in. x 1 in. min 26 gauge steel duct, max 12 in. x 1 in. min 16 ga steel cable tray, max 19% cable fill. |

System No. F-A-8037C

June 10, 2013
 F Rating – 2 Hr
 FT Rating – 1/4 Hr
 FH Rating – 0 Hr
 FTH Rating – 0 Hr

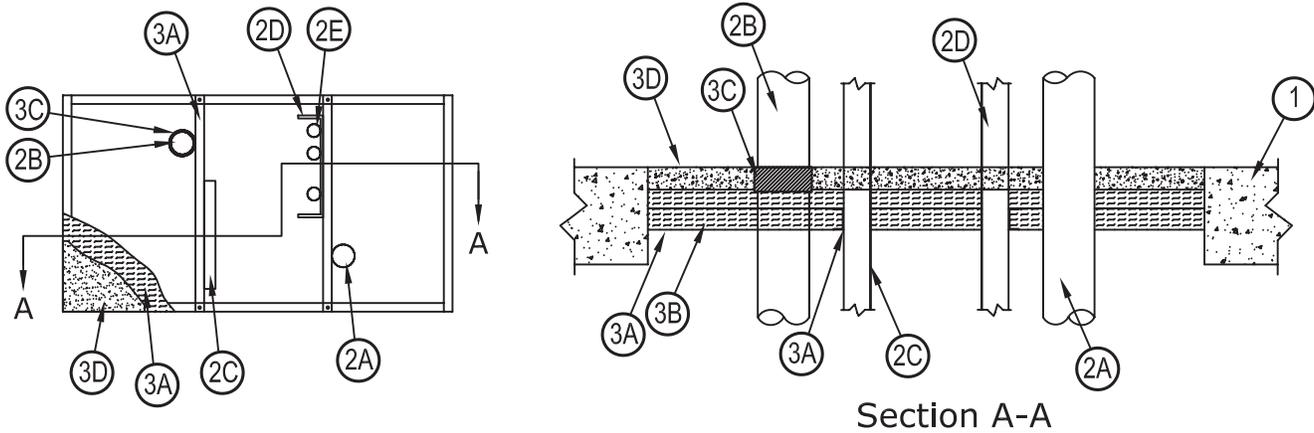

1. **Floor or Wall Assembly** – Min 114 mm (4-1/2 in.) thick reinforced lightweight or normal weight (1600-2400 kg/m³ or 100-150 pcf) concrete. Max area of opening is 7226 cm² (1120 in²) with max dimension of 1016 mm (40 in.)
2. **Through Penetrants** – A combination of the following through penetrants to be installed within the opening. A maximum of one steel duct (Item 2C) and one cable tray (Item 2D) to be installed in the opening. A maximum of two pipes/conduit (Item 2A and/or Item 2B) to be installed within each max 305 by 1016 mm (12 by 40 in.) framed area. Through penetrants to be rigidly supported on both sides of floor assembly. The annular space between metallic penetrants (Items 2A, 2C, 2D) and other nonmetallic penetrating items and cables (Items 2B and 2E) shall be min 242 mm (9-1/2 in.) The annular space between metallic penetrants (Items 2A, 2C, 2D) shall be min 242 mm (9-1/2 in.).
 - A. **Metallic Pipe and Conduit** – The following types and sizes of metallic pipes and conduits may be used. The annular space between metallic pipes / conduit and the periphery of the opening shall be min 140 mm (5-1/2 in.)
 - 2A1. **Steel Pipe** – Nom 51 mm (2 in.) diam (or smaller) Schedule 10 (or heavier) steel pipe.
 - 2A2. **Iron Pipe** – Nom 51 mm (2 in.) diam (or smaller) cast or ductile iron pipe.
 - 2A3. **Conduit** – Nom 51 mm (2 in.) diam (or smaller) steel electrical metallic tubing or nom 51 mm (2 in.) diam (or smaller) steel conduit.
 - B. **Nonmetallic Pipe and Conduit** – The following types and sizes of nonmetallic pipes and conduits may be used. The annular space between nonmetallic pipes / conduit and the periphery of the opening shall be min 140 mm (5-1/2 in.)
 - 2B1. **Polyvinyl Chloride (PVC) Pipe** – Nom 51 mm (2 in.) diam (or smaller) Schedule 40 solid core PVC pipe for use in closed (process or supply) or vented (drain, waste or vent) piping systems.
 - 2B2. **Rigid Nonmetallic Conduit** – Nom 51 mm (2 in.) diam (or smaller) Schedule 40 PVC conduit installed in accordance with the Canadian Electrical Code.
 - 2B3. **Chlorinated Polyvinyl Chloride (CPVC) Pipe** – Nom 51 mm (2 in.) diam (or smaller) SDR 13.5 (or heavier) CPVC pipe for use in closed (process or supply) piping systems.
 - C. **Metallic Duct** – Nom 305 by 25 mm (12 by 1 in.) (or smaller) by 26 gauge (or heavier) steel duct. The annular space between duct and the periphery of the opening shall be min 25 mm (1 in.) The long dimension of duct shall be located against a cross brace (Item 4A) and secured to cross brace with steel screws max 51 mm (2 in.) from ends and max 102 mm (4 in.) on center.
 - D. **Cable Tray** – Nom 305 mm (12 in.) wide by 25 mm (1 in.) deep (or smaller) by 16 gauge (or heavier) perforated steel cable tray. The annular space between cable tray and the periphery of the opening shall be min 25 mm (1 in.) The long dimension of cable tray shall be located against a cross brace (Item 4A) and secured to cross brace with steel screws max 51 mm (2 in.) from ends and max 203 mm (8 in.) on center.
 - E. **Cables** – Aggregate cross-sectional area of cables in cable tray not to exceed 19 percent of the cross-sectional area of the cable tray based on a max 25 mm (1 in.) cable loading depth within the tray. Any combination of the following types and sizes of copper conductor cables may be used:
 - 2E1. Max 4 pair No. 24 AWG copper conductor Cat 6 telephone cable with PVC insulation and jacket materials.
 - 2E2. Max RG/6 (or smaller) coaxial cable with fluorinated ethylene (FE) or PVC insulation and jacket materials.
 - 2E3. Max RG/U (or smaller) coaxial cable with fluorinated ethylene (FE) or PVC insulation and jacket materials.
 - 2E4. Max 7/C No. 12 AWG copper conductors with PVC insulation and jacket materials.
3. **Firestop System** – The firestop system shall consist of the following:
 - A. **Steel Support Grid** – Min 25 by 25 mm (1 by 1 in.) by min 3.2 mm (1/8 in.) thick steel angle installed within opening to frame all four sides and provide edge support for the forming material, 82 mm (3-1/4 in.) below top surface of floor. Angles secured to concrete using min 25 mm (1 in.) long masonry anchors spaced max 305 mm (12 in.) on center and max 51 mm (2 in.) from ends. Additional angle(s) to be installed as cross bracing to provide intermediate support for the forming material along the long dimension of opening. The cross member(s) are to be located max 305 mm (12 in.) from ends of opening and max 305 mm (12 in.) on center along the long dimension of opening. Each end of cross brace angle bears on and is secured to perimeter angle with min one 15 mm (3/4 in.) long No. 8 (or larger) self-tapping steel screw.

System No. F-A-8037C *continued*

- B. **Forming Material*** – Min 51 mm (2 in.) thickness of min 64 kg/m³ (4 pcf) density mineral wool batt insulation laid within opening over the steel support grid. Forming material cut to fit contour around all penetrants to provide a tight friction fit and a base for the firestop mortar.

ROXULINC – Type Safe

- C. **Fill, Void or Cavity Materials* – Wrap Strip** – Nom 6 mm (1/4 in.) thick intumescent elastomeric material faced on one side with aluminum foil, supplied in 51 mm (2 in.) wide strips. One nom 51 mm (2 in.) wide strip tightly-wrapped around each nonmetallic pipe (Item 2B) with foil side exposed. Wrap strip located just above the forming material base (Item 4B) such that the bottom edge is flush with the forming material. Wrap strip held in place with pressure-sensitive tape.

3M COMPANY

3M FIRE PROTECTION PRODUCTS – FS-195+

- D. **Fill, Void or Cavity Materials* – Mortar** – Min 30 mm (1.2 in.) thickness of mortar applied to completely fill the opening annulus above the forming material, flush with top surface of floor. Cementitious mortar mixed with water at a rate of 1.0 part dry mixture to 0.3 parts water by weight in accordance with the installation instructions supplied with the product.

3M COMPANY

3M FIRE PROTECTION PRODUCTS – 3M Fire Barrier Mortar

*Bearing the UL Classification Mark

+Bearing the UL Listing Mar

Reprinted from the Online Certifications Directory with permission from UL
© 2013 UL LLC



Through Penetrations

Compos

8000 Series

Concrete

CAJ

System No. F-A-8038C

June 10, 2013
 F Rating – 2 Hr
 FT Rating – 1/4 Hr
 FH Rating – 0 Hr
 FTH Rating – 0 Hr

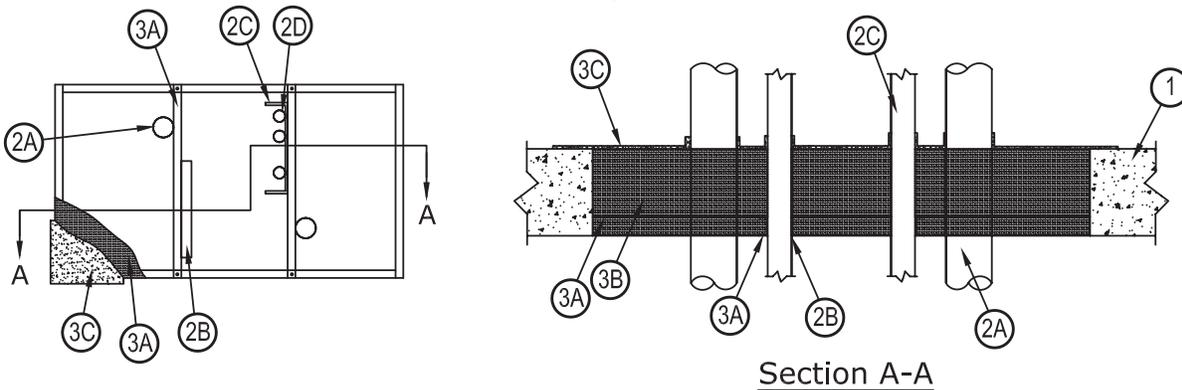

1. **Floor or Wall Assembly** – Min 114 mm (4-1/2 in.) thick reinforced lightweight or normal weight (1600-2400 kg/m³ or 100-150 pcf) concrete. Max area of opening is 7226 cm² (1120 in²) with max dimension of 1016 mm (40 in.)
2. **Through Penetrants** – A combination of the following through penetrants to be installed within the opening. A maximum of one steel duct (Item 2B) and one cable tray (Item 2C) to be installed in the opening. A maximum of two metallic pipes/conduit (Item 2A) to be installed within each max 305 by 1016 mm (12 by 40 in.) framed area. Through penetrants to be rigidly supported on both sides of floor assembly. The annular space between penetrants shall be min 242 mm (9-1/2 in.)
 - A. **Metallic Pipe and Conduit** – The following types and sizes of metallic pipes and conduits may be used. The annular space between metallic pipes / conduit and the periphery of the opening shall be min 140 mm (5-1/2 in.)
 - 2A1. **Steel Pipe** – Nom 51 mm (2 in.) diam (or smaller) Schedule 10 (or heavier) steel pipe.
 - 2A2. **Iron Pipe** – Nom 51 mm (2 in.) diam (or smaller) cast or ductile iron pipe.
 - 2A3. **Conduit** – Nom 51 mm (2 in.) diam (or smaller) steel electrical metallic tubing or nom 51 mm (2 in.) diam (or smaller) steel conduit.
 - B. **Metallic Duct** – Nom 305 by 25 mm (12 by 1 in.) (or smaller) by 26 gauge (or heavier) steel duct. The annular space between duct and the periphery of the opening shall be min 25 mm (1 in.) The long dimension of duct shall be located against a cross brace (Item 4A) and secured to cross brace with steel screws max 51 mm (2 in.) from ends and max 102 mm (4 in.) on center.
 - C. **Cable Tray** – Nom 305 mm (12 in.) wide by 25 mm (1 in.) deep (or smaller) by 16 gauge (or heavier) perforated steel cable tray. The annular space between cable tray and the periphery of the opening shall be min 25 mm (1 in.) The long dimension of cable tray shall be located against a cross brace (Item 4A) and secured to cross brace with steel screws max 51 mm (2 in.) from ends and max 203 mm (8 in.) on center.
 - D. **Cables** – Aggregate cross-sectional area of cables in cable tray not to exceed 19 percent of the cross-sectional area of the cable tray based on a max 25 mm (1 in.) cable loading depth within the tray. Any combination of the following types and sizes of copper conductor cables may be used:
 - 2D1. Max 4 pair No. 24 AWG copper conductor Cat 6 telephone cable with PVC insulation and jacket materials.
 - 2D2. Max RG/6 (or smaller) coaxial cable with fluorinated ethylene (FE) or PVC insulation and jacket materials.
 - 2D3. Max RG/U (or smaller) coaxial cable with fluorinated ethylene (FE) or PVC insulation and jacket materials.
 - 2D4. Max 7/C No. 12 AWG copper conductors with PVC insulation and jacket materials.
3. **Firestop System** – The firestop system shall consist of the following:
 - A. **Steel Support Grid** – Min 25 by 25 mm (1 by 1 in.) by min 3.2 mm (1/8 in.) thick steel angle installed within opening to frame all four sides and provide edge support for the forming material, 102 mm (4 in.) below top surface of floor. Angles secured to concrete using min 25 mm (1 in.) long masonry anchors spaced max 305 mm (12 in.) on center and max 51 mm (2 in.) from ends. Additional angle(s) to be installed as cross bracing to provide intermediate support for the forming material along the long dimension of opening. The cross member(s) are to be located max 305 mm (12 in.) from ends of opening and max 305 mm (12 in.) on center along the long dimension of opening. Each end of cross brace angle bears on and is secured to perimeter angle with min one 15 mm (3/4 in.) long No. 8 (or larger) self-tapping steel screw.
 - B. **Forming Material*** – Min 4 in. (102 mm) thickness, or two layers of min 51 mm (2 in.) thickness, of min 96 kg/m³ (6 pcf) density mineral wool batt insulation laid within opening over the steel support grid. Forming material cut to span the steel supports (Item 3A) and to fit the contour around all penetrants to provide a tight friction fit.
ROXUL INC – Type Safe
 - C. **Fill, Void or Cavity Materials*** – Min 2 mm (0.08 in.) wet thickness of coating spray applied or troweled to completely cover the forming material (Item 3B) at both the top and bottom of opening. Coating to lap min 13 mm (1/2 in.) onto penetrants and onto concrete around periphery of opening, at both top and bottom of floor. Coating to be applied in accordance with the installation instructions supplied with the product.

3M COMPANY

3M FIRE PROTECTION PRODUCTS – FireDam 2000 Spray

*Bearing the UL Classification Mark

Reprinted from the Online Certifications Directory with permission from UL
 © 2013 UL LLC



3M Firestop Systems

Through Penetrations

Electrical Outlet Box

CLIV

Fire Protection for walls and partitions containing flush mounted devices

CLIV

| 3M Systems | "F" Rating | 3M Product | Application Details |
|------------|------------|---|--|
| CLIV | 1, 2 | 3M™ Fire Barrier Moldable Putty Pads MPP+ | Putty Pad system for metallic or nonmetallic outlet boxes installed as a membrane penetration in a gypsum wallboard assembly. Satisfies the 2015 International Building Code Section 714.4.2 requirements. Filed in UL category CLIV 'Wall Opening Protective Materials' tested to UL 263 (ASTM E 119) |

Through Penetrations • CLIV

Suggested Installation for 3M™ Fire Barrier Moldable Putty+ on Electrical Outlet Boxes

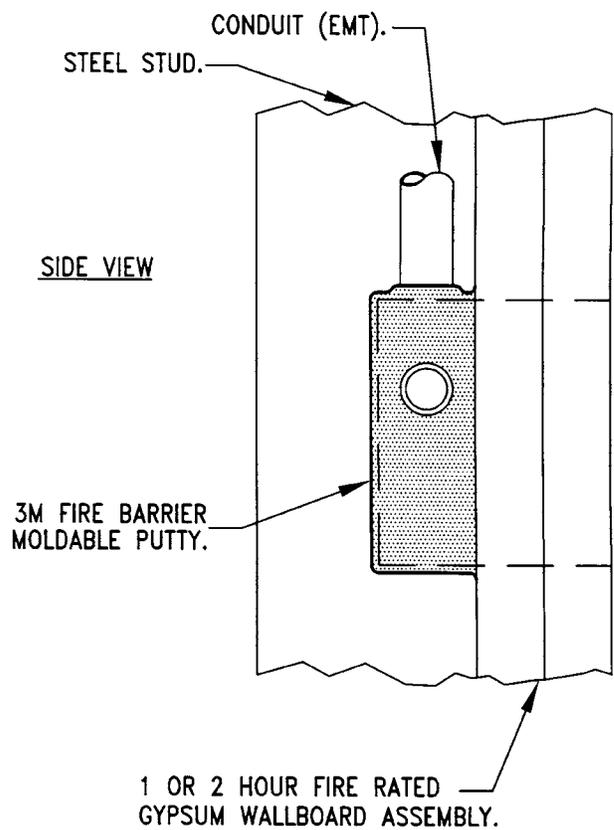
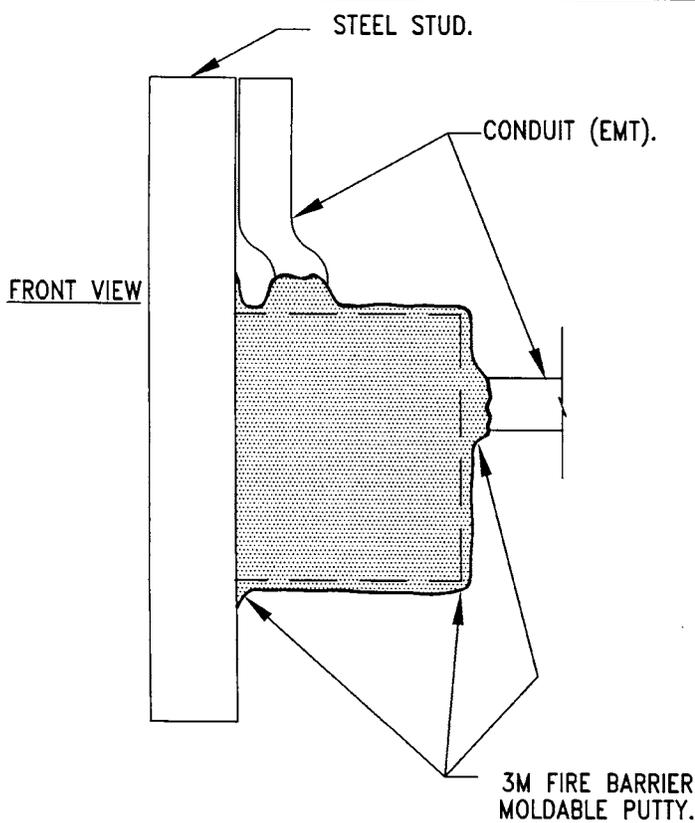
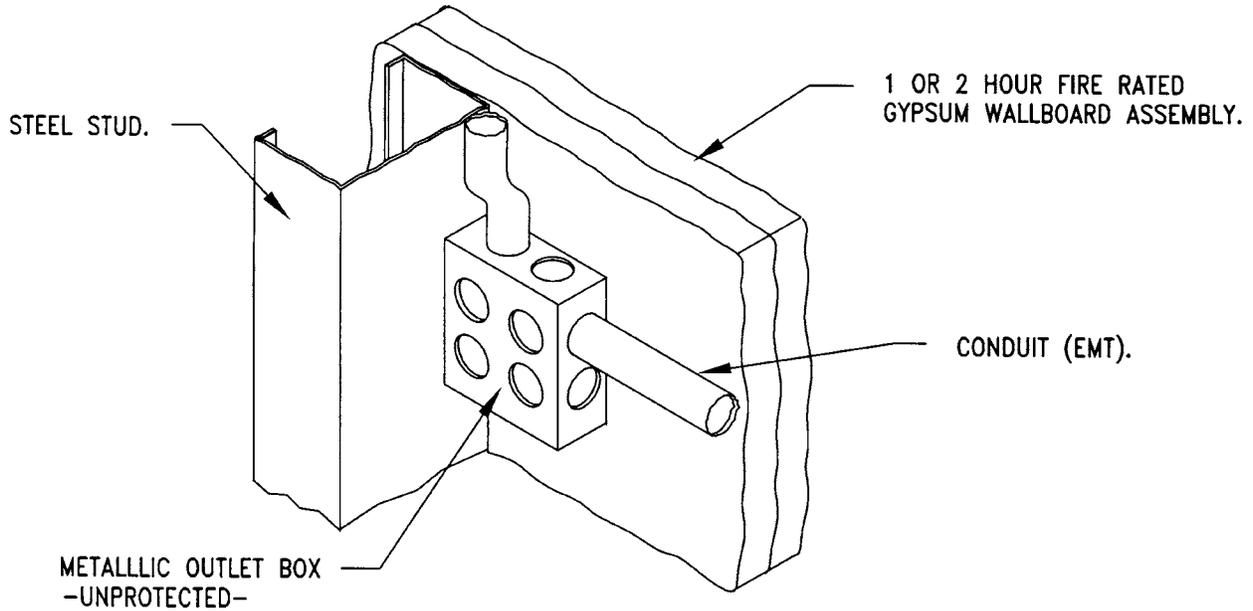

WALL OPENING PROTECTIVE MATERIALS (CLIV)

This category covers proprietary compositions which are used to maintain the hourly ratings of fire resistive walls and partitions containing flush mounted devices such as outlet boxes, electrical cabinets and mechanical cabinets. The individual Classifications indicate the specific applications and the method of installation for which the materials have been evaluated.

The basic standard used to investigate products in this category is ANSI/UL 263, "Fire Tests of Building Construction and Materials".

LOOK FOR CLASSIFICATION MARKING ON PRODUCT

The Classification Marking of Underwriters Laboratories Inc. (shown below) on the product or container is the only method provided by Underwriters Laboratories Inc. to identify Wall Opening Protective Materials produced under its Classification and Follow-Up Service.

**UNDERWRITERS LABORATORIES INC.®
CLASSIFIED**

**WALL OPENING PROTECTIVE MATERIAL
FIRE RESISTANCE CLASSIFICATION
SEE PRODUCT CATEGORY IN UL FIRE
RESISTANCE DIRECTORY**

3M COMPANY 3M FIRE PROTECTION PRODUCTS R9700

3M CENTER, ST PAUL MN 55144 USA

Type MPP+ moldable putty pads for use with max 4-11/16 by 4-11/16 by 2-1/8 in. deep flush device UL Listed Metallic Outlet Boxes installed with steel cover plates for use in 1 or 2 hr fire rated gypsum board wall assemblies framed with min 3-1/2 in. wide wood or steel studs and constructed as specified in the individual U300, U400 or V400 Series Wall and Partition Designs in the Fire Resistance Directory.

Type MPP+ moldable putty pads for use with max 4-11/16 by 4-11/16 by 2 1/8 in. deep flush device UL Listed Metallic Outlet Boxes installed with steel or plastic cover plates for use in 1 hr or 2 hr fire rated gypsum board wall assemblies framed with min 5-1/2 in. wide wood or steel studs and constructed as specified in the individual U300, U400 or V400 Series Wall and Partition Designs in the Fire Resistance Directory. Metallic outlet boxes to be provided with steel attachment brackets which offset box min 1/4 in. from stud. Putty pad to be affixed to the back and all four sides of the box. Boxes may be installed back-to-back within the stud cavity. When back-to-back boxes are interconnected, a ball of putty is to be installed to plug the open end of each electrical metallic tube or conduit within the outlet boxes.

Type MPP+ moldable putty pads for use with max 4 by 4 by 2-1/8 in. deep flush device UL Listed Metallic Outlet Boxes installed with plastic cover plates for use in 1 or 2 hr fire rated gypsum board wall assemblies framed with min 3-1/2 in. wide wood or steel studs and constructed as specified in the individual U300, U400 or V400 Series Wall and Partition Designs in the Fire Resistance Directory.

Type MPP+ moldable putty pads for use with max 14 by 4 by 2-1/2 in. deep flush device UL Listed Metallic Outlet Boxes installed with steel cover plates for use in 1 or 2 hr fire rated gypsum board wall assemblies framed with min 3-1/2 in. wide steel studs and constructed as specified in the individual U400 or V400 Series Wall and Partition Designs in the fire Resistance Directory.

Type MPP+ moldable putty pads for use with max 14 by 4-1/2 by 2-1/2 in. deep UL Listed Nonmetallic Outlet Boxes manufactured

by Carlon Electrical Products, made of PVC and bearing a 2 hr rating under the "Outlet Boxes and Fittings Classified for Fire Resistance" category in the Fire Resistance Directory. Boxes installed with steel cover plates, for use in 1 or 2 hr rated gypsum board wall assemblies framed with min 3-1/2 in. wide wood studs and constructed as specified in the individual U300 Series Wall and Partition Designs in the Fire Resistance Directory.

Type MPP+ moldable putty pads for use with max 4 by 3-1/4 by 3-3/4 in. deep UL Listed Nonmetallic Outlet Boxes manufactured by Thomas & Betts Corp., made of polycarbonate, Type 234 or made of phenolic, Type 1052 and bearing a 2 hr rating under the "Outlet Boxes and Fittings Classified for Fire Resistance" category in the Fire Resistance Directory. Boxes installed with steel cover plates. For use in 1 hr fire rated gypsum board wall assemblies framed with min 3-1/2 in. wide wood studs and constructed as specified in the individual U300 series Wall and Partition Designs in the Fire Resistance Directory.

Type MPP+ moldable putty pads for use with max 4 by 3-3/4 by 3 in. deep UL Listed Nonmetallic Outlet Boxes manufactured by Carlon Electrical Products, made of PVC and bearing a 2 hr rating under the "Outlet Boxes and Fittings Classified for Fire Resistance" category in the Fire Resistance Directory. Boxes installed with plastic cover plates, for use in 1 hr rated gypsum board wall assemblies framed with min 3-1/2 in. wide wood studs and constructed as specified in the individual U300 Series Wall and Partition Designs in the Fire Resistance Directory.

Type MPP+ moldable putty pads for use with max 4 by 3-1/4 by 3-3/4 in. deep UL Listed Nonmetallic Outlet Boxes manufactured by Thomas & Betts Corp., made of phenolic, Type 2002-738-C and bearing a 2 hr rating under the "Outlet Boxes and Fittings Classified for Fire Resistance" category in the Fire Resistance Directory. Boxes installed with steel cover plates. For use in 2 hr fire rated gypsum board wall assemblies framed with min 3-1/2 in. wide steel studs and constructed as specified in the individual U400 or V400 Series Wall and Partition Designs in the Fire Resistance Directory.

Type MPP+ moldable putty pads for use with max 4 by 4 by 1-1/2 in. deep flush device UL Listed Metallic Outlet Boxes installed with plastic cover plates for use in 1 hr fire rated gypsum board wall assemblies framed with min 3-5/8 in. wide steel studs and constructed as specified in the individual U400 or V400 Series Wall and Partition Designs in the Fire Resistance Directory. Boxes may be installed back-to-back within the stud cavity.

Type MPP+ moldable putty pads for use with max 5 by 5 by 2 7/8 in. deep flush device UL Listed Metallic Outlet Boxes or UL Listed Communications-Circuit Accessories manufactured by Randl Industries Inc for use in 1 hr or 2 hr fire rated gypsum board wall assemblies framed with min 3-5/8 in. wide wood or steel studs and constructed as specified in the individual U300, U400 or V400 Series Wall and Partition Designs in the Fire Resistance Directory. Metallic outlet boxes to be provided with UL Listed Signal Appliance with steel cover plate manufactured by Cooper Wheelock Inc.

Moldable putty pads are to be installed to completely cover the exterior surfaces of the outlet box (except for the side of the outlet box against the stud unless otherwise noted) including nailing tabs and to completely seal against the stud within the stud cavity. Multiple moldable putty pads may be installed on an outlet box to attain the required minimum thickness of putty material. Additional putty material used to seal around each conduit and/or cable fitting on the exterior of each box. A min 1/10 in. thickness of putty material is required on the exterior surfaces of flush device boxes in 1 and 2 hr fire rated Wall and Partition Designs. When the moldable putty pad outlet box protective material is used on boxes on both sides of wall as directed, the horizontal separation between outlet boxes on opposite sides of the wall may be less than 24 in. provided that the outlet boxes are not installed back to back, except as noted.

Reprinted from the UL Online Certifications Directory
with permission from UL
© 2012 UL LLC



CLIV.R9700 Wall-opening Protective Materials

July 23, 2010

Type MPP+ moldable putty pads for use with max 4-11/16 by 4-11/16 by 2-1/8 in. deep flush device UL Listed Metallic Outlet Boxes installed with steel cover plates for use in 1 or 2 hr fire rated gypsum board wall assemblies framed with min 3-1/2 in. wide wood or steel studs and constructed as specified in the individual U300, U400 or V400 Series Wall and Partition Designs in the Fire Resistance Directory.

Type MPP+ moldable putty pads for use with max 4-11/16 by 4-11/16 by 2 1/8 in. deep flush device UL Listed Metallic Outlet Boxes installed with steel or plastic cover plates for use in 1 hr or 2 hr fire rated gypsum board wall assemblies framed with min 5-1/2 in. wide wood or steel studs and constructed as specified in the individual U300, U400 or V400 Series Wall and Partition Designs in the Fire Resistance Directory. Metallic outlet boxes to be provided with steel attachment brackets which offset box min 1/4 in. from stud. Putty pad to be affixed to the back and all four sides of the box. Boxes may be installed back-to-back within the stud cavity. When back-to-back boxes are interconnected, a ball of putty is to be installed to plug the open end of each electrical metallic tube or conduit within the outlet boxes.

Type MPP+ moldable putty pads for use with max 4 by 4 by 2-1/8 in. deep flush device UL Listed Metallic Outlet Boxes installed with plastic cover plates for use in 1 or 2 hr fire rated gypsum board wall assemblies framed with min 3-1/2 in. wide wood or steel studs and constructed as specified in the individual U300, U400 or V400 Series Wall and Partition Designs in the Fire Resistance Directory.

Type MPP+ moldable putty pads for use with max 14 by 4 by 2-1/2 in. deep flush device UL Listed Metallic Outlet Boxes installed with steel cover plates for use in 1 or 2 hr fire rated gypsum board wall assemblies framed with min 3-1/2 in. wide steel studs and constructed as specified in the individual U400 or V400 Series Wall and Partition Designs in the fire Resistance Directory.

Type MPP+ moldable putty pads for use with max 14 by 4-1/2 by 2-1/2 in. deep UL Listed Nonmetallic Outlet Boxes manufactured by Carlon Electrical Products, made of PVC and bearing a 2 hr rating under the "Outlet Boxes and Fittings Classified for Fire Resistance" category in the Fire Resistance Directory. Boxes installed with steel cover plates, for use in 1 or 2 hr rated gypsum board wall assemblies framed with min 3-1/2 in. wide wood studs and constructed as specified in the individual U300 Series Wall and Partition Designs in the Fire Resistance Directory.

Type MPP+ moldable putty pads for use with max 4 by 3-1/4 by 3-3/4 in. deep UL Listed Nonmetallic Outlet Boxes manufactured by Thomas & Betts Corp., made of polycarbonate, Type 234 or made of phenolic, Type 1052 and bearing a 2 hr rating under the "Outlet Boxes and Fittings Classified for Fire Resistance" category in the Fire Resistance Directory. Boxes installed with steel cover plates. For use in 1 hr fire rated gypsum board wall assemblies framed with min 3-1/2 in. wide wood studs and constructed as specified in the individual U300 series Wall and Partition Designs in the Fire Resistance Directory.

Type MPP+ moldable putty pads for use with max 4 by 3-3/4 by 3 in. deep UL Listed Nonmetallic Outlet Boxes manufactured by Carlon Electrical Products, made of PVC and bearing a 2 hr rating under the "Outlet Boxes and Fittings Classified for Fire Resistance category in the Fire Resistance Directory. Boxes installed with plastic cover plates, for use in 1 hr rated gypsum board wall assemblies framed with min 3-1/2 in. wide wood studs and constructed as specified in the individual U300 Series Wall and Partition Designs in the Fire Resistance Directory.

Type MPP+ moldable putty pads for use with max 4 by 3-1/4 by 3-3/4 in. deep UL Listed Nonmetallic Outlet Boxes manufactured by Thomas & Betts Corp., made of phenolic, Type 2002-738-C and bearing a 2 hr rating under the "Outlet Boxes and Fittings Classified for Fire Resistance" category in the Fire Resistance Directory. Boxes installed with steel cover plates. For use in 2 hr fire rated gypsum board wall assemblies framed with min 3-1/2 in. wide steel studs and constructed as specified in the individual U400 or V400 Series Wall and Partition Designs in the Fire Resistance Directory.

Type MPP+ moldable putty pads for use with max 4 by 4 by 1-1/2 in. deep flush device UL Listed Metallic Outlet Boxes installed with plastic cover plates for use in 1 hr fire rated gypsum board wall assemblies framed with min 3-5/8 in. wide steel studs and constructed as specified in the individual U400 or V400 Series Wall and Partition Designs in the Fire Resistance Directory. Boxes may be installed back-to-back within the stud cavity.

Type MPP+ moldable putty pads for use with max 5 by 5 by 2 7/8 in. deep flush device UL Listed Metallic Outlet Boxes or UL Listed Communications-Circuit Accessories manufactured by Randl Industries Inc for use in 1 hr or 2 hr fire rated gypsum board wall assemblies framed with min 3-5/8 in. wide wood or steel studs and constructed as specified in the individual U300, U400 or V400 Series Wall and Partition Designs in the Fire Resistance Directory. Metallic outlet boxes to be provided with UL Listed Signal Appliance with steel cover plate manufactured by Cooper Wheelock Inc.

Moldable putty pads are to be installed to completely cover the exterior surfaces of the outlet box (except for the side of the outlet box against the stud unless otherwise noted) including nailing tabs and to completely seal against the stud within the stud cavity. Multiple moldable putty pads may be installed on an outlet box to attain the required minimum thickness of putty material. Additional putty material used to seal around each conduit and/or cable fitting on the exterior of each box. A min 1/10 in. thickness of putty material is required on the exterior surfaces of flush device boxes in 1 and 2 hr fire rated Wall and Partition Designs. When the moldable putty pad outlet box protective material is used on boxes on both sides of wall as directed, the horizontal separation between outlet boxes on opposite sides of the wall may be less than 24 in. provided that the outlet boxes are not installed back to back, except as noted.

MPP+ Moldable Putty Pads

Wall-opening Protective Materials

CLIV





Bottom of Wall Static

BWS

Bottom of Wall Static Assemblies

Floor to Floor

FFD

Floor to Floor Dynamic

FFS

Floor to Floor Static

Floor to Wall

FWD

Floor to Wall Dynamic

FWS

Floor to Wall Static

Head of Wall

HWD

Head of Wall Dynamic

HWS

Head of Wall Static

Wall to Wall

WWD

Wall to Wall Dynamic

WWS

Wall to Wall Static

Continuity Head of Wall

CJD

Perimeter Joint

Perimeter Joint

CWD

Curtain Wall Dynamic

CWS

Curtain Wall Static

3M Firestop Systems

Construction Joints

Bottom of Wall Static

BWS

Bottom of Wall Static Assemblies

Quick Reference Guide

Bottom-of-Wall

| 3M UL Systems | "F" Rating | 3M Product | Through Penetrant Details |
|------------------|------------|---|--|
| BW-S-0007 | 1, 2 | 3M™ Fire Barrier Water Tight Sealant 1000 NS 3M™ Fire Barrier Silicone Sealant 2000+ 3M™ Fire Barrier Water Tight Sealant 3000 WT 3M™ Fire Barrier Sealant FD 150+ 3M™ Fire Barrier Sealant IC 15WB+ 3M™ Fire Barrier Sealant CP 25WB+ | Max. 1 in. bottom of wall joint between a steel stud gypsum wallboard assembly and a concrete floor. Static joint utilizing Fire Barrier sealants. |
| BW-S-0008 | 1, 2 | 3M™ FireDam™ Spray 200 3M™ Fire and Water Barrier Tape 3M™ Watertight Spray | Max. 2 in. bottom of wall joint between a steel stud gypsum wallboard assembly and a concrete floor. Static joint utilizing mineral wool and FireDam Spray 200, Fire Barrier Watertight Spray, or Fire and Water Barrier Tape. |
| BW-S-0037 | 1, 2 | 3M™ Fire Barrier Sealant CP 25WB+ 3M™ Fire Barrier Sealant IC 15WB+ 3M™ Fire Barrier Water Tight Sealant 1000 NS 3M™ Fire Barrier Water Tight Sealant 3000 WT 3M™ Fire Barrier Silicone Sealant 2000+ 3M™ Fire Barrier Sealant FD 150+ | Max. 1/2 in. bottom of wall joint between a gypsum shaft wall and a concrete floor. Static joint utilizing Fire Barrier sealants. |

System No. BW-S-0007

May 18, 2005

Assembly Ratings – 1 and 2 Hr (See Item 2)
L Rating at Ambient – Less Than 1 CFM/lin ft
L Rating at 400° F – Less Than 1 CFM/lin ft
Joint Width – 1 in. Max

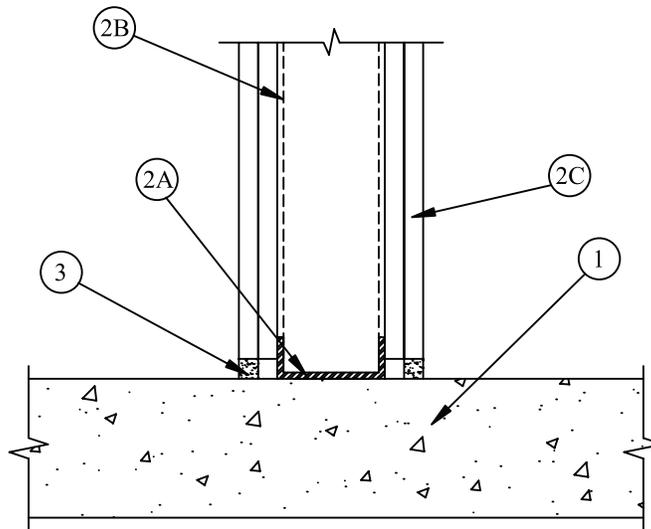

- Floor Assembly** – Min 4-1/2 in. (114 mm) thick reinforced lightweight or normal weight (100-150 pcf or 1600-2400 kg/m³) structural concrete. Floor may also be constructed of any 6 in. (152 mm) thick UL Classified hollow-core **Precast Concrete Units***. See **Precast Concrete Units** category in the Fire Resistance Directory for names of manufacturers.
- Wall Assembly** – The 1 or 2 h fire-rated gypsum board/steel stud wall assembly shall be constructed of the materials and in the manner specified in the individual U400 or V400 Series Wall or Partition Design in the UL Fire Resistance Directory. In addition, the wall may incorporate a head-of-wall joint system constructed as specified in the HW Series Joint Systems in the UL Fire Resistance Directory. The wall shall include the following construction features:
 - Steel Floor Runner** – Floor runners of wall assembly shall consist of min No. 25 gauge galv steel channels sized to accommodate steel studs (Item 2C). Floor runners to be provided with min 1-1/4 in. (32 mm) flanges. Runners secured with steel fasteners spaced 12 in. (305 mm) OC.
 - Studs** – Steel studs to be min 3-1/2 in. wide. (89 mm) Studs cut 1/2 to 3/4 in. (13 to 19 mm) less in length than assembly height with bottom nesting in, resting on and fastened to floor runner with sheet metal screws. Stud spacing not to exceed 24 in. (610 mm) OC.
 - Gypsum Board*** – Gypsum board installed to a min total thickness of 5/8 or 1-1/4 in. (16 or 32 mm) on each side of wall for a 1 or 2 hr rated wall, respectively. Wall to be constructed as specified in the individual U400 or V400 Series Design in the UL Fire Resistance Directory, except that a max 1 in. (25 mm) gap shall be maintained between the bottom of gypsum board and top of concrete floor.

The hourly fire rating of the joint system is equal to the hourly fire rating of the wall.
- Fill, Void or Cavity Material* – Caulk or Sealant** – Max separation between top of floor and bottom of gypsum board is 1 in. (25 mm). Min 5/8 in. (16 mm) thickness of fill material installed on each side of the wall between the bottom of the gypsum board and the top of the concrete floor, flush with each surface of the wall.

3M COMPANY – FB1000 NS, FB-2000, FB-2000+, FB-3000 WT sealant, FireDam 150+, IC 15WB+, CP 25WB+ caulk

*Bearing the UL Classification Mark

Reprinted from the Online Certifications Directory with permission from Underwriters Laboratories Inc.
Copyright © 2010 Underwriters Laboratories Inc.®



UL System No. BW-S-0008

March 20, 2017

ANSI/UL2079

Assembly Ratings – 1 and 2 Hr (See Item 2)
 Joint Width – 2 in. Max
 L Rating at Ambient – Less than 1 CFM/Lin Ft
 L Rating at 400°F – Less than 1 CFM/Lin Ft

CAN/ULC S115

F Ratings – 1 and 2 Hr (See Item 2)
 FT Ratings – 1 and 2 Hr (See Item 2)
 FH Ratings – 1 and 2 Hr (See Item 2)
 FTH Ratings – 1 and 2 Hr (See Item 2)
 Joint Width – 51 mm Max
 L Rating at Ambient – Less than 1.55 L/s/lin m
 L Rating at 204°C – Less than 1.55 L/s/lin m

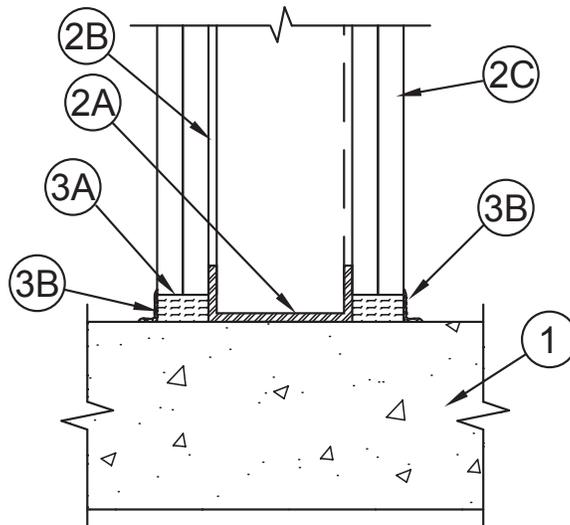

1. **Floor Assembly** – Min 4-1/2 in. (114 mm) thick reinforced lightweight or normal weight (100-150 pcf or 1600-2400 kg/m³) structural concrete. Floor may also be constructed of any 6 in. (152 mm) thick UL Classified hollow-core **Precast Concrete Units***.
 See **Precast Concrete Units** category in the Fire Resistance Directory for names of manufacturers.
2. **Wall Assembly** – The 1 or 2 hr fire-rated gypsum board/steel stud wall assembly shall be constructed of the materials and in the manner specified in the individual U400 or V400 Series Wall and Partition Design in the UL Fire Resistance Directory. In addition, the wall may incorporate a head-of-wall joint system constructed as specified in the HW Series Joint Systems in the UL Fire Resistance Directory. The wall shall include the following construction features:
 - A. **Steel Floor Runner** – Floor runners of wall assembly shall consist of min No. 25 gauge galv steel channels sized to accommodate steel studs (Item 2C). Floor runners to be provided with flanges a min of 1/4 in. (6 mm) greater than the joint width. Runners secured with steel fasteners spaced 12 in. (305 mm) OC.
 - B. **Studs** – Steel studs to be min 3-1/2 in. (89 mm) wide. Studs cut 1/2 to 3/4 in. (13 to 19 mm) less in length than assembly height with bottom nesting in, resting on and fastened to floor runner with sheet metal screws. Stud spacing not to exceed 24 in. (610 mm) OC.
 - C. **Gypsum Board*** – Gypsum board installed to a min total thickness of 5/8 or 1-1/4 in. (16 or 32 mm) on each side of wall for a 1 or 2 hr rated wall, respectively. Wall to be constructed as specified in the individual U400 or V400 Series Design in the UL Fire Resistance Directory, except that a max 2 in. (51 mm) gap shall be maintained between the bottom of gypsum board and top of concrete floor.
The hourly fire rating of the joint system is equal to the hourly fire rating of the wall.
3. **Joint System – Max separation between top of floor and bottom of gypsum board is 2 in. (51 mm).** The joint system consists of forming material and a fill material, as follows:
 - A. **Packing Material** – Min 5/8 and 1-1/4 in. (16 and 32 mm) thickness of min 4 pcf (64 kg/m³) mineral wool batt insulation for 1 and 2 hr rated assemblies, respectively. Packing material to be firmly packed into gap between the bottom of the gypsum board and the top of the concrete floor on each side of the wall, flush with each surface of the wall.
 - B. **Fill, Void or Cavity Material*** – Min 1/16 in. (1.6 mm) dry thickness (1/8 in. or 3.2 mm wet thickness) of fill material sprayed or brushed on each side of the wall to completely cover mineral wool between the bottom of the gypsum board and the top of the concrete floor. When 3M Fire Barrier Watertight Spray is used, min wet (and dry) thickness of spray is 1/10 in. (2.5 mm) and spray shall lap min 1/2 in. (13 mm) onto the floor and wall.
3M COMPANY – FireDam™ Spray 200, 3M Fire Barrier Watertight Spray
 - B1. **Fill, Void or Cavity Material* – Tape** (not shown) – As an alternate to Item 3B, Tape cut to size and press applied along length of joint to completely cover mineral wool between the bottom of the gypsum board and the top of the concrete floor, lapping minimum 1 in. (25 mm) onto wall and floor. Tape shall be applied in minimum 1 ft (305 mm) lengths along the joint at each side of wall and adjoining lengths of Tape shall overlap min 1/2 in. (13 mm).
3M COMPANY – 3M Fire and Water Barrier Tape

*Indicates such products shall bear the UL or cUL Certification Mark for jurisdictions employing the UL or cUL Certification (such as Canada), respectively. 

Reprinted from the Online Certifications Directory with permission from UL©

Construction Joints

Bottom of Wall Static

BWS

System No. BW-S-0037

September 24, 2015

ANSI/UL2079

Assembly Ratings — 1 and 2 Hr (See Item 2)
Joint Width - 1/2 In. Max
L Rating at Ambient — Less than 1 CFM/Lin Ft
L Rating at 400 F — Less than 1 CFM/Lin Ft

CAN/ULC S115

F Ratings — 1 and 2 Hr (See Item 2)
FT Ratings — 1 and 2 Hr (See Item 2)
FH Ratings — 1 and 2 Hr (See Item 2)
FTH Ratings — 1 and 2 Hr (See Item 2)
Joint Width — 1/2 In. Max
L Rating at Ambient — Less than 1 CFM/Lin Ft
L Rating at 400 F — Less than 1 CFM/Lin Ft

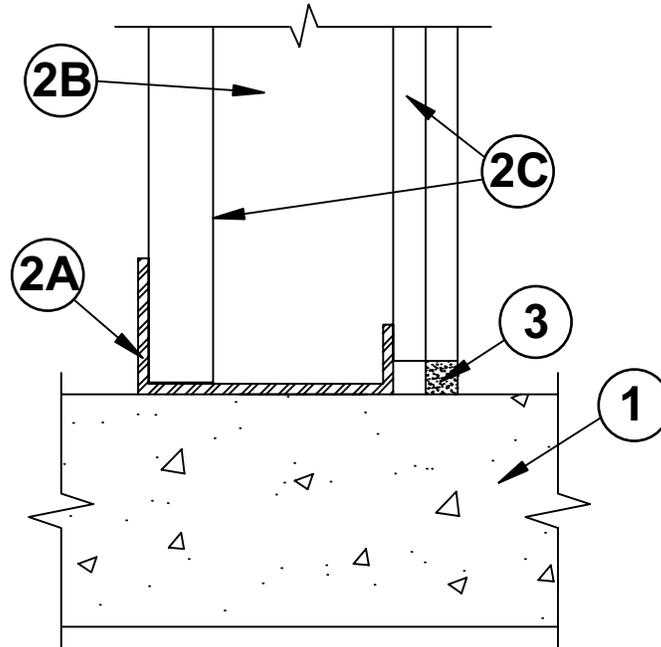

- 1. Floor Assembly** — Min 4-1/2 in. (114 mm) thick reinforced lightweight or normal weight (100-150 pcf or 1600-2400 kg/m³) structural concrete. Floor may also be constructed of any min 6 in. (152 mm) thick UL Classified hollow-core **Precast Concrete Units***. See **Precast Concrete Units** (CFTV) category in the Fire Resistance Directory for names of manufactures.
- 2. Wall Assembly** — The 1 or 2 hr fire rated gypsum board/steel stud shaft wall assembly shall be constructed of the materials and in the manner specified in the individual U400, V400 or W400 Series Wall and Partition Design in the UL Fire Resistance Directory. In addition, the wall may incorporate a head-of-wall joint system constructed as specified in the HW Series Joint Systems in the UL Fire Resistance Directory. The wall shall include the following construction features:
 - A. Steel Floor Runner** — "J"-shaped runners, min 2-1/2 in. (64 mm) deep, with unequal legs of 1 in. (25 mm) and 2 in. (51 mm), fabricated from min 24 MSG galv steel. Runners positioned with short leg toward finished side of wall. Runners attached to structural supports with steel fasteners located not greater than 2 in. (51 mm) from ends and not greater than 24 in. (610 mm) OC.
 - B. Studs** — "C-H", "E" (back-to-back) or "C-T"-shaped studs, min 2-1/2 in. (64 mm) deep, fabricated from min 25 MSG galv steel. Cut to lengths 3/8 to 1/2 in. (10 to 13 mm) less than floor-to-ceiling height and spaced 24 in. (610 mm) OC.
 - C. Gypsum Board*** — 1 in. (25 mm) thick gypsum liner panels and 1/2 in., 5/8 in. or 3/4 in. (13, 16 or 19 mm) thick gypsum panels installed as specified in the individual U400 or V400 Series shaft wall designs in the UL Fire Resistance Directory.

The hourly ratings of the joint system are equal to the hourly fire rating of the wall.

- 3. Fill, Void or Cavity Material* - Sealant** — Max separation between top of floor and bottom of gypsum board is 1/2 in. (13 mm). Min 1/2 in. (13 mm) thickness of fill material installed on finish side of the wall between the bottom of the gypsum board and the top of the concrete floor.

3M COMPANY 3M FIRE PROTECTION PRODUCTS — FB1000 NS Sealant, FB-2000 Caulk, FB-2000+ Caulk, FB-3000 WT Sealant, FireDam 150+ Caulk, IC-15WB+ Caulk+ or CP 25WB+ Caulk

* Indicates such products shall bear the UL or cUL Certification Mark for jurisdictions employing the UL or cUL Certification (such as Canada), respectively.

Construction Joints

Bottom of Wall Static

BWS

3M Firestop Systems

Construction Joints

Floor to Floor

FFD

Floor to Floor Dynamic

FFS

Floor to Floor Static

Quick Reference Guide

Floor-to-Floor

| 3M UL Systems | "F" Rating | 3M Product | Through Penetrant Details |
|---------------|------------|---|---|
| FF-D-0002 | 1, 2 | 3M™ FireDam™ Spray 200 3M™ Fire and Water Barrier Tape | Min 4-1/2 in. concrete. Max 2 in. wide joint. 19% compression/extension. 2 hour F rating. Also known as FFD0002. |
| FF-D-0011 | 2, 3, 4 | 3M™ Fire Barrier Silicone Sealant 2000+ | Min 5-1/2 in. concrete floor. Max 2 in. joint. 10.9% compression/extension. Mineral wool installed at 50% compression. 2 hour F Rating.. Also known as FFD0011. |
| FF-D-0014 | 2, 3, 4 | 3M™ FireDam™ Spray 200 3M™ Fire and Water Barrier Tape | Min 6 in. concrete. Max 2 in. joint. 18.75% compression/extension. 4 hour F rating. Also known as FFD0014. |
| FF-D-0017 | 2 | 3M™ Fire Barrier Water Tight Sealant 1003 SL | Min 4 in. precast autoclaved aerated concrete. Max 1/2 in. joint. 31% compression/extension. 1 hour F rating. Also known as FFD0017. |
| FF-D-1002 | 2, 3 | 3M™ Fire Barrier Water Tight Sealant 1000 NS 3M™ Fire Barrier Water Tight Sealant 1003 SL 3M™ Fire Barrier Water Tight Sealant 1003 SL | Min 4-1/2 in. concrete. Max 4 in. joint. 31% compression/extension. 3 hour F rating. Also known as FFD1002. |
| FF-D-1003 | 2 | 3M™ Fire Barrier Water Tight Sealant 1000 NS 3M™ Fire Barrier Water Tight Sealant 1003 SL 3M™ Fire Barrier Water Tight Sealant 1003 SL | Min 4-1/2 in. concrete. Max 4 in. wide joint. 25% compression/extension. 2 hour F rating. Also known as FFD1003. |
| FF-D-1004 | 2, 3 | 3M™ Fire Barrier Silicone Sealant 2000+ | 4" wide, 25% compree/extension, concrete/concrete. Also referred as FFD1004. |
| FF-D-1020 | 2 | 3M™ Fire Barrier Water Tight Sealant 1003 SL | Min 4-1/2 in. concrete. Max 4 in. joint. 15.6% compress/extension. 2 hour F rating. Also known as FFD1020. |
| FF-D-1021 | 2 | 3M™ Fire Barrier Water Tight Sealant 1003 SL | Min 4-1/2 in. concrete. Max 4 in. joint. 15.6% compress/extension. 2 hour F rating. Also known as FFD1021. |
| FF-D-1042 | 2, 3 | 3M™ FireDam™ Spray 200 3M™ Fire and Water Barrier Tape 3M™ Watertight Spray | Min 6 in. concrete. 4 in. wide joint, 19% compression/extension. 3 hour F rating. Also known as FFD1042. |
| FF-S-0001 | 2 | 3M™ Fire Barrier Silicone Sealant 2000+ 3M™ Fire Barrier Water Tight Sealant 1000 NS 3M™ Fire Barrier Water Tight Sealant 1003 SL 3M™ Fire Barrier Water Tight Sealant 1003 SL | Min 5 in. concrete. Nominal 1 in. joint. 2 hour F rating. Also known as FFS0001. |
| FF-S-0003 | 2 | 3M™ Fire Barrier Sealant CP 25WB+ 3M™ Fire Barrier Water Tight Sealant 3000 WT | 2" wide, concrete/concrete. Also referred as FFS0003. |
| FF-S-0004 | 1.5, 2, 3 | 3M™ Fire Barrier Sealant CP 25WB+ 3M™ Fire Barrier Water Tight Sealant 3000 WT | 1" and 2" wide, concrete/concrete. Also referred as FFS0004. |
| FF-S-1003 | 2, 3 | 3M™ Fire Barrier Silicone Sealant 2000+ | 6" wide, concrete/concrete. Also referred as FFS1003. |
| FF-S-1004 | 2 | 3M™ Fire Barrier Sealant CP 25WB+ 3M™ Fire Barrier Water Tight Sealant 3000 WT | 4" and 6" wide, concrete/concrete. Also referred as FFS1004. |
| FF-S-1027 | 1, 2 | 3M™ Fire Barrier Water Tight Sealant 1000 NS 3M™ Fire Barrier Water Tight Sealant 1003 SL | 6" wide, concrete/concrete. Also referred as FFS1027. |

UL System No. FF-D-0002

January 13, 2017

ANSI/UL2079

Assembly Rating – 2 Hr
 Nominal Joint Width – 2 in
 Class II Movement Capabilities – 19% or 10% Compression
 or Extension (See Item 2)
 L Rating at Ambient – Less than 1 CFM/Lin Ft
 L Rating at 400°F – Less than 1 CFM/Lin Ft

CAN/ULC S115

F Rating – 2 Hr
 FT Rating – 2 Hr
 FH Rating – 2 Hr
 FTH Rating – 2 Hr
 Nominal Joint Width – 51 mm
 Class II Movement Capabilities – 19% or 10% Compression
 or Extension (See Item 2)
 L Rating at Ambient – Less than 1.55 L/s/lin m
 L Rating at 204°C – Less than 1.55 L/s/lin m

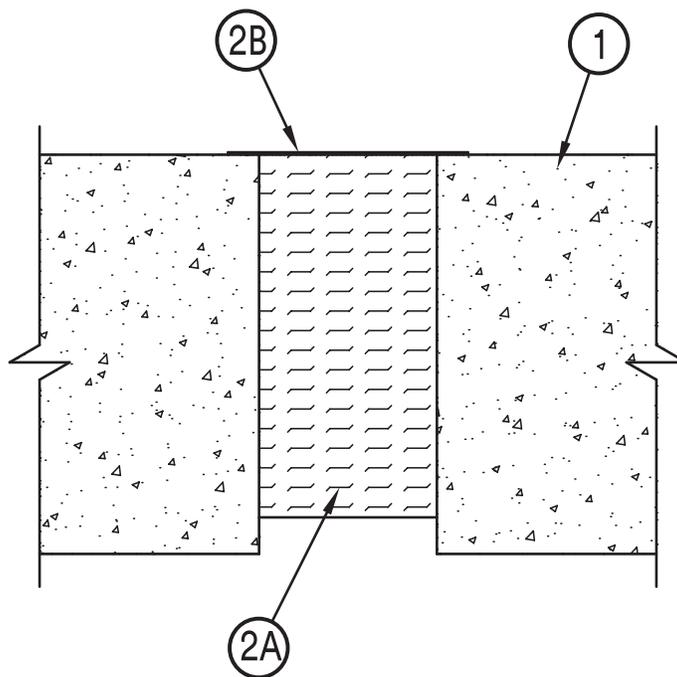

1. **Floor Assembly** – Min 4-1/2 in. (114 mm) thick steel-reinforced lightweight or normal weight (100-150 pcf or 1600-2400 kg/m³) structural concrete.
2. **Joint System** – Max width of joint (at time of installation of joint system) is 2 in. The joint system is designed to accommodate a max 19 percent compression or extension from its installed width except that when the Fire Barrier Watertight Spray (see Item 2B) is used, the movement is limited to max 10 percent compression and extension. The joint system shall consist of the following:
 - A. **Forming Material*** – Min 4 pcf (64 kg/m³) mineral wool batt insulation installed in joint opening as a permanent form. Batt cut to min width of 4 in. (102 mm) and installed edge-first into joint opening, parallel with joint direction. When 3M Fire Barrier Watertight Spray is used, batts to be cut to min width of 4-1/2 in. (114 mm). The batt sections are compressed min 50 percent in thickness and the compressed batt sections are installed flush with the top surface of floor. Adjoining lengths of batt to be tightly-butted with butted seams spaced min 48 in. (1.2 m) apart along the length of the joint.

INDUSTRIAL INSULATION GROUP LLC – MinWool-1200 Safing
ROCK WOOL MANUFACTURING CO – Delta Board
ROCKWOOL MALAYSIA SDN BHD – Type Safe
ROXUL INC – Type Safe
THERMAFIBER INC – Type SAF
 - B. **Fill, Void or Cavity Material*** – Min 1/16 in. (1.6 mm) dry thickness (min 1/8 in. or 3.2 mm wet thickness) of fill material sprayed or brushed on top surface of floor to completely cover mineral wool and overlap a min of 1/2 in. (13 mm) onto concrete floor. When 3M Fire Barrier Watertight Spray is used, min wet (and dry) thickness of spray is 1/10 in. (2.5 mm).

3M COMPANY – FireDam™ Spray 200, 3M Fire Barrier Watertight Spray
 - B1. **Fill, Void or Cavity Material* – Tape** – As an alternate to Item 2B, Tape cut to size and press applied to top surface of floor to completely cover mineral wool and overlap a min of 1 in. (25 mm) onto the concrete floor at both edges of joint. Tape shall be applied in minimum 1 ft (305 mm) lengths along the joint at top of floor and adjoining lengths of Tape shall overlap min 1/2 in. (13 mm).

3M COMPANY – 3M Fire and Water Barrier Tape

*Indicates such products shall bear the UL or cUL Certification Mark for jurisdictions employing the UL or cUL Certification (such as Canada), respectively. 

Reprinted from the Online Certifications Directory with permission from UL©

Construction Joints

Floor to Floor

FFD

System No. FF-D-0011

April 22, 2011

Assembly Rating – 4 Hr

Nominal Joint Width – 2”

Class II Movement Capabilities – 10.9% Compression or Extension

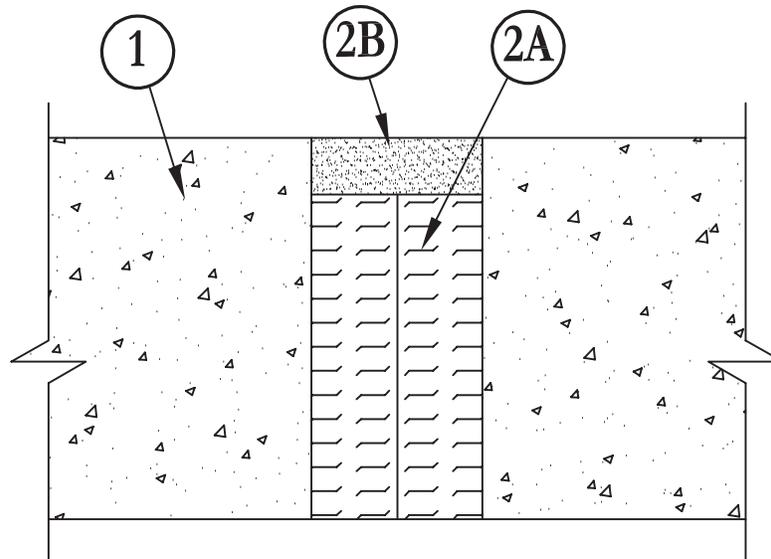

1. **Floor Assembly** – Min 5-1/2 in. thick steel-reinforced lightweight or normal weight (100-150 pcf) structural concrete.
2. **Joint System** – Max width of joint (at time of installation of joint system) is 2 in. The joint system is designed to accommodate a max 10.9 percent compression or extension from its installed width. The joint system shall consist of the following:
 - A. **Forming Material*** – Min 4.0 pcf mineral wool batt insulation installed in joint opening as a permanent form. Batt cut to min width of 5 in. and installed edge-first into joint opening, parallel with joint direction, such that batt sections are compressed min 50 percent in thickness and such that the compressed batt sections are recessed from the top surface of floor to accommodate the required thickness of fill material. Adjoining lengths of batt to be tightly-butted with butted seams spaced min 48 in. apart along the length of the joint.

ROCK WOOL MANUFACTURING CO – Delta Safing Board
ROCKWOOL MALAYSIA SDN BHD – Type Safe
ROXUL INC – Type Safe
THERMAFIBER INC – Type SAF
 - B. **Fill, Void or Cavity Material*** – Min 1/2 in. thickness of fill material applied within the joint, flush with top surface of floor.
3M COMPANY – FB 2000+

*Bearing the UL Classification Mark

Reprinted from the Online Certifications Directory with permission from Underwriters Laboratories Inc.
 Copyright © 2011 Underwriters Laboratories Inc.®



UL System No. FF-D-0014

December 05, 2016

ANSI/UL2079

Assembly Rating – 4 Hr
Nominal Joint Width – 2 in.

Class II Movement Capabilities – 19% Compression or Extension

CAN/ULC S115

F Rating – 4 Hr
FT Rating – 4 Hr
FH Rating – 4 Hr
FTH Rating – 4 Hr

Nominal Joint Width – 51 mm

Class II Movement Capabilities – 19% Compression or Extension

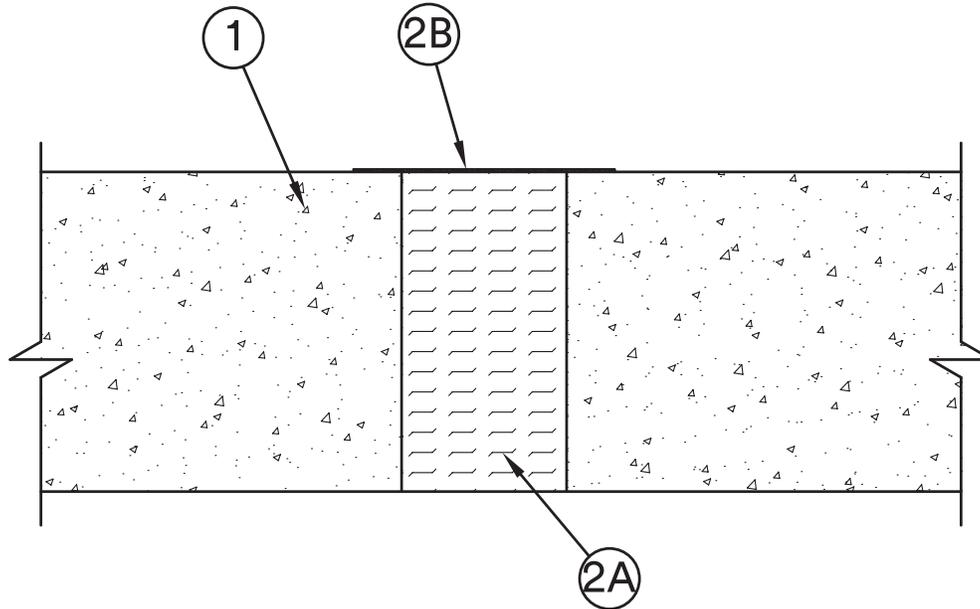

1. **Floor Assembly** – Min 6 in. (152 mm) thick steel-reinforced lightweight or normal weight (100-150 pcf or 1600-2400 kg/m³) structural concrete.
2. **Joint System** – Max width of joint (at time of installation of joint system) is 2 in. (51 mm). The joint system is designed to accommodate a max 19 percent compression or extension from its installed width. The joint system shall consist of the following:
 - A. **Forming Material*** – Min 4 pcf (64 kg/m³) mineral wool batt insulation installed in joint opening as a permanent form. Batt cut to min width of 6 in. (152 mm) and installed edge-first into joint opening, parallel with joint direction, such that batt sections are compressed min 50 percent in thickness and such that the compressed batt sections are flush with top surface of floor. Adjoining lengths of batt to be tightly butted with butted seams spaced min 48 in. (1.2 m) apart along the length of the joint.

INDUSTRIAL INSULATION GROUP LLC – MinWool-1200 Safing
JOHNS MANVILLE – Safing
THERMAFIBER INC – Type SAF
ROCK WOOL MANUFACTURING CO – Delta Safing Board
ROCKWOOL MALAYSIA SDN BHD – Type Safe
ROXUL INC – Type Safe
 - B. **Fill, Void or Cavity Material* – Tape** – As an alternate to Item 2B, Tape cut to size and press applied to top surface of floor to completely cover mineral wool and overlap a min of 1/2 in. (13 mm) onto concrete floor.

3M COMPANY – FireDam™ Spray 200
 - B1. **Fill, Void or Cavity Material* – Tape** – As an alternate to Item 2B, Tape cut to size and press applied to top surface of floor to completely cover mineral wool and overlap a min of 1 in. (25 mm) onto the concrete floor at both sides of joint. Tape shall be applied in minimum 1 ft (305 mm) lengths along the joint at top of floor and adjoining lengths of Tape shall overlap min 1/2 in. (13 mm).

3M COMPANY – 3M Fire and Water Barrier Tape

*Indicates such products shall bear the UL or cUL Certification Mark for jurisdictions employing the UL or cUL Certification (such as Canada), respectively. 

Reprinted from the Online Certifications Directory with permission from UL©

Construction Joints

Floor to Floor

FFD



UL System No. FF-D-0017
XHBN - Joint Systems
XHBN7 - Joint Systems Certified for Canada

August 17, 2012

F Rating — 2 Hr

FT Rating — 2 Hr

FH Rating — 2 Hr

FTH Rating — 2 Hr

Nominal Joint Width — 1/2 in.

Class II Movement Capabilities — 31% Compression or Extension

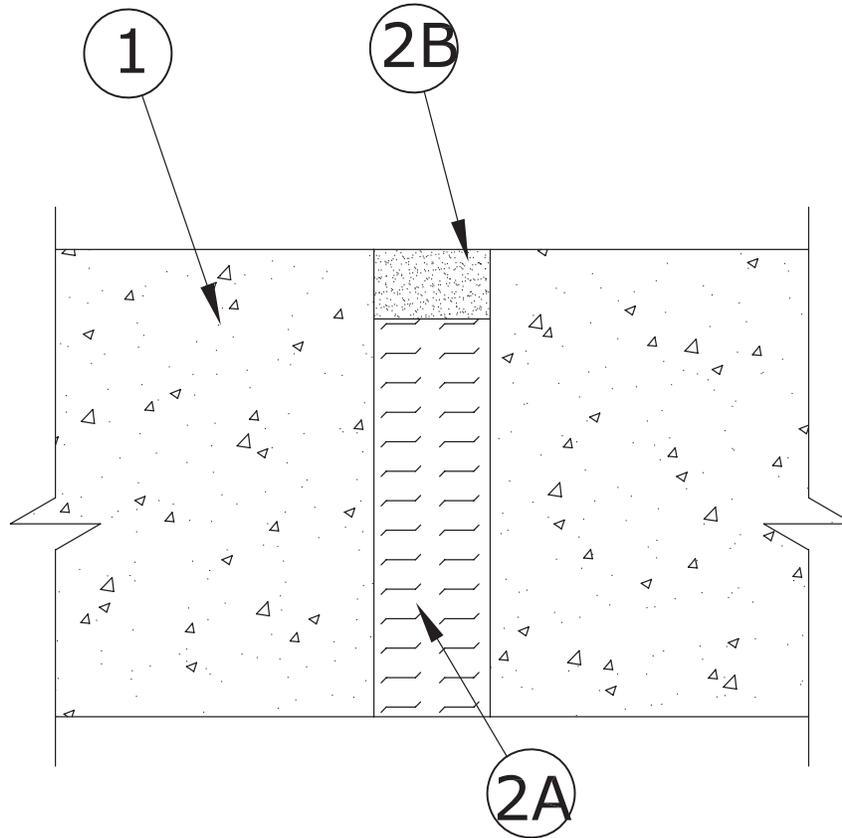

- 1. Floor Assembly — Precast Autoclaved Aerated Concrete*** – Min 4 in. thick as specified in Design No. K909, K910, P932 or P933 in the UL Fire Resistance Directory.

AERCON FLORIDA L L C – Types AC-3.3, AC-4, AC-4.4, AC-6, AC-6.6

- 2. Joint System — Max width of joint (at time of installation of joint system) is 1/2 in. The joint system is designed to accommodate a max 31 percent compression or extension from its installed width.** – The joint system shall consist of the following:

A. Forming Material* – Min 4.0 pcf mineral wool batt insulation installed in joint opening as a permanent form. Min 3-1/2 in. thickness of batt cut to the appropriate width and installed into joint opening such that batt sections are compressed min 50 percent in width and such that the compressed batt sections are recessed from the top surface of floor to accommodate the required thickness of fill material. Adjoining lengths of batt to be tightly-butted with butted seams spaced min 24 in. apart along the length of the joint.

ROCK WOOL MANUFACTURING CO – Delta Safing Board

THERMAFIBER INC – Type SAF

B. Fill, Void or Cavity Material* – Min 1/2 in. thickness of fill material applied within the joint, flush with top surface of floor.

3M COMPANY 3M/DYNEON – FB-1003 SL



*Indicates such products shall bear the UL or cUL Certification Mark for jurisdictions employing the UL or cUL Certification (such as Canada), respectively. Reprinted from the Online Certifications Directory with permission from UL©

System No. FF-D-1002

May 09, 2013

ANSI/UL2079

Assembly Rating – 3 Hr

Nominal Joint Width – 4 In.

Class II Movement Capabilities – 31% Compression or Extension

CAN/ULC S115

F Rating – 3 Hr

FT Rating – 3 Hr

FH Rating – 3 Hr

FTH Rating – 3 Hr

Nominal Joint Width – 4 In.

Class II Movement Capabilities – 31% Compression or Extension

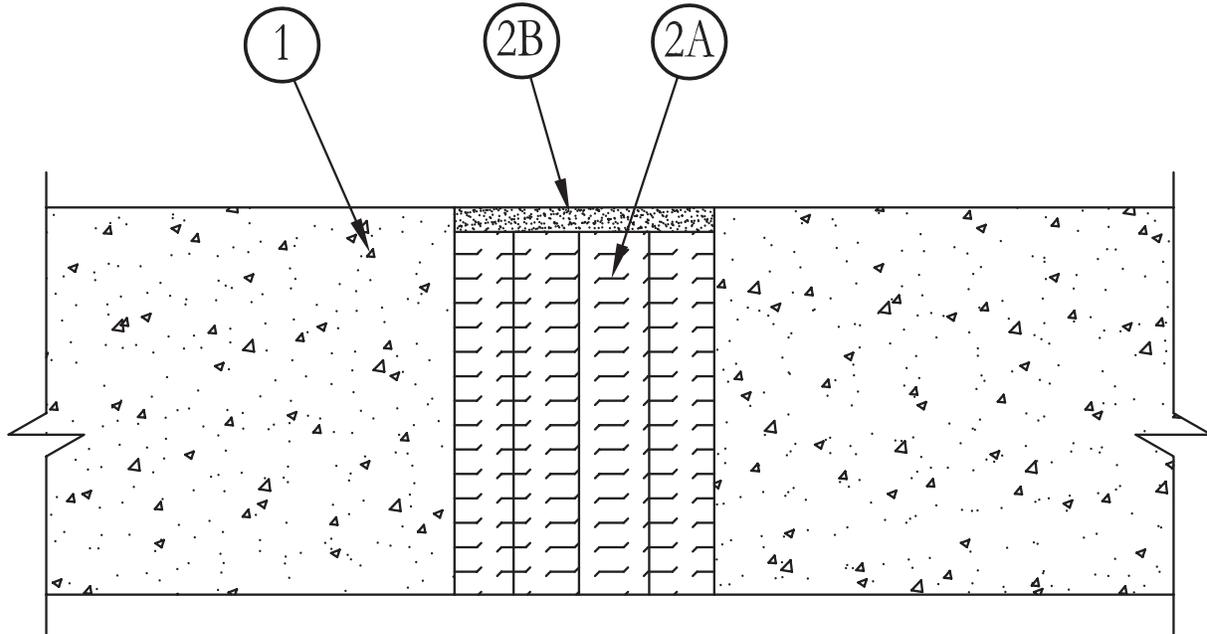

1. **Floor Assembly** – Min 4-1/2 in. (114 mm) thick steel-reinforced lightweight or normal weight (100-150 pcf or 1600-2400 kg/m³) structural concrete.
2. **Joint System** – Max width of joint (at time of installation of joint system) is 4 in. The joint system is designed to accommodate a max 31 percent compression or extension from its installed width. The joint system shall consist of the following:
 - A. **Forming Material*** – Min 4.0 pcf (64 kg/m³) mineral wool batt insulation installed in joint opening as a permanent form. Pieces of batt cut to min width of 4 in. (102 mm) and installed edge-first into joint opening, parallel with joint direction, such that batt sections are compressed min 50 percent in thickness and such that the compressed batt sections are recessed from top surface of floor to accommodate the required thickness of fill material. Adjoining lengths of batt to be tightly-butted with butted seams spaced min 12 in. (305 mm) apart along the length of the joint.

IIG MINWOOL LLC – MinWool-1200 Safing
ROCK WOOL MANUFACTURING CO – Delta Board
ROCKWOOL MALAYSIA SDN BHD – Type Safe
ROXUL INC – Type Safe
THERMAFIBER INC – Type SAF
 - B. **Fill, Void or Cavity Material*** – Min 1/2 in. (13 mm) thickness of fill material applied within the joint, flush with top surface of floor.
3M COMPANY – FB-1000 NS, FB-1003SL or FB-2000

*Bearing the UL Classification Mark

Reprinted from the Online Certifications Directory with permission from UL

© 2013 UL LLC



System No. FF-D-1003

May 09, 2013

ANSI/UL2079

Assembly Rating – 2 Hr

Nominal Joint Width – 4 In.

Class II Movement Capabilities – 25% Compression or Extension

CAN/ULC S115

F Rating – 2 Hr

FT Rating – 2 Hr

FH Rating – 2 Hr

FTH Rating – 2 Hr

Nominal Joint Width – 4 In.

Class II Movement Capabilities – 25% Compression or Extension

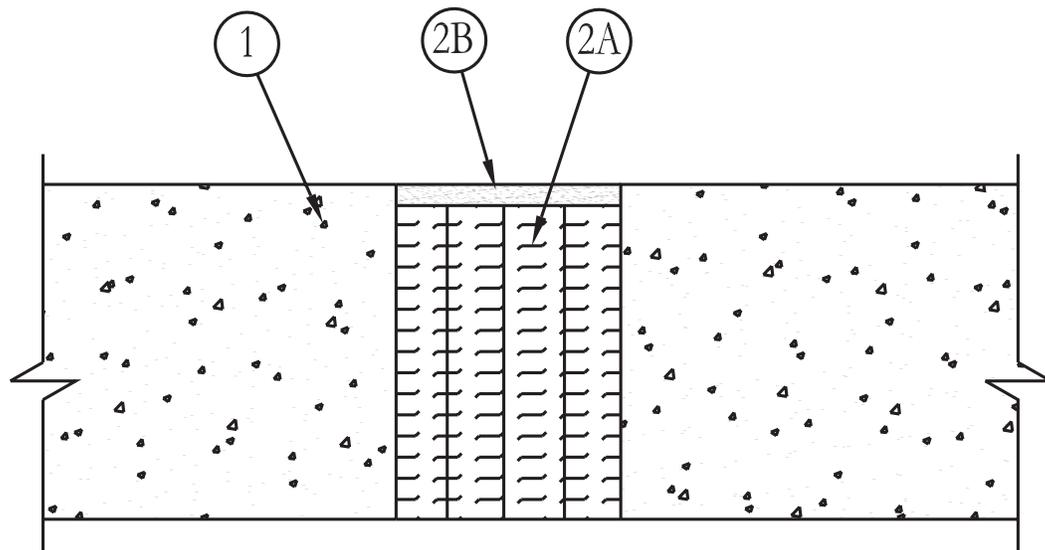

- 1. Floor Assembly** – Min 4-1/2 in. (114 mm) thick steel-reinforced lightweight or normal weight (100-150 pcf or 1600-2400 kg/m³) structural concrete.
- 2. Joint System** – Max width of joint (at time of installation of joint system) is 4 in. The joint system is designed to accommodate a max 25 percent compression or extension from its installed width. The joint system shall consist of the following:
 - A. Forming Material*** – Min 4.0 pcf (64 kg/m³) mineral wool batt insulation installed in joint opening as a permanent form. Pieces of batt cut to min width of 4 in. (102 mm) and installed edge-first into joint opening, parallel with joint direction, such that batt sections are compressed min 50 percent in thickness and such that the compressed batt sections are recessed from top surface of floor to accommodate the required thickness of fill material. Adjoining lengths of batt to be tightly-butted with butted seams spaced min 12 in. (305 mm) apart along the length of the joint.

IIG MINWOOL LLC – MinWool-1200 Safing
ROCK WOOL MANUFACTURING CO – Delta Board
ROCKWOOL MALAYSIA SDN BHD – Type Safe
ROXUL INC – Type Safe
THERMAFIBER INC – Type SAF
 - B. Fill, Void or Cavity Material*** – Min 1/4 in. (6 mm) thickness of fill material applied within the joint, flush with top surface of floor.

3M COMPANY – FB-1000 NS, FB-1003SL or FB-2000

*Bearing the UL Classification Mark

Reprinted from the Online Certifications Directory with permission from UL
© 2013 UL LLC



System No. FF-D-1004

December 04, 2000

Assembly Rating – 3 Hr

Nominal Joint Width – 4 In.

Class II Movement Capabilities – 12.5% Compression or Extension

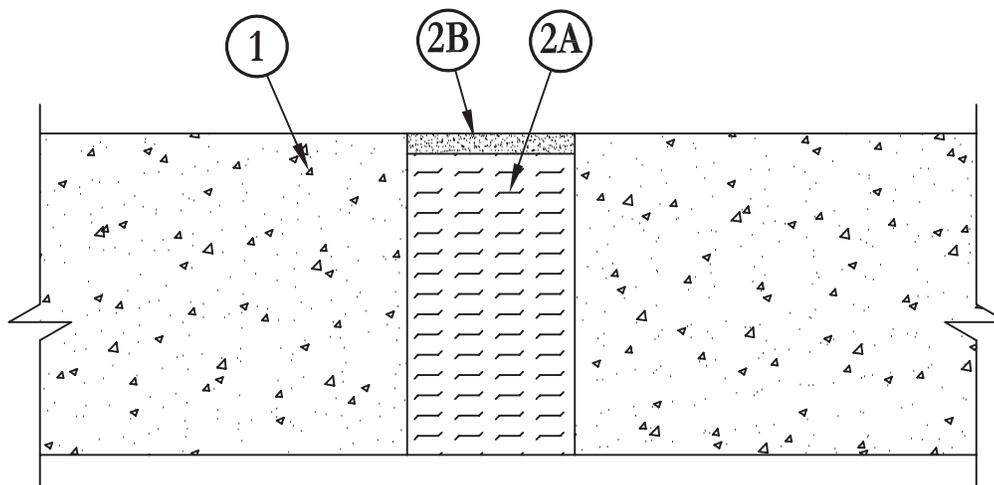

1. **Floor Assembly** – Min 4-1/2 in. thick steel-reinforced lightweight or normal weight (100-150 pcf) structural concrete.
2. **Joint System** – Max width of joint (at time of installation of joint system) is 4 in. The joint system is designed to accommodate a max 12.5 percent compression or extension from its installed width. The joint system shall consist of the following:
 - A. **Forming Material*** – Min 4.0 pcf mineral wool batt insulation installed in joint opening as a permanent form. Pieces of batt cut to min width of 4 in. and installed edge-first into joint opening, parallel with joint direction, such that batt sections are compressed min 50 percent in thickness and such that the compressed batt sections are recessed from top surface of floor as required to accommodate the required thickness of fill material. Adjoining lengths of batt to be tightly-butted with butted seams spaced min 12 in. apart along the length of the joint.

IIG MINWOOL L L C – MinWool-1200 Safing
ROCK WOOL MANUFACTURING CO – Delta Board
ROCKWOOL MALAYSIA SDN BHD – Type Safe
ROXUL INC – Type Safe
THERMAFIBER INC – Type SAF
 - B. **Fill, Void or Cavity Material*** – Min 1/4 in. thickness of fill material applied within the joint, flush with top surface of floor.
3M COMPANY – FB-2000+

*Bearing the UL Classification Mark

Reprinted from the Online Certifications Directory with permission from UL

© 2012 UL LLC



System No. FF-D-1020

January 11, 2013

Assembly Rating – 2 Hr

L Rating At Ambient – Less Than 1 CFM/Lin Ft

L Rating At 400 F – Less than 1 CFM/Lin Ft

Nominal Joint Width – 4”

Class II Movement Capabilities –15.6% Compression or Extension

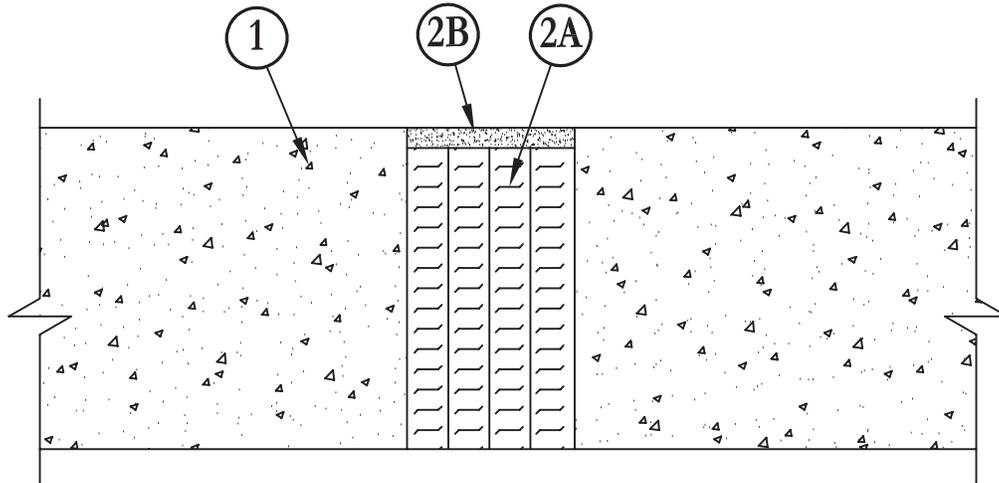

1. **Floor Assembly** – Min 4-1/2 in. thick steel-reinforced lightweight or normal weight (100-150 pcf) structural concrete.
2. **Joint System** – Max width of joint (at time of installation of joint system) is 4 in. The joint system is designed to accommodate a max 15.6 percent compression or extension from its installed width. The joint system shall consist of the following:
 - A. **Forming Material*** – Min 4.0 pcf mineral wool batt insulation installed in joint opening as a permanent form. Batt cut to min width of 4 in. and installed edge-first into joint opening, parallel with joint direction, such that batt sections are compressed min 50 percent in thickness and such that the compressed batt sections are recessed from the top surface of floor to accommodate the required thickness of fill material. Adjoining lengths of batt to be tightly-butted with butted seams spaced min 48 in. apart along the length of the joint. –
ROCK WOOL MANUFACTURING CO – Delta Safing Board
ROCKWOOL MALAYSIA SDN BHD – Type Safe
ROXUL INC – Type Safe
THERMAFIBER INC – Type SAF
 - B. **Fill, Void or Cavity Material*** – Min 1/4 in. depth of fill material applied within the joint, flush with top surface of floor.
3M COMPANY – FB 1003 SL

*Bearing the UL Classification Mark

Reprinted from the Online Certifications Directory with permission from UL
© 2013 UL LLC



System No. FF-D-1021

January 11, 2013

Assembly Rating – 2 Hr

L Rating At Ambient – Less Than 1 CFM/Lin Ft

L Rating At 400 F – Less Than 1 CFM/Lin Ft

Nominal Joint Width – 4 In.

Class II Movement Capabilities – 15.6% Compression or Extension

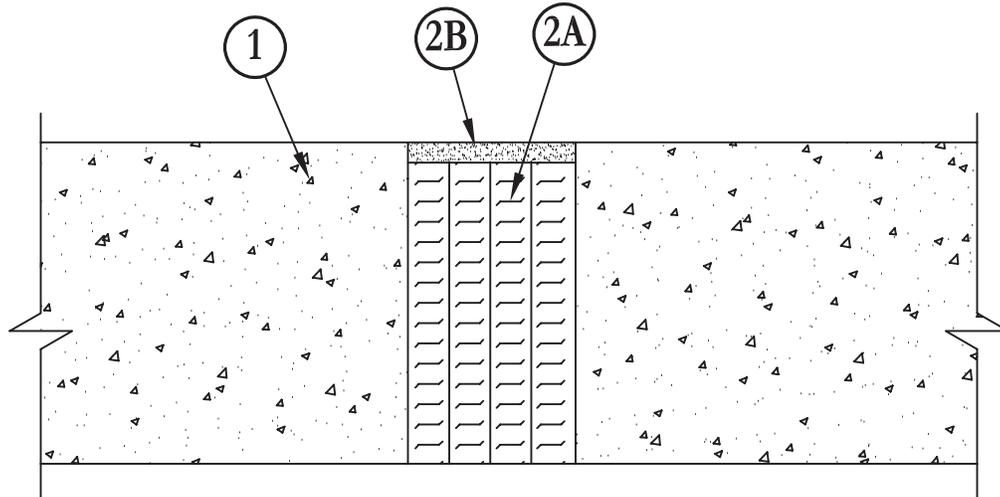

1. **Floor Assembly** – Min 4-1/2 in. thick steel-reinforced lightweight or normal weight (100-150 pcf) structural concrete.
2. **Joint System** – Max width of joint (at time of installation of joint system) is 4 in. The joint system is designed to accommodate a max 15.6 percent compression or extension from its installed width. The joint system shall consist of the following:
 - A. **Forming Material*** – Min 4.0 pcf mineral wool batt insulation installed in joint opening as a permanent form. Batt cut to min width of 4 in. and installed edge-first into joint opening, parallel with joint direction, such that batt sections are compressed min 50 percent in thickness and such that the compressed batt sections are recessed from the top surface of floor to accommodate the required thickness of fill material. Adjoining lengths of batt to be tightly-butted with butted seams spaced min 48 in. apart along the length of the joint. –
ROCK WOOL MANUFACTURING CO – Delta Safing Board
ROCKWOOL MALAYSIA SDN BHD – Type Safe
ROXUL INC – Type Safe
THERMAFIBER INC – Type SAF
 - B. **Fill, Void or Cavity Material*** – Min 1/2 in. depth of fill material applied within the joint, flush with top surface of floor.
3M COMPANY – FB 1003 SL

*Bearing the UL Classification Mark

Reprinted from the Online Certifications Directory with permission from UL

© 2013 UL LLC



UL System No. FF-D-1042

January 13, 2017

ANSI/UL2079

Assembly Rating – 3 Hr
Nominal Joint Width – 4 in.
Class II Movement Capabilities – 19% or 10% Compression
or Extension (See Item 2)
L Rating at Ambient – Less than 1 CFM/Lin Ft
L Rating at 400°F – Less than 1 CFM/Lin Ft

CAN/ULC S115

F Rating – 3 Hr
FT Rating – 3 Hr
FH Rating – 3 Hr
FTH Rating – 3 Hr
Nominal Joint Width – 102 mm
Class II Movement Capabilities – 19% or 10% Compression
or Extension (See Item 2)
L Rating at Ambient – Less than 1.55 L/s/lin m
L Rating at 204°C – Less than 1.55 L/s/lin m

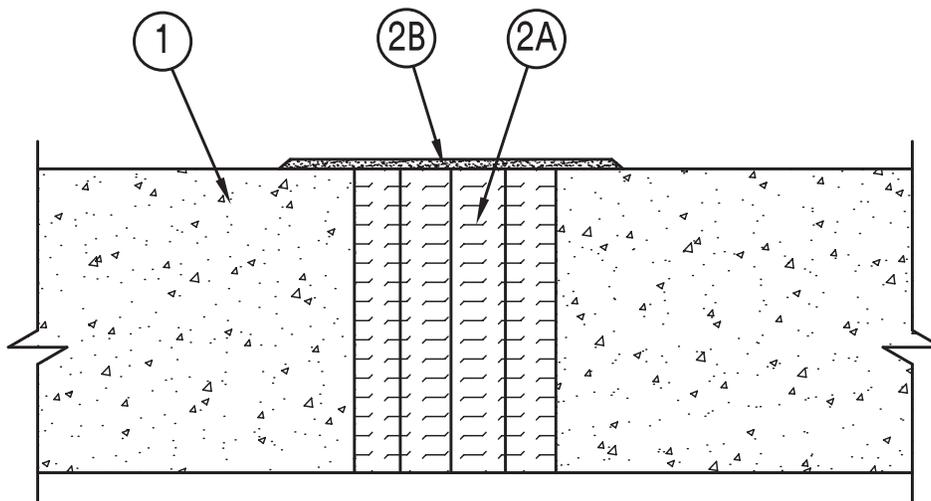

1. **Floor Assembly** – Min 6 in. (152 mm) thick steel-reinforced lightweight or normal weight (100-150 pcf or 1600-2400 kg/m³) structural concrete.
2. **Joint System** – Max width of joint (at time of installation of joint system) is 4 in. (102 mm). The joint system is designed to accommodate a max 19 percent compression or extension from its installed width except that when the Fire Barrier Watertight Spray (see Item 2B) is used, the movement is limited to max 10 percent compression and extension. The joint system shall consist of the following:
 - A. **Forming Material*** – Min 4 pcf (64 kg/m³) mineral wool batt insulation installed in joint opening as a permanent form. Batt cut to min width of 6 in. (152 mm) and installed edge-first into joint opening, parallel with joint direction, such that batt sections are compressed min 50 percent in thickness and such that the compressed batt sections are flush with the top surface of floor. Adjoining lengths of batt to be tightly-butted with butted seams spaced min 36 in. (914 mm) apart along the length of the joint.

INDUSTRIAL INSULATION GROUP LLC – MinWool-1200 Safing
JOHNS MANVILLE – Safing
ROCK WOOL MANUFACTURING CO – Delta Board
ROCKWOOL MALAYSIA SDN BHD – Type Safe
ROXUL INC – Type Safe
THERMAFIBER INC – Type SAF
 - B. **Fill, Void or Cavity Material*** – Min 1/16 in. (1.6 mm) dry thickness (min 1/8 in. or 3.2 mm wet thickness) of fill material sprayed or brushed on top surface of floor to completely cover mineral wool and overlap a min of 1/2 in. (13 mm) onto concrete floor and wall. When 3M Fire Barrier Watertight Spray is used, min wet (and dry) thickness of spray is 1/10 in. (2.5 mm).

3M COMPANY – FireDam™ Spray 200, 3M Fire Barrier Watertight Spray
 - B1. **Fill, Void or Cavity Material* – Tape** – As an alternate to Item 2B, Tape cut to size and press applied to top surface of floor to completely cover mineral wool and overlap a min of 1 in. (25 mm) onto the concrete floor at both edges of joint. Tape shall be applied in minimum 1 ft (305 mm) lengths along the joint at top of floor and adjoining lengths of Tape shall overlap min 1/2 in. (13 mm).

3M COMPANY – 3M Fire and Water Barrier Tape

*Indicates such products shall bear the UL or cUL Certification Mark for jurisdictions employing the UL or cUL Certification (such as Canada), respectively. 
Reprinted from the Online Certifications Directory with permission from UL©

Construction Joints

Floor to Floor

FFD

System No. FF-S-0001

May 09, 2013

ANSI/UL2079

Assembly Rating – 2 Hr

Nominal Joint Width – 1 In.

L Rating At Ambient – Less Than 1 CFM/LIN ft (See Item 2B)

L Rating At 400 F – Less Than 1 CFM/s LIN q ft (See Item 2B)

CAN/ULC S115

F Rating – 2 Hr

FT Rating – 2 Hr

FH Rating – 2 Hr

FTH Rating – 2 Hr

Nominal Joint Width – 1 In.

L Rating At Ambient – Less Than 1 CFM/LIN ft (See Item 2B)

L Rating At 400 F – Less Than 1 CFM/LIN ft (See Item 2B)

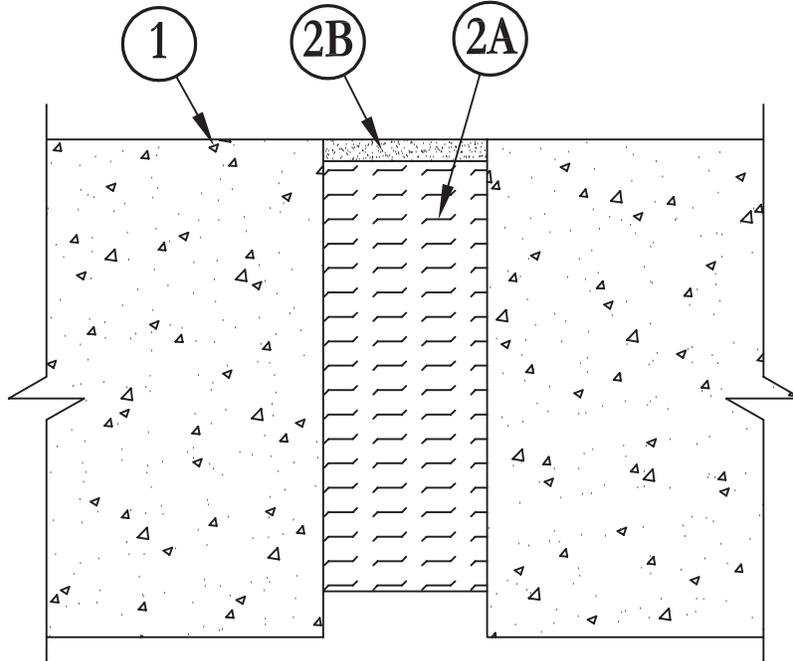

1. **Floor Assembly** – Min 5 in. (127 mm) thick reinforced normal weight (150 pcf or 2400 kg/m³) structural concrete.
2. **Joint System** – Max width of joint is 1 in. The joint system shall consist of the following:
 - A. **Packing Material** – Min 3 in. (76 mm) thickness of min 4.0 pcf (64 kg/m³) mineral wool batt insulation firmly packed into opening as a permanent form, or open cell polyurethane foam backer rod. The open cell polyurethane foam backer rod may be removed after the fill material has cured. Packing material to be recessed from top surface of floor to accommodate the required thickness of fill material.
 - B. **Fill, Void or Cavity Material*** – The type and thickness of fill material applied within the joint, flush with top surface of floor is dependent on the packing material used, as shown in the table below:

| Packing Mtl Type | Fill Mtl | Min Fill Thkns In. |
|------------------|---|--------------------|
| Backer Rod | FB-1000 NS, FB-1003 SL, FB-2000 or FB2000+ | 1-1/2 (38) |
| Mineral Wool | FB-2001 Foam | 1 (25) |

3M COMPANY – FB-1000 NS, FB-1003SL, FB-2000, FB-2000+ or FB-2001

(Note: L Ratings apply only when FB-1000 NS, FB-1003SL, FB-2000 or FB-2000+ is used.)

*Bearing the UL Classification Mark

Reprinted from the Online Certifications Directory with permission from UL

© 2013 UL LLC



System No. FF-S-0003

September 08, 2004
Assembly Rating – 2 Hr
Joint Width – 2 In. Max

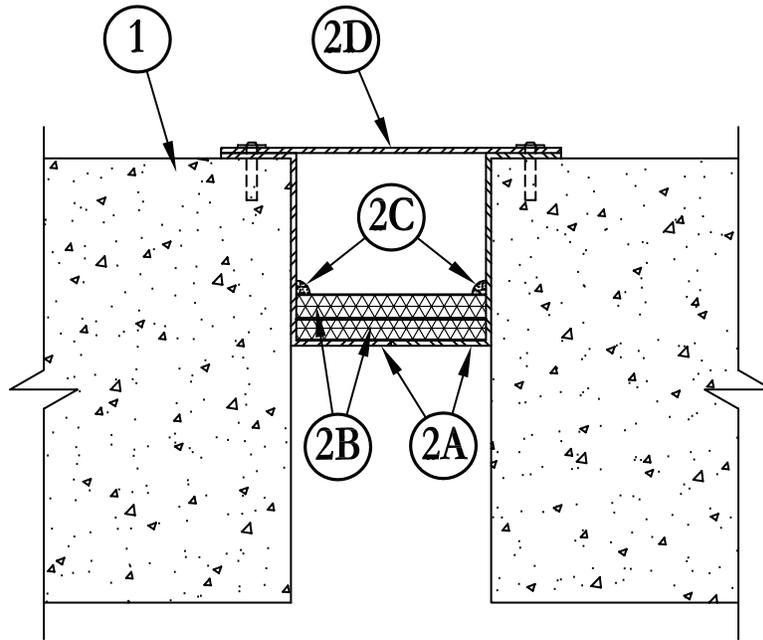

- 1. Floor Assembly** – Min 4-1/2 in. thick reinforced normal weight (150 pcf) structural concrete.
- 2. Joint System** – Max width of joint is 2 in. The joint system shall consist of the following:
 - A. Support Hangers** Nom 1 in. wide strips of min 0.019 in. thick (26 gauge) galv steel bent to form a “hat” shape with each “brim” of the “hat” shape bearing min 3/4 in. on the top surface of each floor slab and with the “crown” at a depth of 2-1/4 in. below the top surface of the floor. Support hangers spaced max 8 in. O.C. along length of joint opening with additional support hanger centered below butted end seam of fill material strips (Item 2B).
 - B. Fill, Void or Cavity Material*** – Nom 1/4 in. thick intumescent elastomer material faced on one side with aluminum foil, supplied in 2 in. wide strips. Strips friction-fitted in joint opening atop support hangers, with aluminum foil facing down, in two layers. First layer butted end seams to be centered over support hanger and covered with generous bead of caulk (Item 2C). Second layer butted end seams to be offset min 8 in. from first layer end seams and covered with generous bead of caulk (Item 2C).
3M COMPANY – FS-195+
 - C. Fill, Void or Cavity Material* – Caulk or Sealant** – Min 1/4 in. diam continuous bead applied to top edges of intumescent strip at its interface with the floor slabs on each side of the joint opening.
3M COMPANY – CP 25WB+ caulk or FB-3000 WT sealant
 - D. Joint Cover** – Nom 6 in. wide sheet of min 0.034 in. thick (20 gauge) galv steel. Sheet covered over joint opening along its entire length. When installed in more than one piece, adjoining sections of steel sheet to overlap min 2 in. Steel sheet secured to concrete slab on each side of joint opening with steel anchor bolts, or equivalent, spaced max 12 in. OC.

*Bearing the UL Classification Marking

Reprinted from the Online Certifications Directory with permission from Underwriters Laboratories Inc.
Copyright © 2010 Underwriters Laboratories Inc.®



System No. FF-S-0004

September 08, 2004

Assembly Ratings – 1-1/2, 2 and 3 Hr (See Item 2)

Joint Width – 1 and 2 In. Max (See Item 2)

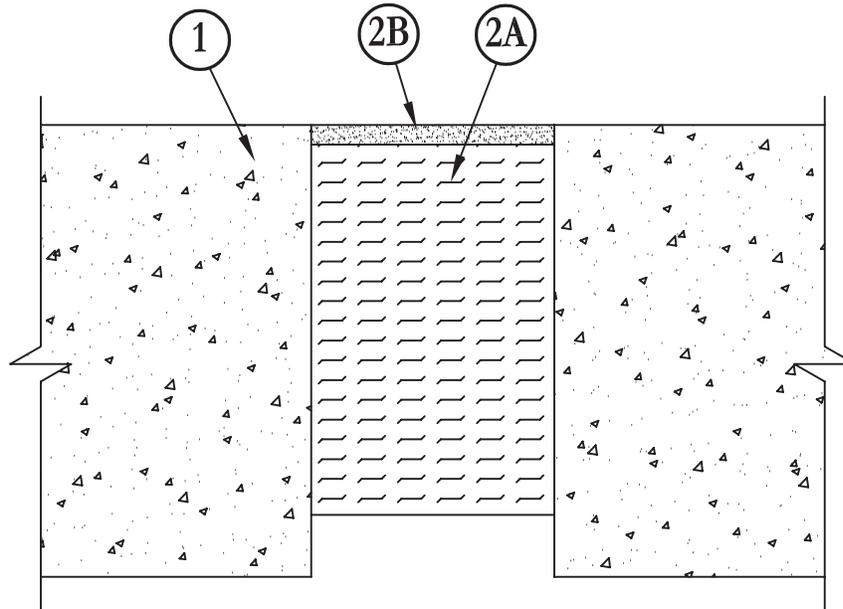

1. **Floor Assembly** – Min 4-1/2 in. thick reinforced lightweight or normal weight (100-150 pcf) structural concrete.
2. **Joint System** – Max width of joint is 1 in. or 2 in. dependent on density of the packing material (Item 2A) and the thickness of the fill material (Item 2B), as shown in the table below. **The Assembly Rating is dependent on the criteria outlined in the table below.** The joint system shall consist of the following:
 - A. **Packing Material** – Min 3 in. thickness of min 4.0 pcf or min 6.0 pcf mineral wool batt insulation firmly packed into opening as a permanent form. The appropriate min density of the mineral wool is outlined in the table below. Packing material to be recessed from top surface of floor to accommodate the required thickness of fill material.
 - B. **Fill, Void or Cavity Material*** – Min 1/4 in. or min 1/2 in. thickness of fill material applied within the joint, flush with top surface of floor, as outlined in the table below:

| Max Joint Opening Width In. | Packing Mtl Min Density pcf | Min Fill Mtl Thkns In. | Assembly Rating Hr |
|-----------------------------|-----------------------------|------------------------|--------------------|
| 1 | 4 | 1/4 | 2 |
| 2 | 4 | 1/2 | 1-1/2 |
| 2 | 6 | 1/2 | 3 |

3M COMPANY – CP 25WB+ or FB-3000 WT

*Bearing the UL Classification Mark

Reprinted from the Online Certifications Directory with permission from UL

© 2012 UL LLC



System No. FF-S-1003

May 09, 2013

ANSI/UL2079

Assembly Rating – 3 Hr

Nominal Joint Width – 6 In.

L Rating At Ambient – Less Than 1 CFM/LIN ft

L Rating At 400 F – Less Than 1 CFM/LIN ft

CAN/ULC S115

F Rating – 3 Hr

FT Rating – 3 Hr

FH Rating – 3 Hr

FTH Rating – 3 Hr

Nominal Joint Width – 6 In.

L Rating At Ambient – Less Than 1 CFM/LIN ft

L Rating At 400 F – Less Than 1 CFM/LIN ft

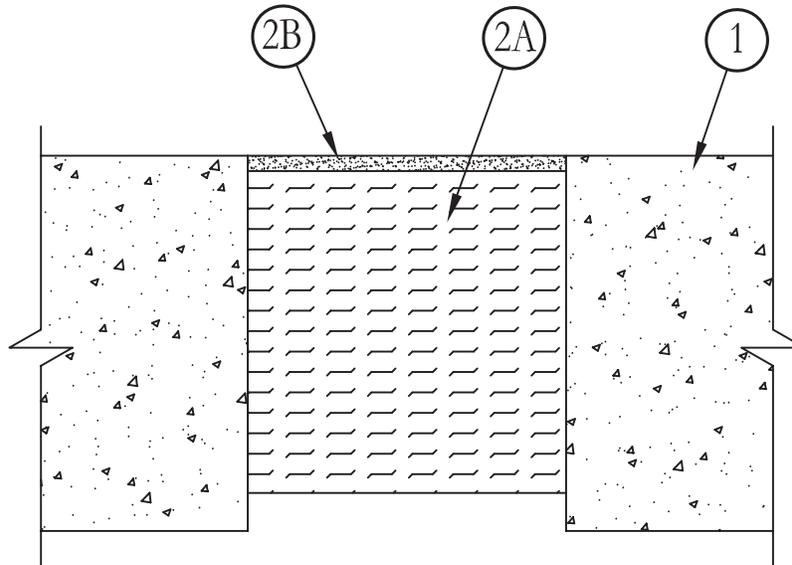

1. **Floor Assembly** – Min 5-1/2 in. (140 mm) thick reinforced lightweight or normal weight (100-150 pcf or 1600-2400 kg/m³) structural concrete.
2. **Joint System** – Max width of joint is 6 in. The joint system shall consist of the following:
 - A. **Packing Material** – Min 4 in. (102 mm) thickness of min 4.0 pcf (64 kg/m³) mineral wool batt insulation firmly packed into opening as a permanent form. Packing material to be recessed from top surface of floor to accommodate the required thickness of fill material.
 - B. **Fill, Void or Cavity Material*** – Min 3/4 in. (19 mm) thickness of fill material applied within the joint, flush with top surface of floor.
3M COMPANY – FB-1000 NS, FB-1003SL, FB-2000 or FB-2000+

*Bearing the UL Classification Mark

Reprinted from the Online Certifications Directory with permission from UL

© 2013 UL LLC



System No. FF-S-1004

September 08, 2004
 Assembly Ratings – 1 & 2 Hr (See Item 2)
 Joint Width – 4 & 6 In. Max (See Item 2)

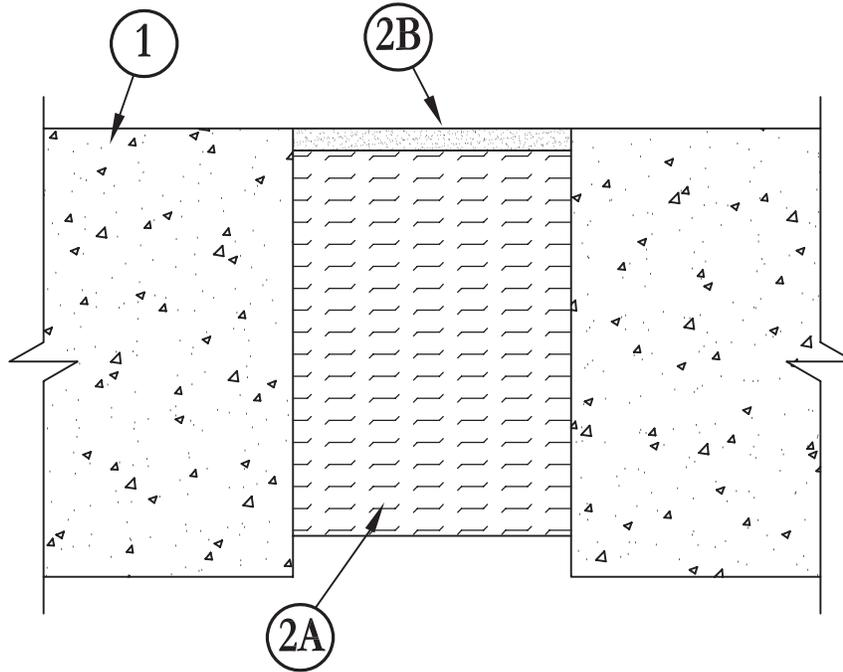

1. **Floor Assembly** – Min 4-1/2 in. thick reinforced lightweight or normal weight (100-150 pcf) structural concrete.
2. **Joint System** – Max width of joint is 4 in. or 6 in., dependent on density of the packing material (Item 2A) and the thickness of the fill material (Item 2B), as shown in the table below. **The Assembly Rating is dependent on the criteria outlined in the table below.** The joint system shall consist of the following:
 - A. **Packing Material** – Min 3 in. thickness of min 4.0 pcf or min 6.0 pcf mineral wool batt insulation firmly packed into opening as a permanent form. The appropriate min density of the mineral wool is outlined in the table below. Packing material to be recessed from top surface of floor to accommodate the required thickness of fill material.
 - B. **Fill, Void or Cavity Material* – Caulk or Sealant** – Min 1/2 in. or min 1 in. thickness of fill material applied within the joint, flush with top surface of floor, as outlined in the table below:

| Max Joint Opening Width In. | Packing Mtl Min Density pcf | Min Fill Mtl Thkns In. | Assembly Rating Hr |
|-----------------------------|-----------------------------|------------------------|--------------------|
| 4 | 4 | 1/2 | 1 |
| 4 | 6 | 1/2 | 2 |
| 6 | 4 | 1 | 2 |

3M COMPANY – CP 25WB+ caulk or FB-3000 WT sealant

*Bearing the UL Classification Marking

Reprinted from the Online Certifications Directory with permission from Underwriters Laboratories Inc.
 Copyright © 2010 Underwriters Laboratories Inc.®



System No. FF-S-1027

August 03, 2001

Assembly Rating – 2 Hr

L Rating At Ambient – Less Than 1 CFM/Lin Ft

L Rating At 400 F – Less Than 1 CFM/Lin Ft

Joint Width – 6 in. Max

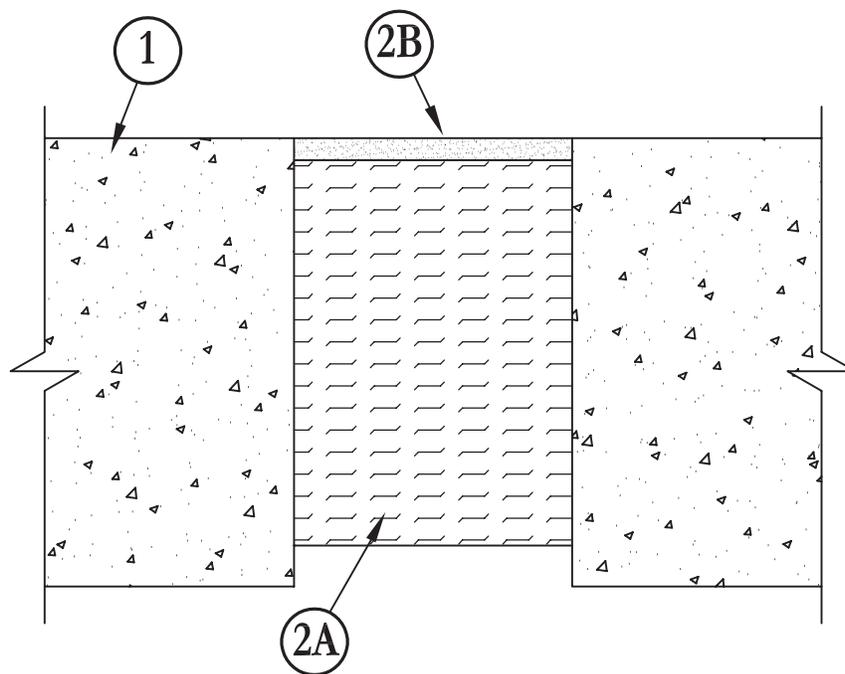

1. **Floor Assembly** – Min 4-1/2 in. thick reinforced lightweight or normal weight (100-150 pcf) structural concrete.
2. **Joint System** – Max width of joint is 6 in. The joint system shall consist of the following:
 - A. **Packing Material** – Min 3-3/4 in. thickness of min 4.0 pcf mineral wool batt insulation packed into opening as a permanent form such that the width of the wool is compressed at least 25 percent. Packing material to be recessed from top surface of floor to accommodate the required thickness of fill material.
 - B. **Fill, Void or Cavity Material*** – Min 1/4 in. thickness of fill material applied within the joint, flush with top surface of floor.
3M COMPANY – FB-1000 NS or FB-1003 SL

*Bearing the UL Classification Mark

Reprinted from the Online Certifications Directory with permission from Underwriters Laboratories Inc.
 Copyright © 2010 Underwriters Laboratories Inc.®



3M Firestop Systems

Construction Joints

Floor to Wall

FWD

Floor to Wall Dynamic

FWS

Floor to Wall Static

Quick Reference Guide

Floor-to-Wall

| 3M UL Systems | "F" Rating | 3M Product | Through Penetrant Details |
|---------------|------------|--|---|
| FW-D-0004 | 2 | 3M™ FireDam™ Spray 200 3M™ Fire and Water Barrier Tape | 2 in. wide joint. 19% compression/extension, minimum 4-1/2 in. concrete wall to minimum 4-1/2 in. concrete floor. 2 hour F rating. Also known as FWD0004. |
| FW-D-0007 | 2, 3, 4 | 3M™ Fire Barrier Silicone Sealant 2000+ | 2" wide, 10.9% compress/extension, concrete/concrete. Also referred as FWD0007. |
| FW-D-0011 | 2, 3, 4 | 3M™ FireDam™ Spray 200 3M™ Fire and Water Barrier Tape | 2 in. wide joint. 19% compress/extension, concrete/concrete. Also known as FWD0011. |
| FW-D-0012 | 2 | 3M™ Fire Barrier Water Tight Sealant 1003 SL | Precast autoclaved aerated concrete floor to precast autoclaved aerated concrete wall. Min 4 in. thick concrete. Max 1/2 in. joint. 31% movement. 2 hour F rating. Also known as FWD0012. |
| FW-D-1002 | 2, 3 | 3M™ Fire Barrier Water Tight Sealant 1000 NS 3M™ Fire Barrier Water Tight Sealant 1003 SL | 4" wide, 31% compress/extension, concrete/concrete. Also referred as FWD1002. |
| FW-D-1003 | 2 | 3M™ Fire Barrier Water Tight Sealant 1000 NS 3M™ Fire Barrier Water Tight Sealant 1003 SL | 4" wide, 25% compress/extension, concrete/concrete. Also referred as FWD1003. |
| FW-D-1009 | 2, 3 | 3M™ Fire Barrier Silicone Sealant 2000+ | 4" wide, 12.5% compress/extension, concrete/concrete. Also referred as FWD1009. |
| FW-D-1017 | 2 | 3M™ Fire Barrier Water Tight Sealant 1003 SL | Max 4 in. wide joint. 15.6% compression/extension. Min 4-1/2 in. concrete floor to min 4-1/2 in. concrete wall. 2 hour F rating. Also known as FWSD1017. |
| FW-D-1040 | 2, 3 | 3M™ FireDam™ Spray 200 3M™ Fire and Water Barrier Tape | 4 in. wide joint. 19% compression/extension,. Min 6 in. concrete floor to min 6 in. concrete wall. 3 hour F rating. Also known as FWD1040. |
| FW-D-1070 | 2 | 3M™ Fire Barrier Water Tight Sealant 1000 NS | Min 4-1/2 in. concrete stair assembly. Min 4-1/2 in. concrete wall. Max joint 4 in. 2 hour F rating,15.6% compression/extension. Mineral wool and sealant. Also known as FWD1070. |
| FW-S-0001 | 1 | 3M™ Fire Barrier Sealant CP 25WB+ 3M™ Fire Barrier Water Tight Sealant 3000 WT | 1-1/2" wide, concrete/concrete. Also referred as FWS0001. |

System No. FW-D-0004
 XHBN - Joint Systems
 XHBN7 - Joint Systems Certified for Canada
 January 13, 2017

Construction Joints

Floor to Wall

| ANSI/UL2079 | CAN/ULC S115 |
|---|---|
| Assembly Rating — 2 Hr | F Rating — 2 Hr |
| Nominal Joint Width - 2 In. | FT Rating — 2 Hr |
| Class II Movement Capabilities — 19% or 10% Compression Or Extension (See Item 2) | FH Rating — 2 Hr |
| L Rating at Ambient — Less than 1 CFM/Lin Ft | FTH Rating — 2 Hr |
| L Rating at 400°F — Less than 1 CFM/Lin Ft | Nominal Joint Width - 51 mm |
| | Class II Movement Capabilities — 19% or 10% Compression Or Extension (See Item 2) |
| | L Rating at Ambient — Less than 1.55 L/s/lin m |
| | L Rating at 204°C — Less than 1.55 L/s/lin m |

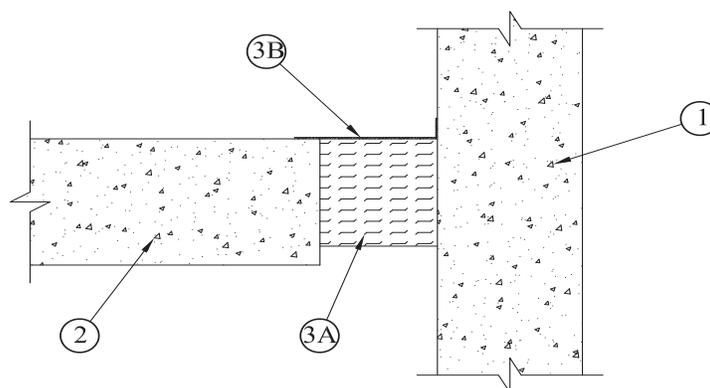

- Wall Assembly** — Min 4-1/2 in. (114 mm) thick reinforced lightweight or normal weight (100-150 pcf or 1600-2400 kg/m³) structural concrete. Wall may also be constructed of any UL Classified **Concrete Blocks***.
 See **Concrete Blocks (CAZT)** category in the Fire Resistance Directory for names of manufacturers.
- Floor Assembly** — Min 4-1/2 in. (114 mm) thick steel-reinforced lightweight or normal weight (100-150 pcf or 1600-2400 kg/m³) structural concrete.
- Joint System** — Max width of joint (at time of installation of joint system) is 2 in. (51 mm). The joint system is designed to accommodate a max 19 percent compression or extension from its installed width except that when the Fire Barrier Watertight Spray (see Item 2B) is used, the movement is limited to max 10 percent compression and extension. The joint system shall consist of the following:
 - Forming Material*** — Min 4 pcf (64 kg/m³) mineral wool batt insulation installed in joint opening as a permanent form. Batt cut to min width of 4 in. (102 mm) and installed edge-first into joint opening, parallel with joint direction, such that batt sections are compressed min 50 percent in thickness and such that the compressed batt sections are flush with the top surface of floor. Adjoining lengths of batt to be tightly-butted with butted seams spaced min 48 in. (1.2 m) apart along the length of the joint.
INDUSTRIAL INSULATION GROUP LLC — MinWool-1200 Safing
JOHNS MANVILLE — Safing
ROCK WOOL MANUFACTURING CO — Delta Safing Board
ROCKWOOL MALAYSIA SDN BHD — Type Safe
ROXUL INC — Type Safe
THERMAFIBER INC — Type SAF
 - Fill, Void or Cavity Material*** — Min 1/16 in. (1.6 mm) dry thickness (min 1/8 in. or 3.2 mm wet thickness) of fill material sprayed or brushed on top surface of floor to completely cover mineral wool and overlap a min of 1/2 in. (13 mm) onto concrete floor and wall. When 3M Fire Barrier Watertight Spray is used, min wet (and dry) thickness of spray is 1/10 in. (2.5 mm).
3M COMPANY — FireDam™ Spray 200, 3M Fire Barrier Watertight Spray
 - Fill, Void or Cavity Material* - Tape** — As an alternate to Item 3B, Tape cut to size and press applied to top surface of floor to completely cover mineral wool and overlap a min of 1 in. (25 mm) onto the concrete floor and wall. Tape shall be applied in minimum 1 ft (305 mm) lengths along the joint at top of floor and adjoining lengths of Tape shall overlap min 1/2 in. (13 mm).
3M COMPANY — 3M Fire and Water Barrier Tape

* Indicates such products shall bear the UL or cUL Certification Mark for jurisdictions employing the UL or cUL Certification (such as Canada), respectively.



System No. FW-D-0007
 April 22, 2011
 Assembly Rating – 4 Hr
 Nominal Joint Width – 2 In.
 Class II Movement Capabilities – 10.9% Compression or Extension

Construction Joints

Floor to Wall

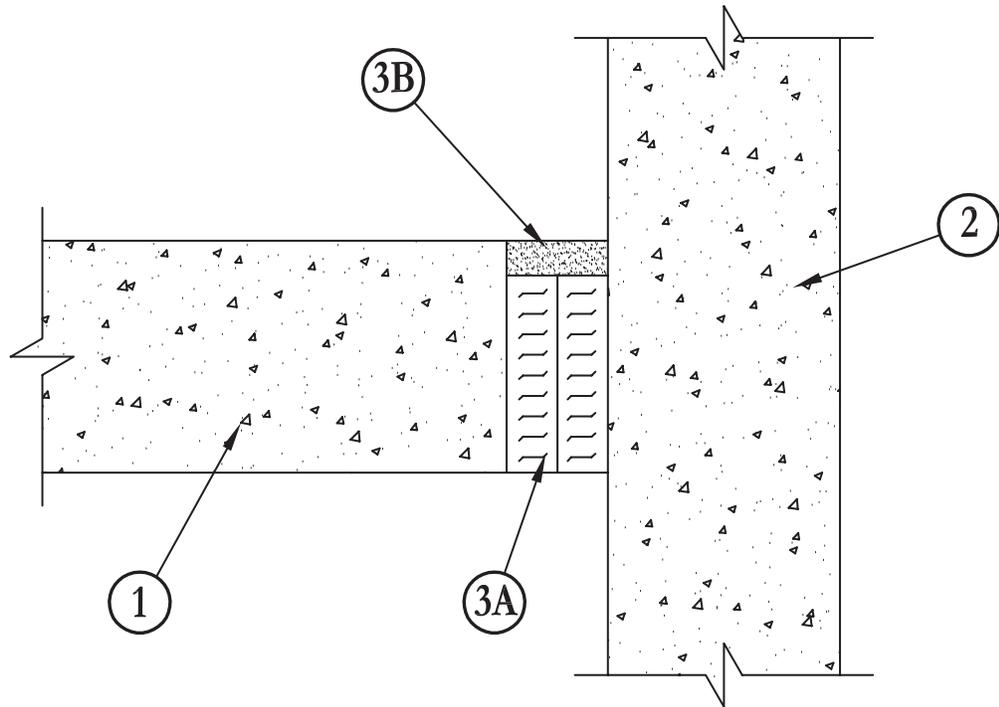

1. **Floor Assembly** – Min 5-1/2 in. thick steel-reinforced lightweight or normal weight (100-150 pcf) structural concrete.
2. **Wall Assembly** – Min 5-1/2 in. thick steel-reinforced lightweight or normal weight (100-150 pcf) structural concrete. Wall may also be constructed of any UL Classified **Concrete Blocks***
3. **Joint System** – **Max width of joint (at time of installation of joint system) is 2 in. The joint system is designed to accommodate a max 10.9 percent compression or extension from its installed width.** The joint system shall consist of the following:
 - A. **Forming Material*** – Min 4.0 pcf mineral wool batt insulation installed in joint opening as a permanent form. Batt cut to min width of 5 in. and installed edge-first into joint opening, parallel with joint direction, such that batt sections are compressed min 50 percent in thickness and such that the compressed batt sections are recessed from the top surface of floor to accommodate the required thickness of fill material. Adjoining lengths of batt to be tightly-butted with butted seams spaced min 48 in. apart along the length of the joint.
ROCKWOOL MANUFACTURING CO – Delta Safing Board
ROCKWOOL MALAYSIA SDN BHD – Type Safe
ROXUL INC – Type Safe
THERMAFIBER INC – Type SAF
 - B. **Fill, Void or Cavity Material*** – Min 1/2 in. thickness of fill material applied within the joint, flush with top surface of floor.
3M COMPANY – FB 2000+

*Bearing the UL Classification Mark

Reprinted from the Online Certifications Directory with permission from Underwriters Laboratories Inc.
 Copyright © 2011 Underwriters Laboratories Inc.®



FW-D

UL System No. FW-D-0011

December 06, 2016

ANSI/UL2079

Assembly Rating – 4 Hr
Nominal Joint Width – 2 in.

Class II Movement Capabilities – 19% Compression or Extension

CAN/ULC S115

F Rating – 4 Hr
FT Rating – 4 Hr
FH Rating – 4 Hr
FTH Rating – 4 Hr

Nominal Joint Width – 51 mm

Class II Movement Capabilities – 19% Compression or Extension

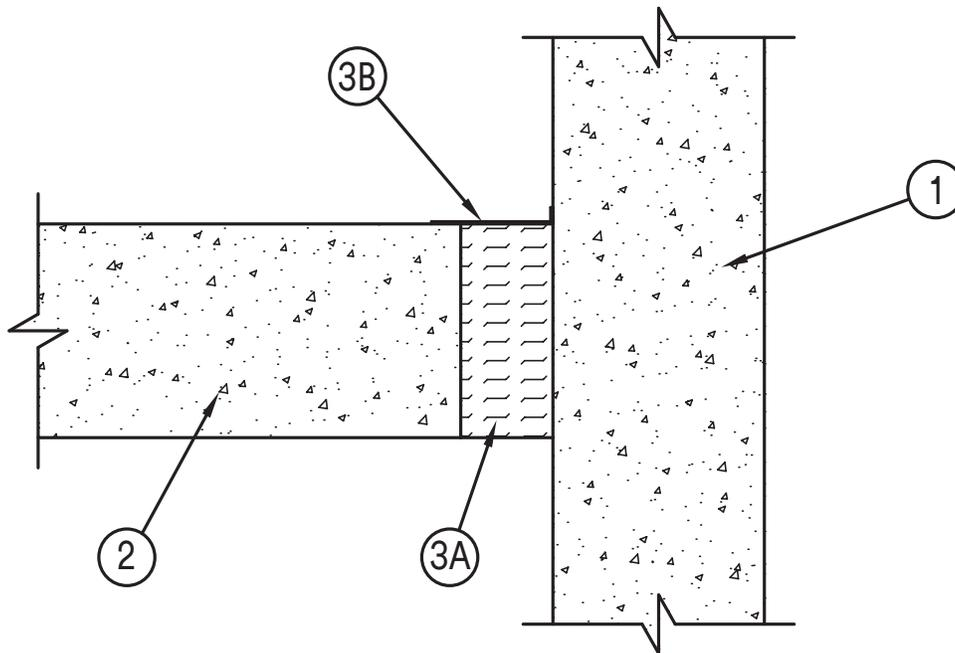

- 1. Wall Assembly** – Min 6 in. (152 mm) thick reinforced lightweight or normal weight (100-150 pcf or 1600-2400 kg/m³) structural concrete. Wall may also be constructed of any UL Classified **Concrete Blocks***.
See **Concrete Blocks** (CAZT) category in the Fire Resistance Directory for names of manufacturers.
- 2. Floor Assembly** – Min 6 in. (152 mm) thick steel-reinforced lightweight or normal weight (100-150 pcf or 1600-2400 kg/m³) structural concrete.
- 3. Joint System** – Max width of joint (at time of installation of joint system) is 2 in. (51 mm). The joint system is designed to accommodate a max 19 percent compression or extension from its installed width. The joint system shall consist of the following:
 - A. Forming Material*** – Min 4 pcf (64 kg/m³) mineral wool batt insulation installed in joint opening as a permanent form. Batt cut to min width of 6 in. (152 mm) and installed edge-first into joint opening, parallel with joint direction, such that batt sections are compressed min 50 percent in thickness and such that the compressed batt sections are flush with top surface of floor. Adjoining lengths of batt to be tightly butted with butted seams spaced min 48 in. (1.2 m) apart along the length of the joint.
INDUSTRIAL INSULATION GROUP LLC – MinWool-1200 Safing
THERMAFIBER INC – Type SAF
ROCK WOOL MANUFACTURING CO – Delta Safing Board
 - B. Fill, Void or Cavity Material* – Tape** – As an alternate to Item 3B, Tape cut to size and press applied to top surface of floor to completely cover mineral wool and overlap a min of 1/2 in. (13 mm) onto concrete floor and wall.
3M COMPANY – FireDam™ Spray 200
 - B1. Fill, Void or Cavity Material* – Tape** – As an alternate to Item 3B, Tape cut to size and press applied to top surface of floor to completely cover mineral wool and overlap a min of 1 in. (25 mm) onto the concrete floor and wall. Tape shall be applied in minimum 1 ft (305 mm) lengths along the joint at top of floor and adjoining lengths of Tape shall overlap min 1/2 in. (13 mm).
3M COMPANY – 3M Fire and Water Barrier Tape

*Indicates such products shall bear the UL or cUL Certification Mark for jurisdictions employing the UL or cUL Certification (such as Canada), respectively. 

Reprinted from the Online Certifications Directory with permission from UL©

Construction Joints

Floor to Wall

FWD



UL System No. FW-D-0012
XHBN - Joint Systems
XHBN7 - Joint Systems Certified for Canada

August 17, 2012

F Rating — 2 Hr

FT Rating — 2 Hr

FH Rating — 2 Hr

FTH Rating — 2 Hr

Nominal Joint Width — 1/2 in.

Class II Movement Capabilities — 31% Compression or Extension

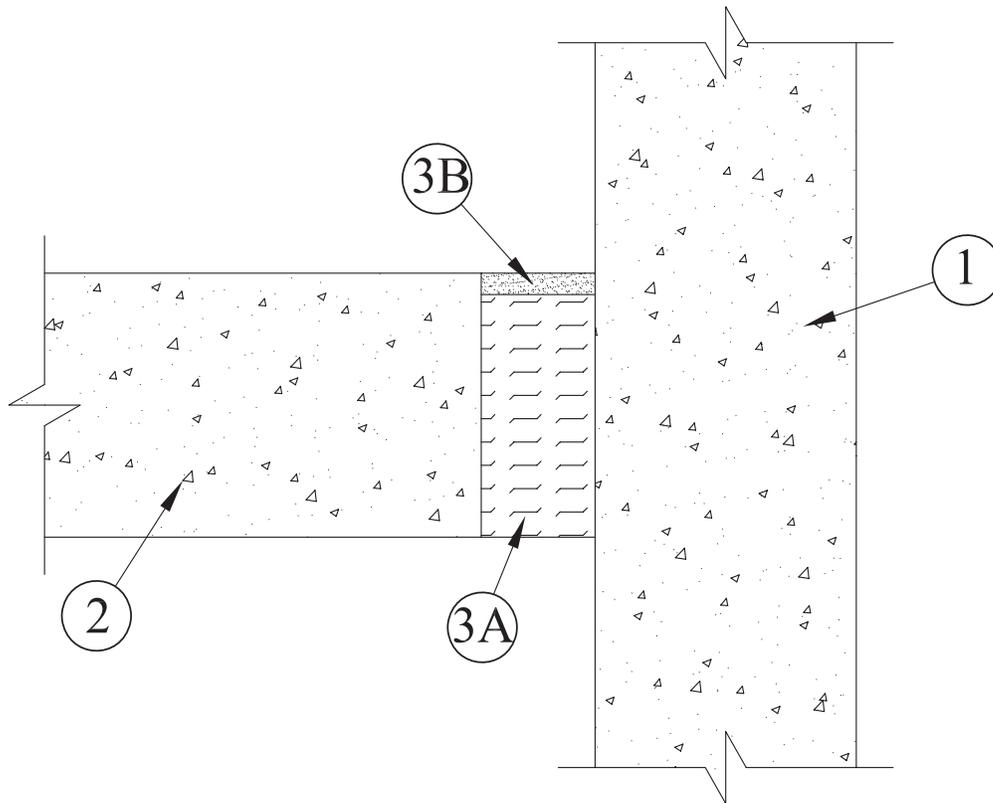

1. Floor Assembly — Precast Autoclaved Aerated Concrete* — Min 4 in. thick as specified in Design No. K909, K910, P932 or P933 in the UL Fire Resistance Directory.

AERCON FLORIDA L L C — Types AC-3.3, AC-4, AC-4.4, AC-6, AC-6.6

2. Wall Assembly — Precast Autoclaved Aerated Concrete* — Min 4 in. thick as specified in Design No. U919 or U920 in the UL Fire Resistance Directory.

AERCON FLORIDA L L C — Types AC-2, AC-3.3, AC-4, AC-4.4, AC-6, AC-6.6

3. Joint System — Max width of joint (at time of installation of joint system) is 1/2 in. The joint system is designed to accommodate a max 31 percent compression or extension from its installed width. — The joint system shall consist of the following:

A. Forming Material* — Min 4.0 pcf mineral wool batt insulation installed in joint opening as a permanent form. Min 3-1/2 in. thickness of batt cut to the appropriate width and installed into joint opening such that batt sections are compressed min 50 percent in width and such that the compressed batt sections are recessed from the top surface of floor to accommodate the required thickness of fill material. Adjoining lengths of batt to be tightly-butted with butted seams spaced min 24 in. apart along the length of the joint.

ROCK WOOL MANUFACTURING CO — Delta Safing Board

THERMAFIBER INC — Type SAF

B. Fill, Void or Cavity Material* — Min 1/2 in. thickness of fill material applied within the joint, flush with top surface of wall.

3M COMPANY 3M/DYNEON — FB-1003 SL

*Indicates such products shall bear the UL or cUL Certification Mark for jurisdictions employing the UL or cUL Certification (such as Canada), respectively. Reprinted from the Online Certifications Directory with permission from UL©



System No. FW-D-1002

May 09, 2013

ANSI/UL2079

Assembly Rating – 3 Hr

Nominal Joint Width – 4 In.

Class II Movement Capabilities – 31% Compression or Extension

CAN/ULC S115

F Rating – 3 Hr

FT Rating – 3 Hr

FH Rating – 3 Hr

FTH Rating – 3 Hr

Nominal Joint Width – 4 In.

Class II Movement Capabilities – 31% Compression or Extension

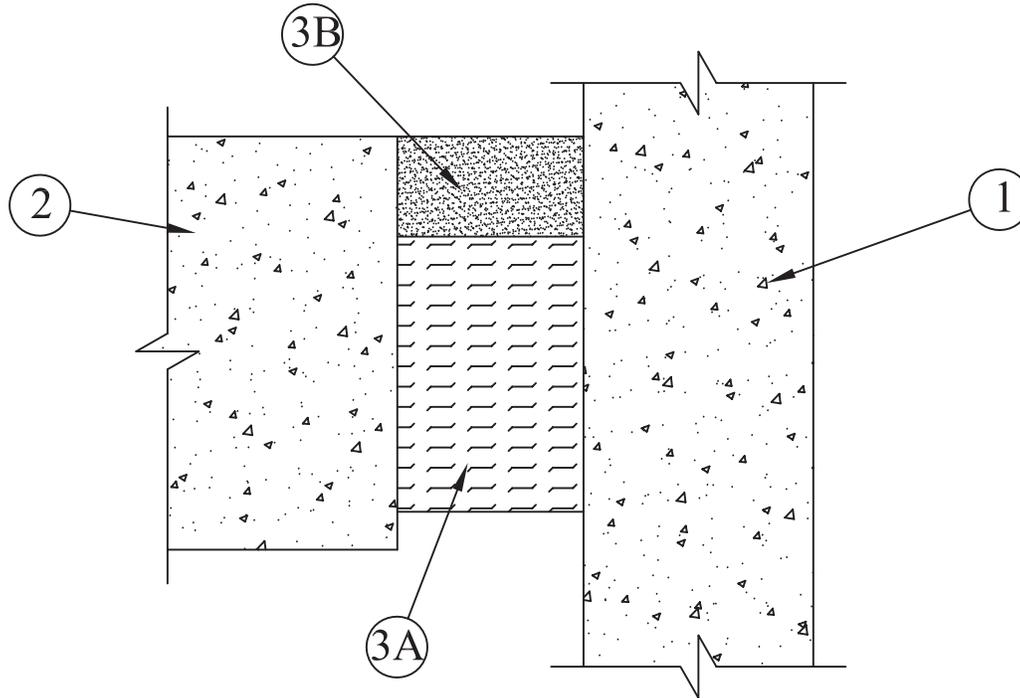

1. **Wall Assembly** – Min 4-1/2 in. (114 mm) thick reinforced lightweight or normal weight (100-150 pcf or 1600-2400 kg/m³) structural concrete. Wall may also be constructed of any UL Classified **Concrete Blocks***.
See **Concrete Blocks (CAZT)** category in the Fire Resistance Directory for names of manufacturers.
2. **Floor Assembly** – Min 4-1/2 in. (114 mm) thick steel-reinforced lightweight or normal weight (100-150 pcf or 1600-2400 kg/m³) structural concrete.
3. **Joint System** – **Max width of joint (at time of installation of joint system) is 4 in. The joint system is designed to accommodate a max 31 percent compression or extension from its installed width.** The joint system shall consist of the following:
 - A. **Forming Material*** – Min 4.0 pcf (64 kg/m³) mineral wool batt insulation installed in joint opening as a permanent form. Pieces of batt cut to min width of 4 in. (102 mm) and installed edge-first into joint opening, parallel with joint direction, such that batt sections are compressed min 50 percent in thickness and such that the compressed batt sections are recessed from top surface of floor to accommodate the required thickness of fill material. Adjoining lengths of batt to be tightly-butted with butted seams spaced min 12 in. (305 mm) apart along the length of the joint.
HIG MINWOOL LLC – MinWool-1200 Safing
ROCK WOOL MANUFACTURING CO – Delta Board
ROCKWOOL MALAYSIA SDN BHD – Type Safe
ROXUL INC – Type Safe
THERMAFIBER INC – Type SAF
 - B. **Fill, Void or Cavity Material*** – Min 1/2 in. (13 mm) thickness of fill material applied within the joint, flush with top surface of floor
3M COMPANY – FB-1000 NS, FB-1003SL or FB-2000

*Bearing the UL Classification Mark

Reprinted from the Online Certifications Directory with permission from UL

© 2013 UL LLC



System No. FW-D-1003

May 09, 2013

ANSI/UL2079

Assembly Rating – 2 Hr

Nominal Joint Width – 4 In.

Class II Movement Capabilities – 25% Compression or Extension

CAN/ULC S115

F Rating – 2 Hr

FT Rating – 2 Hr

FH Rating – 2 Hr

FTH Rating – 2 Hr

Nominal Joint Width – 4 In.

Class II Movement Capabilities – 25% Compression or Extension

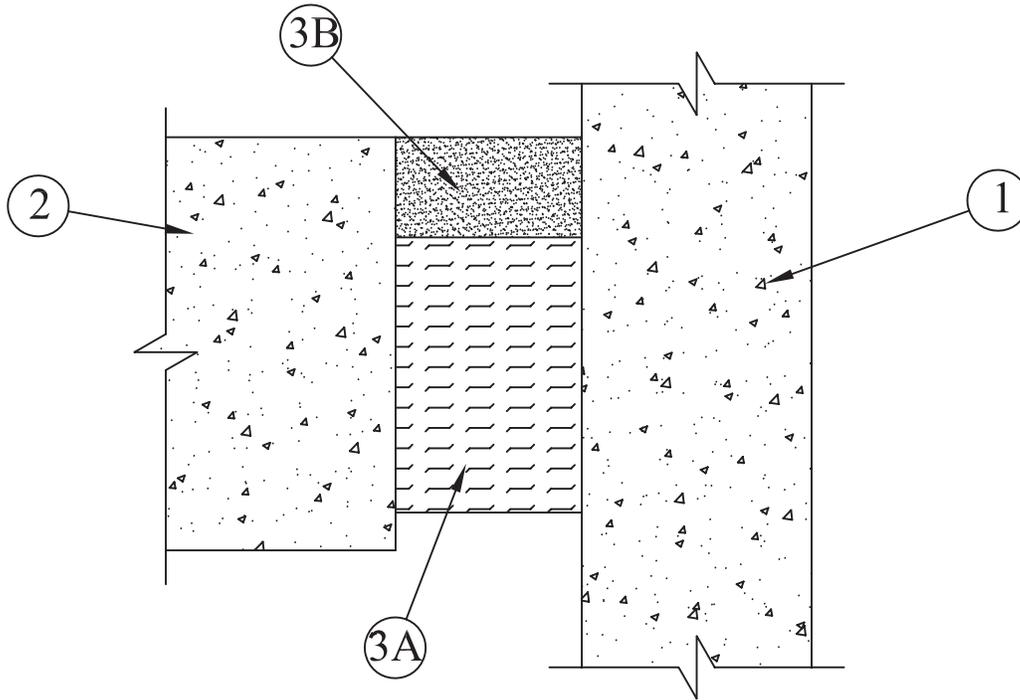

- Wall Assembly** – Min 4-1/2 in. (114 mm) thick reinforced lightweight or normal weight (100-150 pcf or 1600-2400 kg/m³) structural concrete. Wall may also be constructed of any UL Classified **Concrete Blocks***.
See **Concrete Blocks (CAZT)** category in the Fire Resistance Directory for names of manufacturers.
- Floor Assembly** – Min 4-1/2 in. (114 mm) thick steel-reinforced lightweight or normal weight (100-150 pcf or 1600-2400 kg/m³) structural concrete.
- Joint System** – Max width of joint (at time of installation of joint system) is 4 in. The joint system is designed to accommodate a max 25 percent compression or extension from its installed width. The joint system shall consist of the following:
 - Forming Material*** – Min 4.0 pcf (64 kg/m³) mineral wool batt insulation installed in joint opening as a permanent form. Pieces of batt cut to min width of 4 in. (102 mm) and installed edge-first into joint opening, parallel with joint direction, such that batt sections are compressed min 50 percent in thickness and such that the compressed batt sections are recessed from top surface of floor to accommodate the required thickness of fill material. Adjoining lengths of batt to be tightly-butted with butted seams spaced min 12 in. (305 mm) apart along the length of the joint.
IIG MINWOOL LLC – MinWool-1200 Safing
ROCK WOOL MANUFACTURING CO – Delta Board
ROCKWOOL MALAYSIA SDN BHD – Type SAF
ROXUL INC – Type SAF
THERMAFIBER INC – Type SAF
 - Fill, Void or Cavity Material*** – Min 1/4 in. (6 mm) thickness of fill material applied within the joint, flush with top surface of floor
3M COMPANY – FB-1000 NS, FB-1003SL or FB-2000

*Bearing the UL Classification Mark

Reprinted from the Online Certifications Directory with permission from UL
© 2013 UL LLC



System No. FW-D-1009

December 04, 2000

Assembly Rating – 3 Hr

Nominal Joint Width – 4 In.

Class II Movement Capabilities – 12.5% Compression Or Extension

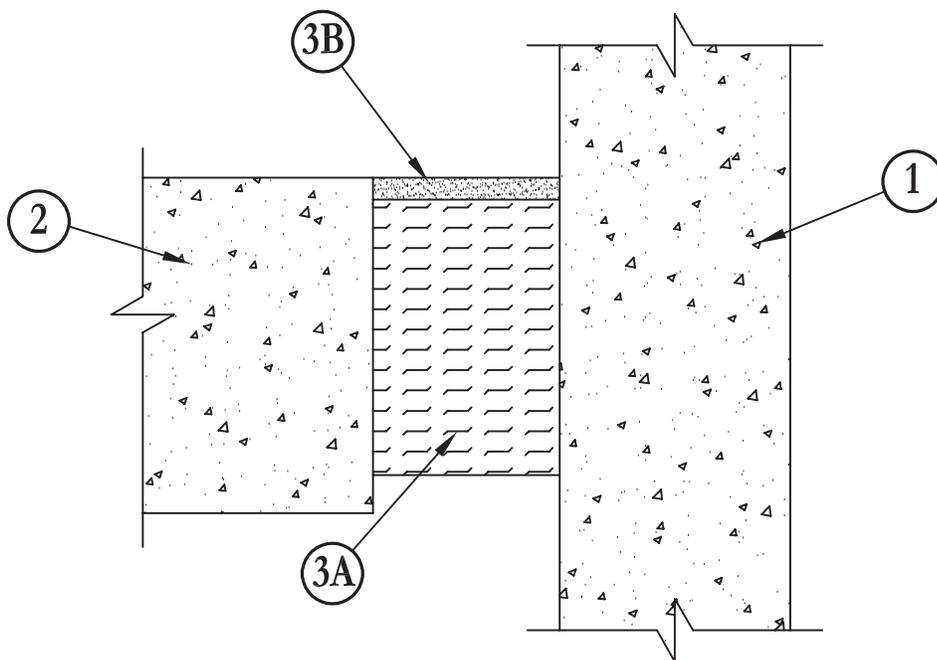

1. **Wall Assembly** – Min 4-1/2 in. thick reinforced lightweight or normal weight (100-150 pcf) structural concrete. Wall may also be constructed of any UL Classified **Concrete Blocks***.
See **Concrete Blocks (CAZT)** category in the Fire Resistance Directory for names of manufacturers.
2. **Floor Assembly** – Min 4-1/2 in. thick steel-reinforced lightweight or normal weight (100-150 pcf) structural concrete.
3. **Joint System** – **Max width of joint (at time of installation of joint system) is 4 in. The joint system is designed to accommodate a max 12.5 percent compression or extension from its installed width.** The joint system shall consist of the following:
 - A. **Forming Material*** – Min 4.0 pcf mineral wool batt insulation installed in joint opening as a permanent form. Pieces of batt cut to min width of 4 in. and installed edge-first into joint opening, parallel with joint direction, such that batt sections are compressed min 50 percent in thickness and such that the compressed batt sections are recessed from top surface of floor to accommodate the required thickness of fill material. Adjoining lengths of batt to be tightly-butted with butted seams spaced min 12 in. apart along the length of the joint.
HIG MINWOOL L L C – MinWool-1200 Safing
ROCK WOOL MANUFACTURING CO – Delta Safing Board
ROCKWOOL MALAYSIA SDN BHD – Type Safe
ROXUL INC – Type Safe
THERMAFIBER INC – Type SAF
 - B. **Fill, Void or Cavity Material*** – Min 1/4 in. thickness of fill material applied within the joint, flush with top surface of floor.
3M COMPANY – FB-2000+

*Bearing the UL Classification Mark

Reprinted from the Online Certifications Directory with permission from UL
© 2012 UL LLC

System No. FW-D-1017

January 11, 2013

Assembly Rating – 2 Hr

L Rating At Ambient – Less Than 1 CFM/Lin Ft

L Rating At 400 F – Less Than 1 CFM/Lin Ft

Nominal Joint Width – 4 In.

Class II Movement Capabilities – 15.6% Compression or Extension

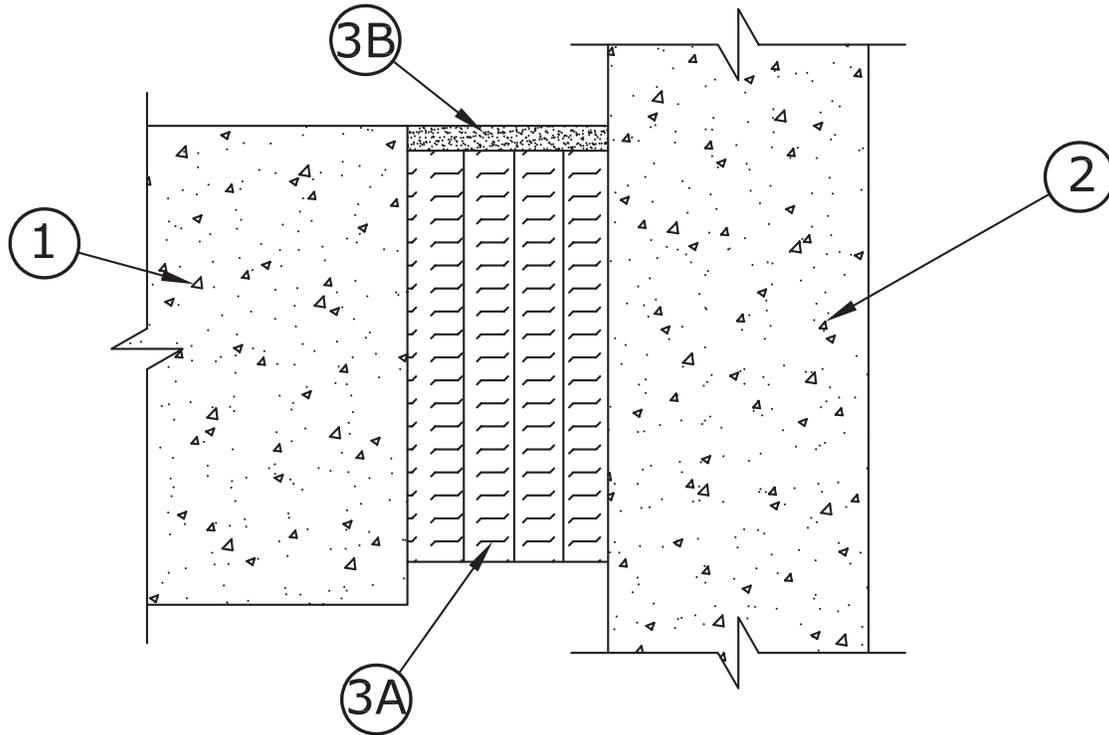

1. **Floor Assembly** – Min 4-1/2 in. thick steel-reinforced lightweight or normal weight (100-150 pcf) structural concrete.
2. **Wall Assembly** – Min 4-1/2 in. thick steel-reinforced lightweight or normal weight (100-150 pcf) structural concrete. Wall may also be constructed of any UL Classified **Concrete Blocks***.
3. **Joint System** – **Max width of joint (at time of installation of joint system) is 4 in. The joint system is designed to accommodate a max 15.6 percent compression or extension from its installed width.** The joint system shall consist of the following:
 - A. **Forming Material*** – Min 4.0 pcf mineral wool batt insulation installed in joint opening as a permanent form. Batt cut to min width of 4 in. and installed edge-first into joint opening, parallel with joint direction, such that batt sections are compressed min 50 percent in thickness and such that the compressed batt sections are recessed from the top surface of floor to accommodate the required thickness of fill material. Adjoining lengths of batt to be tightly-butted with butted seams spaced min 48 in. apart along the length of the joint. –
ROCK WOOL MANUFACTURING CO – Delta Safing Board
ROCKWOOL MALAYSIA SDN BHD – Type Safe
ROXUL INC – Type Safe
THERMAFIBER INC – Type SAF
 - B. **Fill, Void or Cavity Material*** – Min 1/2 in. thickness of fill material applied within the joint, flush with top surface of floor.
3M COMPANY – FB 1003 SL

*Bearing the UL Classification Mark

Reprinted from the Online Certifications Directory with permission from UL
© 2013 UL LLC



Construction Joints

Floor to Wall

FWD

UL System No. FW-D-1040

January 17, 2017

ANSI/UL2079

Assembly Rating – 3 Hr
 Nominal Joint Width – 4 in.
 Class II Movement Capabilities – 19% or 10% Compression
 or Extension (See Item 2)
 L Rating at Ambient – Less than 1 CFM/Lin Ft
 L Rating at 400°F – Less than 1 CFM/Lin Ft

CAN/ULC S115

F Rating – 3 Hr
 FT Rating – 3 Hr
 FH Rating – 3 Hr
 FTH Rating – 3 Hr
 Nominal Joint Width – 102 mm
 Class II Movement Capabilities – 19% or 10% Compression
 or Extension (See Item 2)
 L Rating at Ambient – Less than 1.55 L/s/lin m
 L Rating at 400°F – Less than 1.55 L/s/lin m

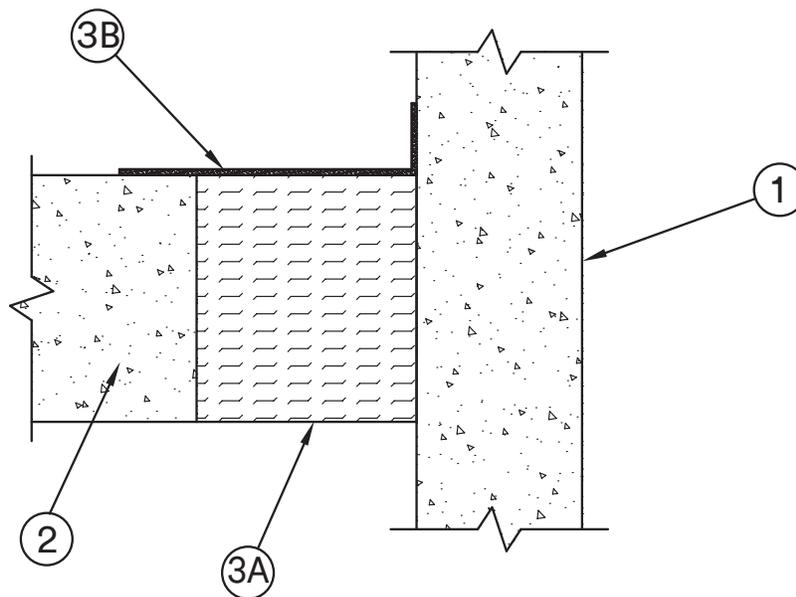

1. **Wall Assembly** – Min 6 in. (152 mm) thick reinforced lightweight or normal weight (100-150 pcf or 1600-2400 kg/m³) structural concrete. Wall may also be constructed of any UL Classified **Concrete Blocks***.
 See **Concrete Blocks** (CAZT) category in the Fire Resistance Directory for names of manufacturers.
2. **Floor Assembly** – Min 6 in. (152 mm) thick steel-reinforced lightweight or normal weight (100-150 pcf or 1600-2400 kg/m³) structural concrete.
3. **Joint System** – Max width of joint (at time of installation of joint system) is 4 in. (102 mm). The joint system is designed to accommodate a max 19 percent compression or extension from its installed width, except that when the **Fire Barrier Watertight Spray** (see Item 2B) is used, the movement is limited to max 10 percent compression and extension. The joint system shall consist of the following:
 - A. **Forming Material*** – Min 4 pcf (64 kg/m³) mineral wool batt insulation installed in joint opening as a permanent form. Batt cut to min width of 6 in. (152 mm) and installed edge-first into joint opening, parallel with joint direction, such that batt sections are compressed min 50 percent in thickness and such that the compressed batt sections are flush with the top surface of floor. Adjoining lengths of batt to be tightly-butted with butted seams spaced min 36 in. (914 mm) apart along the length of the joint.
 INDUSTRIAL INSULATION GROUP LLC – MinWool-1200 Safing
 ROCK WOOL MANUFACTURING CO – Delta Board
 ROCKWOOL MALAYSIA SDN BHD – Type Safe
 ROXUL INC – Type Safe
 THERMAFIBER INC – Type SAF
 - B. **Fill, Void or Cavity Material*** – Min 1/16 in. (1.6 mm) dry thickness (min 1/8 in. or 3.2 mm wet thickness) of fill material sprayed or brushed on top surface of floor to completely cover mineral wool and overlap a min of 1/2 in. (13 mm) onto concrete floor and wall. When 3M Fire Barrier Watertight Spray is used, min wet (and dry) thickness of spray is 1/10 in. (2.5 mm).
 3M COMPANY – FireDam™ Spray 200, 3M Fire Barrier Watertight Spray
 - B1. **Fill, Void or Cavity Material* – Tape** – As an alternate to Item 3B, Tape cut to size and press applied to top surface of floor to completely cover mineral wool and overlap a min of 1 in. (25 mm) onto the concrete floor and wall. Tape shall be applied in minimum 1 ft (305 mm) lengths along the joint at top of floor and adjoining lengths of Tape shall overlap min 1/2 in. (13 mm).
 3M COMPANY – 3M Fire and Water Barrier Tape

*Indicates such products shall bear the UL or cUL Certification Mark for jurisdictions employing the UL or cUL Certification (such as Canada), respectively. 

Reprinted from the Online Certifications Directory with permission from UL©

Construction Joints

Floor to Wall

FWD

System No. FW-D-1070

January 11, 2013

Assembly Rating – 2 Hr

L Rating At Ambient – Less Than 1 CFM/Lin Ft

L Rating At 400 F – Less Than 1 CFM/Lin Ft

Nominal Joint Width – 4 In.

Class II Movement Capabilities – 15.6% Compression or Extension

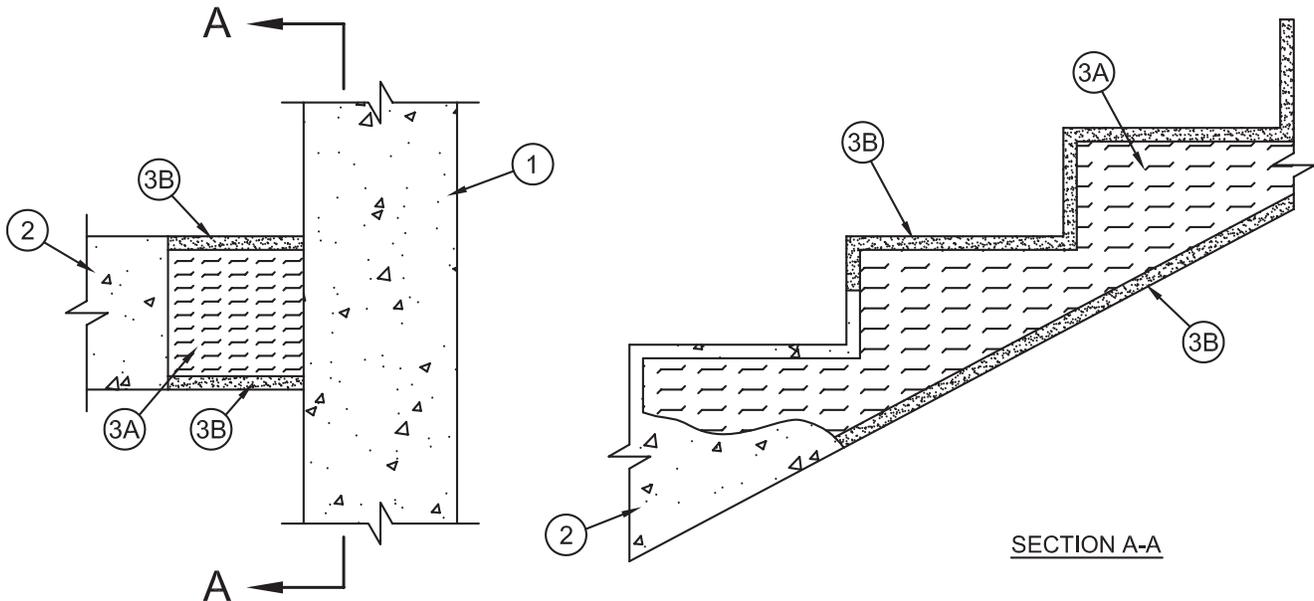

- Wall Assembly** – Min 4-1/2 in. (114 mm) thick reinforced lightweight or normal weight (100-150 pcf or 1600-2400 kg/m³) structural concrete. Wall may also be constructed of any UL Classified **Concrete Blocks***.
See **Concrete Blocks (CAZT)** category in the Fire Resistance Directory for names of manufacturers.
- Stair Assembly** – Min 4-1/2 in. (114 mm) thick reinforced lightweight or normal weight (100-150 pcf or 1600-2400 kg/m³) structural concrete.
- Joint System** – Max width of joint (at time of installation of joint system) is 4 in. (102 mm). The joint system is designed to accommodate a max 15.6 percent compression or extension from its installed width. The joint system shall consist of the following:
 - Forming Material*** – Min 4.0 pcf (64 kg/m³) mineral wool batt insulation installed in joint opening as a permanent form. Batt cut to min width of 3-1/2 in. (89 mm) and installed edge-first into joint opening, parallel with joint direction, such that batt sections are compressed min 50 percent in thickness and such that the compressed batt sections are recessed from the top and bottom surfaces of stair assembly to accommodate the required thickness of fill material. Adjoining lengths of batt to be tightly-butted with butted seams spaced min 48 in. (1219 mm) apart along the length of the joint.
ROCK WOOL MANUFACTURING CO – Delta Safing Board
ROXUL INC – Type Safe
THERMAFIBER INC – Type SAF
 - Fill, Void or Cavity Material*** – Min 1/2 in. (13 mm) thickness of fill material applied within the joint, flush with top and bottom surfaces of stair assembly.
3M COMPANY
3M FIRE PROTECTION PRODUCTS – FB 1000 NS

*Bearing the UL Classification Mark

Reprinted from the Online Certifications Directory with permission from UL
© 2013 UL LLC



Construction Joints

Floor to Wall

FWD

System No. FW-S-0001

September 08, 2004
 Assembly Rating – 1 Hr
 Joint Width – 1-1/2 In. Max

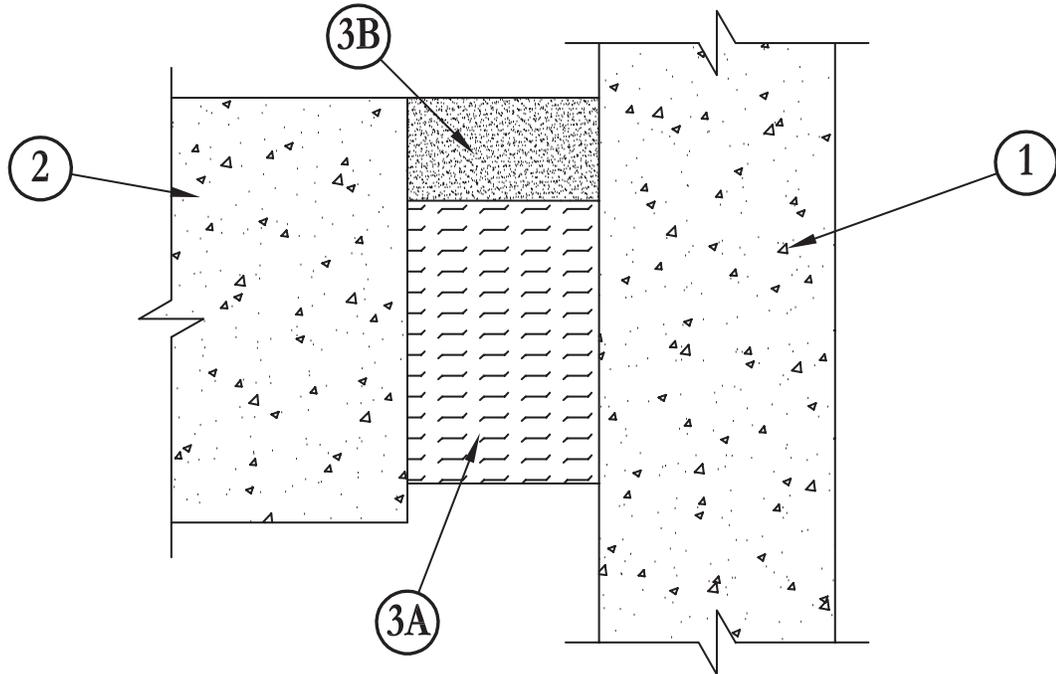

1. **Wall Assembly** – Min 4-1/2 in. thick reinforced lightweight or normal weight (100-150 pcf) structural concrete. Wall may also be constructed of any UL Classified **Concrete Blocks***.
 See **Concrete Blocks (CAZT)** category in the Fire Resistance Directory for names of manufacturers.
2. **Floor Assembly** – Min 4-1/2 in. thick steel-reinforced lightweight or normal weight (100-150 pcf) structural concrete.
3. **Joint System** – Max separation between edge of floor and face of wall is 1-1/2 in. The joint system shall consist of the following:
 - A. **Packing Material** – Min 1 in. thickness of tightly-packed ceramic (alumina-silica) fiber blanket or min 4.0 pcf mineral wool batt insulation firmly packed into opening as a permanent form. Packing material to be recessed from each surface of wall to accommodate the required thickness of fill material.
 - B. **Fill, Void or Cavity Material*** – **Caulk or Sealant** – Min 1 in. thickness of fill material applied within the joint, flush with top surface of floor.
3M COMPANY – CP 25WB+ caulk or FB-3000 WT sealant

*Bearing the UL Classification Marking

Reprinted from the Online Certifications Directory with permission from Underwriters Laboratories Inc.
 Copyright © 2010 Underwriters Laboratories Inc.®



3M Firestop Systems

Construction Joints

Head of Wall

HWD

Head of Wall Dynamic

HWS

Head of Wall Static

Quick Reference Guide

Head-of-Wall

| 3M UL Systems | "F" Rating | 3M Product | Through Penetrant Details |
|---------------|------------|---|---|
| HW-D-0020 | 1, 2 | 3M™ FireDam™ Spray 200 | D700 or D900 concrete over fluted metal deck or fluted roof assembly. U400, V400 or W400 Series gypsum wall. Max 1 in. joint. 25% compression/extension. 1 & 2 hour F rating. Also known as HWD0020. |
| HW-D-0021 | 1, 2 | 3M™ FireDam™ Spray 200 3M™ Fire and Water Barrier Tape | Min 4-1/2 in. concrete floor. U400 or V400 Series gypsum wall. 1 in. wide joint. 19% compression/extension. 1 & 2 hour F rating. Also known as HWD0021. |
| HW-D-0022 | 2 | 3M™ FireDam™ Spray 200 | Min 2-1/2 in. concrete over fluted metal deck or P700/P900 series roof deck. SFRM. Min 6 -1/2 in. concrete wall. Max 1 in. wide joint. 19% compression/extension. 2 hour F rating. Also known as HWD0022. |
| HW-D-0023 | 2 | 3M™ FireDam™ Spray 200 3M™ Fire and Water Barrier Tape | Min 4-1/2 concrete floor. Min 6-1/2 in. concrete wall. Max 1 in. wide joint. 19% compression/extension, 2 hour F rating. Also known as HWD0023. |
| HW-D-0029 | 1, 2 | 3M™ FireDam™ Spray 200 | Min 2-1/2 in. concrete over fluted metal deck with SFRM or fluted steel roof deck assembly. Gypsum wall. Slip track. Max 1 in. joint. 25% compression /extension. 1 & 2 hour F rating. Also known as HWD0029. |
| HW-D-0030 | 2 | 3M™ FireDam™ Spray 200 | Min 2-1/2 in. concrete over fluted metal deck or P700/P900 fluted metal roof. SFRM. Min 6-1/6 in. concrete wall parallel to flutes. Max 1 in. joint. 19% ompression/extension. 2 hour F rating. Also known as HWD0030. |
| HW-D-0031 | 1, 2 | 3M™ FireDam™ Spray 200 | Min 2-1/2 in. concrete over fluted metal deck with optional SFRM or P900 series fluted metal roof deck. U400/V400 gypsum wall. Max 2 in. joint. 25% compression/extension. 2 hour F rating. Also known as HWD0031. |
| HW-D-0038 | 2 | 3M™ FireDam™ Spray 200 3M™ Fire and Water Barrier Tape | Min 4-1/2 in. concrete floor. Min 7-1/2 in. concrete wall. Max 2 in. joint. 19% compression/extension. 2 hour F rating. Also known as HWD0038. |
| HW-D-0040 | 2 | 3M™ FireDam™ Spray 200 | Min 2-1/2 in. concrete over fluted metal deck with optional SFRM. Min 7-1/2 in. concrete wall. Max 2 in. joint. 19% compression/extension. 2 hour F rating. Also known as HWD0040. |
| HW-D-0060 | 1, 2, 3 | 3M™ Fire Barrier Sealant FD 150+ 3M™ Fire Barrier Sealant CP 25WB+ 3M™ Fire Barrier Water Tight Sealant 1000 NS | Min 2-1/2 in. concrete over fluted metal deck or min 4-1/2 in. concrete floor or P770/P800/P900 fluted roof. U400 or V400 series gypsum wall. Fire Trak deflection trak. Wall cladding attached to furring strips. Max 1 in. joint. 100% compression/extension. 1,2 & 3 hour F rating. Also known as HWD0060. |
| HW-D-0061 | 1, 2, 3 | 3M™ Fire Barrier Sealant FD 150+ 3M™ Fire Barrier Sealant CP 25WB+ 3M™ Fire Barrier Water Tight Sealant 1000 NS | Min 2-1/2 in. concrete over fluted metal deck or min 4-1/2 in. concrete floor or P770/P800/P900 fluted roof. U400 or V400 series gypsum wall. Fire Trak deflection trak. Wall cladding attached to furring strips. Max 1 in. joint. 100% compression/extension. 1,2,3 hour F rating. Also known as HWD0061. |
| HW-D-0075 | 4 | 3M™ Fire Barrier Silicone Sealant 2000+ | 2" joint, 10.9% compression/extension, concrete/concrete. Also referred as HWD0075. |
| HW-D-0101 | 1, 2 | 3M™ FireDam™ Spray 200 3M™ Fire and Water Barrier Tape | Min 2-1/2 in. concrete over fluted metal deck. U400/V400 series gypsum wall. Max 1 in. joint. 25% compression/extension. 1 & 2 hour F rating. Also known as HWD0101. |
| HW-D-0111 | 1, 2 | 3M™ Fire Barrier Sealant FD 150+ | 3/4" wide, 17% compress/extension, concrete steel deck/gypsum. 1 & 2 hr assembly ratings. Also known as HWD0111. |
| HW-D-0118 | 1, 2 | 3M™ FireDam™ Spray 200 3M™ Fire and Water Barrier Tape | Min 2-1/2 in. concrete over fluted metal deck or P9000 fluted metal roof or minimum 4-1/2 in. concrete floor. U400/V400 series gypsum wall. Max 1 in. joint. Fire Trak deflection track. Wall cladding. Flutes firestopped per UL system HW-D-0020 or HW-D-0028. 1 & 2 hour F. 100% compression/extension. Also known as HWD0118. |
| HW-D-0119 | 1, 2, 3 | 3M™ Fire Barrier Sealant FD 150+ 3M™ Fire Barrier Sealant CP 25WB+ 3M™ Fire Barrier Water Tight Sealant 1000 NS 3M™ Fire Barrier Silicone Sealant 2000 NS 3M™ Fire Barrier Silicone Sealant 2000+ | Min 2-1/2 in. concrete over fluted metal deck or P900 fluted metal roof or minimum 4-1/2 in. concrete floor. U400/V400/W400 series gypsum shaft wall. Max 1 in. joint. Fire Trak deflection track. Wall cladding. 1, 2, 3 hour F. 100% compression/extension. Also known as HWD0119. |
| HW-D-0120 | 1, 2, 3 | 3M™ Fire Barrier Sealant FD 150+ 3M™ Fire Barrier Sealant CP 25WB+ 3M™ Fire Barrier Water Tight Sealant 1000 NS 3M™ Fire Barrier Silicone Sealant 2000 NS 3M™ Fire Barrier Silicone Sealant 2000+ | Min 2-1/2 in. concrete over fluted metal deck or P900 fluted metal roof or minimum 4-1/2 in. concrete floor. U400/V400/W400 series gypsum wall. Max 1 in. joint. Fire Trak deflection track. Wall cladding. 1, 2, 3 hour F. 100% compression/extension. Also known as HWD0120. |

Quick Reference Guide

Head-of-Wall

| 3M UL Systems | "F" Rating | 3M Product | Through Penetrant Details |
|---------------|------------|---|---|
| HW-D-0122 | 4 | 3M™ FireDam™ Spray 200 | Min 2-1/2 in. concrete over fluted metal deck with SFRM. U400 or V400 series gypsum wall. Max 1 in. joint. 25% compression/extension. 4 hour F rating. Also known as HWD0122. |
| HW-D-0123 | 3, 4 | 3M™ FireDam™ Spray 200 | Min 2-1/2 in. concrete over fluted metal deck with SFRM. Min 6-1/2 in. concrete wall. Max 1 in. joint. 25% compression/extension. 3 & 4 hour F rating. Also known as HWD0123. |
| HW-D-0134 | 1, 2 | 3M™ Fire Barrier Sealant FD 150+ | 3/4" wide, 17% compression/extension, concrete/gypsum. 1 & 2 hr assembly ratings. Also known as HWD0134. |
| HW-D-0168 | 1, 2 | 3M™ Fire Barrier Water Tight Sealant 1000 NS | 1" wide, 25% compress/extension, concrete steel deck/gypsum. Also referred as HWD0168. |
| HW-D-0169 | 2 | 3M™ Fire Barrier Sealant FD 150+ | 3/4" wide, 16.6% compress/extension, concrete/concrete. Also referred as HWD0169. |
| HW-D-0170 | 1, 2 | 3M™ Fire Barrier Water Tight Sealant 1000 NS | 1" wide, 25% compress/extension, concrete/gypsum. Also referred as HWD0170. |
| HW-D-0171 | 2 | 3M™ Fire Barrier Water Tight Sealant 1000 NS | 1" wide, 25% compress/extension, concrete steel deck or roof/gypsum. Also referred as HWD0171. |
| HW-D-0172 | 2 | 3M™ Fire Barrier Water Tight Sealant 1000 NS | 1" wide, 25% compress/extension, concrete/concrete. Also referred as HWD0172. |
| HW-D-0173 | 1, 2 | 3M™ Fire Barrier Water Tight Sealant 1000 NS | 1" wide, 25% compress/extension, concrete steel deck or roof/gypsum. Also referred as HWD0173. |
| HW-D-0174 | 2 | 3M™ Fire Barrier Water Tight Sealant 1000 NS | 1" wide, 25% compress/extension, concrete steel deck or roof/concrete. Also referred as HWD0174. |
| HW-D-0178 | 1, 2 | 3M™ Fire Barrier Sealant FD 150+ | 1" wide, 18.75% compress/extension, concrete steel deck/gypsum. Also referred as HWD0178. |
| HW-D-0192 | 1, 2 | 3M™ FireDam™ Spray 200 | Min 2-1/2 in. concrete over fluted metal deck with SFRM. U400/V400/W400 series gypsum wall. Optional structural steel support perpendicular to wall. 13 % compression/extension. Nominal 2 in. joint width. 1 & 2 hour F rating. Also known as HWD0192. |
| HW-D-0204 | 2 | 3M™ Fire Barrier Sealant FD 150+ | 1" wide, 18.75% compress/extension, concrete steel deck or roof/concrete. Also referred as HWD0204. |
| HW-D-0205 | 1, 2 | 3M™ Fire Barrier Sealant FD 150+ | Gypsum Wall to Fluted Steel Deck (Parallel to flutes), Movement - 19% Compression or Extension. Nominal 1 in. joint width. . Also known as HWD0205. |
| HW-D-0206 | 2 | 3M™ Fire Barrier Sealant FD 150+ | 1" wide, 18.75% compress/extension, concrete steel deck or roof/concrete. Also referred as HWD0206. |
| HW-D-0248 | 2 | 3M™ FireDam™ Spray 200 | Min 2-1/2 in. concrete over fluted metal deck with SFRM. Min 6-1/2 in. concrete wall. Optional structural steel support perpendicular to wall. 13 % compression/extension. Nominal 1 in. joint width. 2 hour F rating. Also known as HWD0248. |
| HW-D-0265 | 2 | 3M™ FireDam™ Spray 200 3M™ Fire and Water Barrier Tape | Min 4-1/2 in. concrete floor or min 6 in. hollow core floor. U400/V400 series gypsum wall. Max 2 in. joint. 25% compression/extension. 2 hour F rating. Also known as HWD0265. |
| HW-D-0376 | 1, 2 | 3M™ FireDam™ Spray 200 3M™ Fire and Water Barrier Tape | Min 2-1/2 concrete over fluted deck. U400/V400 gypsum wall. 1 in. joint, 1-1/2 in. EMT, 1-1/2 in. sched 5 steel, Max 3C with ground No. 12 AWG MC cable, 1-1/2 in. PVC (closed), 1-1/2 in. CPVC (closed), 1-1/2 in. PVC conduit. Annular space between penetrants and steel deck or top of ceiling runner min 1/2 in..1 & 2 hr F. 13% compression/extension. Also known as HWD0376. |
| HW-D-0379 | 2 | 3M™ FireDam™ Spray 200 3M™ Fire and Water Barrier Tape | Min 2-1/2 in. concrete over fluted metal deck. Min 7-1/2 in. concrete wall. Installation from one side only. Max joint 2 in. 13% compression/extension. 2 hour rating. Also known as HWD0379. |
| HW-D-0384 | 1, 2, 3, 4 | 3M™ FireDam™ Spray 200 | Min 2-1/2 in. concrete over fluted metal deck or P700 or P900 roof assembly. U400 or V400 series gypsum walls. I-beam with SFRM parallel to one side of wall min 2 in. to max 6 in. from wall. Metal deck must have SFRM. Nominal 2 in. joint. Class II movement +/- 50%. 1, 2, 3 and 4 hour F ratings. Also known as HWD0384 |
| HW-D-0385 | 2, 3, 4 | 3M™ FireDam™ Spray 200 | Min 2-1/2 in. concrete over fluted metal deck or P700 or P900 roof assembly. Min 6 in. concrete wall or concrete block wall. I-beam with SFRM parallel to one side of wall min 2 in. to max 6 in. from wall. Metal deck must have SFRM. Nominal 2 in. joint. Class II movement +/- 50%. 2, 3 and 4 hour F ratings. Also known as HWD0385. |

Quick Reference Guide

Head-of-Wall

| 3M UL Systems | "F" Rating | 3M Product | Through Penetrant Details |
|---------------|------------|---|---|
| HW-D-0441 | 2, 3 | 3M™ Fire Barrier Sealant FD 150+ | Nominal 2 in. joint. Concrete floor to concrete block wall. 3 hour assembly rating. Movement-13% compression/extension. Mineral wool compressed 50%. Also known as HWD0441. |
| HW-D-0447 | 2 | 3M™ FireDam™ Spray 200 3M™ Fire and Water Barrier Tape | Min 2-1/2 in. concrete over fluted metal deck. Gypsum wall. Nominal 2 in. joint width. Steel straps span valleys of deck. Flutes parallel to wall. Optional deflection channel. Optional isolation pads. 2 hour F rating. 25% compression/extension. Also known as HWD0447. |
| HW-D-0465 | 1, 2, 3, 4 | 3M™ FireDam™ Spray 200 | Min 2-1/2 in. concrete over fluted metal deck. SFRM required. U400/V400 gypsum wall or min 6 in. concrete wall. Nominal 1 in. joint. Structural steel support with SFRM (required) centered over and parallel with wall assembly. 1, 2, 3, 4 hour F Rating. Class II Movement 50% compression/extension. Also known as HWD0465. |
| HW-D-0478 | 2 | 3M™ FireDam™ Spray 200 3M™ Fire and Water Barrier Tape | Min 2-1/2 in. concrete over fluted metal deck. U400 or V400 gypsum wall. Nominal 2 in. joint. Joint parallel to with offset flutes. 25% compression/extension. 2 hour F rating. Also known as HWD0478. |
| HW-D-0479 | 2 | 3M™ FireDam™ Spray 200 3M™ Fire and Water Barrier Tape | Min 2-1/2 in. concrete over fluted metal deck. Min 6-1/8 in. concrete wall. Nominal 2 in. joint. Joint parallel to with offset flutes. 25% compression/extension. 2 hour F rating. Also known as HWD0479. |
| HW-D-0488 | 1 | 3M™ Fire Barrier Sealant CP 25WB+ | P200 or P500 insulated metal roof-ceiling design. U400 or V400 series gypsum wall. Nominal 2 in. joint. +/-100% movement. 1 hour F rating. Deflection channel parallel to purlin web and attached to purlin bottom flange. No additional mineral wool required. Also known as HWD0488. |
| HW-D-0489 | 1 | 3M™ Fire Barrier Sealant CP 25WB+ | P200 or P500 insulated metal roof-ceiling design. U400 or V400 series gypsum wall. Nominal 2 in. joint. +/-100% movement. 1 hour F rating. Deflection channel perpendicular to purlin and attached to purlin bottom flange. No additional mineral wool required. Also known as HWD0489. |
| HW-D-0490 | 1 | 3M™ Fire Barrier Sealant CP 25WB+ | P200 or P500 insulated metal roof-ceiling design. U400 or V400 series gypsum wall with C-H steel studs. Nominal 2 in. joint. +/-100% movement. 1 hour F rating. Deflection channel parallel with / between purlins and attached to lateral bracing. No additional mineral wool required. Also known as HWD0490. |
| HW-D-0517 | 1, 2 | 3M™ Fire Barrier Sealant FD 150+ | Gypsum Wall to concrete floor. Nominal 3/4 in. joint. Class II movement 34% compression only. 1 & 2 hour F rating. No backing material required. Sealant only. Also known as HWD0517. |
| HW-D-0552 | 2 | 3M™ FireDam™ Spray 200 3M™ Fire and Water Barrier Tape | Min 2-1/2 in. concrete over fluted metal deck or min 4-1/2 in. concrete. U400/V400 Series gypsum shaft wall. Flutes parallel to wall or flutes perpendicular to wall. Max 3/4 in. joint. 19% compression/extension. 2 hour F rating. Also known as HWD0552. |
| HW-D-0574 | 2, 3, 4 | 3M™ Fire Barrier Sealant FD 150+ | Min 4-1/2 in. concrete floor to concrete block wall. Max 1 in. joint. 12.5% compression extension. 2, 3, & 4 hour F rating. Backer rod and sealant. Also known as HWD0574. |
| HW-D-0575 | 2 | 3M™ FireDam™ Spray 200 3M™ Fire and Water Barrier Tape | Min 2-1/2 in. concrete over fluted metal deck. Min 7-1/2 in. concrete wall or concrete block wall. Max 2 in. joint. Optional minimum 5 in. x 3 in. steel angles with 3 in. leg secured to ceiling. Class II Movement +/- 13%. Spray can be installed over optional angles. 2 hour F rating. Also known as HWD0575. |
| HW-D-0604 | 1, 2, 3, 4 | 3M™ FireDam™ Spray 200 3M™ Fire and Water Barrier Tape | Min 4-1/2 in. concrete or minimum 2 in. concrete over fluted metal deck to U400 or V400 series gypsum walls. Nominal 2 in. joint. 50% compression/extension. 1, 2, 3 & 4 hour F rating. Also known as HWD0604. |
| HW-D-0633 | 1, 2 | 3M™ Fire and Water Barrier Tape 3M™ FireDam™ Spray 200 | Max. 1 in. head of wall joint between a U400, V400, or W400 series wall assembly and a concrete floor over fluted metal deck. Wall runs perpendicular to flutes. |
| HW-D-0706 | 3, 4 | 3M™ Fire Barrier Sealant CP 25WB+ | Max 3 in. deep fluted steel deck/min 2-1/2 in. concrete floor. Min 1 in. thick mineral fiber board wall. Max 1 in. joint. 50% compression/extension. 3 hour F and T. Also known as HWD0706 |
| HW-D-0746 | 2 | 3M™ Fire Barrier Sealant FD 150+ | Also known as HWD0746. |
| HW-D-0755 | 2, 3, 4 | 3M™ FireDam™ Spray 200 | Max 2" joint between concrete floor, fluted metal deck, fluted metal roof and concrete or concrete block wall assembly. |

Quick Reference Guide

Head-of-Wall

| 3M UL Systems | "F" Rating | 3M Product | Through Penetrant Details |
|---------------|------------|---|---|
| HW-D-0827 | 2 | 3M™ FireDam 150+ | Min 4-1/2 in. concrete floor. Min 5-1/4 in. concrete wall. Installation from one side only. Max joint 2 in. 13% compression/extension. 2 hour rating. |
| HW-D-1002 | 2, 3 | 3M™ Fire Barrier Water Tight Sealant 1000 NS 3M™ Fire Barrier Water Tight Sealant 1003 SL | 4" wide, 31% compress, concrete/concrete. Also referred as HWD1002. |
| HW-D-1003 | 2 | 3M™ Fire Barrier Water Tight Sealant 1000 NS | 4" wide, 25% compress, concrete/concrete. Also referred as HWD1003. |
| HW-D-1007 | 2, 3 | 3M™ Fire Barrier Silicone Sealant 2000+ | 4" wide, 12.5% compress, concrete/concrete. Also referred as HWD1007. |
| HW-D-1010 | 2 | 3M™ FireDam™ Spray 200 3M™ Fire and Water Barrier Tape | Min 4-1/2 in. concrete floor. Min 7-1/2 in. concrete wall. Max 4 in. joint. 19% compression/extension. 2 hour F rating. Also known as HWD1010. |
| HW-D-1011 | 1, 2, 3 | 3M™ Fire Barrier Sealant FD 150+ 3M™ Fire Barrier Sealant CP 25WB+ 3M™ Fire Barrier Water Tight Sealant 1000 NS 3M™ Fire Barrier Silicone Sealant 2000 NS 3M™ Fire Barrier Silicone Sealant 2000+ | Min 2-1/2 in. concrete over fluted metal deck or min 4-1/2 in. concrete or P700/P800/P900 fluted roof. U400 or V400 Series gypsum wall. Fire Trak deflection trak. Wall cladding attached to furring strips. Max 3 in. joint. 100% compression/extension. 1,2,3 hour F rating. Also known as HWD1011. |
| HW-D-1012 | 1, 2, 3 | 3M™ Fire Barrier Sealant FD 150+ 3M™ Fire Barrier Sealant CP 25WB+ 3M™ Fire Barrier Water Tight Sealant 1000 NS 3M™ Fire Barrier Silicone Sealant 2000 NS 3M™ Fire Barrier Silicone Sealant 2000+ | Min 2-1/2 in. concrete over fluted metal deck or min 4-1/2 in. concrete or P700/P800/P900 fluted roof. U400 or V400 Series gypsum wall. Fire Trak deflection trak. Wall cladding attached to furring strips. Max 3 in. joint. 100% compression/extension. 1,2,3 hour F rating. Also known as HWD1012. |
| HW-D-1015 | 2 | 3M™ Fire Barrier Water Tight Sealant 1000 NS | Min 4-1/2 in concrete floor. Min 5 in. concrete wall. Max 4 in. joint. 15.6% compression/extension. 2 hour F rating. Also known as HWD1015. |
| HW-D-1020 | 1, 2 | 3M™ FireDam™ Spray 200 3M™ Fire and Water Barrier Tape | Min 2-1/2 in. concrete over fluted metal deck or P900 fluted metal roof or minimum 4-1/2 in. concrete floor. U400/V400 series gypsum wall. Max 3 in. joint. Fire Trak deflection track. Wall cladding. Flutes firestopped per UL system HW-D-0020 or HW-D-0028. 1 & 2 hour F. 100% compression/extension. Also known as HWD1020. |
| HW-D-1059 | 1, 2 | 3M™ FireDam™ Spray 200 3M™ Fire and Water Barrier Tape | Min 2-1/2 in. concrete over fluted metal deck. U400 or V400 Series gypsum wall. Max 4 in. joint. Max 3 in. flutes. Wall parallel to flutes. 1 & 2 Hour rating. Class II Movement with 25%+/- compression/extension. 8 pcf mineral wool. Also known as HWD1059 |
| HW-D-1079 | 2 | 3M™ FireDam™ Spray 200 3M™ Fire and Water Barrier Tape | Min 4-1/2 in. concrete floor to minimum 7-1/2 in. concrete wall or concrete block wall. Max 4 in. joint. Class II movement +/- 19%. Optional minimum 5 in. x 3 in. steel angles with 3 in. leg secured to ceiling. Class II Movement +/- 13%. Spray can be installed over optional angles. 2 hour F rating. Also known as HWD1079. |
| HW-D-1080 | 2 | 3M™ FireDam™ Spray 200 3M™ Fire and Water Barrier Tape | Min 4-1/2 in. concrete floor to minimum 7-1/2 in. concrete wall or concrete block wall. Wall perpendicular to floor. Max 4 in. joint. Class II movement +/- 19%. Optional minimum 5 in. x 3 in. steel angles with 3 in. leg secured to ceiling. Class II Movement +/- 13%. Spray can be installed over optional angles. 2 hour F rating. Also known as HWD1080. |
| HW-D-1123 | 2 | 3M™ FireDam™ Spray 200 3M™ Fire and Water Barrier Tape | 4 inch head of wall joint between a concret wall and a concrete floor over fluted steel deck. FireDam Spray 200 or Fire and Water Barrier Tape application. |
| HW-D-1126 | 2 | 3M™ FireDam™ Spray 200 | 4 in. head of wall joint between concrete floor and concrete wall. Single side access |
| HW-S-0002 | 1, 2 | 3M™ Fire Barrier Silicone Sealant 2000+ | 1" wide, concrete steel deck/gypsum. Also referred as HWS0002. |
| HW-S-0003 | 1, 2 | 3M™ Fire Barrier Sealant CP 25WB+ 3M™ Fire Barrier Water Tight Sealant 3000 WT | 1" wide, concrete steel deck/gypsum. Also referred as HWS0003. |
| HW-S-0004 | 1, 2 | 3M™ Fire Barrier Sealant CP 25WB+ 3M™ Fire Barrier Water Tight Sealant 3000 WT | 1" wide, concrete steel deck/gypsum. Also referred as HWS0004. |
| HW-S-0005 | 1, 2 | 3M™ Fire Barrier Silicone Sealant 2000+ | 1" wide, concrete/gypsum. Also referred as HWS0005. |
| HW-S-0007 | 2 | 3M™ Fire Barrier Silicone Sealant 2000+ | 1" wide, concrete steel deck/concrete. Also referred as HWS0007. |
| HW-S-0028 | 1, 2 | 3M™ Fire Barrier Water Tight Sealant 1000 NS | Min 2-1/2 in. concrete over fluted metal deck. U400 Series gypsum wall. Max 1 in. joint. 1 & 2 hour F rating. Also known as HWS0028. |

Quick Reference Guide

Head-of-Wall

| 3M UL Systems | "F" Rating | 3M Product | Through Penetrant Details |
|---------------|------------|---|---|
| HW-S-0029 | 2 | 3M™ Fire Barrier Water Tight Sealant 1000 NS | Min 2-1/2 in. concrete over fluted metal deck. Min 4-1/2 in. concrete wall. Max 1 in. joint. 2 hour F rating. Also known as HWS0029. |
| HW-S-0030 | 1, 2 | 3M™ Fire Barrier Sealant CP 25WB+ 3M™ Fire Barrier Water Tight Sealant 3000 WT | 3/4" wide, concrete steel deck/gypsum. Also referred as HWS0030. |
| HW-S-0040 | 1, 2 | 3M™ Fire Barrier Water Tight Sealant 1000 NS | 1" wide, concrete steel deck/gypsum. Also referred as HWS0040. |
| HW-S-0041 | 1, 2 | 3M™ Fire Barrier Water Tight Sealant 1000 NS | 1" wide, concrete/gypsum. Also referred as HWS0041. |
| HW-S-0042 | 2 | 3M™ Fire Barrier Water Tight Sealant 1000 NS | Fluted metal deck to min 5-1/2 in. concrete wall or concrete block wall. Wall perpendicular to flutes. Max 1 in. joint. Mineral installed at 25% compression. 2 hour F rating. Also known as HWS0042. |
| HW-S-0082 | 1 | 3M™ Fire Barrier Sealant FD 150+ | Head of Wall joint between L500 Series floor-ceiling assembly and U300 Series gypsum wallboard assembly. 1/2 in. joint. 1 Hour F Rating. Caulk only system. Also known as HWS0082 |



UL System No. HW-D-0020
XHBN - Joint Systems
XHBN7 - Joint Systems Certified for Canada

January 23, 2018

| ANSI/UL2079 | CAN/ULC S115 |
|---|--|
| Assembly Ratings – 1 and 2 Hr (See Items 2 and 3B) | F Ratings – 1 and 2 Hr (See Items 2 and 3B) |
| Nominal Joint Width – 1 In. | FT Ratings – 1 and 2 Hr (See Items 2 and 3B) |
| Class II Movement Capabilities – 25% Compression or Extension | FH Ratings – 1 and 2 Hr (See Items 2 and 3B) |
| L Rating At Ambient – Less Than 1 CFM/sq ft (See Item 3C) | FTH Rating – 0, 1/2, 3/4, 1-1/4 and 1-1/2 Hr (See Items 2 and 4) |
| L Rating At 400 F – Less Than 1 CFM/sq ft (See Item 3C) | Nominal Joint Width – 25 mm |
| | Class II Movement Capabilities – 25% Compression or Extension |
| | L Rating At Ambient – Less Than 1.55 L/s/lin m (See Item 3C) |
| | L Rating At 400 F – Less Than 1.55 L/s/lin m (See Item 3C) |

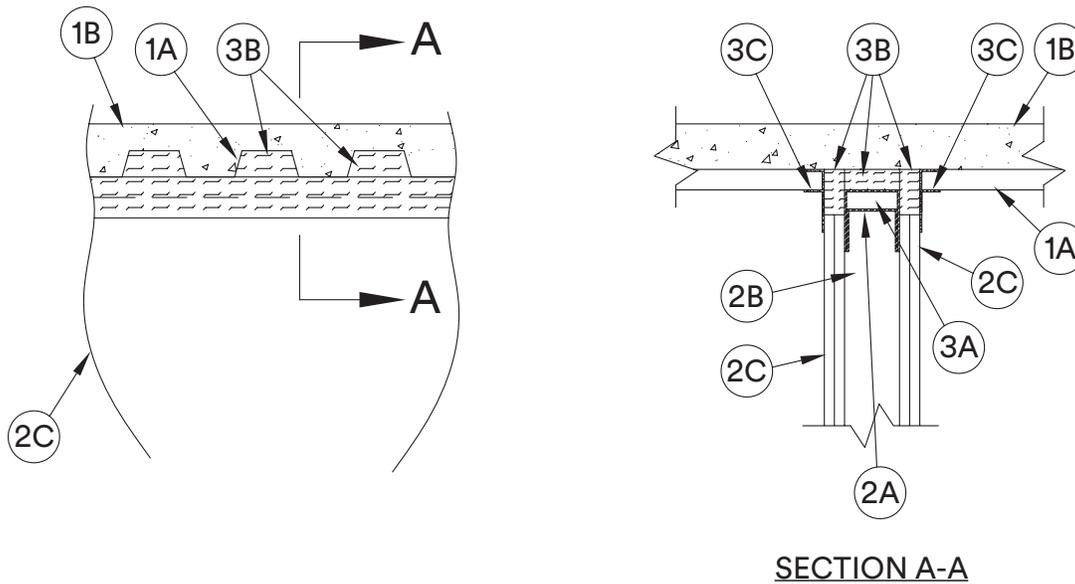

- 1. Floor Assembly** – The fire-rated fluted steel deck/concrete floor assembly shall be constructed of the materials and in the manner described in the individual D700 or D900 Series Floor-Ceiling Design in the UL Fire Resistance Directory and shall include the following construction features:
 - A. Steel Floor And Form Units*** – Max 3 in. (76 mm) deep galv steel fluted floor deck.
 - A1. Spray Applied Fire Resistive Material* – (Optional, Not Shown)** – Prior to the installation of the Deflective Channel, Forming Material and Fill, Void or Cavity Material (Items 3A, 3B, 3C), the steel floor units may be sprayed with a min 5/16 in. (8 mm) thickness to max 11/16 in. (18 mm) thickness of fire resistive material
GCP APPLIED TECHNOLOGIES INC – Type MK-6/HY
 - B. Concrete** – Min 2-1/2 in. (64 mm) thick reinforced concrete, as measured from the top plane of the floor units.
- 1A. Roof Assembly – (Not Shown)** – As an alternate to the floor assembly, a fire rated fluted steel deck roof assembly may be used. The roof assembly shall be constructed of the materials and in the manner described in the individual P900 Series Roof-Ceiling Design in the UL Fire Resistance Directory. **The hourly rating of the roof assembly shall be equal to or greater than the hourly rating of the wall assembly.** The roof assembly shall include the following construction features:
 - A. Steel Roof Deck** – Max 3 in. (76 mm) deep galv steel fluted roof deck.
 - B. Roof Insulation** – Max 2-1/4 in. (57 mm) thick poured insulating concrete, as measured from the top plane of the floor units.
- 2. Wall Assembly** – The 1 or 2 hr fire rated gypsum board/steel stud wall assembly shall be constructed of the materials and in the manner described in the individual U400, V400 or W400 Series Wall and Partition Design in the UL Fire Resistance Directory and shall include the following construction features:

A. Steel Floor And Ceiling Runners – Floor and ceiling runners of wall assembly shall consist of galv steel channels sized to accommodate steel studs (Item 2B). When optional deflection channel (Item 3A) is used, ceiling runner to be provided with 3 in. (76 mm) flanges. Ceiling runner installed within the deflection channel with 1 in. (25 mm) gap maintained between the top of ceiling runner and top of deflection channel. When deflection channel is not used, flange height of ceiling runner shall be min 3/4 in. (19 mm) greater than nom joint width. Ceiling runner is installed perpendicular to direction of fluted steel deck and secured to valleys with steel masonry anchors or by welds spaced max 24 in. (610 mm) OC. When optional spray-applied fire resistive material is used on the steel deck and when deflection channel is not used, ceiling runner secured through spray-applied material to each valley of steel deck with min 3/16 in. (5 mm) diam steel masonry anchors spaced max 12 in. (305 mm) OC.

A1. Light Gauge Framing* – Slotted Ceiling Runner – As an alternate to the ceiling runner in Item 2A, slotted ceiling runner to consist of galv steel channel with slotted flanges sized to accommodate steel studs (Item 2B). Slotted ceiling runner installed perpendicular to direction of fluted steel deck and secured to valleys with steel masonry anchors spaced max 24 in. (610 mm) OC. When slotted ceiling runner is used, deflection channel (Item 3A) shall not be used. When optional spray-applied fire resistive material is used on the steel deck, slotted ceiling runner secured through spray-applied material to each valley of steel deck with min 3/16 in. (5 mm) diam steel masonry anchors spaced max 12 in. (305 mm) OC.

BRADY CONSTRUCTION INNOVATIONS INC, DBA SLIPTRACK SYSTEMS – SLP-TRK

CALIFORNIA EXPANDED METAL PRODUCTS CO – CST

CLARKDIETRICH BUILDING SYSTEMS – Type SLT, SLT-H

CONSOLIDATED FABRICATORS CORP, BUILDING PRODUCTS DIV – SDT250, SDT300

MARINO/WARE, DIV OF WARE INDUSTRIES INC – Type SLT

METAL-LITE INC – The System

OLMAR SUPPLY INC – STT250, STT300

R & P SUPPLY – SCT250, SCT300

RAM SALES L L C – RAM Slotted Track

SCAFCO STEEL STUD MANUFACTURING CO

STEELER INC – Steeler Slotted Ceiling Runner

TELLING INDUSTRIES L L C – True-Action Deflection Track

A2. Light Gauge Framing* – Floor and Ceiling Runners – As an alternate to the ceiling and floor runners in Item 2A, 2A1 and 2A2, floor and ceiling runners to consist of galv steel channel sized to accommodate the **Light Gauge Framing* Slotted Stud** (Item 2B1) or **Light Gauge Framing* Slider C-Clip System** (Item 2B2). Floor and ceiling runners to be provided with min 1-1/4 in. and 3 in. (32 and 76 mm) flanges, respectively. Ceiling runner installed perpendicular to direction of fluted steel deck and secured to valleys with steel masonry anchors spaced max 12 in. (305 mm) OC. When ceiling runner is used, deflection channel (Item 3A) shall not be used. When optional spray-applied fire resistive material is used on the steel deck, ceiling runner is secured through spray-applied material to each valley of steel deck with min 3/16 in. (5 mm) diam steel masonry anchors spaced max 12 in. (305 mm) OC.

STEELER INC – Floor and Ceiling Runners

A3. Light Gauge Framing* – Notched Ceiling Runner – As an alternate to the ceiling runners in Items 2A through 2A3, notched ceiling runners to consist of C-shaped galv steel channel with notched return flanges sized to accommodate steel studs (Item 2B). Notched ceiling runner installed perpendicular to direction of fluted steel deck and secured to valleys with steel masonry anchors spaced max 24 in. (610 mm) OC. When notched ceiling runner is used, deflection channel (Item 3A) shall not be used. When optional spray-applied fire resistive material is used on the steel deck, notched ceiling runner secured through spray-applied material to each valley of steel deck with min 3/16 in. (5 mm) diam steel masonry anchors spaced max 12 in. (305 mm) OC.

OLMAR SUPPLY INC – Type SCR

A4. Light Gauge Framing* – Floor and Ceiling Runners – As an alternate to the ceiling and floor runners in Item 2A, through 2A4, floor and ceiling runners to consist of galv steel channel sized to accommodate the **Light Gauge Framing* Steel Studs** (Item 2B3). Floor and ceiling runners to be provided with min 1-3/4 in. flanges. Ceiling runner installed perpendicular to direction of fluted steel deck and secured to valleys with steel masonry anchors spaced max 12 in. (305 mm) OC. When ceiling runner is used, deflection channel (Item 3A) shall not be used. When optional spray-applied fire resistive material is used on the steel deck, ceiling runner is secured through spray-applied material to each valley of steel deck with min 3/16 in. (5 mm) diam steel masonry anchors spaced max 12 in. (305 mm) OC.

CALIFORNIA EXPANDED METAL PRODUCTS CO – ViperTrack™

B. Studs – Steel studs to be min 3-1/2 in. (89 mm) wide. Studs cut 1/2 to 3/4 in. (13 to 19 mm) less in length than assembly height with bottom nesting in and resting on floor runner and with top nesting in ceiling runner without attachment. When slotted ceiling runner (Item 2A1) is used, steel studs secured to slotted ceiling runner with No. 8 by 1/2 in. (13 mm) long wafer head steel screws at midheight of slot on each side of wall. Stud spacing not to exceed 24 in (610 mm) OC.

B1. Light Gauge Framing* – Slotted Studs – Slotted steel stud to be used in conjunction with **Light Gauge Framing* – Floor and Ceiling Runners** (Item 2A3). Slotted studs to be min 3-1/2 in. (89 mm) wide. Slotted steel studs cut 1 in. (25 mm) less in length than assembly height with bottom nesting in and secured to both ceiling and floor runners. Ceiling runner secured to preformed slot within steel stud by means of No. 10 by 3/4 in. (19 mm) long low profile head steel screw. Floor runner attached to bottom of steel stud by means of No. 8 by 1/2 in. (13 mm) long pan head steel screw. Slotted steel stud spacing not to exceed 24 in. (610 mm) OC.

STEELER INC – Slotted Stud

B2. Light Gauge Framing* – Slider C-Clip System – As an alternate to the **Light Gauge Framing* – Slotted Steel Studs** (Item 2B1), a Slider C-Clip System consisting of a C shaped steel clip with a slotted opening and a steel stud to be used in conjunction with **Light Gauge Framing* – Floor and Ceiling Runners** (Item 2A3). Steel clips and studs to be min 3-1/2 in. (89 mm) wide. Steel clip inserted into inside flange of steel stud without attachment. Total length of steel stud cut 1 in. (25 mm) less than assembly height with bottom of steel stud nesting in and secured to floor runner. Floor runner attached to bottom of steel stud by means of No. 8 by 1/2 in. (13 mm) long pan head steel screw. Ceiling runner secured to steel C-Clip by means of No. 10 by 3/4 in. (19 mm) long pan head steel screw located 3/8 in. (10 mm) below top of ceiling runner. Top row of gypsum board screws shall be centered within the preformed slot of the C-Clip. Steel stud and steel clips spacing not to exceed 24 in. (610 mm) OC.

STEELER INC – Slider C Clip System

B3. Light Gauge Framing* – Steel Studs – Steel Studs to be used in conjunction with **Light Gauge Framing* – Floor and Ceiling Runners** (Item 2A5). Steel studs to be min 3-5/8 in. (92 mm) wide. Studs cut 1/2 to 3/4 in. (13 to 19 mm) less in length than assembly height with bottom nesting in and resting on floor runner and with top nesting in ceiling runner without attachment. When slotted ceiling runner (Item 2A1) is used, steel studs secured to slotted ceiling runner with No. 8 by 1/2 in. (13 mm) long wafer head steel screws at midheight of slot on each side of wall. Stud spacing not to exceed 24 in (610 mm) OC.

CALIFORNIA EXPANDED METAL PRODUCTS CO – ViperStud™

C. Gypsum Board* – Gypsum board sheets installed to a min total thickness of 5/8 in. and 1-1/4 in. (16 and 32 mm) on each side of wall for 1 and 2 hr rated assemblies, respectively. Wall to be constructed as specified in the individual Wall and Partition Design in the UL Fire Resistance Directory, except that a nom 1 in. (25 mm) gap shall be maintained between the top of the gypsum board and the bottom of the steel floor or roof deck and the top row of screws shall be installed into the studs 3-1/2 in. (89 mm) below the lower surface the floor or roof deck. The hourly fire rating of the joint system is equal to the hourly fire rating of the wall.

The hourly Assembly, F, FH FT and FTH Ratings of the joint system are equal to the hourly fire rating of the wall.

3. Joint System – Max separation between bottom of floor or roof and top of wall is 1 in. (25 mm). The joint system is designed to accommodate a max 25 percent compression or extension from its installed width. The joint system consists of an optional deflection channel, forming material and a fill material, as follows:

A. Deflection Channel – (Optional) – A nom 3-5/8 in. (92 mm) wide by 3 in. (76 mm) deep min 24 ga steel U-shaped channel. Deflection channel installed perpendicular to direction of fluted steel deck and secured to valleys with steel masonry anchors or by welds spaced max 24 in. (610 mm) OC. When optional spray-applied fire resistive material is used on the steel deck, deflection channel secured through spray-applied material to each valley of steel deck with min 1-1/2 in. (38 mm) long by min 3/16 in. (5 mm) diam steel masonry anchors spaced max 12 in. (305 mm) OC. The ceiling runner (Item 2A) is installed within the deflection channel to maintain a 1 in. (25 mm) gap between the top of the ceiling runner and the top of the deflection channel. The ceiling runner is not fastened to the deflection channel.

B. Forming Material* – Min 4 in. (102 mm) thickness of min 4 pcf (64 kg/m³) density mineral wool batt insulation cut to the shape of the fluted deck, approx 20 percent larger than the area of the flutes and compressed into flutes of the steel floor or roof deck between the top of the deflection channel or ceiling runner and the steel deck. Additional pieces of min 4 pcf (64 kg/m³) mineral wool batt insulation are to be cut to the contour of the flutes with an additional 1-3/8 in. (35 mm) high section at the bottom of the shapes to fill the 1 in. (25 mm) gap between the top of the gypsum board and bottom of the steel floor or roof deck. The additional pieces of mineral wool are compressed and firmly packed into the flutes and the gap between the top of the gypsum board and bottom of the steel floor units on both sides of the wall and shall be a min 3/4 in. (19 mm) thick for 1 hr Rated Design and a min 1-1/2 in. (38 mm) thick for 2 hr Rated Design.

INDUSTRIAL INSULATION GROUP L L C – MinWool-1200 Safing

ROCK WOOL MANUFACTURING CO – Delta Board or Delta-8

ROCKWOOL MALAYSIA SDN BHD – Type Safe

ROCKWOOL – Type Safe

THERMAFIBER INC – Type SAF

B1. Forming Material* – (Optional, Not Shown) – Preformed mineral wool plugs, formed to the shape of the fluted floor units, friction fit to completely fill the flutes above the ceiling channel. The plugs shall project beyond each side of the ceiling runner and shall be recessed from both wall surfaces to accommodate the required thickness of fill material (Item 3C). Additional forming material, described in Item 3B, to be used in conjunction with the plugs to fill the gap between the top of gypsum board and bottom of steel deck.

THERMAFIBER INC – TopStop mineral wool deck plugs Type SAF batts

C. Fill, Void or Cavity Material* – Min 1/16 in. (1.6 mm) dry (1/8 in. or 3.2 mm wet) thickness of fill material sprayed or brushed on each side of the wall in the flutes of the steel floor or roof deck units and between the top of the gypsum board and the bottom of the steel floor or roof deck units to completely cover mineral wool and overlap a min of 1/2 in. (13 mm) into gypsum board and steel floor deck on both sides of wall. When the steel floor deck is coated with spray-applied material (Item A1), the fill material shall overlap min 2 in. (51 mm) onto the spray-applied material.

3M COMPANY – FireDam™ Spray 200

UL System No. HW-D-0020 (cont.)

C1. Fill, Void or Cavity Material* – Tape – As an alternate to Item C, Tape cut to size and press applied within fluted areas of joint to completely cover mineral wool lapping min 1 in. (25 mm) onto the contour of the steel floor units, or min 2 in. (51 mm) onto the spray applied fire resistive material (Item 1A1) on the steel floor units, and extending to lap min 1 in. (25 mm) onto the gypsum board. Additional pieces of Tape are applied along the joint to completely cover the remaining mineral wool between bottom of steel deck and top edge of gypsum board along length of joint, lapping min 1 in. (25 mm) onto the steel floor units, or min 2 in. (51 mm) onto the spray applied fire resistive material (Item 1A1) on the steel floor units, and min 1 in. (25 mm) onto gypsum board. Adjoining lengths of Tape shall overlap min 1/2 in. (13 mm). Tape shall be applied at both sides of wall.

3M COMPANY – 3M Fire and Water Barrier Tape

Construction Joints

Head of Wall

HWD



L Ratings apply only when FireDam™ Spray 200 is used.

*Indicates such products shall bear the UL or cUL Certification Mark for jurisdictions employing the UL or cUL Certification (such as Canada), respectively.

Reprinted from the Online Certifications Directory with permission from UL©

3M Industrial Adhesives and Tapes
Fire Protection Products
3M Center, Building 230-B-S-37
St. Paul, MN 55144-1000

UL System No. HW-D-0021

January 13, 2017

ANSI/UL2079

Assembly Ratings – 1 and 2 Hr (See Items 2 and 3A)
 Nominal Joint Width – 1 in.
 Class II Movement Capabilities – 19% Compression or Extension
 L Rating At Ambient – Less Than 1 CFM/sq ft
 L Rating At 400 F – Less Than 1 CFM/sq ft

CAN/ULC S115

F Ratings – 1 and 2 Hr (See Items 2 and 3A)
 FT Ratings – 1 and 2 Hr (See Items 2 and 3A)
 FH Ratings – 1 and 2 Hr (See Items 2 and 3A)
 FTH Ratings – 1 and 2 Hr (See Items 2 and 3A)
 Nominal Joint Width – 25 mm
 Class II Movement Capabilities – 19% Compression or Extension
 L Rating At Ambient – Less Than 1.55 L/s/lin m
 L Rating At 204°C – Less Than 1.55 L/s/lin m

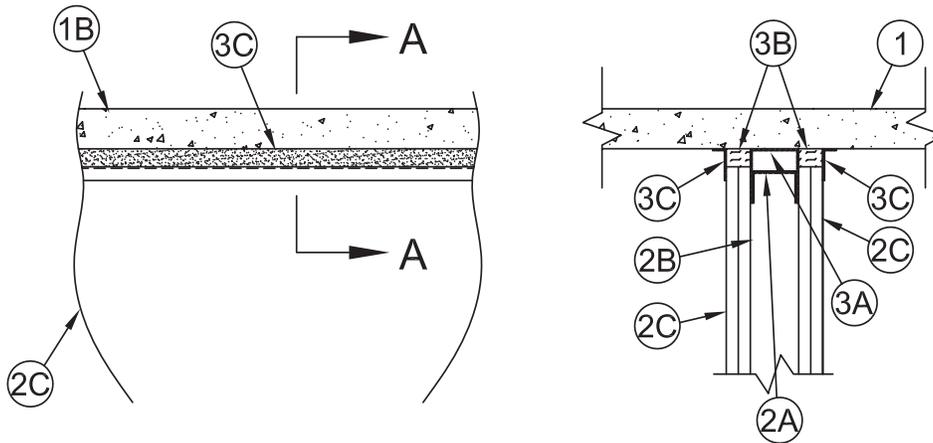

SECTION A-A

1. **Floor Assembly** — Min 4-1/2 in (114 mm) thick steel-reinforced lightweight or normal weight (100-150 pcf or 1600-2400 kg/m³) structural concrete.
2. **Wall Assembly** – The 1 or 2 hr fire rated gypsum board/steel stud wall assembly shall be constructed of the materials and in the manner described in the individual U400 or V400 Series Wall and Partition Design in the UL Fire Resistance Directory and shall include the following construction features:
 - A. **Steel Floor And Ceiling Runners** – Floor and ceiling runners of wall assembly shall consist of galv steel channels sized to accommodate steel studs (Item 2B). Ceiling runner to be provided with 3 in. (76 mm) flanges. When U-shaped deflection channel (Item 3A) is used, ceiling runner installed within the deflection channel with 1 in. (25 mm) gap maintained between the top of ceiling runner and top of deflection channel. When deflection channel is not used, ceiling runner is secured to concrete floor slab with steel masonry anchors or by welds spaced max 24 in. (610 mm) OC.
 - A1. **Light Gauge Framing* – Slotted Ceiling Runner** – As an alternate to the ceiling runner in Item 2A, slotted ceiling runner to consist of galv steel channel with slotted flanges sized to accommodate steel studs (Item 2B). Slotted ceiling runner secured to concrete floor slab with steel masonry anchors spaced max 24 in. (610 mm) OC. When slotted ceiling runner is used, deflection channel (Item 3A) shall not be used.

BRADY CONSTRUCTION INNOVATIONS INC, DBA SLIPTRACK SYSTEMS – SLP-TRK
CALIFORNIA EXPANDED METAL PRODUCTS CO – CST
CLARKDIETRICH BUILDING SYSTEMS – Type SLT, SLT-H
MARINO/WARE, DIV OF WARE INDUSTRIES INC – Type SLT
METAL-LITE INC – The System
RAM SALES LLC – RAM Slotted Track
SCAFCO STEEL STUD MANUFACTURING CO
STEELER INC – Steeler Slotted Ceiling Runner
TELLING INDUSTRIES LLC – True-Action Deflection Track
 - A2. **Light Gauge Framing – Floor and Ceiling Runners** – As an alternate to the ceiling and floor runners in Item 2A, 2A1 and 2A2, floor and ceiling runners to consist of galv steel channel sized to accommodate the **Light Gauge Framing* Slotted Stud** (Item 2B1) or **Light Gauge Framing* Slider C-Clip System** (Item 2B2). Floor and ceiling runners to be provided with min 1-1/4 in. and 3 in. (32 and 76 mm) flanges, respectively. Ceiling runner secured to concrete floor slab with steel masonry anchors spaced max 12 in. (305 mm) OC. When ceiling runner is used, deflection channel (Item 3A) shall not be used.

STEELER INC – Floor and Ceiling Runners
 - A3. **Light Gauge Framing* – Notched Ceiling Runner** – As an alternate to the ceiling runners in Items 2A through 2A3, notched ceiling runners to consist of C-shaped galv steel channel with notched return flanges sized to accommodate steel studs (Item 2B). Notched ceiling runner secured to concrete floor slab with steel masonry anchors spaced max 24 in. (610 mm) OC. When notched ceiling runner is used, deflection channel (Item 3A) shall not be used.

OLMAR SUPPLY INC – Type SCR

Construction Joints

Head of Wall

HWD

A4. Light Gauge Framing* – Floor and Ceiling Runners – As an alternate to the ceiling and floor runners in Item 2A, through 2A4, floor and ceiling runners to consist of galv steel channel sized to accommodate the **Light Gauge Framing* Steel Studs** (Item 2B3). Floor and ceiling runners to be provided with min 1-3/4 in. flanges. Ceiling runner installed perpendicular to direction of fluted steel deck and secured to valleys with steel masonry anchors spaced max 12 in. (305 mm) OC. When ceiling runner is used, deflection channel (Item 3A) shall not be used.

CALIFORNIA EXPANDED METAL PRODUCTS CO – ViperTrack™

B. Studs – Steel studs to be min 3-1/2 in. (89 mm) wide. Studs cut 1/2 to 3/4 in. (13 to 19 mm) less in length than assembly height with bottom nesting in and resting on floor runner and with top nesting in ceiling runner without attachment. When slotted ceiling runner (Item 2A1) is used, steel studs secured to slotted ceiling runner with No. 8 by 1/2 in. (13 mm) long wafer head steel screws at midheight of slot on each side of wall. Stud spacing not to exceed 24 in (610 mm) OC.

B1. Light Gauge Framing* – Slotted Studs – Slotted steel stud to be used in conjunction with **Light Gauge Framing* – Floor and Ceiling Runners** (Item 2A3). Slotted steel studs to be min 3-1/2 in. (89 mm) wide. Slotted steel studs cut 1 in. (25 mm) less in length than assembly height with bottom nesting in and secured to both ceiling and floor runners. Ceiling runner secured to preformed slot within steel stud by means of No. 10 by 3/4 in. (19 mm) long low profile head steel screw. Floor runner attached to bottom of steel stud by means of No. 8 by 1/2 in. (13 mm) long pan head steel screw. Slotted steel stud spacing not to exceed 24 in. (610 mm) OC.

STEELER INC – Slotted Stud

B2. Light Gauge Framing* – Slider C-Clip System – As an alternate to the **Light Gauge Framing* – Slotted Steel Studs** (Item 2B1), a Slider C-Clip System consisting of a C shaped steel clip with a slotted opening and a steel stud to be used in conjunction with **Light Gauge Framing – Floor and Ceiling Runners** (Item 2A3). Steel clips and studs to be min 3-1/2 in. (89 mm) wide. Steel clip inserted into inside flange of steel stud without attachment. Total length of steel stud cut 1 in. less than assembly height with bottom of steel stud nesting in and secured to floor runner. Floor runner attached to bottom of steel stud by means of No. 8 by 1/2 in. (13 mm) long pan head steel screw. Ceiling runner secured to steel C-Clip by means of No. 10 by 3/4 in. (19 mm) long pan head steel screw located 3/8 in. (10 mm) below top of ceiling runner. Top row of gypsum board screws shall be centered within the preformed slot of the C-Clip. Steel stud and steel clips spacing not to exceed 24 in. (610 mm) OC.

STEELER INC – Slider C Clip System

B3. Light Gauge Framing* – Steel Studs – Steel Studs to be used in conjunction with **Light Gauge Framing* – Floor and Ceiling Runners** (Item 2A5). Steel studs to be min 3-5/8 in. (92 mm) wide. Studs cut 1/2 to 3/4 in. (13 to 19 mm) less in length than assembly height with bottom nesting in and resting on floor runner and with top nesting in ceiling runner without attachment. When slotted ceiling runner (Item 2A1) is used, steel studs secured to slotted ceiling runner with No. 8 by 1/2 in. (13 mm) long wafer head steel screws at midheight of slot on each side of wall. Stud spacing not to exceed 24 in (610 mm) OC.

CALIFORNIA EXPANDED METAL PRODUCTS CO – ViperStud™

C. Gypsum Board* – Gypsum board sheets installed to a min total thickness of 5/8 in. and 1-1/4 in. (16 and 32 mm) on each side of wall for 1 and 2 hr rated assemblies, respectively. Wall to be constructed as specified in the individual Wall and Partition Design in the UL Fire Resistance Directory, except that a nom 1 in. (25 mm) gap shall be maintained between the top of the gypsum board and the lower surface of the floor and the top row of screws shall be installed into the studs 3-1/2 in. (89 mm) below the lower surface of the floor.

The hourly Assembly, F, FH FT and FTH Ratings of the joint system are equal to the hourly fire rating of the wall.

3. Joint System – Max separation between bottom of floor and top of wall is 1 in. (25 mm). The joint system is designed to accommodate a max 19 percent compression or extension from its installed width. The joint system consists of a deflection channel, forming material and a fill material, as follows:

A. Deflection Channel (optional) – A nom 3-5/8 in. (92 mm) wide by 3 in. (76 mm) deep min 24 ga steel U-shaped channel. Deflection channel secured to concrete floor with steel masonry anchors spaced max 24 in. (610 mm) OC. The ceiling runner (Item 2A) is installed within the deflection channel to maintain a 1 in. (25 mm) gap between the top of the ceiling runner and the top of the deflection channel. The ceiling runner is not fastened to the deflection channel.

B. Forming Material* – Min 1-3/8 in. (35 mm) width of 4 pcf (64 kg/m³) mineral wool batt insulation compressed and firmly packed into the gap between the top of the gypsum board and bottom of the floor on both sides of the wall and shall be a min 3/4 in. (19 mm) thick for 1 hr Rated Design and a min 1-1/2 in. (38 mm) thick for 2 hr Rated Design.

INDUSTRIAL INSULATION GROUP LLC – MinWool-1200 Safing

ROCK WOOL MANUFACTURING CO – Delta Board or Delta -8

ROCKWOOL MALAYSIA SDN BHD – Type Safe

ROXUL INC – Type Safe

THERMAFIBER INC – Type SAF

C. Fill, Void or Cavity Material* – Min 1/16 in. (1.6 mm) dry (1/8 in. or 3.2 mm wet) thickness of fill material sprayed or brushed on each side of the wall between the top of the gypsum board and the bottom of the floor to completely cover mineral wool and overlap a min of 1/2 in. (13 mm) onto gypsum board and floor on both sides of wall.

3M COMPANY – FireDam™ Spray 200

C1. Fill, Void or Cavity Material* – Tape – As an alternate to Item C, Tape cut to size and press applied along length of joint to completely cover mineral wool and lapping min 1 in. (25 mm) onto the concrete floor and the gypsum board. Tape shall be applied in minimum 1 ft (305 mm) lengths and adjoining lengths of Tape shall overlap min 1/2 in. (13 mm). Tape shall be applied at both sides of wall.

3M COMPANY – 3M Fire and Water Barrier Tape

*Indicates such products shall bear the UL or cUL Certification Mark for jurisdictions employing the UL or cUL Certification (such as Canada), respectively. 
Reprinted from the Online Certifications Directory with permission from UL®



UL System No. HW-D-0022
XHBN - Joint Systems
XHBN7 - Joint Systems Certified for Canada

January 23, 2018

| ANSI/UL2079 | CAN/ULC S115 |
|---|--|
| Assembly Rating – 2 Hr | F Ratings – 2 Hr |
| Nominal Joint Width – 1 In. | FT Ratings – 2 Hr |
| Class II Movement Capabilities – 19% Compression or Extension | FH Rating – 2 Hr |
| L Rating At Ambient – Less Than 1 CFM/lin ft (See Item 3B) | FTH Rating – 2 Hr |
| L Rating At 400 F – Less Than 1 CFM/lin ft (See Item 3B) | Nominal Joint Width – 25 mm |
| | Class II Movement Capabilities – 19% Compression or Extension |
| | L Rating At Ambient – Less Than 1.55 L/s/lin m (See Item 3B) |
| | L Rating At 204°C – Less Than Less Than 1.55 L/s/lin m (See Item 3B) |

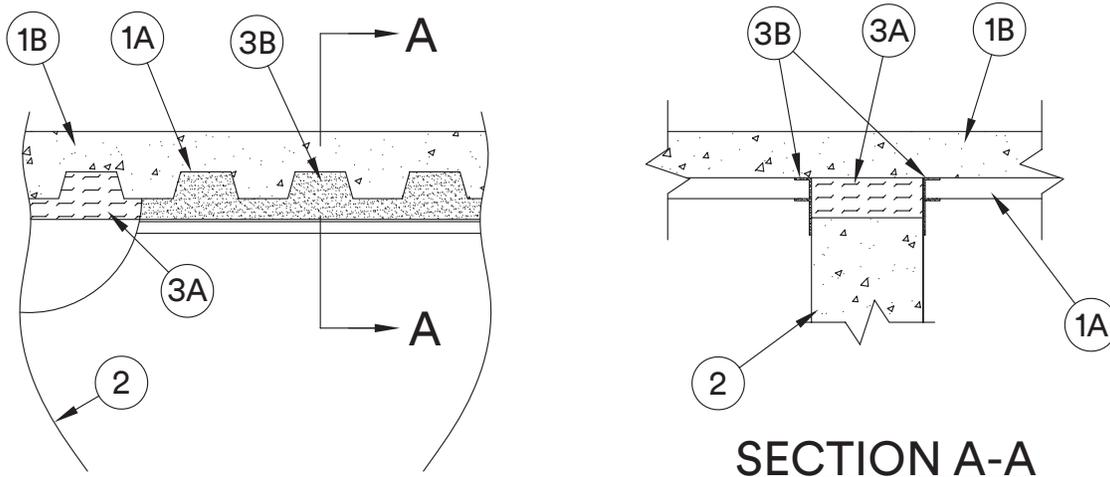

1. Floor Assembly – The fire-rated fluted steel deck/concrete floor assembly shall be constructed of the material and in the manner described in the individual Floor-Ceiling Design in the UL Fire Resistance Directory and shall include the following construction features:

A. Steel Floor And Form Units* – Max 3 in. (76 mm) deep galv steel floor deck.

A1. Spray Applied Fire Resistive Material* – (Optional, not shown) – Prior to the installation of the Forming Material and Fill, Void or Cavity Materials (Items 3A, 3B), the steel floor units may be sprayed with a min 5/16 in. (8 mm) thickness to max 11/16 in (17 mm) thickness of fire resistive material.

GCP APPLIED TECHNOLOGIES INC – Type MK-6/HY

B. Concrete – Min 2-1/2 in. (64 mm) thick reinforced concrete, as measured from the top plane of the floor units.

1A. Roof Assembly – (Not Shown) – As an alternate to the floor assembly, a fire rated fluted steel deck roof assembly may be used. The roof assembly shall be constructed of the materials and in the manner described in the individual P700 or P900 Series Roof-Ceiling Design in the UL Fire Resistance Directory. The hourly rating of the roof assembly shall be equal to or greater than the hourly rating of the wall assembly. The roof assembly shall include the following construction features:

A. Steel Roof Deck – Max 3 in. (76 mm) deep galv steel fluted roof deck.

B. Roof Insulation – (P 900 Series) – Min 2-1/4 in. (57 mm) thick poured insulating concrete, as measured from the top plane of the floor units.

C. Roof Insulation – Mineral and Fiber Board* – (P 700 Series) – Min 3/4 in. (19 mm) thick boards applied in one or more layers directly over steel or over gypsum board sheathing laid atop steel roof deck.

UL System No. HW-D-0022 (cont.)

D. Spray Applied Fire Resistive Material* – (P700 Series, not shown)–Prior to the installation of the Deflective Channel, Forming Material and Fill, Void or Cavity Material (Items 3A, 3B, 3C), the steel floor units may be sprayed with a min 5/16 in. thickness to max 11/16 in. thickness of fire resistive material.

GCP APPLIED TECHNOLOGIES INC – Type MK-6/HY

2. Wall Assembly – Min 6-1/8 in. (156 mm) thick steel-reinforced lightweight or normal weight (100-150 pcf or 1600-2400 kg/m³) concrete. Wall may also be constructed of any UL Classified **Concrete Blocks***.

See **Concrete Blocks** (CAZT) category in the Fire Resistance Directory for names of manufacturers.

3. Joint System – **Max separation between bottom of floor and top of wall is 1 in. (25 mm). The joint system is designed to accommodate a max 19 percent compression or extension from its installed width.** The joint system consists of a forming material and a fill material, as follows:

A. Forming Material* – Min 6-1/2 in. (165 mm) thickness of min 4 pcf (64 kg/m³) density mineral wool batt insulation cut to the shape of the fluted deck, approx 20 percent larger than the area of the flutes with additional min 6-1/2 in. (165 mm) thick by 1-3/8 in. (35 mm) high sections at the bottom of the shapes to completely fill the 1 in. (25 mm) gap between the top of the wall and bottom of the steel floor or roof deck. Mineral wool to be compressed and firmly packed into the flutes and the gap between the top of the wall and bottom of the steel floor or roof deck.

INDUSTRIAL INSULATION GROUP L L C – MinWool-1200 Safing

ROCK WOOL MANUFACTURING CO – Delta Board or Delta-8

ROCKWOOL MALAYSIA SDN BHD – Type Safe

ROCKWOOL – Type Safe

THERMAFIBER INC – Type SAF

A1. Forming Material* – (Optional, Not Shown) - Preformed mineral wool plugs, formed to the shape of the fluted floor units, friction fit to completely fill the flutes above the ceiling channel. The plugs shall project beyond each side of the ceiling runner and shall be recessed from both wall surfaces to accommodate the required thickness of fill material (Item 3B). Additional forming material, described in Item 3A, to be used in conjunction with the plugs to fill the gap between the top of gypsum board and bottom of steel deck.

THERMAFIBER INC – TopStop mineral wool deck plugs Type SAF batts

B. Fill, Void or Cavity Material* – Min 1/16 in. (1.6 mm) dry thickness (min 1/8 in. or 3.2 mm wet thickness) of fill material sprayed or brushed on each side of the wall in the flutes of the steel floor or roof deck and between the top of the wall and the bottom of the steel floor units to completely cover mineral wool and overlap a min of 1 in. (25 mm) onto wall and steel deck on both sides of wall. When the steel floor or roof deck is coated with spray applied material, the fill material shall overlap min 2 in. (51 mm) onto the spray applied material.

3M COMPANY – FireDam™ Spray 200

B1. Fill, Void or Cavity Material* – Tape – As an alternate to Item B, Tape cut to size and press applied within fluted areas of joint to completely cover mineral wool lapping min 1 in. (25 mm) onto the contour of the steel floor units, or min 2 in. (51 mm) onto the spray applied fire resistive material (Item 1A1) on the steel floor units, and extending to lap min 1 in. (25 mm) onto the concrete wall. Additional pieces of Tape are applied along the joint to completely cover the remaining mineral wool between bottom of steel deck and top edge of wall along length of joint, lapping min 1 in. (25 mm) onto the contour of the steel floor units, or min 2 in. (51 mm) onto the spray applied fire resistive material (Item 1A1) on the steel floor units, and min 1 in. (25 mm) onto concrete wall. Adjoining lengths of Tape shall overlap min 1/2 in. (13 mm). Tape shall be applied at both sides of wall.

3M COMPANY – 3M Fire and Water Barrier Tape

Construction Joints

Head of Wall

HW-D



L Ratings apply only when FireDam™ Spray 200 is used.

*Indicates such products shall bear the UL or cUL Certification Mark for jurisdictions employing the UL or cUL Certification (such as Canada), respectively.

Reprinted from the Online Certifications Directory with permission from UL©

3M Industrial Adhesives and Tapes
Fire Protection Products
3M Center, Building 230-B-S-37
St. Paul, MN 55144-1000

UL System No. HW-D-0023

January 17, 2017

ANSI/UL2079

Assembly Ratings – 2 Hr
Nominal Joint Width – 1 in.

Class II Movement Capabilities – 19% Compression or Extension
L Rating At Ambient – Less Than 1 CFM/Lin Ft
L Rating At 400°F – Less Than 1 CFM/Lin Ft

CAN/ULC S115

F Rating – 2 Hr
FT Ratings – 2 Hr
FH Ratings – 2 Hr
FTH Ratings – 2 Hr

Nominal Joint Width – 25 mm
Class II Movement Capabilities – 19% Compression or Extension
L Rating At Ambient – Less Than 1.55 L/s/lin m
L Rating At 204°C – Less Than 1.55 L/s/lin m

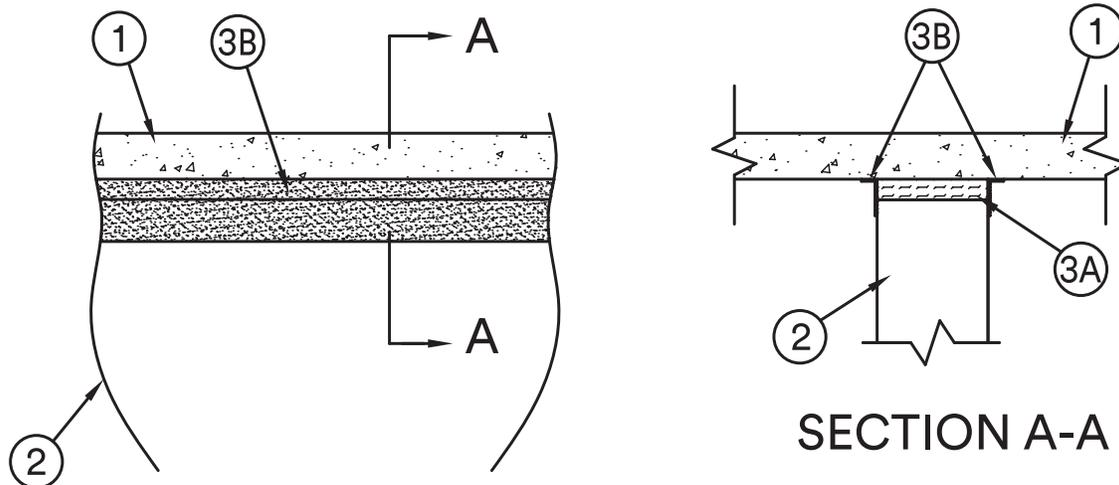

1. **Floor Assembly** – Min 4-1/2 in. (114 mm) thick steel-reinforced lightweight or normal weight (100-150 pcf or 1600-2400 kg/m³) structural concrete.
2. **Wall Assembly** – Min 6-1/8 in. (156 mm) thick steel-reinforced lightweight or normal weight (100-150 pcf or 1600-2400 kg/m³) concrete. Wall may also be constructed of any UL Classified **Concrete Blocks***.
See **Concrete Blocks (CAZT)** category in Fire Resistance Directory for names of manufacturers.
3. **Joint System** – Max separation between bottom of floor and top of wall is 1 in. (25 mm). The joint system is designed to accommodate a max 19 percent compression or extension from its installed width. The joint system consists of a forming material and a fill material, as follows:
 - A. **Forming Material*** – Min 6-1/8 in. (156 mm) thickness of min 4 pcf (64 kg/m³) density mineral wool batt insulation, cut to a min 1-3/8 in. (35 mm) height, compressed and firmly packed into the gap between the top of wall and bottom of the floor as a permanent form.
INDUSTRIAL INSULATION GROUP LLC – MinWool-1200 Safing
ROCK WOOL MANUFACTURING CO – Delta Board or Delta-8
ROCKWOOL MALAYSIA SDN BHD – Type Safe
ROXUL INC – Type Safe
THERMAFIBER INC – Type SAF
 - B. **Fill, Void or Cavity Material* – Tape** – As an alternate to Item B, Tape cut to size and press applied along length of joint to completely cover mineral wool and lapping min 1 in. (25 mm) onto the concrete floor and wall. Tape shall be applied in minimum 1 ft (305 mm) lengths along joint and adjoining lengths of Tape shall overlap min 1/2 in. (13 mm). Tape shall be applied at both sides of wall.
3M COMPANY – FireDam™ Spray 200
 - B1. **Fill, Void or Cavity Material* – Tape** – As an alternate to Item B, Tape cut to size and press applied along length of joint to completely cover mineral wool and lapping min 1 in. (25 mm) onto the concrete floor and wall. Tape shall be applied in minimum 1 ft (305 mm) lengths along joint and adjoining lengths of Tape shall overlap min 1/2 in. (13 mm). Tape shall be applied at both sides of wall.
3M COMPANY – 3M Fire and Water Barrier Tape

*Indicates such products shall bear the UL or cUL Certification Mark for jurisdictions employing the UL or cUL Certification (such as Canada), respectively. 

Reprinted from the Online Certifications Directory with permission from UL©

Construction Joints

Head of Wall

HWD



UL System No. HW-D-0029
XHBN - Joint Systems
XHBN7 - Joint Systems Certified for Canada

January 23, 2018

| ANSI/UL2079 | CAN/ULC S115 |
|---|---|
| Assembly Ratings – 1 and 2 Hr (See Items 2 and 3B) | F Ratings – 1 and 2 Hr (See Items 2 and 3B) |
| Nominal Joint Width - 1 In. | FT Ratings – 1 and 2 Hr (See Items 2 and 3B) |
| Class II Movement Capabilities – 25% Compression or Extension | FH Ratings – 1 and 2 Hr (See Items 2 and 3B) |
| L Rating At 400 F – Less Than 1 CFM/Lin Ft (See Item 3C) | FTH Ratings – 1 and 2 Hr (See Items 2 and 3B) |
| | Nominal Joint Width - 25 mm |
| | Class II Movement Capabilities – 25% Compression or Extension |
| | L Rating At Ambient – Less Than 1.55 L/s/lin m (See Item 3C) |
| | L Rating At 204°C – Less Than 1.55 L/s/lin m (See Item 3C) |

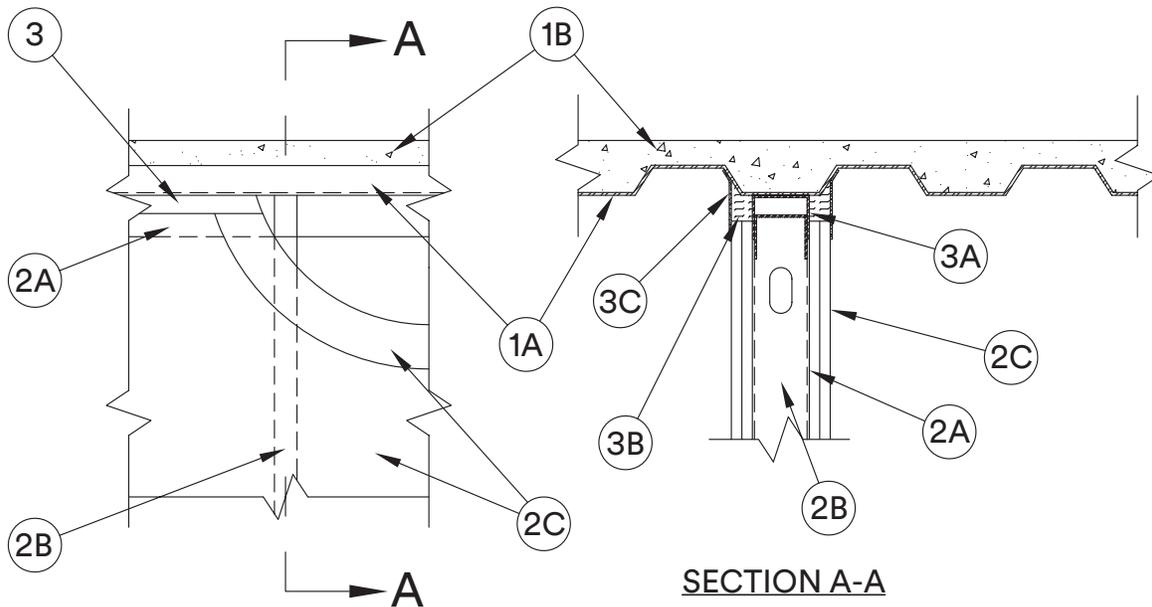

1. Floor Assembly – The fire-rated fluted steel deck/concrete floor assembly shall be constructed of the materials and in the manner described in the individual D700 or D900 Series Floor-Ceiling Design in the UL Fire Resistance Directory and shall include the following construction features:

A. Steel Floor And Form Units* – Max 3 in. (76 mm) deep galv steel fluted floor deck .

A1. Spray Applied Fire Resistive Material* – (Optional, Not Shown) – Prior to the installation of the Deflective Channel, Forming Material and Fill, Void or Cavity Materials (Items 3A and 3B), the steel floor units may be sprayed with a min 5/16 in. (8 mm) to max 11/16 in. (18 mm) thickness of fire resistive material.

GCP APPLIED TECHNOLOGIES INC – Type MK-6/HY.

B. Concrete – Min 2-1/2 in. (64 mm) thick reinforced concrete, as measured from the top plane of the floor units.

1A. Roof Assembly – (Not Shown) – As an alternate to the floor assembly, a fire rated fluted steel deck roof assembly may be used. The roof assembly shall be constructed of the materials and in the manner described in the individual P900 Series Roof-Ceiling Design in the UL Fire Resistance Directory. **The hourly rating of the roof assembly shall be equal to or greater than the hourly rating of the wall assembly.** The roof assembly shall include the following construction features:

A. Steel Roof Deck – Max 3 in. (76 mm) deep galv steel fluted roof deck.

B. Roof Insulation – Min 2-1/4 in. (57 mm) thick poured insulating concrete, as measured from the top plane of the floor units.

Construction Joints

Head of Wall

HWD

2. **Wall Assembly** – The 1 or 2 hr fire rated gypsum board/steel stud wall assembly shall be constructed of the materials and in the manner described in the individual U400 or V400- Series Wall and Partition Design in the UL Fire Resistance Directory and shall include the following construction features:

A. Steel Floor And Ceiling Runners – Floor and ceiling runners of wall assembly shall consist of galv steel channels sized to accommodate steel studs (Item 2B). When deflection channel (Item 3A) is used, ceiling runner to be provided with 3 in. (76 mm) flanges. Ceiling runner installed within the deflection channel with 1 in. (25 mm) gap maintained between the top of ceiling runner and top of deflection channel. When deflection channel is not used, flange height of ceiling runner shall be min 3/4 in. (19 mm) greater than nom joint width. Ceiling runner installed parallel to direction of fluted steel deck, centered beneath valley, and secured with steel masonry anchors or by welds spaced max 24 in. (610 mm) OC. When optional spray-applied fire resistive material is used on the steel deck and when deflection channel is not used, ceiling runner is secured through spray-applied material to valley of floor steel deck with min 3/16 in. (5 mm) diam steel masonry anchors spaced max 12 in. (305 mm) OC.

A1. Light Gauge Framing* – Slotted Ceiling Runner – As an alternate to the ceiling runner in Item 2A, slotted ceiling runner to consist of galv steel channel with slotted flanges sized to accommodate steel studs (Item 2B). Slotted ceiling runner installed parallel to direction of fluted steel deck, centered beneath valley, and secured with steel masonry anchors spaced max 24 in. (610 mm) OC. When slotted ceiling runner is used, deflection channel (Item 3A) shall not be used. When optional spray-applied fire resistive material is used on the steel floor slotted ceiling runner secured through spray-applied material to valley of steel deck with min 3/16 in. (5 mm) diam steel masonry anchors spaced max 12 in. (305 mm) OC.

BRADY CONSTRUCTION INNOVATIONS INC, DBA SLIPTRACK SYSTEMS – SLP-TRK

CALIFORNIA EXPANDED METAL PRODUCTS CO – CST

CLARKDIETRICH BUILDING SYSTEMS – Type SLT, SLT-H

MARINO/WARE, DIV OF WARE INDUSTRIES INC – Type SLT

METAL-LITE INC – The System

RAM SALES L L C – RAM Slotted Track

SCAFCO STEEL STUD MANUFACTURING CO

STEELER INC – Steeler Slotted Ceiling Runner

TELLING INDUSTRIES L L C – True-Action Deflection Track

A2. Light Gauge Framing – Floor and Ceiling Runners – As an alternate to the ceiling and floor runners in Item 2A, 2A1 and 2A2, floor and ceiling runners to consist of galv steel channel sized to accommodate the **Light Gauge Framing* Slotted Stud** (Item 2B1) or **Light Gauge Framing* Slider C-Clip System** (Item 2B2). Floor and ceiling runners to be provided with min 1-1/4 in. and 3 in. (32 and 76 mm) flanges, respectively. Ceiling runner installed parallel to direction of steel deck, centered beneath valley, and secured with steel masonry anchors spaced max 12 in. (305 mm) OC. When ceiling runner is used, deflection channel (Item 3A) shall not be used. When optional spray-applied fire resistive material is used on steel deck, ceiling runner secured through spray-applied material to valley of the steel deck with min 3/16 in. (5 mm) diam steel masonry anchors spaced max 12 in. (305 mm) OC.

STEELER INC – Floor and Ceiling Runners

A3. Light Gauge Framing* – Notched Ceiling Runner – As an alternate to the ceiling runners in Items 2A through 2A3, notched ceiling runners to consist of C-shaped galv steel channel with notched return flanges sized to accommodate steel studs (Item 2B). Notched ceiling runner installed parallel to direction of steel centered on valley, and secured with steel masonry anchors spaced max 24 in. (610 mm) OC. When notched ceiling runner is used, deflection channel (Item 3A) shall not be used. When optional spray-applied fire resistive material is used on the steel deck, notched ceiling runner secured through spray-applied material to valley of deck with min 3/16 in. (5 mm) diam steel masonry anchors spaced max 12 in. (305 mm) OC.

OLMAR SUPPLY INC – Type SCR

A4. Light Gauge Framing* – Floor and Ceiling Runners – As an alternate to the ceiling and floor runners in Item 2A, through 2A4, floor and ceiling runners to consist of galv steel channel sized to accommodate the **Light Gauge Framing* Steel Studs** (Item 2B3). Floor and ceiling runners to be provided with min 1-3/4 in. flanges. Ceiling runner installed parallel to direction of steel deck, centered beneath valley, and secured to valleys with steel masonry anchors spaced max 12 in. (305 mm) OC. When ceiling runner is used, deflection channel (Item 3A) shall not be used. When optional spray-applied fire resistive material is used on the steel deck, ceiling runner is secured through spray-applied material to each valley of steel deck with min 3/16 in. (5 mm) diam steel masonry anchors spaced max 12 in. (305 mm) OC.

CALIFORNIA EXPANDED METAL PRODUCTS CO – ViperTrack™

B. Studs – Steel studs to be min 3-1/2 in. (89 mm) wide. Studs cut 1/2 to 3/4 in. (13 to 19 mm) less in length than assembly height with bottom nesting in and resting on floor runner and with top nesting in ceiling runner without attachment. When slotted ceiling runner (Item 2A1) is used, steel studs secured to slotted ceiling runner with No. 8 by 1/2 in. (13 mm) long wafer head steel screws at midheight of slot on each side of wall. Stud spacing not to exceed 24 in. (610 mm) OC.

B1. Light Gauge Framing* – Slotted Studs – Slotted steel stud to be used in conjunction with **Light Gauge Framing* – Floor and Ceiling Runners** (Item 2A3). Slotted steel studs to be min 3-1/2 in. (89 mm) wide. Slotted studs cut 1 in. (25 mm) less in length than assembly height with bottom nesting in and secured to both ceiling and floor runners. Ceiling runner secured to preformed slot within steel stud by means of No. 10 by 3/4 in. (19 mm) long low profile head steel screw. Floor runner attached to bottom of steel stud by means of No. 8 by 1/2 in. (13 mm) long pan head steel screw. Slotted stud spacing not to exceed 24 in. (610 mm) OC.

STEELER INC – Slotted Stud

B2. Light Gauge Framing* – Slider C-Clip System – As an alternate to the **Light Gauge Framing* – Slotted Steel Studs** (Item 2B1), a Slider C-Clip System consisting of a C shaped steel clip with a slotted opening and a steel stud to be used in conjunction with **Light Gauge Framing – Floor and Ceiling Runners** (Item 2A3). Steel clips and studs to be min 3-1/2 in. (89 mm) wide. Steel clip inserted into inside flange of steel stud without attachment. Total length of steel stud cut 1 in. (25 mm) less than assembly height with bottom of steel stud nesting in and secured to floor runner. Floor runner attached to bottom of steel stud by means of No. 8 by 1/2 in. (13 mm) long pan head steel screw. Ceiling runner secured to steel C-Clip by means of No. 10 by 3/4 in. (19 mm) long pan head steel screw located 3/8 in. (10 mm) below top of ceiling runner. Top row of gypsum board screws shall be centered within the preformed slot of the C-Clip. Steel stud and steel clips spacing not to exceed 24 in. (610 mm) OC.

STEELER INC – Slider C Clip System

B3. Light Gauge Framing* – Steel Studs – Steel Studs to be used in conjunction with **Light Gauge Framing* – Floor and Ceiling Runners** (Item 2A5). Steel studs to be min 3-5/8 in. (92 mm) wide. Studs cut 1/2 to 3/4 in. (13 to 19 mm) less in length than assembly height with bottom nesting in and resting on floor runner and with top nesting in ceiling runner without attachment. When slotted ceiling runner (Item 2A1) is used, steel studs secured to slotted ceiling runner with No. 8 by 1/2 in. (13 mm) long wafer head steel screws at midheight of slot on each side of wall. Stud spacing not to exceed 24 in (610 mm) OC.

CALIFORNIA EXPANDED METAL PRODUCTS CO – ViperStud™

C. Gypsum Board* – Gypsum board sheets installed to a min total thickness of 5/8 in. and 1-1/4 in. (16 and 32 mm) on each side of wall for 1 and 2 hr rated assemblies, respectively. Wall to be constructed as specified in the individual Wall and Partition Design in the UL Fire Resistance Directory, except that a nom 1 in. (25 mm) gap shall be maintained between the top of the gypsum board and the bottom of the steel floor or roof deck and the top row of screws shall be installed into the studs 3-1/2 in. (89 mm) below the lower surface of the floor. **The hourly ratings of the joint system are equal to the hourly fire rating of the wall.**

3. Joint System – Max separation between bottom of floor or roof and top of wall is 1 in. (25 mm). The joint system is designed to accommodate a max 25 percent compression or extension from its installed width. The joint system consists of an optional deflection channel, forming material and a fill material, as follows:

A. Deflection Channel – (Optional) – A nom 3-5/8 in. (92 mm) wide by 3 in. (76 mm) deep min 24 ga steel U-shaped channel. Deflection channel installed parallel to direction of steel deck, centered beneath valley and secured with steel masonry anchors or by welds spaced max 24 in. (610 mm) OC. When optional spray- applied fire resistive material is used on the steel deck, deflection channel secured through spray- applied material to valley of steel deck with min 1-1/2 in. (38 mm) long by min 3/16 in. (5 mm) diam steel masonry anchors spaced a max 24 in. (610 mm) OC . The ceiling runner (Item 2A) is installed within the deflection channel to maintain a 1 in. (25 mm) gap between the top of the ceiling runner and the top of the deflection channel. The ceiling runner is not fastened to the deflection channel.

B. Forming Material* – Min 4 pcf (64 kg/m³) mineral wool batt insulation to be cut a min of 20 percent wider than the gap between the top of the gypsum board and bottom of the steel floor or roof deck. The mineral wool is to be compressed and firmly packed into the gap between the top of the gypsum board and bottom of the steel floor or roof deck on both sides of the wall and shall be min 3/4 in. (19 mm) thick for 1 hr Rated Design and min 1-1/2 in. (38 mm) thick for 2 hr Rated Design.

INDUSTRIAL INSULATION GROUP L L C – MinWool-1200 Safing

ROCK WOOL MANUFACTURING CO – Delta Board or Delta-8

ROCKWOOL MALAYSIA SDN BHD – Type Safe

ROCKWOOL – Type Safe

THERMAFIBER INC – Type SAF

C. Fill, Void or Cavity Material* – Min 1/16 in. (1.6 mm) dry thickness (1/8 in. or 3.2 mm wet thickness) of fill material sprayed or brushed on each side of the wall between the top of the gypsum board and the bottom of the steel floor or roof deck to completely cover mineral wool and overlap a min of 1/2 in. (13 mm) onto gypsum board and steel deck on both sides of wall. When the steel deck is coated with spray applied Material (Item A1), the fill material shall overlap min 2 in. (51 mm) onto the spray applied material.

3M COMPANY – Fire Dam™ Spray 200

C1. Fill, Void or Cavity Material* – Tape – As an alternate to Item C, Tape cut to size and press applied within fluted areas of joint to completely cover mineral wool lapping min 1 in. (25 mm) onto the contour of the steel floor units, or min 2 in. (51 mm) onto the spray applied fire resistive material (Item 1A1) on the steel floor units, and extending to lap min 1 in. (25 mm) onto the gypsum wall. Additional pieces of Tape are applied along the joint to completely cover the remaining mineral wool between bottom of steel deck and top edge of wall along length of joint, lapping min 1 in. (25 mm) onto the contour of the steel floor units, or min 2 in. (51 mm) onto the spray applied fire resistive material (Item 1A1) on the steel floor units, and min 1 in. (25 mm) onto gypsum wall. Adjoining lengths of Tape shall overlap min 1/2 in. (13 mm). Tape shall be applied at both sides of wall.

3M COMPANY – 3M Fire and Water Barrier Tape



L Ratings apply only when FireDam™ Spray 200 is used.

*Indicates such products shall bear the UL or cUL Certification Mark for jurisdictions employing the UL or cUL Certification (such as Canada), respectively.

Reprinted from the Online Certifications Directory with permission from UL©



UL System No. HW-D-0030
XHBN - Joint Systems
XHBN7 - Joint Systems Certified for Canada

January 23, 2018

| ANSI/UL2079 | CAN/ULC S115 |
|---|---|
| Assembly Rating – 2 Hr | F Rating – 2 Hr |
| Nominal Joint Width - 1 In. | FT Rating – 2 Hr |
| Class II Movement Capabilities – 19% Compression or Extension | FH Rating – 2 Hr |
| L Rating At 400 F – Less Than 1 CFM/lin ft (See Item 3B) | FTH Rating – 2 Hr |
| | Nominal Joint Width - 25 mm |
| | Class II Movement Capabilities – 19% Compression or Extension |
| | L Rating At Ambient – Less Than 1.55 L/s/lin m (See Item 3B) |
| | L Rating At 204°C – Less Than 1.55 L/s/lin m (See Item 3B) |

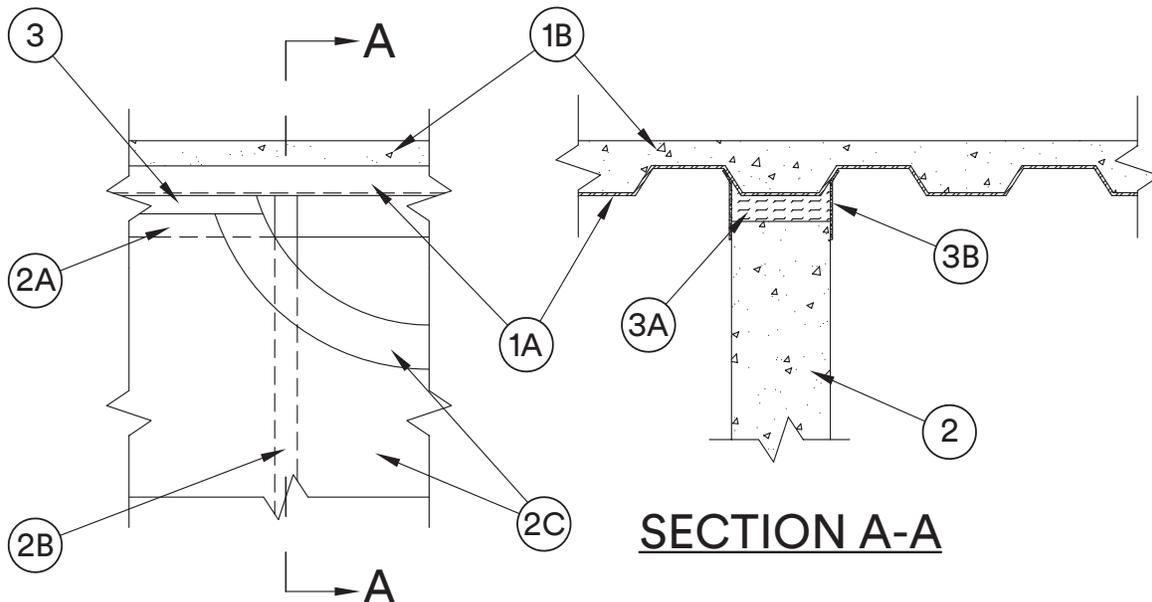

1. Floor Assembly – The fire-rated fluted steel deck/concrete floor assembly shall be constructed of the materials and in the manner described in the individual Floor-Ceiling Design in the UL Fire Resistance Directory and shall include the following construction features:

A. Steel Floor And Form Units* – Max 3 in. (76 mm) deep galv steel fluted floor deck .

A1. Spray Applied Fire Resistive Material* – (Optional, not shown) – Prior to the installation of the Forming Material and Fill, Void or Cavity Materials (Items 3A and 3B), the steel floor units may be sprayed with a min 5/16 in. (8 mm) to max 11/16 in (17 mm) thickness of fire resistive material.

GCP APPLIED TECHNOLOGIES INC – Type MK-6/HY.

B. Concrete – Min 2-1/2 in. (64 mm) thick reinforced concrete, as measured from the top plane of the floor units.

1A. Roof Assembly – (Not Shown)–As an alternate to the floor assembly, a fire rated fluted steel deck roof assembly may be used. The roof assembly shall be constructed of the materials and in the manner described in the individual P700 or P900 Series Roof-Ceiling Design in the UL Fire Resistance Directory. The hourly rating of the roof assembly shall be equal to or greater than the hourly rating of the wall assembly. The roof assembly shall include the following construction features:

A. Steel Roof Deck – Max 3 in. (76 mm) deep galv steel fluted roof deck.

B. Roof Insulation – (P 900 Series) - Min 2-1/4 in. (57 mm) thick poured insulating concrete, as measured from the top plane of the floor units.

C. Roof Insulation – Mineral and Fiber Board* – (P 700 Series) – Min 3/4 in. (19 mm) thick boards applied in one or more layers directly over steel or over gypsum board sheathing laid atop steel roof deck.

UL System No. HW-D-0030 (cont.)

D. Spray Applied Fire Resistive Material* – (P700 Series, not shown)–Prior to the installation of the Deflective Channel, Forming Material and Fill, Void or Cavity Material (Items 3A, 3B, 3C), the steel floor units may be sprayed with a min 5/16 in. (8 mm) to max 11/16 in. (17 mm) thickness of fire resistive material.

GCP APPLIED TECHNOLOGIES INC – Type MK-6/HY

2. Wall Assembly – Min 6-1/8 in. (156 mm) thick steel-reinforced lightweight or normal weight (100-150 pcf or 1600-2400 kg/m³) concrete. Wall may also be constructed of any UL Classified Concrete Blocks*.

See **Concrete Blocks** (CAZT) category in Fire Resistance Directory for names of manufacturers.

3. Joint System – Max separation between bottom of floor or roof and top of wall is 1 in. (25 mm). The joint system is designed to accommodate a max 19 percent compression or extension from its installed width. The joint system consists of a forming material and a fill material, as follows:

A. Forming Material* – Min 6-1/2 in. (165 mm) thickness of min 4 pcf (64 kg/m³) density mineral wool batt insulation cut a min of 20 percent wider than the gap between the top of the wall and bottom of the steel floor or roof deck . Mineral wool to be compressed and firmly packed into the gap between the top of the wall and bottom of the steel floor or roof deck.

INDUSTRIAL INSULATION GROUP L L C – MinWool-1200 Safing

ROCK WOOL MANUFACTURING CO – Delta Board or Delta-8

ROCKWOOL MALAYSIA SDN BHD – Type Safe

ROCKWOOL – Type Safe

THERMAFIBER INC – Type SAF

B. Fill, Void or Cavity Material* – Min 1/16 in. (1.6 mm) dry thickness (min 1/8 in. or 3.2 mm wet thickness) of fill material sprayed or brushed on each side of the wall between the top of the wall and the bottom of the steel floor or roof deck to completely cover mineral wool and overlap a min of 1/2 in. (13 mm) onto wall and steel floor or roof deck on both sides of wall. When the steel floor or roof deck is coated with spray applied material, the fill material shall overlap min 2 in. (51 mm) onto the spray applied material.

3M COMPANY – FireDam™ Spray 200

B1. Fill, Void or Cavity Material* – Tape – As an alternate to Item B, Tape cut to size and press applied along length of joint to completely cover mineral wool and lap min 1 in. (25 mm) onto the steel floor units, or min 2 in. (51 mm) onto the spray applied fire resistive material (Item 1A1) on the steel floor units, and min 1 in. (25 mm) onto concrete wall. Adjoining lengths of Tape shall overlap min 1/2 in. (13 mm). Tape shall be applied at both sides of wall.

3M COMPANY – 3M Fire and Water Barrier Tape



L Ratings apply only when FireDam™ Spray 200 is used.

*Indicates such products shall bear the UL or cUL Certification Mark for jurisdictions employing the UL or cUL Certification (such as Canada), respectively.

Reprinted from the Online Certifications Directory with permission from UL©



UL System No. HW-D-0031
XHBN - Joint Systems
XHBN7 - Joint Systems Certified for Canada

January 23, 2018

| ANSI/UL2079 | CAN/ULC S115 |
|---|---|
| Assembly Rating – 2 Hr | F Rating – 2 Hr |
| Nominal Joint Width – 1 In. | FT Rating – 2 Hr |
| Class II Movement Capabilities – 25% Compression or Extension | FH Rating – 2 Hr |
| L Rating At Ambient – Less Than 1 CFM/lin ft (See Item 3C) | FTH Rating – 2 Hr |
| L Rating At 400 F – Less Than 1 CFM/lin ft (See Item 3C) | Nominal Joint Width – 25 mm |
| | Class II Movement Capabilities – 25% Compression or Extension |
| | L Rating At Ambient – Less Than 1.55 L/s/lin m (See Item 3C) |
| | L Rating At 204°C – Less Than 1.55 L/s/lin m (See Item 3C) |

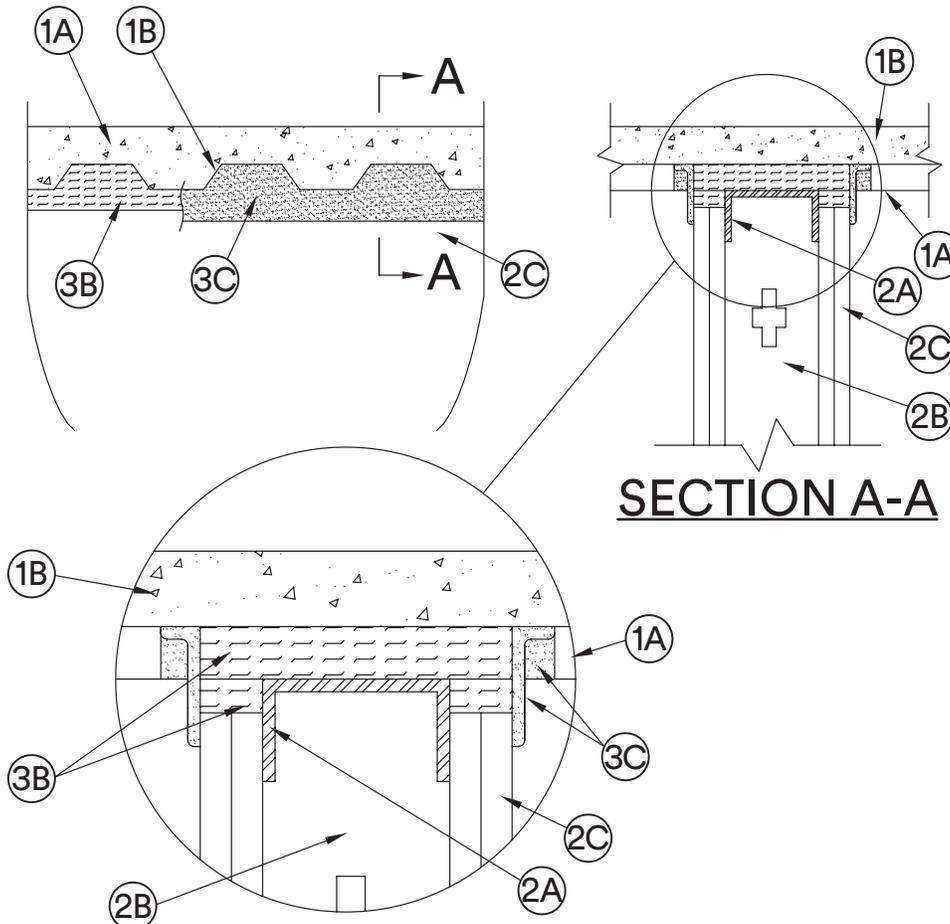

Construction Joints

Head of Wall

HWD

1. **Floor Assembly** – The fire-rated fluted steel deck/concrete floor assembly shall be constructed of the materials and in the manner described in the individual D700 or D900 Series Floor-Ceiling Design in the UL Fire Resistance Directory and shall include the following construction features:
 - A. **Steel Floor And Form Units*** – Max 3 in. (76 mm) deep galv steel fluted floor deck .
 - B. **Concrete** – Min 2-1/2 in. (64 mm) thick reinforced concrete, as measured from the top plane of the floor units.
 - C. **Spray Applied Fire Resistive Material*** – (Optional, Not Shown) – Prior to the installation of the Deflection Channel, Forming Material and Fill, Void or Cavity Materials (Items 3A, 3B, 3C), the steel floor units may be sprayed with a min 5/16 in. (8 mm) to max 11/16 in. (18 mm) thickness of fire resistive material.

GCP APPLIED TECHNOLOGIES INC – Type MK-6/HT.
 - 1A. **Roof Assembly** – (Not Shown) – As an alternate to the floor assembly, a fire rated fluted steel deck roof assembly may be used. The roof assembly shall be constructed of the materials and in the manner described in the individual P900 Series Roof-Ceiling Design in the UL Fire Resistance Directory. The hourly rating of the roof assembly shall be equal to or greater than the hourly rating of the wall assembly. The roof assembly shall include the following construction features:
 - A. **Steel Roof Deck** – Max 3 in. (76 mm) deep galv steel fluted roof deck.
 - B. **Roof Insulation** – Min 2-1/4 in. (57 mm) thick poured insulating concrete, as measured from the top plane of the roof deck.
 2. **Wall Assembly** – The 2 hr fire rated gypsum board/steel stud wall assembly shall be constructed of the materials and in the manner described in the individual U400- or V400 Series Wall and Partition Design in the UL Fire Resistance Directory and shall include the following construction features:
 - A. **Steel Floor And Ceiling Runners** – Floor and ceiling runners of wall assembly shall consist of galv steel channels sized to accommodate steel studs (Item 2B). When deflection channel (Item 3A) is used, ceiling runner to be provided with 3 in. (76 mm) flanges. Ceiling runner is installed within the deflection channel with 2 in. (51 mm) gap maintained between the top of ceiling runner and top of deflection channel. When deflection channel is not used, flange height of ceiling runner shall be min 3/4 in. (19 mm) greater than nom joint width. Ceiling runner installed perpendicular to direction of fluted steel deck and secured to valleys with steel masonry anchors or by welds spaced max 24 in. (610 mm) OC. When optional spray-applied fire resistive material is used on the steel deck and when deflection channel is not used, ceiling runner secured through spray-applied material to each valley of the steel deck with min 3/16 in. (5 mm) diam steel masonry anchors spaced max 12 in. (305 mm) OC.
 - A1. **Light Gauge Framing*** – Slotted Ceiling Runner – As an alternate to the ceiling runner in Item 2A, slotted ceiling runner to consist of galv steel channel with slotted flanges sized to accommodate steel studs (Item 2B). Slotted ceiling runner installed perpendicular to direction of fluted steel deck and secured to valleys with steel masonry anchors spaced max 24 in. (610 mm) OC. When slotted ceiling runner is used, deflection channel (Item 3A) shall not be used. When optional spray-applied fire resistive material is used on the steel deck, slotted ceiling runner secured through spray-applied material to each valley of the steel deck with min 3/16 in. (5 mm) diam steel masonry anchors spaced max 12 in. (305 mm) OC.

BRADY CONSTRUCTION INNOVATIONS INC, DBA SLIPTRACK SYSTEMS – SLP-TRK
CLARKDIETRICH BUILDING SYSTEMS – Type SLT, SLT-H
MARINO/WARE, DIV OF WARE INDUSTRIES INC – Type SLT
METAL-LITE INC – The System
RAM SALES L L C – RAM Slotted Track
SCAFCO STEEL STUD MANUFACTURING CO
TELLING INDUSTRIES L L C – True-Action Deflection Track
 - A2. **Light Gauge Framing*** – Notched Ceiling Runner – As an alternate to the ceiling runners in Items 2A through 2A2, notched ceiling runners to consist of C-shaped galv steel channel with notched return flanges sized to accommodate steel studs (Item 2B). Notched ceiling runner installed perpendicular to direction of fluted steel deck and secured to valleys with steel masonry anchors spaced max 24 in. (610 mm) OC. When notched ceiling runner is used, deflection channel (Item 3A) shall not be used. When optional spray-applied fire resistive material is used on the steel deck, notched ceiling runner secured through spray-applied material to each valley of deck with min 3/16 in. (5 mm) diam steel masonry anchors spaced max 12 in. (305 mm) OC.
 - OLMAR SUPPLY INC** – Type SCR
 - B. **Studs** – Steel studs to be min 3-1/2 in. (89 mm) wide. Studs cut 1/2 to 3/4 in. (13 to 19 mm) less in length than assembly height with bottom nesting in and resting on floor runner and with top nesting in ceiling runner without attachment. When slotted ceiling runner (Item 2A1) is used, steel studs secured to slotted ceiling runner with No. 8 by 1/2 in. (13 mm) long wafer head steel screws at midheight of slot on each side of wall. Stud spacing not to exceed 24 in. (610 mm) OC.
 - C. **Gypsum Board*** – Gypsum board sheets installed to a min total thickness of 1-1/4 in. (32 mm) on each side of wall. Wall to be constructed as specified in the individual Wall and Partition Design in the UL Fire Resistance Directory, except that a nom 2 in. (51 mm) gap shall be maintained between the top of the gypsum board and the bottom of the steel floor roof deck and the top row of screws shall be installed into the studs 4-1/2 in. (114 mm) below the lower surface of the floor or roof deck.
3. **Joint System** – Max separation between bottom of floor or roof and top of wall is 2 in. (51 mm). The joint system is designed to accommodate a max 25 percent compression or extension from its installed width. The joint system consists of an optional deflection channel, forming material and a fill material, as follows:

A. Deflection Channel – (Optional, Not Shown) – A nom 3-5/8 in. (92 mm) wide by 3 in. (76 mm) deep min 24 gauge steel U-shaped channel. Deflection channel installed perpendicular to direction of fluted steel deck and secured to valleys with steel masonry anchors or by welds spaced max 24 in. (610 mm) OC. When optional spray- applied fire resistive material is used on the steel deck, deflection channel secured through spray-applied material to each valley of steel deck with min 1-1/2 in. (38 mm) long by min 3/16 in. (5 mm) diam steel masonry anchors spaced max 12 in. (305 mm) OC . The ceiling runner (Item 2A) is installed within the deflection channel to maintain a 2 in. (51 mm) gap between the top of the ceiling runner and the top of the deflection channel. The ceiling runner is not fastened to the deflection channel.

B. Forming Material* – Min 4 pcf (64 kg/m³) density mineral wool batt insulation cut to the shape of the fluted deck, approximately 20 percent larger than the area of the flutes, with a length equal to the overall thickness of the wall. Insulation compressed into flutes of the steel floor or roof deck above the top of the deflection channel or ceiling runner with the ends flush with the surfaces of the wall. Additional 1-1/4 in. (32 mm) wide sections of mineral wool batt insulation are compressed 50 percent in thickness and installed cut edge first to completely fill the gap above the top of the gypsum board. The forming material shall be installed flush with both surfaces of wall.

INDUSTRIAL INSULATION GROUP L L C – MinWool-1200 Safing

ROCK WOOL MANUFACTURING CO – Delta Board or Delta-8

ROCKWOOL MALAYSIA SDN BHD – Type Safe

ROCKWOOL – Type Safe

THERMAFIBER INC – Type SAF

C. Fill, Void or Cavity Material* – Min 1/16 in. (1.6 mm) dry thickness (1/8 in. or 3.2 mm wet thickness) of fill material sprayed or brushed on each side of the wall in the flutes of the steel floor or roof deck and between the top of the gypsum board and the bottom of the steel floor or roof deck to completely cover mineral wool and overlap a min of 1/2 in. (13 mm) onto gypsum board and steel deck on both sides of wall. When the steel deck is coated with spray applied material, the fill material shall overlap min 2 in. (51 mm) onto the spray applied material.

3M COMPANY – FireDam™ Spray 200

C1. Fill, Void or Cavity Material* – Tape – As an alternate to Item C, Tape cut to size and press applied within fluted areas of joint to completely cover mineral wool lapping min 1 in. (25 mm) onto the contour of the steel floor units and extending to lap min 1 in. (25 mm) onto the gypsum wall. Additional pieces of Tape are applied along the joint to completely cover the remaining mineral wool between bottom of steel deck and top edge of wall along length of joint, lapping min 1 in. (25 mm) onto the contour of the steel floor units and gypsum wall. When the steel deck is coated with spray applied material, the Tape shall overlap min 2 in. (51 mm) onto the spray applied material. Adjoining lengths of Tape shall overlap min 1/2 in. (13 mm). Tape shall be applied at both sides of wall.

3M COMPANY – 3M Fire and Water Barrier Tape

L Ratings apply only when FireDam™ Spray 200 is used.

D. Isolation Pad – (Optional, Not Shown) – As an option, max 1/2 in. (13 mm) thick molded high density glass fiber isolation pads may be installed between the deflection channel (Item 3A) and the steel floor or roof deck for sound control purposes. The isolation pad shall be cut to the width of the deflection channel and shall be installed along the entire length of the wall. When the isolation pad is used, the deflection channel shall be secured to the steel deck, through the isolation pad, with mechanical fasteners in conjunction with steel fender washers and neoprene isolation grommets supplied by the maker of the isolation pad material.



*Indicates such products shall bear the UL or cUL Certification Mark for jurisdictions employing the UL or cUL Certification (such as Canada), respectively.

Reprinted from the Online Certifications Directory with permission from UL©

UL System No. HW-D-0038

January 17, 2017

ANSI/UL2079

Assembly Rating – 2 Hr
 Nominal Joint Width – 2 in.
 Class II Movement Capabilities – 19% Compression or Extension
 L Rating At Ambient – Less Than 1 CFM/lin ft
 L Rating At 400°F – Less Than 1 CFM/lin ft

CAN/ULC S115

F Rating – 2 Hr
 FT Rating – 2 Hr
 FH Rating – 2 Hr
 FTH Rating – 2 Hr
 Nominal Joint Width – 51 mm
 Class II Movement Capabilities – 19% Compression or Extension
 L Rating at Ambient – Less than 1.55 L/s/lin m
 L Rating at 204°C – Less than 1.55 L/s/lin m

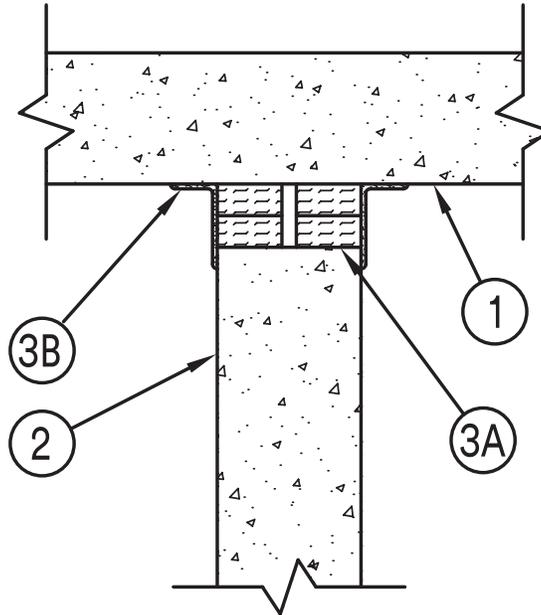

SECTION A-A

1. **Floor Assembly** – Min 4-1/2 in. (114 mm) thick steel-reinforced lightweight or normal weight (100-150 pcf or 1600-2400 kg/m³) structural concrete.
2. **Wall Assembly** – Min 7-1/2 in. (191 mm) thick lightweight or normal weight (100-150 pcf or 1600-2400 kg/m³) concrete. Wall may also be constructed of any UL Classified **Concrete Blocks**.
 See **Concrete Blocks** (CAZT) category in the Fire Resistance Directory for names of manufacturers.
3. **Joint System** – Max separation between bottom of floor and top of wall is 2 in. (51 mm). The joint system is designed to accommodate a max 19 percent compression or extension from its installed width. The joint system consists of a forming material and a fill material, as follows:
 - A. **Forming Material*** – Min 3 in. (76 mm) thick, min 4 pcf (64 kg/m³) mineral wool batt insulation compressed and firmly packed into the gap between the top of the wall and bottom of the floor on both sides of the wall. Pieces of batt to be cut to min width of twice the nom joint width and installed vertically, such that the batt sections are compressed min 50 percent and installed flush with both surfaces of wall.
INDUSTRIAL INSULATION GROUP LLC – MinWool-1200 Safing
ROCK WOOL MANUFACTURING CO – Delta Safing Board
ROCKWOOL MALAYSIA SDN BHD – Type Safe
ROXUL INC – Type Safe
THERMAFIBER INC – Type SAF
 - B. **Fill, Void or Cavity Material*** – Min 1/16 in. (1.6 mm) dry thickness (min 1/8 in. or 3.2 mm wet thickness) of fill material sprayed or brushed on each side of the wall between the top of the wall and the bottom of the floor to completely cover mineral wool and overlap a min of 1/2 in. (13 mm) onto wall and floor on both sides of wall.
3M COMPANY – FireDam™ Spray 200
 - B1. **Fill, Void or Cavity Material* – Tape** – As an alternate to Item B, Tape cut to size and press applied along length of joint to completely cover mineral wool and lap min 1 in. (25 mm) onto the concrete floor and wall. Tape shall be applied in min 1 ft (305 mm) lengths along joint and adjoining lengths of Tape shall overlap min 1/2 in. (13 mm). Tape shall be applied at both sides of wall.
3M COMPANY – 3M Fire and Water Barrier Tape

*Indicates such products shall bear the UL or cUL Certification Mark for jurisdictions employing the UL or cUL Certification (such as Canada), respectively. 

Reprinted from the Online Certifications Directory with permission from UL©



UL System No. HW-D-0040
XHBN - Joint Systems
XHBN7 - Joint Systems Certified for Canada

January 23, 2018

| ANSI/UL2079 | CAN/ULC S115 |
|---|---|
| Assembly Rating – 2 Hr | F Rating – 2 Hr |
| Nominal Joint Width - 2 In. | FT Rating – 2 Hr |
| Class II Movement Capabilities – 19% Compression or Extension | FH Rating – 2 Hr |
| L Rating At Ambient – Less Than 1 CFM/lin ft (See Item 3B) | FTH Rating – 2 Hr |
| L Rating At 400 F – Less Than 1 CFM/lin ft (See Item 3B) | Nominal Joint Width – 51 mm |
| | Class II Movement Capabilities – 19% Compression or Extension |
| | L Rating At Ambient – Less Than 1.55 L/s/lin m (See Item 3B) |
| | L Rating At 204°C – Less Than 1.55 L/s/lin m (See Item 3B) |

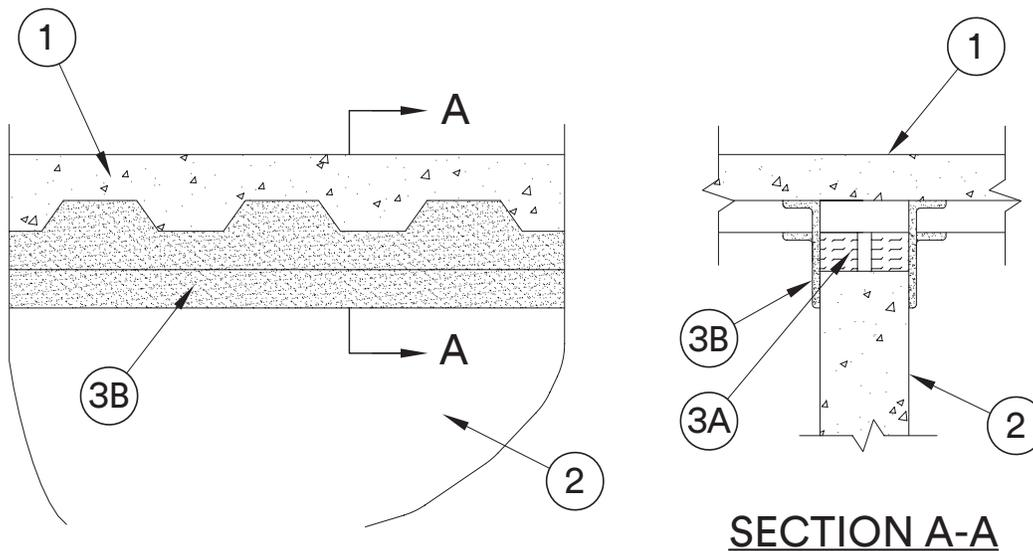

- Floor Assembly** – The fluted steel deck/concrete floor assembly shall be constructed of the materials and in the manner described in the individual Floor-Ceiling Design in the UL Fire Resistance Directory and shall include the following construction features:
 - Steel Floor and Form Units*** – Max 3 in. (76 mm) deep galv fluted units.
 - Spray Applied Fire Resistant Material*** – (Optional, not shown) – Prior to the installation of the Forming Material and Fill, Void or Cavity Materials (Items 3A, 3B), the steel floor units may be sprayed with a min 5/16 in. (8 mm) to max 11/16 in. (17 mm) thickness of fire resistive material.

GCP APPLIED TECHNOLOGIES INC – Type MK-6/HY.
 - Concrete** – Min 2-1/2 in. (64 mm) thick reinforced concrete, as measured from the top plane of the floor units.
- Wall Assembly** – Min 7-1/2 in. (191 mm) thick lightweight or normal weight (100-150 pcf or 1600-2400 kg/m³) concrete. Wall may also be constructed of any UL Classified Concrete Blocks.

See **Concrete Blocks** (CAZT) category in the Fire Resistance Directory for names of manufacturers.
- Joint System** – Max separation between bottom of floor and top of wall is 2 in. (51 mm). The joint system is designed to accommodate a max 19 percent compression or extension from its installed width. The joint system consists of a forming material and a fill material, as follows:
 - Forming Material*** – Min 4 pcf (64 kg/m³) mineral wool batt insulation compressed and firmly packed into the flutes and the gap between the top of the wall and bottom of the floor on both sides of the wall. Pieces of batt to be cut a min thickness of 3 in. (76 mm) to the shape of the deck approximately 25 percent larger than the area of the flutes with additional min 4 in. (102 mm) wide sections of a thickness at least 50 percent larger than gap between the top of the wall and bottom of the steel floor units. Mineral wool to be compressed and firmly packed into the flutes and compressed in thickness and inserted edge first into the gap between the top of the wall and bottom of the steel floor units, flush with both sides of wall.

Construction Joints

Head of Wall

HWD

UL System No. HW-D-0040 (cont.)

INDUSTRIAL INSULATION GROUP LLC – MinWool-1200 Safing

ROCK WOOL MANUFACTURING CO – Delta Safing Board

ROCKWOOL MALAYSIA SDN BHD – Type Safe

ROCKWOOL – Type Safe

THERMAFIBER INC – Type SAF

- B. Fill, Void or Cavity Material*** – Min 1/16 in. (1.6 mm) dry thickness (min 1/8 in. or 3.2 mm wet thickness) of fill material sprayed or brushed on each side of the wall in the flutes of the steel floor units and between the top of the wall and the bottom of the floor to completely cover mineral wool and overlap a min of 1/2 in. (13 mm) onto wall and floor on both sides of wall. When the steel deck is coated with spray applied material (Item A1), the fill material shall overlap min 2 in. (51 mm) onto the spray applied material.

3M COMPANY – FireDam Spray 200

- B1. Fill, Void or Cavity Material* – Tape** – As an alternate to Item B, Tape cut to size and press applied within fluted areas of joint to completely cover mineral wool lapping min 1 in. (25 mm) onto the contour of the steel floor units and extending to lap min 1 in. (25 mm) onto the concrete wall. Additional pieces of Tape are applied along the joint to completely cover the remaining mineral wool between bottom of steel deck and top edge of wall along length of joint, lapping min 1 in. (25 mm) onto the contour of the steel floor units and concrete wall. When the steel deck is coated with spray applied material (Item 1A1), the Tape shall overlap min 2 in. (51 mm) onto the spray applied material. Adjoining lengths of Tape shall overlap min 1/2 in. (13 mm). Tape shall be applied at both sides of wall.

3M COMPANY – 3M Fire and Water Barrier Tape

Construction Joints

Head of Wall

HW-D



L Ratings apply only when FireDam™ Spray 200 is used.

*Indicates such products shall bear the UL or cUL Certification Mark for jurisdictions employing the UL or cUL Certification (such as Canada), respectively.

Reprinted from the Online Certifications Directory with permission from UL©

3M Industrial Adhesives and Tapes
Fire Protection Products
3M Center, Building 230-B-S-37
St. Paul, MN 55144-1000

System No. HW-D-0060

May 27, 2014

ANSI/UL2079

Assembly Ratings — 1, 2 and 3 Hr (See Item 2)

Nominal Joint Width - 1 In.

Class II or III Movement Capabilities —
100% Compression or Extension

CAN/ULC S115

F Ratings — 1, 2 and 3 Hr (See Item 2)

FT Ratings — 1, 2 and 3 Hr (See Item 2)

FH Ratings — 1, 2 and 3 Hr (See Item 2)

FTH Ratings — 1, 2 and 3 Hr (See Item 2)

Nominal Joint Width - 1 In.

Class II or III Movement Capabilities — 100% Compression or Extension

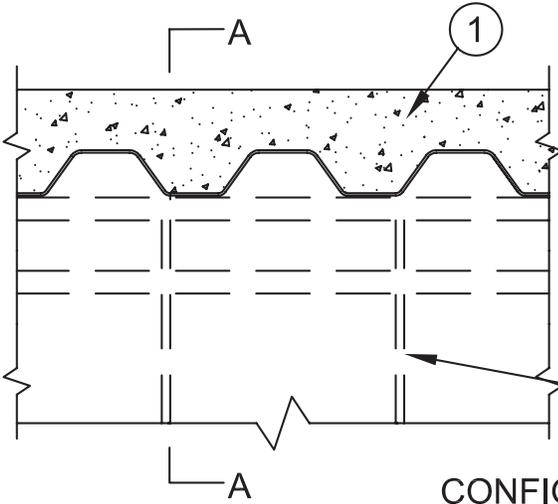

CONFIGURATION A

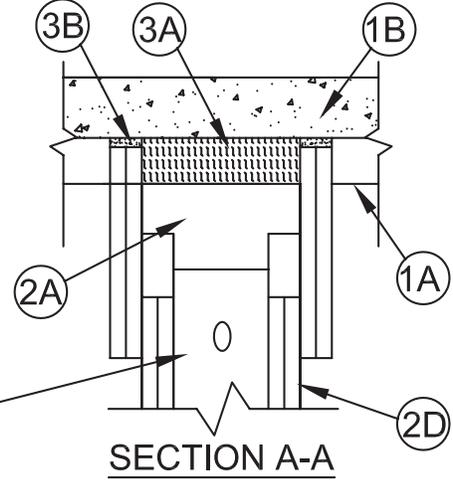

SECTION A-A

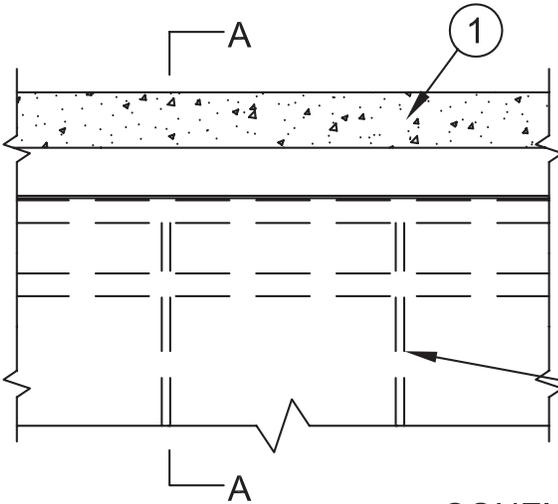

CONFIGURATION B

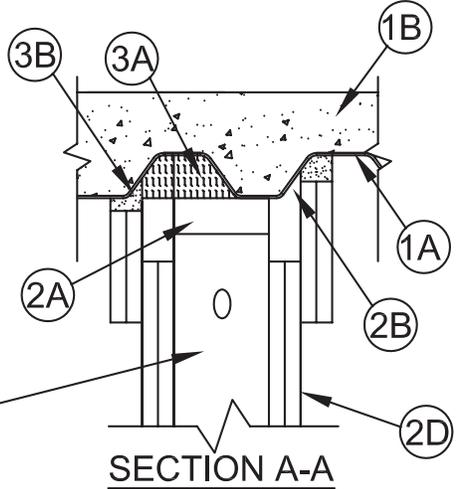

SECTION A-A

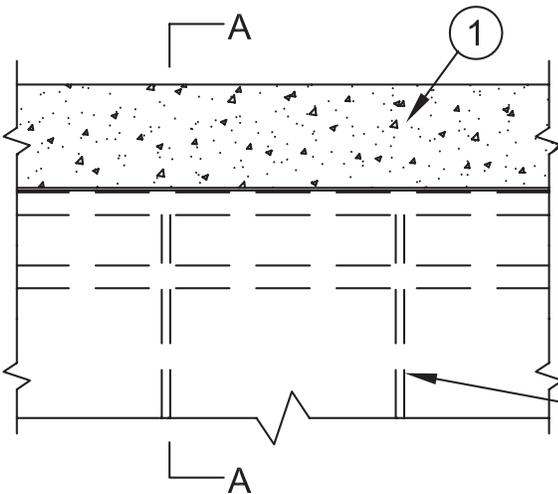

CONFIGURATION C

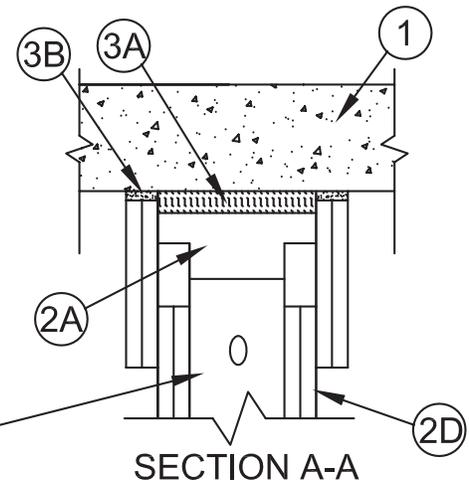

SECTION A-A

Construction Joints

Head of Wall

HWD

System No. HW-D-0060 *continued*

Construction Joints

Head of Wall

1. **Floor Assembly** — The fire-rated fluted steel deck/concrete floor assembly shall be constructed of the materials and in the manner described in the individual Floor-Ceiling Design in the UL Fire Resistance Directory. The hourly fire rating of the floor assembly shall be equal to or greater than the hourly fire rating of the wall assembly. The floor assembly shall include the following construction features:
 - A. **Steel Floor and Form Units*** — Max 3 in. (76 mm) deep galv fluted floor units.
 - B. **Concrete** — Min 2-1/2 in. (64 mm) thick reinforced (100-150 pcf or 1600-2400 kg/m³) concrete, as measured from the top plane of the floor units.
- 1A. **Roof Assembly** — As an alternate to Item 1, the fire-rated roof assembly shall be constructed of the materials and in the manner described in the individual P700, P800 or P900 series Roof-Ceiling Designs in the UL Fire Resistance Directory and shall contain max 3 in. (76 mm) deep galv steel fluted roof units. The hourly fire rating of the roof assembly shall be equal to or greater than the hourly fire rating of the wall assembly. In the case of spray-applied protection materials on the steel roof units, the joint system shall be installed prior to the spray-applied protection material.
- 1B. **Floor Assembly** — As an alternate to Item 1, min 4-1/2 in. (114 mm) thick reinforced lightweight or normal weight (100-150 pcf or 1600-2400 kg/m³) structural concrete or any min 6 in. (152 mm) thick UL Classified hollow-core **Precast Concrete Units***.
See **Precast Concrete Units** (CFTV) category in the Fire Resistance Directory for names of manufactures.
2. **Wall Assembly** — The 1, 2 or 3 hr fire-rated gypsum board /steel stud wall assembly shall be constructed of the materials and in the manner described in the individual U400, V400 or W400-Series Wall and Partition Design in the UL Fire Resistance Directory and shall include the following construction features:

- A. **Light Gauge Framing* - Deflection Trak** — Deflection trak of wall assembly shall consist of min No. 25 gauge galv steel channels sized to accommodate steel studs (Item 2C) and with offset legs to accommodate wall cladding (Item 3A). Deflection trak installed parallel or perpendicular to the floor units. When installed perpendicular (Configuration A), min No. 25 gauge deflection trak secured on both sides to valley of floor units with 1-1/2 in. (38 mm) long welds spaced max 12 in. (305 mm) OC. Min No. 20 gauge deflection trak may be secured with steel fasteners spaced 12 in. (305 mm) OC. When installed parallel (Configuration B), min No. 25 gauge deflection trak secured on one side to valley of floor units with 1-1/2 in. (38 mm) long welds spaced 12 in. (305 mm) OC. Min No. 20 gauge deflection trak may be secured with steel fasteners spaced max 12 in. (305 mm) OC. The other side of the deflection trak is secured to Z-Furring clips (Item 2B) with two No. 8 by 1/2 in. (13 mm) long tec screws. On concrete floor (Configuration C), min No. 20 gauge deflection trak attached to concrete at ceiling with steel fasteners spaced max 12 in. (305 mm) OC.

FIRE TRAK CORP — Shadowline

- B. **Z-Furring - (Parallel Units)** — When trak is installed parallel to floor units, Z-Furring clips are attached to the bottom of the floor units within the crests with two steel fasteners. Clip spacing not to exceed 24 in. (610 mm) OC.
- C. **Studs** — Steel studs to be min 2-1/2 in. (64 mm) wide and as specified in the individual Wall and Partition Design in the UL Fire Resistance Directory. Studs cut 1-1/2 in. (38 mm) less in length than the assembly height with bottom nesting in and resting on floor runner and with top nesting in ceiling runner without attachment. Stud spacing not to exceed 24 in. (610 mm) OC.
- D. **Gypsum Board*** — Gypsum board sheets installed and attached to studs and runners as specified in the individual Wall and Partition Design in the UL Fire Resistance Directory, except that a nominal 1 in. (25 mm) gap shall be maintained between top of the gypsum board and the bottom flange of the deflection trak. Top row of screws shall be installed into the studs 3 in. (76 mm) below the top edge of the gypsum board sheets.

The hourly assembly rating of the joint system is equal to the fire rating of the wall.

Firestop Configuration A

3. **Joint System** — **Max separation between bottom flange of the deflection trak and top of wallboard (at the time of installation of the joint system) is 1 in. (25 mm). The joint system is designed to accommodate a max 100 percent compression or extension from its installed width.** The joint system consists of packing material (Item 3A), wall cladding (Item 3B) and a fill material (Item 3C) as follows:
 - A. **Packing Material** — Min 4 pcf (64 kg/m³) density mineral wool batt insulation cut to the shape of the fluted deck, 25 percent larger than the area of the flutes and compressed into the flutes of the steel floor units above the ceiling runner as a permanent form.
 - B. **Wall Cladding** — Strips of the gypsum board material cut to the contour of the steel floor units and attached to the deflection trak. The number of layers, board type and thickness and fastener type shall be as specified for the gypsum board in the individual Wall and Partition Design in the UL Fire Resistance Directory. Fasteners shall be max spaced 3 in. (76 mm) OC. The top of the wall cladding shall be recessed min 1/8 in. (3.2 mm) to max 1/2 in. (13 mm) from the steel floor units and overlap the gypsum board 4 in. (102 mm).
 - C. **Fill, Void or Cavity Material*** — Full depth of fill material installed on each side of the wall between the top of the wall cladding and the surface of the steel floor units, flush with each surface of the cladding.

3M COMPANY — FB 1000NS, FB 2000, FB 2000+, FD-150+, CP 25 WB+

Firestop Configuration B

3. **Joint System** — **Max separation between bottom flange of the deflection trak and top of wallboard (at the time of installation of the joint system) is 1 in. (25 mm). The joint system is designed to accommodate a max 100 percent compression or extension from its installed width.** The joint system consists of packing material (Item 3A), wall cladding (Item 3B) and a fill material (Item 3C) as follows:
 - A. **Wall Cladding** — Strips of the gypsum board material attached to the deflection trak. The number of layers, board type and thickness and fastener type shall be as specified for the gypsum board in the individual Wall and Partition Design in the UL Fire Resistance Directory. Fasteners shall be max spaced 3 in. (76 mm) OC. The top of the wall cladding shall be recessed min 1/8 in. (3.2 mm) to max 1/2 in. (13 mm) from the steel floor units and overlap the gypsum board 4 in. (102 mm).
 - B. **Fill, Void or Cavity Material*** — Full depth of fill material installed on each side of the wall between the top of the wall cladding and the surface of the steel floor units, flush with each surface of the cladding.

3M COMPANY — FB 1000NS, FB 2000, FB 2000+, FD-150+, CP 25 WB+

HW-D

System No. HW-D-0060 *continued*

Firestop Configuration C

3. **Joint System** — Max separation between bottom flange of the deflection trak and top of wallboard (at the time of installation of the joint system) is 1 in. (25 mm). The joint system is designed to accommodate a max 100 percent compression or extension from its installed width. The joint system consists of packing material (Item 3A), wall cladding (Item 3B) and a fill material (Item 3C) as follows:
- A. **Wall Cladding** — Strips of the gypsum board material attached to the deflection trak. The number of layers, board type and thickness and fastener type shall be as specified for the gypsum board in the individual Wall and Partition Design in the UL Fire Resistance Directory. Fasteners shall be max spaced 3 in. (76 mm) OC. The top of the wall cladding shall be recessed min 1/8 in. (3.2 mm) to max 1/2 in. (13 mm) from the bottom of the concrete floor and overlap the gypsum board 4 in. (102 mm).
 - B. **Fill, Void or Cavity Material*** — Full depth of fill material installed on each side of the wall between the top of the wall cladding and the bottom of the concrete floor, flush with each surface of the cladding.

3M COMPANY — FB 1000NS, FB 2000, FB 2000+, FD-150+, CP 25 WB+

*Bearing the UL Classification Mark

Reprinted from the Online Certifications Directory with permission from UL
© 2014 UL LLC



System No. HW-D-0061

February 19, 2014

ANSI/UL2079

Assembly Ratings — 1, 2 and 3 Hr (See Item 2)

Nominal Joint Width - 1 In.

Class II or III Movement Capabilities —
100% Compression or Extension

CAN/ULC S115

F Ratings — 1, 2 and 3 Hr (See Item 2)

FT Ratings — 1, 2 and 3 Hr (See Item 2)

FH Ratings — 1, 2 and 3 Hr (See Item 2)

FTH Ratings — 1, 2 and 3 Hr (See Item 2)

Nominal Joint Width - 1 In.

Class II or III Movement Capabilities — 100% Compression or Extension

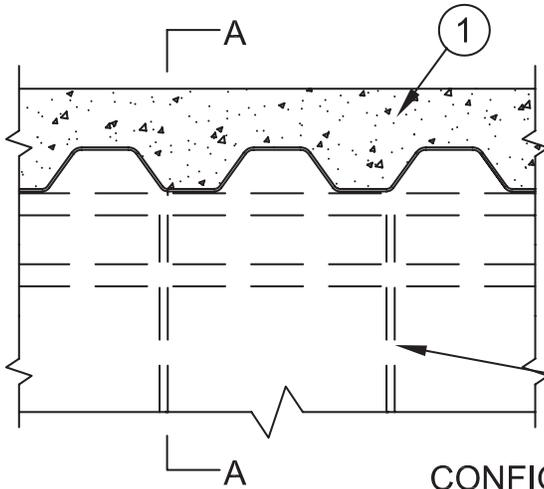

CONFIGURATION A

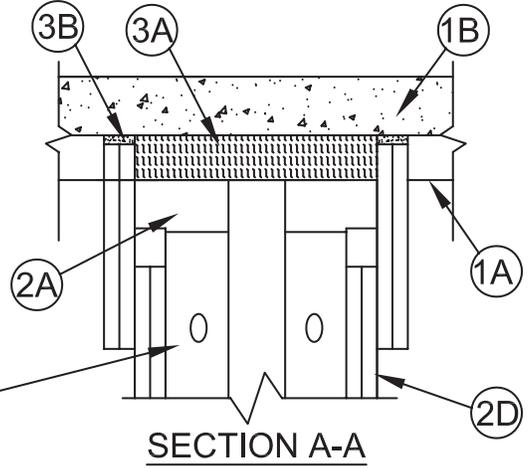

SECTION A-A

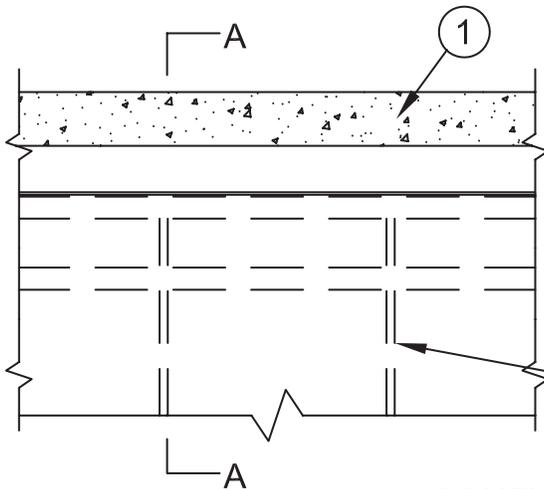

CONFIGURATION B

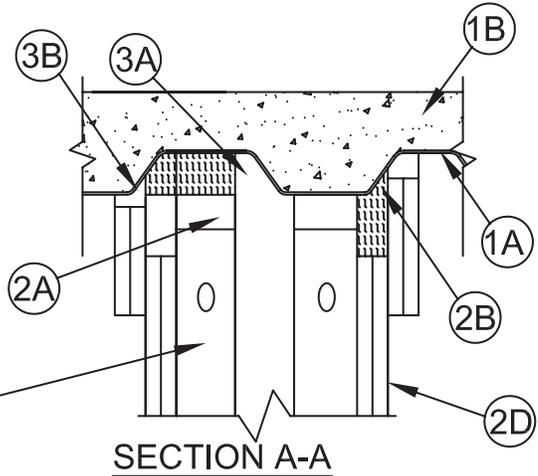

SECTION A-A

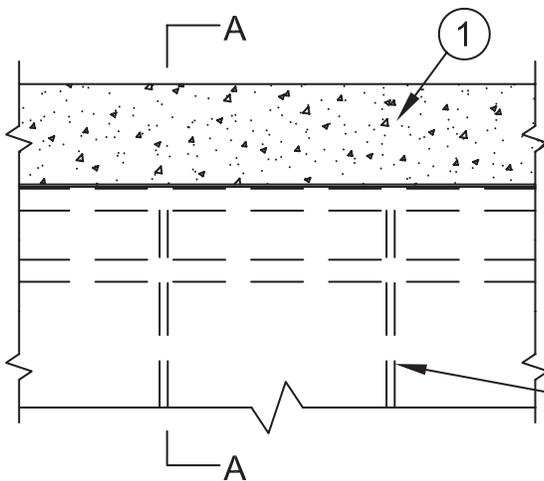

CONFIGURATION C

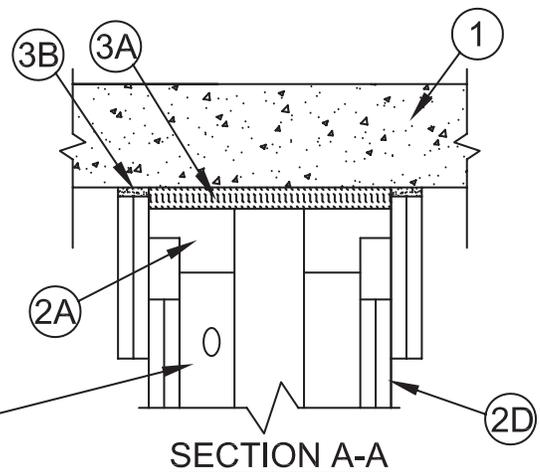

SECTION A-A

System No. HW-D-0061 *continued*

Construction Joints

Head of Wall

1. **Floor Assembly** — The fire-rated fluted steel deck/concrete floor assembly shall be constructed of the materials and in the manner described in the individual Floor-Ceiling Design in the UL Fire Resistance Directory. The hourly fire rating of the floor assembly shall be equal to or greater than the hourly fire rating of the wall assembly. The floor assembly shall include the following construction features:
 - A. **Steel Floor and Form Units*** — Max 3 in. (76 mm) deep galv fluted floor units.
 - B. **Concrete** — Min 2-1/2 in. (64 mm) thick reinforced (100-150 pcf or 1600-2400 kg/m³) concrete, as measured from the top plane of the floor units.
- 1A. **Roof Assembly** — As an alternate to Item 1, the fire-rated roof assembly shall be constructed of the materials and in the manner described in the individual P700, P800 or P900 series Roof-Ceiling Designs in the UL Fire Resistance Directory and shall contain max 3 in. (76 mm) deep galv steel fluted roof units. The hourly fire rating of the roof assembly shall be equal to or greater than the hourly fire rating of the wall assembly. In the case of spray-applied protection materials on the steel roof units, the joint system shall be installed prior to the spray-applied protection material.
- 1B. **Floor Assembly** — As an alternate to Item 1, min 4-1/2 in. (114 mm) thick reinforced lightweight or normal weight (100-150 pcf or 1600-2400 kg/m³) structural concrete or any min 6 in. (152 mm) thick UL Classified hollow-core **Precast Concrete Units***.
See **Precast Concrete Units (CFTV)** category in the Fire Resistance Directory for names of manufactures.
2. **Wall Assembly** — The 1, 2 or 3 hr fire-rated gypsum board /steel stud wall assembly shall be constructed of the materials and in the manner described in the individual U400, V400 or W400-Series Wall and Partition Design in the UL Fire Resistance Directory and shall include the following construction features:
 - A. **Light Gauge Framing* - Deflection Trak** — Deflection trak of wall assembly shall consist of min No. 25 gauge galv steel channels sized to accommodate steel studs (Item 2C) and with offset legs to accommodate wall cladding (Item 3A). Deflection trak installed parallel or perpendicular to the floor units. When installed perpendicular (Configuration A), min No. 25 gauge deflection trak secured on both sides to valley of floor units with 1-1/2 in. (38 mm) long welds spaced max 12 in. (305 mm) OC. Min No. 20 gauge deflection trak may be secured with steel fasteners spaced 12 in. (305 mm) OC. When installed parallel (Configuration B), min No. 25 gauge deflection trak secured on one side to valley of floor units with 1-1/2 in. (38 mm) long welds spaced 12 in. (305 mm) OC. Min No. 20 gauge deflection trak may be secured with steel fasteners spaced max 12 in. (305 mm) OC. The other side of the deflection trak is secured to Z-Furring clips (Item 2B) with two No. 8 by 1/2 in. (13 mm) long tec screws. On concrete floor (Configuration C), min No. 20 gauge deflection trak attached to concrete at ceiling with steel fasteners spaced max 12 in. (305 mm) OC.
FIRE TRAK CORP — Shadowline, Cavity Shadowline
 - B. **Z-Furring - (Parallel Units)** — When trak is installed parallel to floor units, Z-Furring clips are attached to the bottom of the floor units within the crests with two steel fasteners. Clip spacing not to exceed 24 in. (610 mm) OC.
FIRE TRAK CORP — Z-Furring Clips
 - C. **Studs** — Steel studs to be min 2-1/2 in. (64 mm) wide and as specified in the individual Wall and Partition Design in the UL Fire Resistance Directory. Studs cut 1-1/2 in. (38 mm) less in length than the assembly height with bottom nesting in and resting on floor runner and with top nesting in ceiling runner without attachment. Stud spacing not to exceed 24 in. OC.
 - D. **Gypsum Board*** — Gypsum board sheets installed and attached to studs and runners as specified in the individual Wall and Partition Design in the UL Fire Resistance Directory, except that a nominal 1 in. (25 mm) gap shall be maintained between top of the gypsum board and the bottom flange of the deflection trak. Top row of screws shall be installed into the studs 3 in. (76 mm) below the top edge of the gypsum board sheets.
 - E. **Bracing** — (Not Shown) - Bracing as specified in the individual Wall and Partition Design in the UL Fire Resistance Directory.

The hourly assembly rating of the joint system is equal to the fire rating of the wall.

Firestop Configuration A

3. **Joint System** — **Max separation between bottom flange of the deflection trak and top of wallboard (at the time of installation of the joint system) is 1 in. (25 mm). The joint system is designed to accommodate a max 100 percent compression or extension from its installed width.** The joint system consists of packing material (Item 3A), wall cladding (Item 3B) and a fill material (Item 3C) as follows:
 - A. **Packing Material** — Min 4 pcf (65 kg/m³) density mineral wool batt insulation cut to the shape of the fluted deck, 25 percent larger than the area of the flutes and compressed into the flutes of the steel floor units above the ceiling runner as a permanent form.
 - B. **Wall Cladding** — Strips of the gypsum board material cut to the contour of the steel floor units and attached to the deflection trak. The number of layers, board type and thickness and fastener type shall be as specified for the gypsum board in the individual Wall and Partition Design in the UL Fire Resistance Directory. Fasteners shall be max spaced 3 in. (76 mm) OC. The top of the wall cladding shall be recessed min 1/8 in. (3.2 mm) to max 1/2 in. (13 mm) from the steel floor units and overlap the gypsum board 4 in. (102 mm).
 - C. **Fill, Void or Cavity Material*** — Full depth of fill material installed on each side of the wall between the top of the wall cladding and the surface of the steel floor units, flush with each surface of the cladding.
3M COMPANY — FB 1000NS, FB 2000, FB 2000+, FD-150+, CP 25 WB+

Firestop Configuration B

3. **Joint System** — **Max separation between bottom flange of the deflection trak and top of wallboard (at the time of installation of the joint system) is 1 in. (25 mm). The joint system is designed to accommodate a max 100 percent compression or extension from its installed width.** The joint system consists of packing material (Item 3A), wall cladding (Item 3B) and a fill material (Item 3C) as follows:
 - A. **Wall Cladding** — Strips of the gypsum board material attached to the deflection trak. The number of layers, board type and thickness and fastener type shall be as specified for the gypsum board in the individual Wall and Partition Design in the UL Fire Resistance Directory. Fasteners shall be max spaced 3 in. (76 mm) OC. The top of the wall cladding shall be recessed min 1/8 in. (3.2 mm) to max 1/2 in. (13 mm) from the steel floor units and overlap the gypsum board 4 in. (102 mm).
 - B. **Fill, Void or Cavity Material*** — Full depth of fill material installed on each side of the wall between the top of the wall cladding and the surface of the steel floor units, flush with each surface of the cladding.
3M COMPANY — FB 1000NS, FB 2000, FB 2000+, FD-150+, CP 25 WB+

HW-D

System No. HW-D-0061 *continued*

Firestop Configuration C

3. **Joint System** — Max separation between bottom flange of the deflection trak and top of wallboard (at the time of installation of the joint system) is 1 in. (25 mm). The joint system is designed to accommodate a max 100 percent compression or extension from its installed width. The joint system consists of packing material (Item 3A), wall cladding (Item 3B) and a fill material (Item 3C) as follows:
- A. **Wall Cladding** — Strips of the gypsum board material attached to the deflection trak. The number of layers, board type and thickness and fastener type shall be as specified for the gypsum board in the individual Wall and Partition Design in the UL Fire Resistance Directory. Fasteners shall be max spaced 3 in. (76 mm) OC. The top of the wall cladding shall be recessed min 1/8 in. (3.2 mm) to max 1/2 in. (13 mm) from the bottom of the concrete floor and overlap the gypsum board 4 in. (102 mm).
 - B. **Fill, Void or Cavity Material*** — Full depth of fill material installed on each side of the wall between the top of the wall cladding and the surface of the steel floor units, flush with each surface of the cladding.

3M COMPANY — FB 1000NS, FB 2000, FB 2000+, FD-150+, CP 25 WB+

*Bearing the UL Classification Mark

Reprinted from the Online Certifications Directory with permission from UL
© 2014 UL LLC



System No. HW-D-0075

April 22, 2011

Assembly Rating – 4 Hr

Nominal Joint Width – 2 In.

Class II Movement Capabilities – 10.9% Compression or Extension

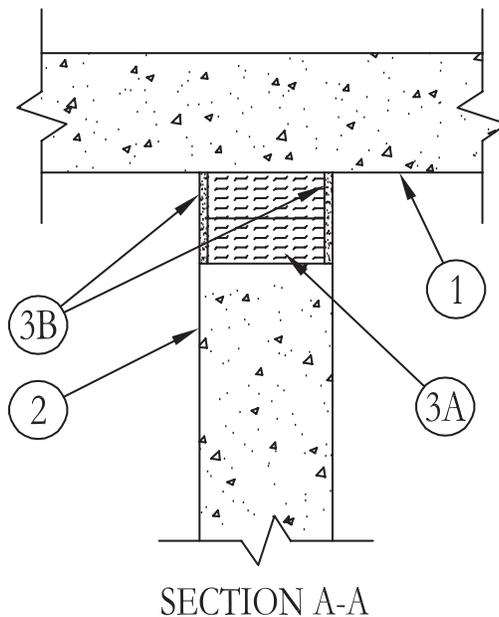

1. **Floor Assembly** – Min 5-1/2 in. thick steel-reinforced lightweight or normal weight (100-150 pcf) structural concrete.
2. **Wall Assembly** – Min 6 in. thick steel-reinforced lightweight or normal weight (100-150 pcf) structural concrete. Wall may also be constructed of any UL Classified **Concrete Blocks***.
3. **Joint System** – **Max width of joint (at time of installation of joint system) is 2 in. The joint system is designed to accommodate a max 10.9 percent compression or extension from its installed width.** The joint system shall consist of the following:
 - A. **Forming Material*** – Min 4.0 pcf mineral wool batt insulation installed in joint opening as a permanent form. Batt cut to min width of 5 in. and installed edge-first into joint opening, parallel with joint direction, such that batt sections are compressed min 50 percent in thickness and such that the compressed batt sections are recessed from both surfaces of wall to accommodate the required thickness of fill material. Adjoining lengths of batt to be tightly-butteted with butted seams spaced min 48 in. apart along the length of the joint. –
ROCK WOOL MANUFACTURING CO – Delta Safing Board
ROCKWOOL MALAYSIA SDN BHD – Type Safe
ROXUL INC – Type Safe
THERMAFIBER INC – Type SAF
 - B. **Fill, Void or Cavity Material*** – Min 1/2 in. thickness of fill material applied within the joint, flush with both surfaces of wall.
3M COMPANY – FB 2000+

*Bearing the UL Classification Mark

Reprinted from the Online Certifications Directory with permission from Underwriters Laboratories Inc.
 Copyright © 2011 Underwriters Laboratories Inc.®



UL System No. HW-D-0101

January 17, 2017

ANSI/UL2079

Assembly Ratings – 1 and 2 Hr (See Item 2)
 Nominal Joint Width – 1 in.
 Class II Movement Capabilities – 25% Compression or Extension
 L Rating At Ambient – Less Than 1 CFM/Lin Ft
 L Rating At 400°F – Less Than 1 CFM/Lin Ft

CAN/ULC S115

F Ratings – 1 and 2 Hr (See Item 2)
 FT Ratings – 1 and 2 Hr (See Item 2)
 FH Ratings – 1 and 2 Hr (See Item 2B)
 FTH Ratings – 1 and 2 Hr (See Item 2)
 Nominal Joint Width – 25 mm
 Class II Movement Capabilities – 25% Compression or Extension
 L Rating at Ambient – Less than 1.55 L/s/lin m
 L Rating at 204°C – Less than 1.55 L/s/lin m

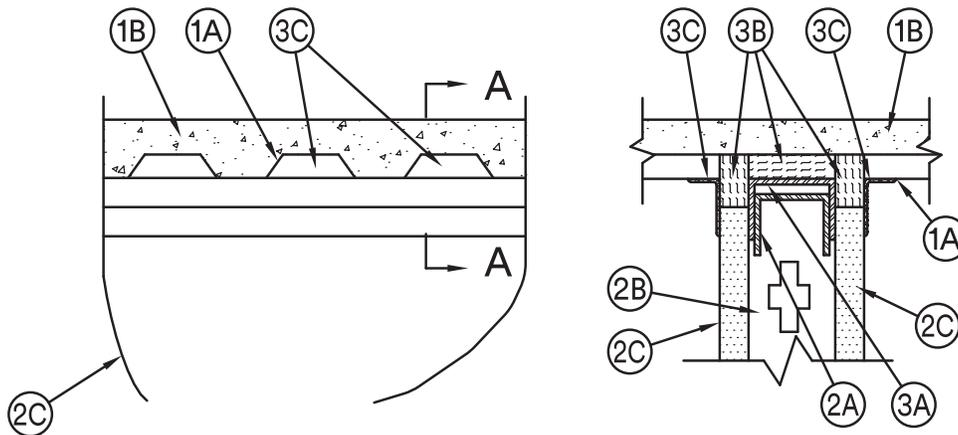

SECTION A-A

1. **Floor Assembly** – The fire-rated fluted steel deck/concrete floor assembly shall be constructed of the materials and in the manner described in the individual Floor-Ceiling Design in the UL Fire Resistance Directory and shall include the following construction features:
 - A. **Steel Floor and Form Units*** – Max 3 in. (76 mm) deep galv steel fluted units.
 - B. **Concrete** – Min 2-1/2 in. (64 mm) thick reinforced concrete, as measured from the top plane of the floor units.
2. **Wall Assembly** – The 1 hr or 2 fire rated gypsum board/steel stud wall assembly shall be constructed of the materials and in the manner described in the individual U400 or V400 Series Wall and Partition Designs in the UL Fire Resistance Directory and shall include the following construction features:

- A. **Steel Floor and Ceiling Runners** – Floor and ceiling runners of wall assembly shall consist of galv steel channels sized to accommodate steel studs (Item 2B). When deflection channel (Item 3A) is used, ceiling runner to be installed within the deflection channel with 1 in. (25 mm) gap maintained between the top of ceiling runner and top of deflection channel. When deflection channel is not used, flange height of ceiling runner shall be min 3/4 in. (19 mm) greater than nom joint width. Ceiling runner installed perpendicular to direction of fluted steel deck and secured with steel masonry anchors or by welds spaced max 24 in. (610 mm) OC.

- A1. **Light Gauge Framing* – Slotted Ceiling Runner** – As an alternate to the ceiling runner in Item 2A, slotted ceiling runner to consist of galv steel channel with slotted flanges sized to accommodate steel studs (Item 2B). Slotted ceiling runner installed perpendicular to direction of fluted steel deck and secured to valleys with steel masonry anchors spaced max 24 in. (610 mm) OC. When slotted ceiling runner is used, deflection channel (Item 3A) shall not be used.

BRADY CONSTRUCTION INNOVATIONS INC, DBA SLIPTRACK SYSTEMS – SLP-TRK

CLARKDIETRICH BUILDING SYSTEMS – Type SLT, SLT-H

MARINO/WARE, DIV OF WARE INDUSTRIES INC – Type SLT

METAL-LITE INC – The System

RAM SALES LLC – RAM Slotted Track

SCAFCO STEEL STUD MANUFACTURING CO

TELLING INDUSTRIES LLC – True-Action Deflection Track

- A2. **Light Gauge Framing* – Notched Ceiling Runner** – As an alternate to the ceiling runners in Items 2A through 2A2, notched ceiling runners to consist of C-shaped galv steel channel with notched return flanges sized to accommodate steel studs (Item 2B). Notched ceiling runner installed perpendicular to direction of fluted steel deck and secured to valleys with steel masonry anchors spaced max 24 in. (610 mm) OC. When notched ceiling runner is used, deflection channel (Item 3A) shall not be used.

OLMAR SUPPLY INC – Type SCR

- B. **Studs** – Steel studs to be min 3-1/2 in. (89 mm) wide. Studs cut 1/2 to 3/4 in. (13 to 19 mm) less in length than assembly height with bottom nesting in and resting on floor runner and with top nesting in ceiling runner without attachment. When slotted ceiling runner (Item 2A1) is used, steel studs secured to slotted ceiling runner with No. 8 by 1/2 in. (13 mm) long wafer head steel screws at midheight of slot on each side of wall. Stud spacing not to exceed 24 in. (610 mm) OC.

C. Gypsum Board* – Gypsum board sheets installed to a min total thickness of 5/8 in. (16 mm) and 1-1/4 in. (32 mm) on each side of wall for 1 and 2 hr rated assemblies, respectively. Wall to be constructed as specified in the individual Wall and Partition Design in the UL Fire Resistance Directory, except that a nom 1 in. (25 mm) gap shall be maintained between the top of the gypsum board and the bottom of the steel floor units and the top row of screws shall be installed into the studs 3-1/2 in. (89 mm) below the lower surface of the floor. The hourly fire rating of the joint system is equal to the hourly fire rating of the wall.

3. Joint System – Max separation between bottom of floor and top of wall is 1 in. (25 mm). The joint system is designed to accommodate a max 25 percent compression or extension from its installed width. The joint system consists of a deflection channel, forming material and a fill material, as follows:

A. Deflection Channel (optional) – A nom 3-5/8 in. (92 mm) wide by 3 in. (76 mm) deep min 24 ga steel U-shaped channel. Flange height of deflection channel shall be min 3/4 in. (19 mm) greater than nom joint width. Deflection channel installed perpendicular to direction of fluted steel deck and secured to valleys with steel masonry anchors or by welds spaced max 24 in. (610 mm) OC. The ceiling runner (Item 2A) is installed within the deflection channel to maintain a 1 in. (25 mm) gap between the top of the ceiling runner and the top of the deflection channel. The ceiling runner is not fastened to the deflection channel.

B. Forming Material* – Min 4 in. (102 mm) thickness of min 4 pcf (64 kg/m³) density mineral wool batt insulation cut to the shape of the fluted deck, approx 20 percent larger than the area of the flutes and compressed into flutes of the steel floor units between the top of the deflection channel and the steel deck. Additional pieces of min 4 pcf (64 kg/m³) mineral wool batt insulation are to be cut to the contour of the flutes with an additional 1-3/8 in. (35 mm) high section at the bottom of the shapes to fill the 1 in. (25 mm) gap between the top of the gypsum board and the bottom of the steel floor units. The additional pieces of mineral wool are compressed and firmly packed into the flutes and the gap between the top of the gypsum board and the bottom of the steel floor units on both sides of the wall. The additional pieces shall be a 3/4 in. (19 mm) thick for a 1 hr rated design and a 1-1/2 in. (38 mm) thick for a 2 hr rated design.

INDUSTRIAL INSULATION GROUP LLC – MinWool-1200 Safing

JOHNS MANVILLE – Safing

ROCK WOOL MANUFACTURING CO – Delta Board or Delta-8

ROCKWOOL MALAYSIA SDN BHD – Type Safe

ROXUL INC – Type Safe

THERMAFIBER INC – Type SAF

C. Fill, Void or Cavity Material* – Min 1/16 in. dry, (1/8 in. wet) thickness of fill material sprayed or brushed on each side of the wall in the flutes of the steel floor units and between the top of the gypsum board and the bottom of the steel floor units to completely cover mineral wool and overlap a min of 1/2 in. onto gypsum board and steel deck on both sides of wall.

3M COMPANY – FireDam™ Spray 200

C1. Fill, Void or Cavity Material* – Tape – As an alternate to Item C, Tape cut to size and press applied within fluted areas of joint to completely cover mineral wool lapping min 1 in. (25 mm) onto the contour of the steel floor units and extending to lap min 1 in. (25 mm) onto the gypsum board. Additional pieces of Tape are applied along the joint to completely cover the remaining mineral wool between bottom of steel deck and top edge of gypsum board along length of joint, lapping min 1 in. (25 mm) onto the steel floor units and gypsum board. Adjoining lengths of Tape shall overlap min 1/2 in. (13 mm). Tape shall be applied at both sides of wall.

3M COMPANY – 3M Fire and Water Barrier Tape

*Indicates such products shall bear the UL or cUL Certification Mark for jurisdictions employing the UL or cUL Certification (such as Canada), respectively. 

Reprinted from the Online Certifications Directory with permission from UL©

System No. HW-D-0111

June 24, 2011

Assembly Ratings – 1 and 2 Hr (See Item 2)

L Rating At Ambient – Less Than 1 CFM/Lin Ft

L Rating At 400 F – Less Than 1 CFM/Lin Ft

Nominal Joint Width – 3/4 In.

Class II Movement Capabilities – 17% Compression or Extension

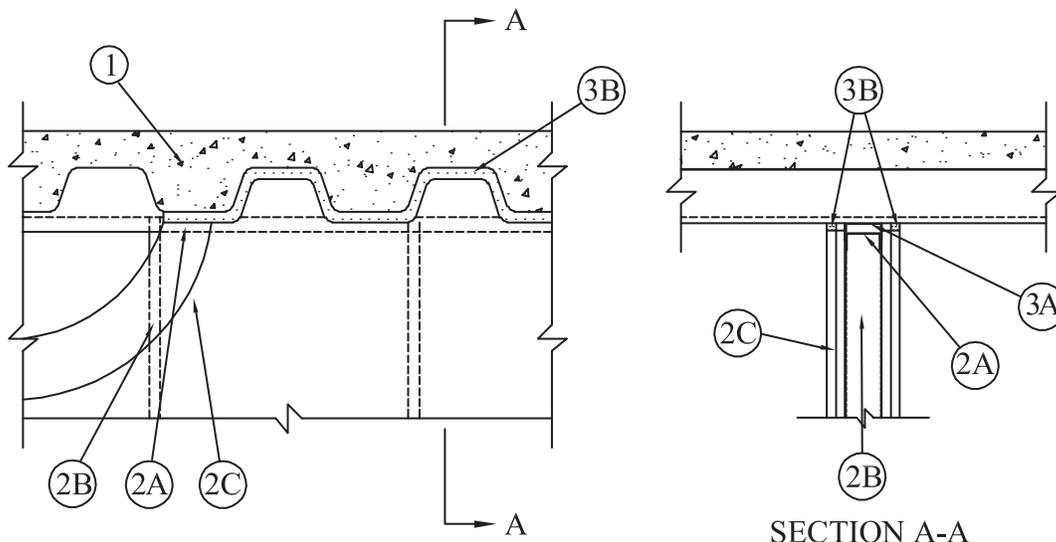

1. **Floor Assembly** – The fluted steel deck/concrete floor assembly shall be constructed of the materials and in the manner described in the individual D700 or D900 Series Floor-Ceiling Design in the UL Fire Resistance Directory and shall include the following construction features:
 - A. **Steel Floor and Form Units*** – Max 3 in. (76 mm) deep galv fluted units.
 - A1. **Spray Applied Fire Resistive Materials*** – (Optional, not shown) – After the installation of ceiling runner or deflection channel (Items 2A, 2A1, 3A) and prior to the installation of the Fill, Void or Cavity Materials (Item 3B), the steel floor units may be sprayed with fire resistive material in accordance with the specifications in the individual D700 Series Design.

W R GRACE & CO - CONN – Type MK-6/HY
 - B. **Concrete** – Min 2-1/2 in. (64 mm) thick reinforced concrete, as measured from the top plane of the floor units.
2. **Wall Assembly** – The 1 or 2 fire rated gypsum board/steel stud wall assembly shall be constructed of the materials and in the manner described in the individual U400 or V400 Series Wall and Partition Design in the UL Fire Resistance Directory and shall include the following construction features:
 - A. **Steel Floor And Ceiling Runners** – Floor and ceiling runners of wall assembly shall consist of min 1-1/4 in. (32 mm) or 2 in. (51 mm) galv steel channels for D900 and D 700 Series Designs, respectively, sized to accommodate steel studs (Item 2B). When U-shaped deflection channel (Item 3A) is used, ceiling runner installed within the deflection channel with 1 in. (25 mm) gap maintained between the top of ceiling runner and top of deflection plate. When deflection channel is not used, ceiling runner is installed perpendicular to direction of fluted steel deck prior to application of the spray-applied fire resistive material and secured to valleys with steel masonry anchors or by welds spaced max 24 in. (610 mm) OC.
 - A1. **Light Gauge Framing* – Slotted Ceiling Runner** – As an alternate to the ceiling runner in Item 2A, slotted ceiling runner to consist of galv steel channel with slotted flanges sized to accommodate steel studs (Item 2B). Slotted ceiling runner installed perpendicular to direction of fluted steel deck prior to application of the spray-applied fire resistive material and secured to valleys with steel masonry anchors spaced max 24 in. (610 mm) OC. When slotted ceiling runner is used, deflection channel (Item 3A) shall not be used.

BRADY CONSTRUCTION INNOVATIONS INC,
DBA SLIPTRACK SYSTEMS – SLP-TRK
CLARKWESTERN BUILDING SYSTEMS INC – Type SLT, SLT-H
MARINO/WARE, DIV OF WARE INDUSTRIES INC – Type SLT
METAL-LITE INC – The System
SCAFCO STEEL STUD MANUFACTURING CO
TELLING INDUSTRIES L L C – True-Action Deflection Track
 - A2. **Light Gauge Framing* – Notched Ceiling Runner** – As an alternate to the ceiling runners in Items 2A through 2A2, notched ceiling runners to consist of C-shaped galv steel channel with notched return flanges sized to accommodate steel studs (Item 2B). Notched ceiling runner installed perpendicular to direction of fluted steel floor deck prior to application of the spray-applied fire resistive material and secured to valleys with steel masonry anchors spaced max 24 in. (610 mm) OC. When notched ceiling runner is used, deflection channel (Item 3A) shall not be used.

OLMAR SUPPLY INC – Type SCR

System No. HW-D-0111 *continued*

Construction Joints

Head of Wall

- B. **Studs** – Steel studs to be min 3-1/2 in. (89 mm) wide. Studs cut 1/2 to 3/4 in. (13 to 19 mm) less in length than assembly height. Studs attached to ceiling runner with sheet metal screws a min of 1/2 in. (13 mm) below bottom of deflection channel, when deflection channel is used. When deflection channel is not used, studs shall not be secured to ceiling runner. When slotted ceiling runner (Item 2A1) is used, steel studs secured to slotted ceiling runner with No. 8 by 1/2 in. (13 mm) long wafer head steel screws at midheight of slot on each side of wall. Stud spacing not to exceed 24 in. (610 mm) OC.
- C. **Gypsum Board*** – Gypsum board sheets to be installed to a min total thickness of 5/8 or 1-1/4 in. (16 or 32 mm) on each side of the wall for a 1 or 2 hr fire rated wall, respectively. Wall to be constructed as specified in the individual Wall and Partition Design in the UL Fire Resistance Directory, except that the gypsum board is cut to fit the contour of the steel floor units or the contour of the spray applied material with a nom 3/4 in. (19 mm) gap. The screws attaching the gypsum board to studs at the top of the wall shall be located 1 in. (25 mm) below the bottom of the deflection channel, when deflection channel is used. When deflection channel is not used, the screws attaching the gypsum board to studs at the top of the wall shall be located 1 in. (25 mm) below the bottom of the ceiling runner (Item 2A) or slotted ceiling runner (Item 2A1). **The hourly fire rating of the joint system is dependant on the hourly fire rating of the wall.**
3. **Joint System – Max separation between bottom of floor or spray applied material and top of wall is 3/4 in. (19 mm). The joint system is designed to accommodate a max 17 percent compression or extension from its installed width.** The joint system consists of a deflection channel and a fill material, as follows:
- A. **Deflection Channel** – (Optional) – A nom 3-1/2 in. (89 mm) wide by min 2 in. (51 mm) deep, min 24 galv steel U-shaped channel. Deflection channel installed perpendicular to direction of fluted steel deck prior to application of the spray-applied fire resistive material and secured to valleys with steel masonry anchors or by welds spaced max 24 in. (610 mm) OC. The ceiling runner (Item 2A) is installed within the deflection channel to maintain a 1 in. (25 mm) gap between the top of the ceiling runner and the top of the deflection channel. The ceiling runner is not fastened to the deflection channel.
- B. **Fill, Void or Cavity Material* – Caulk** – Min 5/8 in. (16 mm) thickness of fill material installed on each side of the wall between the top of the gypsum board and all surfaces of the steel floor units or spray applied material, flush with each surface of gypsum board.
- 3M COMPANY – FD-150+**

*Bearing the UL Classification Mark

Reprinted from the Online Certifications Directory with permission from Underwriters Laboratories Inc.
Copyright © 2011 Underwriters Laboratories Inc.®



HW/D

UL System No. HW-D-0118

December 09, 2016

ANSI/UL2079

Assembly Ratings – 1 and 2 Hr (See Item 2)
Nominal Joint Width – 1 in.

Class II or III Movement Capabilities – 100% Compression or Extension

CAN/ULC S115

F Ratings – 1 and 2 Hr (See Item 2)
FT Ratings – 1 and 2 Hr (See Item 2)
FH Ratings – 1 and 2 Hr (See Item 2)
FTH Ratings – 1 and 2 Hr (See Item 2)
Nominal Joint Width – 25 mm

Class II or III Movement Capabilities – 100% Compression or Extension

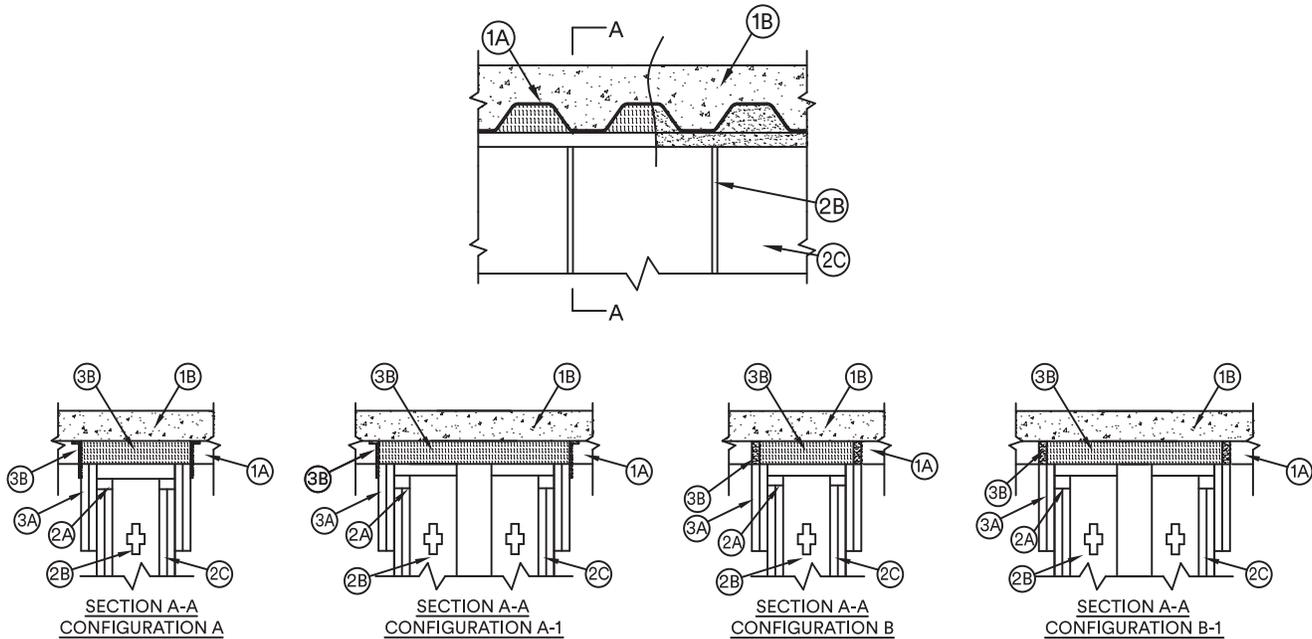

1. **Floor Assembly** – The fire-rated fluted steel deck/concrete floor assembly shall be constructed of the materials and in the manner described in the individual Floor-Ceiling Design in the UL Fire Resistance Directory. The hourly fire rating of the floor assembly shall be equal to or greater than the hourly fire rating of the wall assembly. The floor assembly shall include the following construction features:
 - A. **Steel Floor and Form Units*** – Max 3 in. (76 mm) deep galv fluted floor units.
 - B. **Concrete** – Min 2-1/2 in. (64 mm) thick reinforced lightweight or normal weight (100-150 pcf or 1600-2400 kg/m³) concrete, as measured from the top plane of the floor units.
 - 1A. **Roof Assembly** – As an alternate to Item 1, the fire-rated roof assembly shall be constructed of the materials and in the manner described in the individual P900 Series Roof-Ceiling Designs in the UL Fire Resistance Directory and shall contain max 3 in. (76 mm) deep galv steel fluted roof units. The hourly fire rating of the roof assembly shall be equal to or greater than the hourly fire rating of the wall assembly. In the case of spray-applied protection materials on the steel roof units, the joint system shall be installed prior to the spray-applied protection material.
 - 1B. **Floor Assembly** – As an alternate to Item 1, min 4-1/2 in. (114 mm) thick reinforced lightweight or normal weight (100-150 pcf or 1600-2400 kg/m³) structural concrete.
2. **Wall Assembly** – The 1 or 2 hr fire-rated gypsum board/steel stud wall assembly shall be constructed of the materials and in the manner described in the individual U400 and V400 Series Wall and Partition Design in the UL Fire Resistance Directory and shall include the following construction features:
 - A. **Light Gauge Framing* – Deflection Track** – Deflection track of wall assembly shall consist of min No. 25 gauge galv steel channels sized to accommodate steel studs (Item 2C) and with offset legs to accommodate wall cladding (Item 3A). Deflection track installed perpendicular to floor units. Min No. 25 gauge deflection track secured on both sides to valley of floor units with 1-1/2 in. (38 mm) long welds spaced max 12 in. (305 mm) OC. Min No. 20 gauge deflection track may be secured with steel fasteners spaced 12 in. (305 mm) OC.

FIRE TRAK CORP – Shadowline and Cavity Shadowline
 - B. **Studs** – Steel studs to be min 2-1/2 in. (64 mm) wide and as specified in the individual Wall and Partition Design in the UL Fire Resistance Directory. Studs cut 1-1/2 in. (38 mm) less in length than the assembly height with bottom nesting in and resting on floor runner and with top nesting in ceiling runner without attachment. Stud spacing not to exceed 24 in. (610 mm) OC.
 - C. **Gypsum Board*** – Gypsum board sheets installed and attached to studs and runners as specified in the individual Wall and Partition Design in the UL Fire Resistance Directory, except that a nominal 1 in. (25 mm) gap shall be maintained between top of the gypsum board and the bottom flange of the deflection track. Top row of screws shall be installed into the studs 3 in. (76 mm) below the top edge of the gypsum board sheets.

UL System No. HW-D-0118 (cont.)

D. Bracing (not shown) – Bracing as specified in the individual Wall and Partition Design in the UL Fire Resistance Directory.

The hourly assembly rating of the joint system is equal to the fire rating of the wall.

Firestop Configuration A and A1

3. Joint System – Max separation between bottom flange of the deflection track and top of gypsum board (at the time of installation of the joint system) is 1 in. (25 mm). The joint system is designed to accommodate a max 100 percent compression or extension from its installed width. The joint system consists of wall cladding, packing material and a fill material as follows:

A. Wall Cladding – Strips of the gypsum board material attached to the deflection track. The number of layers, board type and thickness and fastener type shall be as specified for the gypsum board in the individual Wall and Partition Design in the UL Fire Resistance Directory. Fasteners shall be max spaced 3 in. (76 mm) OC. The top of the wall cladding shall be flush with the valleys of the steel floor units and overlap the gypsum board 4 in. (102 mm).

B. Flute Fill – The batt insulation and fill material are to be installed as specified in the Joint Systems in the table below:

| Manufacturer | Product Designation | System No. |
|--------------|--------------------------------|------------|
| 3M Company | FireDam Spray 200 | HW-D-0020 |
| 3M Company | 3M Fire and Water Barrier Tape | HW-D-0020 |

3M COMPANY – FireDam Spray 200, 3M Fire and Water Barrier Tape

Firestop Configuration B and B1

3. Joint System – Max separation between bottom flange of the deflection track and top of wallboard (at the time of installation of the joint system) is 1 in. (25 mm). The joint system is designed to accommodate a max 100 percent compression or extension from its installed width. The joint system consists of wall cladding, packing material and a fill material as follows:

A. Wall Cladding – Strips of the gypsum board material attached to the deflection track. The number of layers, board type and thickness and fastener type shall be as specified for the gypsum wallboard in the individual Wall and Partition Design in the UL Fire Resistance Directory. Fasteners shall be max spaced 3 in. (76 mm) OC. The top of the wall cladding shall be flush with the valleys of the steel floor units and overlap the gypsum board 4 in. (102 mm).

B. Flute Fill – The batt insulation and fill material are to be installed as specified in the systems in the table below:

| Manufacturer | Product Designation | System No. |
|--------------|---------------------|------------|
| 3M Company | FB 1000NS | HW-S-0028 |
| 3M Company | FB 2000 | HW-S-0002 |
| 3M Company | FB 2000+ | HW-S-0002 |

3M COMPANY – FB 1000NS, FB 2000, FB 2000+

*Indicates such products shall bear the UL or cUL Certification Mark for jurisdictions employing the UL or cUL Certification (such as Canada), respectively. 

Reprinted from the Online Certifications Directory with permission from UL©

System No. HW-D-0119

February 19, 2014

ANSI/UL2079

Assembly Ratings — 1, 2 and 3 Hr (See Item 2)

Nominal Joint Width - 1 In.

Class II or III Movement Capabilities —

100% Compression or Extension

CAN/ULC S115

F Ratings — 1, 2 and 3 Hr (See Item 2)

FT Ratings — 1, 2 and 3 Hr (See Item 2)

FH Ratings — 1, 2 and 3 Hr (See Item 2)

FTH Ratings — 1, 2 and 3 Hr (See Item 2)

Nominal Joint Width - 1 In.

Class II or III Movement Capabilities — 100% Compression or Extension

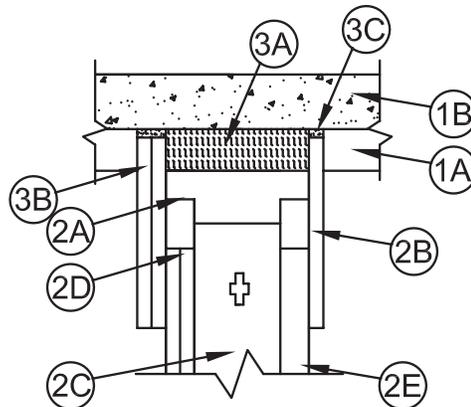
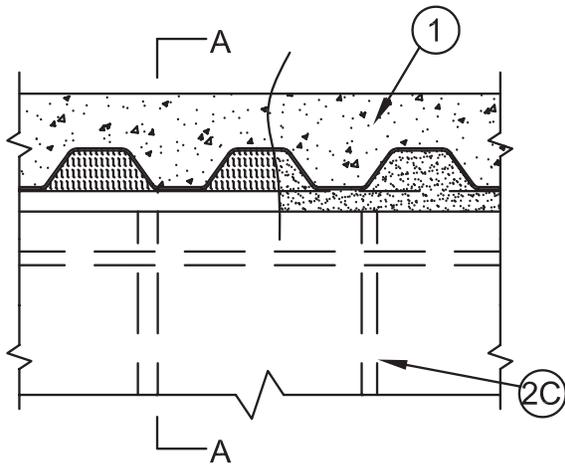

**SECTION A-A
CONFIGURATION A**

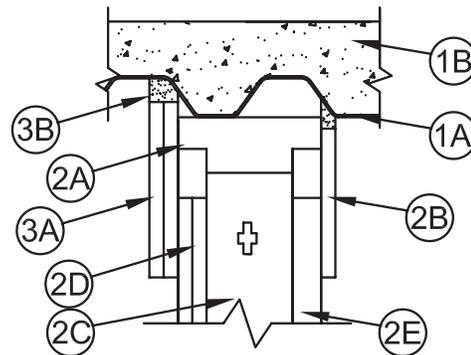
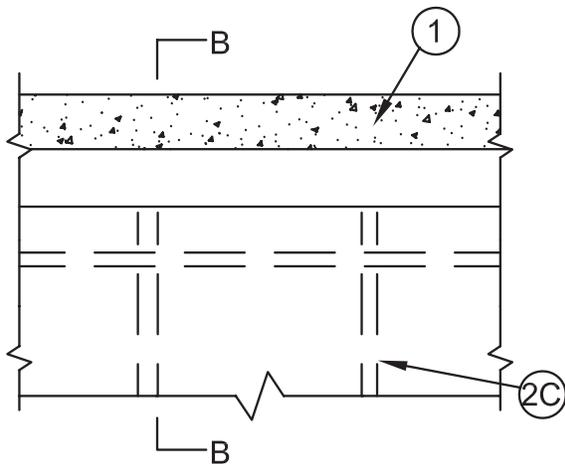

**SECTION B-B
CONFIGURATION B**

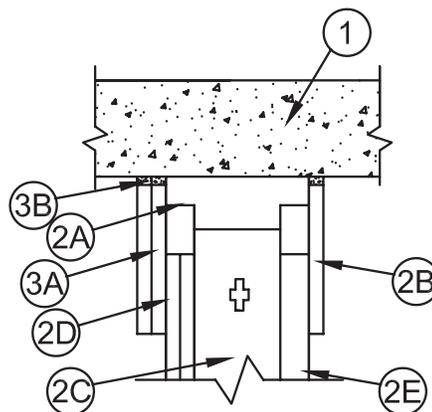
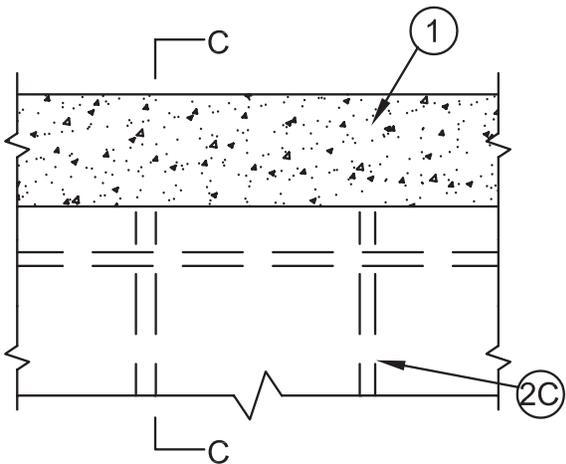

**SECTION C-C
CONFIGURATION C**

System No. HW-D-0119 *continued*

Construction Joints

Head of Wall

1. **Floor Assembly** — The fire-rated fluted steel deck/concrete floor assembly shall be constructed of the materials and in the manner described in the individual D900 Floor-Ceiling Design in the UL Fire Resistance Directory. The hourly fire rating of the floor assembly shall be equal to or greater than the hourly fire rating of the wall assembly. The floor assembly shall include the following construction features:
 - A. **Steel Floor and Form Units*** — Max 3 in. (76 mm) deep galv fluted floor units.
 - B. **Concrete** — Min 2-1/2 in. (64 mm) thick reinforced (100-150 pcf or 1600-2400 kg/m³) concrete, as measured from the top plane of the floor units.
- 1A. **Roof Assembly** — As an alternate to Item 1, the fire-rated roof assembly shall be constructed of the materials and in the manner described in the individual P900 Series Roof-Ceiling Designs in the UL Fire Resistance Directory and shall contain max 3 in. (76 mm) deep galv steel fluted roof units. The hourly fire rating of the roof assembly shall be equal to or greater than the hourly fire rating of the wall assembly.
- 1B. **Floor Assembly** — As an alternate to Item 1, min 4-1/2 in. (114 mm) thick reinforced lightweight or normal weight (100-150 pcf or 1600-2400 kg/m³) structural concrete or any min 6 in. (152 mm) thick UL Classified hollow-core **Precast Concrete Units***.
See **Precast Concrete Units** (CFTV) category in the Fire Resistance Directory for names of manufactures.
2. **Shaft Wall Assembly** — The 1, 2 or 3 hr fire-rated gypsum board /steel stud shaft wall assembly shall be constructed of the materials and in the manner described in the individual U400, V400 or W400 Series Wall and Partition Design in the UL Fire Resistance Directory and shall include the following construction features:

- A. **Light Gauge Framing* — Deflection Trak** — Deflection trak of wall assembly shall consist of min No. 25 gauge galv steel channels sized to accommodate steel studs (Item 2C) and with offset legs to accommodate wall cladding (Item 3A). Deflection trak installed parallel or perpendicular to floor units. When installed perpendicular (Configuration A), deflection trak secured on both sides to valley of floor units with 1-1/2 in. (38 mm) long welds spaced max 12 in. (305 mm) OC for 25 ga trak, 20 ga or heavier trak can be secured with steel fasteners spaced 12 in. (305 mm) OC. When installed parallel (Configuration B), deflection secured on one side to valley of floor units with 1-1/2 in. (38 mm) long welds (25ga) or steel fasteners (20 ga or heavier) spaced max 12 in. (305 mm) OC. The other side of the deflection trak is secured to Z-Furring clips (Item 2B) with two No. 8 by 1/2 in. (13mm) long steel tec screws. On concrete floor (Configuration C), min No. 20 gauge deflection trak attached to concrete at ceiling with steel fasteners spaced max 12 in. (305 mm) OC.
FIRE TRAK CORP — Cavity Shadowline
- B. **Z-Furring - (Parallel Units)** — When trak is installed parallel to floor units, Z-Furring clips are attached to the bottom of the floor units within the crests two steel fasteners. Clip spacing not to exceed 24 in. (610) OC
FIRE TRAK CORP — Z-Furring Clips
- C. **Studs** — Steel studs to be min 2-1/2 in. (64 mm) wide and as specified in the individual Wall and Partition Design in the UL Fire Resistance Directory. Studs cut 1-1/2 in. (38 mm) less in length than the assembly height with bottom nesting in and resting on floor runner and with top nesting in ceiling runner without attachment. Stud spacing not to exceed 24 in. (610 mm) OC.
- D. **Gypsum Board*** — Gypsum board sheets installed and attached to studs and runners as specified in the individual Wall and Partition Design in the UL Fire Resistance Directory, except that a nominal 1 in. (25 mm) gap shall be maintained between top of the gypsum board and the bottom flange of the deflection trak. Top row of screws shall be installed into the studs 3 in. (76 mm) below the top edge of the gypsum board sheets.
- E. **Gypsum Board*** — 1 in. (25 mm) thick gypsum board liner panels, supplied in nom 24 in. (610 mm) widths. Panels cut 1 in. (25 mm) less in length than floor to ceiling height. Gypsum board sheets installed and attached to studs and runners as specified in the individual Wall and Partition Design in the UL Fire Resistance Directory.

The hourly ratings of the joint system are equal to the fire rating of the wall.

Firestop Configuration A

3. **Joint System — Max separation between bottom flange of the deflection trak and top of gypsum board (at the time of installation of the joint system) is 1 in. (25 mm). The joint system is designed to accommodate a max 100 percent compression or extension from its installed width.** The joint system consists of packing material (Item 3A), wall cladding (Item 3B) and a fill material (Item 3C) as follows:
 - A. **Packing Material** — Min 4 pcf (64 kg/m³) density mineral wool batt insulation cut to the shape of the fluted deck, 25 percent larger than the area of the flutes and compressed into the flutes of the steel floor units above the ceiling runner as a permanent form.
 - B. **Wall Cladding** — Strips of the gypsum board material cut to the contour of the steel floor units and attached to the deflection trak on both sides of wall. The number of layers, board type and thickness and fastener type shall be as specified for the gypsum board in the individual Wall and Partition Design in the UL Fire Resistance Directory. Fasteners shall be max spaced 3 in. (76 mm) OC. The top of the wall cladding shall be recessed min 1/8 in. (3.2 mm) to max 1/2 in. (13 mm) from the steel floor units and overlap the gypsum board 4 in. (102 mm) on both sides of wall.
 - C. **Fill, Void or Cavity Material*** — Full depth of fill material installed on each side of the wall between the top of the wall cladding and the surface of the steel floor units, flush with each surface of the cladding.
3M COMPANY — FB 1000NS, FB 2000, FB 2000+, FD-150+, CP 25 WB+

Firestop Configuration B

3. **Joint System — Max separation between bottom flange of the deflection trak and top of gypsum board (at the time of installation of the joint system) is 1 in. (25 mm). The joint system is designed to accommodate a max 100 percent compression or extension from its installed width.** The joint system consists of wall cladding (Item 3A) and a fill material (Item 3B) as follows:
 - A. **Wall Cladding** — Strips of the gypsum board material attached to the deflection trak on both sides of wall. The number of layers, board type and thickness and fastener type shall be as specified for the gypsum board in the individual Wall and Partition Design in the UL Fire Resistance Directory. Fasteners shall be max spaced 3 in. (76 mm) OC. The top of the wall cladding shall be recessed min 1/8 in. (3.2 mm) to max 1/2 in. (13 mm) from the steel floor units and overlap the gypsum board 4 in. (102 mm) on both sides of wall.
 - B. **Fill, Void or Cavity Material*** — Full depth of fill material installed on each side of the wall between the top of the wall cladding and the surface of the steel floor units, flush with each surface of the cladding.
3M COMPANY — FB 1000NS, FB 2000, FB 2000+, FD-150+, CP 25 WB+

System No. HW-D-0119 *continued*

Firestop Configuration C

3. **Joint System** — Max separation between bottom flange of the deflection trak and top of gypsum board (at the time of installation of the joint system) is 1 in. (25 mm). The joint system is designed to accommodate a max 100 percent compression or extension from its installed width. The joint system consists of wall cladding (Item 3A) and a fill material (Item 3B) as follows:
- A. **Wall Cladding** — Strips of the gypsum board material attached to the deflection trak on both sides of wall. The number of layers, board type and thickness and fastener type shall be as specified for the gypsum board in the individual Wall and Partition Design in the UL Fire Resistance Directory. Fasteners shall be max spaced 3 in. (76 mm) OC. The top of the wall cladding shall be recessed min 1/8 in. (3.2 mm) to max 1/2 in. (13 mm) from the bottom of the concrete floor and overlap the gypsum board 4 in. (102 mm) on both sides of wall.
 - B. **Fill, Void or Cavity Material*** — Full depth of fill material installed on each side of the wall between the top of the wall cladding and the surface of the steel floor units, flush with each surface of the cladding.
- 3M COMPANY** — FB 1000NS, FB 2000, FB 2000+, FD-150+, CP 25 WB+

*Bearing the UL Classification Mark

Reprinted from the Online Certifications Directory with permission from UL
© 2014 UL LLC



Construction Joints

Head of Wall

HW/D

System No. HW-D-0120

February 19, 2014

ANSI/UL2079

Assembly Ratings — 1, 2 and 3 Hr (See Item 2)

Nominal Joint Width - 1 In.

Class II or III Movement Capabilities —
100% Compression or Extension

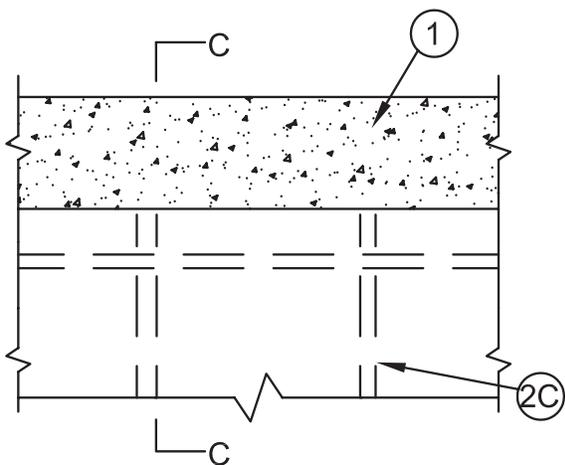
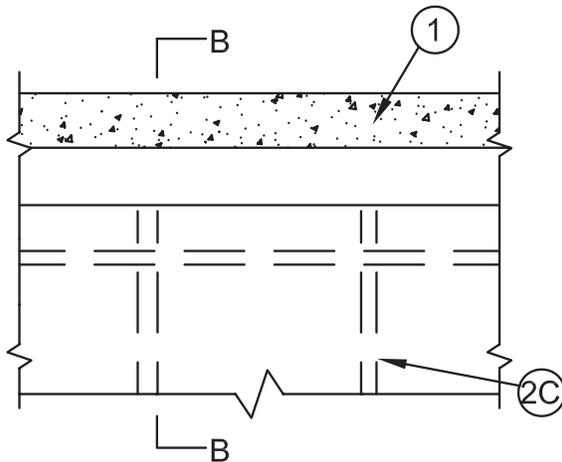
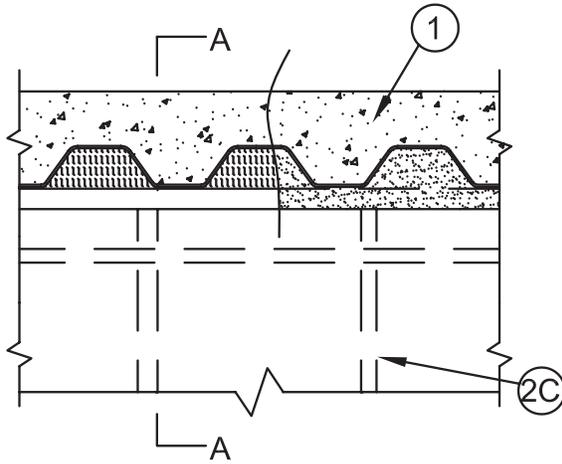

CAN/ULC S115

F Ratings — 1, 2 and 3 Hr (See Item 2)

FT Ratings — 1, 2 and 3 Hr (See Item 2)

FH Ratings — 1, 2 and 3 Hr (See Item 2)

FTH Ratings — 1, 2 and 3 Hr (See Item 2)

Nominal Joint Width - 1 In.

Class II or III Movement Capabilities — 100% Compression or Extension

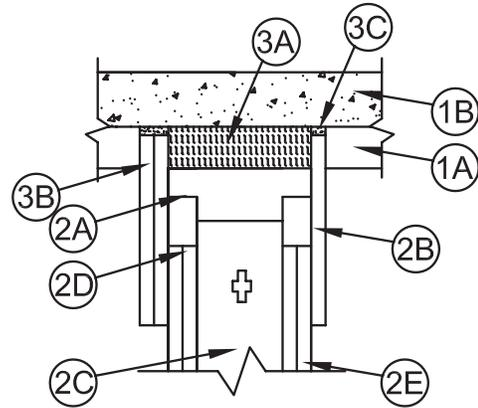

**SECTION A-A
CONFIGURATION A**

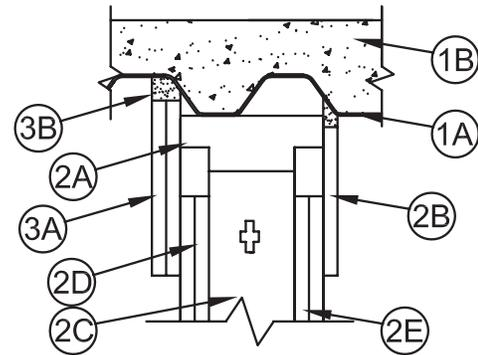

**SECTION B-B
CONFIGURATION B**

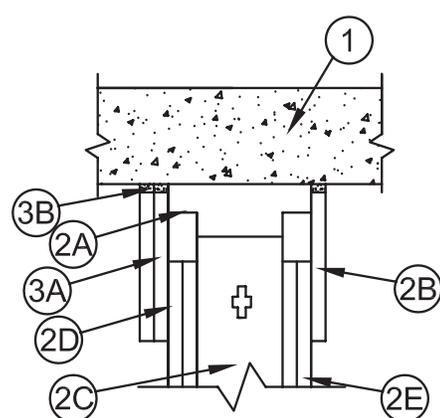

**SECTION C-C
CONFIGURATION C**

System No. HW-D-0120 *continued*

Construction Joints

Head of Wall

1. **Floor Assembly** — The fire-rated fluted steel deck/concrete floor assembly shall be constructed of the materials and in the manner described in the individual D900 Floor-Ceiling Design in the UL Fire Resistance Directory. The hourly fire rating of the floor assembly shall be equal to or greater than the hourly fire rating of the wall assembly. The floor assembly shall include the following construction features:
 - A. **Steel Floor and Form Units*** — Max 3 in. (76 mm) deep galv fluted floor units.
 - B. **Concrete** — Min 2-1/2 in. (64 mm) thick reinforced (100-150 pcf or 1600-2400 kg/m³) concrete, as measured from the top plane of the floor units.
- 1A. **Roof Assembly** — As an alternate to Item 1, the fire-rated roof assembly shall be constructed of the materials and in the manner described in the individual P900 Series Roof-Ceiling Designs in the UL Fire Resistance Directory and shall contain max 3 in. (76 mm) deep galv steel fluted roof units. The hourly fire rating of the roof assembly shall be equal to or greater than the hourly fire rating of the wall assembly.
- 1B. **Floor Assembly** — As an alternate to Item 1, min 4-1/2 in. (114 mm) thick reinforced lightweight or normal weight (100-150 pcf or 1600-2400 kg/m³) structural concrete or any min 6 in. (152 mm) thick UL Classified hollow-core **Precast Concrete Units***.
See **Precast Concrete Units** (CFTV) category in the Fire Resistance Directory for names of manufactures.
2. **Shaft Wall Assembly** — The 1, 2 hr or 3 fire-rated gypsum board /steel stud wall assembly shall be constructed of the materials and in the manner described in the individual U400, V400 or W400 Series Wall and Partition Design in the UL Fire Resistance Directory and shall include the following construction features:

- A. **Light Gauge Framing* — Deflection Trak** — Deflection trak of wall assembly shall consist of min No. 25 gauge galv steel channels sized to accommodate steel studs (Item 2C) and with offset legs to accommodate wall cladding (Item 3A). Deflection trak installed parallel or perpendicular to floor units. When installed perpendicular (Configuration A), deflection trak secured on both sides to valley of floor units with 1-1/2 in. (38 mm) long welds spaced max 12 in. (305 mm) OC. Min No. 20 gauge deflection trak may be secured with steel fasteners spaced 12 in. (305 mm) OC. When installed parallel (Configuration B), min No. 25 gauge deflection secured on one side to valley of floor units with 1-1/2 in. (38 mm) long welds spaced 12 in. (305 mm) OC. Min No.25 gauge deflection trak may be secured with steel fasteners spaced max 12 in. (305 mm) OC. The other side of the deflection trak is secured to Z-Furring clips (Item 2B) with two No. 8 by 1/2 in. (13 mm) long steel tec screws. On concrete floor (Configuration C), min No. 20 gauge deflection trak attached to concrete at ceiling with steel fasteners spaced a max 12 in. (305 mm) OC.

FIRE TRAK CORP — Cavity Shadowline

- B. **Z-Furring - (Parallel Units)** — When trak is installed parallel to floor units, Z-Furring clips are attached to the bottom of the floor units within the crests with two steel fasteners . Clip spacing not to exceed 24 in. (610 mm) OC

FIRE TRAK CORP — Z-Furring Clips

- C. **Studs** — Steel studs to be min 2-1/2 in. (64 mm) wide and as specified in the individual Wall and Partition Design in the UL Fire Resistance Directory. Studs cut 1-1/2 in. (38 mm) less in length than the assembly height with bottom nesting in and resting on floor runner and with top nesting in ceiling runner without attachment. Stud spacing not to exceed 24 in. (610 mm) OC.
- D. **Gypsum Board*** — Gypsum board sheets installed and attached to studs and runners as specified in the individual Wall and Partition Design in the UL Fire Resistance Directory, except that a nominal 1 in. (25 mm) gap shall be maintained between top of the gypsum board and the bottom flange of the deflection trak. Top row of screws shall be installed into the studs 3 in. (76 mm) below the top edge of the gypsum board sheets.
- E. **Gypsum Board*** — 1 in. (25 mm) thick gypsum board liner panels, supplied in nom 24 in. (610 mm) widths. Panels cut 1 in. (25 mm) less in length than floor to ceiling height. Gypsum board sheets installed and attached to studs and runners as specified in the individual Wall and Partition Design in the UL Fire Resistance Directory.

The hourly ratings of the joint system are equal to the fire rating of the wall.

Firestop Configuration A

3. **Joint System — Max separation between bottom flange of the deflection trak and top of gypsum board (at the time of installation of the joint system) is 1 in. (25 mm). The joint system is designed to accommodate a max 100 percent compression or extension from its installed width.** The joint system consists of packing material (Item 3A), wall cladding (Item 3B) and a fill material (Item 3C) as follows:
 - A. **Packing Material** — Min 4 pcf (64 kg/m³) density mineral wool batt insulation cut to the shape of the fluted deck, 25 percent larger than the area of the flutes and compressed into the flutes of the steel floor units above the ceiling runner as a permanent form.
 - B. **Wall Cladding** — Strips of the gypsum board material cut to the contour of the steel floor units and attached to the deflection trak on both sides of wall. The number of layers, board type and thickness and fastener type shall be as specified for the gypsum board in the individual Wall and Partition Design in the UL Fire Resistance Directory. Fasteners shall be max spaced 3 in. (76 mm) OC. The top of the wall cladding shall be recessed min 1/8 in. (3.2 mm) to max 1/2 in. (13 mm) from the steel floor units and overlap the gypsum board 4 in. (102 mm) on both sides of wall.
 - C. **Fill, Void or Cavity Material*** — Full depth of fill material installed on each side of the wall between the top of the wall cladding and the surface of the steel floor units, flush with each surface of the cladding.
3M COMPANY — FB 1000NS, FB 2000, FB 2000+, FD-10+, CP 25 WB+

Firestop Configuration B

3. **Joint System — Max separation between bottom flange of the deflection trak and top of gypsum board (at the time of installation of the joint system) is 1 in. (25 mm). The joint system is designed to accommodate a max 100 percent compression or extension from its installed width.** The joint system consists of wall cladding (Item 3A) and a fill material (Item 3B) as follows:
 - A. **Wall Cladding** — Strips of the gypsum board material attached to the deflection trak on both sides of wall. The number of layers, board type and thickness and fastener type shall be as specified for the gypsum board in the individual Wall and Partition Design in the UL Fire Resistance Directory. Fasteners shall be max spaced 3 in. (76 mm) OC. The top of the wall cladding shall be recessed min 1/8 in. (3.2 mm) to max 1/2 in. (13 mm) from the steel floor units and overlap the gypsum board 4 in. (102 mm) on both sides of wall.
 - B. **Fill, Void or Cavity Material*** — Full depth of fill material installed on each side of the wall between the top of the wall cladding and the bottom of the floor assembly, flush with each surface of the cladding.
3M COMPANY — FB 1000NS, FB 2000, FB 2000+, FD-10+, CP 25 WB+

HW-D

System No. HW-D-0120 *continued*

Firestop Configuration C

3. **Joint System** — Max separation between bottom flange of the deflection trak and top of gypsum board (at the time of installation of the joint system) is 1 in. (25 mm). The joint system is designed to accommodate a max 100 percent compression or extension from its installed width. The joint system consists of spray applied fire resistive material (Item 3A), and wall cladding (Item 3B) as follows:
- A. **Wall Cladding** — Strips of the gypsum board material attached to the deflection trak on both sides of wall. The number of layers, board type and thickness and fastener type shall be as specified for the gypsum board in the individual Wall and Partition Design in the UL Fire Resistance Directory. Fasteners shall be max spaced 3 in. (76 mm) OC. The top of the wall cladding shall be recessed min 1/8 in. (3.2 mm) to max 1/2 in. (13 mm) from the bottom of the concrete floor and overlap the gypsum board 4 in. (102 mm) on both sides of wall.
 - B. **Fill, Void or Cavity Material*** — Full depth of fill material installed on each side of the wall between the top of the wall cladding and the surface of the steel floor units, flush with each surface of the cladding.
- 3M COMPANY** — FB 1000NS, FB 2000, FB 2000+, FD-10+, CP 25 WB+

*Bearing the UL Classification Mark

Reprinted from the Online Certifications Directory with permission from UL
© 2014 UL LLC



Construction Joints

Head of Wall

HW/D

| ANSI/UL2079 | CAN/ULC S115 |
|---|---|
| Assembly Rating – 4 Hr | F Rating – 4 Hr |
| Nominal Joint Width - 1 In. | FT Rating – 4 Hr |
| Class II Movement Capabilities – 25% Compression or Extension | FH Rating – 4 Hr |
| | FTH Rating – 4 Hr |
| | Nominal Joint Width - 25 mm |
| | Class II Movement Capabilities – 25% Compression or Extension |

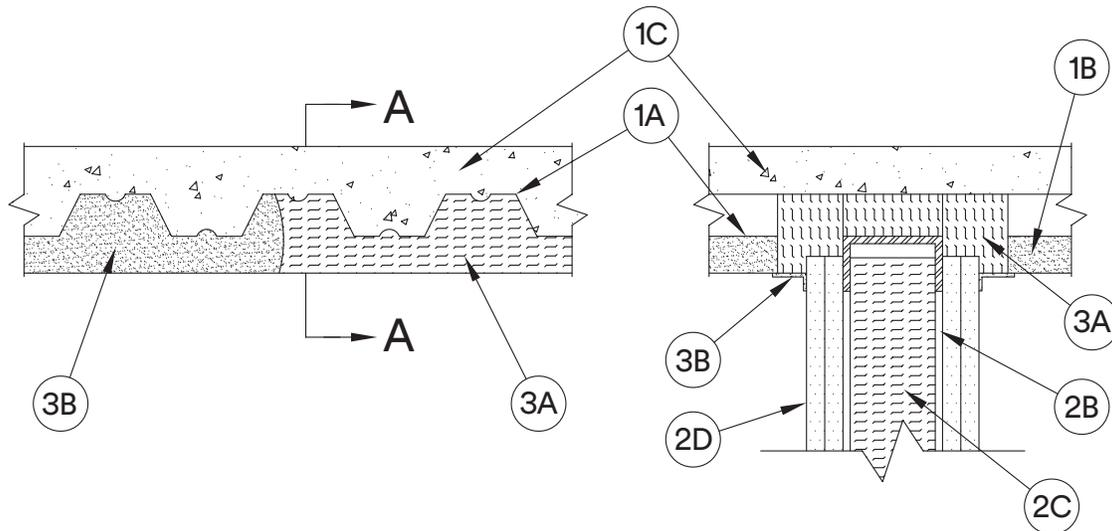

SECTION A-A

- 1. Floor Assembly** – The fluted steel deck/concrete floor assembly shall be constructed of the materials and in the manner described in the individual Floor-Ceiling Design in the UL Fire Resistance Directory and shall include the following construction features:
 - A. Steel Floor and Form Units*** – Max 3 in. (76 mm) deep galv steel fluted units.
 - B. Spray Applied Fire Resistive Material*** – The steel floor units shall be sprayed with a min 2 in. (51 mm) thickness of fire resistive material. The spray applied fire resistive material is to be removed from the steel deck for the installation of the ceiling runner (Item 2A) and the joint system (Item 3) such that the steel deck is bare over the ceiling runner and extending 2 in. (51 mm) beyond the surface of the wallboard on both sides of the wall.
GCP APPLIED TECHNOLOGIES INC – Type MK-6/HY
 - C. Concrete** – Min 2-1/2 in. (64 mm) thick reinforced concrete, as measured from the top plane of the floor units.
- 2. Wall Assembly** – The 4 hr fire rated gypsum board/steel stud wall assembly shall be constructed of the materials and in the manner described in the individual U400 or V400 Series Wall and Partition Design in the UL Fire Resistance Directory and shall include the following construction features:
 - A. Steel Floor and Ceiling Runners** – Floor and ceiling runners of wall assembly shall consist of min 20 gauge galv steel channels sized to accommodate steel studs (Item 2B). Ceiling runner to be provided with 3 in. (76 mm) flanges. Ceiling runner installed perpendicular to direction of fluted steel floor units and secured to valleys with welds or masonry anchors spaced a max of 24 in. (610 mm) OC.
 - B. Studs** – Steel studs to be min 20 gauge galv steel, min 3-5/8 in. (92 mm) wide. Studs cut 1/2 to 3/4 in. (13 to 19 mm) less in length than assembly height with bottom nesting in and resting on floor runner and with top nesting in ceiling runner without attachment. Stud spacing not to exceed 24 in. (610 mm) OC.
 - C. Batts and Blankets** – Min 3 in. (76 mm) thickness of min 4 pcf (64 kg/m³) mineral wool batt insulation placed in each stud cavity with a 1 in. (25 mm) gap between top of batt and top of ceiling runner.
 - D. Gypsum Board*** – Gypsum board sheets to be installed to a min total thickness of 1-1/2 in. (38 mm) on each side of the wall. Wall to be constructed as specified in the individual Wall and Partition Design in the UL Fire Resistance Directory, except that a nom 1 in. (25 mm) gap shall be maintained between the top of the gypsum board and the bottom of the steel floor units and the top row of screws shall be installed into studs 1 in. (25 mm) below the bottom of the ceiling runner.

3. Joint System – Max separation between bottom of floor and top of wall is 1 in. (25 mm). The joint system is designed to accommodate a max 25 percent compression or extension from its installed width. The joint system consists of a forming material and a fill material, as follows:

A. Forming Material* – Min 3-5/8 in. (92 mm) thickness of min 8 pcf (128 kg/m³) density mineral wool batt insulation cut to the shape of the fluted deck, approximately 20 percent larger than the area of the flutes and compressed into flutes of the steel floor units between the top of the ceiling runner and the steel deck. Additional pieces of min 3-1/2 in. (89 mm) thick, min 8 pcf (128 kg/m³) mineral wool batt insulation are to be cut to the contour of the flutes with an additional 1-3/8 in. (35 mm) high section at the bottom of the shapes to fill the 1 in. (25 mm) gap between the top of the wallboard and bottom of the steel floor units. The additional pieces of mineral wool are compressed and firmly packed into the flutes and the gap between the top of the wallboard and bottom of the steel floor units on both sides of the wall and shall extend 2 in. (51 mm) beyond the wall surfaces.

INDUSTRIAL INSULATION GROUP LLC – MinWool-1200 Safing

THERMAFIBER INC – Type SAF

ROCK WOOL MANUFACTURING CO – Delta Safing Board

B. Fill, Void or Cavity Material* – Min 1/16 in. (1.6 mm) dry thickness (min 1/8 in. or 3.2 mm wet thickness) of fill material sprayed or brushed on each side of the wall in the flutes of the steel floor units and between the top of the gypsum board and the bottom of the steel floor units to completely cover mineral wool and overlap a min of 1 in. (25 mm) onto gypsum board and a min of 3 in. (76 mm) onto the spray applied fire resistive material on both sides of wall.

3M COMPANY – Firedam™ Spray 200

B1. Fill, Void or Cavity Material* – Tape – As an alternate to Item B, Tape cut to size and press applied within fluted areas of joint to completely cover mineral wool lapping min 2 in. (51 mm) onto the contour of the protected steel floor units and extending to lap min 1 in. (25 mm) onto the gypsum wall. Additional pieces of Tape are applied along the joint to completely cover the remaining mineral wool between bottom of protected steel deck and top edge of wall along length of joint, lapping min 2 in. (51 mm) onto the contour of the protected steel floor units and min 1 in. (25 mm) onto the gypsum wall. Adjoining lengths of Tape shall overlap min 1/2 in. (13 mm). Tape shall be applied at both sides of wall.

3M COMPANY 3M FIRE PROTECTION PRODUCTS – 3M Fire and Water Barrier Tape



*Indicates such products shall bear the UL or cUL Certification Mark for jurisdictions employing the UL or cUL Certification (such as Canada), respectively.

Reprinted from the Online Certifications Directory with permission from UL©



UL System No. HW-D-0123
XHBN - Joint Systems
XHBN7 - Joint Systems Certified for Canada

January 12, 2018

| ANSI/UL2079 | CAN/ULC S115 |
|---|---|
| Assembly Ratings – 3 or 4 Hr (See Item 1) | F Rating – 3 or 4 Hr (See Item 1) |
| Nominal Joint Width – 1 In. | FT Rating – 3 or 4 Hr (See Item 1) |
| Class II Movement Capabilities – 25% Compression or Extension | FH Rating – 3 or 4 Hr (See Item 1) |
| | FTH Rating – 3 or 4 Hr (See Item 1) |
| | Nominal Joint Width - 25 mm |
| | Class II Movement Capabilities – 25% Compression or Extension |

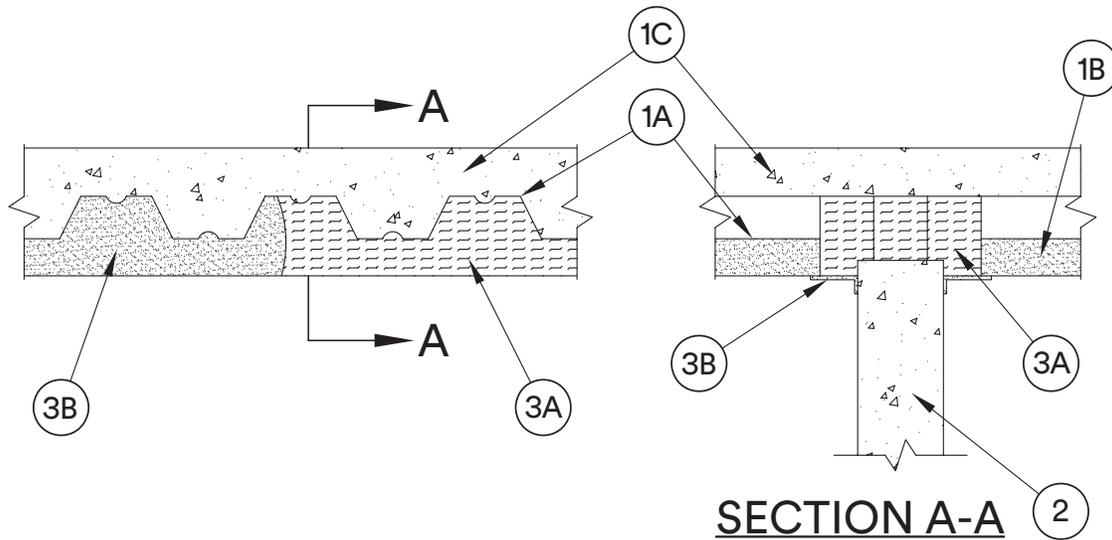

1. Floor Assembly – The fluted steel deck/concrete floor assembly shall be constructed of the materials and in the manner described in the individual D700 or D900 Series Floor-Ceiling Design in the UL Fire Resistance Directory and shall include the following construction features:

- A. Steel Floor and Form Units*** – Max 2 in. (51 mm) deep galv steel fluted units.
- B. Spray Applied Fire Resistive Material*** – The steel floor units shall be sprayed with a min 2 in. (51 mm) thickness of fire resistive material. The spray applied fire resistive material is to be removed from the steel deck for the installation of the joint system (Item 3) such that the steel deck is bare over the wall and extending 2 in. (51 mm) beyond the surface of the gypsum board on both sides of the wall.

GCP APPLIED TECHNOLOGIES INC – Type MK-6/HY

- C. Concrete** – Min 2-1/2 in. (64 mm) thick reinforced concrete, as measured from the top plane of the floor units.

The hourly Assembly, F, FT, FH and FTH Ratings are equal to the 3 or 4 hr Assembly Rating of the D700 or D900 Series Floor-Ceiling design.

2. Wall Assembly – Min 6-1/2 in. (165 mm) thick lightweight or normal weight (100-150 pcf or 1600-2400 kg/m³) concrete. Wall may also be constructed of UL Classified Concrete Blocks.

See **Concrete Blocks** (CAZT) category in the Fire Resistance Directory for names of manufacturers.

3. Joint System – Max separation between bottom of floor and top of wall is 1 in. (25 mm). The joint system is designed to accommodate a max 25 percent compression or extension from its installed width. The joint system consists of a forming material and a fill material, as follows:

- A. Forming Material*** – Min 3-5/8 in. (92 mm) thickness of min 8 pcf (128 kg/m³) density mineral wool batt insulation cut to the shape of the fluted deck, approximately 20 percent larger than the area of the flutes and compressed into flutes of the steel floor units between the top of the wall and the steel deck. Additional pieces of min 3-1/2 in. (89 mm) thick, min 8 pcf (128 kg/m³) mineral wool batt insulation are to be cut to the contour of the flutes with an additional 1-3/8 in. (35 mm) high section at the bottom of the shapes to fill the 1 in. (25 mm) gap between the top of the wall and bottom of the steel floor units. The additional pieces of mineral wool are compressed and firmly packed into the flutes and the gap between the top of the wall and bottom of the steel floor units on both sides of the wall and shall extend 2 in. (51 mm) beyond the wall surfaces.

INDUSTRIAL INSULATION GROUP LLC – MinWool-1200 Safing

THERMAFIBER INC – Type SAF

ROCK WOOL MANUFACTURING CO – Delta Safing Board

- B. Fill, Void or Cavity Material*** – Min 1/16 in. (1.6 mm) dry thickness (min 1/8 in. or 3.2 mm wet thickness) of fill material sprayed or brushed on each side of the wall in the flutes of the steel floor units and between the top of the wall and the bottom of the steel floor units to completely cover mineral wool and overlap a min of 1 in. (25 mm) onto wall and a min of 3 in. (76 mm) onto the spray applied fire resistive material on both sides of wall.

3M COMPANY – FireDam™ Spray 200

- B1. Fill, Void or Cavity Material* – Tape** – As an alternate to Item B, Tape cut to size and press applied within fluted areas of joint to completely cover mineral wool lapping min 2 in. (51 mm) onto the contour of the protected steel floor units and extending to lap min 1 in. (25 mm) onto the concrete wall. Additional pieces of Tape are applied along the joint to completely cover the remaining mineral wool between bottom of protected steel deck and top edge of wall along length of joint, lapping min 2 in. (51 mm) onto the contour of the protected steel floor units and min 1 in. (25 mm) onto the concrete wall. Adjoining lengths of Tape shall overlap min 1/2 in. (13 mm). Tape shall be applied at both sides of wall.

3M COMPANY – 3M Fire and Water Barrier Tape



*Indicates such products shall bear the UL or cUL Certification Mark for jurisdictions employing the UL or cUL Certification (such as Canada), respectively.

Reprinted from the Online Certifications Directory with permission from UL©

System No. HW-D-0134

June 24, 2011

Assembly Rating – 1 and 2 Hr (See Item 2)

L Rating At Ambient – 4 CFM/Lin Ft

L Rating At 400 F – 6 CFM/Lin Ft

Nominal Joint Width – 3/4 In.

Class II Movement Capabilities – 17% Compression or Extension

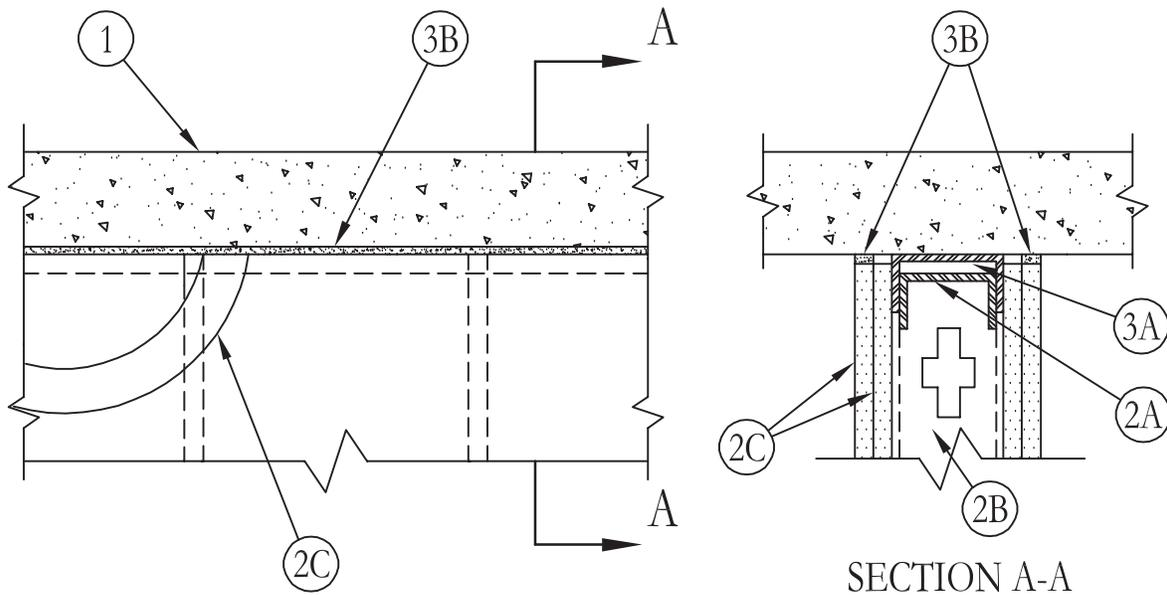

1. **Floor Assembly** – Min 4-1/2 in. (114 mm) thick lightweight or normal weight (100-150 pcf or 1600-2400 kg/m³) concrete.
2. **Wall Assembly** – The 1 or 2 fire rated gypsum wallboard/steel stud wall assembly shall be constructed of the materials and in the manner described in the individual U400 or V400 Series Wall and Partition Design in the UL Fire Resistance Directory and shall include the following construction features:
 - A. **Steel Floor And Ceiling Runners** – Floor and ceiling runners of wall assembly shall consist of galv steel channels sized to accommodate steel studs (Item 2B). When U-shaped deflection channel (Item 3A) is used, ceiling runner installed within the deflection channel with 1 in. (25 mm) gap maintained between the top of ceiling runner and top of deflection channel. When deflection channel is not used, ceiling runner secured to concrete floor slab with steel masonry anchors spaced a max of 24 in. (610 mm) OC.
 - A1. **Light Gauge Framing* – Slotted Ceiling Runner** – As an alternate to the ceiling runner in Item 2A, slotted ceiling runner to consist of galv steel channel with slotted flanges sized to accommodate steel studs (Item 2B). Slotted ceiling runner secured to concrete floor slab with steel masonry anchors spaced max 24 in. (610 mm) OC. When slotted ceiling runner is used, deflection channel (Item 3A) shall not be used.

BRADY CONSTRUCTION INNOVATIONS INC,
DBA SLIPTRACK SYSTEMS – SLP-TRK

CLARKWESTERN BUILDING SYSTEMS INC – Type SLT, SLT-H

MARINO/WARE, DIV OF WARE INDUSTRIES INC – Type SLT

METAL-LITE INC – The System

SCAFCO STEEL STUD MANUFACTURING CO

TELLING INDUSTRIES L L C – True-Action Deflection Track

- A2. **Light Gauge Framing* – Notched Ceiling Runner** – As an alternate to the ceiling runners in Items 2A through 2A2, notched ceiling runners to consist of C-shaped galv steel channel with notched return flanges sized to accommodate steel studs (Item 2B). Notched ceiling runner secured to concrete floor slab with steel masonry anchors spaced max 24 in. (610 mm) OC. When notched ceiling runner is used, deflection channel (Item 3A) shall not be used.

OLMAR SUPPLY INC – Type SCR
- B. **Studs** – Steel studs to be min 3-5/8 in. (92 mm) wide. Studs cut 1/2 to 3/4 in. (13 to 19 mm) less in length than assembly height. Studs attached to ceiling runner with sheet metal screws a min of 1/2 in. (13 mm) below bottom of deflection channel, when deflection channel is used. When deflection channel is not used, steel studs shall not be secured to ceiling runner. When slotted ceiling runner (Item 2A1) is used, steel studs secured to slotted ceiling runner with No. 8 by 1/2 in. (13 mm) long wafer head steel screws at midheight of slot on each side of wall. Stud spacing not to exceed 24 in. (610 mm) OC.
- C. **Gypsum Board*** – Gypsum board sheets installed to a min total thickness of 5/8 in. (16 mm) and 1-1/4 in. (32 mm) on each side of wall for a 1 or 2 hr rated assemblies, respectively. Wall to be constructed as specified in the individual Wall and Partition Design in the UL Fire Resistance Directory, except that a nom 3/4 in. (19 mm) gap shall be maintained between the top of the gypsum board and the lower surface of the floor. The screws attaching the gypsum board to studs at the top of the wall shall be located 1 in. (25 mm) below the bottom of the U-shaped deflection channel (Item 3A) or slotted ceiling runner (Item 2A1).

The hourly fire rating of the joint system is dependent on the hourly fire rating of the wall.

System No. HW-D-0134 *continued*

3. **Joint System – Max separation between bottom of floor and top of wall is 3/4 in. (19 mm). The joint system is designed to accommodate a max 17 percent compression or extension from its installed width.** The joint system consists of a deflection channel forming material and a fill material, as follows:
- A. **Deflection Channel – (Optional)** – A nom 3-3/4 in. (95 mm) wide by min 2 in. (51 mm) deep min 24 ga steel U-shaped channel. Deflection channel secured to concrete floor slab with steel masonry anchors or by welds spaced max 24 in. (610 mm) OC. The ceiling runner (Item 2A) is installed within the deflection channel to maintain a 1 in. (25 mm) gap between the top of the ceiling runner and the top of the deflection channel. The ceiling runner is not fastened to the deflection channel.
 - B. **Fill, Void or Cavity Material* – Caulk** – Min 5/8 in. (16 mm) thickness of fill material installed on each side of the wall between the top of the gypsum board and bottom of floor, flush with each surface of gypsum board.
- 3M COMPANY – FD-150+**

*Bearing the UL Classification Mark

Reprinted from the Online Certifications Directory with permission from Underwriters Laboratories Inc.
Copyright © 2011 Underwriters Laboratories Inc.®



Construction Joints

Head of Wall

HWD

System No. HW-D-0168

August 21, 2002

Assembly Rating – 1 and 2 Hr (See Items 2 and 3)

L Rating At Ambient – Less Than 1 CFM/Lin Ft

L Rating At 400 F – Less Than 1 CFM/Lin Ft

Nominal Joint Width – 1 In.

Class II Movement Capabilities – 25% Compression or Extension

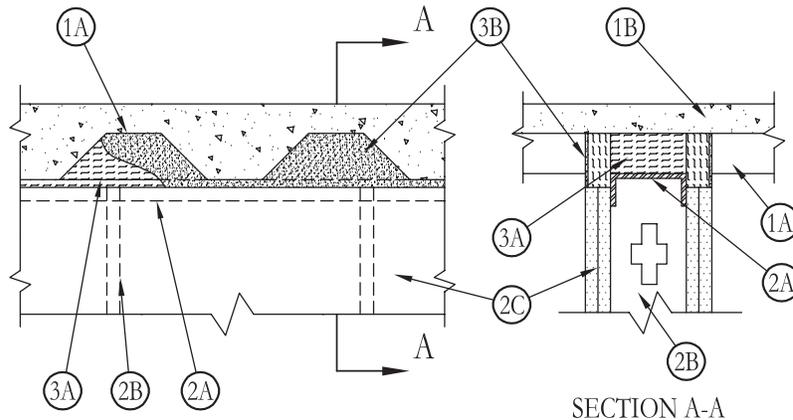

1. **Floor Assembly** – The fire rated fluted steel deck/concrete floor assembly shall be constructed of the materials and in the manner described in the individual Floor-Ceiling Design in the UL Fire Resistance Directory and shall include the following construction features:
 - A. **Steel Floor and Form Units*** – Max 3 in. deep galv steel fluted units.
 - B. **Concrete** – Min 2-1/2 in. thick reinforced concrete, as measured from the top plane of the floor units.
2. **Wall Assembly** – The 1 or 2 hr fire rated gypsum board/stud wall assembly shall be constructed of the materials and in the manner described in the individual U400 series Wall and Partition Design in the UL Fire Resistance Directory and shall include the following construction features:
 - A. **Steel Floor and Ceiling Runners** – Floor and ceiling runners of wall assembly shall consist of min No. 25 gauge galv steel channels sized to accommodate steel studs. Ceiling runner to be provided with min 1-1/2 in. flanges. Ceiling runner secured to valleys of steel floor units with steel fasteners or by welds spaced max 12 in. OC.
 - A1. **Light Gauge Framing* – Clipped Ceiling Runner** – As an alternate to the ceiling runner in Item 2A, clipped runner to consist of galv steel channel with clips preformed in track flanges which positively engage the inside flange of the steel studs (Item 2B). Track sized to accommodate steel studs (Item 2B). Track flanges to be min 2-1/2 in. Clipped ceiling runner installed perpendicular to direction of fluted steel floor units and secured to valleys with steel fasteners spaced max 12 in. OC.
TOTAL STEEL SOLUTIONS L L C – Snap Trak
 - B. **Studs** – Steel studs to be min 3-1/2 in. wide. Studs cut 5/8 in. less in length than assembly height with bottom nesting in and resting on floor runner and with top nesting in ceiling runner without attachment. Stud spacing not to exceed 24 in.
 - C. **Gypsum* Board** – Gypsum board sheets installed to a min total thickness of 5/8 in. and 1-1/4 in. on each side of wall for 1 and 2 hr rated assemblies, respectively. Wall to be constructed as specified in the individual Wall and Partition Design in the UL Fire Resistance Directory, except that a nom 1 in. gap shall be maintained between the top of the gypsum board and the bottom of the steel floor units and the top row of screws shall be installed into the studs 1 in. below the bottom of the ceiling runner.

The hourly fine rating of the joint system is equal to the hourly fire rating on the wall.
3. **Joint System** – Max width of joint (at time of installation of joint system) is 1 in. The joint system is designed to accommodate a max 25 percent compression or extension from its installed width. The joint system shall consist of the following:
 - A. **Forming Material*** – Min 4 in. thickness of min 4 pcf mineral wool batt insulation cut to the shape of the fluted deck, approx 20 percent larger than the area of the flutes and compressed into flutes of the steel floor units between the top of the ceiling runner and the steel deck and compressed in thickness to be flush with vertical leg of ceiling runner on both sides. Additional pieces of min 4 pcf mineral wool batt insulation are to be cut to the contour of the flutes with an additional 1-3/8 in. high section at the bottom of the shapes to fill the 1 in. gap between the top of the gypsum board and bottom of the steel floor units. The additional pieces of mineral wool are to be cut to min 3/4 and 1-1/2 in. thick for 1 and 2 hr rated assemblies, respectively, and compressed and firmly packed into the flutes and the gap between the top of the gypsum board and bottom of the steel floor units on both sides of the wall and compressed in thickness to be recessed from each surface of the wall to accommodate the required thickness of fill material.
HIG MINWOOL L L C – MinWool-1200 Safing
ROCKWOOL MANUFACTURING CO – Delta Safing Board
THERMAFIBER INC – Type SAF
 - B. **Fill, Void or Cavity Material* – Sealant** – Min 1/4 in. thickness of sealant installed on each side of the wall in the flutes of the steel floor units and between the top of the wall and the bottom of the steel floor units, flush with each surface of the gypsum board. An additional min 1/8 in. thickness of sealant to overlap onto gypsum board a min 1/2 in.
3M COMPANY – FB-1000 NS

*Bearing the UL Classification Mark

Reprinted from the Online Certifications Directory with permission from UL

© 2012 UL LLC

System No. HW-D-0169

August 03, 2001

Assembly Rating – 2 Hr

L Rating At Ambient – 4 CFM/Lin Ft

L Rating At 400 F – 6 CFM/Lin Ft

Nominal Joint Width – 3/4 In.

Class II Movement Capabilities – 16.6% Compression or Extension

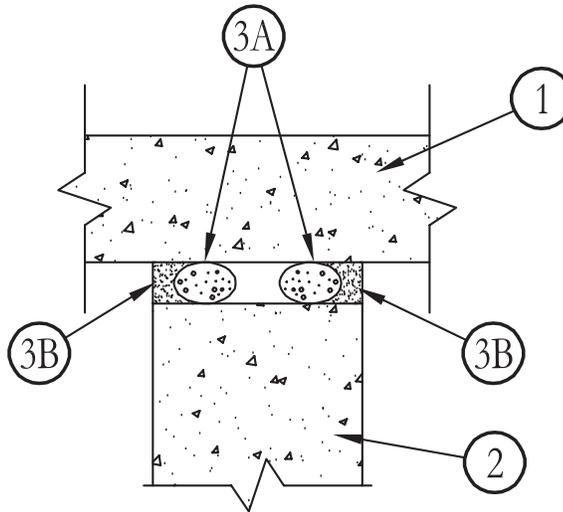

1. **Floor Assembly** – Min 4-1/2 in. thick lightweight or normal weight (100-150 pcf) concrete.
2. **Wall Assembly** – Min 7-1/2 in. thick UL Classified Concrete Blocks* or min 7-1/2 in. thick reinforced lightweight or normal weight (100-150 pcf) structural concrete.
See **Concrete Blocks (CAZT)** category in the Fire Resistance Directory for names of manufacturers.
3. **Joint System** – Max separation between bottom of floor and top of wall is 3/4 in. The joint system is designed to accommodate a max 16.6 percent compression or extension from its installed width. Max width of joint 3/4 in. The joint system consists of the following:
 - A. **Packing Material** – Nom 1 in. diam polyethylene backer rod compressed and installed into joint. Packing material to be recessed from each surface of wall as required to accommodate the required thickness of fill material.
 - B. **Fill, Void or Cavity Material* – Caulk** – Min 1/2 in. thickness of fill material installed within joints on each side of the wall, flush with each surface of the wall.

3M COMPANY – FireDam 150+

*Bearing the UL Classification Mark

Reprinted from the Online Certifications Directory with permission from Underwriters Laboratories Inc.

Copyright © 2010 Underwriters Laboratories Inc.®



System No. HW-D-0170

June 24, 2011

Assembly Rating – 1 & 2 Hr (See Items 2 & 3A)

L Rating at Ambient – Less than 1 CFM/Lin Ft.

L Rating at 400 F – Less than 1 CFM/Lin Ft.

Nominal Joint Width – 1 in.

Class II Movement Capabilities – 25% Compression & Extension

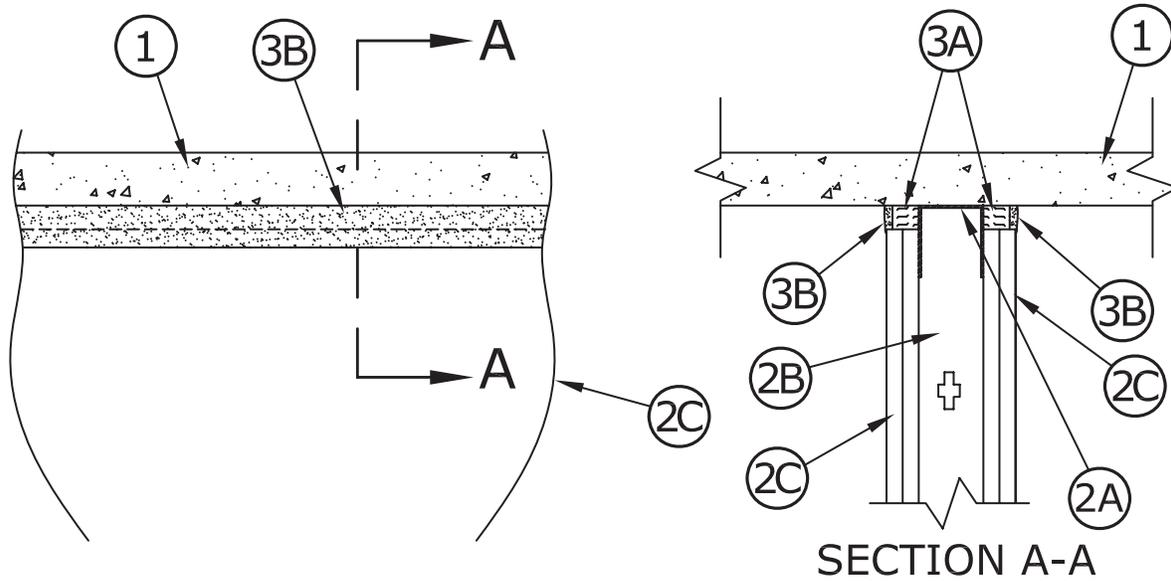

1. **Floor Assembly** – Min 4-1/2 in (114 mm) thick steel-reinforced lightweight or normal weight (100-150 pcf or 1600-2400 kg/m³) structural concrete.
2. **Wall Assembly** – The 1 or 2 hr fire rated gypsum wallboard/steel stud wall assembly shall be constructed of the materials and in the manner described in the individual U400 or V400 Series Wall and Partition Design in the UL Fire Resistance Directory and shall include the following construction features:

A. **Steel Floor And Ceiling Runners** – Floor and ceiling runners of wall assembly shall consist of min No. 25 gauge galv steel channels sized to accommodate steel studs (Item 2B). Ceiling runner to be provided with min 1-1/2 in. (38 mm) flanges. Ceiling runner secured to concrete floor slab with steel masonry anchors spaced max 24 in. (610 mm) OC.

A1. **Light Gauge Framing* – Slotted Ceiling Runner** – As an alternate to the ceiling runner in Item 2A, ceiling runner to consist of galv steel channel with slotted flanges sized to accommodate steel studs (Item 2B). Ceiling runner secured to concrete floor slab with steel masonry anchors spaced max 24 in. (610 mm) OC.

SCAFCO STEEL STUD MANUFACTURING CO

BRADY CONSTRUCTION INNOVATIONS INC,

DBA SLIPTRACK SYSTEMS – SLP-TRK

MARINO/WARE, DIV OF WARE INDUSTRIES INC – Type SLT

TELLING INDUSTRIES L L C – True-Action Deflection Track

A2. **Light Gauge Framing* – Notched Ceiling Runner** – As an alternate to the ceiling runners in Items 2A and 2A1, notched ceiling runners to consist of C-shaped galv steel channel with notched return flanges sized to accommodate steel studs (Item 2B). Notched ceiling runner secured to concrete floor slab with steel masonry anchors spaced max 24 in. (610 mm) OC.

OLMAR SUPPLY INC – Type SCR

B. **Studs** – Steel studs to be min 3-1/2 in. (89 mm) wide. Studs cut 1/2 to 3/4 in. (13 to 19 mm) less in length than assembly height with bottom nesting in and resting on floor runner and with top nesting in ceiling runner without attachment. When slotted ceiling runner is used, steel studs secured to runner with No. 8 by 1/2 in. (13 mm) long wafer head steel screws at midheight of slot on each side of wall. Stud spacing not to exceed 24 in. (610 mm) OC.

C. **Gypsum Board*** – Gypsum board sheets installed to a min total thickness of 5/8 in. (16 mm) and 1-1/4 in. (32 mm) on each side of wall for 1 and 2 hr rated assemblies, respectively. Wall to be constructed as specified in the individual Wall and Partition Design in the UL Fire Resistance Directory, except that a nom 1 in. (25 mm) gap shall be maintained between the top of the gypsum board and the lower surface of the floor and the top row of screws shall be installed into the studs 1 in. (25 mm) below the bottom of the ceiling runner.

The hourly fire rating of the joint system is equal to the hourly fire rating of the wall.

3. **Joint System** – Max separation between bottom of floor and top of wall is 1 in. (25 mm). The joint system is designed to accommodate a max 25 percent compression or extension from its installed width. The joint system consists of the following:
 - A. **Forming Material*** – Min 3/8 and 1 in. (10 and 25 mm) wide strips of min 4 pcf (64 kg/m³) mineral wool batt insulation for 1 and 2 hr rated assemblies, respectively. Mineral wool strips to be compressed approximately 33 percent in thickness to fill the max 1 in. (25 mm)

System No. HW-D-0170 *continued*

gap between top of gypsum board and bottom of floor on both sides of the wall and recessed from each surface of wall to accommodate the required thickness of fill material.

IIG MINWOOL L L C – MinWool-1200 Safing

ROCK WOOL MANUFACTURING CO – Delta Board or Delta -8

ROCKWOOL MALAYSIA SDN BHD – Type Safe

ROXUL INC – Type Safe

THERMAFIBER INC – Type SAF

- B. **Fill, Void or Cavity Material* – Sealant** – Min 1/4 in. (6 mm) thickness of sealant installed on each side of the wall between the top of the wallboard and the bottom of the floor to completely cover mineral wool. An additional min 1/8 in. (3.2 mm) thickness of sealant to overlap onto gypsum board a min of 1/2 in. (13 mm).

3M COMPANY – FireBarrier 1000 NS

*Bearing the UL Classification Mark

Reprinted from the Online Certifications Directory with permission from UL
© 2012 UL LLC

Construction Joints

Head of Wall

HWD

System No. HW-D-0171

September 28, 2001

Assembly Rating – 2 Hr

L Rating at Ambient - Less than 1 CFM/Lin Ft.

L Rating at 400 F - Less than 1 CFM/Lin Ft.

Nominal Joint Width - 1 in.

Class II Movement Capabilities - 25% Compression & Extension

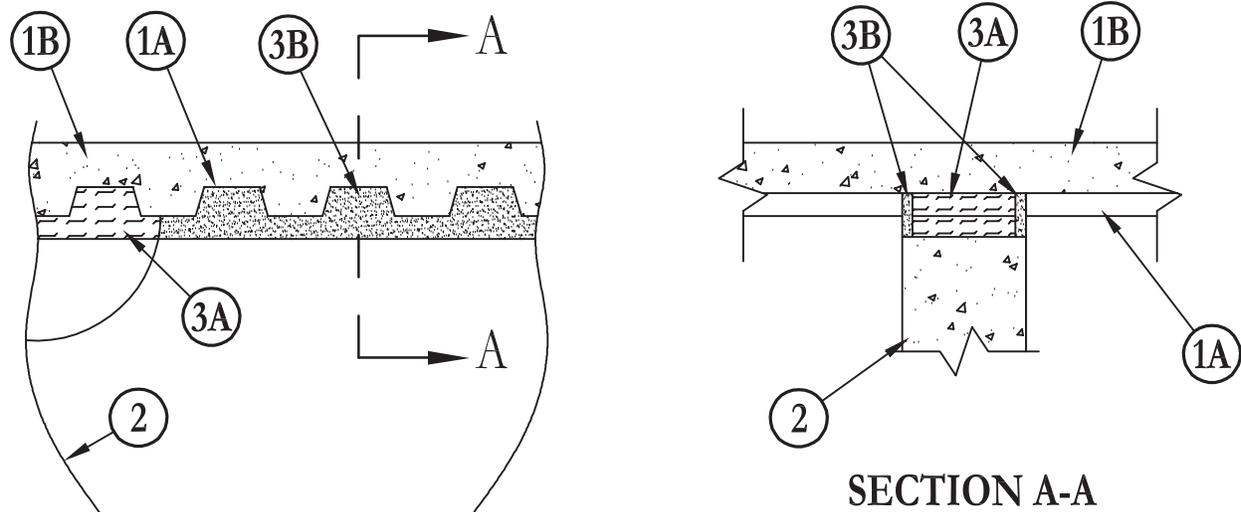
**SECTION A-A**

1. **Floor Assembly** – The fire-rated fluted steel deck/concrete floor assembly shall be constructed of the materials and in the manner described in the individual Floor-Ceiling Design in the UL Fire Resistance Directory and shall include the following construction features:
 - A. **Steel Floor And Form Units*** – Max 3 in. deep galv steel fluted floor deck.
 - B. **Concrete** – Min 2-1/2 in. thick reinforced concrete, as measured from the top plane of the floor units.
- 1A. **Roof Assembly** – (Not Shown) - As an alternate to the floor assembly, a fire rated fluted steel deck roof assembly may be used. The roof assembly shall be constructed of the materials and in the manner described in the individual P900 Series Roof-Ceiling Design in the UL Fire Resistance Directory. The hourly rating of the roof assembly shall be equal to or greater than the hourly rating of the wall assembly and shall include the following construction features:
 - A. **Steel Roof Deck** – Max 3 in. deep galv steel fluted roof deck.
 - B. **Roof Insulation** – Min 2-1/4 in. thick poured insulating concrete, as measured from the top plane of the deck.
2. **Wall Assembly** – Min 6-1/8 in. thick steel-reinforced lightweight or normal weight (100-150 pcf) concrete. Wall may also be constructed of any UL Classified **Concrete Blocks***.
See **Concrete Blocks (CAZT)** category in Fire Resistance Directory for names of manufacturers
3. **Joint System** – Max separation between bottom of floor or roof and top of wall is 1 in. The joint system is designed to accommodate a max 25 percent compression or extension from its installed width. The joint system consists of the following:
 - A. **Forming Material*** – Min 4 pcf mineral wool batt insulation cut into min 5-5/8 in. wide strips, compressed approximately 33 percent in thickness to fill the max 1 in. gap between top of wall and bottom of steel floor or roof deck. Min 5-5/8 in. width of min 4 pcf mineral wool batt insulation cut to the shape of the fluted deck, approximately 20 percent larger than the area of the flutes, firmly packed into the flutes. Mineral wool to be recessed from both surfaces of wall to accommodate the required thickness of fill material.
IIG MINWOOL L L C – MinWool-1200 Safing
ROCK WOOL MANUFACTURING CO – Delta Board or Delta -8
ROCKWOOL MALAYSIA SDN BHD – Type Safe
ROXUL INC – Type Safe
THERMAFIBER INC – Type SAF
 - B. **Fill, Void or Cavity Material* – Sealant** – Min 1/4 in. thickness of sealant installed on each side of wall in the flutes of steel floor or roof deck and between top of wall and bottom of floor to completely cover mineral wool, flush with each surface of wall. .
3M COMPANY – FireBarrier 1000 NS

*Bearing the UL Classification Mark

Reprinted from the Online Certifications Directory with permission from UL

© 2012 UL LLC

System No. HW-D-0172

September 28, 2001

Assembly Rating – 2 Hr

L Rating at Ambient – Less than 1 CFM/Lin Ft.

L Rating at 400 F – Less than 1 CFM/Lin Ft.

Nominal Joint Width – 1 in.

Class II Movement Capabilities – 25% Compression & Extension

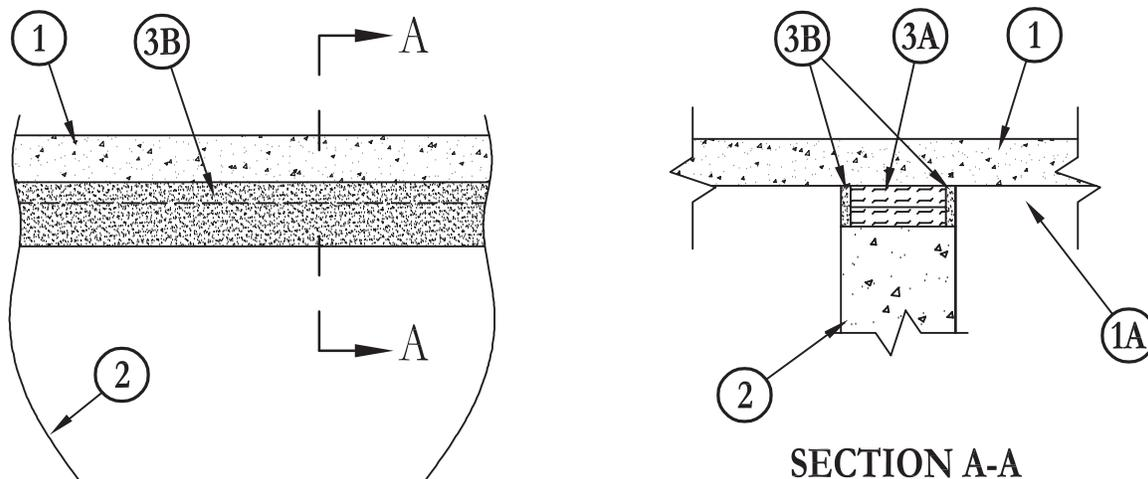

- Floor Assembly** – Min 4-1/2 in thick steel-reinforced lightweight or normal weight (100-150 pcf) structural concrete.
- Wall Assembly** – Min 6-1/8 in. thick steel-reinforced lightweight or normal weight (100-150 pcf) concrete. Wall may also be constructed of any UL Classified **Concrete Blocks***.
See **Concrete Blocks (CAZT)** category in Fire Resistance Directory for names of manufacturers
- Joint System** – Max separation between bottom of floor and top of wall is 1 in. The joint system is designed to accommodate a max 25 percent compression or extension from its installed width. The joint system consists of the following:
 - Forming Material*** – Min 4 pcf mineral wool batt insulation cut into min 5-5/8 in. wide strips, compressed approximately 33 percent in thickness to fill the max 1 in. gap between the top of wall and bottom of floor. Mineral wool to be recessed from both surfaces of wall to accommodate the required thickness of fill material
IIG MINWOOL L L C – MinWool-1200 Safing
ROCK WOOL MANUFACTURING CO – Delta Board or Delta -8
ROCKWOOL MALAYSIA SDN BHD – Type Safe
ROXUL INC – Type Safe
THERMAFIBER INC – Type SAF
 - Fill, Void or Cavity Material* – Sealant** – Min 1/4 in. thickness of sealant installed on each side of wall between top of wall and bottom of floor, flush with each surface of wall.
3M COMPANY – FireBarrier 1000 NS

*Bearing the UL Classification Mark

Reprinted from the Online Certifications Directory with permission from UL

© 2012 UL LLC

System No. HW-D-0173

June 24, 2011

Assembly Rating – 1 & 2 Hr (See Items 2 & 3A)

L Rating at Ambient – Less than 1 CFM/Lin Ft.

L Rating at 400 F – Less than 1 CFM/Lin Ft.

Nominal Joint Width – 1 in.

Class II Movement Capabilities – 25% Compression & Extension

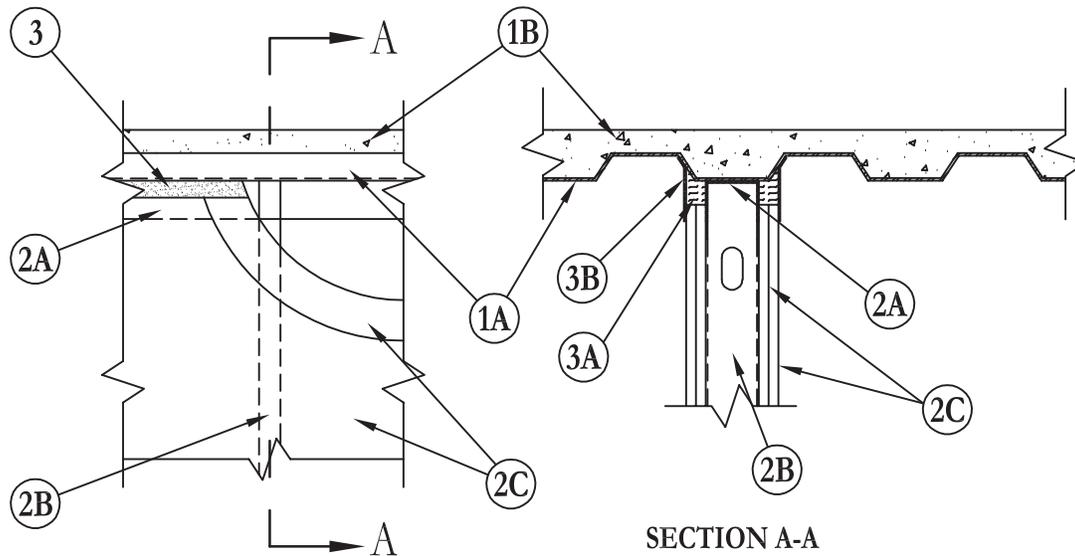

1. **Floor Assembly** – The fire-rated fluted steel deck/concrete floor assembly shall be constructed of the materials and in the manner described in the individual Floor-Ceiling Design in the UL Fire Resistance Directory and shall include the following construction features:
 - A. **Steel Floor And Form Units*** – Max 3 in. (76 mm) deep galv steel fluted roof deck.
 - B. **Concrete** – Min 2-1/2 in. (64 mm) thick reinforced concrete, as measured from the top plane of the floor units.
- 1A. **Roof Assembly** – (Not Shown) – As an alternate to the floor assembly, a fire rated fluted steel deck roof assembly may be used. The roof assembly shall be constructed of the materials and in the manner described in the individual P900 Series Roof-Ceiling Design in the UL Fire Resistance Directory. The hourly rating of the roof assembly shall be equal to or greater than the hourly rating of the wall assembly and shall include the following construction features:
 - A. **Steel Roof Deck** – Max 3 in. (76 mm) deep galv steel fluted roof deck
 - B. **Roof Insulation** – Min 2-1/4 in. (57 mm) thick poured insulating concrete, as measured from the top plane of the deck.
2. **Wall Assembly** – The 1 or 2 hr fire rated gypsum board/steel stud wall assembly shall be constructed of the materials and in the manner described in the individual U400 or V400 Series Wall and Partition Design in the UL Fire Resistance Directory and shall include the following construction features:
 - A. **Steel Floor And Ceiling Runners** – Floor and ceiling runners of wall assembly shall consist of min No. 25 gauge galv steel channels sized to accommodate steel studs (Item 2B). Ceiling runner to be provided with min 1-1/2 in. (38 mm) flanges. Ceiling runner installed parallel to direction of fluted steel deck, centered beneath valley, and secured with steel masonry anchors or welds spaced max 24 in. (610 mm) OC.
 - A1. **Light Gauge Framing* – Slotted Ceiling Runner** – As an alternate to the ceiling runner in Item 2A, ceiling runner to consist of galv steel channel with slotted flanges sized to accommodate steel studs (Item 2B). Ceiling runner installed parallel to direction of fluted steel deck, centered beneath valley, and secured with steel masonry anchors spaced max 24 in. (610 mm) OC.

SCAFCO STEEL STUD MANUFACTURING CO
BRADY CONSTRUCTION INNOVATIONS INC,
DBA SLIPTRACK SYSTEMS – SLP-TRK
MARINO/WARE, DIV OF WARE INDUSTRIES INC – Type SLT
TELLING INDUSTRIES L L C – True-Action Deflection Track
 - A2. **Light Gauge Framing* – Notched Ceiling Runner** – As an alternate to the ceiling runners in Items 2A and 2A1, notched ceiling runners to consist of C-shaped galv steel channel with notched return flanges sized to accommodate steel studs (Item 2B). Notched ceiling runner installed parallel to direction of fluted steel deck, centered beneath valley, and secured with steel masonry anchors spaced max 24 in. (610 mm) OC.

OLMAR SUPPLY INC – Type SCR
 - B. **Studs** – Steel studs to be min 3-1/2 in. (89 mm) wide. Studs cut 1/2 to 3/4 in. (13 to 19 mm) less in length than assembly height with bottom nesting in and resting on floor runner and with top nesting in ceiling runner without attachment. When slotted ceiling runner is used, steel studs secured to runner with No. 8 by 1/2 in. (13 mm) long wafer head steel screws at midheight of slot on each side of wall. Stud spacing not to exceed 24 in. (610 mm) OC.
 - C. **Gypsum Board*** – Gypsum board sheets installed to a min total thickness of 5/8 in. (16 mm) and 1-1/4 in. (32 mm) on each side of wall for 1 and 2 hr rated assemblies, respectively. Wall to be constructed as specified in the individual Wall and Partition Design in the UL

System No. HW-D-0173 *continued*

Fire Resistance Directory, except that a max 1 in. (25 mm) gap shall be maintained between the top of the gypsum board and the lower surface of the floor or roof and the top row of screws shall be installed into the studs 1 in. (25 mm) below the bottom of the ceiling runner.

The hourly fire rating of the joint system is equal to the hourly fire rating of the wall.

3. **Joint System – Max separation between bottom of floor or roof and top of wall is 1 in. (25 mm). The joint system is designed to accommodate a max 25 percent compression or extension from its installed width.** The joint system consists of the following:
- A. **Forming Material*** – Min 3/8 and 1 in. (10 and 25 mm) wide strips of min 4 pcf (64kg/m³) mineral wool batt insulation for 1 and 2 hr rated assemblies, respectively. Mineral wool strips to be compressed approximately 33 percent in thickness to fill the max 1 in. gap between the top of gypsum board and bottom of steel floor or roof deck on both sides of the wall and recessed from each surface of wall to accommodate the required thickness of fill material.
- IIG MINWOOL L L C** – MinWool-1200 Safing
ROCK WOOL MANUFACTURING CO – Delta Board or Delta -8
ROCKWOOL MALAYSIA SDN BHD – Type Safe
ROXUL INC – Type Safe
THERMAFIBER INC – Type SAF
- B. **Fill, Void or Cavity Material* – Sealant** – Min 1/4 in. (6 mm) thickness of sealant installed on each side of wall in the flutes of steel floor or roof deck and between top of wall and bottom of steel floor or roof deck to completely cover mineral wool, flush with each surface of wall. An additional min 1/8 in. (3.2 mm) thickness of sealant to overlap onto gypsum board a min of 1/2 in. (13 mm)
- 3M COMPANY** – FireBarrier 1000 NS

*Bearing the UL Classification Mark

Reprinted from the Online Certifications Directory with permission from UL
© 2012 UL LLC

System No. HW-D-0174

September 28, 2001

Assembly Rating – 2 Hr

L Rating at Ambient - Less than 1 CFM/Lin Ft.

L Rating at 400 F - Less than 1 CFM/Lin Ft.

Nominal Joint Width - 1 in.

Class II Movement Capabilities - 25% Compression & Extension

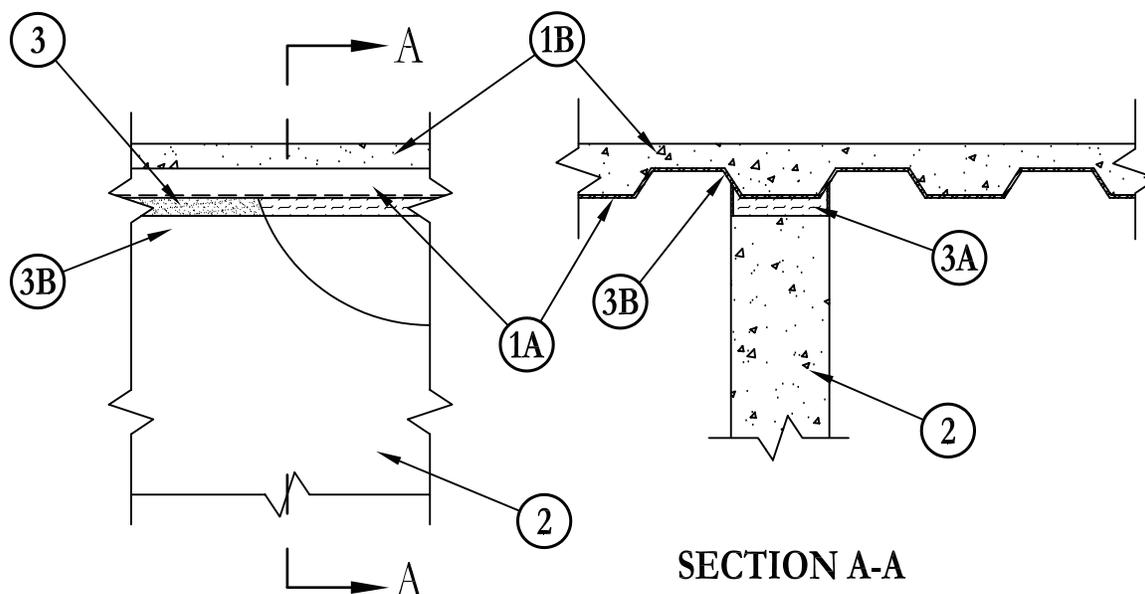
**SECTION A-A**

1. **Floor Assembly** – The fire-rated fluted steel deck/concrete floor assembly shall be constructed of the materials and in the manner described in the individual Floor-Ceiling Design in the UL Fire Resistance Directory and shall include the following construction features:
 - A. **Steel Floor And Form Units*** – Max 3 in. deep galv steel fluted roof deck.
 - B. **Concrete** – Min 2-1/2 in. thick reinforced concrete, as measured from the top plane of the floor units.
- 1A. **Roof Assembly** – (Not Shown) - As an alternate to the floor assembly, a fire rated fluted steel deck roof assembly may be used. The roof assembly shall be constructed of the materials and in the manner described in the individual P900 Series Roof-Ceiling Design in the UL Fire Resistance Directory. The hourly rating of the roof assembly shall be equal to or greater than the hourly rating of the wall assembly and shall include the following construction features:
 - A. **Steel Roof Deck** – Max 3 in. deep galv steel fluted roof deck.
 - B. **Roof Insulation** – Min 2-1/4 in. thick poured insulating concrete, as measured from the top plane of the deck.
2. **Wall Assembly** – Min 6-1/8 in. thick steel-reinforced lightweight or normal weight (100-150 pcf) concrete. Wall may also be constructed of any UL Classified **Concrete Blocks***.
See **Concrete Blocks (CAZT)** category in Fire Resistance Directory for names of manufacturers
3. **Joint System** – Max separation between bottom of floor or roof and top of wall is 1 in. The joint system is designed to accommodate a max 25 percent compression or extension from its installed width. The joint system consists of the following:
 - A. **Forming Material*** – Min 4 pcf mineral wool batt insulation cut into min 5-5/8 in. wide strips, compressed approximately 33 percent in thickness to fill the max 1 in. gap between top of wall and bottom of steel floor or roof deck and recessed from both surfaces of wall to accommodate the required thickness of fill material.
HIG MINWOOL L L C – MinWool-1200 Safing
ROCKWOOL MANUFACTURING CO – Delta Board or Delta -8
ROCKWOOL MALAYSIA SDN BHD – Type Safe
ROXUL INC – Type Safe
THERMAFIBER INC – Type SAF
 - B. **Fill, Void or Cavity Material* – Sealant** – Min 1/4 in. thickness of sealant installed on each side of wall between top of wall and bottom of floor or roof, flush with each surface of wall.
3M COMPANY – FireBarrier 1000 NS

*Bearing the UL Classification Mark

Reprinted from the Online Certifications Directory with permission from UL
© 2012 UL LLC

System No. HW-D-0178

August 21, 2002

Assembly Rating – 1 and 2 Hr (See Items 2 and 3)

L Rating At Ambient – 4 CFM/Lin Ft

L Rating At 400 F – 6 CFM/Lin Ft

Nominal Joint Width – 1 In.

Class II Movement Capabilities – 18.75% Compression or Extension

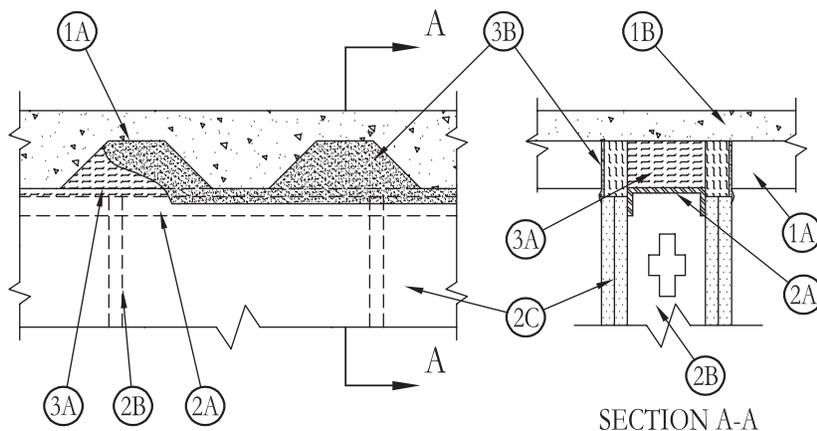

- 1. Floor Assembly** – The fire rated fluted steel deck/concrete floor assembly shall be constructed of the materials and in the manner described in the individual Floor-Ceiling Design in the UL Fire Resistance Directory and shall include the following construction features:
 - A. Steel Floor and Form Units*** – Max 3 in. deep galv steel fluted units.
 - B. Concrete** – Min 2-1/2 in. thick reinforced concrete, as measured from the top plane of the floor units.
- 2. Wall Assembly** – The 1 or 2 hr fire rated gypsum board/stud wall assembly shall be constructed of the materials and in the manner described in the individual U400 series Wall and Partition Design in the UL Fire Resistance Directory and shall include the following construction features:

- A. Steel Floor and Ceiling Runners** – Floor and ceiling runners of wall assembly shall consist of min No. 25 gauge galv steel channels sized to accommodate steel studs. Ceiling runner to be provided with min 1-1/4 in. flanges. Ceiling runner secured to valleys of steel floor units with steel fasteners or by welds spaced max 12 in. OC.
- A1. Light Gauge Framing* – Clipped Ceiling Runner** – As an alternate to the ceiling runner in Item 2A, clipped runner to consist of galv steel channel with clips preformed in track flanges which positively engage the inside flange of the steel studs (Item 2B). Track sized to accommodate steel studs (Item 2B). Track flanges to be min 2-1/2 in. Clipped ceiling runner installed perpendicular to direction of fluted steel floor units and secured to valleys with steel fasteners spaced max 12 in. OC.

TOTAL STEEL SOLUTIONS L L C – Snap Trak

- B. Studs** – Steel studs to be min 3-1/2 in. wide. Studs cut 5/8 in. less in length than assembly height with bottom nesting in and resting on floor runner and with top nesting in ceiling runner without attachment. Stud spacing not to exceed 24 in.
- C. Gypsum Board*** – Gypsum board sheets installed to a min total thickness of 5/8 in. and 1-1/4 in. on each side of wall for 1 and 2 hr rated assemblies, respectively. Wall to be constructed as specified in the individual Wall and Partition Design in the UL Fire Resistance Directory, except that a nom 1 in. gap shall be maintained between the top of the gypsum board and the bottom of the steel floor units and the top row of screws shall be installed into the studs 1 in. below the bottom of the ceiling runner.

The hourly fire rating of the joint system is equal to the hourly fire rating of the wall.

- 3. Joint System** – Max width of joint (at time of installation of joint system) is 1 in. The joint system is designed to accommodate a max 18.75 percent compression or extension from its installed width. The joint system shall consist of the following:
 - A. Forming Material*** – Min 4 in. thickness of min 4 pcf mineral wool batt insulation cut to the shape of the fluted deck, approx 20 percent larger than the area of the flutes and compressed into flutes of the steel floor units between the top of the ceiling runner and the steel deck and compressed in thickness to be flush with vertical leg of ceiling runner on both sides. Additional pieces of min 4 pcf mineral wool batt insulation are to be cut to the contour of the flutes with an additional 1-3/8 in. high section at the bottom of the shapes to fill the 1 in. gap between the top of the wallboard and bottom of the steel floor units. The additional pieces of mineral wool are to be cut to min 3/4 and 1-1/2 in. thick for 1 and 2 hr rated assemblies, respectively and compressed and firmly packed into the flutes and the gap between the top of the gypsum board and bottom of the steel floor units on both sides of the wall and compressed in thickness to be recessed from each surface of the wall to accommodate the required thickness of fill material.

IIG MINWOOL L L C – MinWool-1200 Safing
ROCK WOOL MANUFACTURING CO – Delta Safing Board
THERMAFIBER INC – Type SAF
 - B. Fill, Void or Cavity Material* – Caulk** – Min 1/4 in. thickness of caulk installed on each side of the wall in the flutes of the steel floor units and between the top of the wall and the bottom of the steel floor units, flush with each surface of the gypsum board. An additional min 1/8 in. thickness of caulk to overlap onto gypsum board a min 1/2 in.

3M COMPANY – FireDam 150+

*Bearing the UL Classification Mark

Reprinted from the Online Certifications Directory with permission from UL

© 2012 UL LLC



| ANSI/UL2079 | CAN/ULC S115 |
|---|---|
| Assembly Ratings – 1 and 2 Hr (See Item 2) | F Ratings – 1 and 2 Hr (See Item 2) |
| Nominal Joint Width – 2 In. | FT Ratings – 1 and 2 Hr (See Item 2) |
| Class II Movement Capabilities – 13% Compression or Extension | FH Ratings – 1 and 2 Hr (See Item 2) |
| | FTH Ratings – 1 and 2 Hr (See Item 2) |
| | Nominal Joint Width – 51 mm |
| | Class II Movement Capabilities – 13% Compression or Extension |

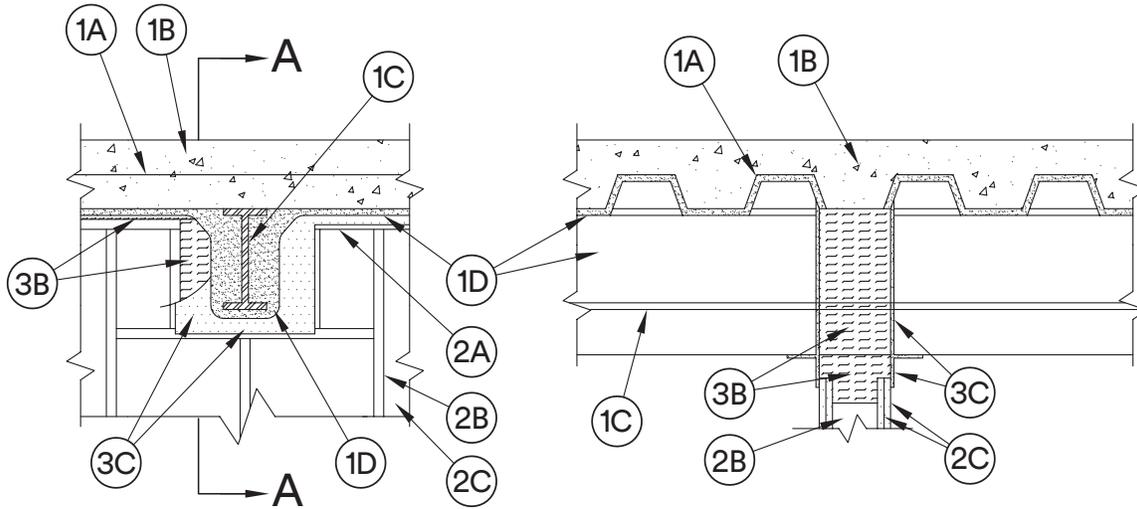

SECTION A-A

- Floor Assembly** – The fire-rated fluted steel deck/concrete floor assembly shall be constructed of the materials and in the manner described in the individual D700 or D900 Series Floor-Ceiling Design in the UL Fire Resistance Directory and shall include the following construction features:
 - Steel Floor and Floor Units*** – Max 3 in. (76 mm) deep galv steel fluted floor units
 - Concrete** – Min 2-1/2 in. (64 mm) thick reinforced concrete, as measured from the top plane of the floor units.
 - Structural Steel Support** – (Optional) –Steel beam or open-web steel joist, as specified in the individual D700 or D900 Series Floor-Ceiling Design, used to support steel floor units. Structural steel support oriented perpendicular to wall assembly. Where open-web steel joists pass through the fire rated wall, 3/8 in. (10 mm) diamond mesh expanded steel lath having a nom weight of 1.7 to 3.4 lb per sq yd (0.9-1.8 kg/m²) shall be secured to one side of each joist with steel tie wire and the lath shall be fully covered with spray applied fire resistive material with no min thickness requirement.
 - Spray-Applied Fire Resistive Material*** – After installation of the ceiling runner (Item 2A) or deflection track (Item 3A, if used), steel floor units and structural steel supports to be sprayed in accordance with the specifications in the individual D700 Series Design or the structural steel supports to be sprayed in accordance with the specifications in the individual D900 Series Design .

GCP APPLIED TECHNOLOGIES INC – Type MK-6/HY
- Wall Assembly** – The 1 or 2 hr fire-rated gypsum board/stud wall assembly shall be constructed of the materials and in the manner described in the individual U400, V400 or W400 Series Wall and Partition Design in the UL Fire Resistance Directory and shall include the following construction features:
 - Steel Floor and Ceiling Runners** – Floor and ceiling runners of wall assembly shall consist of galv steel channels sized to accommodate steel studs (Item 2B). Ceiling runner to be provided with min 1-1/4 in. (32 mm) to max 3 in. (76 mm) flanges. When deflection channel (Item 3A) is used, the ceiling runner is to nest within the deflection channel with a 1/2 in. to 1 in. (13 to 25 mm) gap maintained between the top of the ceiling runner and the top of the deflection channel. When deflection channel is not used, ceiling runner to be provided with min 3 in. (76 mm) flanges and secured to steel floor units (Item 1A) with steel fasteners or welds spaced max 24 in. (610 mm) OC. Ceiling runner to be centered beneath and parallel with valley of steel floor unit. A clearance of 1 to 1-1/4 in. (25 to 32 mm) shall be maintained between the end of the ceiling runner or deflection channel and the spray applied fire resistive material on the structural steel support members.

- B. Studs** – Steel studs to be min 3-5/8 in. (92 mm) wide. Studs cut 1/2 in. to 1 in. (13 to 25 mm) less in length than assembly height with bottom nesting in and secured to floor runner. When deflection channel (Item 3A) is used, steel studs attached to ceiling runner (Item 2A) with sheet metal screws. When deflection channel is not used, studs to nest in ceiling runner without attachment. A framed opening shall be constructed around each structural steel support member. A min clearance of 1 in. (25 mm) to a max clearance of 3 in. (76 mm) shall be maintained between the framing and the spray applied fire resistive material on the two sides of the structural support member. The clearance between the framing and the spray applied fire resistive material on the bottom of the structural steel support member shall be 1 in. (25 mm).
- C. Gypsum Board*** – Gypsum board sheets installed to a min total 5/8 in. (16 mm) or 1-1/4 in. (32 mm) thickness on each side of wall for 1 and 2 hr fire rated assemblies, respectively. Wall to be constructed as specified in the individual U400, V400 or W400 Series Design in the UL Fire Resistance Directory, except that a max 2 in. (51 mm) gap shall be maintained between the top of the gypsum board and the spray applied fire resistive material on the steel floor units when D700 series assembly is used or between the top of the gypsum board the steel floor units when D900 series assembly is used. Also, a 1 in. (25 mm) gap shall be maintained between the top edge of the gypsum board and the spray applied fire resistive material on the structural steel support member. The screws attaching the gypsum board to the studs along the top of the wall shall be located 1 in. (25 mm) below the bottom of the ceiling runner or the optional deflection channel. No gypsum board attachment screws shall be driven into the ceiling runner or into the optional deflection channel.

The hourly fire rating of the joint system is equal to the hourly fire rating of the wall.

- 3. Joint System – Max separation between bottom of the spray applied fire resistive material on the steel floor units and top of gypsum board (at time of installation of joint system) is 2 in. (51 mm) when D700 series assembly is used. Max separation between bottom of the steel floor units and top of gypsum board (at time of installation of joint system) is 2 in. (51 mm) when D900 series assembly is used. Max separation between spray applied fire resistive material on bottom of structural support member and framed opening in top of wall is 1 in. (25 mm). The joint system is designed to accommodate a max 13 percent compression or extension from it's installed width as measured between the spray applied fire resistive material on the steel floor units and the top of the gypsum board.** The joint system shall consist of forming and fill materials, with or without a deflection channel (Item 3A), as follows:

- A. Deflection Channel** – (Optional, Not Shown) - Min 24 gauge galv steel channel, 3 in. (76 mm) deep, sized to accommodate ceiling runner (Item 2A). Deflection channel to be centered beneath and parallel with valley of steel floor unit and secured to steel floor unit with steel fasteners or welds spaced max 24 in. (610 mm) OC. The ceiling runner (Item 2A) is installed within the deflection channel to maintain a 1/2 to 1 in. (13 to 25 mm) gap between the top of the ceiling runner and the top of the deflection channel. A clearance of 1 to 1-1/4 in. (25 to 32 mm) shall be maintained between the end of the deflection channel and the spray applied fire resistive material on the structural steel support members. The ceiling runner nests inside the deflection channel without attachment.
- B. Forming Material*** – Nom 4 pcf (64 kg/m³) mineral wool batt insulation cut to a length approx the same as the overall thickness of wall and inserted cut edge first into the spaces between the spray applied fire resistive material on the structural steel member and the framed notch at the top of the wall, flush with the gypsum board surface on both sides of the wall. The thickness of forming material shall be sufficient to attain a min compression of 25 percent between the sides of the framed notch and the protected structural steel member between the bottom of the framed notch and the bottom of the protected structural steel member. Additional sections of mineral wool batt insulation are compressed 25 percent in thickness and are installed cut edge first to completely fill the gap above the top of the gypsum board, flush with both surfaces of wall.

INDUSTRIAL INSULATION GROUP LLC – MinWool-1200 Safing

JOHNS MANVILLE – Safing

ROCK WOOL MANUFACTURING CO – Delta Board

ROCKWOOL MALAYSIA SDN BHD – Type Safe

ROCKWOOL – Type Safe

THERMAFIBER INC – Type SAF

- C. Fill, Void or Cavity Material*** – Min 1/16 in. (1.6 mm) dry thickness (min 1/8 in. or 3.2 mm wet thickness) of fill material spray applied over the forming material on each side of the wall. Fill material to overlap a min of 1/2 in. (13 mm) onto the gypsum board and a min 2 in. (51 mm) onto the deck or the spray applied material (Item 1C) on the steel floor unit and on the structural steel support member on both sides of wall.

3M COMPANY – FireDam™ Spray 200

- C1. Fill, Void or Cavity Material* – Tape** – As an alternate to Item C, Tape cut to size and press applied to completely cover mineral wool between bottom of floor and top of wall. Tape to overlap a min of 1 in. (25 mm) onto the gypsum board and a min 2 in. (51 mm) onto the deck or the spray applied material (Item 1C) on the steel floor unit and on the structural steel support member on both sides of wall. All adjoining lengths of Tape shall overlap min 1/2 in. (13 mm).

3M COMPANY – 3M Fire and Water Barrier Tape



*Indicates such products shall bear the UL or cUL Certification Mark for jurisdictions employing the UL or cUL Certification (such as Canada), respectively.

Reprinted from the Online Certifications Directory with permission from UL©

System No. HW-D-0204

September 28, 2001

Assembly Rating – 2 Hr

L Rating at Ambient – Less than 1 CFM/Lin Ft.

L Rating at 400 F – Less than 1 CFM/Lin Ft.

Nominal Joint Width – 1 in.

Class II Movement Capabilities – 18.75% Compression & Extension

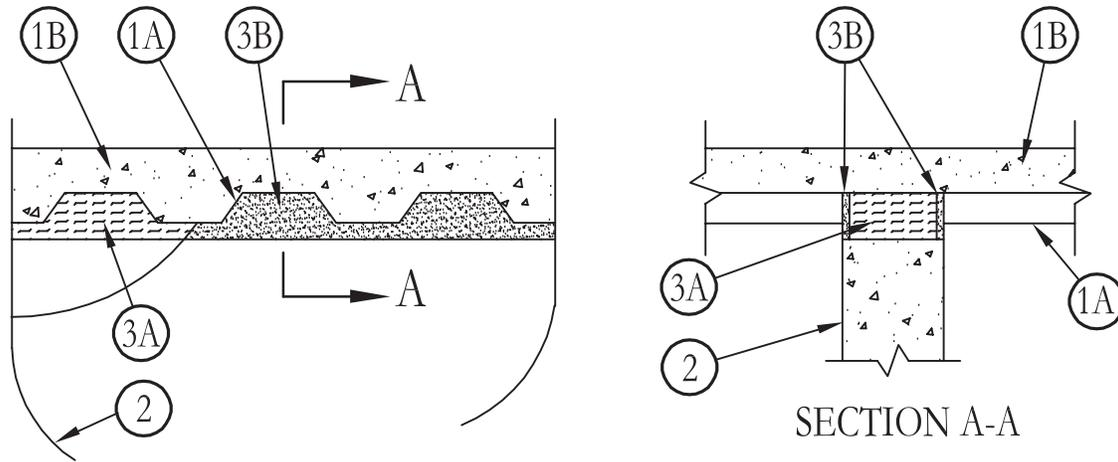

1. **Floor Assembly** – The fire-rated fluted steel deck/concrete floor assembly shall be constructed of the materials and in the manner described in the individual Floor-Ceiling Design in the UL Fire Resistance Directory and shall include the following construction features:
 - A. **Steel Floor And Form Units*** – Max 2 in. deep galv steel fluted roof deck.
 - B. **Concrete** – Min 2-1/2 in. thick reinforced concrete, as measured from the top plane of the floor units.
- 1A. **Roof Assembly** – (Not Shown) - As an alternate to the floor assembly, a fire rated fluted steel deck roof assembly may be used. The roof assembly shall be constructed of the materials and in the manner described in the individual P900 Series Roof-Ceiling Design in the UL Fire Resistance Directory. The hourly rating of the roof assembly shall be equal to or greater than the hourly rating of the wall assembly and shall include the following construction features:
 - A. **Steel Roof Deck** – Max 2 in. deep galv steel fluted roof deck.
 - B. **Roof Insulation** – Min 2-1/4 in. thick poured insulating concrete, as measured from the top plane of the deck.
2. **Wall Assembly** – Min 6-1/8 in. thick steel-reinforced lightweight or normal weight (100-150 pcf) concrete. Wall may also be constructed of any UL Classified **Concrete Blocks***.
See **Concrete Blocks (CAZT)** category in Fire Resistance Directory for names of manufacturers
3. **Joint System** – Max separation between bottom of floor or roof and top of wall is 1 in. The joint system is designed to accommodate a max 18.75 percent compression or extension from its installed width. The joint system consists of the following:
 - A. **Forming Material*** – Min 4 pcf mineral wool batt insulation cut into min 5-5/8 in. wide strips, compressed approximately 33 percent in thickness to fill the max 1 in. gap between top of wall and bottom of steel floor or roof deck. Min 5-5/8 in. width of min 4 pcf mineral wool batt insulation cut to the shape of the fluted deck, approximately 20 percent larger than the area of the flutes, firmly packed into the flutes. Mineral wool to be recessed from both surfaces of wall to accommodate the required thickness of fill material.
HIG MINWOOL L L C – MinWool-1200 Safing
ROCKWOOL MANUFACTURING CO – Delta Board or Delta -8
ROCKWOOL MALAYSIA SDN BHD – Type Safe
ROXUL INC – Type Safe
THERMAFIBER INC – Type SAF
 - B. **Fill, Void or Cavity Material* – Sealant** – Min 1/4 in. thickness of sealant installed on each side of wall in the flutes of steel floor or roof deck and between top of wall and bottom of floor to completely cover mineral wool, flush with each surface of wall. .
3M COMPANY – FireDam 150+

*Bearing the UL Classification Mark

Reprinted from the Online Certifications Directory with permission from UL

© 2012 UL LLC



System No. HW-D-0205

June 24, 2011

Assembly Rating – 1 & 2 Hr (See Items 2 & 3A)

L Rating at Ambient – Less than 1 CFM/Lin Ft.

L Rating at 400 F – Less than 1 CFM/Lin Ft.

Nominal Joint Width – 1 in.

Class II Movement Capabilities – 19% Compression & Extension

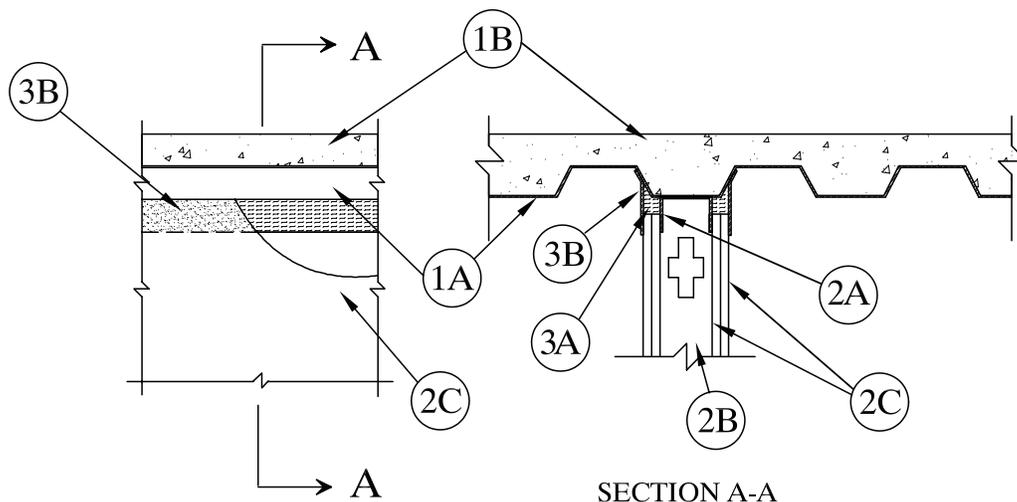

1. **Floor Assembly** – The fire-rated fluted steel deck/concrete floor assembly shall be constructed of the materials and in the manner described in the individual Floor-Ceiling Design in the UL Fire Resistance Directory and shall include the following construction features:
 - A. **Steel Floor And Form Units*** – Max 3 in. (76 mm) deep galv steel fluted floor deck.
 - B. **Concrete** – Min 2-1/2 in. (64 mm) thick reinforced concrete, as measured from the top plane of the floor units.
- 1A. **Roof Assembly** – (Not Shown) - As an alternate to the floor assembly, a fire rated fluted steel deck roof assembly may be used. The roof assembly shall be constructed of the materials and in the manner described in the individual P900 Series Roof-Ceiling Design in the UL Fire Resistance Directory. The hourly rating of the roof assembly shall be equal to or greater than the hourly rating of the wall assembly and shall include the following construction features:
 - A. **Steel Roof Deck** – Max 3 in. (76 mm) deep galv steel fluted roof deck.
 - B. **Roof Insulation** – Min 2-1/4 in. (57 mm) thick poured insulating concrete, as measured from the top plane of the deck.
2. **Wall Assembly** – The 1 or 2 hr fire rated gypsum wallboard/steel stud wall assembly shall be constructed of the materials and in the manner described in the individual U400 or V400 Series Wall and Partition Design in the UL Fire Resistance Directory and shall include the following construction features:
 - A. **Steel Floor And Ceiling Runners** – Floor and ceiling runners of wall assembly shall consist of min No. 25 gauge galv steel channels sized to accommodate steel studs (Item 2B). Ceiling runner to be provided with min 1-1/2 in. (38 mm) flanges. Ceiling runner installed parallel to direction of fluted steel deck, centered beneath valley, and secured with steel masonry anchors or welds spaced max 24 in. (610 mm) OC.
 - A1. **Light Gauge Framing* – Slotted Ceiling Runner** – As an alternate to the ceiling runner in Item 2A, ceiling runner to consist of galv steel channel with slotted flanges sized to accommodate steel studs (Item 2B). Ceiling runner installed parallel to direction of fluted steel deck, centered beneath valley, and secured with steel masonry anchors spaced max 24 in. (610 mm) OC.

SCAFCO STEEL STUD MANUFACTURING CO
BRADY CONSTRUCTION INNOVATIONS INC,
DBA SLIPTRACK SYSTEMS – SLP-TRK
MARINO/WARE, DIV OF WARE INDUSTRIES INC – Type SLT
TELLING INDUSTRIES L L C – True-Action Deflection Track
 - A2. **Light Gauge Framing* – Notched Ceiling Runner** – As an alternate to the ceiling runners in Items 2A and 2A1, notched ceiling runners to consist of C-shaped galv steel channel with notched return flanges sized to accommodate steel studs (Item 2B). Notched ceiling runner installed parallel to direction of fluted steel deck, centered beneath valley, and secured with steel masonry anchors spaced max 24 in. (610 mm) OC.

OLMAR SUPPLY INC – Type SCR
 - B. **Studs** – Steel studs to be min 3-1/2 in. (89 mm) wide. Studs cut 1/2 to 3/4 in. (13 to 19 mm) less in length than assembly height with bottom nesting in and resting on floor runner and with top nesting in ceiling runner without attachment. When slotted ceiling runner is used, steel studs secured to runner with No. 8 by 1/2 in. (13 mm) long wafer head steel screws at midheight of slot on each side of wall. Stud spacing not to exceed 24 in (610 mm) OC.
 - C. **Gypsum Board*** – Gypsum board sheets installed to a min total thickness of 5/8 in. (16 mm) and 1-1/4 in. (32 mm) on each side of wall for 1 and 2 hr rated assemblies, respectively. Wall to be constructed as specified in the individual Wall and Partition Design in the UL Fire Resistance Directory, except that a max 1 in. (25 mm) gap shall be maintained between the top of the gypsum board and the lower surface of the floor or roof and the top row of screws shall be installed into the studs 1 in. (25 mm) below the bottom of the ceiling runner.

The hourly fire rating of the joint system is equal to the hourly fire rating of the wall.

System No. HW-D-0205 *continued*

Construction Joints

Head of Wall

HW/D

3. **Joint System – Max separation between bottom of floor or roof and top of wall is 1 in. (25 mm). The joint system is designed to accommodate a max 19 percent compression or extension from its installed width.** The joint system consists of the following:
- A. **Forming Material*** – Min 3/8 and 1 in. (10 and 25 mm) wide strips of min 4 pcf (64 kg/m³) mineral wool batt insulation for 1 and 2 hr rated assemblies, respectively. Mineral wool strips to be compressed approximately 33 percent in thickness to fill the max 1 in. (25 mm) gap between the top of gypsum board and bottom of steel floor or roof deck on both sides of the wall and recessed from each surface of wall to accommodate the required thickness of fill material.
- IIG MINWOOL L L C** – MinWool-1200 Safing
ROCKWOOL MANUFACTURING CO – Delta Board or Delta -8
ROCKWOOL MALAYSIA SDN BHD – Type Safe
ROXUL INC – Type Safe
THERMAFIBER INC – Type SAF
- B. **Fill, Void or Cavity Material* – Sealant** – Min 1/4 in. (6 mm) thickness of sealant installed on each side of wall in the flutes of steel floor or roof deck and between top of wall and bottom of steel floor or roof deck to completely cover mineral wool, flush with each surface of wall. An additional min 1/8 in. (3.2 mm) thickness of sealant to overlap onto gypsum board a min of 1/2 in. (13 mm).
- 3M COMPANY** – FireDam 150+

*Bearing the UL Classification Mark

Reprinted from the Online Certifications Directory with permission from UL
© 2012 UL LLC



System No. HW-D-0206

September 28, 2001

Assembly Rating – 2 Hr

L Rating at Ambient – Less than 1 CFM/Lin Ft.

L Rating at 400 F – Less than 1 CFM/Lin Ft.

Nominal Joint Width – 1 in.

Class II Movement Capabilities – 18.75% Compression & Extension

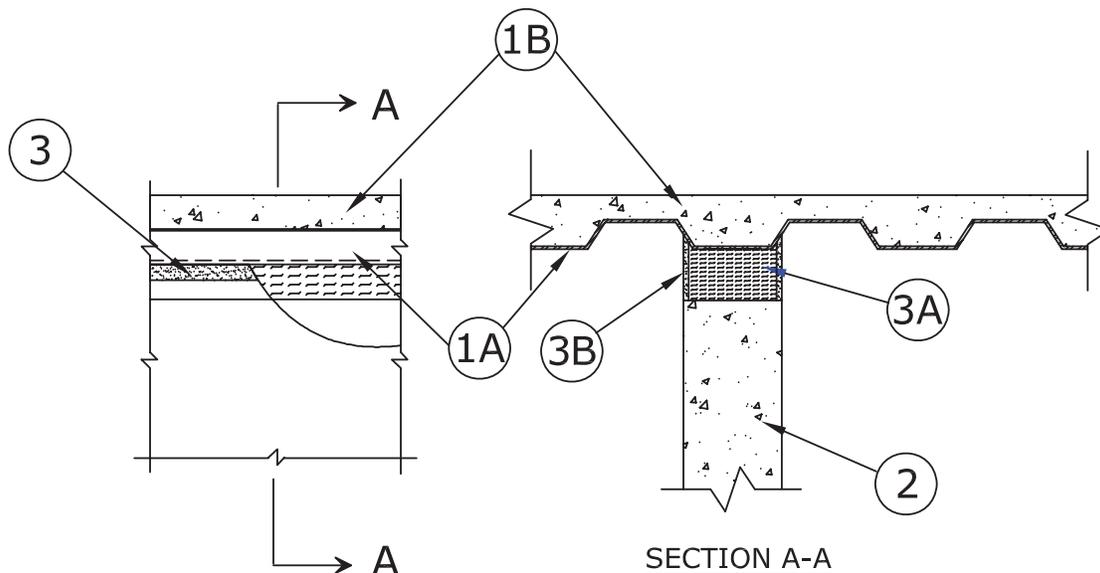

1. **Floor Assembly** – The fire-rated fluted steel deck/concrete floor assembly shall be constructed of the materials and in the manner described in the individual Floor-Ceiling Design in the UL Fire Resistance Directory and shall include the following construction features:
 - A. **Steel Floor And Form Units*** – Max 2 in. deep galv steel fluted roof deck.
 - B. **Concrete** – Min 2-1/2 in. thick reinforced concrete, as measured from the top plane of the floor units.
- 1A. **Roof Assembly** – (Not Shown) – As an alternate to the floor assembly, a fire rated fluted steel deck roof assembly may be used. The roof assembly shall be constructed of the materials and in the manner described in the individual P900 Series Roof-Ceiling Design in the UL Fire Resistance Directory. The hourly rating of the roof assembly shall be equal to or greater than the hourly rating of the wall assembly and shall include the following construction features:
 - A. **Steel Roof Deck** – Max 2 in. deep galv steel fluted roof deck.
 - B. **Roof Insulation** – Min 2-1/4 in. thick poured insulating concrete, as measured from the top plane of the deck.
2. **Wall Assembly** – Min 6-1/8 in. thick steel-reinforced lightweight or normal weight (100-150 pcf) concrete. Wall may also be constructed of any UL Classified **Concrete Blocks***.

See **Concrete Blocks (CAZT)** category in Fire Resistance Directory for names of manufacturers
3. **Joint System** – Max separation between bottom of floor or roof and top of wall is 1 in. The joint system is designed to accommodate a max 18.75 percent compression or extension from its installed width. The joint system consists of the following:
 - A. **Forming Material*** – Min 4 pcf mineral wool batt insulation cut into min 5-5/8 in. wide strips, compressed approximately 33 percent in thickness to fill the max 1 in. gap between top of wall and bottom of steel floor or roof deck and recessed from both surfaces of wall to accommodate the required thickness of fill material.

IIG MINWOOL L L C – MinWool-1200 Safing
ROCK WOOL MANUFACTURING CO – Delta Board or Delta -8
ROCKWOOL MALAYSIA SDN BHD – Type Safe
ROXUL INC – Type Safe
THERMAFIBER INC – Type SAF
 - B. **Fill, Void or Cavity Material* – Sealant** – Min 1/4 in. thickness of sealant installed on each side of wall between top of wall and bottom of floor or roof, flush with each surface of wall. .
3M COMPANY – FireDam 150+

*Bearing the UL Classification Mark

Reprinted from the Online Certifications Directory with permission from UL
© 2012 UL LLC





UL System No. HW-D-0248
XHBN - Joint Systems
XHBN7 - Joint Systems Certified for Canada

January 26, 2018

| ANSI/UL2079 | CAN/ULC S115 |
|---|---|
| Assembly Rating – 2 Hr | F Rating – 2 Hr |
| Nominal Joint Width - 1 In. | FT Rating – 2 Hr |
| Class II Movement Capabilities – 13% Compression or Extension | FH Rating – 2 Hr |
| | FTH Rating – 2 Hr |
| | Nominal Joint Width - 25 mm |
| | Class II Movement Capabilities – 13% Compression or Extension |

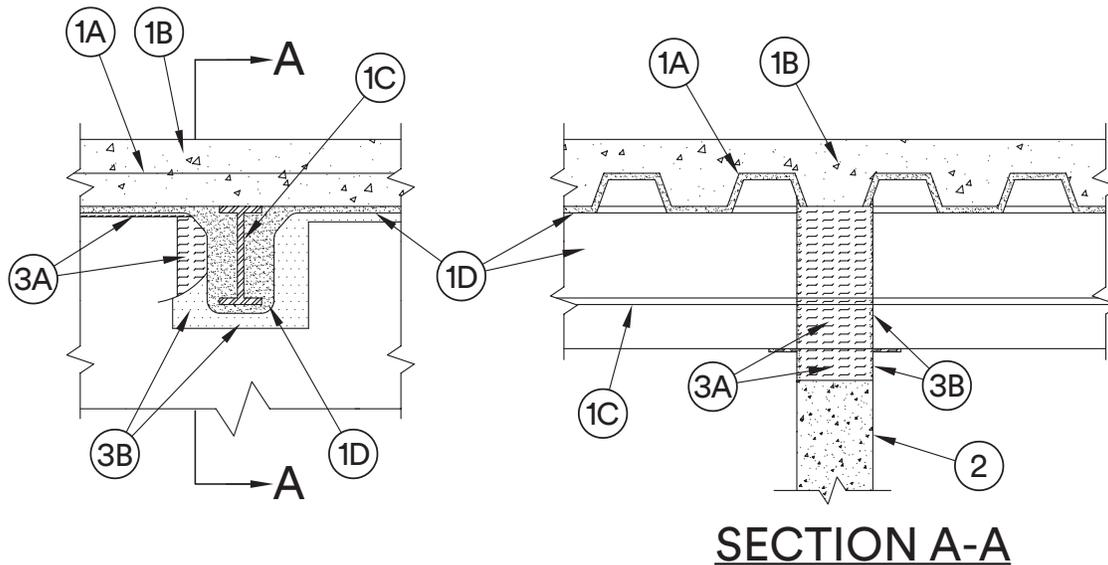

- 1. Floor Assembly** – The fire-rated fluted steel deck/concrete floor assembly shall be constructed of the materials and in the manner described in the individual D700 or D900 Series Floor-Ceiling Design in the UL Fire Resistance Directory and shall include the following construction features:
 - A. Steel Floor and Floor Units*** – Max 3 in. (76 mm) deep galv steel fluted floor units.
 - B. Concrete** – Min 2-1/2 in. (64 mm) thick reinforced concrete, as measured from the top plane of the floor units.
 - C. Structural Steel Support** – (Optional) – Steel beam or open-web steel joist, as specified in the individual D700 or D900 Series Floor-Ceiling Design, used to support steel floor units. Structural steel support oriented perpendicular to wall assembly. Where open-web steel joists pass through the fire rated wall, 3/8 in. (10 mm) diamond mesh expanded steel lath having a nom weight of 1.7 to 3.4 lb per sq yd (0.9 to 1.8 kg/m²) shall be secured to one side of each joist with steel tie wire and the lath shall be fully covered with spray applied fire resistive material with no min thickness requirement.
 - D. Spray-Applied Fire Resistive Material*** – Steel floor units and structural steel supports to be sprayed in accordance with the specifications in the individual D700 Series Design or the structural steel supports to be sprayed in accordance with the specifications in the individual D900 Series Design .

GCP APPLIED TECHNOLOGIES INC – Type MK-6/HY
 - 2. Wall Assembly** – Min 6-1/8 in. (156 mm) thick steel-reinforced lightweight or normal weight (100-150 pcf or 1600-2400 kg/m³) concrete. Wall shall be installed parallel to the flutes of the steel floor and form units. A min clearance of 1 in. (25 mm) to a max clearance of 3 in. (76 mm) shall be maintained between the wall and the spray applied fire resistive material on the two sides of the structural support member. Wall may also be constructed of any UL Classified Concrete Blocks*.
- See **Concrete Blocks** (CAZT) category in Fire Resistance Directory for names of manufacturers.

Construction Joints

Head of Wall

HW-D

3. **Joint System – Max separation between bottom of the spray applied fire resistive material on the lowest portion of steel floor units and top of wall (at time of installation of joint system) is 1 in. (25 mm) when D700 series assembly is used. Max separation between bottom of the steel floor units and top of gypsum board (at time of installation of joint system) is 1 in. (25 mm) when D900 series assembly is used. Max separation between spray applied fire resistive material on bottom of structural support member and top of wall is 1 in. (25 mm). The joint system is designed to accommodate a max 13 percent compression or extension from it's installed width as measured between the spray applied fire resistive material on the steel floor units and the top of wall.** The joint system shall consist of forming and fill materials, as follows:

A. Forming Material* – Nom 4 pcf (64 kg/m³) mineral wool batt insulation cut to a min 6-1/8 in. (156 mm) length, compressed a min of 25 percent in thickness and installed cut edge first to completely fill the gap above the wall, flush with both surfaces of wall. Additional nom 4 pcf (64 kg/m³) mineral wool batt insulation compressed a min of 25 percent in thickness to be installed to completely fill the flutes of the steel floor and form units located above wall. Nom 4 pcf (64 kg/m³) mineral wool batt insulation cut to a min 6-1/8 in. (156 mm) length, compressed a min of 25 percent in thickness and installed cut edge first to completely fill the gap between the spray applied fire resistive material on the structural steel member and the wall.

INDUSTRIAL INSULATION GROUP L L C – MinWool-1200 Safing

JOHNS MANVILLE – Safing

ROCK WOOL MANUFACTURING CO – Delta Board

ROCKWOOL MALAYSIA SDN BHD – Type Safe

ROCKWOOL – Type Safe

THERMAFIBER INC – Type SAF

B. Fill, Void or Cavity Material* – Min 1/16 in. dry thickness (min 1/8 in. or 3.2 mm wet thickness) of fill material spray applied over the forming material on each side of the wall. Fill material to overlap a min of 1/2 in. (13 mm) onto the wall and a min 2 in. (51 mm) onto the deck or the spray applied material (Item 1C) on the steel floor unit and on the structural steel support member on both sides of wall.

3M COMPANY – FireDam™ Spray 200

B1. Fill, Void or Cavity Material* – Tape – As an alternate to Item B, Tape cut to size and press applied to completely cover mineral wool between bottom of floor and top of wall. Tape to overlap a min of 1 in. (25 mm) onto the wall and a min 2 in. (51 mm) onto the deck or the spray applied material (Item 1C) on the steel floor unit and on the structural steel support member on both sides of wall. All adjoining lengths of Tape shall overlap min 1/2 in. (13 mm).

3M COMPANY – 3M Fire and Water Barrier Tape



*Indicates such products shall bear the UL or cUL Certification Mark for jurisdictions employing the UL or cUL Certification (such as Canada), respectively.

Reprinted from the Online Certifications Directory with permission from UL©

UL System No. HW-D-0265

January 17, 2017

ANSI/UL2079

Assembly Rating – 2 Hr
Nominal Joint Width – 2 in.
Class II Movement Capabilities – 25% Compression or Extension
L Rating At Ambient – Less Than 1 CFM/Lin Ft
L Rating At 400°F – Less Than 1 CFM/Lin Ft

CAN/ULC S115

F Rating – 2 Hr
FT Rating – 2 Hr
FH Rating – 2 Hr
FTH Rating – 2 Hr
Nominal Joint Width – 51 mm
Class II Movement Capabilities – 25% Compression or Extension
L Rating at Ambient – Less than 1.55 L/s/lin m
L Rating at 204°C – Less than 1.55 L/s/lin m

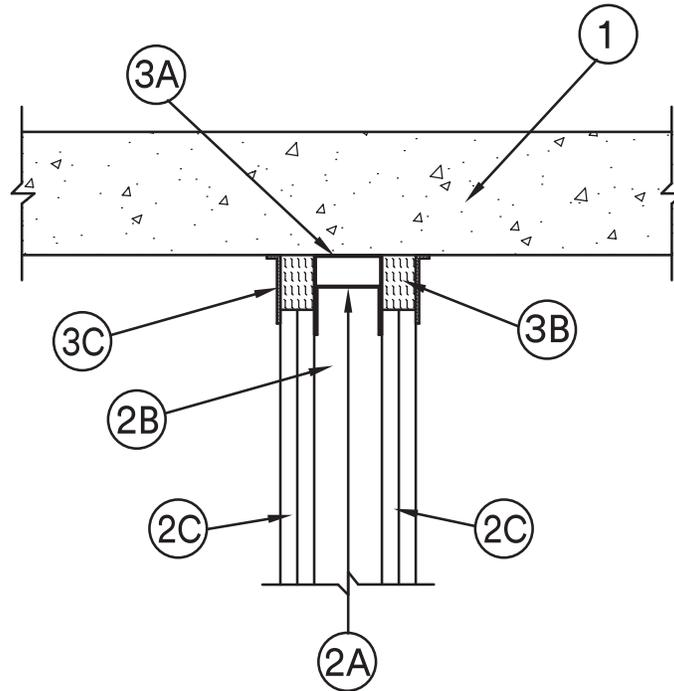

- 1. Floor Assembly** – Min 4-1/2 in. (114 mm) thick steel reinforced lightweight or normal weight (100-150 pcf or 1600-2400 kg/m³) structural concrete. Floor may also be constructed of any min 6 in. thick UL Classified hollow-core **Precast Concrete Units***.
See **Precast Concrete Units** (CFTV) category in the Fire Resistance Directory for names of manufacturers.
- 2. Wall Assembly** – The 2 hr fire rated gypsum board/steel stud wall assembly shall be constructed of the materials and in the manner described in the individual U400 or V400 Series Wall and Partition Design in the UL Fire Resistance Directory and shall include the following construction features:

A. Steel Floor And Ceiling Runners – Floor and ceiling runners of wall assembly shall consist of galv steel channels sized to accommodate steel studs (Item 2B). When deflection channel (Item 3A) is used, ceiling runner to be provided with 3 in. (76 mm) flanges. Ceiling runner is installed within the deflection channel with 2 in. (51 mm) gap maintained between the top of ceiling runner and top of deflection channel. When deflection channel is not used, flange height of ceiling runner shall be min 3/4 in. (19 mm) greater than nom joint width. Ceiling Runner secured to floor assembly with steel fasteners spaced max 24 in. (610 mm) OC.

A1. Light Gauge Framing* – Slotted Ceiling Runner – As an alternate to the ceiling runner in Item 2A, slotted ceiling runner to consist of galv steel channel with slotted flanges sized to accommodate steel studs (Item 2B). Slotted ceiling runner secured to floor assembly with steel fasteners spaced max 24 in. (610 mm) OC. When slotted ceiling runner is used, deflection channel (Item 3A) shall not be used.

METAL-LITE INC – The System

SCAFCO STEEL STUD MANUFACTURING CO

BRADY CONSTRUCTION INNOVATIONS INC, DBA SLIPTRACK SYSTEMS – SLP-TRK

MARINO/WARE, DIV OF WARE INDUSTRIES INC – Type SLT

TELLING INDUSTRIES LLC – True-Action Deflection Track

- B. Studs** – Steel studs to be min 3-1/2 in. (89 mm) wide. Studs cut 1/2 to 3/4 in. (13 to 19 mm) less in length than assembly height with bottom nesting in and resting on floor runner and with top nesting in ceiling runner without attachment. When slotted ceiling runner (Item 2A1) is used, steel studs secured to slotted ceiling runner with No. 8 by 1/2 in. (13 mm) long wafer head steel screws at midheight of slot on each side of wall. Stud spacing not to exceed 24 in. (610 mm) OC.
- C. Gypsum Board*** – Gypsum board installed to a min total thickness of 1-1/4 in. (32 mm) on each side of wall. Wall to be constructed as specified in the individual Wall and Partition Design in the UL Fire Resistance Directory, except that a max 2 in. (51 mm) gap shall be maintained between the top of the gypsum board and the bottom of the floor assembly and the top row of screws shall be installed into the studs 4-1/2 in. (114 mm) below the lower surface of the floor.

- 3. Joint System – Max separation between bottom of floor and top of wall is 2 in. (51 mm). The joint system is designed to accommodate a max 25 percent compression or extension from its installed width.** The joint system consists of a deflection channel, forming material and a fill material, as follows:
- A. Deflection Channel** (optional) – A nom 3-5/8 in. (92 mm) wide by 3 in. (76 mm) deep min 24 gauge steel U-shaped channel. Deflection channel secured to floor assembly with steel fasteners spaced max 24 in. (610 mm) OC. The ceiling runner (Item 2A) is installed within the deflection channel to maintain a 2 in. (51 mm) gap between the top of the ceiling runner and the top of the deflection channel. The ceiling runner is not fastened to the deflection channel.
 - B. Forming Material*** – Min 1-1/4 in. (32 mm) thickness of min 4 pcf (64 kg/m³) mineral wool insulation cut a min 33 percent wider than the max 2 in. (51 mm) wide gap above the top of the gypsum board, compressed in width, and firmly packed into the gap between the top of the gypsum board and the bottom of the floor assembly, flush with both surfaces of the wall.
 - INDUSTRIAL INSULATION GROUP LLC** – MinWool-1200 Safing
 - JOHNS MANVILLE** – Safing
 - ROCK WOOL MANUFACTURING CO** – Delta Board or Delta-8
 - ROCKWOOL MALAYSIA SDN BHD** – Type Safe
 - ROXUL INC** – Type Safe
 - THERMAFIBER INC** – Type SAF
 - C. Fill, Void or Cavity Material*** – Min 1/16 in. (1.6 mm) dry thickness (min 1/8 in. or 3.2 mm wet thickness) of fill material sprayed or brushed on each side of the wall between the top of the gypsum board and the bottom of the floor to completely cover mineral wool and overlap a min of 1/2 in. (13 mm) onto gypsum board and floor on both sides of wall.
 - 3M COMPANY** – FireDam™ Spray 200
 - C1. Fill, Void or Cavity Material* – Tape** – As an alternate to Item C, Tape cut to size and press applied along length of joint to completely cover mineral wool and lap min 1 in. (25 mm) onto the concrete floor and gypsum wall. Tape shall be applied in min 1 ft (305 mm) lengths along joint and adjoining lengths of Tape shall overlap min 1/2 in. (13 mm). Tape shall be applied at both sides of wall.
 - 3M COMPANY** – 3M Fire and Water Barrier Tape

*Indicates such products shall bear the UL or cUL Certification Mark for jurisdictions employing the UL or cUL Certification (such as Canada), respectively. 

Reprinted from the Online Certifications Directory with permission from UL©

UL System No. HW-D-0376

December 09, 2016

ANSI/UL2079

Assembly Rating – 1 and 2 Hr (See Item 2)
Nominal Joint Width – 2 in.
Class II Movement Capabilities – 25% Compression or Extension

CAN/ULC S115

F Ratings – 1 and 2 Hr (See Item 2)
FT Ratings – 1 and 2 Hr (See Item 2)
FH Ratings – 1 and 2 Hr (See Item 2)
FTH Ratings – 1 and 2 Hr (See Item 2)
Nominal Joint Width – 51 mm
Class II Movement Capabilities – 25% Compression or Extension

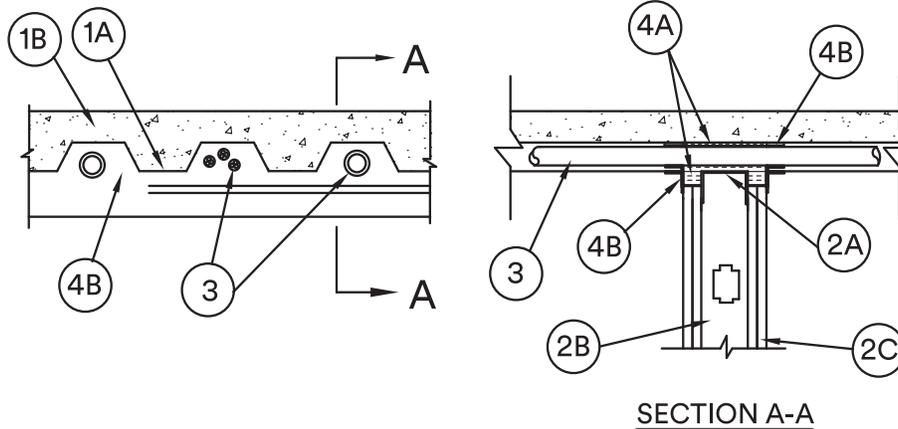

1. **Floor Assembly** – The fire-rated fluted steel deck/concrete floor assembly shall be constructed of the materials and in the manner described in the individual D900 Series Floor-Ceiling Design in the UL Fire Resistance Directory and shall include the following construction features:

- A. **Steel Floor and Form Units*** – Max 3 in. (76 mm) deep galv steel fluted units.
- B. **Concrete** – Min 2-1/2 in. (64 mm) thick reinforced concrete, as measured from the top plane of the floor units.

2. **Wall Assembly** – The 1 or 2 hr fire rated gypsum board/steel stud wall assembly shall be constructed of the materials and in the manner described in the individual U400 or V400 Series Wall and Partition Designs in the UL Fire Resistance Directory and shall include the following construction features:

- A. **Steel Floor and Ceiling Runners** – Floor and ceiling runners of wall assembly shall consist of galv steel channels sized to accommodate steel studs (Item 2B). Flange height of ceiling runner shall be min 3/4 in. (19 mm) greater than nom joint width. Ceiling runner installed perpendicular to direction of fluted steel floor units and secured with steel fasteners or by welds spaced max 24 in. (610 mm) OC.
- A1. **Light Gauge Framing* – Slotted Ceiling Runner** – As an alternate to the ceiling runner in Item 2A, slotted ceiling runner to consist of galv steel channel with slotted flanges sized to accommodate steel studs (Item 2B). Flange height of ceiling runner shall be min 3/4 in. (19 mm) greater than nom joint width. Slotted ceiling runner installed perpendicular to direction of fluted steel floor units and secured to valleys with steel fasteners spaced max 24 in. (610 mm) OC.

BRADY CONSTRUCTION INNOVATIONS INC, DBA SLIPTRACK SYSTEMS – SLP-TRK

- A2. **Light Gauge Framing* – Clipped Ceiling Runner** – As an alternate to the ceiling runner in Items 2A and 2A1, clipped runner to consist of galv steel channel with clips preformed in track flanges which positively engage the inside flange of the steel studs (Item 2B). Track sized to accommodate steel studs (Item 2B). Flange height of ceiling runner shall be min 3/4 in. (19 mm) greater than nom joint width. Clipped ceiling runner installed perpendicular to direction of fluted steel floor units and secured to valleys with steel fasteners spaced max 24 in. (610 mm) OC.

TOTAL STEEL SOLUTIONS LLC – Snap Trak

- B. **Studs** – Steel studs to be min 3-1/2 in. (89 mm) wide. Studs cut 1/2 to 3/4 in. (13 to 19 mm) less in length than assembly height with bottom nesting in and resting on floor runner and with top nesting in ceiling runner without attachment. When slotted ceiling runner (Item 2A1) is used, steel studs secured to slotted ceiling runner with No. 8 by 1/2 in. (13 mm) long wafer head steel screws at midheight of slot on each side of wall. Stud spacing not to exceed 24 in. (610 mm) OC.
- C. **Gypsum Board*** – Gypsum board sheets installed to a min total thickness of 5/8 in. (16 mm) and 1-1/4 in. (32 mm) on each side of wall for 1 and 2 hr rated assemblies, respectively. Wall to be constructed as specified in the individual Wall and Partition Design in the UL Fire Resistance Directory, except that a max 2 in. (51 mm) gap shall be maintained between the top of the gypsum board and the bottom of the steel floor units and the top row of screws shall be installed into the studs 3-1/2 in. (89 mm) below the lower surface of the floor.

The hourly fire rating of the joint system is equal to the hourly fire rating of the wall.

3. **Through Penetrants (Not applicable when Item 4B1 is used)** – A max of one nonmetallic or metallic pipe or conduit or a max of three cables may be installed within the individual areas of the flutes of the steel deck above the ceiling runner. Annular space between the penetrants and the steel deck or top of ceiling runner shall be min 1/2 in. (13 mm). Penetrants to be rigidly supported on both sides of wall assembly. The following types and sizes of nonmetallic or metallic pipe or conduit or cables may be used:

- A. **Metallic Pipes** – The following types and sizes may be used:
 - 1. **Steel Pipe** – Nom 1-1/2 in. (38 mm) diam (or smaller) Schedule 5 (or heavier) steel pipe.
 - 2. **Conduit** – Nom 1-1/2 in. (38 mm) diam (or smaller) electrical metallic tubing or rigid steel conduit.

Construction Joints

Head of Wall

HWD

B. Nonmetallic Pipes – The following types and sizes may be used:

- 1. Polyvinyl Chloride (PVC) Pipe** – Nom 1-1/2 in. (38 mm) diam (or smaller) Schedule 40 solid core PVC pipe for use in closed (process or supply) piping systems.
- 2. Chlorinated Polyvinyl Chloride (CPVC) Pipe** – Nom 1-1/2 in. (38 mm) diam (or smaller) SDR13.5 CPVC pipe for use in closed (process or supply) piping systems.
- 3. Rigid Nonmetallic Conduit++** – Nom 1-1/2 in. (38 mm) diam (or smaller) Schedule 40 PVC conduit installed in accordance with Article 347 of the National Electrical Code (NFPA No. 70).

C. Cables – A max of three cables may be used. A min 1/2 in. (13 mm) annular space must be maintained between cables. Max 3C with ground No. 12 AWG (or smaller) MC (BX) copper cables with polyvinyl chloride insulation.

4. Joint System – Max separation between bottom of floor and top of wall is 2 in. The joint system is designed to accommodate a max 25 percent compression or extension from its installed width. The joint system consists of a forming material and a fill material, as follows:

A. Forming Material* – Min 4 in. (102 mm) thickness of min 4 pcf (64 kg/m³) density mineral wool batt insulation cut to the shape of the fluted deck, approx 20 percent larger than the area of the flutes and compressed into flutes of the steel floor units between the top of the ceiling runner and the steel deck and tightly packed around the individual penetrants. Additional pieces of min 4 pcf (64 kg/m³) mineral wool batt insulation are to be cut to the contour of the flutes with an additional 1-3/4 in. (44 mm) high section at the bottom of the shapes to fill the 2 in. (51 mm) gap between the top of the gypsum board and the bottom of the steel floor units. The additional pieces of mineral wool are compressed and firmly packed into the flutes and around the penetrants and into the gap between the top of the gypsum board and the bottom of the steel floor units on both sides of the wall. The additional pieces shall be a 3/4 in. (19 mm) thick for a 1 hr rated design and a 1-1/2 in. (38 mm) thick for a 2 hr rated design.

INDUSTRIAL INSULATION GROUP LLC – MinWool-1200 Safing

ROCK WOOL MANUFACTURING CO – Delta Board or Delta-8

ROCKWOOL MALAYSIA SDN BHD – Type Safe

ROXUL INC – Type Safe

B. Fill, Void or Cavity Material* – Min 1/16 in. (1.6 mm) dry thickness (min 1/8 in. or 3.2 mm wet thickness) of fill material sprayed or brushed on each side of the wall in the flutes of the steel floor units and between the top of the gypsum board and the bottom of the steel floor units to completely cover mineral wool and overlap a min of 1/2 in. (13 mm) onto gypsum board and a min 1 in. (25 mm) onto steel deck and penetrants on both sides of wall.

3M COMPANY – FireDam™ Spray 200

B1. Fill, Void or Cavity Material* – Tape (Not applicable when Item 3 is used) – As an alternate to Item 4B, Tape cut to size and press applied within fluted areas of joint to completely cover mineral wool lapping min 1 in. (25 mm) onto the contour of the steel floor units and extending to lap min 1 in. (25 mm) onto the gypsum wall. Additional pieces of Tape are applied along the joint to completely cover the remaining mineral wool between bottom of steel deck and top edge of wall along length of joint, lapping min 1 in. (25 mm) onto the contour of the steel floor units and min 1 in. (25 mm) onto the gypsum wall. Adjoining lengths of Tape shall overlap min 1/2 in. (13 mm). Tape shall be applied at both sides of wall.

3M COMPANY – 3M Fire and Water Barrier Tape

*Indicates such products shall bear the UL or cUL Certification Mark for jurisdictions employing the UL or cUL Certification (such as Canada), respectively. 

Reprinted from the Online Certifications Directory with permission from UL©

UL System No. HW-D-0379

January 17, 2017

ANSI/UL2079

Assembly Rating – 2 Hr
 Nominal Joint Width – 2 in.
 Class II Movement Capabilities – 13% Compression or Extension
 L Rating At Ambient – Less Than 1 CFM/lin ft
 L Rating At 400°F – Less Than 1 CFM/lin ft

CAN/ULC S115

F Rating – 2 Hr
 FT Rating – 2 Hr
 FH Rating – 2 Hr
 FTH Rating – 2 Hr
 Nominal Joint Width – 51 mm
 Class II Movement Capabilities – 13% Compression or Extension
 L Rating at Ambient – Less than 1.55 L/s/lin m
 L Rating at 204°C – Less than 1.55 L/s/lin m

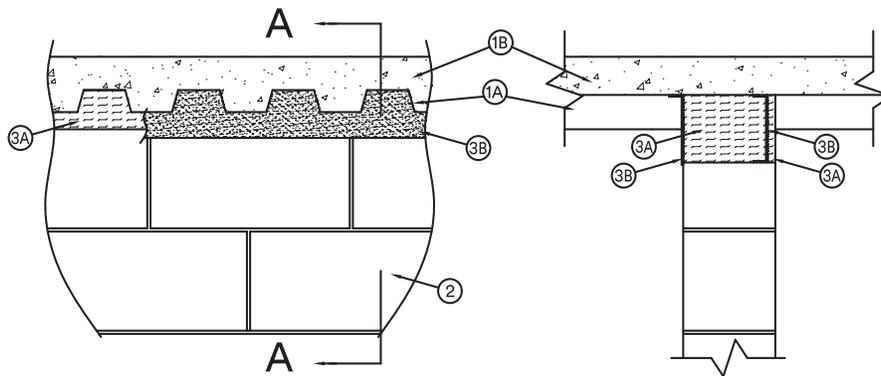

SECTION A-A

1. **Floor Assembly** – The fire rated fluted steel floor unit/concrete floor assembly shall be constructed of the materials and in a manner described in the individual D900 Floor-Ceiling Design in the UL Fire Resistance Directory and shall include the following construction features:

- A. **Steel Floor And Form Units*** – Max 3 in. (76 mm) deep galv steel fluted floor units.
- B. **Concrete** – Min 2-1/2 in. (64 mm) thick reinforced concrete, as measured from the top plane of the floor units.

2. **Wall Assembly** – Min 7-1/2 in. (191 mm) thick reinforced lightweight or normal weight (100-150 pcf or 1600-2400 kg/m³) structural concrete. Wall may also be constructed of any UL Classified **Concrete Blocks***.

See **Concrete Blocks** (CAZT) category in the Fire Resistance Directory for names of manufacturers.

3. **Joint System** – Max width of joint (at time of installation of joint system) is 2 in. (51 mm). The joint system is designed to be installed from only one side of the wall due to the opposite side of the wall being inaccessible. The joint system is designed to accommodate a max 12.5 percent compression or extension from its installed width. The joint system shall consist of the following:

- A. **Forming Material*** – Min 4 pcf (64 kg/m³) mineral wool batt insulation cut into strips, compressed approximately 25 percent in thickness, and installed to fill the max 2 in. (51 mm) gap between the top of the wall and the bottom of the fluted steel floor units. Additional pieces of min 4 pcf (64 kg/m³) mineral wool batt insulation cut to the shape of the fluted deck, approximately 20 percent larger than the area of the flutes, firmly packed into the flutes. The strips and shaped pieces of mineral wool batt insulation installed on the inaccessible side of the wall are to be 1 in. to 2 in. (25 to 51 mm) wide and are to be installed flush with the inaccessible surface of the wall. After application of the sealant (Item 3B) on the surface of the mineral wool batt packing material above the top plane of the wall, additional strips and shaped pieces of the mineral wool batt insulation are to be installed to fill the remainder of the joint opening above the wall, flush with the accessible surface of the wall.

ROCK WOOL MANUFACTURING CO – Delta Board or Delta-8

ROCKWOOL MALAYSIA SDN BHD – SAFE

ROXUL INC – SAFE

- B. **Fill, Void or Cavity Material* – Sealant** – Min 1/8 in. (3.2 mm) wet thickness or 1/16 in. (1.6 mm) dry thickness of fill material spray applied over the forming material. The fill material sprayed on the nom 1 in. to 2 in. (25 to 51 mm) thickness of forming material located on the inaccessible side of the wall is to lap a min of 1 in. (25 mm) onto the steel deck and onto the top surface of the wall. The fill material sprayed on the forming material on the accessible side of the wall is to overlap a min of 1/2 in. (13 mm) onto the wall and a min of 1 in. (25 mm) onto the steel floor unit on either side of the wall.

3M COMPANY – FireDam™ Spray 200

- B1. **Fill, Void or Cavity Material* – Tape** – As an alternate to Item B, Tape cut to size and press applied within fluted areas of joint to completely cover mineral wool lapping min 1 in. (25 mm) onto the contour of the steel floor units and extending to lap min 1 in. (25 mm) onto the concrete wall. Additional pieces of Tape are applied along the joint to completely cover the remaining mineral wool between bottom of steel deck and top edge of wall along length of joint, lapping min 1 in. (25 mm) onto the contour of the steel floor units and min 1 in. (25 mm) onto the concrete wall. Adjoining lengths of Tape shall overlap min 1/2 in. (13 mm). Tape shall be applied at both sides of wall.

3M COMPANY – 3M Fire and Water Barrier Tape

*Indicates such products shall bear the UL or cUL Certification Mark for jurisdictions employing the UL or cUL Certification (such as Canada), respectively. 

Reprinted from the Online Certifications Directory with permission from UL©

| ANSI/UL2079 | CAN/ULC S115 |
|---|---|
| Assembly Ratings – 1, 2, 3 and 4 Hr (See Item 2) | F Ratings – 1, 2, 3 and 4 Hr (See Item 2) |
| Nominal Joint Width - 2 In. | FT Ratings – 1, 2, 3 and 4 Hr (See Item 2) |
| Class II Movement Capabilities – 50% Compression or Extension | FH Ratings – 1, 2, 3 and 4 Hr (See Item 2) |
| | FTH Ratings – 1, 2, 3 and 4 Hr (See Item 2) |
| | Nominal Joint Width - 51 mm |
| | Class II Movement Capabilities – 50% Compression or Extension |

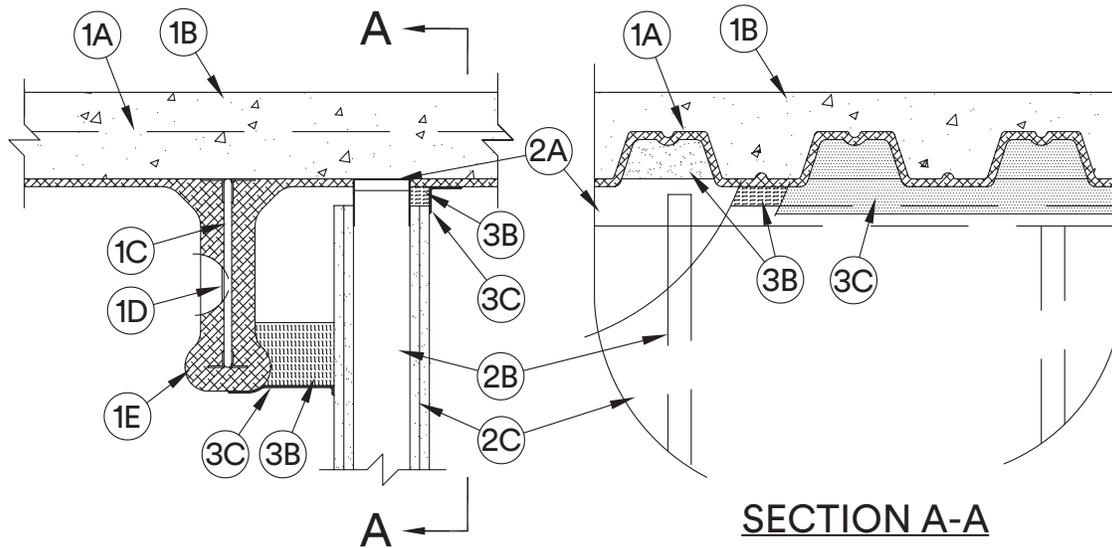

1. **Floor Assembly** – The fire-rated fluted steel deck/concrete floor assembly shall be constructed of the materials and in the manner described in the individual D700 or D800 Series Floor-Ceiling Design in the UL Fire Resistance Directory. The hourly fire rating of the floor assembly shall be equal to or greater than the hourly fire rating of the wall assembly. The floor assembly shall include the following construction features:
 - A. **Steel Floor and Floor Units*** – Max 3 in. (76 mm) deep galv steel fluted floor units.
 - B. **Concrete** – Min 2-1/2 in. (64 mm) thick reinforced concrete, as measured from the top plane of the floor units.
 - C. **Structural Steel Support** – Steel beam or open-web steel joist, as specified in the individual D700 or D800 Series Floor-Ceiling Design, used to support steel floor units. Structural steel support oriented parallel to and 2 to 6 in. (51 to 152 mm) from wall assembly.
 - D. **Steel Lath** – When structural steel support (Item 1C) consists of open-web steel joists, 3/8 in. (10 mm) diamond mesh expanded steel lath having a nom weight of 1.7 to 3.4 lb per sq yd (0.9 to 1.8 kg/m²) shall be installed to completely cover one side of each joist which is located within 6 in. (152 mm) of wall assembly. The lath shall be secured with steel tie wire and shall be fully covered with spray applied fire resistive material.
 - E. **Spray-Applied Fire Resistive Material*** – After installation of the ceiling runner (Item 2A) or deflection track (Item 3A, if used), steel floor units and structural steel supports to be sprayed with the thickness of material specified in the individual D700 or D800 Series Design. The flutes of the steel floor units above the structural steel supports and above the ceiling runner (Item 2A) or deflection channel (Item 3A) shall be filled with spray-applied fire resistive material. As an alternate, the spray-applied fire resistive material in the flutes above the ceiling runner may be applied to follow the contour of the steel floor units. Excess material shall be removed from the flanges of the ceiling runner or deflection track beyond the required thickness of spray-applied fire resistive material on the steel floor units.

GCP APPLIED TECHNOLOGIES INC – Type MK-6/HY

- 1A. **Roof Assembly** – (Not Shown) – As an alternate to the floor assembly (Item 1), a fire rated fluted steel deck roof assembly may be used. The roof assembly shall be constructed of the materials and in the manner described in the individual P700 or P800 Series Roof-Ceiling Design in the UL Fire Resistance Directory. The hourly fire rating of the roof assembly shall be equal to or greater than the hourly fire rating of the wall assembly. The roof assembly shall include the following construction features:

- A. Steel Roof Deck** – Max 3 in. (76 mm) deep galv steel fluted roof deck.
- B. Roof Insulation – Mineral and Fiber Board*** – Min 3/4 in. (19 mm) thick boards applied in one or more layers directly over steel roof deck or over gypsum board sheathing laid atop steel roof deck.
- C. Roof Covering*** – Hot-mopped or cold-application materials compatible with mineral and fiber board insulation.
- D. Structural Steel Support** – Steel beam or open-web steel joist, as specified in the individual P700 or P800 Series Roof-Ceiling Design, used to support steel floor units. Structural steel support oriented parallel to and min 2 in. (51 mm) to max 6 in. (152 mm) from wall assembly.
- E. Steel Lath** – When structural steel support (Item 1D) consists of open-web steel joists, 3/8 in. (10 mm) diamond mesh expanded steel lath having a nom weight of 1.7 to 3.4 lb per sq yd (0.9 to 1.8 kg/m²) shall be installed to completely cover one side of each joist which is located within 6 in. (152 mm) of wall assembly. The lath shall be secured with steel tie wire and shall be fully covered with spray applied fire resistive material.
- F. Spray-Applied Fire Resistive Material*** – After installation of the ceiling runner (Item 2A) or deflection track (Item 3A, if used), steel roof deck and structural steel supports to be sprayed with a thickness of spray applied fire resistive material as specified in the individual P700 or P800 Series Roof-Ceiling design. The flutes of the steel deck above the structural steel supports and above the ceiling runner (Item 2A) or deflection channel (Item 3A) shall be filled with spray-applied fire resistive material. As an alternate, the spray-applied fire resistive material in the flutes above the ceiling runner may be applied to follow the contour of the steel roof deck. Excess material shall be removed from the flanges of the ceiling runner or deflection track beyond the required thickness of spray-applied fire resistive material on the steel roof deck.

GCP APPLIED TECHNOLOGIES INC – Type MK-6/HY

- 2. Wall Assembly** – The 1, 2, 3 or 4 hr fire-rated gypsum board/steel stud wall assembly shall be constructed of the materials and in the manner described in the individual U400 or V400 Series Wall and Partition Design in the UL Fire Resistance Directory and shall include the following construction features:

- A. Steel Floor and Ceiling Runners** – Floor and ceiling runners of wall assembly shall consist of galv steel channels sized to accommodate steel studs (Item 2B). Ceiling runner flange height to be min 1/2 in. (13 mm) greater than joint width at max anticipated extension. When deflection channel (Item 3A) is used, flange height of ceiling runner is to be equal to or greater than flange height of deflection channel and the ceiling runner is to nest within the deflection channel with a max 1-1/4 in. (32 mm) gap maintained between the top of the ceiling runner and the top of the deflection channel. When deflection channel is not used, ceiling runner is secured to steel floor units (Item 1A) with steel fasteners or welds spaced max 24 in. (610 mm) OC. Ceiling runner or deflection track to be installed parallel with structural steel support and located such that a max clearance of 4 in. (102 mm) is present between the finished wall and the spray-applied fire resistive material at the lowest elevation of the structural steel support.

- A1. Light Gauge Framing* – Slotted Ceiling Runner** – As an alternate to the ceiling runner in Item 2A, ceiling runner to consist of galv steel channel with slotted flanges sized to accommodate steel studs (Item 2B). Ceiling runner secured to valleys with steel fasteners spaced max 24 in. (610 mm) OC. When slotted ceiling runner is used, deflection channel (Item 3A) shall not be used.

BRADY CONSTRUCTION INNOVATIONS INC, DBA SLIPTRACK SYSTEMS – SLP-TRK

- A2. Light Gauge Framing* – Clipped Ceiling Runner** – As an alternate to the ceiling runner in Items 2A and 2A1, clipped runner to consist of galv steel channel with clips preformed in track flanges which positively engage the inside flange of the steel studs (Item 2B). Track sized to accommodate steel studs (Item 2B). Track flanges to be min 2-1/2 in. (64 mm). Clipped ceiling runner secured with steel fasteners spaced max 24 in. (610 mm) OC. When clipped ceiling runner is used, deflection channel (Item 3A) shall not be used.

TOTAL STEEL SOLUTIONS L L C – Snap Trak

- B. Studs** – Steel studs to be min 3-5/8 in. (92 mm) wide. Studs cut max 1-1/4 in. (32 mm) less in length than assembly height to accommodate max anticipated compression of joint width with bottom nesting in and resting on floor runner and with top nesting in ceiling runner without attachment. Stud spacing not to exceed 24 in. (610 mm) OC. When slotted ceiling runner (Item 2A1) is used, steel studs secured to slotted ceiling runner with No. 8 by 1/2 (13 mm) long wafer head steel screws at midheight of slot on each side of wall. When deflection channel (Item 3A) is used, steel studs attached to ceiling runner (Item 2A) with sheet metal screws located 3/4 in. (19 mm) below the bottom of the deflection channel. When deflection channel is not used, studs to nest in ceiling runner without attachment.
- C. Gypsum Board*** – Gypsum board sheets installed to a min total 5/8 in. (16 mm), 1-1/4 in. (32 mm), 1-1/2 in. (38 mm) or 2 in. (51 mm) thickness on each side of wall for 1, 2, 3 and 4 hr fire rated assemblies, respectively. Wall to be constructed as specified in the individual U400 or V400 Series Design in the UL Fire Resistance Directory except that a max 2 in. (51 mm) gap shall be maintained between the top of the gypsum board and the bottom plane of the spray applied fire resistive material on the steel deck. on both sides of the wall assembly. The screws attaching the gypsum board to the studs along the top of the wall shall be located 1 in. (25 mm) below the bottom of the ceiling runner. No gypsum board attachment screws shall be driven into the ceiling runner or into the optional deflection channel. Where the top of the wall assembly is inaccessible above the lowest elevation of the structural steel support, the gypsum board attachment screws may be omitted.

The hourly fire rating of the joint system is equal to the hourly fire rating of the wall.

- 3. Joint System** – Max separation between bottom plane of steel floor unit and top of gypsum board (at time of installation of joint system) is 2 in. (51 mm). Max separation between spray applied fire resistive material on structural support member and surface of wall is min 1 in. (25 mm) to max 4 in. (102 mm). The joint system is designed to accommodate a max 50 percent compression or extension from its installed width as measured between the bottom plane of the spray-applied fire resistive material on the steel floor unit and the top of the gypsum board. The joint system shall consist of forming and fill materials, with or without a deflection channel (Item 3A), as follows:

UL System No. HW-D-0384 (cont.)

- A. Deflection Channel** – (Optional, Not Shown) – Max 2 in. (51 mm) deep min 24 gauge galv steel channel sized to accommodate ceiling runner (Item 2A). Deflection channel to be installed parallel with structural steel support and located such that a max clearance of 4 in. (102 mm) is present between the finished wall and the spray-applied fire resistive material at the lowest elevation of the structural steel support. Deflection channel secured to steel floor units with steel fasteners or welds spaced max 24 in. (610 mm) OC. The ceiling runner (Item 2A) is installed within the deflection channel to maintain a max 1-1/4 in. (32 mm) gap between the top of the ceiling runner and the top of the deflection channel. The ceiling runner nests inside the deflection channel without attachment.
- B. Forming Material*** – Nom 4 pcf (64 kg/m³) density mineral wool batt insulation. Sections of mineral wool batt cut to a width of 4 in. (102 mm) and stacked to attain a thickness which is 50 percent greater than the width of the linear gap between the spray applied fire resistive material on the structural steel member and the surface of the wall assembly. Stacked sections of mineral wool compressed 33 percent in thickness and installed cut edge first into linear gap until the bottom edge is flush with the bottom surface of the spray applied fire resistive material on the structural steel member. When the spray-applied fire resistive material in the flutes above the wall follows the contour of the steel deck, sections of mineral wool batt cut to the shape of the fluted deck and stacked to a min 6 in. (152 mm) thickness shall be installed in the flutes of the steel floor or roof deck between the top of the deflection channel and the spray-applied fire resistive material. The mineral wool batt insulation is to be installed flush with the gypsum board surface on the side of the wall opposite the structural steel support. Additional sections of mineral wool batt insulation are compressed 50 percent in thickness and are installed cut edge first to completely fill the gap above the top of the gypsum board.

ROCK WOOL MANUFACTURING CO – Delta Board

ROCKWOOL MALAYSIA SDN BHD – SAFE

ROCKWOOL – SAFE

THERMAFIBER INC – SAF Mineral Wool

- C. Fill, Void or Cavity Material* – Sealant** – Min 1/8 in. (3.2 mm) wet thickness or 1/16 in. (1.6 mm) dry thickness of fill material spray applied over the forming material on each side of the wall. Fill material to overlap a min of 1/2 in. (13 mm) onto the gypsum board and a min 2 in. (51 mm) onto the spray applied material (Item 1C) on the steel floor unit or on the structural steel support member on each side of the wall.

3M COMPANY – FireDam™ Spray 200

- C1. Fill, Void or Cavity Material* – Tape** – As an alternate to Item C, Tape cut to size and press applied within fluted areas of joint to completely cover mineral wool lapping min 2 in. (51 mm) onto the contour of the protected steel floor units and extending to lap min 1 in. (25 mm) onto the gypsum wall. Additional pieces of Tape are applied along the joint to completely cover the remaining mineral wool between bottom of protected steel deck and top edge of wall along length of joint, lapping min 2 in. (51 mm) onto the contour of the protected steel floor units and min 1 in. (25 mm) onto the gypsum wall. Additional pieces of Tape to be applied to completely cover the mineral wool between structural support beam and face of wall, lapping min 2 in. (51 mm) onto sprayed structural beam and min 1 in. onto gypsum wall. Adjoining lengths of Tape shall overlap min 1/2 in. (13 mm).

3M COMPANY – 3M Fire and Water Barrier Tape

Construction Joints

Head of Wall

HW-D



*Indicates such products shall bear the UL or cUL Certification Mark for jurisdictions employing the UL or cUL Certification (such as Canada), respectively.

Reprinted from the Online Certifications Directory with permission from UL©

3M Industrial Adhesives and Tapes
Fire Protection Products
3M Center, Building 230-B-S-37
St. Paul, MN 55144-1000



UL System No. HW-D-0385
XHBN - Joint Systems
XHBN7 - Joint Systems Certified for Canada

January 12, 2018

| ANSI/UL2079 | CAN/ULC S115 |
|---|---|
| Assembly Ratings – 2, 3 and 4 Hr (See Item 2) | F Ratings – 2, 3 and 4 Hr (See Item 2) |
| Nominal Joint Width - 2 In. | FT Ratings – 2, 3 and 4 Hr (See Item 2) |
| Class II Movement Capabilities – 50% Compression or Extension | FH Ratings – 2, 3 and 4 Hr (See Item 2) |
| | FTH Ratings – 2, 3 and 4 Hr (See Item 2) |
| | Nominal Joint Width – 51 mm |
| | Class II Movement Capabilities – 50% Compression or Extension |

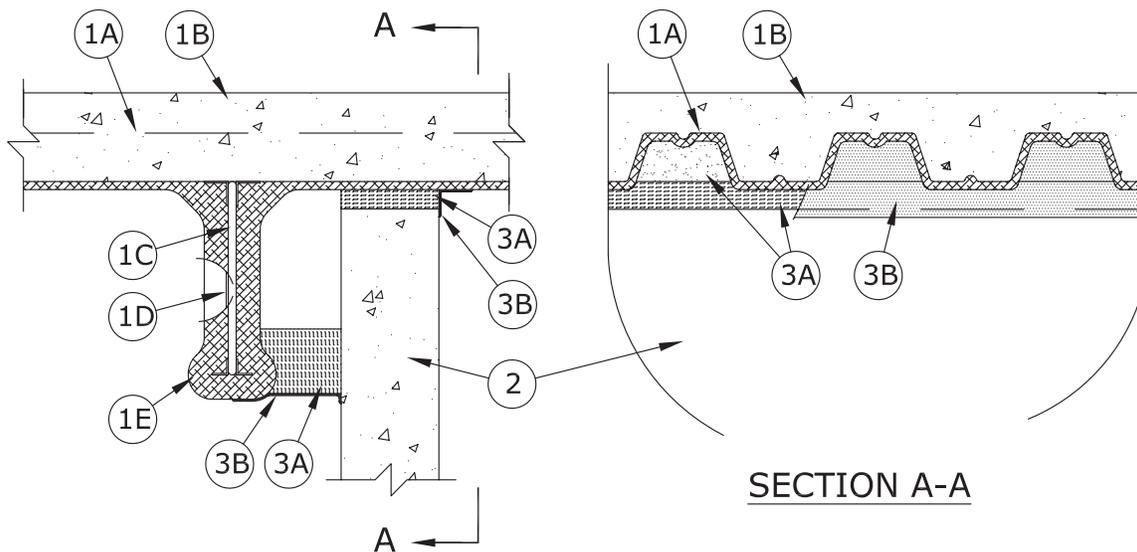

1. **Floor Assembly** – The fire-rated fluted steel deck/concrete floor assembly shall be constructed of the materials and in the manner described in the individual D700 or D800 Series Floor-Ceiling Design in the UL Fire Resistance Directory. The hourly fire rating of the floor assembly shall be equal to or greater than the hourly fire rating of the wall assembly. The floor assembly shall include the following construction features:
 - A. **Steel Floor and Floor Units*** – Max 3 in. (76 mm) deep galv steel fluted floor units.
 - B. **Concrete** – Min 2-1/2 in. (64 mm) thick reinforced concrete, as measured from the top plane of the floor units.
 - C. **Structural Steel Support** – Steel beam or open-web steel joist, as specified in the individual D700 or D800 Series Floor-Ceiling Design, used to support steel floor units. Structural steel support oriented parallel to and min 2 in. (51 mm) to max 6 in. (152 mm) from wall assembly.
 - D. **Steel Lath** – When structural steel support (Item 1C) consists of open-web steel joists, 3/8 in. (10 mm) diamond mesh expanded steel lath having a nom weight of 1.7 to 3.4 lb per sq yd (0.9 to 1.8 kg/m²) shall be installed to completely cover one side of each joist which is located within 6 in. (152 mm) of wall assembly. The lath shall be secured with steel tie wire and shall be fully covered with spray applied fire resistive material.
 - E. **Spray-Applied Fire Resistive Material*** – Steel floor units and structural steel supports to be sprayed with the thickness of material specified in the individual D700 or D800 Series Design. The flutes of the steel floor units above the structural steel supports shall be filled with spray-applied fire resistive material. The spray-applied fire resistive material in the flutes above the wall shall be applied to follow the contour of the steel floor units.

GCP APPLIED TECHNOLOGIES INC – Type MK-6/HY
- 1A. **Roof Assembly** – (Not Shown) – As an alternate to the floor assembly (Item 1), a fire rated fluted steel deck roof assembly may be used. The roof assembly shall be constructed of the materials and in the manner described in the individual P700 or P800 Series Roof-Ceiling Design in the UL Fire Resistance Directory. The hourly fire rating of the roof assembly shall be equal to or greater than the hourly fire rating of the wall assembly. The roof assembly shall include the following construction features:
 - A. **Steel Roof Deck** – Max 3 in. (76 mm) deep galv steel fluted roof deck.
 - B. **Roof Insulation** – Mineral and Fiber Board* – Min 3/4 in. (19 mm) thick boards applied in one or more layers directly over steel roof deck or over gypsum board sheathing laid atop steel roof deck.
 - C. **Roof Covering*** – Hot-mopped or cold-application materials compatible with mineral and fiber board insulation.

- D. Structural Steel Support** – Steel beam or open-web steel joist, as specified in the individual P700 or P800 Series Roof-Ceiling Design, used to support steel floor units. Structural steel support oriented parallel to and min 2 in. (51 mm) to max 6 in. (152 mm) from wall assembly.
- E. Steel Lath** – When structural steel support (Item 1D) consists of open-web steel joists, 3/8 in. (10 mm) diamond mesh expanded steel lath having a nom weight of 1.7 to 3.4 lb per sq yd (0.9 to 1.8 kg/m²) shall be installed to completely cover one side of each joist which is located within 6 in. (152 mm) of wall assembly. The lath shall be secured with steel tie wire and shall be fully covered with spray applied fire resistive material.
- F. Spray-Applied Fire Resistive Material*** – Steel roof deck and structural steel supports to be sprayed with a thickness of spray applied fire resistive material as specified in the individual P700 or P800 Series Roof-Ceiling design. The flutes of the steel deck above the structural steel supports shall be filled with spray-applied fire resistive material. The spray-applied fire resistive material in the flutes above the wall shall be applied to follow the contour of the steel roof deck.

GCP APPLIED TECHNOLOGIES INC – Type MK-6/HY

- 2. Wall Assembly** – Min 6 in. (152 mm) thick steel-reinforced lightweight or normal weight (100-150 pcf or 1600-2400 kg/m³) structural concrete. Wall may also be constructed of any UL Classified Concrete Blocks*.

See **Concrete Blocks** (CAZT) category in the Fire Resistance Directory for names of manufacturers.

The hourly fire rating of the joint system is equal to the hourly fire rating of the wall assembly.

- 3. Joint System** – Max separation between bottom plane of spray-applied fire resistive material on the steel floor unit and the top of the concrete wall assembly (at time of installation of joint system) is 2 in. (51 mm). Separation distance between spray applied fire resistive material on structural support member and surface of wall is min 1 in. (25 mm) to max 4 in. (102 mm). The joint system is designed to accommodate a max 50 percent compression or extension from its installed width as measured between the bottom plane of the spray-applied fire resistive material on the steel floor unit and the top of the wall. The joint system shall consist of forming and fill materials, as follows:
 - A. Forming Material*** – Nom 4 pcf (64 kg/m³) density mineral wool batt insulation. Sections of mineral wool batt cut to a width of 4 in. (102 mm) and stacked to attain a thickness which is 50 percent greater than the width of the linear gap between the spray applied fire resistive material on the structural steel member and the surface of the wall assembly. Stacked sections of mineral wool compressed 33 percent in thickness and installed cut edge first into linear gap until the bottom edge is flush with the bottom surface of the spray applied fire resistive material on the structural steel member. On the opposite side of the wall, sections of mineral wool batt insulation cut to the width of the wall inserted edge-first between the top of the wall and the spray-applied fire resistive material on the valleys of the steel deck, compressed approx 50 percent in thickness beneath each valley and flush with the wall surface. Additional pieces of mineral wool batt cut to the shape of the steel deck flute, stacked to a min 6 in. (152 mm) thickness and installed in the flutes above the wall flush with the wall surface.
 - ROCK WOOL MANUFACTURING CO** – Delta Board
 - ROCKWOOL MALAYSIA SDN BHD** – SAFE
 - ROCKWOOL** – SAFE
 - THERMAFIBER INC** – SAF Mineral Wool
 - B. Fill, Void or Cavity Material* – Sealant** – Min 1/8 in. (3.2 mm) wet thickness or 1/16 in. (1.6 mm) dry thickness of fill material spray applied over the forming material on each side of the wall. Fill material to overlap a min of 1/2 in. (13 mm) onto the wall surface and a min of 2 in. (51 mm) onto the spray-applied fire resistive material on each side of the wall.
 - 3M COMPANY** – FireDam™ Spray 200
 - B1. Fill, Void or Cavity Material* – Tape** – As an alternate to Item B, Tape cut to size and press applied within fluted areas of joint to completely cover mineral wool lapping min 2 in. (51 mm) onto the contour of the protected steel floor units and extending to lap min 1 in. (25 mm) onto the concrete wall. Additional pieces of Tape are applied along the joint to completely cover the remaining mineral wool between bottom of protected steel deck and top edge of wall along length of joint, lapping min 2 in. (51 mm) onto the contour of the protected steel floor units and min 1 in. (25 mm) onto the concrete wall. Additional pieces of Tape to be applied to completely cover the mineral wool between structural support beam and face of wall, lapping min 2 in. (51 mm) onto sprayed structural beam and min 1 in. onto face of concrete wall. Adjoining lengths of Tape shall overlap min 1/2 in. (13 mm).
 - 3M COMPANY** – 3M Fire and Water Barrier Tape



*Indicates such products shall bear the UL or cUL Certification Mark for jurisdictions employing the UL or cUL Certification (such as Canada), respectively.

Reprinted from the Online Certifications Directory with permission from UL©

System No. HW-D-0441

March 14, 2006

Assembly Rating – 3 Hr

Nominal Joint Width – 2 In.

Class II Movement Capability – 13% Compression and Extension

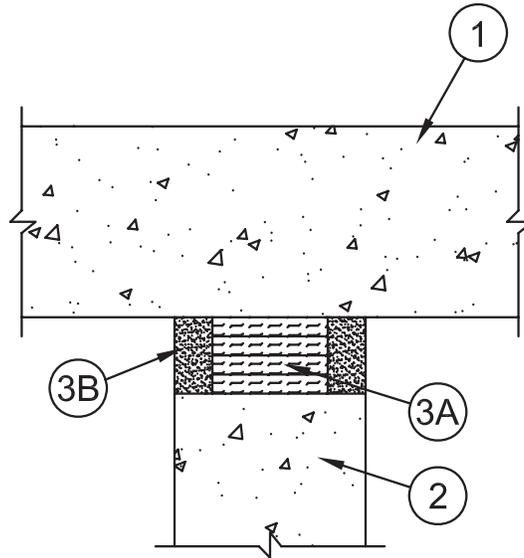

- Floor Assembly** – Min 4-1/2 in. (114 mm) thick reinforced lightweight or normal weight (100-150 pcf or 1600-2400 kg/m³) structural concrete.
- Wall Assembly** – Min 5-1/4 in. (133 mm) thick reinforced lightweight or normal weight (100-150 pcf or 1600-2400 kg/m³) structural concrete. Wall may also be constructed of any UL Classified **Concrete Blocks***.
See **Concrete Blocks** (CAZT) category in the Fire Resistance Directory for names of manufacturers.
- Joint System** – Max separation between bottom of floor and top of wall (at time of installation of joint system) is 2 in. The joint system is designed to accommodate a max 13 percent compression or extension from its installed width. The joint system shall consist of the following:
 - Forming Material*** – Min 4.0 pcf (64 kg/m³) mineral wool batt insulation installed in joint opening as a permanent form. Pieces of batt cut to min width of 4-1/4 in. (108 mm) and installed edge-first into joint opening, parallel with joint direction, such that batt sections are compressed min 50 percent in thickness and such that the compressed batt sections are recessed from both surfaces of wall to accommodate the required thickness of fill material.
IIG MINWOOL L L C – MinWool 1200 Safing
ROCK WOOL MANUFACTURING CO – Delta Board
ROCKWOOL MALAYSIA SDN BHD – SAFE
ROXUL INC – SAFE
THERMAFIBER INC – SAF
 - Fill, Void or Cavity Material*** – **Caulk** – Min 1/2 in. thickness of fill material applied within the joint, flush with both surfaces of wall.
3M COMPANY – FireDam 150+ Caulk

*Bearing the UL Classification Mark

Reprinted from the Online Certifications Directory with permission from UL
© 2012 UL LLC



UL System No. HW-D-0447

December 13, 2016

ANSI/UL2079

Assembly Rating – 2 Hr
Nominal Joint Width – 2 in.

Class II Movement Capabilities – 25% Compression or Extension

CAN/ULC S115

F Rating – 2 Hr
FT Rating – 2 Hr
FH Rating – 2 Hr
FTH Rating – 2 Hr
51 mm

Class II Movement Capabilities – 25% Compression or Extension

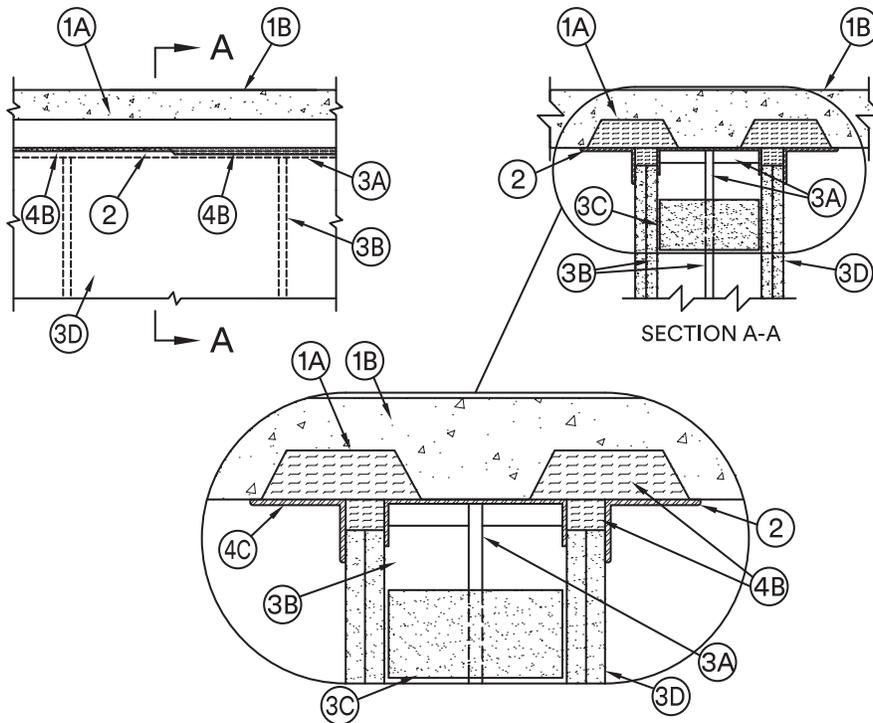

1. **Floor Assembly** – The fire-rated fluted steel deck/concrete floor assembly shall be constructed of the materials and in the manner described in the individual D900 Series Floor-Ceiling Design in the UL Fire Resistance Directory and shall include the following construction features:
 - A. **Steel Floor And Form Units*** – Max 3 in. (76 mm) deep galv steel fluted floor deck.
 - B. **Concrete** – Min 2-1/2 in. (64 mm) thick reinforced concrete, as measured from the top plane of the floor deck.
2. **Steel Straps** – Nom 2 in. (51 mm) wide min No. 20 gauge galv steel straps, spaced max 24 in. (610 mm) OC. Steel straps cut to overlap a min of 1-1/2 in. (38 mm) onto two adjacent valleys of floor deck and secured using min 1-1/4 in. (32 mm) long steel fasteners with steel fender washers at each end. When optional isolation pads (Item 4D) are used, continuous min No. 20 gauge galv steel backing plate(s) may be substituted for the steel straps. Backing plate(s) to overlap a min of 1-1/2 in. (38 mm) onto valleys of floor deck and secured using min 1-1/4 in. (32 mm) long steel fasteners with steel fender washers spaced max 24 in. (610 mm) OC.
3. **Wall Assembly** – The 2 hr fire rated double steel stud/gypsum board wall assembly shall be constructed of the materials and in the manner described in the individual U400 or V400 Series Wall and Partition Design in the UL Fire Resistance Directory and shall include the following construction features:
 - A. **Steel Floor And Ceiling Runners** – Floor and ceiling runners of wall assembly shall consist of galv steel channels sized to accommodate steel studs (Item 3B). When deflection channels (Item 4A) are used, ceiling runners to be provided with 3 in. (76 mm) flanges. Ceiling runners installed within the deflection channels with 2 in. (51 mm) gap maintained between the top of ceiling runner and top of deflection channel. When deflection channels are not used, flange height of ceiling runners shall be min 3/4 in. (19 mm) greater than nom joint width. Ceiling runners installed parallel with direction of fluted steel floor units and secured to steel straps (Item 2) with two No. 8 self-drilling, self-tapping steel screws per strap.
 - B. **Studs** – Steel studs to be min 3-1/2 in. (89 mm) wide. Studs cut 1/2 to 2 in. (13 to 51 mm) less in length than assembly height with bottom nesting in and resting on floor runner and with top nesting in ceiling runner without attachment. Opposing studs to align. Stud spacing not to exceed 24 in. (610 mm) OC.
 - C. **Bracing** – Cut from pieces of steel channel or gypsum board and screw-attached to opposing studs as specified in the individual Wall and Partition Design.
 - D. **Gypsum Board*** – Gypsum board sheets installed to a min total thickness of 1-1/4 in. (32 mm) on each side of wall. Wall to be constructed as specified in the individual Wall and Partition Design in the UL Fire Resistance Directory, except that a max 2 in. (51 mm) gap shall be maintained between the top of the gypsum board and the bottom of the steel floor roof deck and the top row of screws shall be installed into the studs 4-1/2 in. (114 mm) below the lower surface of the floor or roof deck.

Construction Joints

Head of Wall

HWD

- 4. Joint System** – Max separation between bottom of floor and top of wall is 2 in. (51 mm). The joint system is designed to accommodate a max 25 percent compression or extension from its installed width. The joint system consists of optional deflection channels, forming material and a fill material, as follows:
- A. Deflection Channel** (optional, not shown) – Nom 3-5/8 in. (92 mm) wide by 3 in. (76 mm) deep min 24 gauge steel U-shaped channels. Deflection channels installed parallel with direction of fluted steel floor units and secured to steel straps (Item 2) with two No. 8 self-drilling, self-tapping steel screws per strap. The ceiling runner (Item 3A) is installed within the deflection channel to maintain a max 2 in. (51 mm) gap between the top of the ceiling runner and the top of the deflection channel. The ceiling runner is not fastened to the deflection channel.
 - B. Forming Material*** – Min 4 pcf (64 kg/m³) density mineral wool batt insulation installed to entirely fill the flutes of the steel floor units above the steel straps or steel backing plates. Mineral wool cut into strips having an approximate width equal to that of the flute, stacked as needed and then compressed 50 percent in thickness into the flute. Butted end seams of mineral wool strips to be centered over steel straps. Additional 1-1/4 in. (32 mm) wide sections of mineral wool batt insulation are compressed 50 percent in thickness and installed cut edge first to completely fill the gap above the top of the gypsum board. The forming material shall be installed flush with both surfaces of wall.
 - INDUSTRIAL INSULATION GROUP LLC** – MinWool-1200 Safing
 - JOHNS MANVILLE** – Safing
 - ROCK WOOL MANUFACTURING CO** – Delta Board or Delta-8
 - ROCKWOOL MALAYSIA SDN BHD** – Type Safe
 - ROXUL INC** – Type Safe
 - THERMAFIBER INC** – Type SAF
 - C. Fill, Void or Cavity Material*** – Min 1/16 in. (1.6 mm) dry thickness (1/8 in. or 3.2 mm wet thickness) of fill material sprayed or brushed on each side of the wall to completely cover mineral wool and steel straps or steel backing plates and to overlap a min of 1/2 in. (13 mm) onto gypsum board and steel deck on both sides of wall.
 - 3M COMPANY** – FireDam™ Spray 200
 - C1. Fill, Void or Cavity Material* – Tape** – As an alternate to Item C, Tape cut to size and press applied to completely cover mineral wool between bottom of steel floor units and top of wall, lapping min 1 in. (25 mm) onto the gypsum wall and extending to cover the exposed mineral wool within the flutes and lapping min 1 in. (25 mm) onto the contour of the steel floor units min. Tape shall be applied in min 1 ft (305 mm) lengths along the joint and adjoining lengths of Tape shall overlap min 1/2 in. (13 mm). Tape shall be applied at both sides of wall.
 - 3M COMPANY** – 3M Fire and Water Barrier Tape
 - D. Isolation Pads** (optional, not shown) – As an option, max 1/2 in. (13 mm) thick molded high density glass fiber isolation pads may be installed between the deflection channels (Item 3A) and the steel straps (Item 2) for sound control purposes. The isolation pads shall be cut to the width of each deflection channel and shall be installed along the entire length of the wall. When the isolation pads are used, the deflection channels shall be secured to the steel deck, through the isolation pads and steel straps or steel backing plates, with mechanical fasteners in conjunction with steel fender washers and neoprene isolation grommets supplied by the maker of the isolation pad material.

*Indicates such products shall bear the UL or cUL Certification Mark for jurisdictions employing the UL or cUL Certification (such as Canada), respectively. 

Reprinted from the Online Certifications Directory with permission from UL©



UL System No. HW-D-0465
XHBN - Joint Systems
XHBN7 - Joint Systems Certified for Canada

January 12, 2018

| ANSI/UL2079 | CAN/ULC S115 |
|--|--|
| Assembly Ratings – 1, 2, 3 and 4 Hr (See Items 1 and 2) | F Ratings – 1, 2, 3 and 4 Hr (See Items 1 and 2) |
| Nominal Joint Width – 2 In. | FT Ratings – 1, 2, 3 and 4 Hr (See Items 1 and 2) |
| Class II Movement Capabilities – 50% Compression or Extension | FH Ratings – 1, 2, 3 and 4 Hr (See Items 1 and 2) |
| | FTH Ratings – 1, 2, 3 and 4 Hr (See Items 1 and 2) |
| | Nominal Joint Width – 51 mm |
| | Class II Movement Capabilities – 50% Compression or Extension |

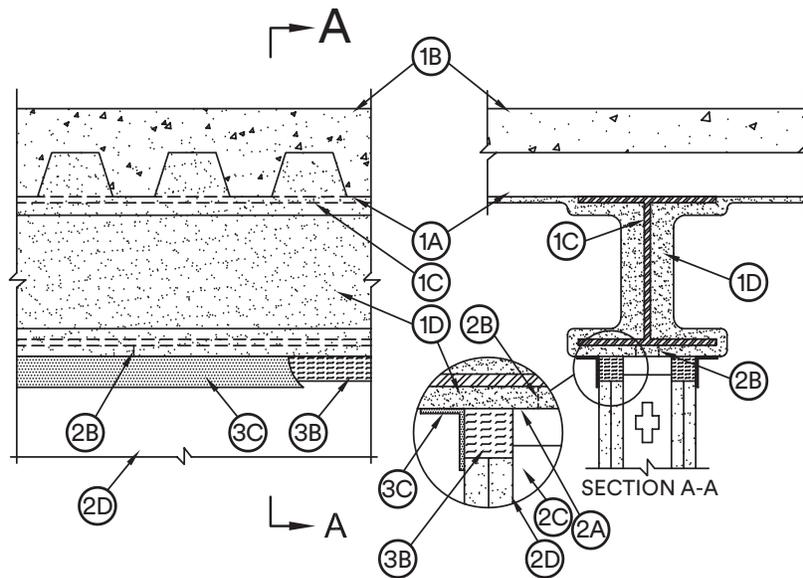

CONFIGURATION A

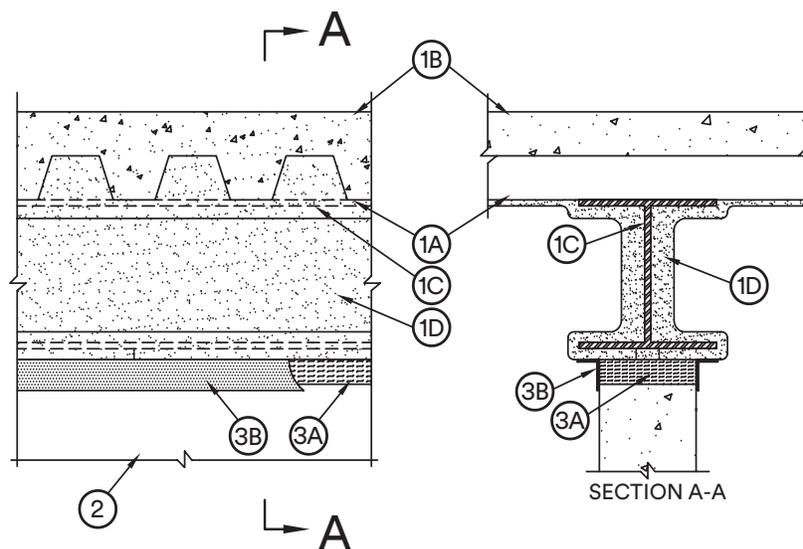

CONFIGURATION B

1. **Floor Assembly** – The fire-rated fluted steel deck/concrete floor assembly shall be constructed of the materials and in the manner described in the individual D700 Series Floor-Ceiling Design in the UL Fire Resistance Directory and shall include the following construction features:
 - A. **Steel Floor And Floor Units*** – Max 3 in. (76 mm) deep galv steel fluted floor units.
 - B. **Concrete** – Min 2-1/2 in. (64 mm) thick reinforced concrete, as measured from the top plane of the floor units.
 - C. **Structural Steel Support** – Steel beam, as specified in the individual D700 Series Floor-Ceiling Design, used to support steel floor units. Steel beam centered over and parallel with wall assembly.
 - D. **Spray-Applied Fire Resistive Material*** – After installation of the steel attachment clips (Item 2B), steel floor units and structural steel support to be sprayed with the min thickness of material specified in the individual D700 Series Design. The flutes of the steel floor units are to be filled with material across the entire top flange of the steel beam. **Additional material shall be applied to the web of the steel beam on each side of the wall. For a 1 hr Assembly, F, FT, FH and FTH Rating, the thickness of material applied to each side of the steel beam web shall be 13/16 in. (21 mm). For a 2 hr Assembly, F, FT, FH and FTH Rating, the thickness of material applied to each side of the steel beam web shall be 1-3/8 in. (35 mm). For a 3 hr Assembly, F, FT, FH and FTH Rating, the thickness of material applied to each side of the steel beam web shall be 3-1/16 in. (78 mm). For a 4 hr Assembly, F, FT, FH and FTH Rating, the thickness of material applied to each side of the steel beam web shall be 4-7/16 in. (113 mm).**

GCP APPLIED TECHNOLOGIES INC – Type MK-6/HY

Joint Configuration A

2. **Wall Assembly** – The 1,2, 3 or 4 hr fire-rated gypsum board/stud wall assembly shall be constructed of the materials and in the manner described in the individual U400 or V400 Series Wall or Partition Design in the UL Fire Resistance Directory and shall include the following construction features:
 - A. **Steel Floor and Ceiling Runners** – Floor and ceiling runners of wall assembly shall consist of galv steel channels sized to accommodate steel studs (Item 2B). Ceiling runner flange height to be min 1/2 in. (13 mm) greater than joint width at max anticipated extension. When deflection channel (Item 3A) is used, flange height of ceiling runner is to be equal to or greater than flange height of deflection channel and the ceiling runner is to nest within the deflection channel with a max 1-1/4 (32 mm) gap maintained between the top of the ceiling runner and the top of the deflection channel. When deflection channel is not used, ceiling runner is secured to steel beam (Item 1A) with steel attachment clips (Item 2B) spaced max 24 in. (610 mm) OC. Ceiling runner or deflection channel to be centered beneath and parallel with bottom flange of steel beam. A clearance equal to the required thickness of spray-applied fire resistive material (Item 1D) shall be maintained between the top of the ceiling runner or deflection channel and the bottom flange of the steel beam.
 - B. **Steel Attachment Clips** – Z-shaped clips formed from min 1 in. (25 mm) wide strips of min 16 ga galv steel. Clips to be sized to extend through the thickness of the spray-applied fire resistive material on the bottom flange of the steel beam with 2 in. (51 mm) long upper and lower legs. Clips to be installed perpendicular to steel beam direction. Legs of clips fastened to center of the steel beam bottom flange and to top center of ceiling runner (or deflection channel) prior to application of spray-applied fire resistive materials using steel fasteners or welds. Clips spaced max 16 in. (406 mm) OC.
 - C. **Studs** – Steel studs to be min 3-5/8 in. (92 mm) wide. Studs cut max 1-1/4 in. (32 mm) less in length than assembly height to accommodate max anticipated compression of joint width with bottom nesting in and resting on floor runner and with top nesting in ceiling runner without attachment. Stud spacing not to exceed 24 in. (610 mm) OC. When deflection channel (Item 3A) is used, steel studs attached to ceiling runner (Item 2A) with sheet metal screws located 1/2 in. (13 mm) below the bottom of the deflection channel. When deflection channel is not used, studs to nest in ceiling runner without attachment.
 - D. **Gypsum Board*** – Gypsum board sheets installed to a min total 5/8 in. (16 mm), 1-1/4 in. (32 mm), 1-7/8 in. (48 mm) or 2-1/2 in. (64 mm) thickness on each side of wall for 1, 2, 3 and 4 hr fire rated assemblies, respectively. Wall to be constructed in accordance with the individual U400 or V400 Series Wall and Partition Design in the UL Fire Resistance Directory except that a max 2 in. (51 mm) high gap shall be maintained between the top of the gypsum board and the bottom plane of the spray applied fire resistive material on the bottom flange of the steel beam. The screws attaching the gypsum board to the studs along the top of the wall shall be located 1 in. (25 mm) below the bottom of the ceiling runner. No gypsum board attachment screws shall be driven into the ceiling runner or into the optional deflection channel.

The hourly Assembly, F, FT, FH and FTH R ratings of the joint system are equal to the hourly fire rating of the wall.

3. **Joint System** – Max separation between spray applied fire resistive material on bottom of steel beam and top of gypsum board (at time of installation of joint system) is 2 in. (51 mm). The joint system is designed to accommodate a max 50 percent compression or extension from its installed width as measured between the bottom plane of the protective material on the steel beam and the top of the gypsum board. The joint system shall consist of forming and fill materials, with or without a deflection channel (Item 3A), as follows:
 - A. **Deflection Channel** – (Optional, Not Shown) - Max 2 in. (51 mm) deep min 24 gauge galv steel channel sized to accommodate ceiling runner (Item 2A). Deflection channel installed parallel with and centered beneath bottom flange of steel beam (Item 1C) and secured to steel beam with steel attachment clips (Item 2B) spaced max 16 in. (406 mm) OC. The ceiling runner (Item 2A) is installed within the deflection channel to maintain a max 1-1/4 (32 mm) gap between the top of the ceiling runner and the top of the deflection channel. A clearance equal to the required thickness of spray-applied fire resistive material (Item 1D) shall be maintained between the top of the ceiling runner or deflection channel and the bottom flange of the steel beam. The ceiling runner nests inside the deflection channel without attachment.

- B. Forming Material*** – Sections of min 4 pcf (64 kg/m³) mineral wool batt insulation to be compressed 33 percent in thickness and installed cut-edge first to completely fill the gap between the spray-applied fire resistive material and the top of the gypsum board. The forming material shall be installed flush with both surfaces of wall.

INDUSTRIAL INSULATION GROUP L L C – MinWool-1200 Safing

JOHNS MANVILLE – Safing

ROCK WOOL MANUFACTURING CO – Delta Board

ROCKWOOL MALAYSIA SDN BHD – SAFE

ROCKWOOL – SAFE

THERMAFIBER INC – SAF

- C. Fill, void or Cavity Material* - Sealant** – Min 1/8 in. (3.2 mm) wet thickness or 1/16 in. (1.6 mm) dry thickness of fill material spray applied over the forming material on each side of the wall. Fill material to overlap min 1 in. (25 mm) onto the gypsum board and onto the spray applied fire resistive material on both sides of wall.

3M COMPANY – FireDam Spray 200

- C1. Fill, Void or Cavity Material* – Tape** – As an alternate to Item C, Tape cut to size and press applied to completely cover mineral wool forming material, lapping min 1 in. (25 mm) onto the gypsum wall and min 2 in. (51 mm) onto the sprayed structural support beam. Tape shall be applied in min 1 ft (305 mm) lengths along the joint and adjoining lengths of Tape shall overlap min 1/2 in. (13 mm). Tape shall be applied at both sides of wall.

3M COMPANY – 3M Fire and Water Barrier Tape

Joint Configuration B

- 2. Wall Assembly** – Min 6 in. (152 mm) thick steel-reinforced lightweight or normal weight (100 to 150 pcf or 1600-2400 kg/m³) structural concrete. Wall to be parallel to and centered under steel beam. Wall may also be constructed of any UL Classified Concrete Blocks*.

See **Concrete Blocks** (CAZT) category in the Fire Resistance Directory for names of manufacturers.

The hourly fire rating of the joint system is equal to the hourly fire rating of the wall. When the concrete or block wall is used, the maximum assembly fire rating is 3 Hrs.

- 3. Joint System** – Max separation between spray applied fire resistive material on bottom of steel beam and top of concrete wall (at time of installation of joint system) is 2 in. (51 mm). The joint system is designed to accommodate a max 50 percent compression or extension from its installed width as measured between the bottom plane of the protective material on the steel beam and the top of the concrete wall. The joint system shall consist of forming and fill materials as follows:

- A. Forming Material*** – Sections of min 4 pcf (64 kg/m³) mineral wool batt insulation to be compressed 33 percent in thickness and installed cut-edge first to completely fill the gap between the spray-applied fire resistive material and the top of the concrete wall. The forming material shall be installed flush with both surfaces of wall.

INDUSTRIAL INSULATION GROUP L L C – MinWool-1200 Safing

JOHNS MANVILLE – Safing

ROCK WOOL MANUFACTURING CO – Delta Board

ROCKWOOL MALAYSIA SDN BHD – SAFE

ROCKWOOL – SAFE

THERMAFIBER INC – SAF

- B. Fill, Void or Cavity Material* - Sealant** – Min 1/8 in. (3.2 mm) wet thickness or 1/16 in. (1.6 mm) dry thickness of fill material spray applied over the forming material on each side of the wall. Fill material to overlap min 1 in. (25 mm) onto the wall surface and onto the spray applied fire resistive material on both sides of wall.

3M COMPANY – FireDam Spray 200

- B1. Fill, Void or Cavity Material* – Tape** – As an alternate to Item B, Tape cut to size and press applied to completely cover mineral wool forming material, lapping min 1 in. (25 mm) onto the concrete wall and min 2 in. (51 mm) onto the sprayed structural support beam. Tape shall be applied in min 1 ft (305 mm) lengths along the joint and adjoining lengths of Tape shall overlap min 1/2 in. (13 mm). Tape shall be applied at both sides of wall.

3M COMPANY – 3M Fire and Water Barrier Tape



*Indicates such products shall bear the UL or cUL Certification Mark for jurisdictions employing the UL or cUL Certification (such as Canada), respectively.

Reprinted from the Online Certifications Directory with permission from UL©

UL System No. HW-D-0478

December 13, 2016

ANSI/UL2079

Assembly Rating – 2 Hr
Nominal Joint Width – 2 in.

Class II Movement Capabilities – 25% Compression or Extension

CAN/ULC S115

F Rating – 2 Hr
FT Rating – 2 Hr
FH Rating – 2 Hr
FTH Rating – 2 Hr

Nominal Joint Width – 51 mm

Class II Movement Capabilities – 25% Compression or Extension

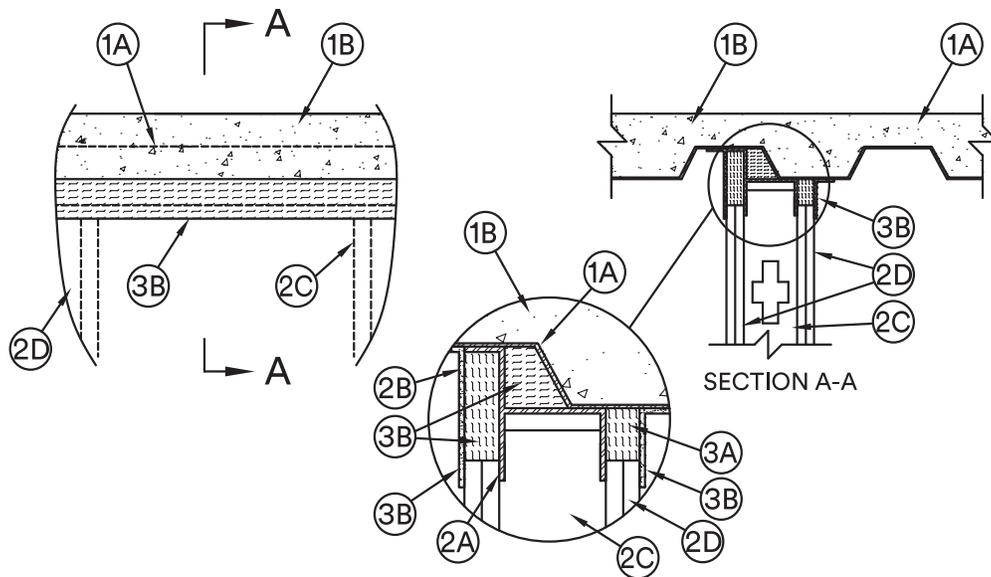

1. Floor Assembly – The fire rated fluted steel deck/concrete floor assembly shall be constructed of the materials and in the manner described in the individual Floor-Ceiling Design in the UL Fire Resistance Directory and shall include the following construction features:

- A. Steel Floor And Form Units*** – Max 3 in. (76 mm) deep fluted galv steel deck.
- B. Concrete** – Min 2-1/2 in. (64 mm) thick reinforced concrete, as measured from the top plane of the floor units.

2. Wall Assembly – The 2 hr fire rated gypsum board/steel stud wall assembly shall be constructed of the materials and in the manner described in the individual U400 or V400 Series Wall and Partition Design in the UL Fire Resistance Directory and shall include the following construction features:

- A. Steel Floor And Ceiling Runners** – Floor and ceiling runners of wall assembly shall consist of min 25 ga galv steel channels sized to accommodate steel studs (Item 2B). Ceiling runner to be provided with min 3 in. (76 mm) flanges. Ceiling runner installed parallel with direction of fluted steel deck with one side in contact with deck valley and with opposite side cantilevered minimum 1-1/2 in. (38 mm) beyond deck valley. Ceiling runner secured to valley of deck with steel anchors or welds spaced max 24 in. (610 mm) OC. Ceiling runner additionally secured to crest of deck in conjunction with steel attachment clips (Item 2B).
- B. Steel Attachment Clips** – Z-shaped clips formed from min 1 in. (25 mm) wide strips of min 16 ga galv steel. Height of clip to be equal to depth of steel deck. Legs of clip to be sized to lap min 1 in. (25 mm) on crest of steel deck and min 1 in. (25 mm) on top of steel ceiling runner. Web of clip to be parallel and flush with side edge of ceiling runner. Legs of clips fastened to crest of the steel deck and to the top of the ceiling runner (or deflection channel) prior to application of spray-applied fire resistive materials using steel fasteners or welds. Clips spaced max 6 in. (152 mm) OC.
- C. Studs** – Steel studs to be min 3-1/2 in. (89 mm) wide. Studs cut 1/2 to 3/4 in. (13 to 19 mm) less in length than assembly height with bottom nesting in and resting on floor runner and with top nesting in ceiling runner without attachment. Stud spacing not to exceed 24 in. (610 mm) OC.
- D. Gypsum Board*** – Gypsum board sheets installed to a min total thickness of 1-1/4 in. (32 mm) on each side of wall. Wall to be constructed as specified in the individual Wall and Partition Design in the UL Fire Resistance Directory, except that a max 2 in. (51 mm) gap shall be maintained between the top of the gypsum board and the bottom plane of the steel deck floor and the top row of screws shall be installed into the studs 1 in. (25 mm) below the bottom of the ceiling runner.

3. Joint System – Max separation between bottom plane of steel deck floor and top of gypsum board is 2 in. (51 mm). The joint system is designed to accommodate a max 25 percent compression or extension from its installed width. The joint system consists of the following:

- A. Forming Material*** – The flute area of the steel deck above the cantilevered ceiling runner is to be tightly packed with min 4 pcf (64 kg/m³) mineral wool batt insulation inserted cut-edge first and compressed min 33 percent in thickness. Nom 1-1/4 in. (32 mm) thick strips of min 4 pcf (64kg/m³) mineral wool batt insulation to be cut to a width which is 1 in. (25 mm) greater than the vertical distance between the top of the gypsum board and the steel deck on each side of the wall. Mineral wool strips to be compressed in width and installed to fill the gap between the top of the gypsum board and the bottom of the steel floor deck flush with the wall surface on each side of the wall.

INDUSTRIAL INSULATION GROUP LLC – MinWool-1200 Safing

JOHNS MANVILLE – Safing

Construction Joints

Head of Wall

HWD

UL System No. HW-D-0478 (cont.)

ROCK WOOL MANUFACTURING CO – Delta Board or Delta -8

ROCKWOOL MALAYSIA SDN BHD – Type Safe

ROXUL INC – Type Safe

THERMAFIBER INC – Type SAF

- B. Fill, Void or Cavity Material* – Sealant** – Min 1/8 in. (3.2 mm) wet thickness or 1/16 in. (1.6 mm) dry thickness of fill material spray applied over the forming material on each side of the wall. Fill material to overlap min 2 in. (51 mm) onto steel deck and min 1 in. (25 mm) onto the gypsum board on both sides of the wall.

3M COMPANY

3M FIRE PROTECTION PRODUCTS – FireDam 200 Spray

- B1. Fill, Void or Cavity Material* – Tape** – As an alternate to Item B, Tape cut to size and press applied over the mineral wool forming material and lapping min 1 in. (25 mm) onto the steel floor units and gypsum wall. Tape applied in minimum 1 ft (305 mm) lengths along joint and adjoining lengths of Tape shall overlap min 1/2 in. (13 mm). Tape shall be applied at both sides of wall.

3M COMPANY – 3M Fire and Water Barrier Tape

*Indicates such products shall bear the UL or cUL Certification Mark for jurisdictions employing the UL or cUL Certification (such as Canada), respectively. 

Reprinted from the Online Certifications Directory with permission from UL©

Construction Joints

Head of Wall

HW-D

UL System No. HW-D-0479

December 13, 2016

ANSI/UL2079

Assembly Rating – 2 Hr
Nominal Joint Width – 2 in.

Class II Movement Capabilities – 25% Compression or Extension

CAN/ULC S115

F Rating – 2 Hr
FT Rating – 2 Hr
FH Rating – 2 Hr
FTH Rating – 2 Hr

Nominal Joint Width – 51 mm

Class II Movement Capabilities – 25% Compression or Extension

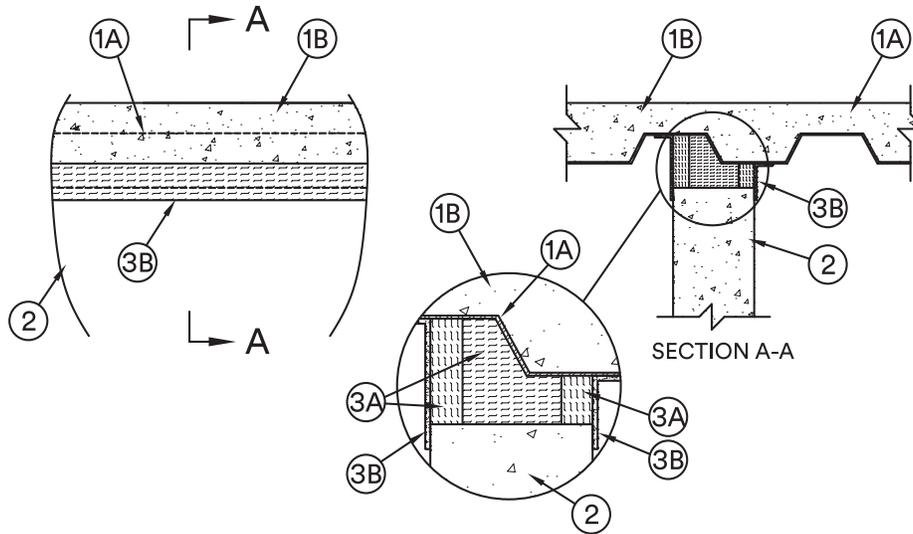

1. Floor Assembly – The fire rated fluted steel deck/concrete floor assembly shall be constructed of the materials and in the manner described in the individual Floor-Ceiling Design in the UL Fire Resistance Directory and shall include the following construction features:

A. Steel Floor And Form Units* – Max 3 in. (76 mm) deep fluted galv steel deck.

B. Concrete – Min 2-1/2 in. (64 mm) thick reinforced concrete, as measured from the top plane of the floor units.

2. Wall Assembly – Min 6-1/8 in. (156 mm) thick steel-reinforced lightweight or normal weight (100-150 pcf or 1600-2400 kg/m³) concrete. Wall may also be constructed of any UL Classified **Concrete Blocks***. Wall assembly to be installed parallel with fluted steel floor deck with a min of 2 in. (51 mm) of the wall thickness beneath valley of deck.

See **Concrete Blocks** (CAZT) category in the Fire Resistance Directory for names of manufacturers

3. Joint System – Max separation between bottom plane of steel deck floor and top of wall is 2 in. (51 mm). The joint system is designed to accommodate a max 25 percent compression or extension from its installed width. The joint system consists of the following:

A. Forming Material* – The area between the top of the wall and the steel deck is to be tightly packed with min 4 pcf (64 kg/m³) mineral wool batt insulation inserted cut-edge first and compressed min 33 percent in thickness. The forming material is to be recessed 1-1/4 in. (32 mm) from each surface of the wall to accommodate vertically-oriented strips of forming material. Nom 1-1/4 in. (32 mm) thick strips of min 4 pcf (64kg/m³) mineral wool batt insulation to be cut to a width which is 1 in. (25 mm) greater than the vertical distance between the top of the wall and the steel deck on each side of the wall. Mineral wool strips to be compressed in width and installed to fill the gap between the top of the wall and the bottom of the steel floor deck flush with the wall surface on each side of the wall.

INDUSTRIAL INSULATION GROUP LLC – MinWool-1200 Safing

JOHNS MANVILLE – Safing

ROCK WOOL MANUFACTURING CO – Delta Board or Delta -8

ROCKWOOL MALAYSIA SDN BHD – Type Safe

ROXUL INC – Type Safe

THERMAFIBER INC – Type SAF

B. Fill, Void or Cavity Material* – Sealant – Min 1/8 in. (3.2 mm) wet thickness or 1/16 in. (1.6 mm) dry thickness of fill material spray applied over the forming material on each side of the wall. Fill material to overlap min 2 in. (51 mm) onto steel deck and min 1 in. (25 mm) onto the wall surface on both sides of the wall.

3M COMPANY

3M FIRE PROTECTION PRODUCTS – FireDam 200 Spray

B1. Fill, Void or Cavity Material* – Tape – As an alternate to Item B, Tape cut to size and press applied over the mineral wool forming material and lapping min 1 in. (25 mm) onto the steel floor units and concrete wall. Tape applied in minimum 1 ft (305 mm) lengths along joint and adjoining lengths of Tape shall overlap min 1/2 in. (13 mm). Tape shall be applied at both sides of wall.

3M COMPANY – 3M Fire and Water Barrier Tape

*Indicates such products shall bear the UL or cUL Certification Mark for jurisdictions employing the UL or cUL Certification (such as Canada), respectively. 

Reprinted from the Online Certifications Directory with permission from UL©

Construction Joints

Head of Wall

HWD

System No. HW-D-0488

February 11, 2008

Assembly Rating – 1 Hr

Nominal Joint Width – 2 in.

Class II Movement Capabilities – 100% Compression and Extension

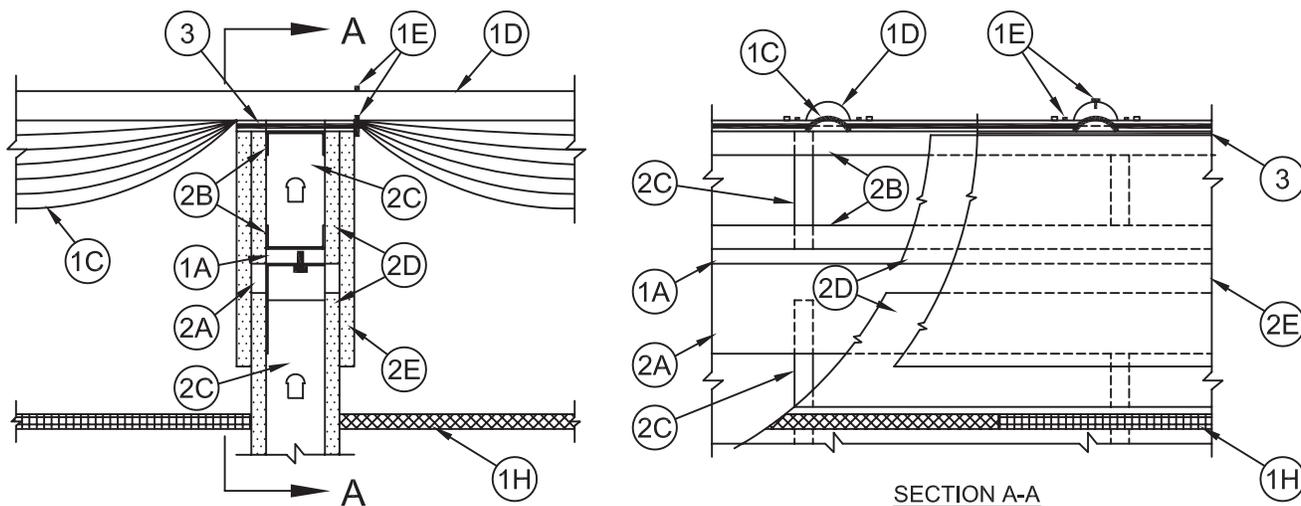

1. **Roof-Ceiling Assembly** – The fire rated roof-ceiling assembly shall be constructed of the materials and in the manner described in the individual P200 or P500 Series **Roof-Ceiling Designs** in the UL Fire Resistance Directory and shall include the following construction features:
 - A. **Purlin** – Min 16 ga coated steel. Max spacing as specified in the individual **Roof-Ceiling Design**.
 - B. **Lateral Bracing** – (Not Shown) – As required.
 - C. **Batts and Blankets* – Insulation** – Any faced compressible glass-fiber blanket insulation having a min 6 in. (152 mm) thickness before compression and a min density of 0.6 pcf (9.6 kg/m³). Insulation draped over purlins prior to installation of panel clips (Item 1F) and/or metal roof deck panels (Item 1D). Side edges of the batts shall be butted or overlapped a max of 3 in. (76 mm).
See **Batts and Blankets (BZJZ)** category in the UL Fire Resistance Directory or **Batts and Blankets (BKNV)** category in the UL Building Materials Directory for names of manufacturers.
 - D. **Metal Roof Deck Panels*** – Min 26 ga coated steel. Panels continuous over two or more spans. Roof panel end laps, if required, centered over purlins with min 3 in. (76 mm) panel overlap as specified in the individual **Roof-Ceiling Design**. A line of tube sealant or tape sealant may be used at panel end and side laps.
See **Metal Roof Deck Panels (TJPV)** category in the UL Roofing Materials and Systems Directory for names of manufacturers.
 - E. **Fasteners** – Fasteners used for panel-to-purlin and panel-to-panel connections to be self-tapping, hex-head, plated steel or stainless steel screws with either an integral or a separate steel washer fitted with a compressible sealing washer. Fastener type, length, pilot hole diam and spacing to be as specified in the individual **Roof-Ceiling Design**.
 - F. **Roof Deck Fasteners* – Panel Clips** – (Not Shown) – Panel clips used for panel-to-purlin connections to be secured to purlin through insulation as specified in the individual **Roof-Ceiling Design**.
See **Roof Deck Fasteners (TLSX)** category in the UL Roofing Materials and Systems Directory for names of manufacturers.
 - G. **Thermal Spacer Blocks** – (Not Shown) – Expanded polystyrene strips cut to fit between panel clips (Item 1F) as specified in the individual **Roof-Ceiling Design**. Thermal spacer blocks, when used, are to be installed between insulation (Item 1C) and metal roof deck panels (Item 1D) over purlins.
 - H. **Ceiling Membrane – The Steel Framing Members*, Acoustical Material*, Gypsum Board*** and other ceiling membrane components shall be as specified in the individual **Roof-Ceiling Design**.
2. **Wall Assembly** – The 1 h fire-rated gypsum board/steel stud wall assembly shall be constructed of the materials and in the manner specified in the individual U400 or V400 Series **Wall and Partition Design** in the UL Fire Resistance Directory and shall include the following construction features:
 - A. **Ceiling Deflection Channel** – U-shaped channel formed from min 16 ga steel sized to accommodate steel studs (Item 2C) and provided with 5 in. (127 mm) flanges. Deflection channel installed parallel with and aligned with web of purlin and secured to bottom flange of purlin with min No. 14 self-tapping, hex-head, plated steel or stainless steel screws spaced max 24 in. (610 mm) OC.
 - B. **Steel Floor and Ceiling Runners** – Floor runner of the wall assembly and the floor and ceiling runners of the cripple wall above the wall assembly shall consist of min 1-1/4 in. (32 mm) deep min 25 ga galv steel channels sized to accommodate steel studs (Item 2C). Floor runner of cripple wall aligned with and resting atop flange of purlin. Ceiling runner of cripple wall installed to compress insulation (Item 1C) to min thickness of 3/8 in. (10 mm) by wedging lengths of stud (Item 2C) between the runners. Steel studs of cripple wall attached to web of purlin with steel screws driven through opposite side of purlin web.
 - C. **Studs** – Steel studs to be min 3-1/2 in. (89 mm) wide. Studs cut max 2 in. (51 mm) less in length than assembly height with bottom nesting in and resting on the floor runner and with top nesting in ceiling deflection channel without attachment. Width of stud to be equal to or greater than width of purlin flange. Stud spacing not to exceed 24 in. (610 mm) O.C. Studs of cripple wall cut to length as required to compress insulation (Item 1C) to min thickness of 3/8 in. (10 mm) and spaced max 24 in. (610 mm) OC.

Construction Joints

Head of Wall

HWD

System No. HW-D-0488 *continued*

Construction Joints

- D. **Gypsum Board*** – Min 5/8 in. (16 mm) thick gypsum board sheets installed on each side of wall. Wall to be constructed as specified in the individual U400 or V400 Series Design in the UL Fire Resistance Directory except that a max 2 in. wide gap shall be maintained between the gypsum board of the wall assembly below the purlin and the gypsum board of the cripple wall. Top edge of gypsum board of wall assembly to be max 2 in. (51 mm) below top of ceiling deflection channel. Bottom edge of gypsum board of cripple wall to be flush with top of ceiling deflection channel. Screws securing gypsum board to steel studs of wall assembly to be located 2-1/4 in. to 2-1/2 in. (57 to 64 mm) below flange of ceiling deflection channel. Screws securing gypsum board of cripple wall to be driven into web of purlin and into studs and runners of cripple wall. No screws are to be driven into flanges of ceiling deflection channel.
- E. **Gypsum Board*** – Min 5/8 in. (16 mm) thick “rip strip” of gypsum board installed to cover first layer of gypsum board on cripple wall and to lap min 3 in. (76 mm) onto gypsum board of wall assembly on each side of wall. The “rip strip” of gypsum board is to be the same material used for the wall assembly and is to be secured to the web of purlin and into studs and runners of the cripple wall. No screws are to be driven into flanges of ceiling deflection channel. Joints of “rip strip” to be offset from joints of gypsum board on wall assembly.

Max separation between top of wall assembly gypsum board and bottom of cripple wall gypsum board (at time of installation of joint system) is 2 in. (51 mm). The joint system is designed to accommodate a max 100 percent compression or extension from its installed width.

- 3. **Fill, Void or Cavity Material* – Caulk** – Min 5/8 in. (16 mm) thickness of fill material installed to fill any gap between top of cripple wall gypsum board and insulation (Item 1C) or purlin flange on each side of the wall.

3M COMPANY

3M FIRE PROTECTION PRODUCTS – CP 25WB+ caulk

*Bearing the UL Classification Mark

Reprinted from the Online Certifications Directory with permission from Underwriters Laboratories Inc.
Copyright © 2010 Underwriters Laboratories Inc.®



Head of Wall

HW-D

System No. HW-D-0489

February 11, 2008

Assembly Rating – 1 Hr

Nominal Joint Width – 2 in.

Class II Movement Capabilities – 100% Compression and Extension

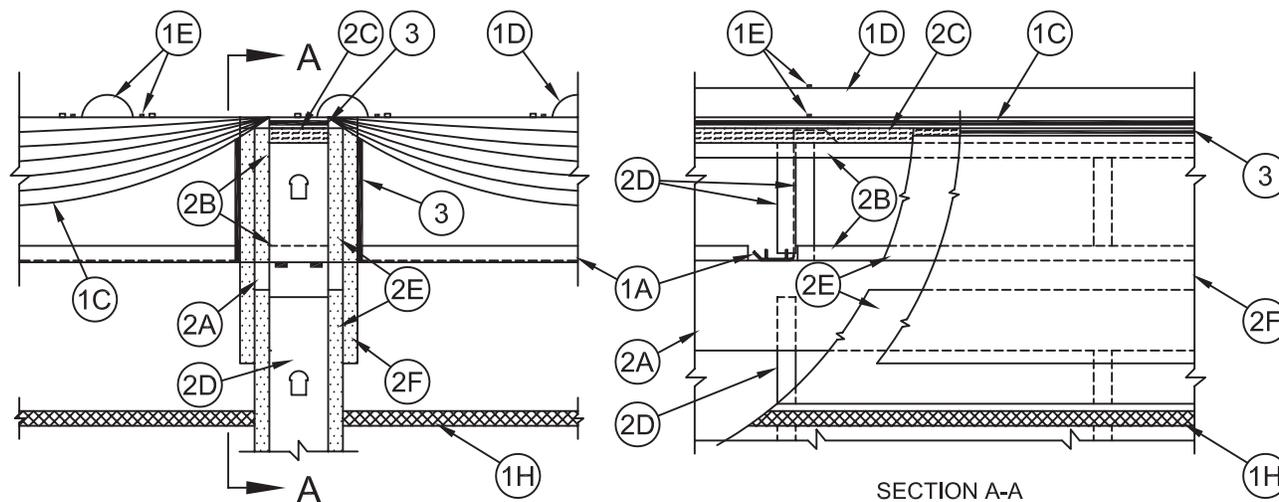

- 1. Roof-Ceiling Assembly** – The fire rated roof-ceiling assembly shall be constructed of the materials and in the manner described in the individual P200 or P500 Series **Roof-Ceiling Designs** in the UL Fire Resistance Directory and shall include the following construction features:
 - A. Purlin** – Min 16 ga coated steel. Max spacing as specified in the individual **Roof-Ceiling Design**.
 - B. Lateral Bracing** – (Not Shown) – As required.
 - C. Batts and Blankets* – Insulation** – Any faced compressible glass-fiber blanket insulation having a min 6 in. (152 mm) thickness before compression and a min density of 0.6 pcf (9.6 kg/m³). Insulation draped over purlins prior to installation of panel clips (Item 1F) and/or metal roof deck panels (Item 1D). Side edges of the batts shall be butted or overlapped a max of 3 in. (76 mm).
See **Batts and Blankets (BZJZ)** category in the UL Fire Resistance Directory or **Batts and Blankets (BKNV)** category in the UL Building Materials Directory for names of manufacturers.
 - D. Metal Roof Deck Panels*** – Min 26 ga coated steel. Panels continuous over two or more spans. Roof panel end laps, if required, centered over purlins with min 3 in. (76 mm) panel overlap as specified in the individual **Roof-Ceiling Design**. A line of tube sealant or tape sealant may be used at panel end and side laps.
See **Metal Roof Deck Panels (TJPV)** category in the UL Roofing Materials and Systems Directory for names of manufacturers.
 - E. Fasteners** – Fasteners used for panel-to-purlin and panel-to-panel connections to be self-tapping, hex-head, plated steel or stainless steel screws with either an integral or a separate steel washer fitted with a compressible sealing washer. Fastener type, length, pilot hole diam and spacing to be as specified in the individual **Roof-Ceiling Design**.
 - F. Roof Deck Fasteners* – Panel Clips** – (Not Shown) – Panel clips used for panel-to-purlin connections to be secured to purlin through insulation as specified in the individual **Roof-Ceiling Design**.
See **Roof Deck Fasteners (TLSX)** category in the UL Roofing Materials and Systems Directory for names of manufacturers.
 - G. Thermal Spacer Blocks** – (Not Shown) – Expanded polystyrene strips cut to fit between panel clips (Item 1F) as specified in the individual **Roof-Ceiling Design**. Thermal spacer blocks, when used, are to be installed between insulation (Item 1C) and metal roof deck panels (Item 1D) over purlins.
 - H. Ceiling Membrane** – **The Steel Framing Members*, Acoustical Material*, Gypsum Board*** and other ceiling membrane components shall be as specified in the individual **Roof-Ceiling Design**.
- 2. Wall Assembly** – The 1 h fire-rated gypsum board/steel stud wall assembly shall be constructed of the materials and in the manner specified in the individual U400 or V400 Series **Wall and Partition Design** in the UL Fire Resistance Directory and shall include the following construction features:
 - A. Ceiling Deflection Channel** – U-shaped channel formed from min 16 ga steel sized to accommodate steel studs (Item 2D) and provided with 5 in. (127 mm) flanges. Deflection channel installed perpendicular to purlins and secured to bottom flange of purlins with min No. 14 self-tapping, hex-head, plated steel or stainless steel screws.
 - B. Steel Floor and Ceiling Runners** – Floor runner of the wall assembly and the floor and ceiling runners of the cripple wall above the wall assembly shall consist of min 1-1/4 in. (32 mm) deep min 25 ga galv steel channels sized to accommodate steel studs (Item 2D). Floor runner of cripple wall aligned with and screw-attached to top of ceiling deflection channel. Ceiling runner of cripple wall installed to compress insulation (Item 1C) to min thickness of 3/8 in. (10 mm) by wedging lengths of stud (Item 2D) between the runners. Steel studs of cripple wall attached to each side of purlin web and to floor and ceiling runners with steel screws.
 - C. Batts and Blankets* – Packing Material** – Unfaced compressible mineral wool batt insulation having a nom 2 in. (51 mm) thickness before compression and a nom density of 4 pcf (64 kg/m³). Strips of nom 2 in. (51 mm) thick batt cut to width of cripple wall ceiling runner and compressed min 50 percent in thickness between cripple wall ceiling runner and insulation (Item 1C). Compression of mineral wool batt packing material to result in compression of insulation (Item 1C) to nominal 3/8 in. (10 mm) thickness.
See **Batts and Blankets (BZJZ)** category in the UL Fire Resistance Directory or **Batts and Blankets (BKNV)** category in the UL Building Materials Directory for names of manufacturers.

System No. HW-D-0489 *continued*

Construction Joints

- D. **Studs** – Steel studs to be min 3-1/2 in. (89 mm) wide. Studs cut max 2 in. (51 mm) less in length than assembly height beneath purlins with bottom nesting in and resting on the floor runner and with top nesting in ceiling deflection channel without attachment. Stud spacing not to exceed 24 in. (610 mm) O.C. Studs of cripple wall cut to length as required to compress packing material (Item 2C) and insulation (Item 1C) to min thicknesses of 1 in. (25 mm) and 3/8 in. (10 mm), respectively. Studs spaced max 24 in. (610 mm) OC.
- E. **Gypsum Board*** – Min 5/8 in. (16 mm) thick gypsum board sheets installed on each side of wall. Wall to be constructed as specified in the individual U400 or V400 Series Design in the UL Fire Resistance Directory except that a max 2 in. wide gap shall be maintained between the gypsum board of the wall assembly below the purlin and the gypsum board of the cripple wall. Top edge of gypsum board of wall assembly to be max 2 in. (51 mm) below top of ceiling deflection channel. Bottom edge of gypsum board of cripple wall to be flush with top of ceiling deflection channel. Screws securing gypsum board to steel studs of wall assembly to be located 2-1/4 in. to 2-1/2 in. (57 to 64 mm) below flange of ceiling deflection channel. Screws securing gypsum board of cripple wall to be driven into studs and runners of cripple wall. No screws are to be driven into flanges of ceiling deflection channel.
- F. **Gypsum Board*** – Min 5/8 in. (16 mm) thick “rip strip” of gypsum board installed to cover first layer of gypsum board on cripple wall and to lap min 3 in. (76 mm) onto gypsum board of wall assembly on each side of wall. The “rip strip” of gypsum board is to be the same material used for the wall assembly and is to be secured to the studs and runners of the cripple wall. No screws are to be driven into flanges of ceiling deflection channel. Joints of “rip strip” to be offset from joints of gypsum board on wall assembly.

Max separation between top of wall assembly gypsum board and bottom of cripple wall gypsum board (at time of installation of joint system) is 2 in. (51 mm). The joint system is designed to accommodate a max 100 percent compression or extension from its installed width.

- 3. **Fill, Void or Cavity Material* – Caulk** – Min 5/8 in. (16 mm) thickness of fill material installed to fill any gap between top of cripple wall gypsum board and insulation (Item 1C) on each side of the wall. Additional caulk installed to fill annular space between purlin and gypsum board “rip strip” (Item 2F) on both sides of wall. Additional nom 1/2 in. (13 mm) diam bead of caulk to be applied around perimeter of purlin at its interface with the “rip strip” on each side of the wall.

3M COMPANY

3M FIRE PROTECTION PRODUCTS – CP 25WB+ caulk

*Bearing the UL Classification Mark

Reprinted from the Online Certifications Directory with permission from Underwriters Laboratories Inc.
Copyright © 2010 Underwriters Laboratories Inc.®



Head of Wall

HW-D

System No. HW-D-0490

February 11, 2008

Assembly Rating – 1 Hr

Nominal Joint Width – 2 in.

Class II Movement Capabilities – 100% Compression and Extension

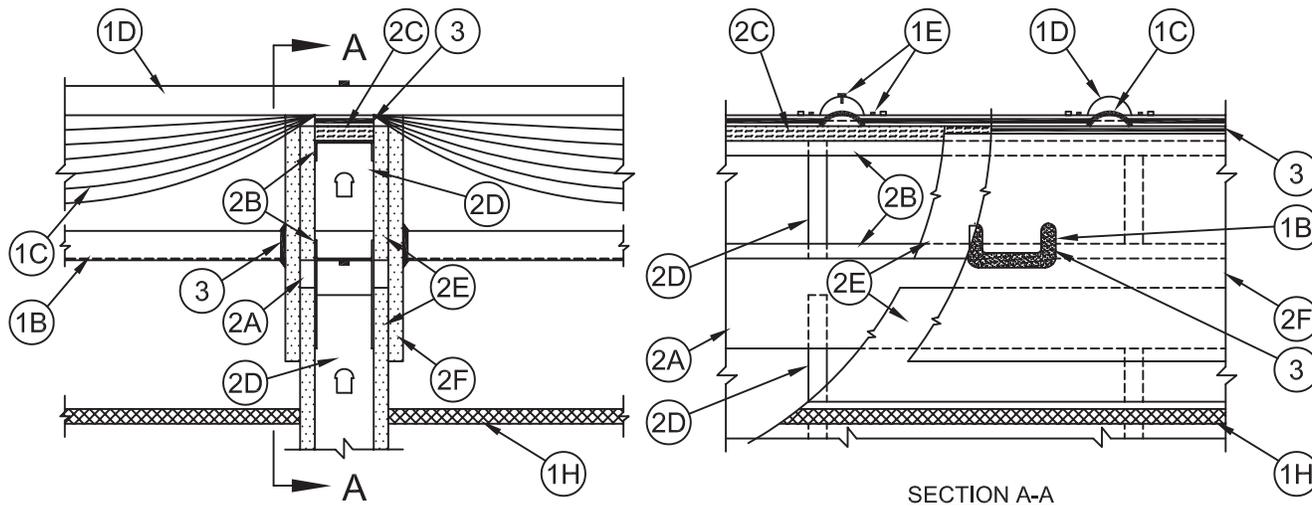

1. **Roof-Ceiling Assembly** – The fire rated roof-ceiling assembly shall be constructed of the materials and in the manner described in the individual P200 or P500 Series **Roof-Ceiling Designs** in the UL Roofing Materials and Systems Directory and shall include the following construction features:
 - A. **Purlin** – (Not Shown) – Min 16 ga coated steel. Max spacing as specified in the individual **Roof-Ceiling Design**.
 - B. **Lateral Bracing** – Min 16 ga coated steel strap, channel, angle or other structural shape installed where required for lateral support of studs. Attached to steel purlins on each side of wall assembly with welds or with min No. 14 self-tapping, hex-head, plated steel or stainless steel screws.
 - C. **Batts and Blankets*** – **Insulation** – Any faced compressible glass-fiber blanket insulation having a min 6 in. (152 mm) thickness before compression and a min density of 0.6 pcf (9.6 kg/m³). Insulation draped over purlins prior to installation of panel clips (Item 1F) and/or metal roof deck panels (Item 1D). Side edges of the batts shall be butted or overlapped a max of 3 in. (76 mm).
See **Batts and Blankets (BZJZ)** category in the UL Fire Resistance Directory or **Batts and Blankets (BKNV)** category in the UL Building Materials Directory for names of manufacturers.
 - D. **Metal Roof Deck Panels*** – Min 26 ga coated steel. Panels continuous over two or more spans. Roof panel end laps, if required, centered over purlins with min 3 in. (76 mm) panel overlap as specified in the individual **Roof-Ceiling Design**. A line of tube sealant or tape sealant may be used at panel end and side laps.
See **Metal Roof Deck Panels (TJPV)** category in the UL Roofing Materials and Systems Directory for names of manufacturers.
 - E. **Fasteners** – Fasteners used for panel-to-purlin and panel-to-panel connections to be self-tapping, hex-head, plated steel or stainless steel screws with either an integral or a separate steel washer fitted with a compressible sealing washer. Fastener type, length, pilot hole diam and spacing to be as specified in the individual **Roof-Ceiling Design**.
 - F. **Roof Deck Fasteners* – Panel Clips** – (Not Shown) - Panel clips used for panel-to-purlin connections to be secured to purlin through insulation as specified in the individual **Roof-Ceiling Design**.
See **Roof Deck Fasteners (TLSX)** category in the UL Roofing Materials and Systems Directory for names of manufacturers.
 - G. **Thermal Spacer Blocks** – (Not Shown) – Expanded polystyrene strips cut to fit between panel clips (Item 1F) as specified in the individual **Roof-Ceiling Design**. Thermal spacer blocks, when used, are to be installed between insulation (Item 1C) and metal roof deck panels (Item 1D) over purlins.
 - H. **Ceiling Membrane – The Steel Framing Members*, Acoustical Material*, Gypsum Board*** and other ceiling membrane components shall be as specified in the individual **Roof-Ceiling Design**.
2. **Wall Assembly** – The 1 h fire-rated gypsum board/steel stud wall assembly shall be constructed of the materials and in the manner specified in the individual U400 or V400 Series **Wall and Partition Design** in the UL Fire Resistance Directory and shall include the following construction features:
 - A. **Ceiling Deflection Channel** – U-shaped channel formed from min 16 ga steel sized to accommodate steel studs (Item 2D) and provided with 5 in. (127 mm) flanges. Deflection channel installed parallel with and between purlins and secured to lateral bracing (Item 1B) with min No. 14 self-tapping, hex-head, plated steel or stainless steel screws.
 - B. **Steel Floor and Ceiling Runners** – Floor runner of the wall assembly and the floor and ceiling runners of the cripple wall above the wall assembly shall consist of min 1-1/4 in. (32 mm) deep min 25 ga galv steel channels sized to accommodate steel studs (Item 2D). Floor runner of cripple wall aligned with and screw-attached to top of ceiling deflection channel. Ceiling runner of cripple wall installed to compress insulation (Item 1C) and packing material (Item 2C) to min thickness of 3/8 in. (10 mm) and 1 in. (25 mm), respectively, by wedging lengths of stud (Item 2D) between the runners. Steel studs of cripple wall attached to floor and ceiling runners with steel screws.

System No. HW-D-0490 *continued*

Construction Joints

Head of Wall

- C. **Batts and Blankets*** – **Packing Material** – Unfaced compressible mineral wool batt insulation having a nom 2 in. (51 mm) thickness before compression and a nom density of 4 pcf (64 kg/m³). Strips of nom 2 in. (51 mm) thick batt cut to width of cripple wall ceiling runner and compressed min 50 percent in thickness between cripple wall ceiling runner and insulation (Item 1C). Compression of mineral wool batt packing material to result in compression of insulation (Item 1C) to nominal 3/8 in. (10 mm) thickness. When width of metal roof deck panels (Item 1D) rib exceeds 2 in. (51 mm).

See **Batts and Blankets** (BZJZ) category in the UL Fire Resistance Directory or **Batts and Blankets** (BKNV) category in the UL Building Materials Directory for names of manufacturers.

- D. **Studs** – Steel studs to be min 3-1/2 in. (89 mm) wide. Studs cut max 2 in. (51 mm) less in length than assembly height beneath purlins with bottom nesting in and resting on the floor runner and with top nesting in ceiling deflection channel without attachment. Stud spacing not to exceed 24 in. (610 mm) O.C. Studs of cripple wall cut to length as required to compress packing material (Item 2C) and insulation (Item 1C) to min thicknesses of 1 in. (25 mm) and 3/8 in. (10 mm), respectively. Studs spaced max 24 in. (610 mm) OC.
- E. **Gypsum Board*** – Min 5/8 in. (16 mm) thick gypsum board sheets installed on each side of wall. Wall to be constructed as specified in the individual U400 or V400 Series Design in the UL Fire Resistance Directory except that a max 2 in. wide gap shall be maintained between the gypsum board of the wall assembly and the gypsum board of the cripple wall. Top edge of gypsum board of wall assembly to be max 2 in. (51 mm) below top of ceiling deflection channel. Bottom edge of cripple wall gypsum board to be flush with top of ceiling deflection channel. Screws securing gypsum board to steel studs of wall assembly to be located 2-1/4 in. to 2-1/2 in. (57 to 64 mm) below flange of ceiling deflection channel. Screws securing gypsum board of cripple wall to be driven into studs and runners of cripple wall. No screws are to be driven into flanges of ceiling deflection channel.
- F. **Gypsum Board*** – Min 5/8 in. (16 mm) thick “rip strip” of gypsum board installed to cover first layer of gypsum board on cripple wall and to lap min 3 in. (76 mm) onto gypsum board of wall assembly on each side of wall. The “rip strip” of gypsum board is to be the same material used for the wall assembly and is to be secured to the studs and runners of the cripple wall. No screws are to be driven into flanges of ceiling deflection channel. Joints of “rip strip” to be offset from joints of gypsum board on wall assembly.

Max separation between top of wall assembly gypsum board and bottom of cripple wall gypsum board (at time of installation of joint system) is 2 in. (51 mm). The joint system is designed to accommodate a max 100 percent compression or extension from its installed width.

3. **Fill, Void or Cavity Material*** – **Caulk** – Min 5/8 in. (16 mm) thickness of fill material installed to fill any gap between top of cripple wall gypsum board and insulation (Item 1C) on each side of the wall. Additional caulk installed to fill annular space between lateral bracing and gypsum board “rip strip” (Item 2F) on both sides of wall. Additional nom 1/2 in. (13 mm) diam bead of caulk to be applied around perimeter of lateral brace at its interface with the “rip strip” on each side of the wall.

3M COMPANY

3M FIRE PROTECTION PRODUCTS – CP 25WB+ caulk

*Bearing the UL Classification Mark

Reprinted from the Online Certifications Directory with permission from Underwriters Laboratories Inc.
Copyright © 2010 Underwriters Laboratories Inc.®



HW/D

System No. HW-D-0517

April 20, 2010

Assembly Ratings – 1 and 2 Hr (See Item 2)

L Rating At Ambient – 4 CFM/Lin Ft

L Rating At 400 F – 6 CFM/Lin Ft

Nominal Joint Width – 3/4 In.

Class II Movement Capability – 34% Compression Only

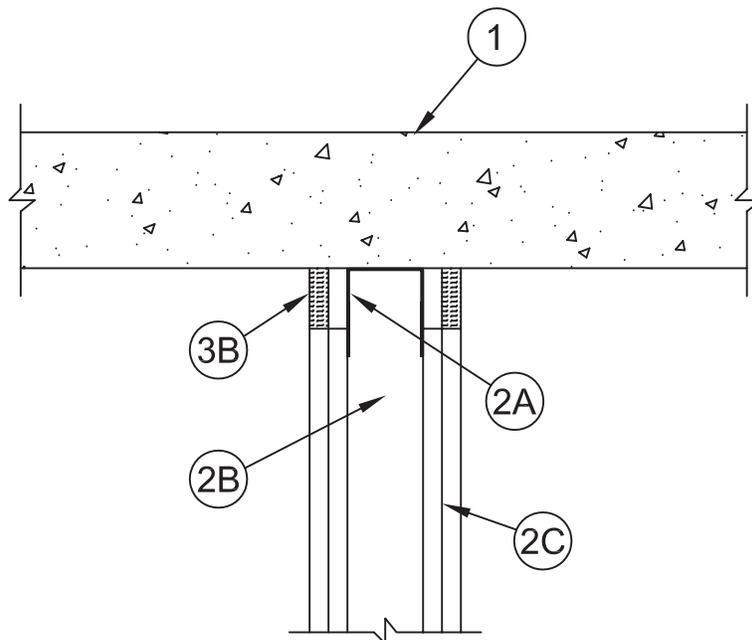

1. **Floor Assembly** – Min 4-1/2 in. (114 mm) thick lightweight or normal weight (100-150 pcf or 1600-2400 kg/m³) concrete.
2. **Wall Assembly** – The 1 or 2 hr fire rated gypsum board/steel stud wall assembly shall be constructed of the materials and in the manner described in the individual U400 or V400 Series Wall and Partition Design in the UL Fire Resistance Directory and shall include the following construction features:
 - A. **Steel Floor And Ceiling Runners** – Floor and ceiling runners of wall assembly shall consist of galv steel channels sized to accommodate steel studs (Item 2B). When U-shaped deflection channel (Item 3A) is used, ceiling runner installed within the deflection channel with 1 in. (25 mm) gap maintained between the top of ceiling runner and top of deflection channel. When deflection channel is not used, ceiling runner secured to concrete floor slab with steel masonry anchors spaced a max of 24 in. (610 mm) OC.
 - A1. **Light Gauge Framing* – Slotted Ceiling Runner** – As an alternate to the ceiling runner in Item 2A, slotted ceiling runner to consist of galv steel channel with slotted flanges sized to accommodate steel studs (Item 2B). Slotted ceiling runner secured to concrete floor slab with steel masonry anchors spaced max 24 in. (610 mm) OC. When slotted ceiling runner is used, deflection channel (Item 3A) shall not be used.

BRADY CONSTRUCTION INNOVATIONS INC,
DBA SLIPTRACK SYSTEMS – SLP-TRK
CLARKWESTERN BUILDING SYSTEMS INC – Type SLT, SLT-H
METAL-LITE INC – The System
SCAFCO STEEL STUD MANUFACTURING CO
TELLING INDUSTRIES L L C – True-Action Deflection Track
 - A2. **Light Gauge Framing* – Clipped Ceiling Runner** – As an alternate to the ceiling runner in Items 2A and 2A1, clipped runner to consist of galv steel channel with clips preformed in track flanges which positively engage the inside flange of the steel studs (Item 2B). Track sized to accommodate steel studs (Item 2B). Track flanges to be min 2-1/2 in. (64 mm). Clipped ceiling runner secured to concrete floor slab with steel masonry anchors spaced max 24 in. (610 mm) OC. When clipped ceiling runner is used, deflection channel (Item 3A) shall not be used.

TOTAL STEEL SOLUTIONS L L C – Snap Trak
 - A3. **Light Gauge Framing* – Notched Ceiling Runner** – As an alternate to the ceiling runners in Items 2A through 2A2, notched ceiling runners to consist of C-shaped galv steel channel with notched return flanges sized to accommodate steel studs (Item 2B). Notched ceiling runner secured to concrete floor slab with steel masonry anchors spaced max 24 in. (610 mm) OC. When notched ceiling runner is used, deflection channel (Item 3A) shall not be used.

OLMAR SUPPLY INC – Type SCR
 - B. **Studs** – Steel studs to be min 3-5/8 in. (92 mm) wide. Studs cut 1/2 to 3/4 in. (13 to 19 mm) less in length than assembly height. Studs attached to ceiling runner with sheet metal screws a min of 1/2 in. (13 mm) below bottom of deflection channel, when deflection channel is used. When deflection channel is not used, steel studs shall not be secured to ceiling runner. When slotted ceiling runner (Item 2A1) is used, steel studs secured to slotted ceiling runner with No. 8 by 1/2 in. (13 mm) long wafer head steel screws at midheight of slot on each side of wall. Stud spacing not to exceed 24 in. (610 mm) OC.

Construction Joints

Head of Wall

HW-D

System No. HW-D-0517 *continued*

- C. **Gypsum Board*** – Gypsum board sheets installed to a min total thickness of 5/8 in. (16 mm) and 1-1/4 in. (32 mm) on each side of wall for 1 and 2 hr rated assemblies, respectively. Wall to be constructed as specified in the individual Wall and Partition Design in the UL Fire Resistance Directory, except that a nom 3/4 in. (19 mm) gap shall be maintained between the top of the gypsum board and the lower surface of the floor. The screws attaching the gypsum board to studs at the top of the wall shall be located 1 in. (25 mm) below the bottom of the U-shaped deflection channel (Item 3A) or slotted ceiling runner (Item 2A1).

The hourly fire rating of the joint system is equal to the hourly fire rating of the wall.

3. **Joint System** – Max separation between bottom of floor and top of wall is 3/4 in. (19 mm). The joint system is designed to accommodate a max 34 percent compression from its installed width. The joint system consists of a deflection channel forming material and a fill material, as follows:
- A. **Deflection Channel** – (Optional, Not Shown) – Nom 3-3/4 in. (95 mm) wide by min 2 in. (51 mm) deep min 24 ga steel U-shaped channel. Deflection channel secured to concrete floor slab with steel masonry anchors or by welds spaced max 24 in. (610 mm) OC. The ceiling runner (Item 2A) is installed within the deflection channel to maintain a 1 in. (25 mm) gap between the top of the ceiling runner and the top of the deflection channel. The ceiling runner is not fastened to the deflection channel.
- B. **Fill, Void or Cavity Material* – Caulk** – Min 5/8 in. (16 mm) thickness of fill material installed on each side of the wall between the top of the gypsum board and bottom of floor, flush with each surface of gypsum board.

3M COMPANY

3M FIRE PROTECTION PRODUCTS – FD-150+

*Bearing the UL Classification Mark

Reprinted from the Online Certifications Directory with permission from Underwriters Laboratories Inc.
Copyright © 2010 Underwriters Laboratories Inc.®



Construction Joints

Head of Wall

HW-D

UL System No. HW-D-0552

February 13, 2017

ANSI/UL2079

Assembly Rating – 2 Hr
 Nominal Joint Width – 3/4 in.
 Class II Movement Capabilities – 19% Compression or Extension

CAN/ULC S115

F Rating – 2 Hr
 FT Rating – 2 Hr
 FH Rating – 2 Hr
 FTH Rating – 2 Hr
 Nominal Joint Width – 19 mm
 Class II Movement Capabilities – 19% Compression or Extension

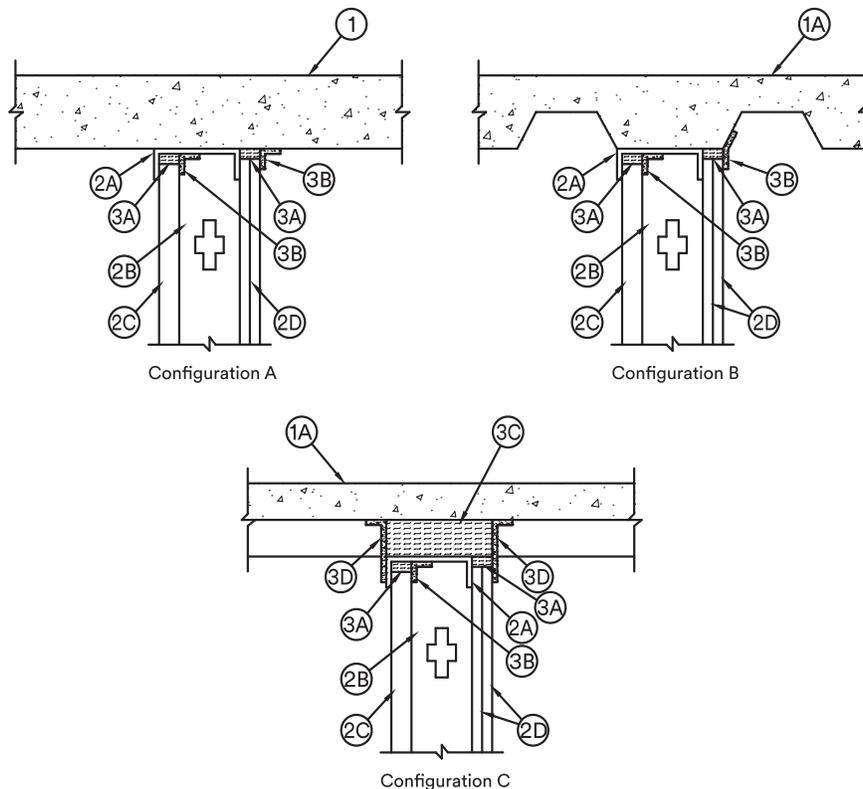

1. **Floor Assembly** – Min 4-1/2 in. (114 mm) thick reinforced lightweight or normal weight (100-150 pcf or 1600-2400 kg/m³) structural concrete. Floor may also be constructed of any UL Classified hollow-core **Precast Concrete Units***.
 See **Precast Concrete Units** (CFTV) in Fire Resistance Directory for names of manufacturers.
- 1A. **Floor Assembly** – The fire-rated fluted steel deck/concrete floor assembly shall be constructed of the materials and in the manner described in the individual D900 Series Floor-Ceiling Design in the UL Fire Resistance Directory and shall include the following construction features:
 - A. **Steel Floor And Form Units*** – Max 3 in. (76 mm) deep galv steel fluted floor units.
 - B. **Concrete** – Min 2-1/2 in. (64 mm) thick reinforced concrete, as measured from the top plane of the floor units.
2. **Shaft Wall Assembly** – The 2 hr fire rated shaft wall assembly shall be constructed of the materials and in the manner described in the individual U400 or V400-Series Wall and Partition Design in the UL Fire Resistance Directory and shall include the following construction features:
 - A. **Steel Floor And Ceiling Runners** – Floor and ceiling runners of wall assembly shall consist of galv steel channels sized to accommodate steel “C-H” studs. Flange height of ceiling runner shall be min 1/2 in. (13 mm) greater than nom joint width. Ceiling runner secured with steel masonry anchors spaced max 24 in. (610 mm) OC.
 - B. **Steel Studs** – “C-H”-shaped steel studs to be min 2-1/2 in. (64 mm) wide and formed of min 24 MSG galv steel. Studs cut 1/2 to 3/4 in. (13 to 19 mm) less in length than assembly height with bottom nesting in and resting on floor runner and with top nesting in ceiling runner or slotted ceiling track. Studs spaced 24 in. (610 mm) OC. After installation of gypsum board liner panels (Item 2D), studs secured to flange of floor runner on finished side of wall only with No. 6 by 1/2 in. (13 mm) long self-drilling, self-tapping steel screws. Studs secured to flange of slotted ceiling track on finished side of wall only with No. 8 by 1/2 in. (13 mm) long self-drilling, self-tapping wafer head steel screws at slot mid height.
 - C. **Gypsum Board*** – 1 in. (25 mm) thick by 24 in. (610 mm) wide gypsum board liner panels. Panels cut 1 in. (25mm) less in length than floor to ceiling height. Vertical edges inserted in “H”-shaped section of “C-H” studs. Free edge of end panels attached to long leg of “J” runner (Item 2A) with 1-5/8 in. (41 mm) long Type S steel screws spaced max 12 in. (305 mm) OC.
 - D. **Gypsum Board*** – Gypsum board sheets, 1/2 or 5/8 in. (13 or 16 mm) thick, applied vertically or horizontally in two layers on finished side of wall as specified in the individual U400 or V400-Series Wall and Partition Design. A max 1 in. (25 mm) gap shall be maintained between the top of the gypsum board and the bottom surface of the concrete floor. The screws attaching the gypsum board layers to the C-H studs shall be located 1 in. (25 mm) below the bottom of the slotted ceiling track (Item 2C). No gypsum board attachment screws are to penetrate the slotted ceiling track.

Construction Joints

Head of Wall

HWD

3. Joint System – Max separation between bottom of floor and top of liner panel (Item 2D) and between bottom of floor and top of gypsum board sheets (Item 2E) at time of installation of joint system is 3/4 in. (19 mm). The joint system is designed to accommodate a maximum 19 percent compression or extension from its installed width. The joint system consists of the following:

Configuration A, B, and C

- A. Forming Material*** – Min 4 pcf (64 kg/m³) density mineral wool batt insulation cut to a thickness equal to the overall thickness of the gypsum board and shaft liner and compressed 50 percent in height and inserted between the top of the gypsum board and bottom of floor on both sides of the wall.
- B. Fill, Void or Cavity Material* – Sealant** – Prior to the installation of the gypsum board (Item 2D), a min 1/16 in. (1.6 mm) dry thickness (min 1/8 in. or 3.2 mm wet thickness) of fill material sprayed or brushed on inside of ceiling runner to completely cover mineral wool and overlap a min of 1/2 in. (13 mm) onto shaft liner (Item 2C) and runner (Item 2A). After installation of gypsum board (Item 2D) min 1/16 in. (1.6 mm) dry thickness (min 1/8 in. or 3.2 mm wet thickness) of fill material sprayed or brushed on gypsum board on the wall to completely cover mineral wool and overlap a min of 1/2 in. (13 mm) onto wall and floor

3M COMPANY

3M FIRE PROTECTION PRODUCTS – FireDam Spray 200

- B1. Fill, Void or Cavity Material* – Tape** – Alternate to Item B. Prior to the installation of the gypsum board (Item 2D), Tape cut to size and press applied on inside of ceiling runner to completely cover mineral wool and overlap a min of 1 in. (25 mm) onto shaft liner (Item 2C) and runner (Item 2A). After installation of gypsum board (Item 2D) , Tape cut to size and press applied over the mineral wool forming material and lapping min 1 in. (25 mm) onto the steel floor units and gypsum wall. Tape applied in minimum 1 ft (305 mm) lengths along joint and adjoining lengths of Tape shall overlap min 1/2 in. (13 mm).

3M COMPANY – 3M Fire and Water Barrier Tape

Configuration C Only

- C. Forming Material*** – Min 4 in. (102 mm) thickness of min 4 pcf (64 kg/m³) density mineral wool batt insulation cut to the shape of the fluted deck, approx 20 percent larger than the area of the flutes and compressed into flutes of the steel floor deck between the top of the ceiling runner and the steel deck.
- D. Fill, Void or Cavity Material*** – Min 1/16 in. (1.6 mm) dry (1/8 in. or 3.2 mm wet) thickness of fill material sprayed or brushed on each side of the wall in the flutes of the steel floor units and between the bottom edge of the ceiling runner or top of the gypsum board, and the bottom of the steel floor to completely cover mineral wool and overlap a min of 1/2 in. (13 mm) on to gypsum board, ceiling runner and steel floor deck on both sides of wall.

3M COMPANY

3M FIRE PROTECTION PRODUCTS – FireDam™ Spray 200

- D1. Fill, Void or Cavity Material* – Tape** – As an alternate to Item D, Tape cut to size and press applied within fluted areas of joint to completely cover mineral wool lapping min 1 in. (25 mm) onto the contour of the steel floor units and extending to lap min 1 in. (25 mm) onto the gypsum wall (finished side of wall) and ceiling runner (shaft side of wall). Adjoining lengths of Tape shall overlap min 1/2 in. (13 mm). Tape shall be applied at both sides of wall.

3M COMPANY – 3M Fire and Water Barrier Tape

*Indicates such products shall bear the UL or cUL Certification Mark for jurisdictions employing the UL or cUL Certification (such as Canada), respectively. 

Reprinted from the Online Certifications Directory with permission from UL©

UL System No. HW-D-0575

January 17, 2017

ANSI/UL2079

Assembly Rating – 2 Hr
Nominal Joint Width – 2 in.

Class II Movement Capabilities – 13% Compression or Extension
L Rating At Ambient – Less Than 1 CFM/Lin Ft
L Rating At 400°F – Less Than 1 CFM/Lin Ft

CAN/ULC S115

F Rating – 2 Hr
FT Rating – 2 Hr
FH Rating – 2 Hr
FTH Rating – 2 Hr

Nominal Joint Width – 51 mm

Class II Movement Capabilities – 13% Compression or Extension
L Rating at Ambient – Less than 1.55 L/s/lin m
L Rating at 204°C – Less than 1.55 L/s/lin m

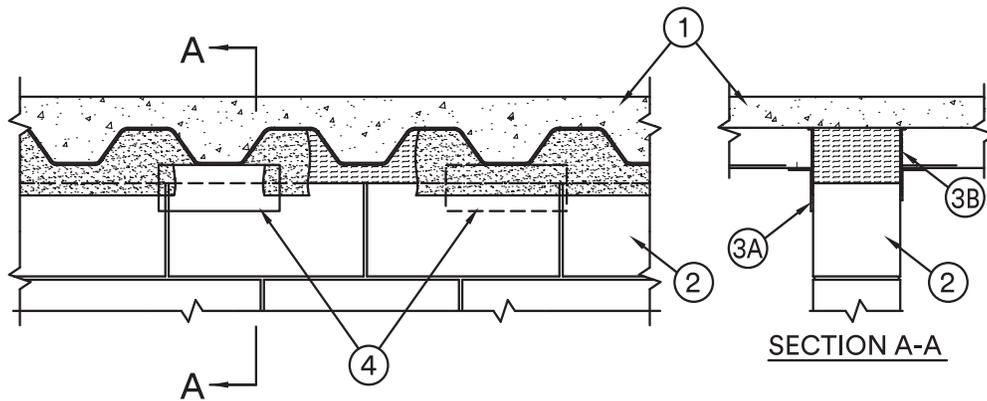

- 1. Floor Assembly** – The fire rated fluted steel floor unit/concrete floor assembly shall be constructed of the materials and in a manner described in the individual D900 Floor-Ceiling Design in the UL Fire Resistance Directory and shall include the following construction features:

A. Steel Floor And Form Units* – Max 3 in. (76 mm) deep galv steel fluted floor units.

B. Concrete – Min 2-1/2 in. (64 mm) thick reinforced concrete, as measured from the top plane of the floor units.

- 2. Wall Assembly** – Min 7-1/2 in. (191 mm) thick reinforced lightweight or normal weight (100-150 pcf or 1600-2400 kg/m³) structural concrete. Wall may also be constructed of any UL Classified **Concrete Blocks***.

See **Concrete Blocks** (CAZT) category in the Fire Resistance Directory for names of manufacturers.

- 3. Joint System** – Max width of joint (at time of installation of joint system) is 2 in. (51 mm). The joint system is designed to be installed from only one side of the wall due to the opposite side of the wall being inaccessible. The joint system is designed to accommodate a max 13 percent compression or extension from its installed width. The joint system shall consist of the following:

A. Forming Material* – Min 4 pcf (64 kg/m³) mineral wool batt insulation cut into strips, compressed approximately 25 percent in thickness, and installed to fill the max 2 in. (51 mm) gap between the top of the wall and the bottom of the fluted steel floor units. Additional pieces of min 4 pcf (64 kg/m³) mineral wool batt insulation cut to the shape of the fluted deck, approximately 20 percent larger than the area of the flutes, firmly packed into the flutes.

ROCK WOOL MANUFACTURING CO – Delta Board or Delta-8

ROCKWOOL MALAYSIA SDN BHD – SAFE

ROXUL INC – SAFE

B. Fill, Void or Cavity Material* – Sealant – Min 1/16 in. (1.6 mm) dry thickness (min 1/8 in. or 3.2 mm wet thickness) of fill material sprayed or brushed on each side of the wall between the top of the wall and the bottom of the floor to completely cover mineral wool and overlap a min of 1/2 in. (13 mm) onto wall, and min of 1 in. (25 mm) onto the steel floor unit, on both sides of wall.

3M COMPANY

3M FIRE PROTECTION PRODUCTS – FireDam™ Spray 200

B1. Fill, Void or Cavity Material* – Tape – As an alternate to Item B, Tape cut to size and press applied within fluted areas of joint to completely cover mineral wool lapping min 1 in. (25 mm) onto the contour of the steel floor units and extending to lap min 1 in. (25 mm) onto the concrete block wall. Additional pieces of Tape are applied along the joint to completely cover the remaining mineral wool between bottom of steel deck and top edge of wall along length of joint, lapping min 1 in. (25 mm) onto the contour of the steel floor units and min 1 in. (25 mm) onto the concrete block wall. Adjoining lengths of Tape shall overlap min 1/2 in. (13 mm). Tape shall be applied at both sides of wall.

3M COMPANY – 3M Fire and Water Barrier Tape

- 4. Steel Angles** (optional) – Nom 5 × 3 in. (127 × 76 mm) (or larger) by 12 MSG (or heavier) steel angles. Nom 3 in. (76 mm) leg secured to ceiling, on both sides of wall, with steel fasteners. Angles can consist of intermittent or continuous lengths. Intermittent lengths can be random or evenly spaced.

*Indicates such products shall bear the UL or cUL Certification Mark for jurisdictions employing the UL or cUL Certification (such as Canada), respectively. 

Reprinted from the Online Certifications Directory with permission from UL©

Construction Joints

Head of Wall

HWD

UL System No. HW-D-0604

December 14, 2016

ANSI/UL2079

Assembly Ratings – 1, 2, 3 and 4 Hr (See Item 2)
 Nominal Joint Width – 2 in.
 Class II Movement Capabilities – 50% Compression or Extension

CAN/ULC S115

F Ratings – 1, 2, 3 and 4 Hr (See Item 2)
 FT Ratings – 1, 2, 3 and 4 Hr (See Item 2)
 FH Ratings – 1, 2, 3 and 4 Hr (See Item 2)
 FTH Ratings – 1, 2, 3 and 4 Hr (See Item 2)
 Nominal Joint Width – 51 mm
 Class II Movement Capabilities – 50% Compression or Extension

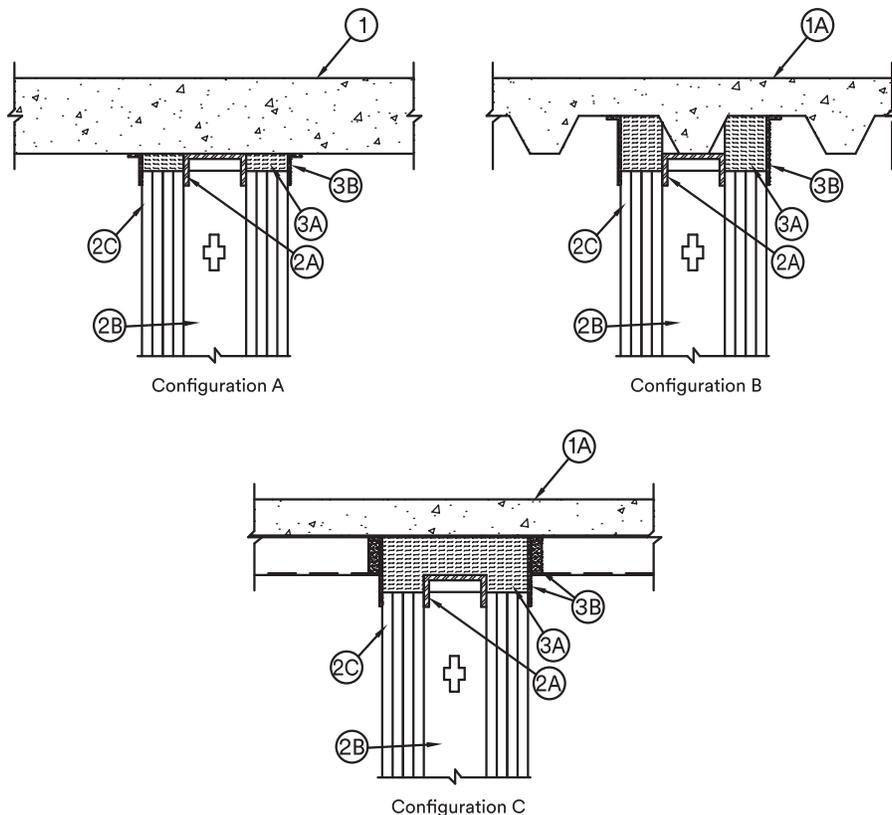

1. Floor Assembly – Min 4-1/2 in. (114 mm) thick reinforced lightweight or normal weight (100-150 pcf or 1600-2400 kg/m³) structural concrete. Floor may also be constructed of any UL Classified hollow-core **Precast Concrete Units***.

See **Precast Concrete Units** (CFTV) in Fire Resistance Directory for names of manufacturers.

1A. Floor Assembly – The fire-rated fluted steel deck/concrete floor assembly shall be constructed of the materials and in the manner described in the individual D900 Series Floor-Ceiling Design in the UL Fire Resistance Directory and shall include the following construction features:

- A. Steel Floor And Form Units*** – Max 3 in. (76 mm) deep galv steel fluted floor units.
- B. Concrete** – Min 2-1/2 in. (64 mm) thick reinforced concrete, as measured from the top plane of the floor units.

2. Wall Assembly – The 1, 2, 3 or 4 hr fire-rated gypsum board/stud wall assembly shall be constructed of the materials and in the manner described in the individual U400 or V400 Series Wall and Partition Design in the UL Fire Resistance Directory and shall include the following construction features:

- A. Steel Floor and Ceiling Runners** – Floor and ceiling runners of wall assembly shall consist of min No. 25 gauge galv steel channels sized to accommodate steel studs (Item 2B). Ceiling runner flange height to be min 1/2 in. (13 mm) greater than joint width at max anticipated extension. Ceiling runner secured with steel masonry anchors or welds spaced max 24 in. (610 mm) OC. Ceiling runner secured directly to bottom of floor for Configuration A. Ceiling runner secured parallel to and centered with flute as shown in Configuration B. For Configuration C, ceiling runner secured perpendicular to steel deck flutes.
- B. Studs** – Steel studs to be min 3-5/8 in. (92 mm) wide. Studs cut max 1-1/4 in. (32 mm) less in length than assembly height to accommodate max anticipated compression of joint width with bottom nesting in and resting on floor runner and with top nesting in ceiling runner without attachment. Stud spacing not to exceed 24 in. (610 mm) OC.
- C. Gypsum Board*** – Gypsum board sheets installed to a min total thickness of 5/8 in., 1-1/4 in., 1-7/8 in., or 2-1/2 in. (16, 32, 48 or 64 mm) on each side of wall for 1, 2, 3 and 4 hr fire rated wall assemblies, respectively. Wall to be constructed as specified in the individual U400 Series Design in the UL Fire Resistance Directory, except that a max 2 in. (51 mm) gap shall be maintained between the top of the gypsum board and the bottom surface of the floor. The screws securing successive layers of gypsum board shall be staggered min 1 in. (25 mm) from screws in preceding layer(s). Top row of screws in face layer of gypsum board shall be installed into the studs 1-1/2 in. (38 mm) below flange of ceiling runner.

The hourly fire rating of the joint system is equal to the hourly fire rating of the wall.

- 3. Joint System** – Max separation between bottom of floor and top of gypsum board sheets at time of installation of joint system is 2 in. (51 mm). The joint system is designed to accommodate a maximum 50 percent compression or extension from its installed width. The joint system consists of the following:

Configurations A and B

- A. Forming Material*** – Min 4 pcf (64 kg/m³) density mineral wool batt insulation cut to a width equal to the overall thickness of the gypsum board and with a thickness equal to twice the height of the gap between the top of the gypsum board and the bottom of the floor. Insulation compressed 50 percent in thickness and inserted between the top of the gypsum board and the bottom of the floor on both sides of the wall.

INDUSTRIAL INSULATION GROUP LLC – MinWool-1200 Safing

JOHNS MANVILLE – Safing

ROCK WOOL MANUFACTURING CO – Delta Board

ROCKWOOL MALAYSIA SDN BHD – Type Safe

ROXUL INC – Type Safe

- B. Fill, Void or Cavity Material*** – Min 1/16 in. (1.6 mm) dry thickness (1/8 in. or 3.2 mm wet thickness) of fill material sprayed or brushed to completely cover forming material and to overlap a min of 1/2 in. (13 mm) on to gypsum board and concrete or steel floor deck on both sides of wall.

3M COMPANY

3M FIRE PROTECTION PRODUCTS – FireDam™ Spray 200

- B1. Fill, Void or Cavity Material* – Tape** – As an alternate to Item B, Tape cut to size and press applied over the mineral wool forming material and lapping min 1 in. (25 mm) onto the steel floor units or concrete floor and concrete wall. Tape applied in minimum 1 ft (305 mm) lengths along joint and adjoining lengths of Tape shall overlap min 1/2 in. (13 mm). Tape shall be applied at both sides of wall.

3M COMPANY – 3M Fire and Water Barrier Tape

Configuration C

- A. Forming Material*** – Nom 4 pcf (64 kg/m³) mineral wool batt cut to the shape of the steel deck flute with a height 1 in. (25 mm) greater than the height of flutes and with a length equal to the overall thickness of the wall assembly. Mineral wool batt compressed and installed into each flute above the ceiling runner with its projecting ends flush with the wall surfaces. Additional pieces of min 4 pcf (64 kg/m³) density mineral wool batt cut to a width equal to the overall thickness of the gypsum board and with a thickness equal to twice the height of the gap between the top of the gypsum board and the valleys of the steel deck floor. Insulation compressed 50 percent in thickness and inserted between the top of the gypsum board and the bottom of the floor on both sides of the wall.

INDUSTRIAL INSULATION GROUP LLC – MinWool-1200 Safing

JOHNS MANVILLE – Safing

ROCK WOOL MANUFACTURING CO – Delta Board

ROCKWOOL MALAYSIA SDN BHD – Type Safe

ROXUL INC – Type Safe

- B. Fill, Void or Cavity Material*** – Min 1/16 in. (1.6 mm) dry thickness (1/8 in. or 3.2 mm wet thickness) of fill material sprayed or brushed to completely cover forming material and to overlap a min of 1/2 in. (13 mm) on to gypsum board and steel deck on both sides of wall.

3M COMPANY

3M FIRE PROTECTION PRODUCTS – FireDam™ Spray 200

- B1. Fill, Void or Cavity Material* – Tape** – As an alternate to Item B, Tape cut to size and press applied within fluted areas of joint to completely cover mineral wool lapping min 1 in. (25 mm) onto the contour of the steel floor units or concrete floor and extending to lap min 1 in. (25 mm) onto the gypsum wall. Adjoining lengths of Tape shall overlap min 1/2 in. (13 mm). Tape shall be applied at both sides of wall.

3M COMPANY – 3M Fire and Water Barrier Tape

*Indicates such products shall bear the UL or cUL Certification Mark for jurisdictions employing the UL or cUL Certification (such as Canada), respectively. 

Reprinted from the Online Certifications Directory with permission from UL©



UL System No. HW-D-0633
XHBN - Joint Systems
XHBN7 - Joint Systems Certified for Canada

November 08, 2017

| ANSI/UL2079 | CAN/ULC S115 |
|--|--|
| Assembly Ratings — 1 and 2 Hr (See Item 2) | F Ratings — 1 and 2 Hr (See Item 2) |
| Nominal Joint Width - 1 In. | FT Ratings — 1 and 2 Hr (See Item 2) |
| | FH Ratings — 1 and 2 Hr (See Item 2) |
| | FTH Ratings — 1 and 2 Hr (See Item 2) |
| | Nominal Joint Width - 25 mm |
| Class II or III Movement Capabilities — 25% Compression or Extension | Class II or III Movement Capabilities — 25% Compression or Extension |
| L Rating at Ambient — Less than 1 CFM/Lin Ft | L Rating at Ambient — Less than 1.55 L/s/m |
| L Rating at 400°F — Less than 1 CFM/Lin Ft | L Rating at 400°F — Less than 1.55 L/s/m |

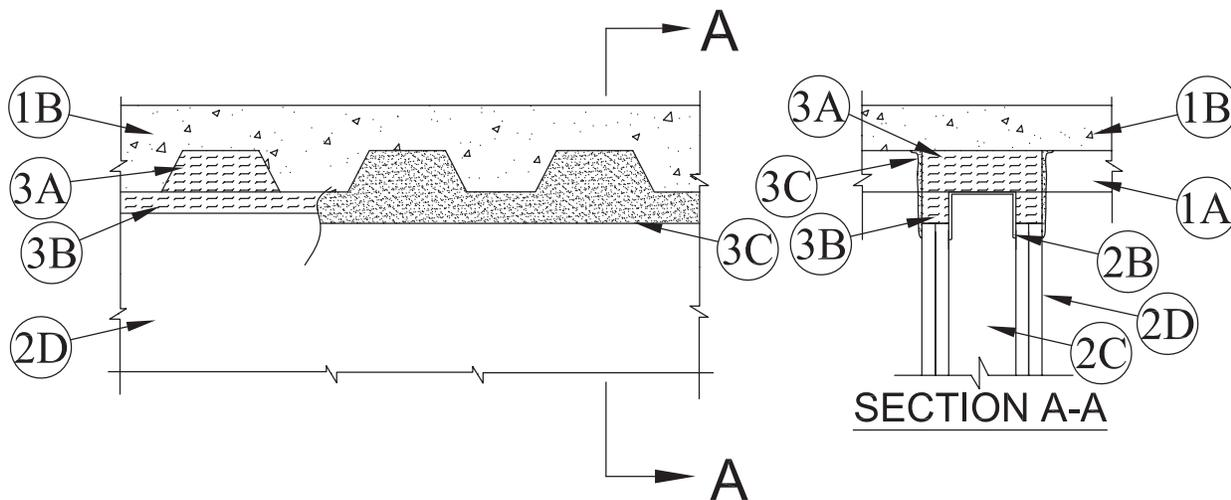

1. Floor Assembly – The fire-rated fluted steel deck/concrete floor assembly shall be constructed of the materials and in the manner described in the individual D900 Floor-Ceiling Design in the UL Fire Resistance Directory. The hourly fire rating of the floor assembly shall be equal to or greater than the hourly fire rating of the wall assembly. The floor assembly shall include the following construction features:

- A. Steel Floor and Form Units*** – Max 3 in. (76 mm) deep galv fluted floor units.
- B. Concrete** – Min 2-1/2 in. (64 mm) thick reinforced (100-150 pcf or 1600-2400 kg/m³) concrete, as measured from the top plane of the floor units.

1A. Roof Assembly – As an alternate to Item 1, the fire-rated roof assembly shall be constructed of the materials and in the manner described in the individual P900 Series Roof-Ceiling Designs in the UL Fire Resistance Directory and shall contain max 3 in. (76 mm) deep galv steel fluted roof units. The hourly fire rating of the roof assembly shall be equal to or greater than the hourly fire rating of the wall assembly.

2. Wall Assembly – The 1 hr or 2 fire rated gypsum board/steel stud wall assembly shall be constructed of the materials and in the manner described in the individual U400, V400 or W400 Series Wall and Partition Designs in the UL Fire Resistance Directory and shall include the following construction features:

- A. Steel Floor Runners** – Floor runners of wall assembly shall consist of galv steel channels sized to accommodate steel studs (Item 2C).
- B. Light Gauge Framing*** - Slotted Ceiling Runner – Slotted ceiling runner to consist of galv steel channel with slotted flanges sized to accommodate steel studs (Item 2C). Slotted ceiling runner installed perpendicular to direction of fluted steel deck secured to valleys (Configuration A) or parallel to direction of fluted deck secured to valleys or corrugated steel straps (Configuration B and C) with typical steel fasteners or welds spaced max 24 in. (610 mm).

SAFTI SEAL INC – STW or STX

MRI STEEL FRAMING LLC – Smart Slotted Track

SUPER STUD BUILDING PRODUCTS – Slotted Track

UL System No. HW-D-0633 (cont.)

- C. Studs** – Steel studs to be min 3-1/2 in. (89 mm) wide. Studs cut 1/2 to 3/4 in. (13 to 19 mm) less in length than assembly height with bottom nesting in and resting on floor runner and with top nesting in ceiling runner (Item 2B) steel studs secured to slotted ceiling runner with No. 8 by 1/2 in. (13 mm) long wafer head steel screws at mid-height of slot on min. one side of wall. Stud spacing not to exceed 24 in. (610 mm) OC.
- D. Gypsum Board*** – Gypsum board sheets installed to a min total thickness of 5/8 in. (16 mm) and 1-1/4 in. (32 mm) on each side of wall for 1 and 2 hr rated assemblies, respectively. Wall to be constructed as specified in the individual Wall and Partition Design in the UL Fire Resistance Directory, except that a nom 1 in. (25 mm) gap shall be maintained between the top of the gypsum board and the bottom of the steel floor units and the top row of screws shall be installed into the studs a min. 4 in. (102 mm) below the lower surface of the floor. The hourly fire rating of the joint system is equal to the hourly fire rating of the wall.
- 3. Joint System** – Max separation between bottom flange of the deflection track and top of wallboard (at the time of installation of the joint system) is 1 in. (25 mm). The joint system is designed to accommodate a max 25 percent compression or extension from its installed width. The joint system consists of:
- A. Forming Material*** – Min 4 pcf (64 kg/m³) density mineral wool batt insulation cut approx 33 percent wider than the flutes, approx 33 percent thicker than the depth of the steel deck, and with a length equal to the overall width of the wall. Mineral wool compressed and inserted into flutes of the steel floor units between top of ceiling runner and the steel deck.
- INDUSTRIAL INSULATION GROUP L L C** – MinWool-1200 Safing
- JOHNS MANVILLE** – Safing
- ROCK WOOL MANUFACTURING CO** – Delta Board or Delta-8
- ROCKWOOL** – Type Safe
- THERMAFIBER INC** – Type SAF
- A1. Forming Material* – Plugs** – As an alternate to Item 3A, preformed mineral wool plugs, formed to the shape of the fluted floor units, friction fit to completely fill the flutes above the ceiling runner. The plugs shall project beyond the finished side of the ceiling runner, flush with wall surface.
- ROCK WOOL MANUFACTURING CO** – Delta Deck Plugs
- B. Forming Material*** – Min 4 pcf (64 kg/m³) density mineral wool batt insulation cut to a thickness twice larger than the distance between the top of the gypsum board and the bottom of the steel floor unit. Material compressed 50 percent and installed within ceiling runner above top of liner panel flush with the inside surface of the panel. Material compressed and installed on finished side of the wall between the top of the gypsum board and the bottom of the steel floor units, flush with the surface of the wall.
- INDUSTRIAL INSULATION GROUP L L C** – MinWool-1200 Safing
- JOHNS MANVILLE** – Safing
- ROCK WOOL MANUFACTURING CO** – Delta Board
- ROCKWOOL** – SAFE
- THERMAFIBER INC** – Type SAF
- C. Fill, Void or Cavity Material*** – Min 1/16 in. (0.6 mm) dry, (1/8 in. or 3.2 mm wet) thickness of fill material sprayed or brushed on each side of the wall in the flutes of the steel floor units and between the top of the gypsum board and the bottom of the steel floor units to completely cover mineral wool and overlap a min of 1/2 in. (13 mm) onto gypsum board and steel deck on both sides of wall.
- 3M COMPANY** – Firedam Spray 200
- C1. Fill, Void or Cavity Material* – Tape** – As an alternate to the 3M Firedam Spray 200 (see Item C), Tape cut to size and press applied within fluted areas of joint to completely cover mineral wool lapping min 1 in. (25 mm) onto the contour of the steel floor units and extending to lap min 1 in. (25 mm) onto the gypsum wall. Additional pieces of Tape are applied along the joint to completely cover the remaining mineral wool between bottom of steel deck and top edge of wall along length of joint, lapping min 1 in. (25 mm) onto the contour of the steel floor units and min 1 in. (25 mm) onto the gypsum wall. Adjoining lengths of Tape shall overlap min 1/2 in. (13 mm). Tape shall be applied at both sides of wall.
- 3M COMPANY** – 3M Fire and Water Barrier Tape



*Indicates such products shall bear the UL or cUL Certification Mark for jurisdictions employing the UL or cUL Certification (such as Canada), respectively.

Reprinted from the Online Certifications Directory with permission from UL©

3M Industrial Adhesive and Tapes
Fire Protection Products
3M Center, Building 230-B-S-37
St. Paul, MN 55144-1000



UL System No. HW-D-0706
XHBN - Joint Systems
XHBN7 - Joint Systems Certified for Canada

March 02, 2017

| ANSI/UL2079 | CAN/ULC S115 |
|-------------------------------------|---|
| Assembly Rating — 3 Hr | F Rating — 4 Hr |
| Nominal Joint Width - 1 in. (25 mm) | FT Rating — 3 Hr |
| | FH Rating — 4 Hr |
| | FTH Rating — 3 Hr |
| | Nominal Joint Width - 25 mm (1 in.) |
| | Class II or III Movement Capabilities — 50% Compression or Extension |

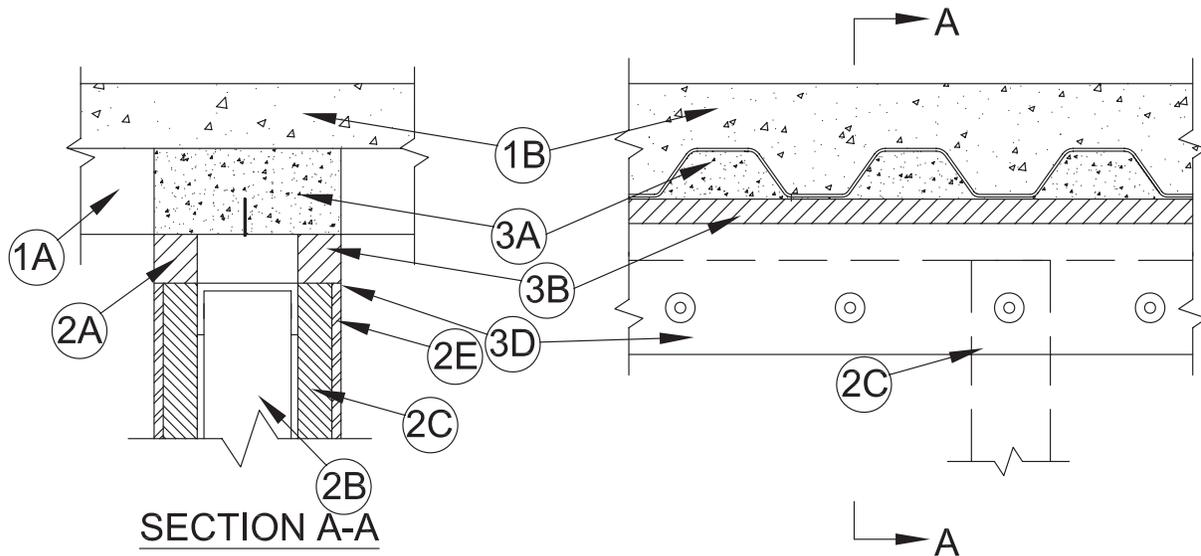

1. Floor Assembly – The fire-rated fluted steel deck/concrete floor assembly shall be constructed of the materials and in the manner described in the individual D900 Series Floor-Ceiling Design in the UL Fire Resistance Directory. The floor assembly shall have a fire rating equal to or greater than the joint system and shall include the following construction features:

- A. Steel Floor And Form Units*** – Max 3 in. (76 mm) deep galv steel fluted floor units.
- B. Concrete** – Min 2-1/2 in. (64 mm) thick reinforced concrete, as measured from the top plane of the floor units.

2. Wall Assembly – The 4 hr fire-rated cementitious and mineral fiber panels/steel stud wall assembly shall be constructed of the materials and in the manner described in Wall and Partition Design No. V460 in the UL Fire Resistance Directory and shall include the following construction features:

- A. Steel Floor And Ceiling Runners** – Nom, 4-1/4 in. (108 mm) wide by 1-3/8 in. (35 mm) deep steel channels fabricated by from min No. 14 MSG galv steel. Prior to the installation of the Mineral and Fiber Panels and Partition Panels (Items 2B and 2E), No. 8 by 2-1/2 in. (64 mm) long steel screws drilled through the ceiling runner and into the fluted deck area.
- B. Studs** – Steel studs to be channel shaped min 4 in. (102 mm) deep, 2-1/2 in. (64 mm) flanges and 1/2 in. (13 mm) return, fabricated from 14 MSG, spaced a max of 24 in. (610 mm) OC. Studs to be cut 1 in. (25 mm) less than assembly height. Studs secured to floor runners with self-drilling screws and friction fit into ceiling runners.
- C. Mineral and Fiber Boards*** – Min 1 in. (25 mm) thick calcium silicate board, 48 in. (1219 mm) wide. Boards attached to studs with No. #8 self-drilling screws, 2-3/8 in. (60 mm) long, spaced 10 in. (254 mm) OC. Joints centered over studs and staggered on opposite sides of wall.

DURASYSTEMS BARRIERS INC – PROMATECT®250

- D. Caulking and Sealants*** – (Not Shown) - Min 1/4 in. (6.4 mm) bead of sealant, installed on all vertical and horizontal joint surfaces between adjacent panels of calcium silicate board (Item 3).

DURASYSTEMS BARRIERS INC – PROMASEAL

E. Units Partition Panel* – Nom 3/8 in. (9.5 mm) thick, steel skin cementitious panels, installed over calcium silicate board (Item 3) with vertical and horizontal joints offset. Panels installed to steel studs using No. 12 flat or hex washer head self-drilling screws, 2-1/2 in. (64 mm) long, at 10 in. (25 mm) OC. At all, horizontal joints, a 14 MSG sheet of steel, 4 in. (102 mm) wide by the length of the joint is installed between the calcium silicate board (Item 3) and the DuraSteel panel (Item 5) such that it overlaps equally the ends of adjacent DuraSteel panels.

DURASYSTEMS BARRIERS INC – DURASTEEL

3. Joint System – Max separation between bottom of floor deck and top of wall is 1 in. (25 mm). The joint system is designed to accommodate a max 50 percent compression and extension from its installed width. The joint system consists of the following:

A. Fill, Void or Cavity Material - Mortar – Min 6-3/4 in. (171 mm) thickness of mortar installed in accordance with manufacturer’s installation instructions to completely fill the gap within the flutes of the steel deck, installed flush with both surfaces of the wall. As an option, foam sheets may be installed within the gap between the wall and the floor to prevent the leakage of the fill material during the installation.

DURASYSTEMS BARRIERS INC – DURA S.T.O.P Firestop Mortar

B. Fill, Void or Cavity Material - Foam Strips – Nom 1 11/16 in. (42 mm) wide tapered foam strips cut to size and compressed 68 percent in height in accordance with manufacturer’s installation instructions. Strips compressed and inserted into the gap between the top of the wall and the bottom of the steel deck, flush with both surfaces of the wall.

DURASYSTEMS BARRIERS INC – FGC

C. Fill, Void or Cavity Material* – Sealant – (Not Shown) - Prior to the installation of the foam strips (Item 3B) , a min 1/4 in. (6.4 mm) thickness of fill material applied at the bottom of the mortar (Item 3A) and the steel deck along the length of the joint in accordance with manufacturer’s installation instructions.

TREMCO INC – Tremstop Fyre Sil

C1. Fill, Void or Cavity Material* – Sealant – (Not Shown) - Prior to the installation of the cover plate, (Item 3D), a min 1/4 in. (6.4 mm) diam bead of fill material applied on the Unit Partition Panel (Item 2E) along the length of the joint approximately 1-1/2 in. (38 mm) below the top of the panel.

3M COMPANY 3M FIRE PROTECTION PRODUCTS – CP 25WB+ Caulk

D. Cover Plate* – Nom 3 in. (76 mm) wide by No. 22 gauge thick steel cover plate with a return flange provided by the foam strip manufacturer. The cover plate extends a nom 1/2 in (13 mm) on to foam strips (Item No. 3B) on both sides of the wall. The cover plate secured to wall by No. 10 by 1 in. (25 mm) long steel screws spaced a max 8 in. (203mm) OC.

DURASYSTEMS BARRIERS INC — OFP



*Indicates such products shall bear the UL or cUL Certification Mark for jurisdictions employing the UL or cUL Certification (such as Canada), respectively.

Reprinted from the Online Certifications Directory with permission from UL©

System No. HW-D-0746

October 07, 2014

ANSI/UL2079

Assembly Rating — 2 Hr

Nominal Joint Width - 1 In.

Class II Movement Capabilities — 12.5% Compression or Extension

L Rating At Ambient — Less Than 1 CFM/Lin Ft

L Rating At 400°F — Less Than 1 CFM/Lin Ft

CAN/ULC S115

F Rating — 2 Hr

FT Rating — 2 Hr

FH Rating — 2 Hr

FTH Rating — 2 Hr

Nominal Joint Width - 1 In.

Class II Movement Capabilities — 12.5% Compression or Extension

L Rating At Ambient — Less Than 1 CFM/Lin Ft

L Rating At 400°F — Less Than 1 CFM/Lin Ft

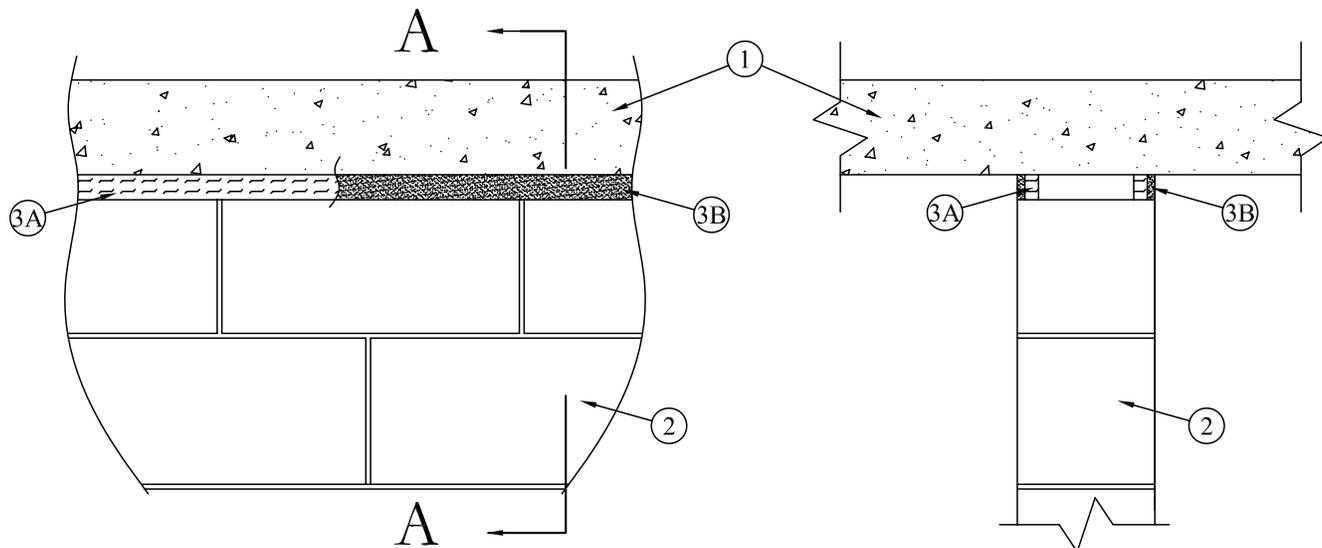

SECTION A-A

- Floor Assembly** — Min 2-1/2 in. (64 mm) thick reinforced lightweight or normal weight (100-150 pcf or 1600-2400 kg/m³) structural concrete.
- Wall Assembly** — Min 7-1/2 in. (191 mm) thick reinforced lightweight or normal weight (100-150 pcf or 1600-2400 kg/m³) structural concrete. Wall may also be constructed of any min 7-5/8 in. (194 mm) thick UL Classified **Concrete Blocks***. See **Concrete Blocks (CAZT)** category in the Fire Resistance Directory for names of manufacturers.
- Joint System** — Max width of joint (at time of installation of joint system) is 1 in. (25 mm). The joint system is designed to accommodate a max 12.5 percent compression or extension from its installed width. The joint system shall consist of the following:
 - Forming Material*** — Min 4 pcf (64 kg/m³) mineral wool batt insulation cut into strips that are min 5/8 in. (16 mm) wide with a thickness of min 25 percent larger than the joint width. The strips of mineral wool are compressed and firmly packed into the joint at both sides of wall, recessed 1/4 in. (6 mm) from face of wall.
ROCK WOOL MANUFACTURING CO — Delta Board or Delta-8
ROCKWOOL MALAYSIA SDN BHD — SAFE
ROXUL INC — SAFE
 - Fill, Void or Cavity Material*** — **Caulk** — Min 1/4 in. (6 mm) thickness of fill material installed within the joint on each side of the wall between the top of the wall and bottom of floor, flush with each surface of wall.
3M COMPANY 3M FIRE PROTECTION PRODUCTS — FireDam 150+

* Indicates such products shall bear the UL or cUL Certification Mark for jurisdictions employing the UL or cUL Certification (such as Canada), respectively.

Reprinted from the Online Certifications Directory with permission from UL

© 2014 UL LLC



January 22, 2018

| ANSI/UL2079 | CAN/ULC S115 |
|---|---|
| Assembly Ratings – 2, 3 and 4 Hr (See Item 2) | F Ratings – 2, 3 and 4 Hr (See Item 2) |
| Nominal Joint Width – 2 In. | FT Ratings – 2, 3 and 4 Hr (See Item 2) |
| Class II Movement Capabilities – 19% Compression or Extension | FH Ratings – 2, 3 and 4 Hr (See Item 2) |
| | FTH Ratings – 2, 3 and 4 Hr (See Item 2) |
| | Nominal Joint Width - 51 mm |
| | Class II Movement Capabilities – 19% Compression or Extension |

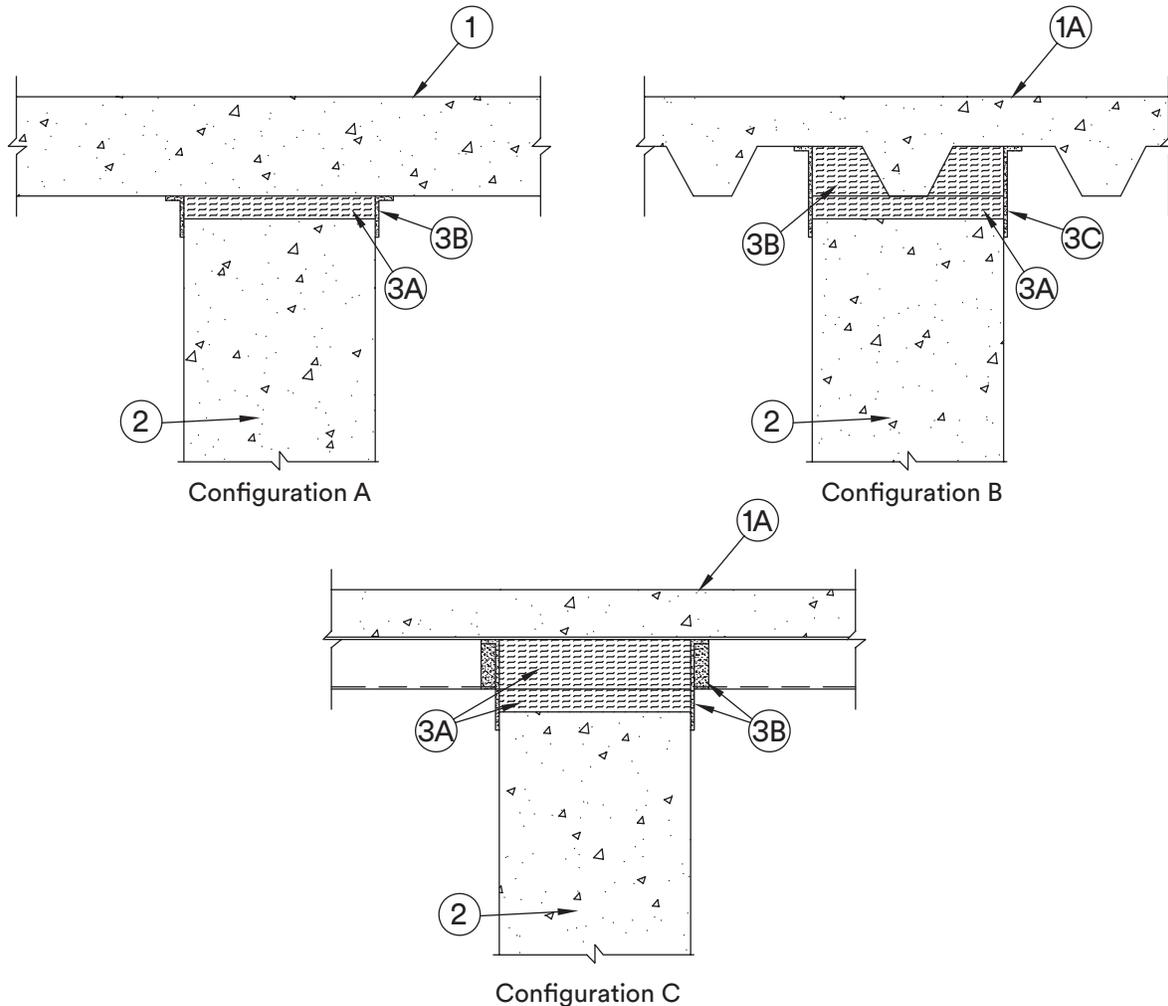

1. Floor Assembly – Min 4-1/2 in. (114 mm) thick reinforced lightweight or normal weight (100-150 pcf or 1600-2400 kg/m³) structural concrete. Floor may also be constructed of any UL Classified hollow-core Precast Concrete Units*.

See **Precast Concrete Units** (CFTV) in Fire Resistance Directory for names of manufacturers.

1A. Floor Assembly – The fire-rated fluted steel deck/concrete floor assembly shall be constructed of the materials and in the manner described in the individual D700 or D900 Series Floor-Ceiling Design in the UL Fire Resistance Directory. The hourly fire rating of the floor assembly shall be equal to or greater than the hourly fire rating of the wall assembly. The floor assembly shall include the following construction features:

A. Steel Floor And Form Units* – Max 3 in. (76 mm) deep galv steel fluted floor units.

B. Concrete – Min 2-1/2 in. (64 mm) thick reinforced concrete, as measured from the top plane of the floor units.

C. Spray Applied Fire Resistive Material* (Optional, Not Shown) – The steel floor units may be sprayed with fire resistive material in accordance with the applicable Floor-Ceiling Design. The spray applied fire resistive material is to be removed from the steel deck for the installation of the joint system (Item 3) such that the steel deck is bare over the wall.

GCP APPLIED TECHNOLOGIES INC – Type MK-6/HY

1B. Roof Assembly – (Not Shown) - As an alternate to the floor assembly (Item 1), a fire rated fluted steel deck roof assembly may be used. The roof assembly shall be constructed of the materials and in the manner described in the individual P700 or P900 Series Roof-Ceiling Design in the UL Fire Resistance Directory. The hourly fire rating of the roof assembly shall be equal to or greater than the hourly fire rating of the wall assembly. The roof assembly shall include the following construction features:

A. Steel Roof Deck – Max 3 in. (76 mm) deep galv steel fluted roof deck.

B. Roof Insulation – Min 2-1/2 in. (64 mm) thick poured insulating concrete, as measured from the top plane of the steel roof deck.

C. Spray Applied Fire Resistive Material* (Optional, Not Shown) – The steel roof units may be sprayed with fire resistive material in accordance with the applicable Roof-Ceiling Design. The spray applied fire resistive material is to be removed from the steel deck for the installation of the joint system (Item 3) such that the steel deck is bare over the wall.

GCP APPLIED TECHNOLOGIES INC – Type MK-6/HY

2. Wall Assembly – Min 6-1/8 in. (156 mm), 7-3/8 in. (187 mm) or 8-5/8 in. (219 mm) thick lightweight or normal weight (100-150 pcf or 1600-2400 kg/m³) concrete for 2, 3 and 4 hr Assembly (F, FT, FH and FTH) Ratings, respectively. Wall may also be constructed of UL Classified Concrete Blocks. The hourly Assembly, F, FT, FH and FTH rating of the joint system is equal to the hourly rating of the wall.

See **Concrete Blocks** (CAZT) category in the Fire Resistance Directory for names of manufacturers.

3. Joint System – Max separation between bottom of floor and top of wall at time of installation of joint system is 2 in. (51 mm). The joint system is designed to accommodate a maximum 19 percent compression or extension from its installed width. The joint system consists of the following:

Configurations A and B

A. Forming Material* – Min 4 pcf (64 kg/m³) density mineral wool batt insulation cut to a thickness equal to twice the height of the gap between the top of the wall and the bottom of the floor. Insulation compressed 50 percent in thickness and inserted within joint to completely fill the space between the top of the wall and the bottom of the floor, over the full thickness of the wall.

INDUSTRIAL INSULATION GROUP L L C – MinWool-1200 Safing

JOHNS MANVILLE – Safing

ROCK WOOL MANUFACTURING CO – Delta Board

ROCKWOOL MALAYSIA SDN BHD – Type Safe

ROCKWOOL – Type Safe

B. Fill, Void or Cavity Material* – Min 1/16 in. (1.6 mm) dry thickness (1/8 in. or 3.2 mm wet thickness) of fill material sprayed or brushed to completely cover forming material and to overlap a min of 1/2 in. (13 mm) on to wall and steel deck or spray applied fire resistive material on both sides of wall.

3M COMPANY 3M FIRE PROTECTION PRODUCTS – FireDam™ Spray 200

B1. Fill, Void or Cavity Material* – Tape – As an alternate to Item B, Tape cut to size and press applied to completely cover mineral wool forming material and overlap a min of 1 in. (25 mm) onto wall and steel deck, or min 2 in. (51 mm) onto spray applied fire resistive material, on both sides of wall. Adjoining lengths of Tape shall overlap min 1/2 in. (13 mm).

3M COMPANY – 3M Fire and Water Barrier Tape

Configuration C

A. Forming Material* – Nom 4 pcf (64 kg/m³) mineral wool batt cut to the shape of the steel deck flute with a height 1 in. (25 mm) greater than the height of flutes and with a length equal to the overall thickness of the wall assembly. Mineral wool batt compressed and installed into each flute above the wall with its ends projecting flush with the wall surfaces. Additional pieces of min 4 pcf (64 kg/m³) density mineral wool batt cut to a width equal to the overall thickness of the wall and with a thickness equal to twice the height of the gap between the top of the wall and the valleys of the steel deck floor. Insulation compressed 50 percent in thickness and inserted between the top of the wall and the bottom of the floor, flush with both sides of the wall.

INDUSTRIAL INSULATION GROUP L L C – MinWool-1200 Safing

JOHNS MANVILLE – Safing

ROCK WOOL MANUFACTURING CO – Delta Board

ROCKWOOL MALAYSIA SDN BHD – Type Safe

ROCKWOOL – Type Safe

B. Fill, Void or Cavity Material* – Min 1/16 in. (1.6 mm) dry thickness (1/8 in. or 3.2 mm wet thickness) of fill material sprayed or brushed to completely cover forming material and to overlap a min of 1/2 in. (13 mm) on to wall and steel deck or spray applied fire resistive material on both sides of wall.

3M COMPANY 3M FIRE PROTECTION PRODUCTS – FireDam™ Spray 200

UL System No. HW-D-0755 (cont.)

B1. Fill, Void or Cavity Material* – Tape – As an alternate to Item B, Tape cut to size and press applied within fluted areas of joint to completely cover mineral wool lapping min 1 in. (25 mm) onto the contour of the steel floor units and extending to lap min 1 in. (25 mm) onto the gypsum wall. Additional pieces of Tape are applied along the joint to completely cover the remaining mineral wool between bottom of steel deck and top edge of wall along length of joint, lapping min 1 in. (25 mm) onto the contour of the steel floor units and min 1 in. (25 mm) onto the gypsum wall. When the steel deck is coated with spray applied material, the Tape shall overlap min 2 in. (51 mm) onto the spray applied material. Adjoining lengths of Tape shall overlap min 1/2 in. (13 mm). Tape shall be applied at both sides of wall.

3M COMPANY – 3M Fire and Water Barrier Tape

Construction Joints

Head of Wall

HWD



*Indicates such products shall bear the UL or cUL Certification Mark for jurisdictions employing the UL or cUL Certification (such as Canada), respectively.

Reprinted from the Online Certifications Directory with permission from UL©

3M Industrial Adhesives and Tapes
Fire Protection Products
3M Center, Building 230-B-S-37
St. Paul, MN 55144-1000



UL System No. HW-D-0827
XHBN - Joint Systems
XHBN7 - Joint Systems Certified for Canada

July 31, 2018

| ANSI/UL2079 | CAN/ULC S115 |
|---|--|
| Assembly Rating — 2 Hr | F Rating — 2 Hr |
| Nominal Joint Width - 2 In. | FT Rating — 2 Hr |
| Class II Movement Capabilities — 13% Compression or Extension | FH Rating — 2 Hr |
| | FTH Rating — 2 Hr |
| | Nominal Joint Width - 51 mm |
| | Class II Movement Capabilities —13% Compression or Extension |

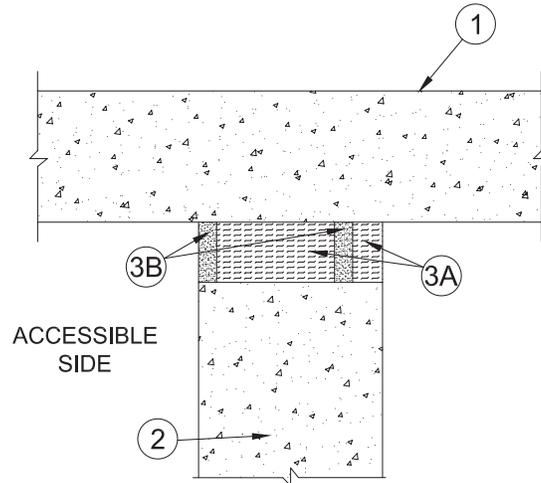

- Floor Assembly** – Min 4-1/2 in. (114 mm) thick reinforced lightweight or normal weight (100-150 pcf or 1600-2400 kg/m³) structural concrete.
- Wall Assembly** – Min 5-1/4 in. (133 mm) thick reinforced lightweight or normal weight (100-150 pcf or 1600-2400 kg/m³) structural concrete. Wall may also be constructed of any UL Classified **Concrete Blocks***.
See **Concrete Blocks** (CAZT) category in the Fire Resistance Directory for names of manufacturers.
- Joint System** – Max separation between bottom of floor and top of wall (at time of installation of joint system) is 2 in. The joint system is designed to accommodate a max 13 percent compression or extension from its installed width. The joint system shall consist of the following:
 - Forming Material*** — Min 4 pcf (64 kg/m³) mineral wool batt insulation compressed and firmly packed into the gap between the top of the wall and bottom of the floor. The strips of mineral wool batt insulation installed on the inaccessible side of the wall are to be 1 in. to 2 in. (25 to 51 mm) wide and are to be installed edge-first such that the batt sections are compressed min 50 percent, flush with the inaccessible surface of the wall. After application of the fill material (Item 3B) on the surface of the mineral wool batt packing material above the top plane of the wall, additional strips of the mineral wool batt insulation are to be installed to fill the remainder of the joint opening above the wall and recessed from the surface of the wall to accommodate the fill material on the accessible surface of the wall. Sections of strips of batts to be stacked on top of each other to form an overall thickness two times the thickness of the nominal joint width and installed edge-first such that the batt sections are compressed min 50 percent.

INDUSTRIAL INSULATION GROUP LLC — MinWool-1200 Safing

JOHNS MANVILLE — Safing

ROCK WOOL MANUFACTURING CO — Delta Safing Board

ROCKWOOL MALAYSIA SDN BHD — Type Safe

ROCKWOOL — Type Safe

THERMAFIBER INC — Type SAF

B. Fill, Void or Cavity Material* — Caulk or Sealant — Min 1/2 in. (13 mm) thickness of fill material applied within the joint over the first 1 to 2 in. (25 to 51 mm) wide strips of forming material. Min 1/2 in. (13 mm) of fill material applied within the joint, flush with the accessible surface of wall.

3M COMPANY 3M FIRE PROTECTION PRODUCTS — FireDam 150+

*Indicates such products shall bear the UL or cUL Certification Mark for jurisdictions employing the UL or cUL Certification (such as Canada), respectively.

Reprinted from the Online Certifications Directory with permission from UL©



System No. HW-D-1002

May 09, 2013

Assembly Rating – 3 Hr

Nominal Joint Width – 4 In.

Class II Movement Capabilities – 31% Compression Or Extension

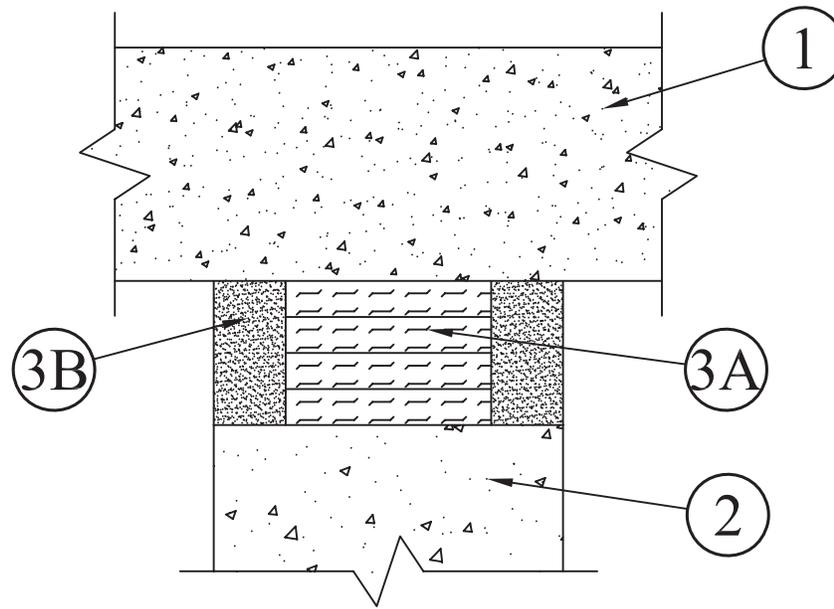

- Floor Assembly** – Min 4-1/2 in. (114 mm) thick steel-reinforced lightweight or normal weight (100-150 pcf or 1600-2400 kg/m³) structural concrete.
- Wall Assembly** – Min 5 in. thick reinforced lightweight or normal weight (100-150 pcf or 1600-2400 kg/m³) structural concrete. Wall may also be constructed of any UL Classified **Concrete Blocks***.
See **Concrete Blocks (CAZT)** category in the Fire Resistance Directory for names of manufacturers.
- Joint System** – Max separation between bottom of floor and top of wall (at time of installation of joint system) is 4 in. The joint system is designed to accommodate a max 31 percent compression or extension from its installed width. The joint system consists of a forming material and a fill material as follows:
 - Forming Material*** – Min 4.0 pcf (64 kg/m³) mineral wool batt insulation installed in joint opening as a permanent form. Pieces of batt cut to min width of 4 in. (102 mm) and installed vertically, edge-first into joint opening, such that batt sections are compressed min 50 percent in thickness and such that the compressed batt sections are recessed from each surface of wall as required to accommodate the required thickness of fill material. Adjoining lengths of batt to be tightly-butted with butted seams spaced min 12 in. (305 mm) apart along the length of the joint.
IIG MINWOOL LLC – MinWool-1200 Safing
ROCK WOOL MANUFACTURING CO – Delta Board
ROCKWOOL MALAYSIA SDN BHD – Type Safe
ROXUL INC – Type Safe
THERMAFIBER INC – Type SAF
 - Fill, Void or Cavity Material*** – Min 1/2 in. (13 mm) thickness of fill material applied within the joint, flush with each surface of wall.
3M COMPANY – FB-1000 NS, FB-1003SL or FB-2000

*Bearing the UL Classification Mark

Reprinted from the Online Certifications Directory with permission from UL

© 2013 UL LLC



Construction Joints

Head of Wall

HWD

System No. HW-D-1003

May 09, 2013

Assembly Rating – 2 Hr

Nominal Joint Width – 4 In.

Class II Movement Capabilities – 25% Compression Or Extension

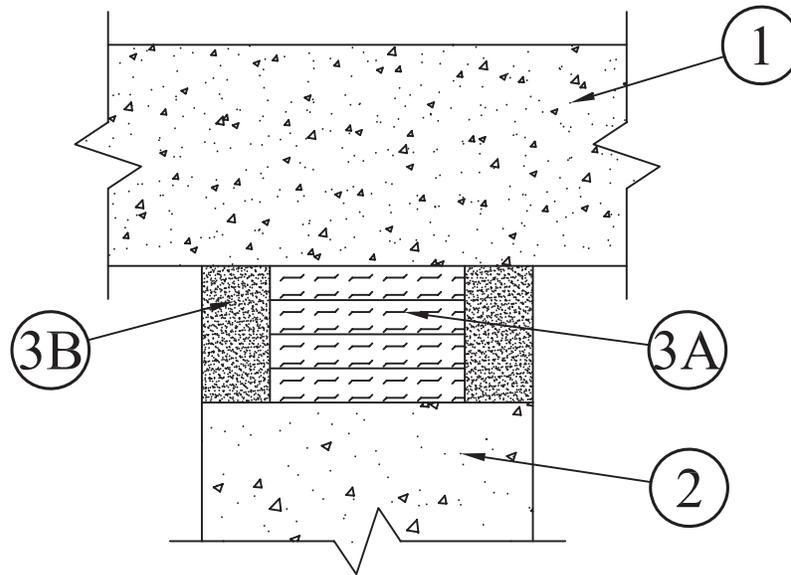

1. **Floor Assembly** – Min 4-1/2 in. (114 mm) thick steel-reinforced lightweight or normal weight (100-150 pcf or 1600-2400 kg/m³) structural concrete.
2. **Wall Assembly** – Min 4-1/2 in. (114 mm) thick reinforced lightweight or normal weight (100-150 pcf or 1600-2400 kg/m³) structural concrete. Wall may also be constructed of any UL Classified **Concrete Blocks***.
See **Concrete Blocks (CAZT)** category in the Fire Resistance Directory for names of manufacturers.
3. **Joint System** – Max separation between bottom of floor and top of wall (at time of installation of joint system) is 4 in. The joint system is designed to accommodate a max 25 percent compression or extension from its installed width. The joint system consists of a forming material and a fill material as follows:
 - A. **Forming Material*** – Min 4.0 pcf (64 kg/m³) mineral wool batt insulation installed in joint opening as a permanent form. Pieces of batt cut to min width of 4 in. (102 mm) and installed vertically, edge-first into joint opening, such that batt sections are compressed min 50 percent in thickness and such that the compressed batt sections are recessed from each surface of wall as required to accommodate the required thickness of fill material. Adjoining lengths of batt to be tightly-butted with butted seams spaced min 12 in. (305 mm) apart along the length of the joint.
HIG MINWOOL LLC – MinWool-1200 Safing
ROCK WOOL MANUFACTURING CO – Delta Board
ROCKWOOL MALAYSIA SDN BHD – Type Safe
ROXUL INC – Type Safe
THERMAFIBER INC – Type SAF
 - B. **Fill, Void or Cavity Material*** – Min 1/4 in. (6 mm) thickness of fill material applied within the joint, flush with each surface of wall.
3M COMPANY – FB-1000 NS or FB-2000

*Bearing the UL Classification Mark

Reprinted from the Online Certifications Directory with permission from UL

© 2013 UL LLC



System No. HW-D-1007

December 21, 2011

Assembly Rating – 3 Hr

Nominal Joint Width – 4 In.

Class II Movement Capabilities – 12.5% Compression Or Extension

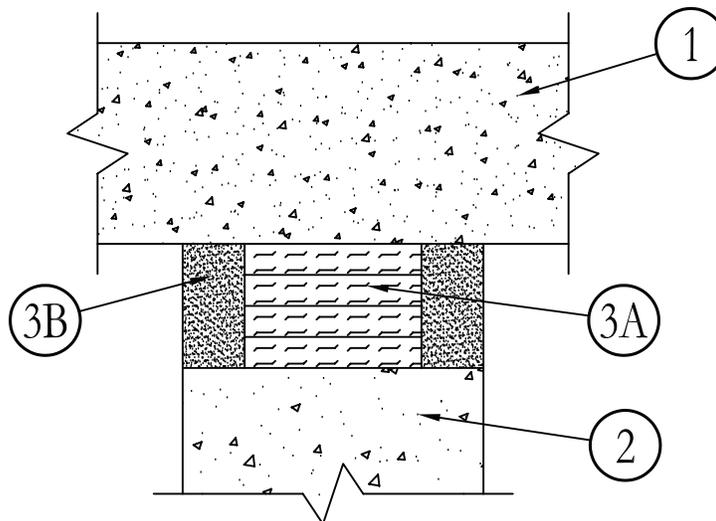

- Wall Assembly** – Min 4-1/2 in. thick reinforced lightweight or normal weight (100-150 pcf) structural concrete. Wall may also be constructed of any UL Classified **Concrete Blocks***.
See **Concrete Blocks** (CAZT) category in the Fire Resistance Directory for names of manufacturers.
- Floor Assembly** – Min 4-1/2 in. thick steel-reinforced lightweight or normal weight (100-150 pcf) structural concrete.
- Joint System** – **Max width of joint (at time of installation of joint system) is 4 in. The joint system is designed to accommodate a max 12.5 percent compression or extension from its installed width.** The joint system shall consist of the following:
 - Forming Material*** – Min 4.0 pcf mineral wool batt insulation installed in joint opening as a permanent form. Pieces of batt cut to min width of 4 in. and installed edge-first into joint opening, parallel with joint direction, such that batt sections are compressed min 50 percent in thickness and such that the compressed batt sections are recessed from top surface of floor to accommodate the required thickness of fill material. Adjoining lengths of batt to be tightly-butted with butted seams spaced min 12 in. apart along the length of the joint.
IIG MINWOOL L L C – MinWool-1200 Safing
ROCK WOOL MANUFACTURING CO – Delta Safing Board
ROCKWOOL MALAYSIA SDN BHD – Type Safe
ROXUL INC – Type Safe
THERMAFIBER INC – Type SAF
 - Fill, Void or Cavity Material*** – Min 1/4 in. thickness of fill material applied within the joint, flush with top surface of floor.
3M COMPANY – FB-2000+

*Bearing the UL Classification Mark

Reprinted from the Online Certifications Directory with permission from UL
© 2012 UL LLC



UL System No. HW-D-1010

December 14, 2016

ANSI/UL2079

Assembly Rating – 2 Hr
Nominal Joint Width – 4 in.

Class II Movement Capabilities – 19% Compression or Extension

CAN/ULC S115

F Rating – 2 Hr
FT Rating – 2 Hr
FH Rating – 2 Hr
FTH Rating – 2 Hr

Nominal Joint Width – 102 mm

Class II Movement Capabilities – 19% Compression or Extension

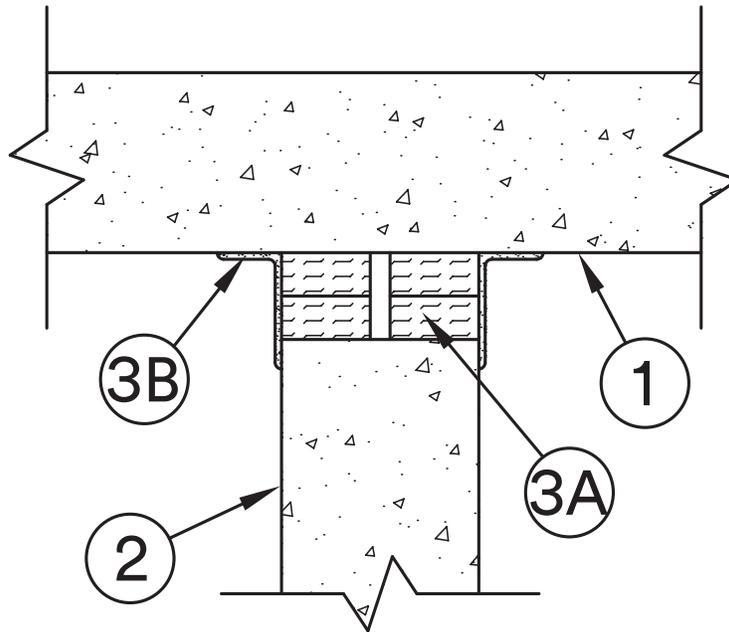

- 1. Floor Assembly** – Min 4-1/2 in. (114 mm) thick steel-reinforced lightweight or normal weight (100-150 pcf or 1600-2400 kg/m³) structural concrete.
- 2. Wall Assembly** – Min 7-1/2 in. 191 mm) thick lightweight or normal weight (100-150 pcf or 1600-2400 kg/m³) concrete. Wall may also be constructed of any UL Classified **Concrete Blocks**.
See **Concrete Blocks** (CAZT) category in the Fire Resistance Directory for names of manufacturers.
- 3. Joint System** – Max separation between bottom of floor and top of wall is 4 in. (102 mm). The joint system is designed to accommodate a max 19 percent compression or extension from its installed width. The joint system consists of a forming material and a fill material, as follows:
 - A. Forming Material*** – Min 4 pcf (64 kg/m³) mineral wool batt insulation compressed and firmly packed into the gap between the top of the wall and bottom of the floor on both sides of the wall. Sections of min 3 in. (76 mm) wide strips of batts to be stacked on top of each other to form an overall thickness two times the thickness of the nominal joint width and installed edge-first such that the batt sections are compressed min 50 percent and installed flush with both surfaces of wall.
INDUSTRIAL INSULATION GROUP LLC – MinWool-1200 Safing
JOHNS MANVILLE – Safing
ROCK WOOL MANUFACTURING CO – Delta Safing Board
ROCKWOOL MALAYSIA SDN BHD – Type Safe
ROXUL INC – Type Safe
THERMAFIBER INC – Type SAF
 - B. Fill, Void or Cavity Material*** – Min 1/16 in. (1.6 mm) dry thickness (min 1/8 in. or 3.2 mm wet thickness) of fill material sprayed or brushed on each side of the wall between the top of the wall and the bottom of the floor to completely cover mineral wool and overlap a min of 1/2 in. (13 mm) onto wall and floor on both sides of wall.
3M COMPANY – FireDam™ Spray 200
 - B1. Fill, Void or Cavity Material* – Tape** – As an alternate to Item B, Tape cut to size and press applied over the mineral wool forming material, lapping min 1 in. (25 mm) onto the concrete floor and extending to lap min 1 in. (25 mm) onto the concrete wall. Tape applied in minimum 1 ft (305 mm) lengths along joint and adjoining lengths of Tape shall overlap min 1/2 in. (13 mm). Tape shall be applied at both sides of wall.
3M COMPANY – 3M Fire and Water Barrier Tape

*Indicates such products shall bear the UL or cUL Certification Mark for jurisdictions employing the UL or cUL Certification (such as Canada), respectively. 

Reprinted from the Online Certifications Directory with permission from UL©

System No. HW-D-1011

February 19, 2014

ANSI/UL2079

Assembly Ratings — 1, 2 and 3 Hr (See Item 2)

Nominal Joint Width - 3 In.

Class II or III Movement Capabilities —

100% Compression or Extension

CAN/ULC S115

F Ratings — 1, 2 and 3 Hr (See Item 2)

FT Ratings — 1, 2 and 3 Hr (See Item 2)

FH Ratings — 1, 2 and 3 Hr (See Item 2)

FTH Ratings — 1, 2 and 3 Hr (See Item 2)

Nominal Joint Width - 3 In.

Class II or III Movement Capabilities — 100% Compression or Extension

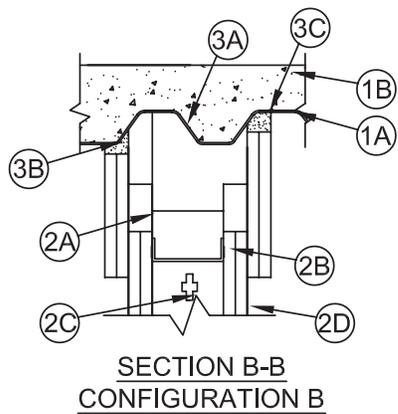
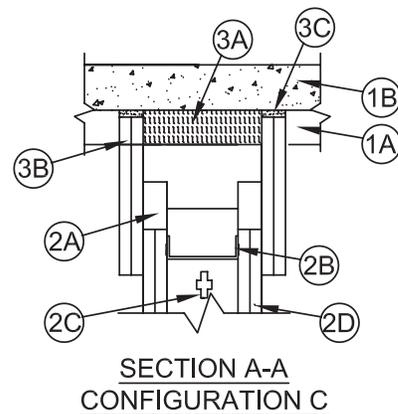
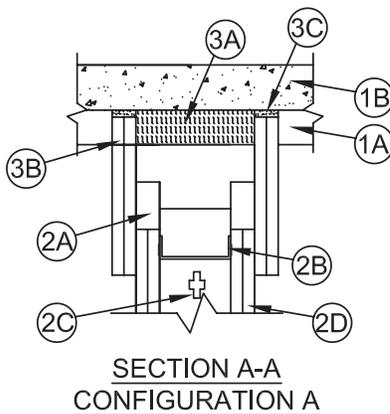
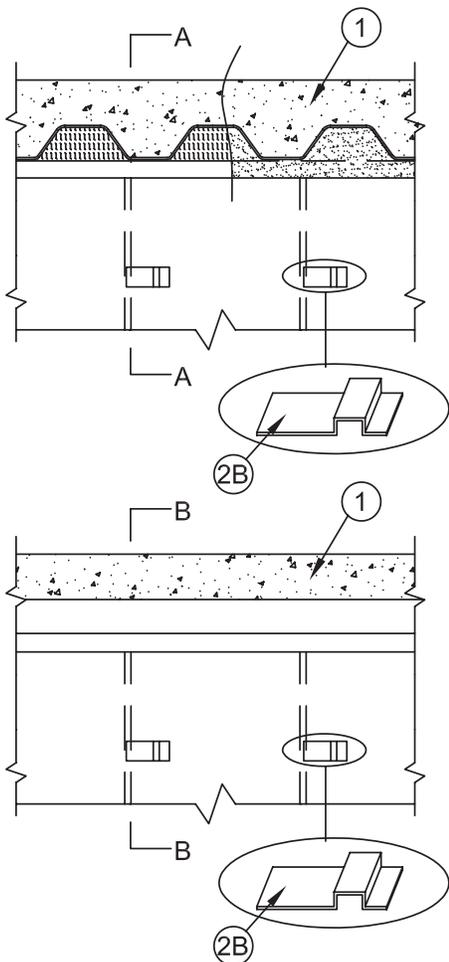

1. **Floor Assembly** — The fire-rated fluted steel deck/concrete floor assembly shall be constructed of the materials and in the manner described in the individual Floor-Ceiling Design in the UL Fire Resistance Directory. The hourly fire rating of the floor assembly shall be equal to or greater than the hourly fire rating of the wall assembly. The floor assembly shall include the following construction features:
 - A. **Steel Floor and Form Units*** — Max 3 in. (76 mm) deep galv fluted floor units.
 - B. **Concrete** — Min 2-1/2 in. (64 mm) thick reinforced (100-150 pcf or 1600-2400 kg/m³) concrete, as measured from the top plane of the floor units.
- 1A. **Roof Assembly** — As an alternate to Item 1, the fire-rated roof assembly shall be constructed of the materials and in the manner described in the individual P700, P800 or P900 Series Roof-Ceiling Designs in the UL Fire Resistance Directory and shall contain max 3 in. deep galv steel fluted roof units. The hourly fire rating of the roof assembly shall be equal to or greater than the hourly fire rating of the wall assembly. In the case of spray-applied protection materials on the steel roof units, the joint system shall be installed prior to the spray-applied protection material.
- 1B. **Floor Assembly** — As an alternate to Item 1, min 4-1/2 in. (114 mm) thick reinforced lightweight or normal weight (100-150 pcf or 1600-2400 kg/m³) structural concrete or any min 6 in. (152 mm) thick UL Classified hollow-core **Precast Concrete Units***.
See **Precast Concrete Units** (CFTV) category in the Fire Resistance Directory for names of manufactures.
2. **Wall Assembly** — The 1, 2 or 3 hr fire-rated gypsum board /steel stud wall assembly shall be constructed of the materials and in the manner described in the individual U400, V400 or W400-Series Wall and Partition Design in the UL Fire Resistance Directory and shall include the following construction features:
 - A. **Light Gauge Framing* — Deflection Trak** — Deflection trak of wall assembly shall consist of min No. 25 gauge galv steel channels sized to accommodate steel studs (Items 2C) and with offset legs to accommodate wall cladding (Item 3A). Deflection trak installed parallel or perpendicular to the floor units. When installed perpendicular (Configuration A), min No. 25 gauge deflection trak secured on both sides to valley of floor units with 1-1/2 in. (38 mm) long welds spaced max 12 in. (305 mm) OC. Min No. 20 gauge deflection trak

System No. HW-D-1011 *continued*

may be secured with No. 8 by 1/2 in. (13 mm) long steel tec screws spaced 12 in. (305 mm) OC. When installed parallel (Configuration B), min No. 25 gauge deflection trak secured on one side to valley of floor units with 1-1/2 in. (38 mm) long welds spaced 12 in. (305 mm) OC. Min No. 25 gauge deflection trak may be secured with No. 8 by 1/2 in. (13 mm) steel tec screws spaced max 12 in. (305 mm) OC. The other side of the deflection trak is secured to Z-Furring clips (Item 2B) with two No. 8 by 1/2 in. (13 mm) long steel tec screws. On concrete floor (Configuration C), min No. 20 gauge deflection trak attached to concrete at ceiling with 1/4 in. (6 mm) diam by 1-1/4 in. (32 mm) long steel expansion anchors spaced max 12 in. (305 mm) OC.

FIRE TRAK CORP — Shadowline

- B. **Light Gauge Framing*** — Clips are attached to the inside bottom leg of the ceiling runner (Item 2A) with 2 — No.8 by 1/2 in. (13 mm) long steel self-drilling framing screws and engage the short flange of the studs.

FIRE TRAK CORP — Slip Clips or Redi Klips

- C. **Studs** — Steel studs to be min 2-1/2 in. (64 mm) wide and specified in the individual Wall and Partition Design in the UL Fire Resistance Directory. Studs cut 4 in. (102 mm) less in length than the assembly height with bottom nesting in and resting on floor runner and with top nesting in ceiling runner without attachment. Stud spacing not to exceed 24 in. (610 mm) OC.
- D. **Gypsum Board*** — Gypsum board sheets installed and attached to studs and runners as specified in the individual Wall and Partition Design in the UL Fire Resistance Directory, except that a nominal 3-1/2 in. (89 mm) gap shall be maintained between top of the gypsum board and the bottom flange of the deflection trak. Top row of screws shall be installed into the studs 13-1/2 in. (343 mm) below the top edge of the gypsum board sheets.
- E. **Z-Furring — (Parallel Units)** — When trak is installed parallel to floor units, Z-Furring clips are attached to the bottom of the floor units within the crests and top of the deflection trak with two No. 8 by 1/2 in. (13 mm) long steel tec screws. Clip spacing not to exceed 24 in. (610 mm) OC.

FIRE TRAK CORP — Z-Furring Clips

The hourly ratings of the joint system are equal to the fire rating of the wall.

Firestop Configuration A

3. **Joint System — Max separation between bottom flange of the deflection trak and top of wallboard (at the time of installation of the joint system) is 3 in. (76 mm). The joint system is designed to accommodate a max 100 percent compression or extension from its installed width.** The joint system consists of packing material (Item 3A), wall cladding (Item 3B) and a fill material (Item 3C) as follows:
- A. **Packing Material** — Min 4 pcf (64 kg/m³) density mineral wool batt insulation cut to the shape of the fluted deck, 25 percent larger than the area of the flutes and compressed into the flutes of the steel floor units above the ceiling runner as a permanent form.
- B. **Wall Cladding** — Strips of the gypsum board material cut to the contour of the steel floor units and attached to the deflection trak. The number of layers, board type and thickness and fastener type shall be specified for the gypsum board in the individual Wall and Partition Design in the UL Fire Resistance Directory. Fasteners shall be max spaced 3 in. OC. The top of the wall cladding shall be recessed min 1/8 in. (3.2 mm) to max 1/2 in. (13 mm) from the steel floor units and overlap the gypsum board 7 in. (178 mm).
- C. **Fill, Void or Cavity Material*** — Full depth of fill material installed on each side of the wall between the top of the wall cladding and the surface of the steel floor units, flush with each surface of the cladding.

3M COMPANY — FB 1000NS, FB 2000, FB 2000+, FD-150+, CP 25 WB+

Firestop Configuration B

3. **Joint System — Max separation between bottom flange of the deflection trak and top of wallboard (at the time of installation of the joint system) is 3 in. The joint system is designed to accommodate a max 100 percent compression or extension from its installed width.** The joint system consists of wall cladding (Item 3A) and a fill material (Item 3B) as follows:
- A. **Wall Cladding** — Strips of the gypsum board material attached to the deflection trak. The number of layers, board type and thickness and fastener type shall be as specified for the gypsum board in the individual Wall and Partition Design in the UL Fire Resistance Directory. Fasteners shall be max spaced 3 in. (76 mm) OC. The top of the wall cladding shall be recessed min 1/8 in. (3.2 mm) to max 1/2 in. (13 mm) from the steel floor units and overlap the gypsum board 7 in. (178 mm).
- B. **Fill, Void or Cavity Material*** — Full depth of fill material installed on each side of the wall between the top of the wall cladding and the surface of the steel floor units, flush with each surface of the cladding.

3M COMPANY — FB 1000NS, FB 2000, FB 2000+, FD-150+, CP 25 WB+

Firestop Configuration C

3. **Joint System — Max separation between bottom flange of the deflection trak and top of wallboard (at the time of installation of the joint system) is 3 in. (76 mm). The joint system is designed to accommodate a max 100 percent compression or extension from its installed width.** The joint system consists of wall cladding (Item 3A) and a fill material (Item 3B) as follows:
- A. **Wall Cladding** — Strips of the gypsum board material attached to the deflection trak. The number of layers, board type and thickness and fastener type shall be as specified for the gypsum board in the individual Wall and Partition Design in the UL Fire Resistance Directory. Fasteners shall be max spaced 3 in. (76 mm) OC. The top of the wall cladding shall be recessed min 1/8 in. (3.2 mm) to max 1/2 in. (13 mm) from the bottom of the concrete floor and overlap the gypsum board 7 in. (178 mm).
- B. **Fill, Void or Cavity Material*** — Full depth of fill material installed on each side of the wall between the top of the wall cladding and the bottom of the floor assembly, flush with each surface of the cladding.

3M COMPANY — FB 1000NS, FB 2000, FB 2000+, FD-150+, CP 25 WB+

*Bearing the UL Classification Mark

Reprinted from the Online Certifications Directory with permission from UL

© 2014 UL LLC



System No. HW-D-1012

February 19, 2014

ANSI/UL2079

Assembly Ratings — 1, 2 and 3 Hr (See Item 2)

Nominal Joint Width - 3 In.

Class II or III Movement Capabilities —
100% Compression or Extension

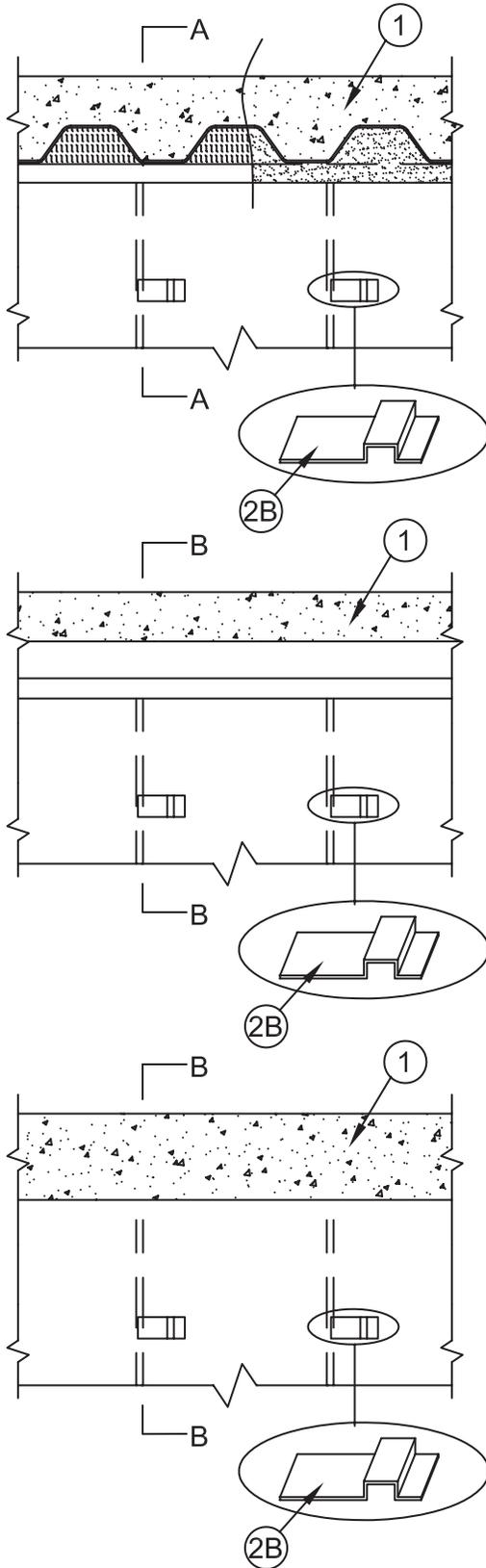

CAN/ULC S115

F Ratings — 1, 2 and 3 Hr (See Item 2)

FT Ratings — 1, 2 and 3 Hr (See Item 2)

FH Ratings — 1, 2 and 3 Hr (See Item 2)

FTH Ratings — 1, 2 and 3 Hr (See Item 2)

Nominal Joint Width - 3 In.

Class II or III Movement Capabilities — 100% Compression or Extension

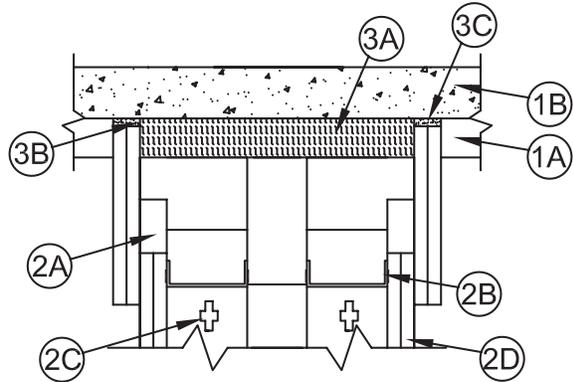

**SECTION A-A
CONFIGURATION A**

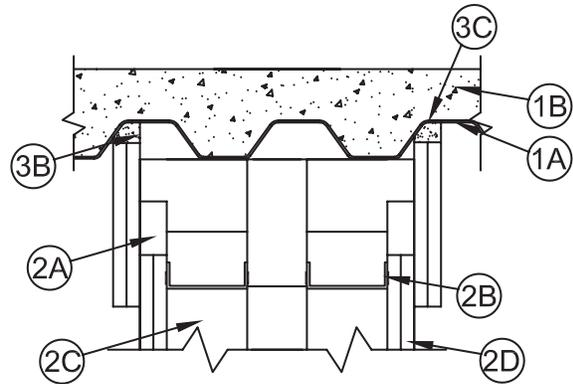

**SECTION B-B
CONFIGURATION B**

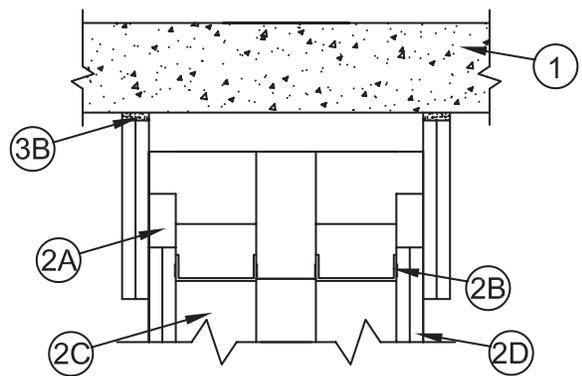

**SECTION C-C
CONFIGURATION C**

System No. HW-D-1012 *continued*

Construction Joints

Head of Wall

1. **Floor Assembly** — The fire-rated fluted steel deck/concrete floor assembly shall be constructed of the materials and in the manner described in the individual Floor-Ceiling Design in the UL Fire Resistance Directory. The hourly fire rating of the floor assembly shall be equal to or greater than the hourly fire rating of the wall assembly. The floor assembly shall include the following construction features:
 - A. **Steel Floor and Form Units*** — Max 3 in. (76 mm) deep galv fluted floor units.
 - B. **Concrete** — Min 2-1/2 in. (64 mm) thick reinforced (100-150 pcf or 1600-2400 kg/m³) concrete, as measured from the top plane of the floor units.
- 1A. **Roof Assembly** — As an alternate to Item 1, the fire-rated roof assembly shall be constructed of the materials and in the manner described in the individual P700, P800 or P900 series Roof-Ceiling Designs in the UL Fire Resistance Directory and shall contain max 3 in. (76 mm) deep galv steel fluted roof units. The hourly fire rating of the roof assembly shall be equal to or greater than the hourly fire rating of the wall assembly. In the case of spray-applied protection materials on the steel roof units, the joint system shall be installed prior to the spray-applied protection material.
- 1B. **Floor Assembly** — As an alternate to Item 1, min 4-1/2 in. (114 mm) thick reinforced lightweight or normal weight (100-150 pcf or 1600-2400 kg/m³) structural concrete or any min 6 in. (152 mm) thick UL Classified hollow-core **Precast Concrete Units***.
See **Precast Concrete Units** (CFTV) category in the Fire Resistance Directory for names of manufactures.
2. **Wall Assembly** — The 1, 2 or 3 hr fire-rated gypsum board/steel stud wall assembly shall be constructed of the materials and in the manner described in the individual U400, V400 or W400-Series Wall and Partition Design in the UL Fire Resistance Directory and shall include the following construction features:

- A. **Light Gauge Framing* — Deflection Trak** — Deflection trak of wall assembly shall consist of min No. 25 gauge galv steel channels sized to accommodate steel studs (Item 2C) and with offset legs to accommodate wall cladding (Item 3A). Deflection trak installed parallel or perpendicular to the floor units. When installed perpendicular (Configuration A), min No. 25 gauge deflection trak secured on both sides to valley of floor units with 1-1/2 in. (38 mm) long welds spaced max 12 in. (305 mm) OC. Min No. 20 gauge deflection trak may be secured with No. 8 by 1/2 in. (13 mm) long steel tec screws spaced 12 in. (305 mm) OC. When installed parallel (Configuration B), min No. 25 gauge deflection trak secured on one side to valley of floor units with 1-1/2 in. (38 mm) long welds spaced 12 in. (305 mm) OC. Min No. 25 gauge deflection trak may be secured with No. 8 by 1/2 in. (13 mm) steel tec screws spaced max 12 in. (305 mm) OC. The other side of the deflection trak is secured to Z-Furring clips (Item 2B) with two No. 8 by 1/2 in. (13 mm) long tec screws. On concrete floor (Configuration C), min No. 20 gauge deflection trak attached to concrete at ceiling with 1/4 in. (6 mm) diam by 1-1/4 in. (32 mm) long steel expansion anchor spaced max 12 in. OC.

FIRE TRAK CORP — Shadowline, Cavity Shadowline

- B. **Light Gauge Framing*** — Clips are attached to the inside bottom leg of the ceiling runner (Item 2A) with 2 - No. 8 by 1/2 in. (13 mm) long steel-drilling framing screws and engage the short flange of the studs.

FIRE TRAK CORP — Slip Clips or Redi Klips

- C. **Studs** — Steel studs to be min 2-1/2 in. (64 mm) wide and as specified in the individual Wall and Partition Design in the UL Fire Resistance Directory. Studs cut 4 in. (102 mm) less in length than the assembly height with bottom nesting in and resting on floor runner and with top nesting in ceiling runner without attachment. Stud spacing not to exceed 24 in. (610 mm) OC.
- D. **Gypsum Board*** — Gypsum board sheets installed and attached to studs and runners as specified in the individual Wall and Partition Design in the UL Fire Resistance Directory, except that a nominal 3-1/2 in. (89 mm) gap shall be maintained between top of the gypsum board and the bottom flange of the deflection trak. Top row of screws shall be installed into the studs 13-1/2 in. (343 mm) below the top edge of the gypsum board sheets.
- E. **Z-Furring — (Parallel Units)** — When trak is installed parallel to floor units, Z-Furring clips are attached to the bottom of the floor units within the crests and top of the deflection trak with two No. 8 by 1/2 in. (13 mm) long tec screws or steel fasteners. Clip spacing not to exceed 24 in. (610 mm) OC.

FIRE TRAK CORP — Z-Furring Clips

- F. **Bracing** — (Not Shown) - Bracing as specified in the individual Wall and Partition Design in the UL Fire Resistance Directory.

The hourly ratings of the joint system are equal to the fire rating of the wall.

Firestop Configuration A

3. **Joint System** — **Max separation between bottom flange of the deflection trak and top of wallboard (at the time of installation of the joint system) is 1 in. (25 mm). The joint system is designed to accommodate a max 100 percent compression or extension from its installed width.** The joint system consists of packing material (Item 3A), wall cladding (Item 3B) and a fill material (Item 3C) as follows:
 - A. **Packing Material** — Min 4 pcf (64 kg/m³) density mineral wool batt insulation cut to the shape of the fluted deck, 25 percent larger than the area of the flutes and compressed into the flutes of the steel floor units above the ceiling runner as a permanent form.
 - B. **Wall Cladding** — Strips of the gypsum board material cut to the contour of the steel floor units and attached to the deflection trak. The number of layers, board type and thickness and fastener type shall be as specified for the gypsum board in the individual Wall and Partition Design in the UL Fire Resistance Directory. Fasteners shall be max spaced 3 in. (76 mm) OC. The top of the wall cladding shall be recessed min 1/8 in. (3.2 mm) to max 1/2 in. (13 mm) from the steel floor units and overlap the gypsum board 7 in. (178 mm).
 - C. **Fill, Void or Cavity Material*** — Full depth of fill material installed on each side of the wall between the top of the wall cladding and the surface of the steel floor units, flush with each surface of the cladding.

3M COMPANY — FB 1000NS, FB 2000, FB 2000+, FD-150+, CP 25 WB+

HW-D

System No. HW-D-1012 *continued*

Firestop Configuration B

3. **Joint System** — Max separation between bottom flange of the deflection trak and top of wallboard (at the time of installation of the joint system) is 1 in. (25 mm). The joint system is designed to accommodate a max 100 percent compression or extension from its installed width. The joint system consists of packing material (Item 3A), wall cladding (Item 3B) and a fill material (Item 3C) as follows:
- A. **Wall Cladding** — Strips of the gypsum board material attached to the deflection trak. The number of layers, board type and thickness and fastener type shall be as specified for the gypsum board in the individual Wall and Partition Design in the UL Fire Resistance Directory. Fasteners shall be max spaced 3 in. (76 mm) OC. The top of the wall cladding shall be recessed min 1/8 in. (3.2 mm) to max 1/2 in. (13 mm) from the steel floor units and overlap the gypsum board 7 in. (178 mm).
 - B. **Fill, Void or Cavity Material*** — Full depth of fill material installed on each side of the wall between the top of the wall cladding and the surface of the steel floor units, flush with each surface of the cladding.
- 3M COMPANY** — FB 1000NS, FB 2000, FB 2000+, FD-150+, CP 25 WB+

Firestop Configuration C

3. **Joint System** — Max separation between bottom flange of the deflection trak and top of wallboard (at the time of installation of the joint system) is 1 in. (25 mm). The joint system is designed to accommodate a max 100 percent compression or extension from its installed width. The joint system consists of packing material (Item 3A), wall cladding (Item 3B) and a fill material (Item 3C) as follows:
- A. **Wall Cladding** — Strips of the gypsum board material attached to the deflection trak. The number of layers, board type and thickness and fastener type shall be as specified for the gypsum board in the individual Wall and Partition Design in the UL Fire Resistance Directory. Fasteners shall be max spaced 3 in. (76 mm) OC. The top of the wall cladding shall be recessed min 1/8 in. (3.2 mm) to max 1/2 in. (13 mm) from the bottom of the concrete floor and overlap the gypsum board 7 in. (178 mm).
 - B. **Fill, Void or Cavity Material*** — Full depth of fill material installed on each side of the wall between the top of the wall cladding and the surface of the steel floor units, flush with each surface of the cladding.
- 3M COMPANY** — FB 1000NS, FB 2000, FB 2000+, FD-150+, CP 25 WB+

*Bearing the UL Classification Mark

Reprinted from the Online Certifications Directory with permission from UL
© 2014 UL LLC



System No. HW-D-1015

January 11, 2013

Assembly Rating – 2 Hr

L Rating At Ambient – Less Than 1 CFM/Lin Ft

L Rating At 400 F – Less Than 1 CFM/Lin Ft

Nominal Joint Width – 4 In.

Class II Movement Capabilities – 15.6% Compression or Extension

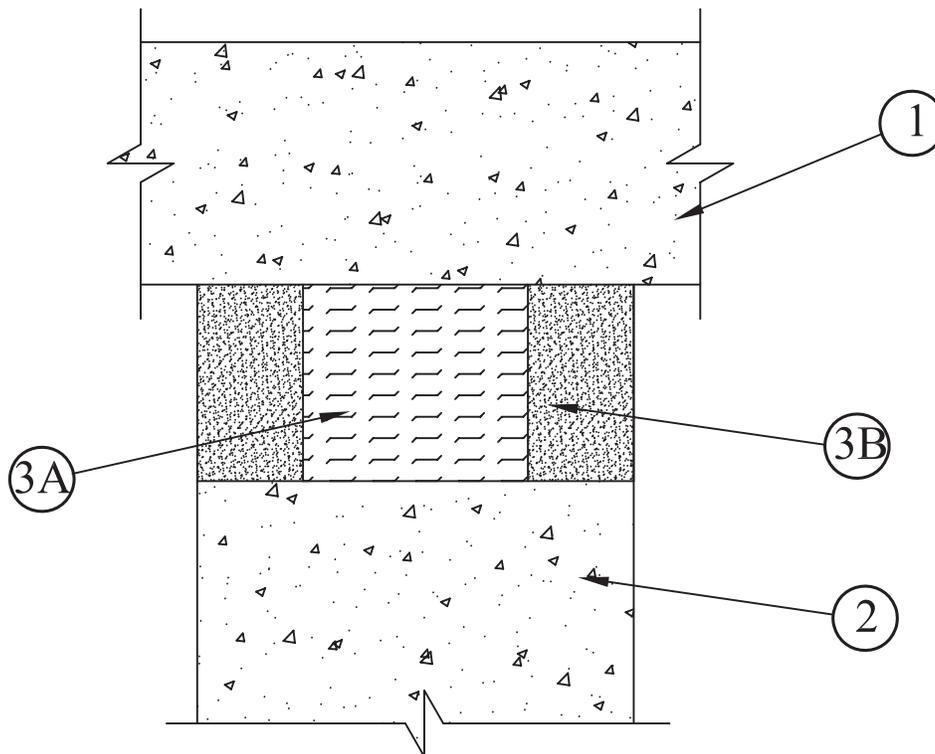

1. **Floor Assembly** – Min 4-1/2 in. thick steel-reinforced lightweight or normal weight (100-150 pcf) structural concrete.
2. **Wall Assembly** – Min 5 in. thick steel-reinforced lightweight or normal weight (100-150 pcf) structural concrete. Wall may also be constructed of any UL Classified **Concrete Blocks***.
3. **Joint System** – **Max width of joint (at time of installation of joint system) is 4 in. The joint system is designed to accommodate a max 15.6 percent compression or extension from its installed width.** The joint system shall consist of the following:
 - A. **Forming Material*** – Min 4.0 pcf mineral wool batt insulation installed in joint opening as a permanent form. Batt cut to min width of 4 in. and installed edge-first into joint opening, parallel with joint direction, such that batt sections are compressed min 50 percent in thickness and such that the compressed batt sections are recessed from both surfaces of wall to accommodate the required thickness of fill material. Adjoining lengths of batt to be tightly-butted with butted seams spaced min 48 in. apart along the length of the joint. –
ROCK WOOL MANUFACTURING CO – Delta Safing Board
ROCKWOOL MALAYSIA SDN BHD – Type Safe
ROXUL INC – Type Safe
THERMAFIBER INC – Type SAF
 - B. **Fill, Void or Cavity Material*** – Min 1/2 in. thickness of fill material applied within the joint, flush with both surfaces of wall.
3M COMPANY – FB 1000 NS

*Bearing the UL Classification Mark

Reprinted from the Online Certifications Directory with permission from UL

© 2013 UL LLC



System No. HW-D-1020

XHBN - Joint Systems
XHBN7 - Joint Systems Certified for Canada
December 16, 2016

| ANSI/UL2079 | CAN/ULC S115 |
|---|---|
| Assembly Ratings — 1, and 2 Hr (See Item 2) | F Ratings — 1 and 2 Hr (See Item 2) |
| Nominal Joint Width - 3 In. | FT Ratings — 1 and 2 Hr (See Item 2) |
| Class II or III Movement Capabilities — 100% Compression or Extension | FH Ratings — 1 and 2 Hr (See Item 2) |
| | FTH Ratings — 1 and 2 Hr (See Item 2) |
| | Nominal Joint Width - 3 In. |
| | Class II or III Movement Capabilities — 100% Compression or Extension |

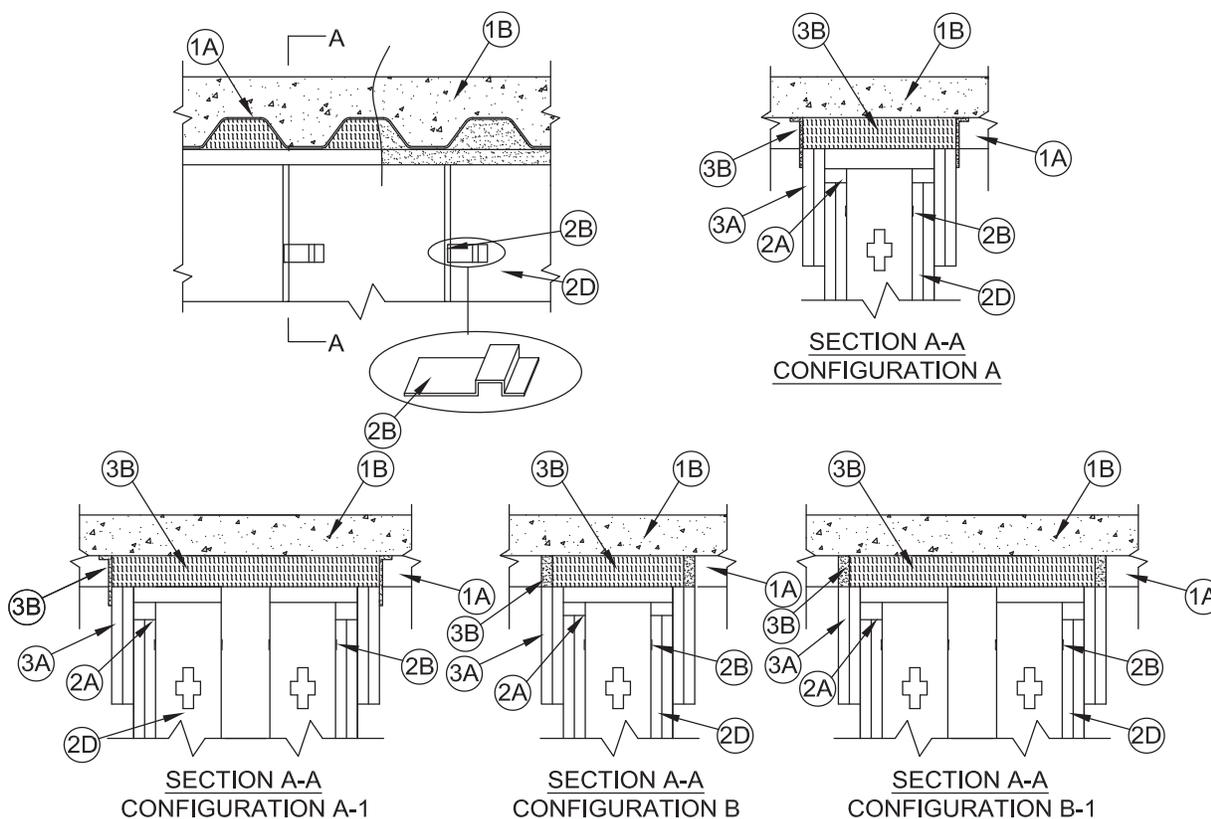

1. **Floor Assembly** — The fire-rated fluted steel deck/concrete floor assembly shall be constructed of the materials and in the manner described in the individual Floor-Ceiling Design in the UL Fire Resistance Directory. The hourly fire rating of the floor assembly shall be equal to or greater than the hourly fire rating of the wall assembly. The floor assembly shall include the following construction features:

A. **Steel Floor and Form Units*** — Max 3 in. (76 mm) deep galv fluted floor units.

B. **Concrete** — Min 2-1/2 in. (64 mm) thick reinforced (100-150 pcf or 1600-2400 kg/m³) concrete, as measured from the top plane of the floor units.

1A. **Roof Assembly** — As an alternate to Item 1, the fire-rated roof assembly shall be constructed of the materials and in the manner described in the individual P900 Series Roof-Ceiling Designs in the UL Fire Resistance Directory and shall contain max 3 in. (76 mm) deep galv steel fluted roof units. The hourly fire rating of the assembly shall be equal or greater than the hourly fire rating of the wall assembly. In the case of spray-applied protection materials in the steel roof units, the joint system shall be installed prior to the spray-applied protection material.

1B. **Floor Assembly** — As an alternate to Item 1, min 4-1/2 in. (114 mm) thick reinforced lightweight or normal weight (100-150 pcf or 1600-2400 kg/m³) structural concrete.

2. **Wall Assembly** — The 1 or 2 hr fire-rated gypsum board /steel stud wall assembly shall be constructed of the materials and in the manner described in the individual U400 and V400-Series Wall and Partition Design in the UL Fire Resistance Directory and shall include the following construction features:

A. **Light Gauge Framing* — Deflection Track** — Deflection track of wall assembly shall consist of min No. 25 gauge galv steel channels sized to accommodate steel studs (Item 2C) and with offset legs to accommodate wall cladding (Item 3A). Deflection track installed perpendicular to floor units. Min No. 25 gauge deflection track secured on both sides to valley of floor units with 1-1/2 in. (38 mm) long welds spaced max 12 in. (305 mm) OC. Min No. 20 gauge deflection track may be secured with steel fasteners spaced 12 in. (305 mm) OC.

FIRE TRAK CORP — Shadowline and Cavity Shadowline

B. **Light Gauge Framing*** — Clips are attached to the inside bottom leg of the ceiling runner (Item 2A) with 2 - No. 8 by 1/2 in. (13 mm)

3M Fire Protection Products

System No. HW-D-1020 *continued*

long steel self-drilling framing screws and engage the short flange of the studs.

FIRE TRAK CORP — Slip Clips or Redi Klips

C. **Studs** — Steel studs to be min 2-1/2 in. (64 mm) wide and as specified in the individual Wall and Partition Design in the UL Fire Resistance Directory. Studs cut 4 in. (102 mm) less in length than the assembly height with bottom nesting in and resting on floor runner and with top nesting in ceiling runner without attachment. Stud spacing not to exceed 24 in. (610 mm) OC.

D. **Gypsum Board*** — Gypsum board sheets installed and attached to studs and runners as specified in the individual Wall and Partition Design in the UL Fire Resistance Directory, except that a nominal 3-1/2 in. (89 mm) gap shall be maintained between top of the gypsum board and the bottom flange of the deflection track. Top row of screws shall be installed into the studs 13-1/2 in. (343 mm) below the top edge of the gypsum board sheets.

E. **Bracing** — (Not shown) Bracing as specified in the individual Wall and Partition Design in the UL Fire Resistance Directory. The hourly assembly rating of the joint is equal to the fire rating of the wall.

Firestop Configuration A and A1

3. **Joint System** — Max separation between bottom flange of the deflection track and top of gypsum board (at the time of installation of the joint system) is 1 in. (25 mm). The joint system is designed to accommodate a max 100 percent compression or extension from its installed width. The joint system consists of spray applied fire resistive material (Item 3A), and wall cladding (Item 3B), as follows:

A. **Wall Cladding** — Strips of the gypsum board material attached to the deflection track. The number of layers, board type and thickness and fastener type shall be as specified for the gypsum board in the individual Wall and Partition Design in the UL Fire Resistance Directory. Fasteners shall be max spaced 3 in. (76 mm) OC. The top of the wall cladding shall be flush with the valleys of the steel floor units and overlap the gypsum board 7 in. (178 mm) irectory. Fasteners shall be max spaced 3 in. (76 mm) OC. The top of the wall cladding shall be flush with the valleys of the steel floor units and overlap the gypsum board 7 in. (178 mm).

B. **Flute Fill** — The batt insulation and fill material are to be installed as specified in the Joint Systems in the table below:

| Manufacturer | Product Designation | System No. |
|--------------|---------------------|------------|
| 3M Company | FireDam™ Spray 200 | HW-D-0020 |

3M COMPANY — FireDam Spray 200

B1 **Fill, Void or Cavity Material*** — **Tape** — As an alternate to the 3M FireDam Spray 200 (see Item B), Tape cut to size and press applied over the mineral wool forming material in the flutes and lapping min 1 in. (25 mm) onto the contour of the steel floor units and gypsum wall. Tape applied in minimum 1 ft (305 mm) lengths along joint and adjoining lengths of Tape shall overlap min 1/2 in. (13 mm). Tape shall be applied at both sides of wall.

3M COMPANY — 3M Fire and Water Barrier Tape

Firestop Configuration B and B1

3. **Joint System** — Max separation between bottom flange of the deflection track and top of gypsum board (at the time of installation of the joint system) is 1 in. (25 mm). The joint system is designed to accommodate a max 100 percent compression or extension from its installed width. The joint system consists of spray applied fire resistive material (Item 3A), and wall cladding (Item 3B) as follows:

A. **Wall Cladding** — Strips of the gypsum board material attached to the deflection track. The number of layers, board type and thickness and fastener type shall be as specified for the gypsum board in the individual Wall and Partition Design in the UL Fire Resistance Directory. Fasteners shall be max spaced 3 in. (76 mm) OC. The top of the wall cladding shall be flush with the valleys of the steel floor units and overlap the gypsum board 7 in. (178 mm).

B. **Flute Fill** — The batt insulation and fill material are to be installed as specified in the Joint Systems in the table below:

| Manufacturer | Product Designation | System No. |
|--------------|---------------------|------------|
| 3M Company | FB 1000NS | HW-S-0028 |
| 3M Company | FB 2000 | HW-S-0002 |
| 3M Company | FB 2000+ | HW-S-0002 |

3M COMPANY — FB 1000NS, FB 2000, FB 2000+

* Indicates such products shall bear the UL or cUL Certification Mark for jurisdictions employing the UL or cUL Certification (such as Canada), respectively.



UL System No. HW-D-1059

December 16, 2016

ANSI/UL2079

Assembly Ratings – 1 and 2 Hr (See Item 2)
 Nominal Joint Width – 4 in.
 Class II Movement Capabilities – 25% Compression or Extension

CAN/ULC S115

F Ratings – 1 and 2 Hr (See Item 2)
 FT Ratings – 1 and 2 Hr (See Item 2)
 FH Ratings – 1 and 2 Hr (See Item 2)
 FTH Ratings – 1 and 2 Hr (See Item 2)
 Nominal Joint Width – 102 mm
 Class II Movement Capabilities – 25% Compression or Extension

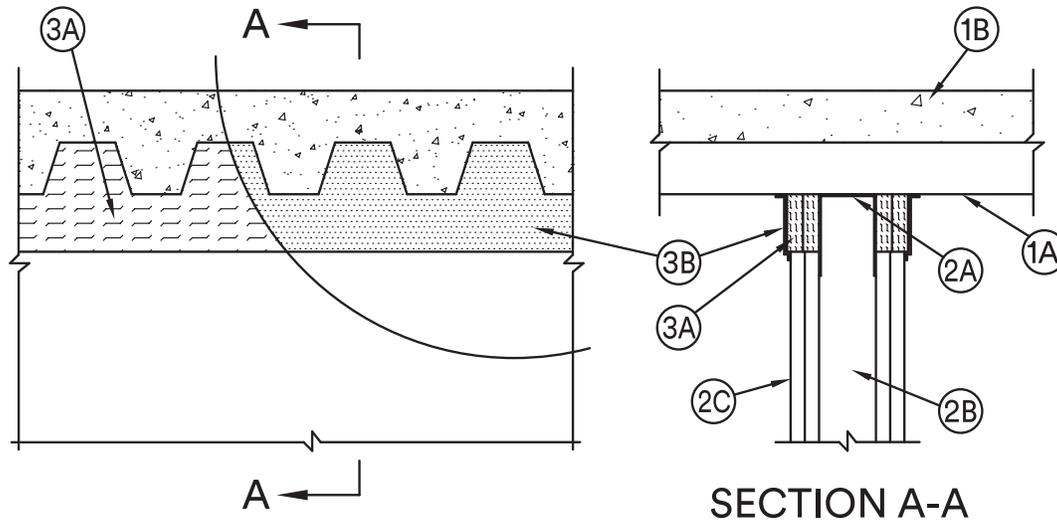

1. Floor Assembly – The fire-rated fluted steel deck/concrete floor assembly shall be constructed of the materials and in the manner described in the UL Fire Resistance Directory. The hourly fire rating of the floor assembly shall be equal to or greater than the hourly fire rating of the wall assembly. The floor assembly shall include the following construction features:

- A. Steel Floor and Floor Units*** – Max 3 in. (76 mm) deep galv steel fluted floor units.
- B. Concrete** – Min 2-1/2 in. (64 mm) thick reinforced concrete, as measured from the top plane of the floor units.

2. Wall Assembly – The 1 or 2 hr fire-rated gypsum board/steel stud wall assembly shall be constructed of the materials and in the manner described in the individual U400 or V400 Series Wall or Partition Design in the UL Fire Resistance Directory and shall include the following construction features:

- A. Steel Floor and Ceiling Runners** – Floor and ceiling runners of wall assembly shall consist of min 24 gauge galv steel channels sized to accommodate steel studs (Item 2B). Ceiling runner to be provided with flanges sized a min of 1-1/2 in. (38 mm) longer than the nom joint width. The ceiling runner is secured to steel floor units with steel fasteners or welds spaced max 24 in. (610 mm) OC.
- B. Studs** – Steel studs to be min 3-1/2 in. (89 mm) wide. Studs cut 1-1/4 in. (32 mm) to 1-1/2 in. (38 mm) less in length than assembly height with bottom nesting in and secured to floor runner. Studs to nest in ceiling runner without attachment.
- C. Gypsum Board*** – Gypsum board sheets installed to a min total 5/8 in. (16 mm) or 1-1/4 in. (32 mm) thickness on each side of wall for 1 and 2 hr fire rated assemblies, respectively. Wall to be constructed as specified in the individual U400 or V400 Series Design in the UL Fire Resistance Directory except that a max 4 in. (102 mm) gap shall be maintained between the top of the gypsum board and the bottom plane of the steel deck on both sides of wall assembly. For 1 hr fire rated walls, a min 4 in. wide strip of 5/8 in. thick gypsum board shall be installed flush with the top edge of the gypsum board along its entire length on both sides of the wall to create a nominal 1-1/4 in. wide ledge to support the bottom edge of the forming material (Item 3A). The screws attaching the gypsum board to the studs along the top of the wall shall be located 1-1/2 in. (38 mm) below the bottom of the ceiling runner. No gypsum board attachment screws shall be driven into the ceiling runner.

The hourly fire rating of the joint system is equal to the hourly fire rating of the wall.

3. Joint System – Max separation between bottom plane of steel floor unit and top of gypsum board (at time of installation of joint system) is 4 in. (102 mm). The joint system is designed to accommodate a max 25 percent compression or extension from its installed width as measured between the bottom plane of the steel floor unit and the top of the gypsum board. The joint system shall consist of forming and fill materials, as follows:

- A. Forming Material*** – Nom 8 pcf (128 kg/m³) mineral wool batt insulation. Sections of mineral wool batt cut to a width equal to the thickness of the wall assembly at its top edge and tightly packed into the areas of the fluted deck above the ceiling runner, flush with both surfaces of wall. Additional 1-1/2 in. wide by 2 in. (51 mm) thick sections of nom 8 pcf (128 kg/m³) mineral wool batt insulation are compressed 37 percent in the thickness direction and installed to completely fill the gap above the top of the gypsum board on both sides of the wall. As an option for the 1 hr assembly rating, nom 4 pcf (64 kg/m³) density mineral wool batt insulation may be used in the gap above the top of the gypsum board.

ROCK WOOL MANUFACTURING CO – Delta 8

ROCKWOOL MALAYSIA SDN BHD – SAFE

ROXUL INC – SAFE

Construction Joints

Head of Wall

HWD

UL System No. HW-D-1059 (cont.)

Construction Joints

B. Fill, Void or Cavity Material* – Sealant – Min 1/8 in. (3.2 mm) wet thickness or 1/16 in. (1.6 mm) dry thickness of fill material spray applied over the forming material on each side of the wall. Fill material to overlap a min of 1/2 in. (13 mm) onto the gypsum board and a min 1 in. (25 mm) onto the steel floor unit on each side of the wall.

3M COMPANY – FireDam™ Spray 200

B1. Fill, Void or Cavity Material* – Tape – As an alternate to Item B, Tape cut to size and press applied within fluted areas of joint to completely cover mineral wool lapping min 1 in. (25 mm) onto the contour of the steel floor units and extending to lap min 1 in. (25 mm) onto the gypsum wall. Additional pieces of Tape are applied along the joint to completely cover the remaining mineral wool between bottom of steel deck and top edge of wall along length of joint, lapping min 1 in. (25 mm) onto the contour of the steel floor units and min 1 in. (25 mm) onto the gypsum wall. Adjoining lengths of Tape shall overlap min 1/2 in. (13 mm). Tape shall be applied at both sides of wall.

3M COMPANY – 3M Fire and Water Barrier Tape

*Indicates such products shall bear the UL or cUL Certification Mark for jurisdictions employing the UL or cUL Certification (such as Canada), respectively.



Reprinted from the Online Certifications Directory with permission from UL©

Head of Wall

HW-D

UL System No. HW-D-1079

December 16, 2016

ANSI/UL2079

Assembly Rating – 2 Hr
Nominal Joint Width – 4 in.
Class II Movement Capabilities – 19% Compression or Extension

CAN/ULC S115

F Rating – 2 Hr
FT Rating – 2 Hr
FH Rating – 2 Hr
FTH Rating – 2 Hr
Nominal Joint Width – 102 mm
Class II Movement Capabilities – 19% Compression or Extension

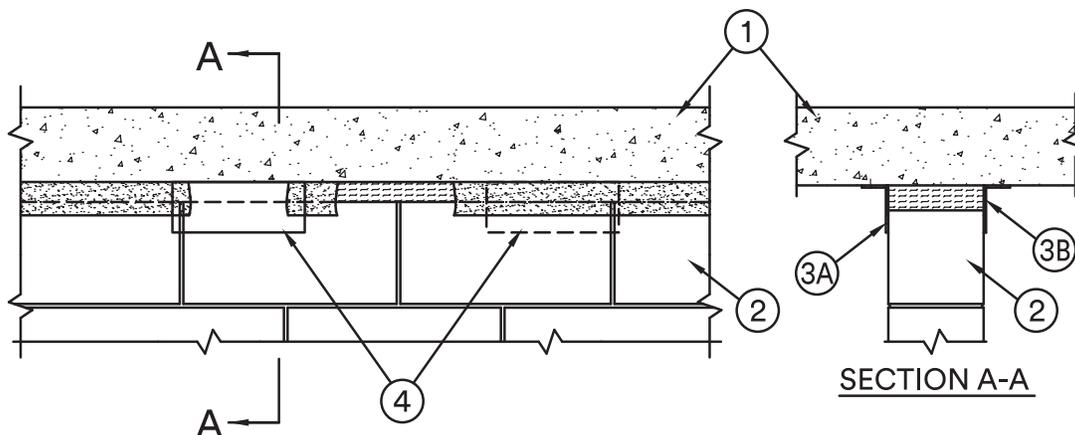

1. **Floor Assembly** – Min 4-1/2 in. (114 mm) thick steel-reinforced lightweight or normal weight (100-150 pcf or 1600-2400 kg/m³) structural concrete.
2. **Wall Assembly** – Min 7-1/2 in. 191 mm) thick lightweight or normal weight (100-150 pcf or 1600-2400 kg/m³) concrete. Wall may also be constructed of any UL Classified **Concrete Blocks**.
See **Concrete Blocks** (CAZT) category in the Fire Resistance Directory for names of manufacturers.
3. **Joint System** – Max separation between bottom of floor and top of wall is 4 in. (102 mm). The joint system is designed to accommodate a max 19 percent compression or extension from its installed width. The joint system consists of a forming material and a fill material, as follows:
 - A. **Forming Material*** – Min 4 pcf (64 kg/m³) mineral wool batt insulation compressed and firmly packed into the gap between the top of the wall and bottom of the floor on both sides of the wall. Sections of min 3 in. (76 mm) wide strips of batts to be stacked on top of each other to form an overall thickness two times the thickness of the nominal joint width and installed edge-first such that the batt sections are compressed min 50 percent and installed flush with both surfaces of wall.
INDUSTRIAL INSULATION GROUP LLC – MinWool-1200 Safing
JOHNS MANVILLE – Safing
ROCK WOOL MANUFACTURING CO – Delta Safing Board
ROCKWOOL MALAYSIA SDN BHD – Type Safe
ROXUL INC – Type Safe
THERMAFIBER INC – Type SAF
 - B. **Fill, Void or Cavity Material*** – Min 1/16 in. (1.6 mm) dry thickness (min 1/8 in. or 3.2 mm wet thickness) of fill material sprayed or brushed on each side of the wall between the top of the wall and the bottom of the floor to completely cover mineral wool and overlap a min of 1/2 in. (13 mm) onto wall and floor on both sides of wall.
3M COMPANY
3M FIRE PROTECTION PRODUCTS – FireDam™ Spray 200
 - B1. **Fill, Void or Cavity Material* – Tape** – As an alternate to Item B, Tape cut to size and press applied to completely cover mineral wool forming material and lapping min 1 in. (25 mm) onto the contour of the steel floor units and extending to lap min 1 in. (25 mm) onto the concrete block wall. Tape to be applied in minimum 1 ft (305 mm) lengths along the joint and adjoining lengths of Tape shall overlap min 1/2 in. (13 mm). Tape shall be applied at both sides of wall.
3M COMPANY – 3M Fire and Water Barrier Tape
4. **Steel Angles** (optional) – Nom 5 × 3 in. (127x 76mm) (or larger) by 12 MSG (or heavier) steel angles. Nom 3 in. (76 mm) leg secured to ceiling, on both sides of wall, with steel fasteners. Angles can consist of intermittent or continuous lengths. Intermittent lengths can be random or evenly spaced.

*Indicates such products shall bear the UL or cUL Certification Mark for jurisdictions employing the UL or cUL Certification (such as Canada), respectively. 

Reprinted from the Online Certifications Directory with permission from UL©

Construction Joints

Head of Wall

HWD

UL System No. HW-D-1080

March 21, 2017

ANSI/UL2079

Assembly Rating – 2 Hr
Nominal Joint Width – 4 in.
Class II Movement Capabilities – 19% Compression or Extension

CAN/ULC S115

F Rating – 2 Hr
FT Rating – 2 Hr
FH Rating – 2 Hr
FTH Rating – 2 Hr
Nominal Joint Width – 102 mm
Class II Movement Capabilities – 19% Compression or Extension

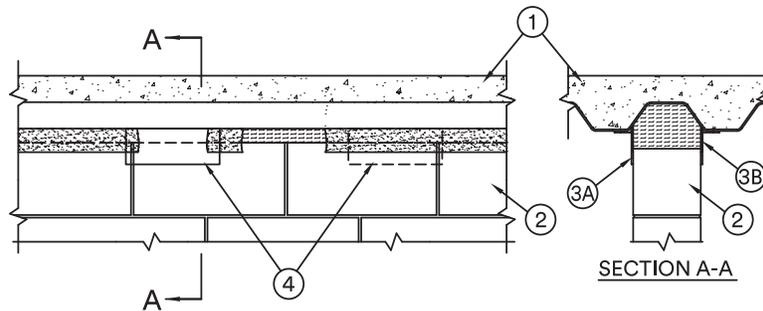

- 1. Floor Assembly** — The fire-rated fluted steel deck/concrete floor assembly shall be constructed of the materials and in the manner described in the individual D900 Series Floor-Ceiling Design in the UL Fire Resistance Directory and shall include the following construction features:
 - A. Steel Floor and Form Units*** – Max 3 in. (76 mm) deep galv steel fluted floor units.
 - B. Concrete** – Min 2-1/2 in. (64 mm) thick reinforced concrete, as measured from the top plane of the floor units.
- 1A. Roof Assembly** (not shown) – As an alternate to the floor assembly, a fire rated fluted steel deck roof assembly may be used. The roof assembly shall be constructed of the materials and in the manner described in the individual P900 Series Roof-Ceiling Design in the UL Fire Resistance Directory. The hourly rating of the roof assembly shall be equal to or greater than the hourly rating of the wall assembly. The roof assembly shall include the following construction features:
 - A. Steel Roof Deck** – Max 3 in. (76 mm) deep galv steel fluted roof deck.
 - B. Roof Insulation** – Min 2-1/4 in. (57 mm) thick poured insulating concrete, as measured from the top plane of the steel roof deck
- 2. Wall Assembly** – Min 7-1/2 in. (191 mm) thick lightweight or normal weight (100-150 pcf or 1600-2400 kg/m³) concrete, running parallel to the deck fluts. Wall may also be constructed of any UL Classified **Concrete Blocks**.
See **Concrete Blocks** (CAZT) category in the Fire Resistance Directory for names of manufacturers.
- 3. Joint System** – Max separation between bottom of floor and top of wall is 4 in. (102 mm). The joint system is designed to accommodate a max 19 percent compression or extension from its installed width. The joint system consists of a forming material and a fill material, as follows:
 - A. Forming Material*** – Min 4 pcf (64 kg/m³) mineral wool batt insulation compressed and firmly packed into the gap between the top of the wall and bottom of the floor on both sides of the wall, and filling the crest of the deck. Sections of min 3 in. (76 mm) wide strips of batts to be stacked on top of each other to form an overall thickness two times the thickness of the nominal joint width and installed edge-first such that the batt sections are compressed min 50 percent and installed flush with both surfaces of wall.
INDUSTRIAL INSULATION GROUP LLC – MinWool-1200 Safing
JOHNS MANVILLE – Safing
ROCK WOOL MANUFACTURING CO – Delta Safing Board
ROCKWOOL MALAYSIA SDN BHD – Type Safe
ROXUL INC – Type Safe
THERMAFIBER INC – Type SAF
 - B. Fill, Void or Cavity Material*** – Min 1/16 in. (1.6 mm) dry thickness (min 1/8 in. or 3.2 mm wet thickness) of fill material sprayed or brushed on each side of the wall between the top of the wall and the bottom of the floor to completely cover mineral wool and overlap a min of 1/2 in. (13 mm) onto wall and floor on both sides of wall.
3M COMPANY
3M FIRE PROTECTION PRODUCTS — FireDam™ Spray 200
 - B1. Fill, Void or Cavity Material*** – Tape – As an alternate to Item B, Tape cut to size and press applied to completely cover mineral wool forming material and lapping min 1 in. (25 mm) onto the contour of the steel floor units and the concrete wall. Tape to be applied in minimum 1 ft (305 mm) lengths along the joint and adjoining lengths of Tape shall overlap min 1/2 in. (13 mm). Tape shall be applied at both sides of wall.
3M COMPANY
3M COLUMBIA PLANT – 3M Fire and Water Barrier Tape
- 4. Steel Angles** (optional) – Nom 5 × 3 in. (127 × 76 mm) (or larger) by 12 MSG (or heavier) steel angles. Nom 3 in. (76 mm) leg secured to ceiling, on both sides of wall, with steel fasteners. Angles can consist of intermittent or continuous lengths. Intermittent lengths can be random or evenly spaced.

*Indicates such products shall bear the UL or cUL Certification Mark for jurisdictions employing the UL or cUL Certification (such as Canada), respectively. 
Reprinted from the Online Certifications Directory with permission from UL©



UL System No. HW-D-1123
XHBN - Joint Systems
XHBN7 - Joint Systems Certified for Canada

November 07, 2017

| ANSI/UL2079 | CAN/ULC S115 |
|---|---|
| Assembly Rating – 2 Hr | F Rating – 2 Hr |
| Nominal Joint Width – 4 In. | FT Rating – 2 Hr |
| Class II Movement Capabilities – 19% Compression or Extension | FH Rating – 2 Hr |
| | FTH Rating – 2 Hr |
| | Nominal Joint Width – 102 mm |
| | Class II Movement Capabilities – 19% Compression or Extension |

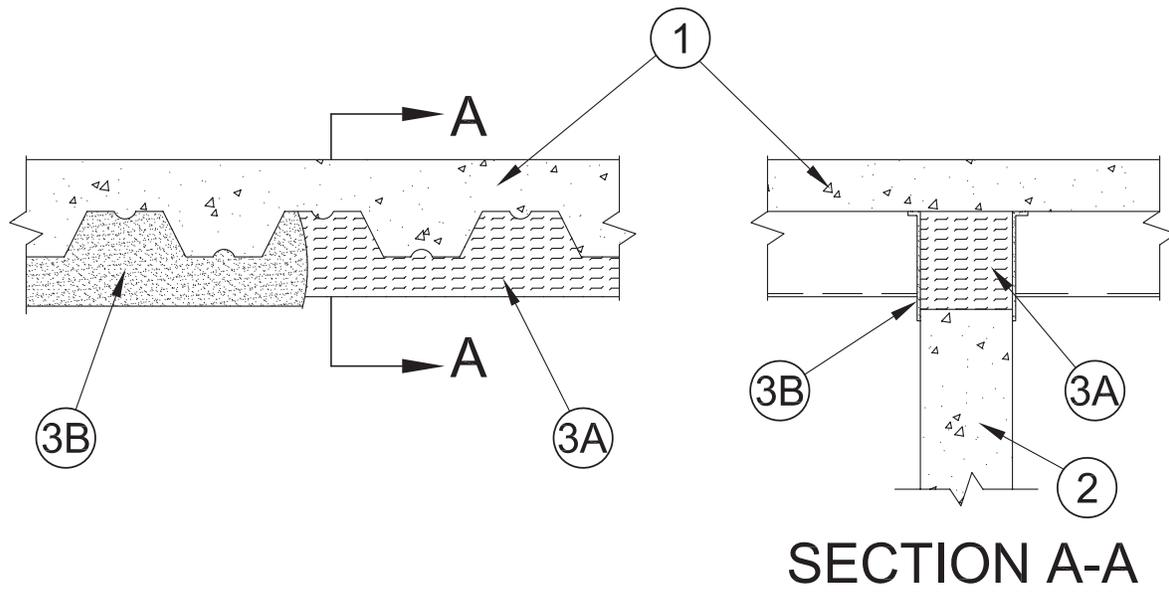

- 1. Floor Assembly** – The fire-rated fluted steel deck/concrete floor assembly shall be constructed of the materials and in the manner described in the individual D900 Series Floor-Ceiling Design in the UL Fire Resistance Directory and shall include the following construction features:
 - A. Steel Floor and Form Units*** – Max 3 in. (76 mm) deep galv steel fluted floor units.
 - B. Concrete** – Min 2-1/2 in. (64 mm) thick reinforced concrete, as measured from the top plane of the floor units.
- 1A. Roof Assembly** – (Not Shown) – As an alternate to the floor assembly, a fire rated fluted steel deck roof assembly may be used. The roof assembly shall be constructed of the materials and in the manner described in the individual P900 Series Roof-Ceiling Design in the UL Fire Resistance Directory. The hourly rating of the roof assembly shall be equal to or greater than the hourly rating of the wall assembly. The roof assembly shall include the following construction features:
 - A. Steel Roof Deck** – Max 3 in. (76 mm) deep galv steel fluted roof deck.
 - B. Roof Insulation** – Min 2-1/4 in. (57 mm) thick poured insulating concrete, as measured from the top plane of the steel roof deck.
- 2. Wall Assembly** – Min 7-1/2 in. 191 mm) thick lightweight or normal weight (100-150 pcf or 1600-2400 kg/m³) concrete, running perpendicular to the deck flutes. Wall may also be constructed of any UL Classified Concrete Blocks.
 See **Concrete Blocks** (CAZT) category in the Fire Resistance Directory for names of manufacturers.
- 3. Joint System** – Max separation between bottom of floor and top of wall is 4 in. (102 mm). The joint system is designed to accommodate a max 19 percent compression or extension from its installed width. The joint system consists of a forming material and a fill material, as follows:
 - A. Forming Material*** – Nom 4 pcf (64 kg/m³) mineral wool batt cut to the shape of the steel deck flute with a height 1 in. (25 mm) greater than the height of flutes and with a length equal to the overall thickness of the wall assembly. Mineral wool batt compressed and installed into each flute above the wall with its ends projecting flush with the wall surfaces. Additional pieces of min 4 pcf (64 kg/m³) density mineral wool batt cut to a width equal to the overall thickness of the wall and with a thickness equal to twice the height of the gap between the top of the wall and the valleys of the steel deck floor. Insulation compressed 50 percent in thickness and inserted between the top of the wall and the bottom of the floor, flush with both sides of the wall.

INDUSTRIAL INSULATION GROUP LLC – MinWool-1200 Safing

JOHNS MANVILLE – Safing

ROCK WOOL MANUFACTURING CO – Delta Board

ROCKWOOL MALAYSIA SDN BHD – Type Safe

ROCKWOOL – Type Safe

THERMAFIBER INC – Type SAF

- B. Fill, Void or Cavity Material*** – Min 1/16 in. (1.6 mm) dry thickness (min 1/8 in. or 3.2 mm wet thickness) of fill material sprayed or brushed on each side of the wall between the top of the wall and the bottom of the floor to completely cover mineral wool and overlap a min of 1/2 in. (13 mm) onto wall and floor on both sides of wall.

3M COMPANY 3M FIRE PROTECTION PRODUCTS – FireDam™ Spray 200

- B1. Fill, Void or Cavity Material* – Tape** – As an alternate to Item B, Tape cut to size and press applied to completely cover mineral wool forming material and lapping min 1 in. (25 mm) onto the contour of the steel floor units and the concrete wall. Tape to be applied in minimum 1 ft (305 mm) lengths along the joint and adjoining lengths of Tape shall overlap min 1/2 in. (13 mm). Tape shall be applied at both sides of wall.

3M COMPANY 3M FIRE PROTECTION PRODUCTS – 3M Fire and Water Barrier Tape

- 4. Steel Angles** – (Optional, not shown) – Nom 5 in. by 3 in. (127 mm by 76 mm) (or larger) by 12 MSG (or heavier) steel angles. Nom 3 in. (76 mm) leg secured to ceiling, on both sides of wall, with steel fasteners. Angles can consist of intermittent or continuous lengths. Intermittent lengths can be random or evenly spaced.

Construction Joints

Head of Wall

HWD



*Indicates such products shall bear the UL or cUL Certification Mark for jurisdictions employing the UL or cUL Certification (such as Canada), respectively.

Reprinted from the Online Certifications Directory with permission from UL©



System No. HW-D-1126
XHBN - Joint Systems
XHBN7 - Joint Systems Certified for Canada

May 16, 2018

| ANSI/UL2079 | CAN/ULC S115 |
|---|---|
| Assembly Rating – 2 Hr | F Rating – 2 Hr |
| Nominal Joint Width – 4 In. | FT Rating – 2 Hr |
| Class II Movement Capabilities – 19% Compression or Extension | FH Rating – 2 Hr |
| L Rating at Ambient – Less than 1 CFM/Lin Ft | FTH Rating – 2 Hr |
| L Rating at 400°F – Less than 1 CFM/Lin Ft | Nominal Joint Width – 102 mm |
| | Class II Movement Capabilities – 19% Compression or Extension |
| | L Rating at Ambient – Less than 1.55 L/s/m |
| | L Rating at 204°C – Less than 1.55 L/s/m |

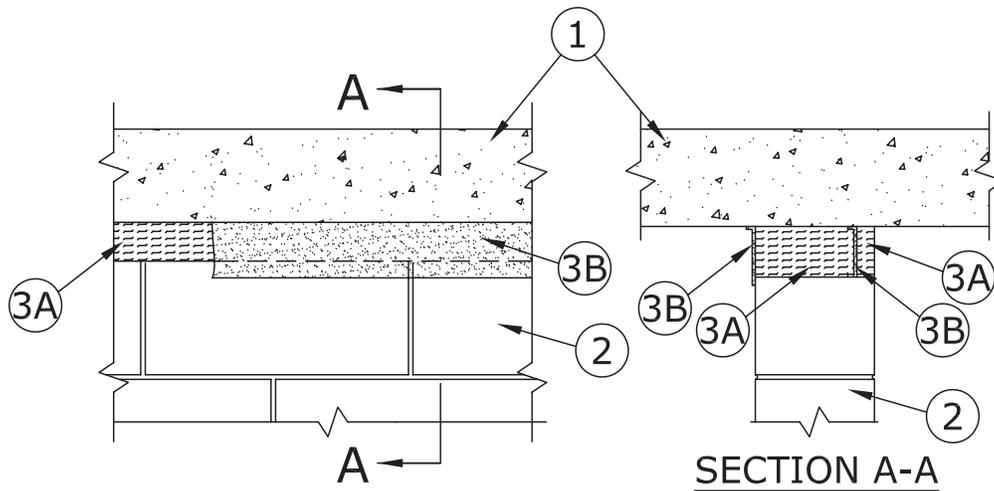

- Floor Assembly** — Min 4-1/2 in. (114 mm) thick steel-reinforced lightweight or normal weight (100-150 pcf or 1600-2400 kg/m³) structural concrete.
- Wall Assembly** — Min 7-1/2 in. (191 mm) thick lightweight or normal weight (100-150 pcf or 1600-2400 kg/m³) concrete. Wall may also be constructed of any UL Classified **Concrete Blocks**.
See **Concrete Blocks** (CAZT) category in the Fire Resistance Directory for names of manufacturers.
- Joint System** — Max separation between bottom of floor and top of wall is 4 in. (102 mm). The joint system is designed to accommodate a max 19 percent compression or extension from its installed width. The joint system consists of a forming material and a fill material, as follows:
 - Forming Material*** — Min 4 pcf (64 kg/m³) mineral wool batt insulation compressed and firmly packed into the gap between the top of the wall and bottom of the floor. The strips and shaped pieces of mineral wool batt insulation installed on the inaccessible side of the wall are to be 1 in. to 2 in. (25 to 51 mm) wide and are to be installed edge-first such that the batt sections are compressed min 50 percent, flush with the inaccessible surface of the wall. After application of the sealant (Item 3B) on the surface of the mineral wool batt packing material above the top plane of the wall, additional strips of the mineral wool batt insulation are to be installed to fill the remainder of the joint opening above the wall, flush with the accessible surface of the wall. Sections of strips of batts to be stacked on top of each other to form an overall thickness two times the thickness of the nominal joint width and installed edge-first such that the batt sections are compressed min 50 percent.

INDUSTRIAL INSULATION GROUP L L C — MinWool-1200 Safing

JOHNS MANVILLE — Safing

ROCK WOOL MANUFACTURING CO — Delta Safing Board

ROCKWOOL MALAYSIA SDN BHD — Type Safe

ROCKWOOL — Type Safe

THERMAFIBER INC — Type SAF

B. Fill, Void or Cavity Material* — Sealant — Min 1/8 in. (3.2 mm) wet thickness or 1/16 in. (1.6 mm) dry thickness of fill material spray applied over the forming material. The fill material sprayed on the nom 1 in. to 2 in. (25 to 51 mm) thickness of forming material located on the inaccessible side of the wall is to lap a min of 1 in. (25 mm) onto the floor and onto the top surface of the wall. The fill material sprayed on the forming material on the accessible side of the wall is to overlap a min of 1/2 in. (13 mm) onto the floor and wall.

3M COMPANY 3M FIRE PROTECTION PRODUCTS — FireDam™ Spray 200

* Indicates such products shall bear the UL or cUL Certification Mark for jurisdictions employing the UL or cUL Certification (such as Canada), respectively.



System No. HW-S-0002

March 07, 1996

Assembly Ratings – 1 & 2 Hr (See Item 2)

L Rating – At Ambient Less Than 1 CFM/Lin Ft (See Item 3B)

L Rating At 400 F – Less Than 1 CFM/Lin Ft (See Item 3B)

Joint Width – 1 In. Max

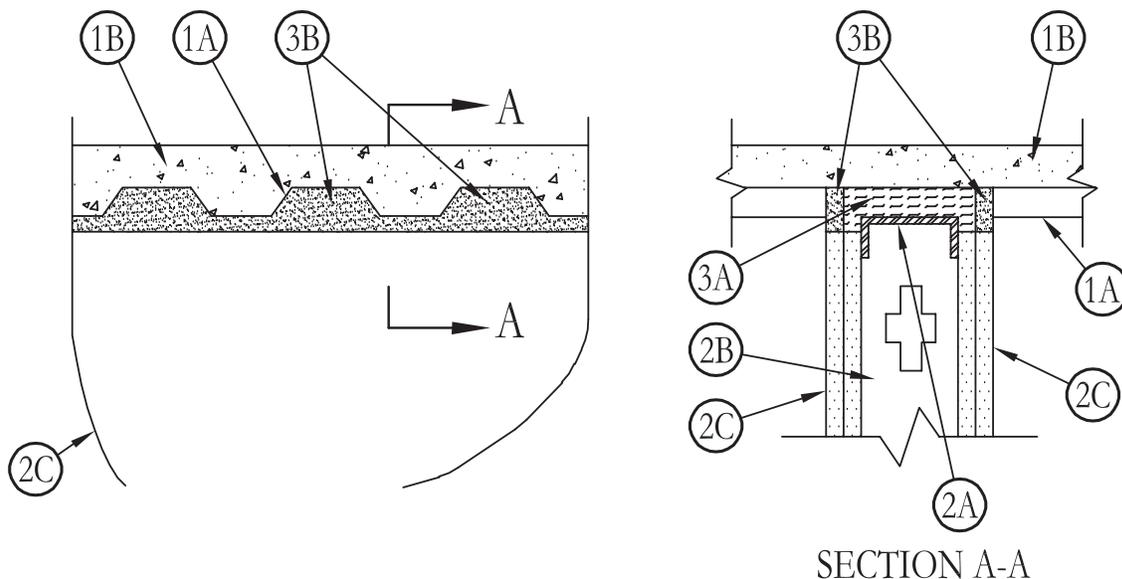

- Floor Assembly** – The fire-rated fluted steel deck/concrete floor assembly shall be constructed of the materials and in the manner described in the individual Floor-Ceiling Design in the UL Fire Resistance Directory and shall include the following construction features:
 - Steel Floor And Form Units*** – Max 3 in. deep galv or phos/painted fluted units.
 - Concrete** – Min 3 in. thick reinforced concrete, as measured from the top plane of the fluted units.
- Wall Assembly** – The 1 or 2 hr fire rated gypsum wallboard/steel stud wall assembly shall be constructed of the materials and in the manner described in the individual U400-Series Wall or Partition Design in the UL Fire Resistance Directory and shall include the following construction features:
 - Steel Floor And Ceiling Runners** – Floor and ceiling runners of wall assembly shall consist of min 25 gauge galv steel channels sized to accommodate steel studs (Item 2B). Ceiling runner to be provided with min 1-1/4 in. flanges. Ceiling runner secured to valleys of steel floor units (Item 1A) with steel fasteners or by welds spaced max 24 in. OC.
 - Studs** – Steel studs to be min 3-5/8 in. wide. Studs cut 1 in. less in length than assembly height with bottom nesting in and resting on floor runner and with top nesting in ceiling runner without attachment. Stud spacing not to exceed 24 in. OC.
 - Gypsum Board*** – Wallboard sheets installed to a min total thickness of 1/2 or 1 in. on each side of wall for a 1 or 2 hr fire rated wall, respectively. Wall to be constructed as specified in the individual Wall and Partition Design in the UL Fire Resistance Directory, except that a nom 1 in. gap shall be maintained between the top of the wallboard and the bottom of the steel floor units and the top row of screws shall be installed into the studs 1-3/4 in. below the valleys of the steel floor units. The hourly fire rating of the joint system is equal to the hourly fire rating of the wall.
- Joint System** – Max separation between bottom of floor and top of wall is 1 in. The joint system consists of a forming material and a fill material in the flutes of the steel floor units and between the top of the wallboard and bottom of the steel floor units, as follows:
 - Packing Material** – For 1 or 2 Hr Rated Designs, a 3-1/2 in. or 4-1/2 in. thickness, respectively, of min 4 pcf density mineral wool batt insulation is firmly packed into flutes of the steel floor units and between the top of the wallboard and bottom of the steel floor units, and recessed from each surface of wall to accommodate the required thickness of fill material.
 - Fill, Void or Cavity Material*** – Min 1/2 in. thickness of fill material installed on each side of the wall in the flutes of the steel floor units and between the top of the wallboard and the bottom of the steel floor units (concrete floor), flush with each surface of wallboard.
3M COMPANY – FB-2000 or FB-2000+. (Note: L Ratings apply only when FB-2000+ is used)

*Bearing the UL Classification Marking

Reprinted from the Online Certifications Directory with permission from Underwriters Laboratories Inc.
Copyright © 2010 Underwriters Laboratories Inc.®



System No. HW-S-0003

September 08, 2004
 Assembly Ratings – 1 & 2 Hr (See Item 2)
 Joint Width – 1 In. Max

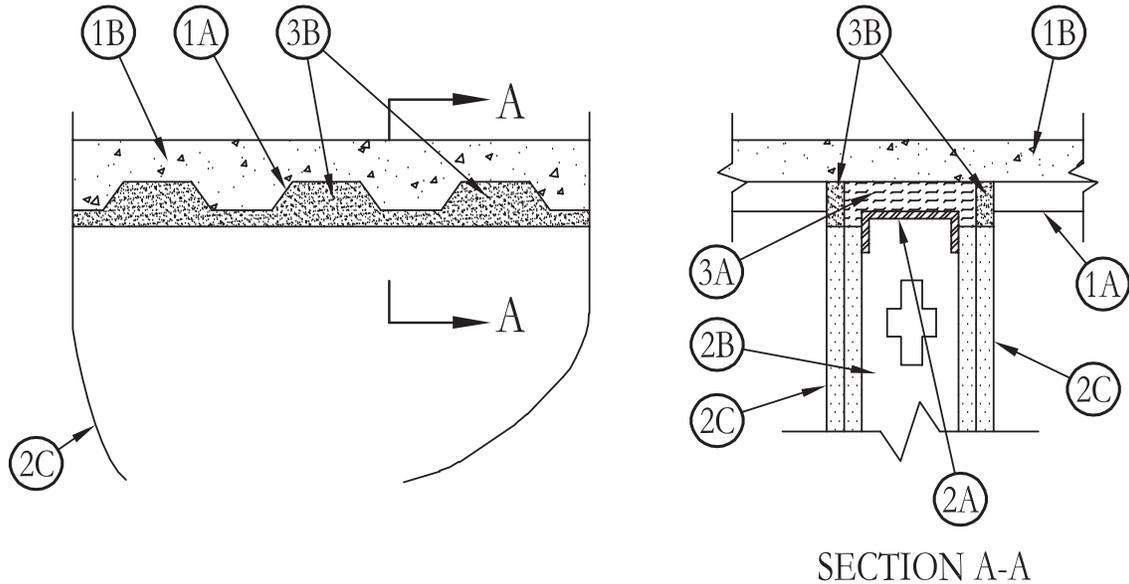

SECTION A-A

1. **Floor Assembly** – The fire-rated fluted steel deck/concrete floor assembly shall be constructed of the materials and in the manner described in the individual Floor-Ceiling Design in the UL Fire Resistance Directory and shall include the following construction features:
 - A. **Steel Floor And Form Units*** – Max 1-1/2 in. deep galv or phos/painted fluted units.
 - B. **Concrete** – Min 3 in. thick reinforced concrete, as measured from the top plane of the floor units.
2. **Wall Assembly** – The 1 or 2 hr fire rated gypsum wallboard/steel stud wall assembly shall be constructed of the materials and in the manner described in the individual U400-Series Wall or Partition Design in the UL Fire Resistance Directory and shall include the following construction features:
 - A. **Steel Floor And Ceiling Runners** – Floor and ceiling runners of wall assembly shall consist of min 25 gauge galv steel channels sized to accommodate steel studs (Item 2B). Ceiling runner to be provided with min 1-1/4 in. flanges. Ceiling runner secured to valleys of steel floor units (Item 1A) with steel fasteners or by welds spaced max 24 in. OC.
 - B. **Studs** – Steel studs to be min 3-5/8 in. wide. Studs cut 1 in. less in length than assembly height with bottom nesting in and resting on the floor runner and with top nesting in ceiling runner without attachment. Stud spacing not to exceed 24 in. OC.
 - C. **Gypsum Board*** – Wallboard sheets installed to a min total thickness of 1/2 or 1 in. on each side of wall for a 1 or 2 hr fire rated wall, respectively. Wall to be constructed as specified in the individual Wall and Partition Design in the UL Fire Resistance Directory, except that a nom 1 in. gap shall be maintained between the top of the wallboard and the bottom of the steel floor units and the top row of screws shall be installed into the studs 1-3/4 in. below the valleys of the steel floor units. The hourly fire rating of the joint system is equal to the hourly fire rating of the wall.
3. **Joint System** – Max separation between bottom of floor and top of wall is 1 in. The joint system consists of a forming material and a fill material in the flutes of the steel floor units and between the top of the wallboard and bottom of the steel floor units, as follows:
 - A. **Packing Material** – For 1 or 2 Hr Rated Designs, a 3-1/2 in. or 4-1/2 in. thickness, respectively, of min 4 pcf density mineral wool batt insulation is firmly packed into flutes of the steel floor units and between the top of the wallboard and bottom of the steel floor units, and recessed from each surface of wall to accommodate the required thickness of fill material.
 - B. **Fill, Void or Cavity Material* – Caulk or Sealant** – Min 1/2 in. thickness of fill material installed on each side of the wall in the flutes of the steel floor units and between the top of the wallboard and the bottom of the steel floor units (concrete floor), flush with each surface of wallboard.

3M COMPANY – CP 25WB+ caulk or FB-3000 WT sealant

*Bearing the UL Classification Marking

Reprinted from the Online Certifications Directory with permission from Underwriters Laboratories Inc.
 Copyright © 2010 Underwriters Laboratories Inc.®



System No. HW-S-0004

September 08, 2004

Assembly Ratings – 1 & 2 Hr (See Items 2, 3B & 3C)

Joint Width – 1 In. Max

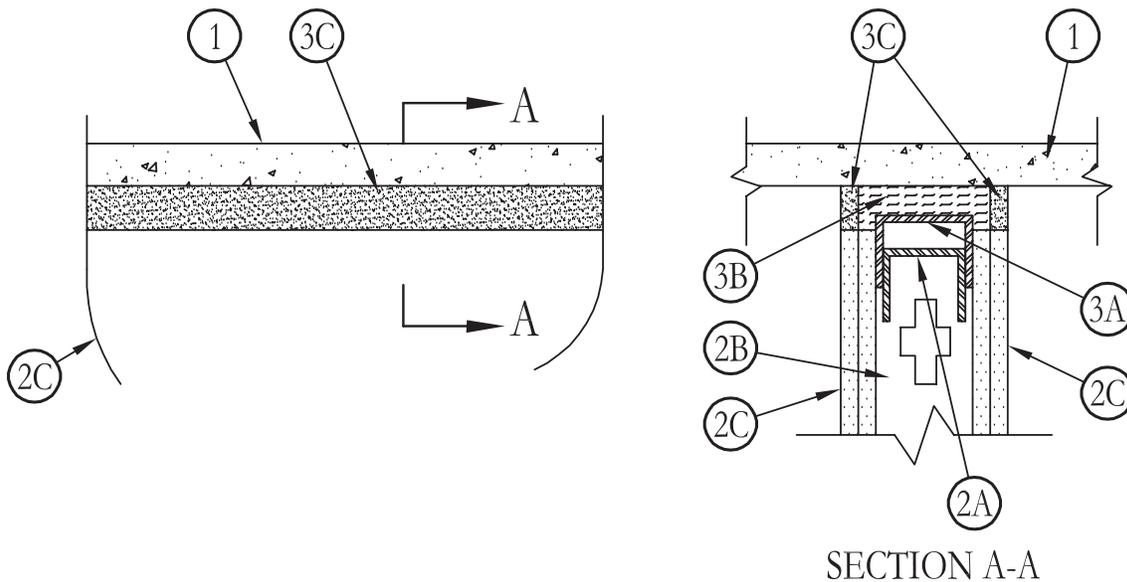

- Floor Assembly** – Min 4-1/2 in. thick steel-reinforced lightweight or normal weight (100-150 pcf) structural concrete.
- Wall Assembly** – The 1 or 2 hr fire rated gypsum wallboard/stud wall assembly shall be constructed of the materials and in the manner described in the individual U400-Series Wall or Partition Design in the UL Fire Resistance Directory and shall include the following construction features:
 - Steel Floor And Ceiling Runners** – Top and bottom runners of wall assembly shall consist of min 3-5/8 in. wide by 3 in. deep corrosion protected min 25 MSG steel channels. Floor runner secured with steel fasteners spaced max 24 in. O.C. The ceiling runner is installed within the u-shaped deflection plate (item 3A) with a nom 1 in. gap is maintained between the top of the ceiling runner and the top of the deflection plate.
 - Studs** – Min 3-5/8 in. wide by 1-1/4 in. deep corrosion protected min 25 MSG steel channels. Steel stud spacing not to exceed 24 in. O.C.
 - Gypsum Board*** – 5/8 in. thick, 4 ft wide with square or tapered edges. Wallboard sheets installed vertically on both sides of stud framing with joints centered over studs. A max 1 in. gap is maintained between the top of the wallboard and the bottom of the concrete floor. The gypsum wallboard type, thickness, number of layers and fastener types shall be as specified in the individual U400-Series Design in the UL Fire Resistance Directory.
- Joint System** – Max separation between bottom of floor and top of wall is 1 in. The joint system consists of a deflection plate, packing material and caulk, as follows:
 - Deflection Plate** – A nom 4 in. wide by 3 in. deep, min 24 gauge steel u-shaped channel. The deflection plate is attached to the concrete floor with masonry anchors at a max 24 in. O.C. The steel ceiling runner (item 2A) is installed within the deflection plate to maintain a nom 1 in. gap between the top of the ceiling runner and the top of the deflection plate. The ceiling runner is not fastened to the deflection plate.
 - Packing Material** – The following packing materials are used:
 - Mineral Wool** – A 1 in. thickness by 4 in. wide section of min 4 pcf density mineral wool batt insulation is fitted into the 1 in. gap within the deflection plate between the top of the ceiling runner and the deflection plate.
 - Polyethylene Backer Rod** (2 hr rated system only) – A nom 1-1/4 in. diam polyethylene backer rod friction-fitted into the gap between the top of the gypsum wallboard and the bottom of the concrete deck on both sides of the wall and recessed from each surface of wall to accommodate the required thickness of fill material.
 - Fill, Void or Cavity Material* – Caulk or Sealant** – A min 5/8 in. thickness of fill material for 1 hr rated systems and a min 1/2 in. thickness of fill material for 2 hr rated systems installed on each side of the wall between the top of the wallboard and bottom of the concrete floor.
3M COMPANY – CP 25WB+ caulk or FB-3000 WT sealant

*Bearing the UL Classification Mark

Reprinted from the Online Certifications Directory with permission from Underwriters Laboratories Inc.

Copyright © 2010 Underwriters Laboratories Inc.®



System No. HW-S-0005

May 09, 2013

ANSI/UL2079

Assembly Ratings – 1 and 2 Hr (See Items 2, 3B and 3C)

Nominal Joint Width – 1 In.

CAN/ULC S115

F Ratings – 1 and 2 Hr (See Items 2, 3B and 3C)

FT Ratings – 1 and 2 Hr (See Items 2, 3B and 3C)

FH Ratings – 1 and 2 Hr (See Items 2, 3B and 3C)

FTH Ratings – 1 and 2 Hr (See Items 2, 3B and 3C)

Nominal Joint Width – 1 In.

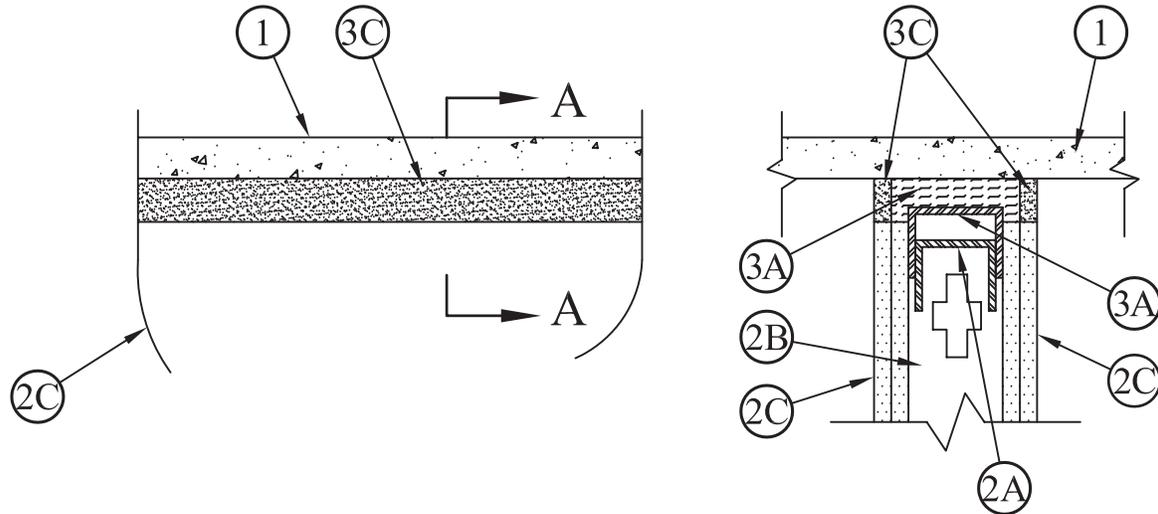
**SECTION A-A**

1. **Floor Assembly** – Min 4-1/2 in. (114 mm) thick steel-reinforced lightweight or normal weight (100-150 pcf or 1600-2400 kg/m³) structural concrete.
2. **Wall Assembly** – The 1 or 2 hr fire rated gypsum wallboard/stud wall assembly shall be constructed of the materials and in the manner described in the individual U400-Series Wall or Partition Design in the UL Fire Resistance Directory and shall include the following construction features:
 - A. **Steel Floor And Ceiling Runners** – Top and bottom runners of wall assembly shall consist of min 3-5/8 in. (92 mm) wide by 3 in. (76 mm) deep corrosion protected min 25 MSG steel channels. Floor runners secured with steel fasteners spaced max 24 in. (610 mm) O.C. The ceiling runners are installed within the U-shaped deflection plate (Item 3A) with a nom 1 in. (25 mm) gap is maintained between the top of the ceiling runners and the top of the deflection plate.
 - B. **Studs** – 3-5/8 in. (92 mm) wide by 1-1/4 in. (32 mm) deep corrosion protected min 25 MSG steel channels. Steel stud spacing not to exceed 24 in. (610 mm) O.C.
 - C. **Gypsum Board*** – 5/8 in. (16 mm) thick, 4 ft (1219 mm) wide with square or tapered edges. Wallboard sheets installed vertically on both sides of stud framing with joints centered over studs. A max 1 in. (25 mm) gap is maintained between the top of the wallboard and the bottom of the concrete floor. The gypsum wallboard type, thickness, number of layers and fastener types shall be as specified in the individual U400-Series Design in the UL Fire Resistance Directory.
3. **Joint System** – Max separation between bottom of floor and top of wall is 1 in. (25 mm). The joint system consists of a deflection plate, packing material and caulk, as follows:
 - A. **Deflection Plate** – A nom 4 in. (102 mm) wide by 3 in. (76 mm) deep, min 24 ga steel U-shaped channel. The deflection plate is attached to the concrete floor with masonry anchors at a max 24 in. (610 mm) OC. The steel ceiling runner (Item 2A) is installed within the deflection plate to maintain a nom 1 in. (25 mm) gap between the top of the ceiling runner and the top of the deflection plate. The ceiling runner is not fastened to the deflection plate.
 - B. **Packing Material** – The following packing materials are used:
 - Mineral Wool** – A 1 in. (25 mm) thickness by 4 in. (102 mm) wide section of min 4 pcf density mineral wool batt insulation is fitted into the 1 in. (25 mm) gap within the deflection plate between the top of the ceiling runner and the deflection plate.
 - Polyethylene Backer Rod** (2 hr rated system only) – A nom 1-1/4 in. (32 mm) diam polyethylene backer rod friction-fitted into the gap between the top of the gypsum wallboard and the bottom of the concrete deck on both sides of the wall and recessed from each surface of wall to accommodate the required thickness of fill material.
 - C. **Fill, Void or Cavity Material*** – A min 5/8 in. (16 mm) thickness of fill material for 1 hr rated systems and a min 1/2 in. (13 mm) thickness of fill material for 2 hr rated systems installed on each side of the wall between the top of the wallboard and bottom of the concrete floor.

3M COMPANY – FB-1000 NS, FB-2000 or FB-2000+

*Bearing the UL Classification Mark

Reprinted from the Online Certifications Directory with permission from UL

© 2013 UL LLC



System No. HW-S-0007

May 09, 2013

Assembly Rating – 2 Hr

Joint Width – 1 In. Max

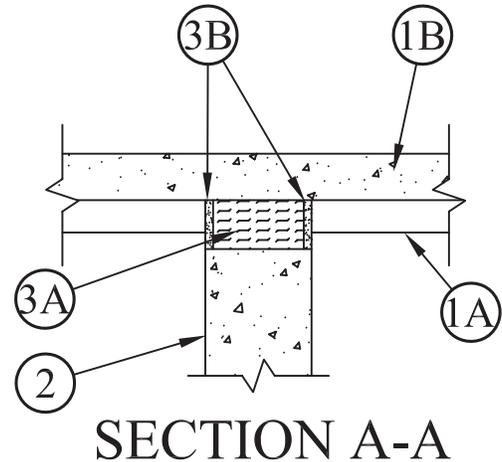
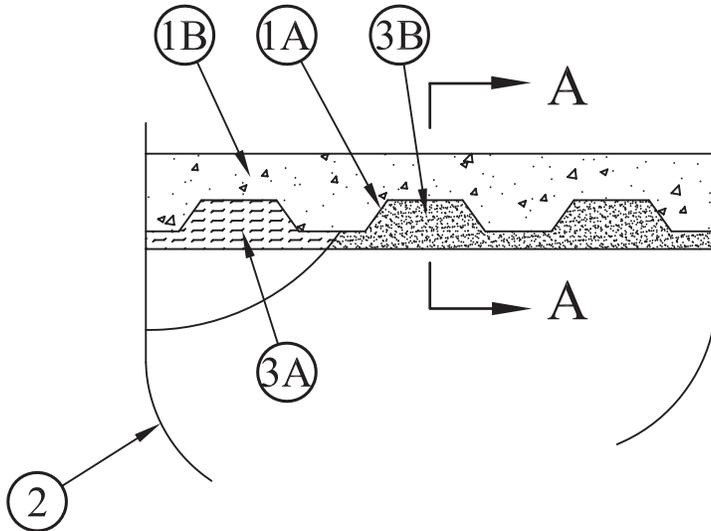

1. **Floor Assembly** – The fire-rated fluted steel deck/concrete floor assembly shall be constructed of the materials and in the manner described in the individual Floor-Ceiling Design in the UL Fire Resistance Directory and shall include the following construction features:
 - A. **Steel Floor And Form Units*** – Composite or noncomposite max 3 in. (76 mm) deep min 22 ga galv or phos/painted fluted units. Adjacent units button-punched or welded together max 36 in. (914 mm) OC along side joints.
 - B. **Normal Weight or Light Weight Concrete** – Min 3 in. (76 mm) thick concrete of the type, density, and compressive strength detailed for the specific Floor-Ceiling Design described in the UL Fire Resistance Directory.
2. **Wall Assembly** – Min 5-1/2 in. (140 mm) thick reinforced lightweight or normal weight (100-150 pcf or 1600-2400 kg/m³) structural concrete. Wall may also be constructed of any UL Classified **Concrete Blocks***.
See **Concrete Blocks (CAZT)** category in the Fire Resistance Directory for names of manufacturers.
3. **Joint System** – Max separation between bottom of floor and top of wall is 1 in. (25 mm). The joint system consists of a forming material and a fill material in the flutes of the steel floor units and between the top of the wall and bottom of the steel floor units, as follows:
 - A. **Packing Material** – Min 4-1/2 in. (114 mm) thickness of min 4.0 pcf (64 kg/m³) mineral wool batt insulation firmly packed into flutes of the steel floor units and between the top of the wallboard and bottom of the steel floor units as a permanent form. Packing material to be recessed from each surface of wall to accommodate the required thickness of fill material.
 - B. **Fill, Void or Cavity Material*** – Min 1/2 in. (13 mm) thickness of fill material installed on each side of the wall in the flutes of the steel floor units and between the top of the wall and the bottom of the steel floor units, flush with each surface of wall.

3M COMPANY – FB-1000 NS, FB-2000 or FB-2000+

*Bearing the UL Classification Mark

Reprinted from the Online Certifications Directory with permission from UL

© 2013 UL LLC



System No. HW-S-0028

August 03, 2001

Assembly Rating – 1 and 2 Hr (See Item 2)
 L Rating At Ambient – Less Than 1 CFM/Lin Ft
 L Rating At 400 F – Less Than 1 CFM/Lin Ft

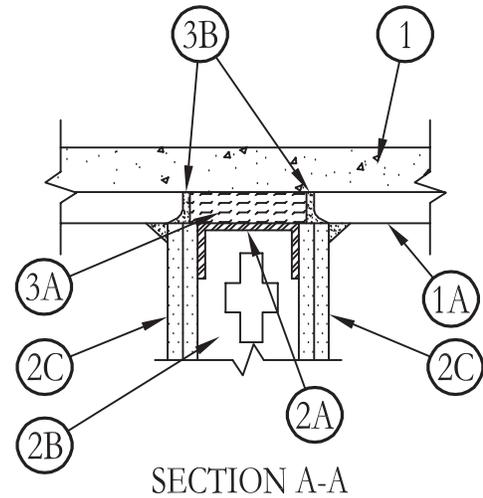
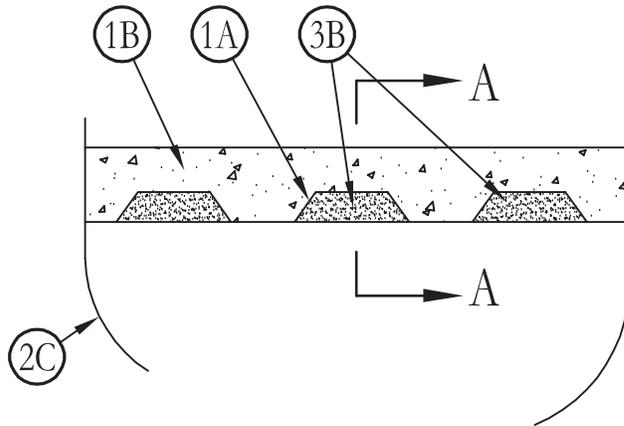

1. **Floor Assembly** – The fire rated fluted steel deck/concrete floor assembly shall be constructed of the materials and in the manner described in the individual Floor-Ceiling Design in the UL Fire Resistance Directory and shall include the following construction features:
 - A. **Steel Floor and Form Units*** – Composite or noncomposite max 3 in. deep min 22 galv or phos/painted fluted units. Adjacent units button-punched or welded together max 36 in. OC along side joints.
 - B. **Normal Weight or Light Weight Concrete** – Min 2-1/2 in. thick concrete of the type, density and compressive strength detailed for the specific Floor-Ceiling Design described in the UL Fire Resistance Directory.
2. **Wall Assembly** – The 1 or 2 Hr fire-rated gypsum wallboard/stud wall assembly shall be constructed of the materials and in the manner specified in the individual U400 Series Wall and Partition Designs in the UL Fire Resistance Directory and shall include the following construction features:
 - A. **Steel Floor and Ceiling Runners** – Floor and ceiling runners of wall assembly shall consist of min 25 ga galv steel channels sized to accommodate steel studs (Item 2B). Ceiling runner to be provided with min 1-1/4 in. flanges. Ceiling runner secured to valleys of steel floor units (Item 1A) with steel fasteners or by welds spaced max 24 in. OC.
 - B. **Studs** – Min 3-1/2 in. wide by 1-1/4 in. deep corrosion protected min 25 MSG steel channels. Steel stud spacing not to exceed 24 in. OC.
 - C. **Gypsum Board*** – 5/8 in. thick, 4 ft wide with square or tapered edges. Wallboard sheets installed vertically on both sides of stud framing with joints centered over studs. Wallboard to be butted tight to bottom of the steel deck. The gypsum wallboard type, thickness, number of layers and fastener types shall be as specified in the individual U400 Series Design in the UL Fire Resistance Directory.
3. **Joint System** – The joint system consists of a forming material and a fill material in the flutes of the steel floor units, as follows:
 - A. **Packing Material** – Min 3-3/4 in. thickness of min 4.0 pcf mineral wool batt insulation, compressed a min of 25 percent into flutes of the steel floor units between the top of the ceiling runner and bottom of the steel floor units, and recessed from each surface of wall to accommodate the required thickness of fill material.
 - B. **Fill, Void or Cavity Material*** – Min 3/8 in. thickness of fill material installed on each side of the wall in the flutes of the steel floor units. An additional min 3/8 in. bead of fill material to be installed at the wallboard/steel deck interface.

3M COMPANY – FB-1000 NS

*Bearing the UL Classification Mark

Reprinted from the Online Certifications Directory with permission from Underwriters Laboratories Inc.
 Copyright © 2010 Underwriters Laboratories Inc.®



System No. HW-S-0029

August 03, 2001

Assembly Rating – 2 Hr

L Rating At Ambient – Less Than 1 CFM/Lin Ft

L Rating At 400 F – Less Than 1 CFM/Lin Ft

Joint Width – 1 In. Max

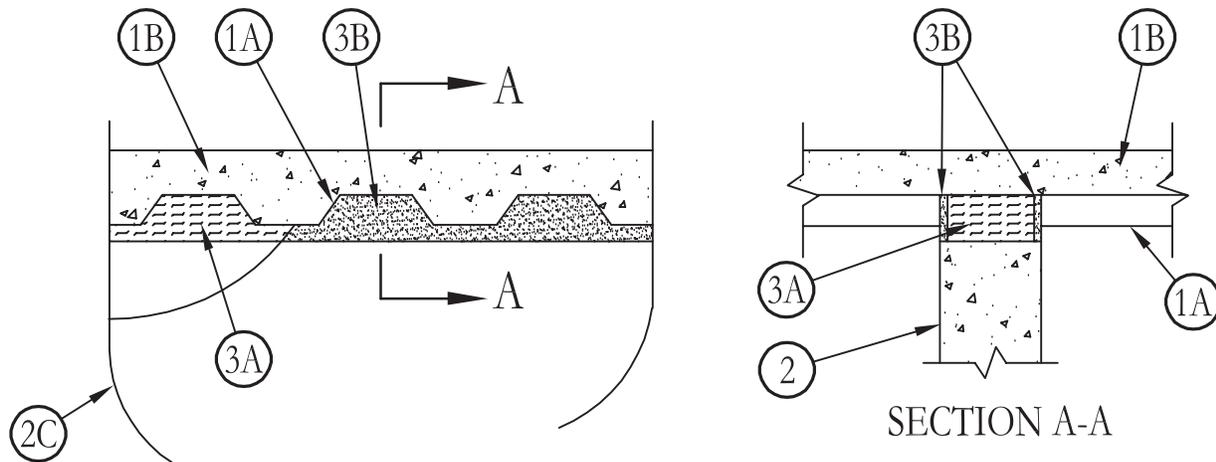

- Floor Assembly** – The fire-rated fluted steel deck/concrete floor assembly shall be constructed of the materials and in the manner described in the individual Floor-Ceiling Design in the UL Fire Resistance Directory and shall include the following construction features:
 - Steel Floor And Form Units*** – Composite or noncomposite max 3 in. deep min 22 ga galv or phos/painted fluted units. Adjacent units button-punched or welded together max 36 in. OC along side joints.
 - Normal Weight or Light Weight Concrete** – Min 2-1/2 in. thick concrete of the type, density, and compressive strength detailed for the specific Floor-Ceiling Design described in the UL Fire Resistance Directory.
- Wall Assembly** – Min 4-1/2 in. thick reinforced lightweight or normal weight (100-150 pcf) structural concrete. Wall may also be constructed of any UL Classified **Concrete Blocks***.
See **Concrete Blocks (CAZT)** category in the Fire Resistance Directory for names of manufacturers.
- Joint System** – Max separation between bottom of floor and top of wall is 1 in. The joint system consists of a packing material and a fill material in the flutes of the steel floor units and between the top of the wall and bottom of the steel floor units, as follows:
 - Packing Material** – Min 3-3/4 in. thickness of min 4 pcf density mineral wool batt insulation, compress a min of 25% into flutes of the steel floor units and between the top of the wall and bottom of the steel floor units as a permanent form. Packing material to be recessed from each surface of wall to accommodate the required thickness of fill material.
 - Fill, Void or Cavity Material* – Sealant** – min 3/8 in. thickness of fill material installed on each side of the wall in the flutes of the steel floor units and between the top of the wall and the bottom of the steel floor units, flush with each surface of wall. An additional min 3/8 in. bead of fill material to be installed at the wall steel deck interface when wall and deck are in contact.

3M COMPANY – FB-1000 NS

*Bearing the UL Classification Mark

Reprinted from the Online Certifications Directory with permission from Underwriters Laboratories Inc.

Copyright © 2010 Underwriters Laboratories Inc.®



Construction Joints

Head of Wall

HW S

System No. HW-S-0030

September 08, 2004

Assembly Rating – 1 & 2 Hr (See Item 2)

Joint Width – 3/4 In. Max

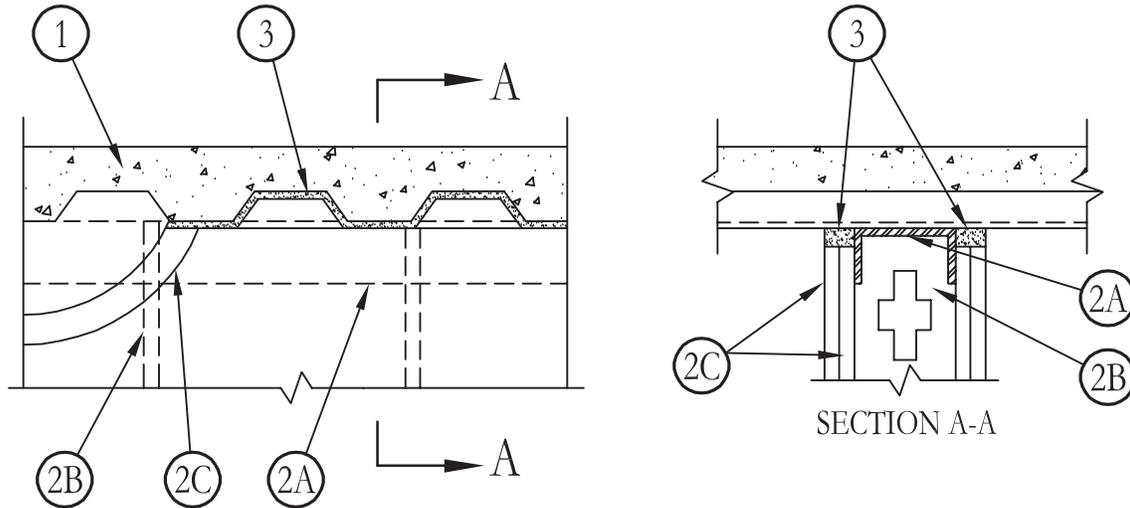

1. **Floor Assembly** – The fire-rated fluted steel deck/concrete floor assembly shall be constructed of the materials and in the manner described in the individual Floor-Ceiling Design in the UL Fire Resistance Directory and shall include the following construction features:
 - A. **Steel Floor and Form Units*** – Max 3 in. deep galv steel fluted units.
 - B. **Concrete** – Min 2-1/2 in. thick reinforced concrete, as measured from the top plane of the floor units.
2. **Wall Assembly** – The 1 or 2 hr fire-rated gypsum wallboard/steel stud wall assembly shall be constructed of the materials and in the manner described in the individual U400 Series Wall or Partition Designs in the UL Fire Resistance Directory and shall include the following construction features:
 - A. **Steel Floor and Ceiling Runners** – Floor and ceiling runners of wall assembly shall consist of galv steel channels sized to accommodate steel studs (Item 2B). Ceiling runner to be secured to valleys of steel floor units (Item A) with steel fasteners or by welds spaced max 24 in. OC.
 - B. **Studs** – Steel studs to be min 3-1/2 in. wide. Studs cut 1/2 to 3/4 in. less in length than assembly height with bottom nesting in and resting on floor runner and with top nesting in ceiling runner with or without attachment. Stud spacing not to exceed 24 in. OC.
 - C. **Gypsum Board*** – Wallboard sheets installed to a min total thickness of 5/8 in. and 1-1/4 in. on each side of wall for 1 and 2 hr rated assemblies, respectively. Wall to be constructed as specified in the individual Wall and Partition Design in the UL Fire Resistance Directory, except that wallboard is cut to the contour of the steel floor units with a max 3/4 in. gap between the top of the wallboard and the bottom of the floor units.

The hourly fire rating of the joint system is dependent on the hourly fire rating of the wall.
3. **Fill, Void or Cavity Material* – Caulk or Sealant** – Min 5/8 in. and 1-1/4 in. thickness of fill material for 1 and 2 hr rated assemblies, respectively, installed on each side of the wall between the top of the wallboard and all surfaces of the steel floor units, flush with each surface of the wall.

3M COMPANY – CP 25WB+ caulk or FB-3000 WT sealant

*Bearing the UL Classification Marking

Reprinted from the Online Certifications Directory with permission from Underwriters Laboratories Inc.
Copyright © 2010 Underwriters Laboratories Inc.®



System No. HW-S-0040

May 09, 2013

ANSI/UL2079

Assembly Rating – 1 & 2 Hr (See Item 2)
Nominal Joint Width – 1 In.
L Rating At Ambient – Less Than 1 CFM/LIN ft
L Rating At 400 F – Less Than 1 CFM/LIN ft

CAN/ULC S115

F Rating – 1 & 2 Hr (See Item 2)
FT Rating – 1 & 2 Hr (See Item 2)
FH Rating – 1 & 2 Hr (See Item 2)
FTH Rating – 1 & 2 Hr (See Item 2)
Nominal Joint Width – 1 In.
L Rating At Ambient – Less Than 1 CFM/LIN ft
L Rating At 400 F – Less Than 1 CFM/LIN ft

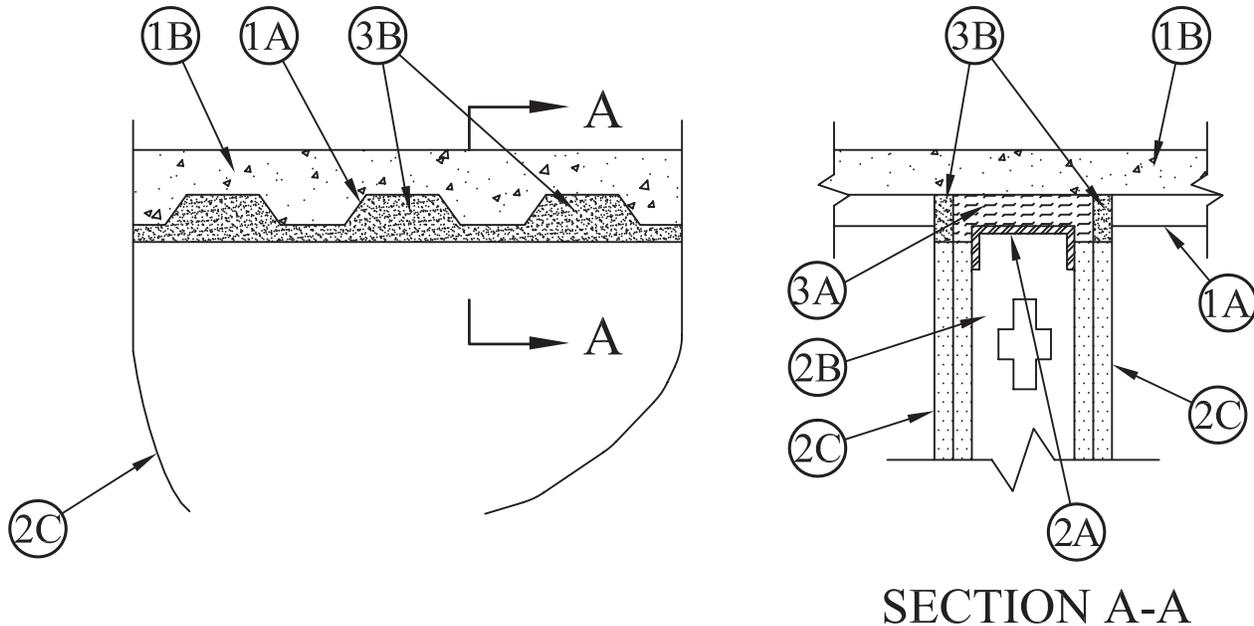

SECTION A-A

- Floor Assembly** – The fire-rated fluted steel deck/concrete floor assembly shall be constructed of the materials and in the manner described in the individual Floor-Ceiling Design in the UL Fire Resistance Directory and shall include the following construction features:
 - Steel Floor And Form Units*** – Max 1-1/2 to 3 (38 to 76 mm) in. deep min 22 ga galv or phos/painted steel fluted units.
 - Concrete** – Min 3 in. (76 mm) thick reinforced concrete, as measured from the top plane of the floor units.
- Wall Assembly** – The 1 or 2 hr fire rated gypsum wallboard/steel stud wall assembly shall be constructed of the materials and in the manner described in the individual U400 - Series Wall or Partition Design in the UL Fire Resistance Directory and shall include the following construction features:
 - Steel Floor And Ceiling Runners** – Floor and ceiling runners of wall assembly shall consist of min 25 ga galv steel channels sized to accommodate steel studs (Item 2B). Ceiling runner to be provided with 1-1/4 in. (32 mm) flanges. Ceiling runner secured to valleys of steel floor units (Item 1A) with steel fasteners or by welds spaced max 24 in. (610 mm) OC.
 - Studs** – Steel studs to be min 3-1/2 in. (89 mm) wide. Studs cut 1/2 to 3/4 in. (13 to 19 mm) less in length than assembly height with bottom nesting in and resting on floor runner and with top nesting in ceiling runner without attachment. Stud spacing not to exceed 24 in. (610 mm) OC.
 - Gypsum Board*** – Wallboard sheets installed to a min total thickness of 5/8 in. (16 mm) and 1-1/4 in. (32 mm) on each side of wall for 1 and 2 hr rated assemblies, respectively. Wall to be constructed as specified in the individual Wall and Partition Design in the UL Fire Resistance Directory, except that a nom 1 in. (25 mm) gap shall be maintained between the top of the wallboard and the bottom of the steel floor units and the top row of screws shall be installed into the studs 1-3/4 in. (44 mm) below the valleys of the steel floor units.
- Joint System** – Max separation between bottom of floor and top of wall is 1 in. (25 mm). The joint system consists of a packing material and a fill material in the flutes of the steel floor units and between the top of the wallboard and bottom of the steel floor units, as follows:
 - Packing Material*** – Min 3-1/2 in. (89 mm) thickness of min 4 pcf (64 kg/m³) density mineral wool batt insulation for 1 hr Rated Design, min 4-1/2 in. (114 mm) thickness for 2 hr Rated Design, firmly packed into flutes of the steel floor units and between the top of the wallboard and bottom of the steel floor units, and recessed from each surface of wall to accommodate the required thickness of fill material.
 - Fill, Void or Cavity Material*** – Min 1/2 in. (13 mm) thickness of fill material installed on each side of the wall in the flutes of the steel floor units and between the top of the wallboard and the bottom of the steel floor units (concrete floor), flush with each surface of wallboard.

3M COMPANY – FB-1000 NS or FB-2000

*Bearing the UL Classification Mark

Reprinted from the Online Certifications Directory with permission from UL
© 2013 UL LLC



System No. HW-S-0041

May 09, 2013

ANSI/UL2079

Assembly Rating – 1 & 2 Hr (See Items 2, 3B & 3C)

Nominal Joint Width – 1 In.

CAN/ULC S115

F Rating – 1 & 2 Hr (See Items 2, 3B & 3C)

FT Rating – 1 & 2 Hr (See Items 2, 3B & 3C)

FH Rating – 1 & 2 Hr (See Items 2, 3B & 3C)

FTH Rating – 1 & 2 Hr (See Items 2, 3B & 3C)

Nominal Joint Width – 1 In.

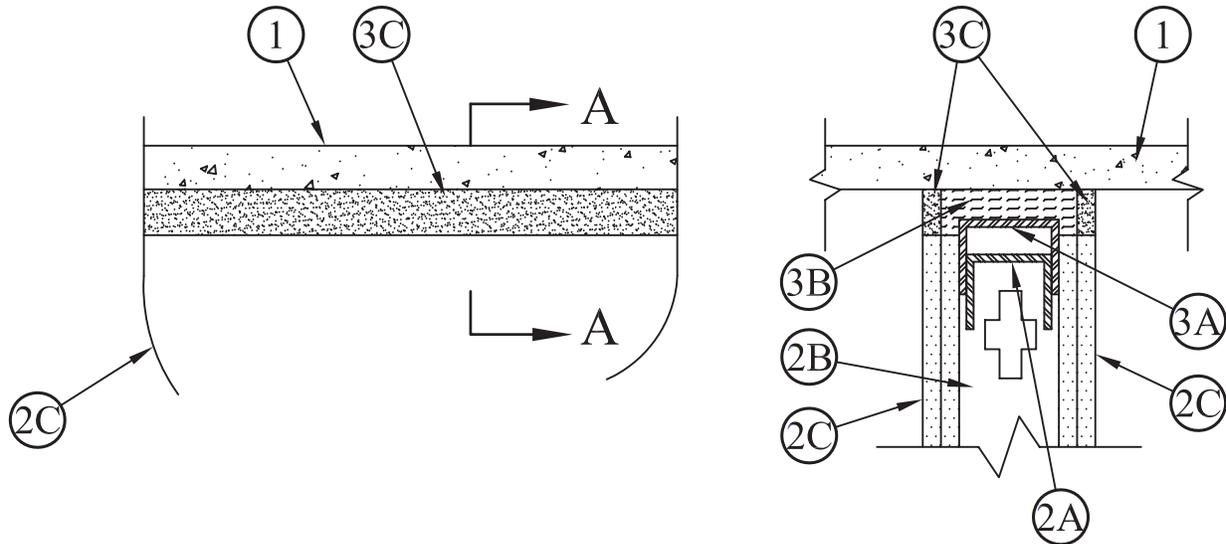
**SECTION A-A**

1. **Floor Assembly** – Min 4-1/2 in. (114 mm) thick steel-reinforced lightweight or normal weight (100-150 pcf or 1600-2400 kg/m³) structural concrete.
 2. **Wall Assembly** – The 1 or 2 hr fire rated gypsum wallboard/steel stud wall assembly shall be constructed of the materials and in the manner described in the individual U400- Series Wall or Partition Design in the UL Fire Resistance Directory and shall include the following construction features:
 - A. **Steel Floor And Ceiling Runners** – Floor and ceiling runners of wall assembly shall consist of min 25 ga galv steel channels sized to accommodate steel studs (Item 2B). Ceiling runner to be provided with 3 in. (76 mm) flanges. Ceiling runner installed within the U-shaped deflection plate (Item 3A) with 1 in. (25 mm) gap maintained between the top of ceiling runner and top of deflection plate.
 - B. **Studs** – Steel studs to be min 3-1/2 in. (89 mm) wide. Studs cut 1/2 to 3/4 in. (13 to 19 mm) less in length than assembly height with bottom nesting in and resting on floor runner and with top nesting in ceiling runner without attachment. Stud spacing not to exceed 24 in. (610 mm) OC.
 - C. **Gypsum Board*** – Wallboard sheets installed to a min total thickness of 5/8 in. (16 mm) and 1-1/4 in. (32 mm) on each side of wall for 1 and 2 hr rated assemblies, respectively. Wall to be constructed as specified in the individual Wall and Partition Design in the UL Fire Resistance Directory, except that a nom 1 in. (25 mm) gap shall be maintained between the top of the wallboard and the lower surface of the floor and the top row of screws shall be installed into the studs 3-1/2 in. (89 mm) below the valleys of the steel floor units.
 3. **Joint System** – Max separation between bottom of floor and top of wall is 1 in. (25 mm). The joint system consists of a deflection plate, packing material and caulk, as follows:
 - A. **Deflection Channel** – A nom 4 in. (102 mm) wide by 3 in. (76 mm) deep min 24 ga steel U-shaped channel. Deflection channel secured to lower surface of floor with steel fasteners spaced max 24 in. (610 mm) OC. The ceiling runner (Item 2A) is installed within the deflection channel to maintain a 1 in. (25 mm) gap between the top of the ceiling runner and the top of the deflection channel. The ceiling runner is not fastened to the deflection channel.
 - B. **Packing Material** – The following packing materials are used:
 - Mineral Wool** – A 1 in. (25 mm) thickness by 4 in. (102 mm) wide section of min 4 pcf (64 kg/m³) density mineral wool batt insulation is fitted into the 1 in. (25 mm) gap within the deflection plate between the top of the ceiling runner and the deflection plate.
 - Polyethylene Baker Rod** – (2 hr rated system only) – A nom 3/4 in. (19 mm) thick by 1 in. (25 mm) wide polyethylene backer rod friction-fitted into the gap between the top of the gypsum wallboard and the bottom of the concrete deck on both sides of the wall and recessed from each surface of wall to accommodate the required thickness of fill material.
 - C. **Fill, Void or Cavity Material*** – A min 5/8 in. (16 mm) thickness of fill material installed on each side of the wall between the top of the wallboard and bottom of the concrete floor.
- 3M COMPANY** – FB-1000 NS or FB-2000

*Bearing the UL Classification Mark

Reprinted from the Online Certifications Directory with permission from UL

© 2013 UL LLC



System No. HW-S-0042

May 09, 2013

ANSI/UL2079

Assembly Rating – 2 Hr
Nominal Joint Width – 1 In.

CAN/ULC S115

F Rating – 2 Hr
FT Rating – 2 Hr
FH Rating – 2 Hr
FTH Rating – 2 Hr
Nominal Joint Width – 1 In.

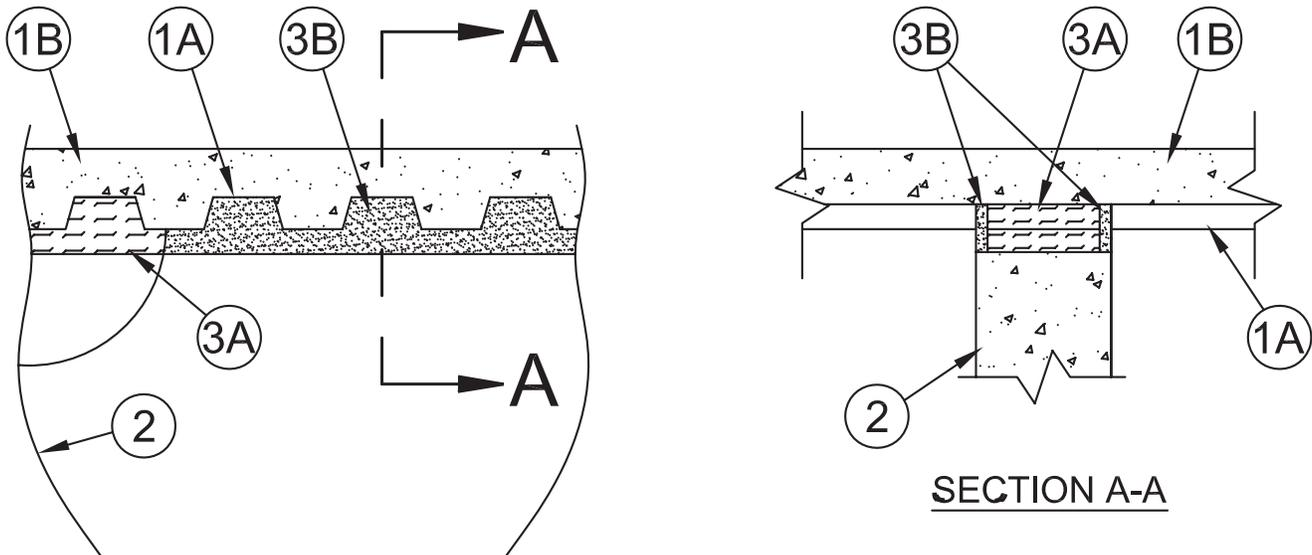

- Floor Assembly** – The fire-rated fluted steel deck/concrete floor assembly shall be constructed of the materials and in the manner described in the individual Floor-Ceiling Design in the UL Fire Resistance Directory and shall include the following construction features:
 - Steel Floor And Form Units*** – Max 3 in. (76 mm) deep min 22 ga galv or phos/painted steel fluted units.
 - Concrete** – Min 3 in. (76 mm) thick reinforced concrete, as measured from the top plane of the floor units.
- Wall Assembly** – Min 5-1/2 in. (140 mm) thick reinforced lightweight or normal weight (100-150 pcf or 1600-2400 kg/m³) structural concrete. Wall may also be constructed of any UL Classified **Concrete Blocks***.
See **Concrete Blocks (CAZT)** category in the Fire Resistance Directory for names of manufacturers.
- Joint System** – **Max separation between bottom of floor and top of wall is 1 in. (25 mm).** The joint system consists of a packing material and a fill material in the flutes of the steel floor units and between the top of the wall and bottom of the steel floor units, as follows:
 - Packing Material** – Min 3-1/2 in. (89 mm) thickness of min 4 pcf (64 kg/m³) density mineral wool batt insulation for 1 hr Rated Design, min 4-1/2 in. (114 mm) thickness for 2 hr Rated Design, firmly packed into flutes of the steel floor units and between the top of the wall and bottom of the steel floor units, and recessed from each surface of wall to accommodate the required thickness of fill material. Mineral wool batts packed into opening horizontally with a min 25 percent compression.
 - Fill, Void or Cavity Material*** – Min 1/2 in. (13 mm) thickness of fill material installed on each side of the wall in the flutes of the steel floor units and between the top of the wall and the bottom of the steel floor units, flush with each surface of wall.

3M COMPANY – FB-1000 NS or FB-2000

Bearing the UL Classification Mark

Reprinted from the Online Certifications Directory with permission from UL
© 2013 UL LLC



System No. HW-S-0082

September 11, 2006
 Assembly Rating – 1 Hr
 Joint Width – 1/2 In. (13 mm) Max

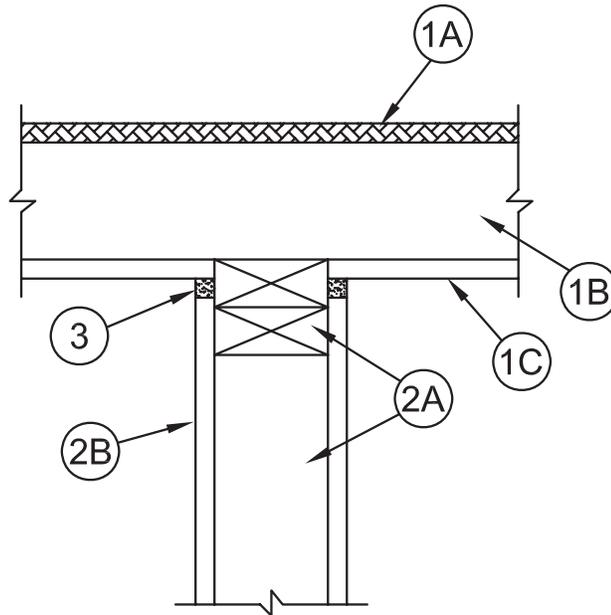

1. **Floor Assembly** – The 1 hr fire-rated wood joist, wood truss or combination wood and steel truss Floor-Ceiling assembly shall be constructed of the materials and in the manner described in the individual L500-Series Floor-Ceiling Design in the UL Fire Resistance Directory and shall include the following construction features:
 - A. **Flooring System** – Lumber or plywood subfloor with finish floor of lumber, plywood or **Floor Topping Mixture*** as specified in the individual Floor-Ceiling Design.
 - B. **Wood Joists** – Nom 10 in. (254 mm) deep (or deeper) lumber, steel or combination lumber and steel joists, trusses or **Structural Wood Members*** with bridging as required and with ends firestopped.
 - C. **Gypsum Board*** – Nom 4 ft. (122 cm) wide by 5/8 in. (16 mm) thick as specified in the individual Floor-Ceiling Design.
2. **Wall Assembly** – The 1 hr fire rated gypsum board/lumber stud wall assembly shall be constructed of the materials and in the manner described in the individual U300-Series Wall and Partition Designs in the UL Fire Resistance Directory and shall include the following construction features:
 - A. **Studs** – Wall framing to consist of nom 2 by 4 in. (51 by 102 mm) lumber spaced 16 in. (406 mm) OC. Top plate installed parallel or perpendicular to direction of wood joists and secured to bottom of joists with steel fasteners spaced max 24 in. (610 mm) OC.
 - B. **Gypsum Board*** – Gypsum board sheets installed to a min total thickness of 5/8 in. (16 mm) on each side of wall. Wall to be constructed as specified in the individual Wall and Partition Design in the UL Fire Resistance Directory, except that a max 1/2 in. (13 mm) gap shall be maintained between the top of the gypsum board and the ceiling of the floor-ceiling assembly.
3. **Fill, Void or Cavity Material* – Caulk** – Min 5/8 in. (16 mm) thickness of fill material installed to fill the max 1/2 in. (13 mm) gap at the wall/ceiling intersection flush with each surface of the wall.

3M COMPANY – FireDam 150+ Caulk

*Bearing the UL Classification Mark

Reprinted from the Online Certifications Directory with permission from Underwriters Laboratories Inc.

Copyright © 2010 Underwriters Laboratories Inc.®



3M Firestop Systems

Construction Joints

Wall to Wall

WWD

Wall to Wall Dynamic

WWS

Wall to Wall Static

Quick Reference Guide

Wall-to-Wall

| 3M UL Systems | "F" Rating | 3M Product | Through Penetrant Details |
|---------------|------------|---|--|
| WW-D-0013 | 2, 3, 4 | 3M™ Fire Barrier Silicone Sealant 2000+ | 2" wide, 10.9% compress/extension, concrete/concrete. Also referred as WWD0013. |
| WW-D-0021 | 2 | 3M™ Fire Barrier Sealant FD 150+ | 1" wide, 18% compress/extension, concrete/concrete. Also referred as WWD0021. |
| WW-D-0045 | 1, 2, 3 | 3M™ Fire Barrier Sealant FD 150+ | Gypsum Wall to Gypsum Wall; 1, 2 and 3 hour rating; 2" Nominal Joint Width; Movement - 12.5% Compression or Extension. Also known as WWD0045. |
| WW-D-0046 | 2, 3 | 3M™ Fire Barrier Sealant FD 150+ | Concrete Wall to Concrete Wall; 3 hour rating; 2" Nominal Joint Width; Movement - 12.5% Compression or Extension. Also known as WWD0046. |
| WW-D-0047 | 1, 2, 3 | 3M™ Fire Barrier Sealant FD 150+ | Concrete Wall to Gypsum Wall; 1, 2, and 3 hour rating; 2" Nominal Joint Width; Movement - -12.5 % Compression or Extension. Also known as WWD0047 |
| WW-D-0074 | 1, 2 | 3M™ Fire Barrier Sealant FD 150+ | Min 4-1/2" concrete wall. U400 Series wall. Nom 3/4 in. joint. Gypsum wall T's into concrete wall. Steel runner attached to concrete wall. No mineral wool required. 1&2 hour F rating. 17% compression/extension. See system for L rating. Also known as WWD0074. |
| WW-D-0096 | 2, 3, 4 | 3M™ Fire Barrier Sealant FD 150+ | Min 7-1/2 in. structural concrete or concrete block wall. Nominal 1 in. width. +/- 12.5% movement. 1-1/4 backer rod required. 2, 3, and 4 hour F rating. Also known as WWD0096. |
| WW-D-0176 | 1, 2 | 3M™ Fire Barrier Sealant FD 150+ | 1 or 2 hour fire rated gypsum board/steel stud assembly as specified by the U400, V400, or W400 designs. Max 2 in. joint. 19% compression/extension. 1 or 2 hour F and T rating. Also known as WWD0176 |
| WW-D-0177 | 2 | 3M™ Fire Barrier Sealant FD 150+ | Min 6 in. concrete or concrete block wall. Max 2 in. joint. 19% compression/extension. 2 hour F and T rating. Also Known as WWD0177 |
| WW-D-0215 | 2 | 3M™ Fire and Water Barrier Tape FWBT | Max. 2 in. wide joint between two parallel concrete assemblies. Utilizing mineral wool and Fire and Water Barrier Tape. Or FireDam™ Spray 200 Max. 19% compression or extension. |
| WW-D-0227 | 1, 2 | FireDam™ Spray 200 | Max 2 in. wall to wall joint between gypsum wall assemblies. Single side access. |
| WW-D-0228 | 2 | FireDam™ Spray 200 | Max 2 in. wall to wall joint between concrete wall assemblies. Single side access. |
| WW-D-1003 | 2, 3 | 3M™ Fire Barrier Water Tight Sealant 1000 NS | Min 5 in. concrete wall or concrete block wall. Max 4 in. joint. +/- 31% movement. 3 hour F rating. Also known as WWD1003. |
| WW-D-1004 | 2 | 3M™ Fire Barrier Water Tight Sealant 1000 NS | Min 4-12 in. concrete wall or concrete block wall. Max 4 in. joint. n. joint. +/- 25% movement. 2 hour F rating. Also knowns at WWD1004. |
| WW-D-1010 | 2, 3 | 3M™ Fire Barrier Silicone Sealant 2000+ | 4" wide, 25% compress/extension, concrete/concrete. Also referred as WWD1010. |
| WW-D-1023 | 2 | 3M™ Fire Barrier Water Tight Sealant 1000 NS | Min 5 in. concrete walls. Max 4 in. joint. 15.6% compression/extension. 2 hour F rating. Also known as WWD1023. |
| WW-D-1202 | 1, 2 | 3M™ FireDam™ Spray 200 3M™ Fire and Water Barrier Tape FWBT | Max. 4 in. wide joint between two parallel steel stud gypsum wallboard assemblies. Utilizing mineral wool and Fire and Water Barrier Tape. Or FireDam™ Spray 200 Max. 25% compression or extension. |
| WW-D-1203 | 2 | 3M™ FireDam™ Spray 200 3M™ Fire and Water Barrier Tape FWBT | Max. 4 in. wide joint between two parallel concrete assemblies. Utilizing mineral wool and Fire and Water Barrier Tape. Or FireDam™ Spray 200 Max. 25% compression or extension. |
| WW-D-1204 | 2 | 3M™ FireDam™ Spray 200 3M™ Fire and Water Barrier Tape FWBT | Max. 4 in. wide joint between two parallel concrete assemblies. Utilizing mineral wool and Fire and Water Barrier Tape. Or FireDam™ Spray 200 Max. 19% compression or extension. |
| WW-S-0001 | 2 | 3M™ Fire Barrier Silicone Sealant 2000+ 3M™ Fire Barrier Water Tight Sealant 1000 NS | Min 4-1/2 in. concrete wall or concrete block wall. Max 1 in. joint. Backer rod required. 2 hour F rating. Also known as WWS0001. |
| WW-S-0004 | 2 | 3M™ Fire Barrier Silicone Sealant 2000+ 3M™ Fire Barrier Water Tight Sealant 1000 NS | U400 Series Gypsum Wall or Partition with steel studs. Max 3/4 in. joint. No mineral wool or backer rod required. 2 hour F rating. Also known as WWS0004. |

Wall-to-Wall

| 3M UL Systems | "F" Rating | 3M Product | Through Penetrant Details |
|------------------|------------|---|---|
| WW-S-0008 | 2 | 3M™ Fire Barrier Sealant CP 25WB+ 3M™ Fire Barrier Water Tight Sealant 3000 WT | 1" wide, concrete/concrete. Also referred as WWS0008. |
| WW-S-0028 | 2 | 3M™ Fire Barrier Sealant CP 25WB+ 3M™ Fire Barrier Water Tight Sealant 3000 WT | 1" wide, concrete/concrete. Also referred as WWS0028. |
| WW-S-0032 | 2 | 3M™ Fire Barrier Silicone Sealant 2000+ | 1-1/2" wide, gypsum/gypsum. Also referred as WWS0032. |
| WW-S-0034 | 2 | 3M™ Fire Barrier Sealant FD 150+ | 1/2" wide, concrete/concrete. Also referred as WWS0034. |
| WW-S-0035 | 2 | 3M™ Fire Barrier Sealant FD 150+ | 1" wide, concrete/concrete. Also referred as WWS0035. |
| WW-S-1001 | 2, 3 | 3M™ Fire Barrier Silicone Sealant 2000+ 3M™ Fire Barrier Water Tight Sealant 1000 NS | Min 4-1/2 n. concrete wall for max 4 in. joints. Min 5 in. concrete wall for max 6 in. joints. Concrete block wall. 3 hour F rating. Also known as WWS1001. |
| WW-S-1003 | 2, 3 | 3M™ Fire Barrier Silicone Sealant 2000+ 3M™ Fire Barrier Water Tight Sealant 1000 NS | 6" wide, concrete/concrete. Also referred as WWS1003. |
| WW-S-1030 | 2 | 3M™ Fire Barrier Water Tight Sealant 1000 NS | 4" wide, concrete/concrete. Also referred as WWS1030. |

System No. WW-D-0013

April 22, 2011

Assembly Rating – 4 Hr

Nominal Joint Width – 2 In.

Class II Movement Capabilities – 10.9% Compression or Extension

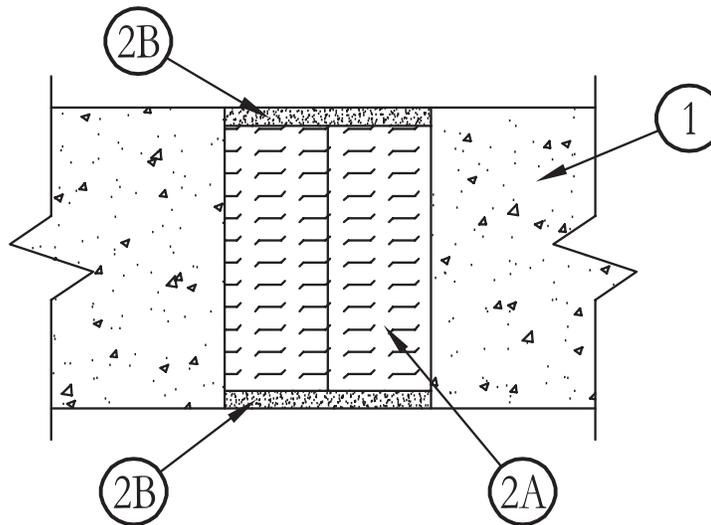

1. **Wall Assembly** – Min 6 in. thick steel-reinforced lightweight or normal weight (100-150 pcf) structural concrete. Wall may also be constructed of any UL Classified **Concrete Blocks***.
2. **Joint System** – Max width of joint (at time of installation of joint system) is 2 in. The joint system is designed to accommodate a max 10.9 percent compression or extension from its installed width. The joint system shall consist of the following:
 - A. **Forming Material*** – Min 4.0 pcf mineral wool batt insulation installed in joint opening as a permanent form. Batt cut to min width of 5 in. and installed edge-first into joint opening, parallel with joint direction, such that batt sections are compressed min 50 percent in thickness and such that the compressed batt sections are recessed from both surfaces of wall to accommodate the required thickness of fill material. Adjoining lengths of batt to be tightly-butted with butted seams spaced min 48 in. apart along the length of the joint.
IIG MINWOOL L L C – MinWool-1200 Safing
ROCK WOOL MANUFACTURING CO – Delta Safing Board
ROCKWOOL MALAYSIA SDN BHD – Type Safe
ROXUL INC – Type Safe
THERMAFIBER INC – Type SAF
 - B. **Fill, Void or Cavity Material*** – Min 1/2 in. thickness of fill material applied within the joint, flush with both surfaces of wall.
3M COMPANY – FB 2000+

*Bearing the UL Classification Mark

Reprinted from the Online Certifications Directory with permission from Underwriters Laboratories Inc.
Copyright © 2011 Underwriters Laboratories Inc.®



System No. WW-D-0021

August 03, 2001

Assembly Rating – 2 Hr

L Rating At Ambient – 4 CFM/Lin Ft

L Rating At 400 F – 6 CFM/Lin Ft

Nominal Joint Width – 1 in. Max

Class II Movement Capabilities – 18.75% Compression or Extension

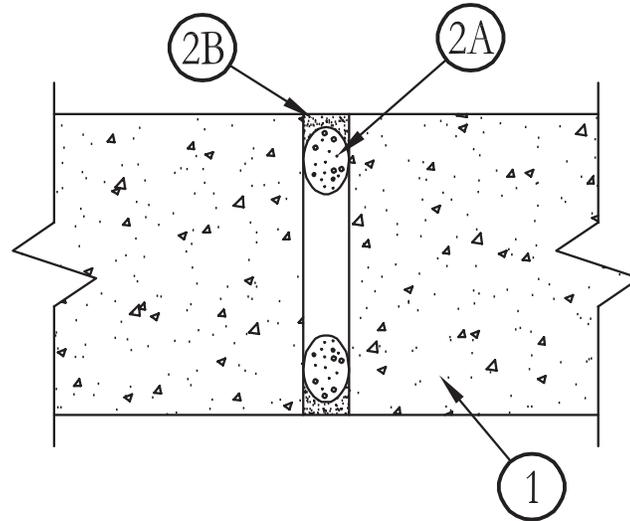

1. **Wall Assembly** – Min 7-1/2 in. thick reinforced lightweight or normal weight (100-150 pcf) structural concrete. Wall may also be constructed of any UL Classified **Concrete Blocks***.
See **Concrete Blocks** (CAZT) category in the Fire Resistance Directory for names of manufacturers.
2. **Joint System** – **Max width of joint (at time of installation of joint system) is 1 in. The joint system is designed to accommodate a max 18.75 percent compression or extension from its installed width.** The joint system shall consist of the following:
 - A. **Packing Material** – Nom 1-1/4 in. diameter polyethylene backer rod compressed and installed into joint. Packing material to be recessed from each surface of wall as required to accommodate the required thickness of fill material.
 - B. **Fill, Void or Cavity Material*** – Min 1/2 in. thickness of fill material applied within the joint, flush with both surfaces of wall.
3M COMPANY – FireDam 150+

*Bearing the UL Classification Mark

Reprinted from the Online Certifications Directory with permission from Underwriters Laboratories Inc.
Copyright © 2010 Underwriters Laboratories Inc.®



System No. WW-D-0045

November 25, 2003

Assembly Ratings - 1, 2 and 3 Hr (See Item 1)

Nominal Joint Width - 2 in.

Class II Movement Capabilities - 12.5% Compression or Extension

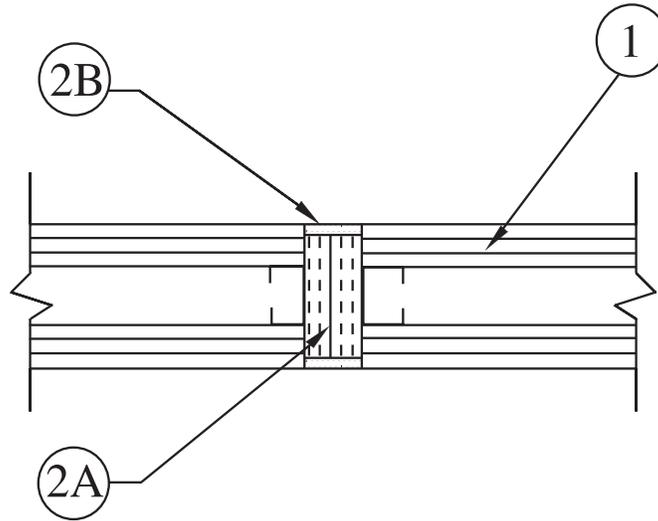

1. **Wall Assembly** – Nonbearing 1, 2 or 3 hr fire rated gypsum board/steel stud assembly constructed of the materials and in the manner described in the individual U400-Series Wall or Partition Design in the UL Fire Resistance Directory and shall include the following construction features:

- A. **Studs** – Min 1-1/2 in. (38 mm) wide steel studs spaced max 24 in. (610 mm) OC.
- B. **Gypsum Board*** – The gypsum board type, thickness, number of layers, fastener type and sheet orientation shall be as specified in the individual U400 Series Design in the UL Fire Resistance Directory.

The hourly assembly rating of the joint system is equal to the hourly fire rating of the wall assembly in which it is installed.

2. **Joint System** – Max width of joint (at time of installation of joint system) is 2 in. (51 mm) The joint system is designed to accommodate a max 12.5 percent compression or extension from its installed width. The joint system shall consist of the following:

- A. **Forming Material*** – Min 4.0 pcf (64 kg/m³) mineral wool batt insulation installed in joint opening as a permanent form. Pieces of batt cut to min width of 1-3/4, 3, or 4-1/4 in. (44, 76 or 108 mm) for 1, 2 and 3 hr rated assemblies, respectively. Pieces of batt installed edge-first into joint opening, parallel with joint direction, such that batt sections are compressed min 50 percent in thickness and such that the compressed batt sections are recessed from both surfaces of wall to accommodate the required thickness of fill material.

ROCK WOOL MANUFACTURING CO – Delta Board

ROCKWOOL MALAYSIA SDN BHD – SAFE

ROXUL INC – SAFE

- B. **Fill, Void or Cavity Material*** – Min 1/2 in. (13 mm) thickness of fill material applied within the joint, flush with both surfaces of wall.

3M COMPANY – FD-150+

*Bearing the UL Classification Mark

Reprinted from the Online Certifications Directory with permission from UL

© 2012 UL LLC



System No. WW-D-0046

November 25, 2003

Assembly Rating – 3 Hr

Nominal Joint Width – 2 in.

Class II Movement Capabilities – 12.5% Compression or Extension

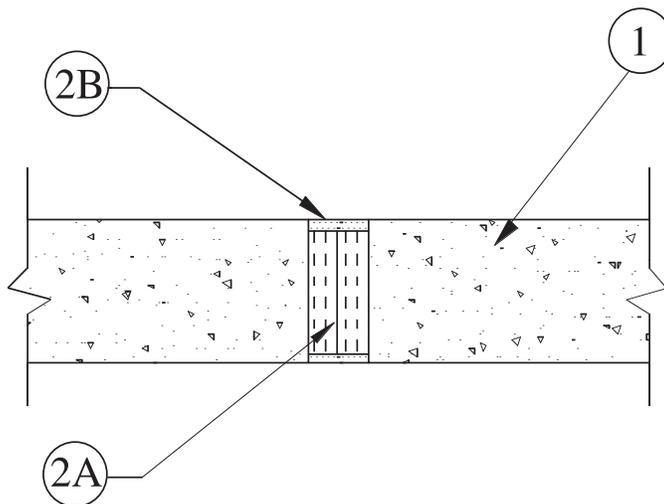

1. **Wall Assembly** – Min 5-1/4 in. (133 mm) thick reinforced lightweight or normal weight (100-150 pcf or 1600-2400 kg/m³) structural concrete. Wall may also be constructed of any UL Classified **Concrete Blocks***.
See **Concrete Blocks (CAZT)** category in the Fire Resistance Directory for names of manufacturers.
2. **Joint System** – Max width of joint (at time of installation of joint system) is 2 in. (51 mm). The joint system is designed to accommodate a max 12.5 percent compression or extension from its installed width. The joint system shall consist of the following:
 - A. **Forming Material*** – Min 4.0 pcf (64 kg/m³) mineral wool batt insulation installed in joint opening as a permanent form. Pieces of batt cut to min width of 4-1/4 in. (108 mm) and installed edge-first into joint opening, parallel with joint direction, such that batt sections are compressed min 50 percent in thickness and such that the compressed batt sections are recessed from both surfaces of wall to accommodate the required thickness of fill material.
ROCK WOOL MANUFACTURING CO – Delta Board
ROCKWOOL MALAYSIA SDN BHD – SAFE
ROXUL INC – SAFE
 - B. **Fill, Void or Cavity Material*** – Min 1/2 in. (13 mm) thickness of fill material applied within the joint, flush with both surfaces of wall.
3M COMPANY – FD-150+

*Bearing the UL Classification Mark

Reprinted from the Online Certifications Directory with permission from UL

© 2012 UL LLC



System No. WW-D-0047

November 25, 2003

Assembly Rating – 1, 2 and 3 Hr (See Item 1)

Nominal Joint Width – 2 in.

Class II Movement Capabilities – 12.5% Compression or Extension

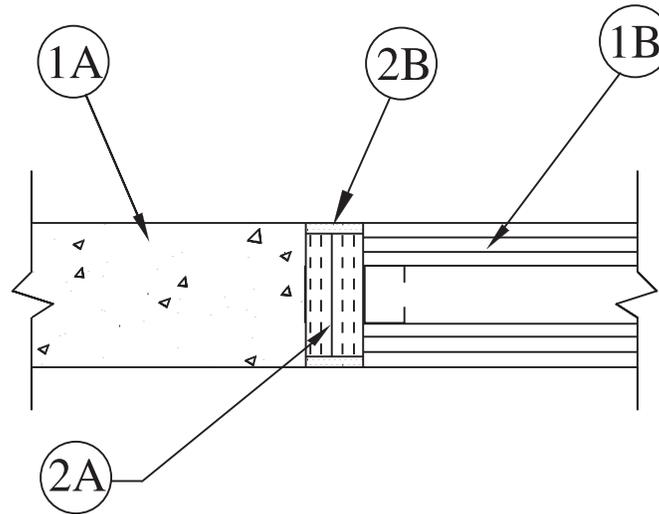

1. **Wall Assembly** – The wall assembly shall consist of the following:

- A. Min 2-3/4, 4 and 5-1/4 in. (70, 102 and 133 mm) thick reinforced lightweight or normal weight (100-150 pcf or 1600-2400 kg/m³) structural concrete for 1, 2 and 3 hr rated assemblies, respectively. Additionally, thickness of concrete wall shall be equal to or greater than thickness of gypsum board wall. Wall may also be constructed of any UL Classified **Concrete Blocks***.

See **Concrete Blocks** (CAZT) category in the Fire Resistance Directory for names of manufacturers.

- B. Nonbearing 1, 2 or 3 hr fire rated gypsum board/steel stud assembly constructed of the materials and in the manner described in the individual U400-Series Wall or Partition Design in the UL Fire Resistance Directory and shall include the following construction features:

A. **Studs** – Min 1-1/2 in. (38 mm) wide steel studs spaced max 24 in. (610 mm) OC.

B. **Gypsum Board*** – The gypsum board type, thickness, number of layers, fastener type and sheet orientation shall be as specified in the individual U400 Series Design in the UL Fire Resistance Directory.

The hourly assembly rating of the joint system is equal to the hourly fire rating of the wall assembly in which it is installed.

2. **Joint System** – Max width of joint (at time of installation of joint system) is 2 in. (51 mm) The joint system is designed to accommodate a max 12.5 percent compression or extension from its installed width. The joint system shall consist of the following:

- A. **Forming Material*** – Min 4.0 pcf (64 kg/m³) mineral wool batt insulation installed in joint opening as a permanent form. Pieces of batt cut to min width of 1-3/4, 3, or 4-1/4 in. (44, 76 or 108 mm) for 1, 2 and 3 hr rated assemblies, respectively. Pieces of batt installed edge-first into joint opening, parallel with joint direction, such that batt sections are compressed min 50 percent in thickness and such that the compressed batt sections are recessed from both surfaces of gypsum board wall to accommodate the required thickness of fill material.

ROCK WOOL MANUFACTURING CO – Delta Board

ROCKWOOL MALAYSIA SDN BHD – SAFE

ROXUL INC – SAFE

- B. **Fill, Void or Cavity Material*** – Min 1/2 in. (13 mm) thickness of fill material applied within the joint, flush with both surfaces of gypsum board wall.

3M COMPANY – FD-150+

*Bearing the UL Classification Mark

Reprinted from the Online Certifications Directory with permission from UL

© 2012 UL LLC





**UL System No. WW-D-0074
XHBN - Joint Systems**

September 01, 2017

Assembly Rating – 1 and 2 Hr (See Item 2)

L Rating At Ambient – 4 CFM/Lin Ft

L Rating At 400 F – 6 CFM/Lin Ft

Nominal Joint Width – 3/4 In.

Class II Movement Capabilities – 17% Compression or Extension

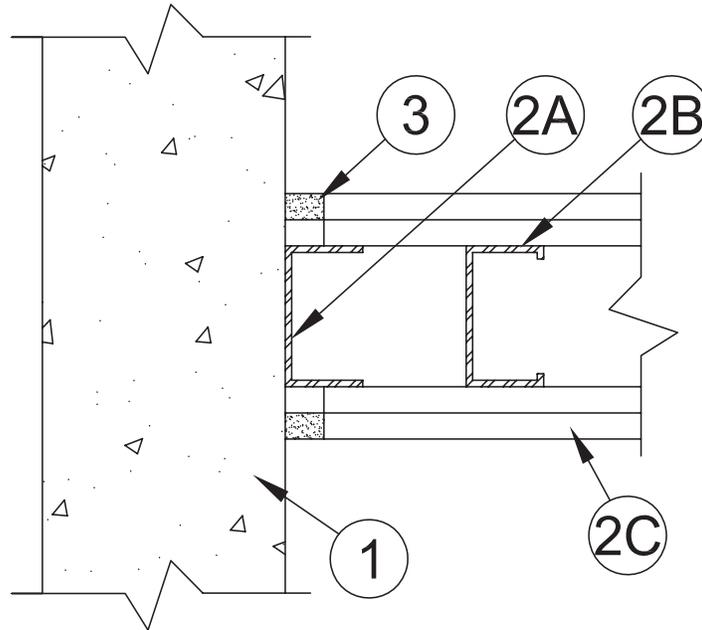

1. Concrete Wall Assembly – Min 4-1/2 in. thick reinforced lightweight or normal weight (100-150 PCF) structural concrete. Wall may also be constructed of any UL Classified **Concrete Blocks***.

See **Concrete Blocks** (CAZT) category in the Fire Resistance Directory for names of manufacturers.

2. Gypsum Wall Assembly – The 1 or 2 h fire-rated gypsum wallboard/steel stud wall assembly shall be constructed of the materials and in the manner specified in the individual U400 Series Wall or Partition Design in the UL Fire Resistance Directory and shall include the following construction features:

- A. Steel Runners** – Runners of wall assembly shall consist of min No. 25 gauge galv steel channels sized to accommodate steel studs (Item 2B). Runner to be provided with 1-1/4 in. flanges. Runner secured to concrete wall assembly with steel concrete fasteners spaced 12 in. OC.
- B. Studs** – Steel studs to be min 3-5/8 in. (92 mm) wide. Studs cut 1/2 to 3/4 in. (13 to 19 mm) less in length than assembly height. Stud spacing not to exceed 24 in. (610 mm) OC.
- C. Gypsum Board*** – Gypsum board sheets installed to a min total thickness of 5/8 in. (16 mm) and 1-1/4 in. (32 mm) on each side of wall for a 1 or 2 hr rated assemblies, respectively. Wall to be constructed as specified in the individual Wall and Partition Design in the UL Fire Resistance Directory, except that a nom 3/4 in. (19 mm) gap shall be maintained between the side of the gypsum board and the face of the concrete wall assembly.

3. Fill, Void or Cavity Material* – Caulk – Max separation between side of gypsum board and face of concrete wall assembly is 3/4 in. (19 mm). The joint system is designed to accommodate a max 17 percent compression or extension from its installed width. Min 5/8 in. (16 mm) thickness of fill material installed on each side of the wall between the side of the gypsum board and the face of the concrete wall assembly, flush with each surface of gypsum board.

3M COMPANY 3M FIRE PROTECTION PRODUCTS – FD-150+

Construction Joints

Wall to Wall

WW-D



*Indicates such products shall bear the UL or cUL Certification Mark for jurisdictions employing the UL or cUL Certification (such as Canada), respectively.

Reprinted from the Online Certifications Directory with permission from UL©

System No. WW-D-0096

November 18, 2010

Assembly Ratings – 2, 3 and 4 Hr (See Item 1)

Nominal Joint Width – 1 In.

Class II Movement Capabilities – 12.5% Compression Or Extension

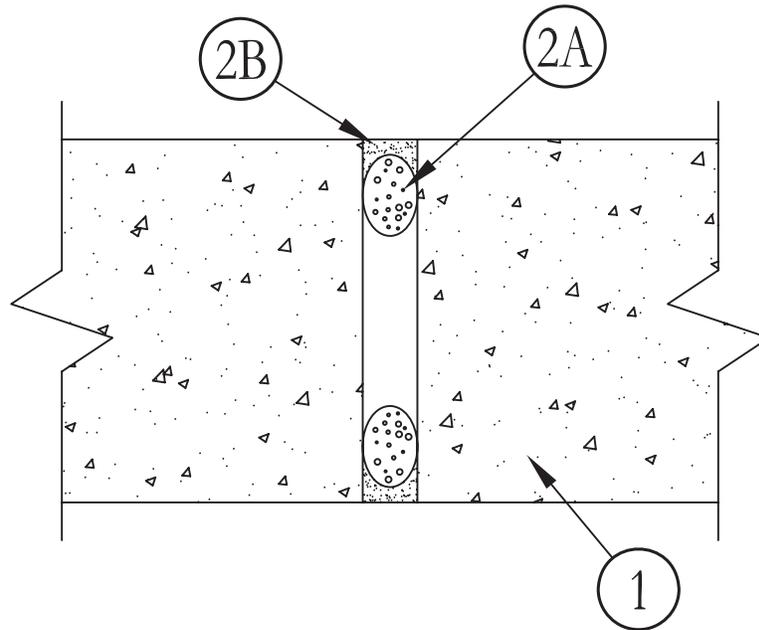

1. **Wall Assembly** – Min 7-1/2 in. (191 mm) thick reinforced lightweight or normal weight (100-150 pcf or 1600-2400 kg/m³) structural concrete. Wall may also be constructed of any UL Classified **Concrete Blocks***.
See **Concrete Blocks (CAZT)** category in the Fire Resistance Directory for names of manufacturers.
The assembly rating is equal to the hourly rating of the wall assembly.
2. **Joint System** – Max width of joint (at time of installation of joint system) is 1 in. (25 mm). The joint system is designed to accommodate a max 12.5 percent compression or extension from its installed width. The joint system shall consist of the following:
 - A. **Packing Material** – Nom 1-1/4 in. (32 mm) diameter polyethylene backer rod compressed and installed into joint. Packing material to be recessed from each surface of wall to accommodate the required thickness of fill material.
 - B. **Fill, Void or Cavity Material*** – Min 1/2 in. (13 mm) thickness of fill material applied within the joint, flush with both surfaces of wall.

3M COMPANY

3M FIRE PROTECTION PRODUCTS – FD 150+

*Bearing the UL Classification Mark

Reprinted from the Online Certifications Directory with permission from Underwriters Laboratories Inc.
Copyright © 2010 Underwriters Laboratories Inc.®



System No. WW-D-0176

July 24, 2014

ANSI/UL2079

Assembly Ratings — 1 and 2 Hr (See Item 1)

Nominal Joint Width — 2 In.

Class I Movement Capabilities — 19% Compression or Extension

CAN/ULC S115

F Ratings — 1 and 2 Hr (See Item 1)

FT Ratings — 1 and 2 Hr (See Item 1)

FH Ratings — 1 and 2 Hr (See Item 1)

FTH Ratings — 1 and 2 Hr (See Item 1)

Nominal Joint Width — 51 mm

Class I Movement Capabilities — 19% Compression or Extension

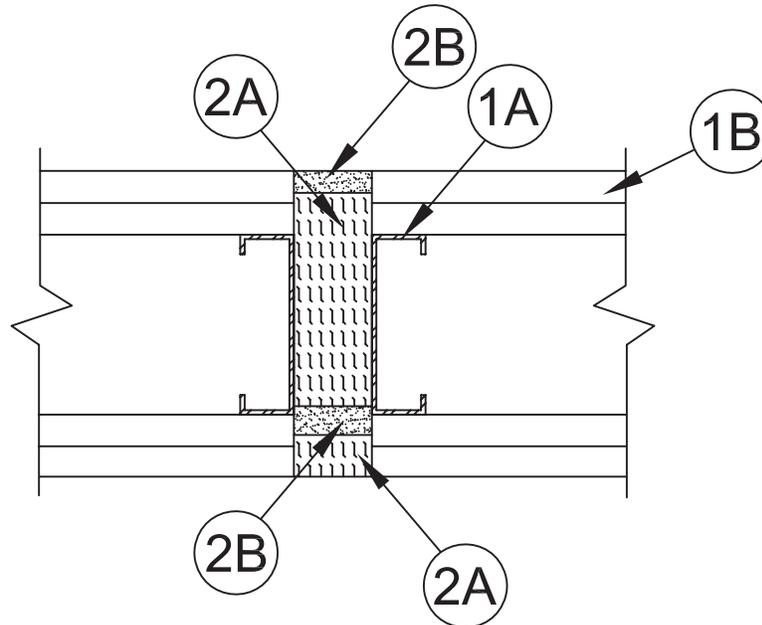

1. **Wall Assembly** — Nonbearing 1 or 2 hr fire rated gypsum board/steel stud assembly constructed of the materials and in the manner described in the individual U400, V400 or W400 Series Wall or Partition Design in the UL Fire Resistance Directory and shall include the following construction features:
 - A. **Studs** — Min 3-1/2 (89 mm) wide steel studs spaced max 24 in. (610 mm) OC. Additional studs lining opening.
 - B. **Gypsum Board*** — The gypsum board type, thickness, number of layers, fastener type and sheet orientation shall be as specified in the individual U400, V400 or W400 Series Design in the UL Fire Resistance Directory.

The hourly assembly rating of the joint system is equal to the hourly fire rating of the wall assembly in which it is installed.

2. **Joint System** — Max width of joint (at time of installation of joint system) is 2 in. (51 mm) The joint system is designed to accommodate a max 19 percent compression or extension from its installed width. The joint system shall consist of the following:
 - A. **Forming Material*** — Min 4.0 pcf (64 kg/m³) mineral wool batt insulation installed in joint opening as a permanent form. Pieces of batt cut to min width of twice the width of the joint and 1 in. wide, compressed 50% and inserted cut edge first into the joint flush with inaccessible side of wall. A 1 in. (25 mm) depth of sealant (Item 2B) is then applied. Additional pieces of batt are cut to a width of twice the width of the joint and a width of 3-7/8 in., compressed 50% and inserted cut edge first into the joint. Pieces of batt are inserted such that the compressed batt sections are recessed from the accessible surfaces of gypsum board wall to accommodate the required thickness of fill material. (Item 2B)

ROCK WOOL MANUFACTURING CO — Delta Board

ROCKWOOL MALAYSIA SDN BHD — SAFE

ROXUL INC — SAFE

- B. **Fill, Void or Cavity Material*** — Min 5/8 in. (16 mm) thickness of fill material applied within the joint from the accessible side of wall to the installed 1 in. (25 mm) depth of forming material (Item 2A). Additional 5/8 in. (16 mm) thickness installed to the forming materials (Item 2A) flush with the accessible side of wall.

3M COMPANY — FD-150+

* Indicates such products shall bear the UL or cUL Certification Mark for jurisdictions employing the UL or cUL Certification (such as Canada), respectively.

Reprinted from the Online Certifications Directory with permission from UL

© 2014 UL LLC



System No. WW-D-0177

July 24, 2014

ANSI/UL2079

Assembly Ratings — 2 Hr
Nominal Joint Width — 2 In.

Class I Movement Capabilities — 19% Compression or Extension

CAN/ULC S115

F Ratings — 2 Hr
FT Ratings — 2 Hr
FH Ratings — 2 Hr

FTH Ratings — 2 Hr

Nominal Joint Width — 51 mm

Class I Movement Capabilities — 19% Compression or Extension

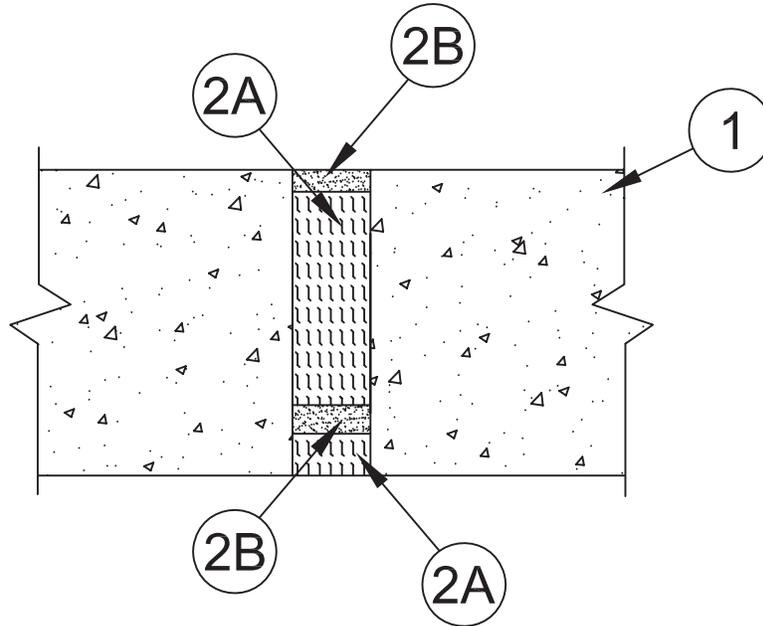

- Wall Assembly** — Min 6 in. (152 mm) thick reinforced lightweight or normal weight (100-150 pcf or 1600-2400 kg/m³) structural concrete. Wall may also be constructed of any UL Classified **Concrete Blocks***.
See **Concrete Blocks (CAZT)** category in the Fire Resistance Directory for names of manufacturers.
- Joint System** — Max width of joint (at time of installation of joint system) is 2 in. (51 mm) The joint system is designed to accommodate a max 19 percent compression or extension from its installed width. The joint system shall consist of the following:
 - Forming Material*** — Min 4.0 pcf (64 kg/m³) mineral wool batt insulation installed in joint opening as a permanent form. Pieces of batt cut to min thickness of twice the width of the joint and 1 in. wide, compressed 50% and inserted cut edge first into the joint flush with inaccessible side of wall. A 5/8 in. (16 mm) depth of sealant (Item 2B) is then applied. Additional pieces of batt are cut to a thickness of twice the width of the joint and a width of 3-7/8 in. (98 mm), compressed 50% and inserted cut edge first into the joint. Pieces of batt are inserted such that the compressed batt sections are recessed from the accessible surfaces of wall to accommodate the required thickness of fill material. (Item 2B).
ROCK WOOL MANUFACTURING CO — Delta Board
ROCKWOOL MALAYSIA SDN BHD — SAFE
ROXUL INC — SAFE
 - Fill, Void or Cavity Material*** — Min 5/8 in. (16 mm) thickness of fill material applied within the joint from the accessible side of wall to the installed 1 in. depth of forming material (Item 2A). Additional 5/8 in. (16 mm) thickness installed to the forming materials (Item 2A) flush with the accessible side of wall.
3M COMPANY — FD-150+

* Indicates such products shall bear the UL or cUL Certification Mark for jurisdictions employing the UL or cUL Certification (such as Canada), respectively.

Reprinted from the Online Certifications Directory with permission from UL

© 2014 UL LLC



Construction Joints

Wall to Wall

WW-D



UL System No. WW-D-0215
XHBN - Joint Systems
XHBN7 - Joint Systems Certified for Canada

July 31, 2018

| ANSI/UL2079 | CAN/ULC S115 |
|---|---|
| Assembly Rating — 4 Hr | F Rating — 4 Hr |
| Nominal Joint Width - 2 In. | FT Rating — 4 Hr |
| Class II Movement Capabilities — 19% Compression Or Extension | FH Rating — 4 Hr |
| L Rating at Ambient — Less than 1 CFM/Lin Ft | FTH Rating — 4 Hr |
| L Rating at 400°F — Less than 1 CFM/Lin Ft | Nominal Joint Width - 51 mm |
| | Class II Movement Capabilities — 19% Compression Or Extension |
| | L Rating at Ambient — Less than 1.55 L/s/m |
| | L Rating at 204°C — Less than 1.55 L/s/m |

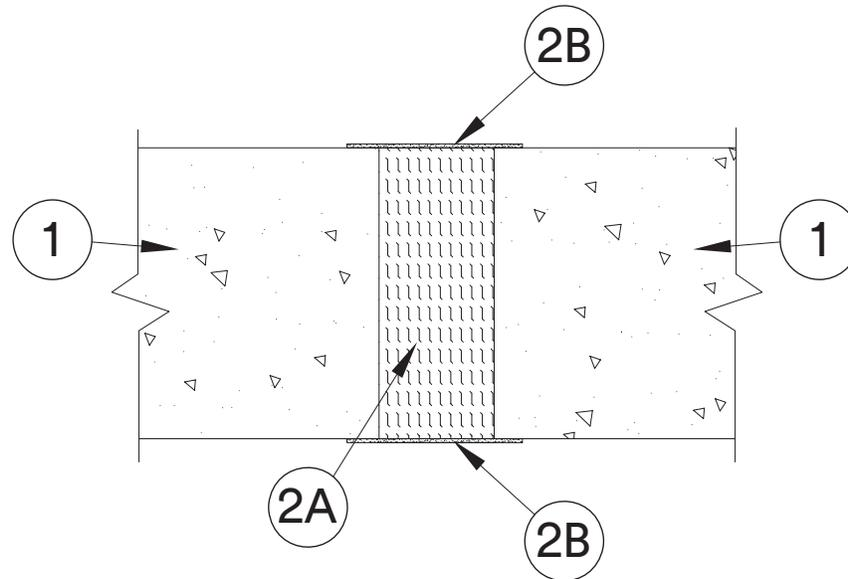

1. **Wall Assembly** – Min 6 in. (152 mm) thick steel-reinforced lightweight or normal weight (100-150 pcf or 1600-2400 kg/m³) structural concrete.
2. **Joint System** – Max width of joint (at time of installation of joint system) is 2 in. (51 mm). The joint system is designed to accommodate a max 19 percent compression or extension from its installed width. The joint system shall consist of the following:
 - A. **Forming Material*** – Min 4 pcf (64 kg/m³) mineral wool batt insulation installed in joint opening as a permanent form. Batt cut to min width of 6 in. (152 mm) and installed edge-first into joint opening, parallel with joint direction, such that batt sections are compressed min 50 percent in thickness and such that the compressed batt sections are flush with both surfaces of wall. Adjoining lengths of batt to be tightly butted with butted seams spaced min 48 in. (1.2 m) apart along the length of the joint.

INDUSTRIAL INSULATION GROUP L L C – MinWool-1200 Safing
JOHNS MANVILLE – Safing
THERMAFIBER INC – Type SAF
ROCK WOOL MANUFACTURING CO – Delta Safing Board
ROCKWOOL MALAYSIA SDN BHD – Type Safe
ROCKWOOL – Type Safe
 - B. **Fill, Void or Cavity Material* – Tape** – Tape cut to size and press applied to both surfaces of wall to completely cover mineral wool and overlap a min of 1 in. (25 mm) onto the concrete at both sides of joint. Tape shall be applied in minimum 1 ft (305 mm) lengths along the joint at both sides of wall and adjoining lengths of Tape shall overlap min 1/2 in. (13 mm).

3M COMPANY 3M FIRE PROTECTION PRODUCTS – 3M Fire and Water Barrier Tape

UL System No. WW-D-0215 (cont.)

B1. Fill, Void or Cavity Material*– As an alternate o Item B, min 1/16 in. (1.6 mm) dry thickness (min 1/8 in. or 3.2 mm wet thickness) of fill material sprayed or brushed to both surfaces of wall to completely cover mineral wool and overlap a min of 1/2 in. (13 mm) onto the concrete at both sides of joint.

3M COMPANY 3M FIRE PROTECTION PRODUCTS – FireDam™ Spray 200

*Indicates such products shall bear the UL or cUL Certification Mark for jurisdictions employing the UL or cUL Certification (such as Canada), respectively.

Reprinted from the Online Certifications Directory with permission from UL©

Construction Joints

Wall to Wall

WW-D



3M Industrial Adhesives and Tapes
Fire Protection Products
3M Center, Building 230-B-S-37
St. Paul, MN 55144-1000



UL System No. WW-D-0227
XHBN - Joint Systems
XHBN7 - Joint Systems Certified for Canada

September 26, 2018

| ANSI/UL2079 | CAN/ULC S115 |
|--|--|
| Assembly Ratings — 1 and 2 Hr (See Item 1) | F Ratings — 1 and 2 Hr (See Item 1) |
| Nominal Joint Width - 2 In. | FT Ratings — 1 and 2 Hr (See Item 1) |
| Class I Movement Capabilities — 19% Compression or Extension | FH Ratings — 1 and 2 Hr (See Item 1) |
| | FTH Ratings — 1 and 2 Hr (See Item 1) |
| | Nominal Joint Width - 51 mm |
| | Class I Movement Capabilities — 19% Compression or Extension |

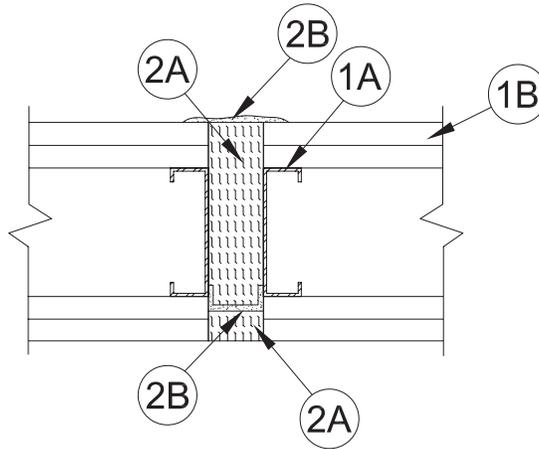

1. Wall Assembly – Nonbearing 1 or 2 hr fire rated gypsum board/steel stud assembly constructed of the materials and in the manner described in the individual U400, V400 or W400 Series Wall or Partition Design in the UL Fire Resistance Directory and shall include the following construction features:

- A. Studs** — Min 3-1/2 (89 mm) wide steel studs spaced max 24 in. (610 mm) OC. Additional studs lining opening.
- B. Gypsum Board*** — The gypsum board type, thickness, number of layers, fastener type and sheet orientation shall be as specified in the individual U400, V400 or W400 Series Design in the UL Fire Resistance Directory.

The hourly assembly rating of the joint system is equal to the hourly fire rating of the wall assembly in which it is installed.

2. Joint System — Max width of joint (at time of installation of joint system) is 2 in. (51 mm) The joint system is designed to accommodate a max 19 percent compression or extension from its installed width. The joint system shall consist of the following:

- A. Forming Material*** — Min 4.0 pcf (64 kg/m³) mineral wool batt insulation installed in joint opening as a permanent form. Pieces of batt cut to min width of twice the width of the joint and 1 in. wide, compressed 50% and inserted cut edge first into the joint flush with inaccessible side of wall. A min 1/16 in. (1.6 mm) dry thickness (min 1/8 in. or 3.2 mm wet thickness) of spray is then applied. Additional pieces of batt are cut to a thickness of twice the width of the joint and a width to fill the remaining depth of the joint (3-3/4 in. for 1 hr, 5 in. for 2 hr), compressed 50% and inserted cut edge first into the joint. Pieces of batt are inserted such that the compressed batt sections are flush with the accessible surfaces of gypsum board wall.

INDUSTRIAL INSULATION GROUP LLC — MinWool-1200 Safing

JOHNS MANVILLE — Safing

THERMAFIBER INC — Type SAF

ROCK WOOL MANUFACTURING CO — Delta Board

ROCKWOOL MALAYSIA SDN BHD — Type Safe

ROCKWOOL — Type Safe

- B. Fill, Void or Cavity Material* — Caulk or Sealant** — Min 1/16 in. (1.6 mm) dry thickness (min 1/8 in. or 3.2 mm wet thickness) of fill material sprayed or brushed within the joint from the accessible side of wall to the installed over the 1 in. (25 mm) depth of forming material (Item 2A). Min 1/16 in. (1.6 mm) dry thickness (min 1/8 in. or 3.2 mm wet thickness) thickness sprayed or brushed to completely the forming materials (Item 2A) and overlapping both sides of the opening a min 1/2 in (13 mm) on the accessible side of wall.

3M COMPANY 3M FIRE PROTECTION PRODUCTS — FireDam™ Spray 200

*Indicates such products shall bear the UL or cUL Certification Mark for jurisdictions employing the UL or cUL Certification (such as Canada), respectively.

Reprinted from the Online Certifications Directory with permission from UL©

3M Industrial Adhesives and Tapes
Fire Protection Products
 3M Center, Building 230-B-S-37
 St. Paul, MN 55144-1000





UL System No. WW-D-0228
XHBN - Joint Systems
XHBN7 - Joint Systems Certified for Canada

September 26, 2018

| ANSI/UL2079 | CAN/ULC S115 |
|--|---|
| Assembly Rating — 2 Hr | F Rating — 2 Hr |
| Nominal Joint Width - 2 In. | FT Rating — 2 Hr |
| Class I Movement Capabilities — 19% Compression or Extension | FH Rating — 2 Hr |
| | FTH Rating — 2 Hr |
| | Nominal Joint Width - 51 mm |
| | Class I Movement Capabilities —19% Compression or Extension |

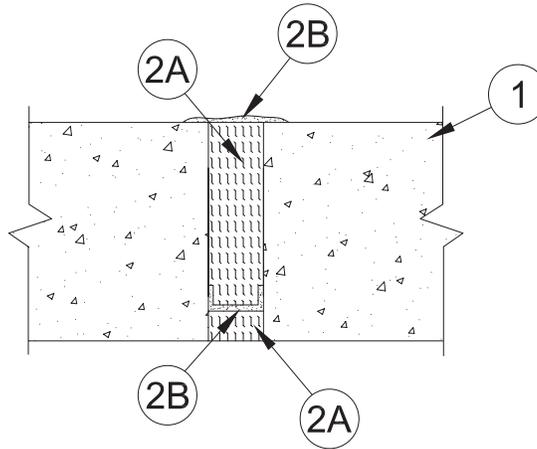

- 1. Wall Assembly** – Min 6 in. (152 mm) thick reinforced lightweight or normal weight (100-150 pcf or 1600-2400 kg/m³) structural concrete. Wall may also be constructed of any UL Classified Concrete Blocks*.
 See **Concrete Blocks (CAZT)** category in the Fire Resistance Directory for names of manufacturers.
- 2. Joint System** — **Max width of joint (at time of installation of joint system) is 2 in. (51 mm)** The joint system is designed to accommodate a max 19 percent compression or extension from its installed width. The joint system shall consist of the following:

A. Forming Material* — Min 4.0 pcf (64 kg/m³) mineral wool batt insulation installed in joint opening as a permanent form. Pieces of batt cut to min width of twice the width of the joint and 1 in. wide, compressed 50% and inserted cut edge first into the joint flush with inaccessible side of wall. A min 1/16 in. (1.6 mm) dry thickness (min 1/8 in. or 3.2 mm wet thickness) of spray is then applied. Additional pieces of batt are cut to a thickness of twice the width of the joint and a width to fill the remaining depth of the joint (3-3/4 in. for 1 hr, 5 in. for 2 hr). compressed 50% and inserted cut edge first into the joint. Pieces of batt are inserted such that the compressed batt sections are flush with the accessible surfaces of wall.

INDUSTRIAL INSULATION GROUP L L C — MinWool-1200 Safing

JOHNS MANVILLE — Safing

THERMAFIBER INC — Type SAF

ROCK WOOL MANUFACTURING CO — Delta Board

ROCKWOOL MALAYSIA SDN BHD — Type Safe

ROCKWOOL — Type Safe

B. Fill, Void or Cavity Material* — Min 1/16 in. (1.6 mm) dry thickness (min 1/8 in. or 3.2 mm wet thickness) of fill material sprayed or brushed within the joint from the accessible side of wall to the installed over the 1 in. (25 mm) depth of forming material (Item 2A). Min 1/16 in. (1.6 mm) dry thickness (min 1/8 in. or 3.2 mm wet thickness) thickness sprayed or brushed to completely the forming materials (Item 2A) and overlapping both sides of the opening a min 1/2 in (13 mm) on the accessible side of wall.

3M COMPANY 3M FIRE PROTECTION PRODUCTS — FireDam™ Spray 200

Construction Joints

Wall to Wall

WW-D



*Indicates such products shall bear the UL or cUL Certification Mark for jurisdictions employing the UL or cUL Certification (such as Canada), respectively.

Reprinted from the Online Certifications Directory with permission from UL©

System No. WW-D-1003

May 09, 2013

ANSI/UL2079

Assembly Rating – 3 Hr

Nominal Joint Width – 4 In.

Class II Movement Capabilities – 31% Compression or Extension

CAN/ULC S115

F Rating – 3 Hr

FT Rating – 3 Hr

FH Rating – 3 Hr

FTH Rating – 3 Hr

Nominal Joint Width – 4 In.

Class II Movement Capabilities – 31% Compression or Extension

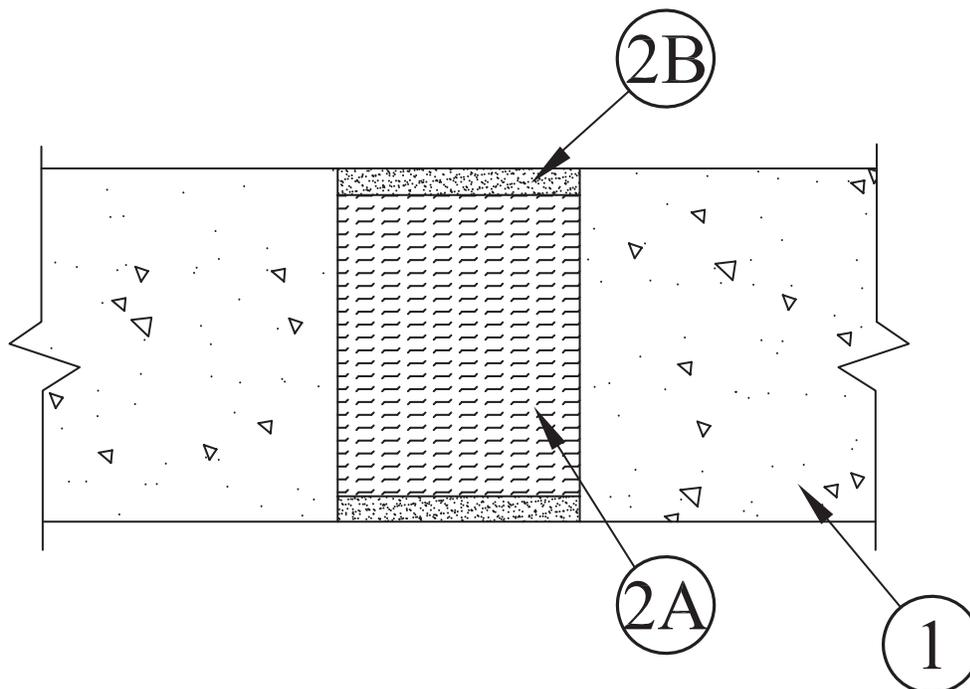

1. **Wall Assembly** – Min 5 in. (127 mm) thick reinforced lightweight or normal weight (100-150 pcf or 1600-2400 kg/m³) structural concrete. Wall may also be constructed of any UL Classified **Concrete Blocks***.
See **Concrete Blocks (CAZT)** category in the Fire Resistance Directory for names of manufacturers.
2. **Joint System** – Max width of joint (at time of installation of joint system) is 4 in. (102 mm). The joint system is designed to accommodate a max 31 percent compression or extension from its installed width. The joint system shall consist of the following:
 - A. **Forming Material*** – Min 4.0 pcf (64 kg/m³) mineral wool batt insulation installed in joint opening as a permanent form. Pieces of batt cut to min width of 4 in. (102 mm) and installed horizontally, edge-first into joint opening, such that batt sections are compressed min 50 percent in thickness and such that the compressed batt sections are recessed from each surface of wall to accommodate the required thickness of fill material. Adjoining lengths of batt to be tightly-butted with butted seams spaced min 12 in. (305 mm) apart along the length of the joint.
IIG MINWOOL LLC – MinWool-1200 Safing
ROCK WOOL MANUFACTURING CO – Delta Board
ROCKWOOL MALAYSIA SDN BHD – Type Safe
ROXUL INC – Type Safe
THERMAFIBER INC – Type SAF
 - B. **Fill, Void or Cavity Material*** – Min 1/2 in. (13 mm) thickness of fill material applied within the joint, flush with each surface of wall.
3M COMPANY – FB-1000 NS or FB-2000

*Bearing the UL Classification Mark

Reprinted from the Online Certifications Directory with permission from UL

© 2013 UL LLC



System No. WW-D-1004

May 09, 2013

ANSI/UL2079

Assembly Rating – 2 Hr

Nominal Joint Width – 4 In.

Class II Movement Capabilities – 25% Compression or Extension

CAN/ULC S115

F Rating – 2 Hr

FT Rating – 2 Hr

FH Rating – 2 Hr

FTH Rating – 2 Hr

Nominal Joint Width – 4 In.

Class II Movement Capabilities – 25% Compression or Extension

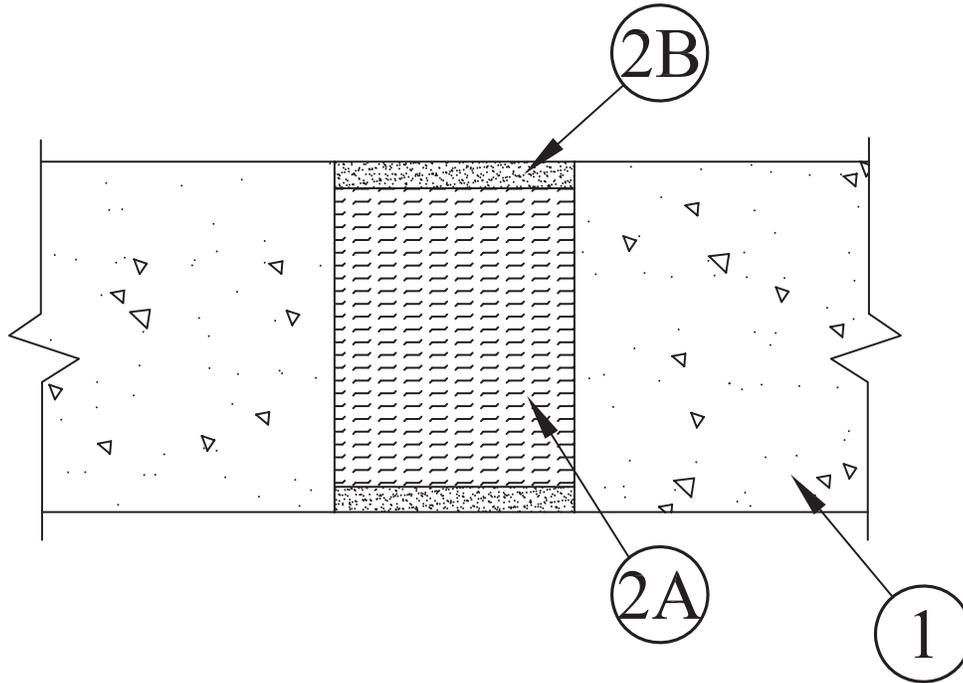

1. **Wall Assembly** – Min 4-1/2 in. (114 mm) thick reinforced lightweight or normal weight (100-150 pcf or 1600-2400 kg/m³) structural concrete. Wall may also be constructed of any UL Classified **Concrete Blocks***.
See **Concrete Blocks (CAZT)** category in the Fire Resistance Directory for names of manufacturers.
2. **Joint System** – Max width of joint (at time of installation of joint system) is 4 in. (102 mm). The joint system is designed to accommodate a max 25 percent compression or extension from its installed width. The joint system shall consist of the following:

- A. **Forming Material*** – Min 4.0 pcf (64 kg/m³) mineral wool batt insulation installed in joint opening as a permanent form. Pieces of batt cut to min width of 4 in. (102 mm) and installed horizontally, edge-first into joint opening, such that batt sections are compressed min 50 percent in thickness and such that the compressed batt sections are recessed from each surface of wall to accommodate the required thickness of fill material. Adjoining lengths of batt to be tightly-butted with butted seams spaced min 12 in. (305 mm) apart along the length of the joint.

IIG MINWOOL LLC – MinWool-1200 Safing

ROCK WOOL MANUFACTURING CO – Delta Board

ROCKWOOL MALAYSIA SDN BHD – Type Safe

ROXUL INC – Type Safe

THERMAFIBER INC – Type SAF

- B. **Fill, Void or Cavity Material*** – Min 1/4 in. (6 mm) thickness of fill material applied within the joint, flush with each surface of wall.

3M COMPANY – FB-1000 NS or FB-2000

*Bearing the UL Classification Mark

Reprinted from the Online Certifications Directory with permission from UL

© 2013 UL LLC



System No. WW-D-1010

December 04, 2000

Assembly Rating – 3 Hr

Nominal Joint Width – 4 In.

Class II Movement Capabilities – 12.5% Compression Or Extension

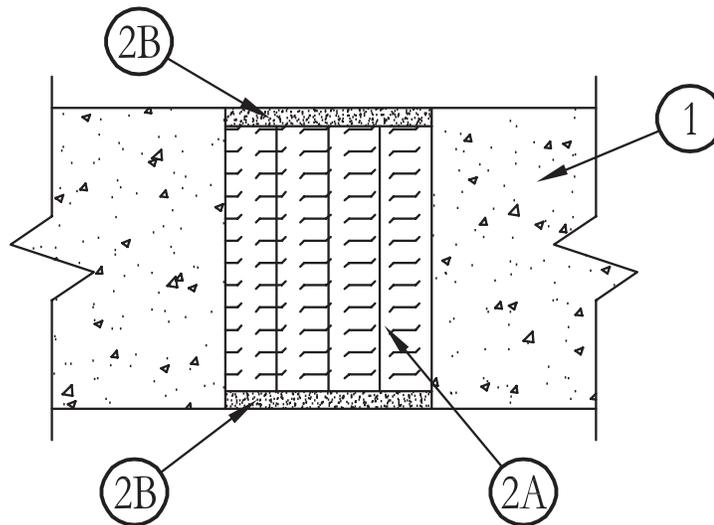

1. **Wall Assembly** – Min 4-1/2 in. thick reinforced lightweight or normal weight (100-150 pcf) structural concrete. Wall may also be constructed of any UL Classified **Concrete Blocks***.
See **Concrete Blocks** (CAZT) category in the Fire Resistance Directory for names of manufacturers.
2. **Joint System** – Max width of joint (at time of installation of joint system) is 4 in. The joint system is designed to accommodate a max 12.5 percent compression or extension from its installed width. The joint system shall consist of the following:
 - A. **Forming Material*** – Min 4.0 pcf mineral wool batt insulation installed in joint opening as a permanent form. Pieces of batt cut to min width of 4 in. and installed edge-first into joint opening, parallel with joint direction, such that batt sections are compressed min 50 percent in thickness and such that the compressed batt sections are recessed from top surface of floor to accommodate the required thickness of fill material. Adjoining lengths of batt to be tightly-butted with butted seams spaced min 12 in. apart along the length of the joint.
HIG MINWOOL L L C – MinWool-1200 Safing
ROCKWOOL MALAYSIA SDN BHD – Type Safe
ROXUL INC – Type Safe
THERMAFIBER INC – Type SAF
 - B. **Fill, Void or Cavity Material*** – Min 1/4 in. thickness of fill material applied within the joint, flush with both surfaces of wall.
3M COMPANY – FB-2000+

*Bearing the UL Classification Mark

Reprinted from the Online Certifications Directory with permission from UL
© 2012 UL LLC

System No. WW-D-1023

January 11, 2013

Assembly Rating – 2 Hr

L Rating At Ambient – Less Than 1 CFM/Lin Ft

L Rating At 400 F – Less Than 1 CFM/Lin Ft

Nominal Joint Width – 4 In.

Class II Movement Capabilities – 15.6% Compression or Extension

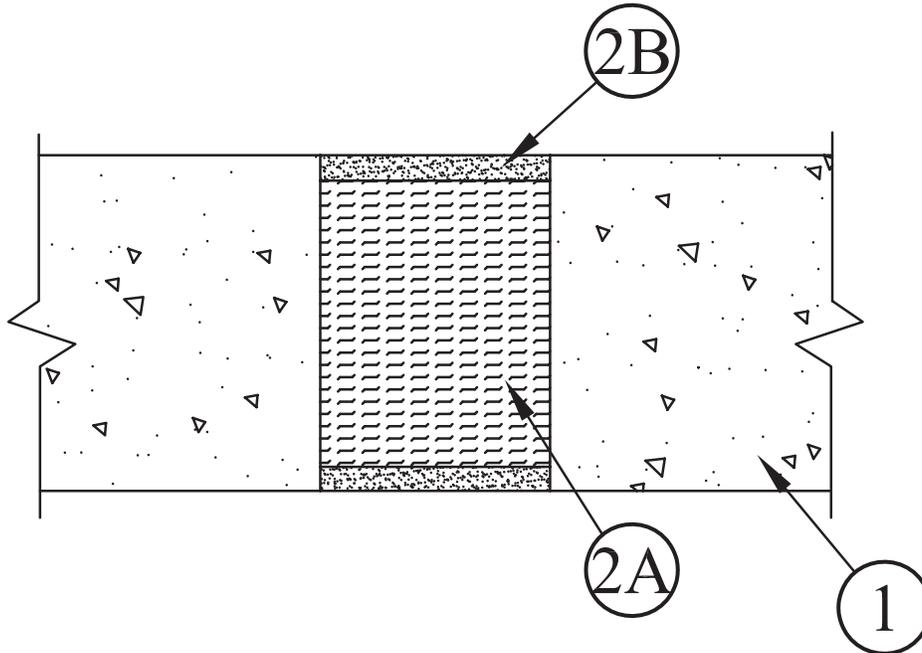

1. **Wall Assembly** – Min 5 in. thick steel-reinforced lightweight or normal weight (100-150 pcf) structural concrete. Wall may also be constructed of any UL Classified **Concrete Blocks***.
2. **Joint System** – **Max width of joint (at time of installation of joint system) is 4 in. The joint system is designed to accommodate a max 15.6 percent compression or extension from its installed width.** The joint system shall consist of the following:
 - A. **Forming Material*** – Min 4.0 pcf mineral wool batt insulation installed in joint opening as a permanent form. Batt cut to min width of 4 in. and installed edge-first into joint opening, parallel with joint direction, such that batt sections are compressed min 50 percent in thickness and such that the compressed batt sections are recessed from both surfaces of wall to accommodate the required thickness of fill material. Adjoining lengths of batt to be tightly-butted with butted seams spaced min 48 in. apart along the length of the joint.

IIG MINWOOL LLC – Paroc Safing Insulation
ROCK WOOL MANUFACTURING CO – Delta Safing Board
ROCKWOOL MALAYSIA SDN BHD – Type Safe
ROXUL INC – Type Safe
THERMAFIBER INC – Type SAF
 - B. **Fill, Void or Cavity Material*** – Min 1/2 in. thickness of fill material applied within the joint, flush with both surfaces of wall.

3M COMPANY – FB 1000 NS

*Bearing the UL Classification Mark

Reprinted from the Online Certifications Directory with permission from UL
© 2013 UL LLC





UL System No. WW-D-1202
XHBN - Joint Systems
XHBN7 - Joint Systems Certified for Canada

July 31, 2018

| ANSI/UL1479 (ASTM E814) | CAN/ULC S115 |
|---|---|
| Assembly Ratings — 1 and 2 Hr (See Item 1) | F Ratings — 1 and 2 Hr (See Item 1) |
| Nominal Joint Width — 4 In. | FT Ratings — 1 and 2 Hr (See Item 1) |
| Class II Movement Capabilities - 25% Compression or Extension | FH Ratings — 1 and 2 Hr (See Item 1) |
| | FTH Ratings — 1 and 2 Hr (See Item 1) |
| | Nominal Joint Width — 102 mm |
| | Class II Movement Capabilities - 25% Compression or Extension |

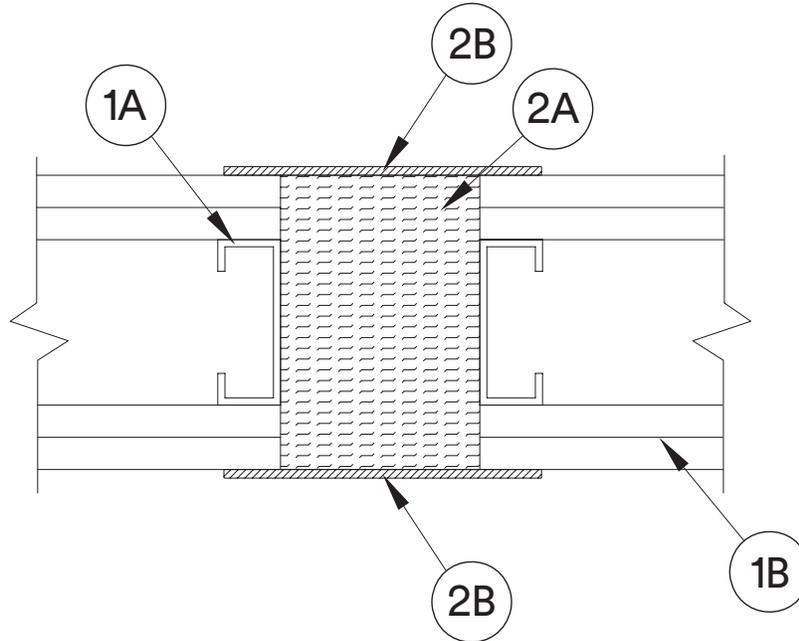

1. Wall Assembly – The 1 or 2 hr fire rated gypsum board/steel stud assembly constructed of the materials and in the manner described in the individual U400, V400 or W400 Series Wall or Partition Design in the UL Fire Resistance Directory and shall include the following construction features:

A. Studs – Min 3-1/2 in. (89 mm) wide steel studs spaced max 24 in. (610 mm) OC.

B. Gypsum Board* – Gypsum board sheets installed to a min total thickness of 5/8 in. (16 mm) or 1-1/4 in. (32 mm) on each side of wall for 1 and 2 hr fire rated assemblies, respectively. The gypsum board type, number of layers, fastener type and sheet orientation shall be as specified in the individual U400, V400 or W400 Series Design in the UL Fire Resistance Directory.

The hourly assembly rating of the joint system is equal to the hourly fire rating of the wall assembly in which it is installed.

2. Joint System – Max width of joint (at time of installation of joint system) is 4 in. (102 mm). The joint system is designed to accommodate a max 25 percent compression or extension from its installed width. The joint system shall consist of the following:

A. Forming Material* – Min 4.0 pcf (64 kg/m³) mineral wool batt insulation installed in joint opening as a permanent form. Pieces of batt cut to min width of 4-3/4 or 6 in. (121 or 152 mm) for 1 and 2 hr rated assemblies, respectively. Pieces of batt installed edge-first into joint opening, parallel with joint direction, such that batt sections are compressed min 50 percent in thickness and flush with both surfaces of wall.

INDUSTRIAL INSULATION GROUP LLC – MinWool-1200 Safing

ROCK WOOL MANUFACTURING CO – Delta Safing Insulation

ROCKWOOL MALAYSIA SDN BHD – SAFE Mineral Wool

ROCKWOOL – SAFE Mineral Wool

JOHNS MANVILLE – Safing

THERMAFIBER INC – Type SAF

UL System No. WW-D-1202 (cont.)

B. Fill, Void or Cavity Material* – Tape – Tape cut to size and press applied to completely cover mineral wool forming material along length of joint, lapping min 1 in. (25 mm) onto the gypsum board at each side of joint. Tape to be applied in 1 ft (305 mm) (or greater) lengths and adjoining lengths of Tape shall overlap min 1/2 in. (13 mm). Tape shall be applied at both sides of wall.

3M COMPANY 3M FIRE PROTECTION PRODUCTS – 3M Fire and Water Barrier Tape

B1. Fill, Void or Cavity Material* – As an alternate to Item B, min 1/16 in. (1.6 mm) dry thickness (min 1/8 in. or 3.2 mm wet thickness) of fill material sprayed or brushed to both surfaces of wall to completely cover mineral wool and overlap a min of 1/2 in. (13 mm) onto the concrete at both sides of joint.

3M COMPANY 3M FIRE PROTECTION PRODUCTS – FireDam™ Spray 200

*Indicates such products shall bear the UL or cUL Certification Mark for jurisdictions employing the UL or cUL Certification (such as Canada), respectively.

Reprinted from the Online Certifications Directory with permission from UL©

Construction Joints

Wall to Wall

WW-D



July 31, 2018

| ANSI/UL1479 (ASTM E814) | CAN/ULC S115 |
|---|---|
| Assembly Rating — 2 Hr | F Rating — 2 Hr |
| Nominal Joint Width — 4 In. | FT Rating — 2 Hr |
| Class II Movement Capabilities - 25% Compression or Extension | FH Rating — 2 Hr |
| | FTH Rating — 2 Hr |
| | Nominal Joint Width — 102 mm |
| | Class II Movement Capabilities - 25% Compression or Extension |

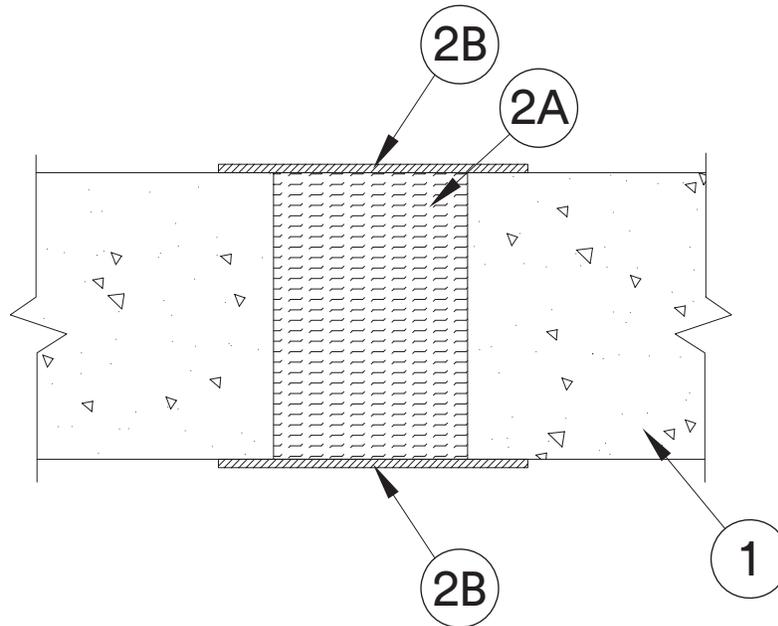

1. Wall Assembly – Wall Assembly – Min 4-3/4 in. (121 mm) thick reinforced lightweight or normal weight (100-150 pcf or 1600-2400 kg/m³) structural concrete. Wall may also be constructed of any UL Classified Concrete Blocks*.

See **Concrete Blocks** (CAZT) category in the Fire Resistance Directory for names of manufacturers.

2. Joint System – Max width of joint (at time of installation of joint system) is 4 in. (102 mm). The joint system is designed to accommodate a max 25 percent compression or extension from its installed width. The joint system shall consist of the following:

A. Forming Material* – Min 4.0 pcf (64 kg/m³) mineral wool batt insulation installed in joint opening as a permanent form. Pieces of batt cut to min width of 4-3/4 in. (121 mm) and installed edge-first into joint opening, parallel with joint direction, such that batt sections are compressed min 50 percent in thickness and flush with both surfaces of wall.

INDUSTRIAL INSULATION GROUP L L C – MinWool-1200 Safing

ROCK WOOL MANUFACTURING CO – Delta Safing Insulation

ROCKWOOL MALAYSIA SDN BHD – SAFE Mineral Wool

ROCKWOOL – SAFE Mineral Wool

JOHNS MANVILLE – Safing

THERMAFIBER INC – Type SAF

B. Fill, Void or Cavity Material* – Tape – Tape cut to size and press applied to completely cover mineral wool forming material along length of joint, lapping min 1 in. (25 mm) onto the concrete at each side of joint. Tape to be applied in 1 ft (305 mm) (or greater) lengths and adjoining lengths of Tape shall overlap min 1/2 in. (13 mm). Tape shall be applied at both sides of wall.

3M COMPANY 3M FIRE PROTECTION PRODUCTS – 3M Fire and Water Barrier Tape

UL System No. WW-D-1203 (cont.)

B1. Fill, Void or Cavity Material* – As an alternate to Item B, min 1/16 in. (1.6 mm) dry thickness (min 1/8 in. or 3.2 mm wet thickness) of fill material sprayed or brushed to both surfaces of wall to completely cover mineral wool and overlap a min of 1/2 in. (13 mm) onto the concrete at both sides of joint.

3M COMPANY 3M FIRE PROTECTION PRODUCTS – FireDam™ Spray 200

*Indicates such products shall bear the UL or cUL Certification Mark for jurisdictions employing the UL or cUL Certification (such as Canada), respectively.

Reprinted from the Online Certifications Directory with permission from UL©

Construction Joints

Wall to Wall

WW-D



3M Industrial Adhesives and Tapes
Fire Protection Products
3M Center, Building 230-B-S-37
St. Paul, MN 55144-1000



UL System No. WW-D-1204
XHBN - Joint Systems
XHBN7 - Joint Systems Certified for Canada

July 31, 2018

| ANSI/UL2079 | CAN/ULC S115 |
|---|---|
| Assembly Rating — 3 Hr | F Rating — 3 Hr |
| Nominal Joint Width - 4 In. | FT Rating — 3 Hr |
| Class II Movement Capabilities — 19% Compression Or Extension | FH Rating — 3 Hr |
| L Rating at Ambient — Less than 1 CFM/Lin Ft | FTH Rating — 3 Hr |
| L Rating at 400°F — Less than 1 CFM/Lin Ft | Nominal Joint Width - 102 mm |
| | Class II Movement Capabilities — 19% Compression Or Extension |
| | L Rating at Ambient — Less than 1.55 L/s/m |
| | L Rating at 204°C — Less than 1.55 L/s/m |

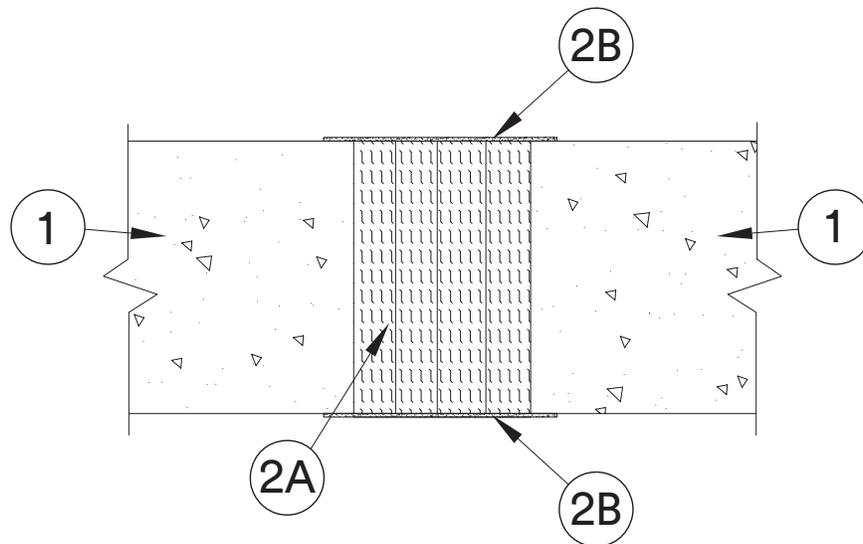

- Wall Assembly** – Min 6 in. (152 mm) thick steel-reinforced lightweight or normal weight (100-150 pcf or 1600-2400 kg/m³) structural concrete.
- Joint System** – Max width of joint (at time of installation of joint system) is 4 in. (102 mm). The joint system is designed to accommodate a max 19 percent compression or extension from its installed width. The joint system shall consist of the following:
 - Forming Material*** – Min 4 pcf (64 kg/m³) mineral wool batt insulation installed in joint opening as a permanent form. Batt cut to min width of 6 in. (152 mm) and installed edge-first into joint opening, parallel with joint direction, such that batt sections are compressed min 50 percent in thickness and such that the compressed batt sections are flush with the both surfaces of wall. Adjoining lengths of batt to be tightly-butted with butted seams spaced min 36 in. (914 mm) apart along the length of the joint.

INDUSTRIAL INSULATION GROUP L L C – MinWool-1200 Safing
JOHNS MANVILLE – Safing
ROCK WOOL MANUFACTURING CO – Delta Board
ROCKWOOL MALAYSIA SDN BHD – Type Safe
ROCKWOOL – Type Safe
THERMAFIBER INC – Type SAF
 - Fill, Void or Cavity Material* – Tape** – Tape cut to size and press applied to both surfaces of wall to completely cover mineral wool and overlap a min of 1 in. (25 mm) onto the concrete at both sides of joint. Tape shall be applied in minimum 1 ft (305 mm) lengths along the joint at both sides of wall and adjoining lengths of Tape shall overlap min 1/2 in. (13 mm).
3M COMPANY 3M FIRE PROTECTION PRODUCTS – 3M Fire and Water Barrier Tape

Construction Joints

Wall to Wall

WW-D

UL System No. WW-D-1204 (cont.)

B1. Fill, Void or Cavity Material* – As an alternate to Item B, min 1/16 in. (1.6 mm) dry thickness (min 1/8 in. or 3.2 mm wet thickness) of fill material sprayed or brushed to both surfaces of wall to completely cover mineral wool and overlap a min of 1/2 in. (13 mm) onto the concrete at both sides of joint..

3M COMPANY 3M FIRE PROTECTION PRODUCTS – FireDam™ Spray 200

*Indicates such products shall bear the UL or cUL Certification Mark for jurisdictions employing the UL or cUL Certification (such as Canada), respectively.

Reprinted from the Online Certifications Directory with permission from UL©

Construction Joints

Wall to Wall

WW-D



3M Industrial Adhesives and Tapes
Fire Protection Products
3M Center, Building 230-B-S-37
St. Paul, MN 55144-1000

System No. WW-S-0001

May 09, 2013

Assembly Rating — 2 Hr
 L Rating At Ambient — Less Than 1 CFM/LIN Ft
 L Rating At 400 F — Less Than 1 CFM/LIN Ft
 Joint Width — 1 In. Max

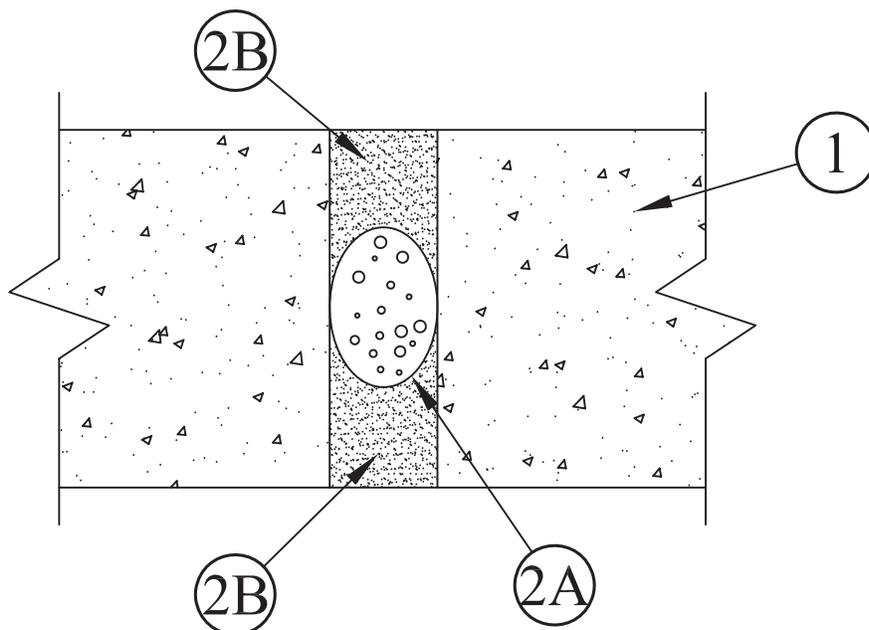

1. **Wall Assembly** – Min 4-1/2 in. (114 mm) thick reinforced lightweight or normal weight (100-150 pcf or 1600-2400 kg/m³) structural concrete. Wall may also be constructed of any UL Classified **Concrete Blocks***. See **Concrete Blocks** (CAZT) category in the Fire Resistance Directory for names of manufacturers.
2. **Joint System** – Max width of joint is 1 in. (25 mm). The joint system shall consist of the following:
 - A. **Packing Material** – Max width of joint is 1 in. (25 mm). Open cell polyurethane foam backer rod, used as a permanent form. Packing material to be recessed each surface of wall to accommodate the required thickness of fill material.
 - B. **Fill, Void or Cavity Material*** – Min 1-1/2 in. (38 mm) thickness of fill material applied within the joint, flush with each surface of wall.

3M COMPANY – FB-1000 NS, FB-2000 or FB-2000+

*Bearing the UL Classification Mark

Reprinted from the Online Certifications Directory with permission from UL
 © 2013 UL LLC



System No. WW-S-0004

May 09, 2013

ANSI/UL2079

Assembly Rating – 2 Hr
Nominal Joint Width – 3/4 In.

CAN/ULC S115

F Rating – 2 Hr
FT Rating – 2 Hr
FH Rating – 2 Hr
FTH Rating – 2 Hr
Nominal Joint Width – 3/4 In.

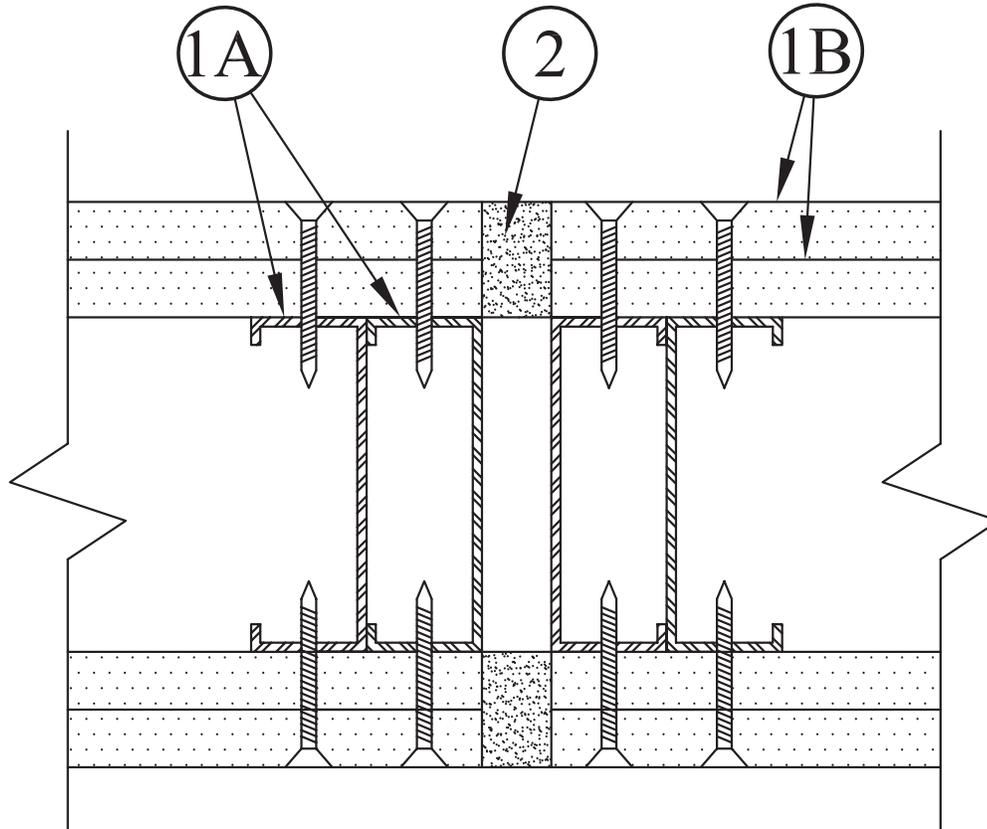

- Wall Assembly** – Nonbearing 2 hr fire rated gypsum wallboard/stud assembly constructed of the materials and in the manner described in the individual U400-Series Wall or Partition Design in the UL Fire Resistance Directory and shall include the following construction features:
 - Studs** – Min 3-5/8 in. (92 mm) wide by 1-1/4 in. (32 mm) deep corrosion protected min 25 MSG steel channels. Steel stud spacing not to exceed 24 in. (610 mm) OC.
 - Gypsum Board*** – Two layers 5/8 in. (16 mm) thick gypsum wallboard, as specified in the individual U400-Series Design.
- Joint System** – Max width of joint is 3/4 in. (19 mm). The joint system shall consist of the following:

Fill, Void or Cavity Material* – Min 1-1/4 in. (32 mm) thickness of fill material applied within the joint, flush with each surface of wall.
3M COMPANY – FB-1000 NS, FB-2000 or FB-2000+

*Bearing the UL Classification Mark

Reprinted from the Online Certifications Directory with permission from UL
© 2013 UL LLC



System No. WW-S-0008

September 08, 2004
Assembly Rating – 2 Hr
Joint Width – 1 In. Max

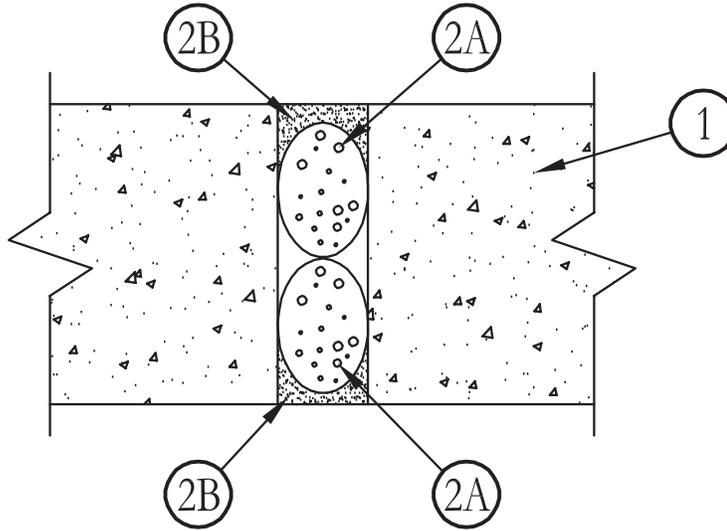

1. **Wall Assembly** – Min 4-1/2 in. thick reinforced lightweight or normal weight (100-150 pcf) structural concrete. Wall may also be constructed of any UL Classified **Concrete Blocks***.
See **Concrete Blocks (CAZT)** category in the Fire Resistance Directory for names of manufacturers.
2. **Joint System** – Max width of joint is 1 in. The joint system shall consist of the following:
 - A. **Packing Material** – Open cell polyurethane foam backer rod friction-fitted into joint opening on each side of wall assembly. Packing material to be recessed each surface of wall to accommodate the required thickness of fill material.
 - B. **Fill, Void or Cavity Material*** – Min 1/2 in. thickness of fill material applied within the joint, flush with both surfaces of wall.
3M COMPANY – MP+ Stix putty, CP 25WB+ caulk or FB-3000 WT sealant

*Bearing the UL Classification Marking

Reprinted from the Online Certifications Directory with permission from Underwriters Laboratories Inc.
Copyright © 2010 Underwriters Laboratories Inc.®



Construction Joints

Wall to Wall

WWS

System No. WW-S-0028

September 08, 2004
 Assembly Rating – 2 Hr
 Joint Width – 1 In. Max

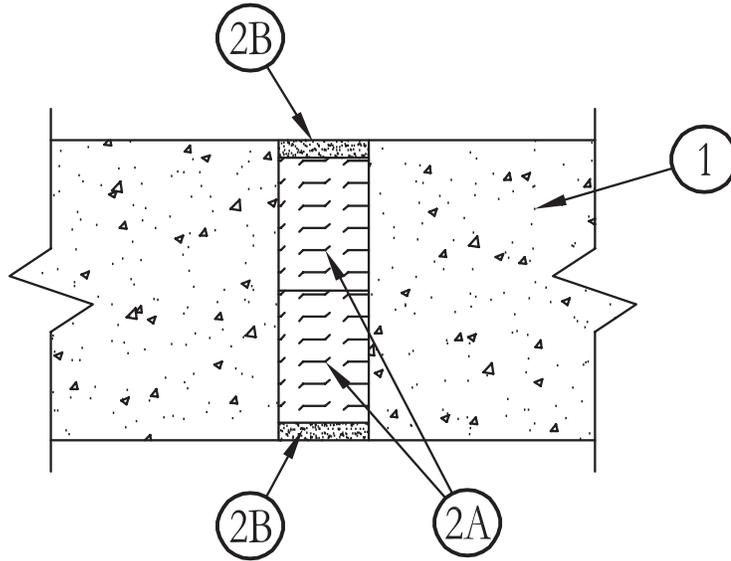

1. **Wall Assembly** – Min 4-1/2 in. thick reinforced lightweight or normal weight (100-150 pcf) structural concrete. Wall may also be constructed of any UL Classified **Concrete Blocks***.
 See **Concrete Blocks** (CAZT) category in the Fire Resistance Directory for names of manufacturers.
2. **Joint System** – Max width of joint is 1 in. The joint system shall consist of the following:
 - A. **Packing Material** – Min 2 in. thickness of min 4.0 pcf mineral wool batt insulation firmly packed into opening on each side of wall as a permanent form. Packing material to be recessed from each surface of wall to accommodate the required thickness of fill material.
 - B. **Fill, Void or Cavity Material*** – Min 1/4 in. thickness of fill material applied within the joint, flush with each surface of wall.
3M COMPANY – CP 25WB+ caulk or FB-3000 WT sealant

*Bearing the UL Classification Marking

Reprinted from the Online Certifications Directory with permission from Underwriters Laboratories Inc.
 Copyright © 2010 Underwriters Laboratories Inc.®



System No. WW-S-0032

January 16, 1998
Assembly Rating – 2 Hr
Joint Width – 1-1/2 in. Max

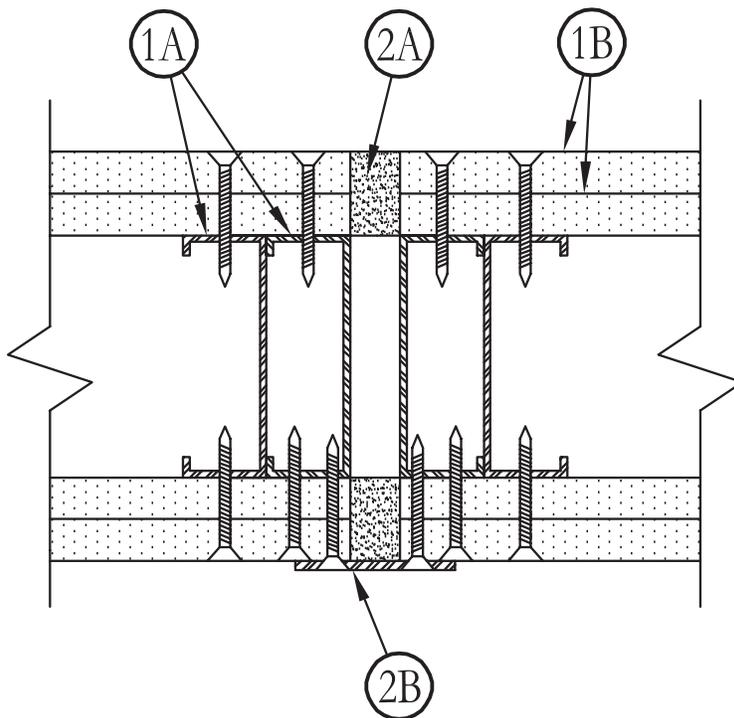

- Wall Assembly** – Nonbearing 2 hr fire rated gypsum wallboard/stud assembly constructed of the materials and in the manner described in the individual U400-Series Wall or Partition Design in the UL Fire Resistance Directory, including the following construction features:
 - Studs** – Min 3-5/8 in. wide by 1-1/4 in. deep corrosion protected min 25 MSG Steel channels. Steel stud spacing not to exceed 24 in. OC.
 - Gypsum Board*** – Two layers 5/8 in. thick gypsum wallboard, as specified in the individual U400-Series Design.
- Joint System** – Max width of joint is 1-1/2 in. The joint system shall consist of the following:
 - Fill, Void or Cavity Material*** – Min 1-1/4 in. thickness of fill material applied within the joint, flush with each surface of wall.
3M COMPANY – FB-2000 or FB-2000+
 - Steel Cover Plate** – Min 28 gauge galv steel cover plate sized to overlap wall a min of 2 in. on both sides of opening. Plate attached to either one side or both sides of wall and shall be continuous for the entire height of opening.

*Bearing the UL Classification Marking

Reprinted from the Online Certifications Directory with permission from Underwriters Laboratories Inc.
Copyright © 2010 Underwriters Laboratories Inc.®

Construction Joints

Wall to Wall

WWS

System No. WW-S-0034

August 03, 2001

Assembly Rating – 2 Hr

L Rating At Ambient – 4 CFM/Lin Ft

L Rating At 400 F – 6 CFM/Lin Ft

Joint Width – 1/2 in. Max

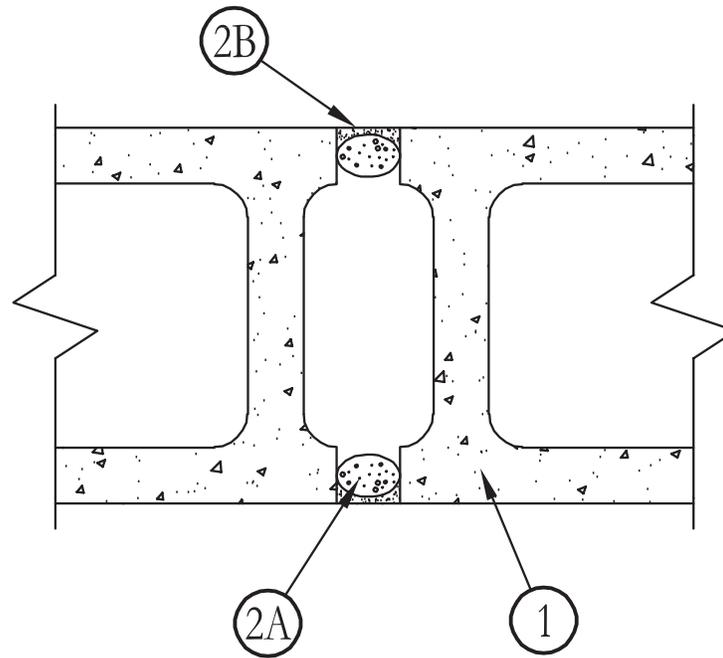

1. **Wall Assembly** – Min 7-1/2 in. thick UL Classified **Concrete Blocks*** or min 7-1/2 in. thick reinforced lightweight or normal weight (100-150 pcf) structural concrete.
See **Concrete Blocks (CAZT)** category in the Fire Resistance Directory for names of manufacturers.
2. **Joint System** – Max width of joint is 1/2 in. The joint system shall consist of the following:
 - A. **Forming Material** – Nom 3/4 in. diameter polyethylene backer rod compressed and installed into joint. Packing material to be recessed from each surface of wall as required to accommodate the required thickness of fill material.
 - B. **Fill, Void or Cavity Material*** – Min 1/4 in. thickness of fill material applied within the joint, flush with both surfaces of wall.
3M COMPANY – FireDam 150+

*Bearing the UL Classification Mark

Reprinted from the Online Certifications Directory with permission from Underwriters Laboratories Inc.
Copyright © 2010 Underwriters Laboratories Inc.®



System No. WW-S-0035

August 03, 2001

Assembly Rating – 2 Hr

L Rating At Ambient – 4 CFM/Lin Ft

L Rating At 400 F – 6 CFM/Lin Ft

Joint Width – 1 In. Max

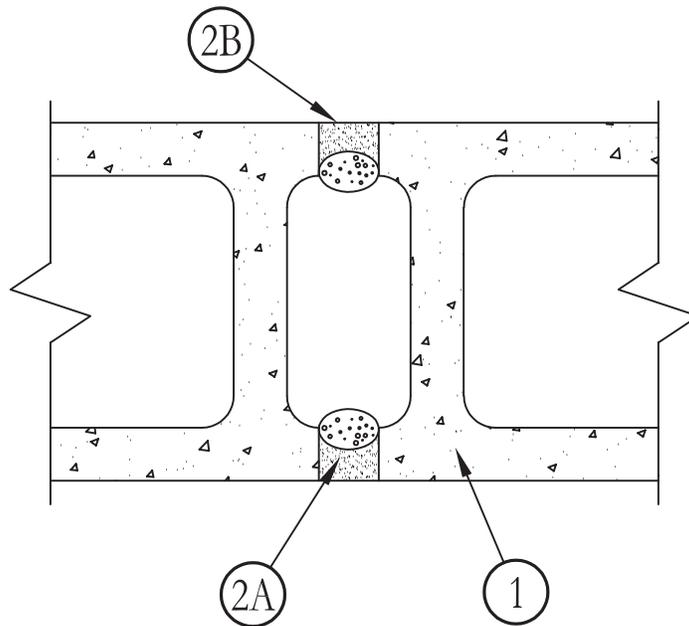

1. **Wall Assembly** – Min 7-1/2 in. thick UL Classified **Concrete Blocks*** or min 7-1/2 in. thick reinforced lightweight or normal weight (100-150 pcf) structural concrete.
See **Concrete Blocks (CAZT)** category in the Fire Resistance Directory for names of manufacturers.
2. **Joint System** – Max width of joint is 1 in. The joint system shall consist of the following:
 - A. **Forming Material** – Nom 1-1/4 in. diameter polyethylene backer rod compressed and installed into joint. Packing material to be recessed from each surface of wall as required to accommodate the required thickness of fill material.
 - B. **Fill, Void or Cavity Material*** – Min 1/2 in. thickness of fill material applied within the joint, flush with both surfaces of wall.
3M COMPANY – FireDam 150+

*Bearing the UL Classification Mark

Reprinted from the Online Certifications Directory with permission from Underwriters Laboratories Inc.
Copyright © 2010 Underwriters Laboratories Inc.®



Construction Joints

Wall to Wall

WWS

System No. WW-S-1001

May 09, 2013

ANSI/UL2079

Assembly Rating – 3 Hr

Nominal Joint Width – 4 & 6 In. Max (See Item 2)

L Rating At Ambient – Less Than 1 CFM/LIN ft

L Rating At 400 F – Less Than 1 CFM/LIN ft

CAN/ULC S115

F Rating – 3 Hr

FT Rating – 3 Hr

FH Rating – 3 Hr

FTH Rating – 3 Hr

Nominal Joint Width – 4 & 6 In. Max (See Item 2)

L Rating At Ambient – Less Than 1 CFM/LIN ft

L Rating At 400 F – Less Than 1 CFM/LIN ft

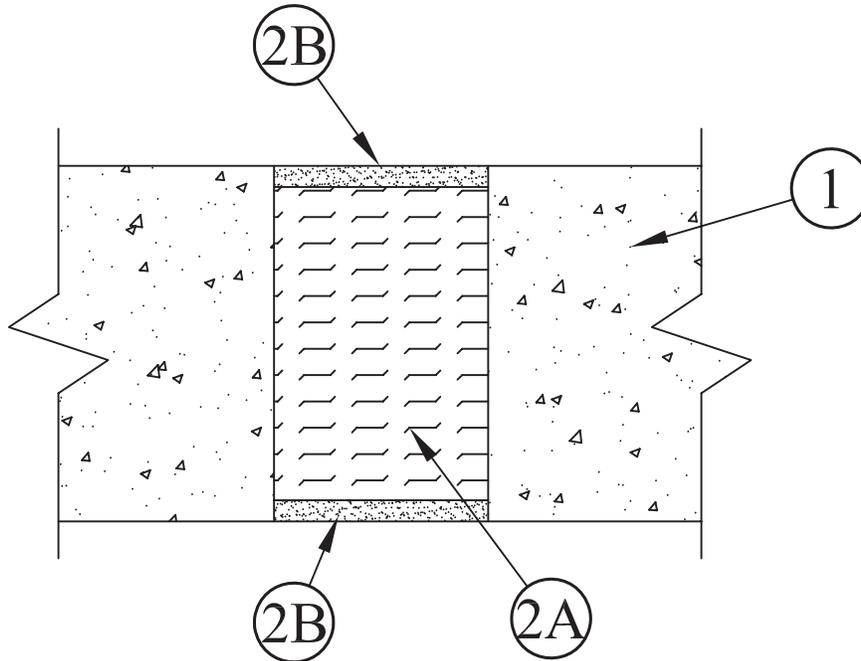

- Wall Assembly** – Min 4-1/2 in. or 5 in. (114 or 127 mm) thick reinforced lightweight or normal weight (100-150 pcf or 1600-2400 kg/m³) structural concrete for max 4 in. and 6 in. (102 and 152 mm) wide joints, respectively. Wall may also be constructed of any UL Classified **Concrete Blocks***.
See **Concrete Blocks (CAZT)** category in the Fire Resistance Directory for names of manufacturers.
- Joint System** – Max width of joint is 4 in. or 6 in. (102 or 152 mm), dependent on the thickness of the packing material (Item 2A). The joint system shall consist of the following:
 - Packing Material** – Min 3 in. (76 mm) thickness of min 4.0 pcf (64 kg/m³) mineral wool batt insulation for max 4 in. wide joint. Min 4 in. (102 mm) thickness of min 4.0 pcf (64 kg/m³) mineral wool batt insulation for max 6 in. (152 mm) wide joint. Packing material firmly packed into opening as a permanent form and recessed from each surface of wall to accommodate the required thickness of fill material.
 - Fill, Void or Cavity Material*** – Min 1/2 in. (13 mm) thickness of fill material applied within the joint, flush with each surface of wall.
3M COMPANY – FB-1000 NS, FB-2000 or FB-2000+.

*Bearing the UL Classification Mark

Reprinted from the Online Certifications Directory with permission from UL

© 2013 UL LLC



Construction Joints

Wall to Wall

WWS

System No. WW-S-1003

May 09, 2013

ANSI/UL2079

Assembly Rating – 3 Hr

Nominal Joint Width – 6 In.

L Rating At Ambient – Less Than 1 CFM/LIN ft

L Rating At 400 F – Less Than 1 CFM/LIN ft

CAN/ULC S115

F Rating – 3Hr

FT Rating – 3Hr

FH Rating – 3Hr

FTH Rating – 3Hr

Nominal Joint Width – 6 In.

L Rating At Ambient – Less Than 1 CFM/LIN ft

L Rating At 400 F – Less Than 1 CFM/LIN ft

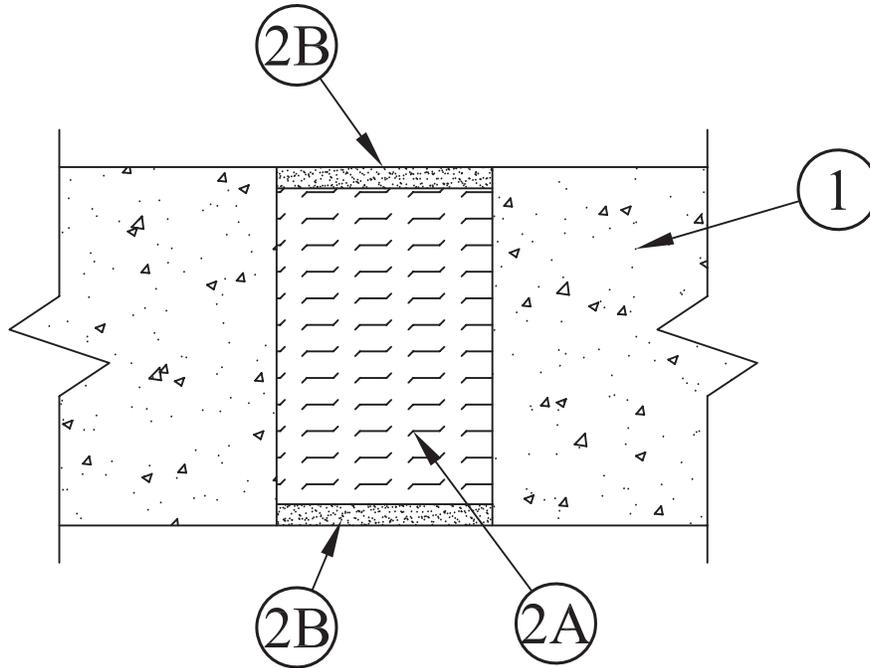

1. **Wall Assembly** – Min 5-1/2 in. (140 mm) thick reinforced lightweight or normal weight (100-150 pcf or 1600-2400 kg/m³) structural concrete. Wall may also be constructed of any UL Classified **Concrete Blocks***. See **Concrete Blocks** (CAZT) category in the Fire Resistance Directory for names of manufacturers.
2. **Joint System** – Max width of joint is 6 in. (152 mm). The joint system shall consist of the following:
 - A. **Packing Material** – Min 4 in. (102 mm) thickness of min 4.0 pcf (64 kg/m³) mineral wool batt insulation firmly packed into opening as a permanent form. Packing material to be recessed from each surface of wall to accommodate the required thickness of fill material.
 - B. **Fill, Void or Cavity Material*** – Min 3/4 in. (19 mm) thickness of fill material applied within the joint, flush with each surface of wall, **3M COMPANY** – FB-1000 NS, FB-2000 or FB-2000+.

*Bearing the UL Classification Mark

Reprinted from the Online Certifications Directory with permission from UL

© 2013 UL LLC



System No. WW-S-1030

August 03, 2001

Assembly Rating – 2 Hr

L Rating At Ambient – Less Than 1 CFM/Lin Ft

L Rating At 400 F – Less Than 1 CFM/Lin Ft

Joint Width – 4 In. Max

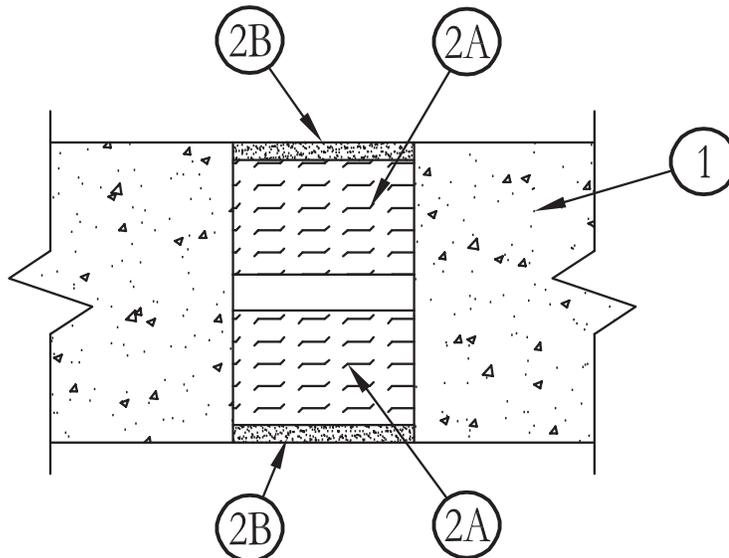

1. **Wall Assembly** – Min 4-1/2 in. thick lightweight or normal weight (100-150 pcf) concrete wall or min 7-5/8 in. thick masonry wall. Wall may also be constructed of any UL Classified **Concrete Blocks***. See **Concrete Blocks** (CAZT) category in the Fire Resistance Directory for names of manufacturers.
2. **Joint System** – Max width of joint is 4 in. The joint system shall consist of the following:
 - A. **Packing Material** – Min 1-3/4 in. thickness of min 4.0 pcf mineral wool batt insulation packed into opening as a permanent form on both sides of wall such that the width of the wool is compressed at least 25 percent. Packing material to be recessed from both surfaces of wall to accommodate the required thickness of fill material.
 - B. **Fill, Void or Cavity Material*** – Min 3/8 in. thickness of fill material applied within the joint, flush with each surface of wall.
3M COMPANY – FB-1000 NS

*Bearing the UL Classification Mark

Reprinted from the Online Certifications Directory with permission from Underwriters Laboratories Inc.
Copyright © 2010 Underwriters Laboratories Inc.®

3M Firestop Systems

Construction Joints

Continuity Head of Wall

CJD

Head of Wall Dynamic

Continuity Head-of-Wall

| 3M UL Systems | "F" Rating | 3M Product | Through Penetrant Details |
|---------------|------------|-----------------------------------|--|
| CJ-D-0005 | 1 | 3M™ Fire Barrier Sealant CP 25WB+ | 2 in. head of wall joint between gypsum wallboard assembly and non-rated horizontal assembly. Purlins present. 100% compression or extension |
| CJ-D-0006 | 1 | 3M™ Fire Barrier Sealant CP 25WB+ | 2 in. head of wall joint between gypsum wallboard assembly and non-rated horizontal assembly. Purlins present. 100% compression or extension |
| CJ-D-0007 | 1 | 3M™ Fire Barrier Sealant CP 25WB+ | 2 in. head of wall joint between gypsum wallboard assembly and non-rated horizontal assembly. Purlins present. 100% compression or extension |

System No. CJ-D-0005

April 19, 2012

Joint Rating – 1 Hr

Nominal Joint Width – 2 in.

Class II or III Movement Capabilities – 100% Compression and Extension

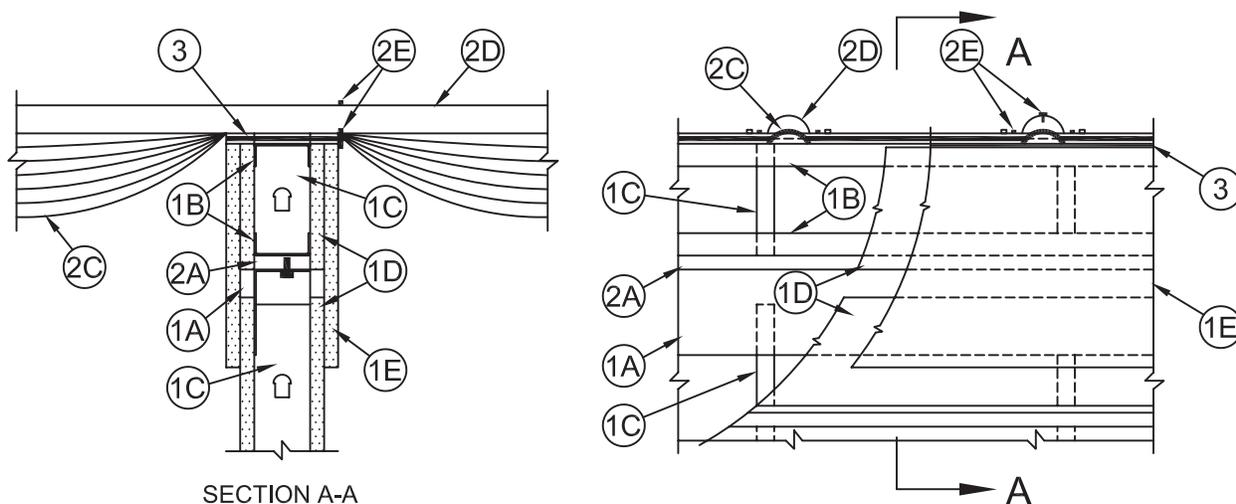

1. **Wall Assembly** – The minimum 1 hr fire rated gypsum board/steel stud wall assembly shall be constructed of the materials and in the manner specified in the individual U400, V400 or W400 Series Wall and Partition Design in the UL Fire Resistance Directory and shall include the following construction features:

- A. **Ceiling Deflection Channel** – U-shaped channel formed from min 16 ga steel sized to accommodate steel studs (Item 1C) and provided with nom 5 in. (127 mm) flanges. Deflection channel installed parallel with and aligned with web of purlin and secured to bottom flange of purlin with min No. 14 self-tapping, hex-head, plated steel or stainless steel screws spaced max 24 in. (610 mm) OC.
- B. **Steel Floor and Ceiling Runners** – Floor runner of the wall assembly and the floor and ceiling runners of the cripple wall above the wall assembly shall consist of min 1-1/4 in. (32 mm) deep min 25 ga galv steel channels sized to accommodate steel studs (Item 1C). Floor runner of cripple wall aligned with and resting atop flange of purlin. Ceiling runner of cripple wall installed to compress insulation (Item 2C) to min thickness of 3/8 in. (10 mm) by wedging lengths of stud (Item 1C) between the runners. Steel studs of cripple wall attached to web of purlin with steel screws driven through opposite side of purlin web.
- C. **Studs** – Steel studs to be min 3-1/2 in. (89 mm) wide. Studs cut max 2 in. (51 mm) less in length than the wall assembly height with bottom nesting in and resting on the floor runner and with top nesting in ceiling deflection channel without attachment. Width of stud to be equal to or greater than width of purlin flange. Stud spacing not to exceed 24 in. (610 mm) O.C. Studs of cripple wall cut to length as required to compress insulation (Item 2C) to min thickness of 3/8 in. (10 mm) and spaced max 24 in. (610 mm) OC.
- D. **Gypsum Board*** – (CKNX) – Min 5/8 in. (16 mm) thick gypsum board sheets installed on each side of wall. Wall to be constructed as specified in the individual U400, V400 or W400 Series Design in the UL Fire Resistance Directory except that a max 2 in. (51 mm) wide gap shall be maintained between the gypsum board of the wall assembly below the purlin and the gypsum board of the cripple wall. Top edge of gypsum board of wall assembly to be max 2 in. (51 mm) below top of ceiling deflection channel. Bottom edge of gypsum board of cripple wall to be flush with top of ceiling deflection channel. Screws securing gypsum board to steel studs of wall assembly to be located 2-1/4 in. to 2 1/2 in. (57 to 64 mm) below flange of ceiling deflection channel. Screws securing gypsum board of cripple wall to be driven into web of purlin and into studs and runners of cripple wall. No screws are to be driven into flanges of ceiling deflection channel.
- E. **Gypsum Board*** – (CKNX) – Min 5/8 in. (16 mm) thick “rip strip” of gypsum board installed to cover first layer of gypsum board on cripple wall and to lap min 3 in. (76 mm) onto gypsum board of wall assembly on each side of wall. The “rip strip” of gypsum board is to be the same material used for the wall assembly and is to be secured to the web of purlin and into studs and runners of the cripple wall. No screws are to be driven into flanges of ceiling deflection channel. Joints of “rip strip” to be offset from joints of gypsum board on wall assembly.

Max separation between top of wall assembly gypsum board and bottom of cripple wall gypsum board (at time of installation of joint system) is 2 in. (51 mm). The joint system is designed to accommodate a max 100 percent compression or extension from its installed width.

2. **Nonrated Horizontal Assembly** – The nonrated horizontal assembly shall be constructed of the materials and in the manner described in the individual Roof Deck Constructions (Guide TGKX) in the UL Roofing Materials and Systems Directory and shall include the following construction features:
 - A. **Purlin** – Min 16 ga coated steel. Max spacing as specified in the individual Roof Deck Construction.
 - B. **Lateral Bracing** – (Not Shown) – As required.
 - C. **Batts and Blankets*** – **Insulation** – Any faced compressible glass-fiber blanket insulation having a min 6 in. (152 mm) thickness before compression and a min density of 0.6 pcf (9.6 kg/m³). Insulation draped over purlins prior to installation of panel clips (Item 2F) and/or metal roof deck panels (Item 2D). Side edges of the batts shall be butted or overlapped a max of 3 in. (76 mm).
See **Batts and Blankets** (BZJZ) category in the UL Fire Resistance Directory or **Batts and Blankets** (BKNV) category in the UL Building Materials Directory for names of manufacturers.
 - D. **Metal Roof Deck Panels*** – Min 26 ga coated steel. Panels continuous over two or more spans. Roof panel end laps, if required, centered over purlins with min 3 in. (76 mm) panel overlap as specified in the individual Roof Deck Construction. A line of tube sealant or tape sealant may be used at panel end and side laps.

Design No. CJ-D-0005 *continued*

See **Metal Roof Deck Panels** (TJPV) category in the UL Roofing Materials and Systems Directory for names of manufacturers.

- E. **Fasteners** – Fasteners used for panel-to-purlin and panel-to-panel connections to be self-tapping, hex-head, plated steel or stainless steel screws with either an integral or a separate steel washer fitted with a compressible sealing washer. Fastener type, length, pilot hole diam and spacing to be as specified in the individual Roof Deck Construction.
- F. **Roof Deck Fasteners* – Panel Clips** – (Not Shown) – Panel clips used for panel-to-purlin connections to be secured to purlin through insulation as specified in the individual Roof Deck Construction.

See **Roof Deck Fasteners** (TLSX) category in the UL Roofing Materials and Systems Directory for names of manufacturers.

- G. **Thermal Spacer Blocks** – (Not Shown) – Expanded polystyrene strips cut to fit between panel clips (Item 2F) as specified in the individual Roof Deck Construction. Thermal spacer blocks, when used, are to be installed between insulation (Item 2C) and metal roof deck panels (Item 2D) over purlins.
3. **Fill, Void or Cavity Material* (XHHW) – Caulk** – Min 5/8 in. (16 mm) thickness of fill material installed to fill any gap between top of cripple wall gypsum board and insulation (Item 2C) or purlin flange on each side of the wall.

3M COMPANY

3M FIRE PROTECTION PRODUCTS – CP 25WB+ Caulk

Reprinted from the Online Certifications Directory with permission from UL

© 2013 UL LLC

System No. CJ-D-0006

April 19, 2012

Joint Rating – 1 Hr

Nominal Joint Width – 2 in.

Class II or III Movement Capabilities – 100% Compression and Extension

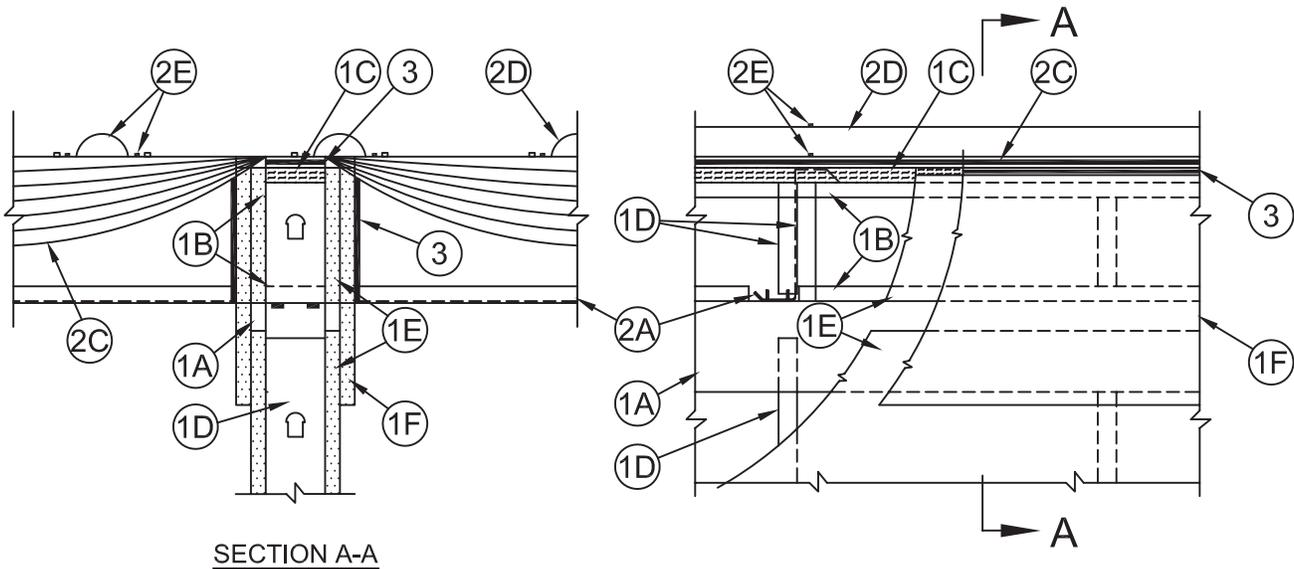

SECTION A-A

1. **Wall Assembly** – The minimum 1 h fire rated gypsum board/steel stud wall assembly shall be constructed of the materials and in the manner specified in the individual U400, V400 or W400 Series Wall and Partition Design in the UL Fire Resistance Directory and shall include the following construction features:
 - A. **Ceiling Deflection Channel** – U-shaped channel formed from min 16 ga steel sized to accommodate steel studs (Item 1D) and provided with nom 5 in. (127 mm) flanges. Deflection channel installed perpendicular to purlins and secured to bottom flange of purlins with min No. 14 self-tapping, hex-head, plated steel or stainless steel screws.
 - B. **Steel Floor and Ceiling Runners** – Floor runner of the wall assembly and the floor and ceiling runners of the cripple wall above the wall assembly shall consist of min 1-1/4 in. (32 mm) deep min 25 ga galv steel channels sized to accommodate steel studs (Item 1D). Floor runner of cripple wall aligned with and screw-attached to top of ceiling deflection channel. Ceiling runner of cripple wall installed to compress insulation (Item 2C) to min thickness of 3/8 in. (10 mm) by wedging lengths of stud (Item 1D) between the runners. Steel studs of cripple wall attached to each side of purlin web and to floor and ceiling runners with steel screws.
 - C. **Batts and Blankets* – Packing Material** – Unfaced compressible mineral wool batt insulation having a nom 2 in. (51 mm) thickness before compression and a nom density of 4 pcf (64 kg/m³). Strips of nom 2 in. (51 mm) thick batt cut to width of cripple wall ceiling runner and compressed min 50 percent in thickness between cripple wall ceiling runner and insulation (Item 2C). Compression of mineral wool batt packing material to result in compression of insulation (Item 2C) to nominal 3/8 in. (10 mm) thickness.
See **Batts and Blankets (BZJZ)** category in the UL Fire Resistance Directory or **Batts and Blankets (BKNV)** category in the UL Building Materials Directory for names of manufacturers.
 - D. **Studs** – Steel studs to be min 3-1/2 in. (89 mm) wide. Studs cut max 2 in. (51 mm) less in length than the wall assembly height beneath purlins with bottom nesting in and resting on the floor runner and with top nesting in ceiling deflection channel without attachment. Stud spacing not to exceed 24 in. (610 mm) O.C. Studs of cripple wall cut to length as required to compress packing material (Item 1C) and insulation (Item 2C) to min thicknesses of 1 in. (25 mm) and 3/8 in. (10 mm), respectively. Studs spaced max 24 in. (610 mm) OC.
 - E. **Gypsum Board* – (CKNX)** – Min 5/8 in. (16 mm) thick gypsum board sheets installed on each side of wall. Wall to be constructed as specified in the individual U400, V400 or W400 Series Design in the UL Fire Resistance Directory except that a max 2 in. (51 mm) wide gap shall be maintained between the gypsum board of the wall assembly below the purlin and the gypsum board of the cripple wall. Top edge of gypsum board of wall assembly to be max 2 in. (51 mm) below top of ceiling deflection channel. Bottom edge of gypsum board of cripple wall to be flush with top of ceiling deflection channel. Screws securing gypsum board to steel studs of wall assembly to be located 2-1/4 in. to 2-1/2 in. (57 to 64 mm) below flange of ceiling deflection channel. Screws securing gypsum board of cripple wall to be driven into studs and runners of cripple wall. No screws are to be driven into flanges of ceiling deflection channel.
 - F. **Gypsum Board* – (CKNX)** – Min 5/8 in. (16 mm) thick “rip strip” of gypsum board installed to cover first layer of gypsum board on cripple wall and to lap min 3 in. (76 mm) onto gypsum board of wall assembly on each side of wall. The “rip strip” of gypsum board is to be the same material used for the wall assembly and is to be secured to the studs and runners of the cripple wall. No screws are to be driven into flanges of ceiling deflection channel. Joints of “rip strip” to be offset from joints of gypsum board on wall assembly.

Max separation between top of wall assembly gypsum board and bottom of cripple wall gypsum board (at time of installation of joint system) is 2 in. (51 mm). The joint system is designed to accommodate a max 100 percent compression or extension from its installed width.
2. **Nonrated Horizontal Assembly** – The nonrated horizontal assembly shall be constructed of the materials and in the manner described in the individual Roof Deck Constructions (Guide TGKX) in the UL Roofing Materials and Systems Directory and shall include the following construction features:
 - A. **Purlin** – Min 16 ga coated steel. Max spacing as specified in the individual Roof Deck Construction.
 - B. **Lateral Bracing** – (Not Shown) – As required.
 - C. **Batts and Blankets* – Insulation** – Any faced compressible glass-fiber blanket insulation having a min 6 in. (152 mm) thickness before compression and a min density of 0.6 pcf (9.6 kg/m³). Insulation draped over purlins prior to installation of panel clips (Item 2F) and/or

Design No. CJ-D-0006 *continued*

metal roof deck panels (Item 2D). Side edges of the batts shall be butted or overlapped a max of 3 in. (76 mm).

See **Batts and Blankets** (BZJZ) category in the UL Fire Resistance Directory or **Batts and Blankets** (BKNV) category in the UL Building Materials Directory for names of manufacturers.

- D. **Metal Roof Deck Panels*** – Min 26 ga coated steel. Panels continuous over two or more spans. Roof panel end laps, if required, centered over purlins with min 3 in. (76 mm) panel overlap as specified in the individual Roof Deck Construction. A line of tube sealant or tape sealant may be used at panel end and side laps.

See **Metal Roof Deck Panels** (TJPV) category in the UL Roofing Materials and Systems Directory for names of manufacturers.

- E. **Fasteners** – Fasteners used for panel-to-purlin and panel-to-panel connections to be self-tapping, hex-head, plated steel or stainless steel screws with either an integral or a separate steel washer fitted with a compressible sealing washer. Fastener type, length, pilot hole diam and spacing to be as specified in the individual Roof Deck Construction.

- F. **Roof Deck Fasteners* – Panel Clips** – (Not Shown) – Panel clips used for panel-to-purlin connections to be secured to purlin through insulation as specified in the individual Roof Deck Construction.

See **Roof Deck Fasteners** (TLSX) category in the UL Roofing Materials and Systems Directory for names of manufacturers.

- G. **Thermal Spacer Blocks** – (Not Shown) – Expanded polystyrene strips cut to fit between panel clips (Item 1F) as specified in the individual Roof Deck Construction. Thermal spacer blocks, when used, are to be installed between insulation (Item 2C) and metal roof deck panels (Item 2D) over purlins.

3. **Fill, Void or Cavity Material* (XHHW) – Caulk** – Min 5/8 in. (16 mm) thickness of fill material installed to fill any gap between top of cripple wall gypsum board and insulation (Item 2C) on each side of the wall. Additional sealant installed to fill annular space between purlin and gypsum board “rip strip” (Item 1F) on both sides of wall. Additional nom 1/2 in. (13 mm) diam bead of sealant to be applied around perimeter of purlin at its interface with the “rip strip” on each side of the wall.

3M COMPANY

3M FIRE PROTECTION PRODUCTS – CP 25WB+ Caulk

*Bearing the UL Classification Mark

Reprinted from the Online Certifications Directory with permission from UL

© 2013 UL LLC

System No. CJ-D-0007

April 19, 2012

Joint Rating – 1 Hr

Nominal Joint Width – 2 in.

Class II or III Movement Capabilities – 100% Compression and Extension

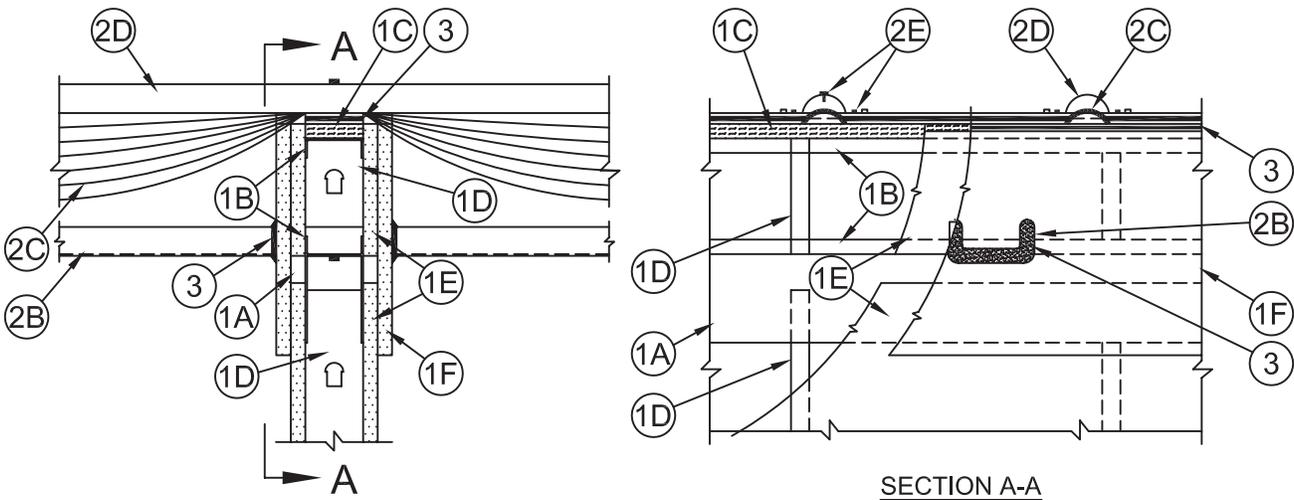

1. **Wall Assembly** – The minimum 1 h fire rated gypsum board/steel stud wall assembly shall be constructed of the materials and in the manner specified in the individual U400, V400 or W400 Series Wall and Partition Design in the UL Fire Resistance Directory and shall include the following construction features:

- A. **Ceiling Deflection Channel** – U-shaped channel formed from min 16 ga steel sized to accommodate steel studs (Item 2D) and provided with nom 5 in. (127 mm) flanges. Deflection channel installed parallel with and between purlins and secured to lateral bracing (Item 1B) with min No. 14 self-tapping, hex-head, plated steel or stainless steel screws.
- B. **Steel Floor and Ceiling Runners** – Floor runner of the wall assembly and the floor and ceiling runners of the cripple wall above the wall assembly shall consist of min 1-1/4 in. (32 mm) deep min 25 ga galv steel channels sized to accommodate steel studs (Item 2D). Floor runner of cripple wall aligned with and screw-attached to top of ceiling deflection channel. Ceiling runner of cripple wall installed to compress insulation (Item 1C) and packing material (Item 2C) to min thickness of 3/8 in. (10 mm) and 1 in. (25 mm), respectively, by wedging lengths of stud (Item 2D) between the runners. Steel studs of cripple wall attached to floor and ceiling runners with steel screws.
- C. **Batts and Blankets* – Packing Material** – Unfaced compressible mineral wool batt insulation having a nom 2 in. (51 mm) thickness before compression and a nom density of 4 pcf (64 kg/m³). Strips of nom 2 in. (51 mm) thick batt cut to width of cripple wall ceiling runner and compressed min 50 percent in thickness between cripple wall ceiling runner and insulation (Item 1C). Compression of mineral wool batt packing material to result in compression of insulation (Item 1C) to nominal 3/8 in. (10 mm) thickness. When width of metal roof deck panels (Item 1D) rib exceeds 2 in. (51 mm).

See **Batts and Blankets (BZJZ)** category in the UL Fire Resistance Directory or **Batts and Blankets (BKNV)** category in the UL Building Materials Directory for names of manufacturers.

- D. **Studs** – Steel studs to be min 3-1/2 in. (89 mm) wide. Studs cut max 2 in. (51 mm) less in length than the wall assembly height beneath purlins with bottom nesting in and resting on the floor runner and with top nesting in ceiling deflection channel without attachment. Stud spacing not to exceed 24 in. (610 mm) O.C. Studs of cripple wall cut to length as required to compress packing material (Item 2C) and insulation (Item 1C) to min thicknesses of 1 in. (25 mm) and 3/8 in. (10 mm), respectively. Studs spaced max 24 in. (610 mm) OC.
- E. **Gypsum Board* – (CKNX)** – Min 5/8 in. (16 mm) thick gypsum board sheets installed on each side of wall. Wall to be constructed as specified in the individual U400 or V400 Series Design in the UL Fire Resistance Directory except that a max 2 in. wide gap shall be maintained between the gypsum board of the wall assembly and the gypsum board of the cripple wall. Top edge of gypsum board of wall assembly to be max 2 in. (51 mm) below top of ceiling deflection channel. Bottom edge of cripple wall gypsum board to be flush with top of ceiling deflection channel. Screws securing gypsum board to steel studs of wall assembly to be located 2-1/4 in. to 2-1/2 in. (57 to 64 mm) below flange of ceiling deflection channel. Screws securing gypsum board of cripple wall to be driven into studs and runners of cripple wall. No screws are to be driven into flanges of ceiling deflection channel.
- F. **Gypsum Board* – (CKNX)** – Min 5/8 in. (16 mm) thick “rip strip” of gypsum board installed to cover first layer of gypsum board on cripple wall and to lap min 3 in. (76 mm) onto gypsum board of wall assembly on each side of wall. The “rip strip” of gypsum board is to be the same material used for the wall assembly and is to be secured to the studs and runners of the cripple wall. No screws are to be driven into flanges of ceiling deflection channel. Joints of “rip strip” to be offset from joints of gypsum board on wall assembly.

Max separation between top of wall assembly gypsum board and bottom of cripple wall gypsum board (at time of installation of joint system) is 2 in. (51 mm). The joint system is designed to accommodate a max 100 percent compression or extension from its installed width.

2. **Nonrated Horizontal Assembly** – The nonrated horizontal assembly shall be constructed of the materials and in the manner described in the individual Roof Deck Constructions (Guide TGKX) in the UL Roofing Materials and Systems Directory and shall include the following construction features:

- A. **Purlin** – (Not Shown) – Min 16 ga coated steel. Max spacing as specified in the individual Roof-Ceiling Design.
- B. **Lateral Bracing** – Min 16 ga coated steel strap, channel, angle or other structural shape installed where required for lateral support of studs. Attached to steel purlins on each side of wall assembly with welds or with min No. 14 self-tapping, hex-head, plated steel or stainless steel screws.

Design No. CJ-D-0007 *continued*

Construction Joints

Expansion Joint

- C. **Batts and Blankets*** – **Insulation** – Any faced compressible glass-fiber blanket insulation having a min 6 in. (152 mm) thickness before compression and a min density of 0.6 pcf (9.6 kg/m³). Insulation draped over purlins prior to installation of panel clips (Item 1F) and/or metal roof deck panels (Item 1D). Side edges of the batts shall be butted or overlapped a max of 3 in. (76 mm).
See **Batts and Blankets** (BZJZ) category in the UL Fire Resistance Directory or Batts and Blankets (BKNV) category in the UL Building Materials Directory for names of manufacturers.
- D. **Metal Roof Deck Panels*** – Min 26 ga coated steel. Panels continuous over two or more spans. Roof panel end laps, if required, centered over purlins with min 3 in. (76 mm) panel overlap as specified in the individual Roof-Ceiling Design. A line of tube sealant or tape sealant may be used at panel end and side laps.
See **Metal Roof Deck Panels** (TJPV) category in the UL Roofing Materials and Systems Directory for names of manufacturers.
- E. **Fasteners** – Fasteners used for panel-to-purlin and panel-to-panel connections to be self-tapping, hex-head, plated steel or stainless steel screws with either an integral or a separate steel washer fitted with a compressible sealing washer. Fastener type, length, pilot hole diam and spacing to be as specified in the individual Roof-Ceiling Design.
- F. **Roof Deck Fasteners* – Panel Clips** – (Not Shown) - Panel clips used for panel-to-purlin connections to be secured to purlin through insulation as specified in the individual Roof-Ceiling Design.
See **Roof Deck Fasteners** (TLSX) category in the UL Roofing Materials and Systems Directory for names of manufacturers.
- G. **Thermal Spacer Blocks** – (Not Shown) - Expanded polystyrene strips cut to fit between panel clips (Item 1F) as specified in the individual Roof-Ceiling Design. Thermal spacer blocks, when used, are to be installed between insulation (Item 1C) and metal roof deck panels (Item 1D) over purlins.
3. **Fill, Void or Cavity Material* (XHHW) – Caulk** – Min 5/8 in. (16 mm) thickness of fill material installed to fill any gap between top of cripple wall gypsum board and insulation (Item 1C) on each side of the wall. Additional sealant installed to fill annular space between lateral bracing and gypsum board “rip strip” (Item 2F) on both sides of wall. Additional nom 1/2 in. (13 mm) diam bead of sealant to be applied around perimeter of lateral brace at its interface with the “rip strip” on each side of the wall.

3M COMPANY

3M FIRE PROTECTION PRODUCTS – CP 25WB+ Caulk

*Bearing the UL Classification Mark

Reprinted from the Online Certifications Directory with permission from UL

© 2013 UL LLC

CJD

3M Firestop Systems

Construction Joints

Perimeter Joint

CWD

Curtain Wall Dynamic

CWS

Curtain Wall Static

Perimeter Joint

| 3M UL Systems | "F" Rating | 3M Product | Through Penetrant Details |
|---------------|------------|---|---|
| CW-D-1017 | 2 | 3M™ FireDam™ Spray 200 3M™ Fire and Water Barrier Tape 3M™ Watertight Spray | Max. 4 in. perimeter joint with Thermafiber® curtainwall insulation |
| CW-D-2055 | 2 | 3M™ FireDam™ Spray 200 3M™ Fire and Water Barrier Tape 3M™ Watertight Spray | Max. 4 in. perimeter joint with Thermafiber® curtainwall insulation |
| CW-S-2004 | 2 | 3M™ FireDam™ Spray 200 3M™ FireDam™ Spray 200 3M™ Fire and Water Barrier Tape 3M™ Watertight Spray | Max. 8 in. perimeter joint with Roxul® or Rockwool® curtainwall insulation. |
| CW-S-2005 | 2 | 3M™ FireDam™ Spray 200 3M™ FireDam™ Spray 200 3M™ Fire and Water Barrier Tape 3M™ Watertight Spray | Max. 8 in. perimeter joint with Roxul® or Rockwool® curtainwall insulation. |
| CW-S-2007 | 2 | 3M™ FireDam™ Spray 200 3M™ FireDam™ Spray 200 3M™ Fire and Water Barrier Tape 3M™ Watertight Spray | Max. 8 in. perimeter joint with Roxul® or Rockwool® curtainwall insulation. |

UL System No. CW-D-1017

March 20, 2017

F Rating – 2 Hr

T Rating – 1/2 Hr

Linear Opening Width – 4 in. Max

L Rating At Ambient – Less Than 1 CFM/sq ft

L Rating At 400°F – Less Than 1 CFM/sq ft

Class II Movement Capabilities – 5% Vertical Shear

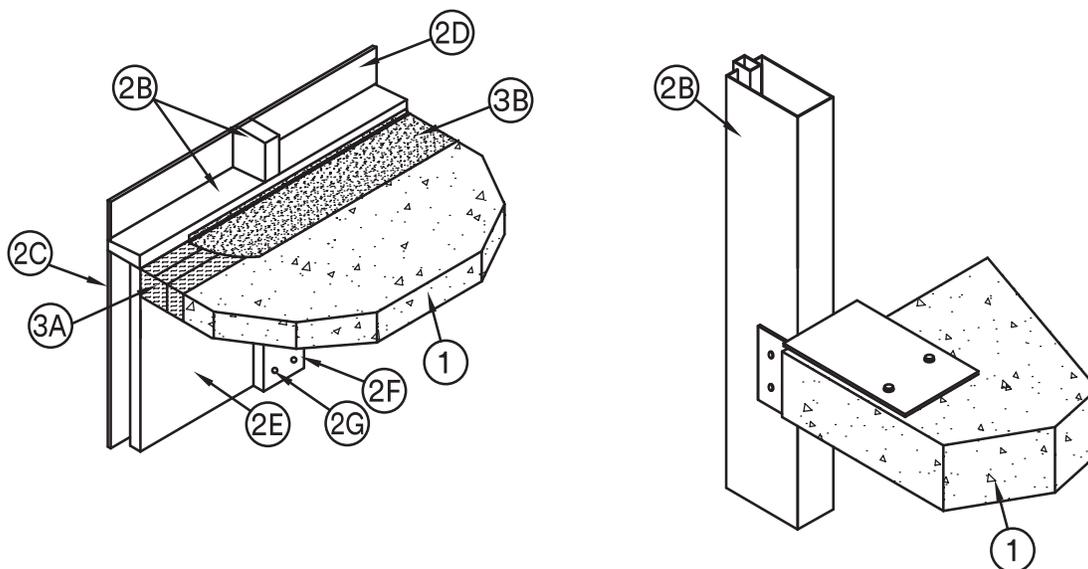

1. **Floor Assembly** – Min 4-1/2 in. (114 mm) thick reinforced lightweight or normal weight (100-150 pcf or 1600-2400 kg/m³) structural concrete.

2. **Curtain Wall Assembly** – The curtain wall assembly shall incorporate the following construction features:

A. Mullion Mounting Brackets – Min 3 in. (76 mm) by 3 in. (76 mm) by 1/4 in. steel angles attached through the mullion on each side with min 3/8 in. (10 mm) diam steel bolts with steel nuts and washers. The brackets are attached to a min 8 in. (203 mm) by 3-1/4 in. (83 mm) by 1/2 in. (13 mm) thick steel angles with a min 4 in. (51 mm) long with min 1/2 in. (13 mm) diam steel bolts with steel nuts and washers. The 8 in. (203 mm) by 3-1/4 in. (83 mm) angle is secured to the top of floor with two min 1/2 in. (13 mm) diam steel masonry anchors in conjunction with steel washers.

A1. Mullion Mounting Brackets – As an alternate to Item 2A, min 8 in. (203 mm) wide by 3/4 in. (19 mm) thick extruded aluminum Halfen mounting brackets with one nom 2 in. (51 mm) high leg for support and attachment of mullion and with one leg at least 6 in. (152 mm) longer than width of linear opening between floor assembly and mullion. Mounting bracket attached to top of floor with two min 1/2 in. (13 mm) diam steel masonry anchors in conjunction with washer plates supplied with mounting bracket.

B. Framing – The two-piece rectangular tubing mullions (vertical members) and transoms (horizontal members) shall be min 2-1/2 in. (64 mm) wide by 7-1/2 in. (191 mm) deep and shall be formed from min 0.100 in. (2.5 mm) thick aluminum. Mullions spaced max 60 in. (1.52 m) OC and secured to mullion mounting brackets (Item 2A) at each floor level. Interior face of mullions to be max 4 in. (102 mm) from edge of floor assembly. Transoms to be spaced min 24 in. (610 mm) OC. The minimum height from the top of the floor to the bottom of the vision panel sill is 0 in. The maximum height from the top of the floor to the bottom of horizontal transom is 3 in. (76 mm).

C. Spandrel Panels – The spandrel panels shall consist of one of the following types:

a. Glass Panels – Nom 1/4 in. (6 mm) thick opaque heat-strengthened glass. Each panel secured in position with aluminum pressure plates in conjunction with glazing gaskets and steel screws.

b. Aluminum Panels – Nom 1/8 in. (3 mm) thick aluminum panels with 1/4 in. (6 mm) thick edges. Each panel secured in position with aluminum pressure plates in conjunction with gaskets and steel screws.

c. Stone Panels – Nom 1-3/16 in. (46 mm) thick polished granite spandrel panels with 1 in. (25 mm) thick gauged edges. Each panel secured in position with aluminum pressure plates in conjunction with gaskets and steel screws.

D. Vision Panels – Nom 1/4 in. (6 mm) thick transparent heat-strengthened glass or nom 1 in. (25 mm) thick insulated glass units with two layers of nom 1/4 in. (6 mm) thick transparent heat-strengthened glass separated by a 1/2 in. (25 mm) air space. Each panel secured in position with aluminum pressure plates in conjunction with glazing gaskets and steel screws.

E. Curtain Wall Insulation* – Min. 2 in. (51 mm) thick mineral wool batt insulation faced on one side with aluminum foil/scrim vapor retarder. Impasse® Horizontal Hangers are installed in the insulation batt 6 in. (152 mm) from each mullion end and spaced max 16 in. (406 mm) OC across at the window sill transom. One Impasse® Vertical Hanger is installed along both vertical mullion sides of the insulation batt at 6 in. (152 mm) up from the bottom of the insulation batt. Insulation batt is then installed in spandrel area flush with the interior surface of the framing with no vertical or horizontal seams. Impasse® Horizontal Hangers are screw attached to top horizontal transom, Impasse® Vertical Hangers are screw attached to vertical mullions using min No. 10 by min. 1/2 in. (13 mm) self-drilling/self-taping screws. No attachment to the lower horizontal transom is required.

THERMAFIBER INC – FIRESpan® 90

F. Mullion Covers – Curtain Wall Insulation* – Nom 2 in. (51 mm) thick mineral wool batt insulation faced on one side with aluminum foil/ scrim vapor retarder, supplied in min 24 by 48 in. (610 by 1219 mm) boards. Min. 12 in. (305 mm) wide strips to be centered over mullions secured to curtain wall insulation (Item 2E) with a min. of four Spiral Anchors (Item 2G) spaced a max 12 in. (305mm) OC. Mullion covers to tightly abut the bottom of the forming material (Item 3A).

THERMAFIBER INC – FIRESpan® 90

G. Light Gauge Framing* – Spiral Anchor – Galv steel wire spiral anchors used to secure the curtain wall insulation (Item 2F and 2G). Nom length of spiral anchors to be 3-3/4 in. (95 mm), spaced max 12 in. (305 mm) OC.

THERMAFIBER INC – Spiral Anchor

3. Safing System – Max separation between edge of floor assembly and face of framing members (at time of installation) is 4 in. (102 mm). The safing system is designed to accommodate vertical shear movement up to a max of 5 percent of its installed width. The safing system shall incorporate the following construction features:

A. Forming Material* – Nom 4 pcf (64 kg/m³) density mineral wool batt insulation. Batt sections cut to a 4 in. (102 mm) width and stacked to a thickness which is min 25 percent greater than the width of the linear gap between the curtain wall insulation and the edge of the concrete floor slab. The forming material is compressed and inserted cut-edge-first into linear gap such that its top surface is flush with the top surface of the floor assembly. A max of one tightly-butted seam is permitted between mullions. Additional piece of forming material to be friction-fit into gap between batt sections above mullion mounting clip at each mullion location.

THERMAFIBER INC – SAF

B. Fill, Void or Cavity Material* – Min 1/8 in. (3 mm) wet thickness (min 1/16 in. (1.5 mm) dry thickness) of fill material spray-applied over top of forming material and lapping min 1/2 in. (13 mm) onto the top surface of the floor and onto the curtain wall insulation (Item 2E) and mullion covers (Item 2F). When 3M Fire Barrier Watertight Spray is used, min wet (and dry) thickness of spray is 1/10 in. (2.5 mm).

3M COMPANY

3M FIRE PROTECTION PRODUCTS – FireDam™ Spray 200, 3M Fire Barrier Watertight Spray

B1. Fill, Void or Cavity Material* – Tape – As an alternate to Item 3B, Tape cut to size and press applied to top surface of joint to completely cover mineral wool and overlap a min of 1 in. (25 mm) onto the top surface of the floor and onto the curtain wall insulation (Item 2E) and mullion covers (Item 2F). Tape shall be applied in min 1 ft (305 mm) lengths along the joint and adjoining lengths of Tape shall overlap min 1/2 in. (13 mm).

3M COMPANY

3M FIRE PROTECTION PRODUCTS – 3M Fire and Water Barrier Tape

*Indicates such products shall bear the UL or cUL Certification Mark for jurisdictions employing the UL or cUL Certification (such as Canada), respectively. 

Reprinted from the Online Certifications Directory with permission from UL©

UL System No. CW-D-2055

March 20, 2017

F Rating – 2 Hr

T Rating – 1/4 Hr

Integrity Rating – 2 Hr

Insulation Rating – 1/4 Hr

Linear Opening Width – 4 In. Max

Class II Movement Capabilities – 5% Vertical Shear (See Item 3)

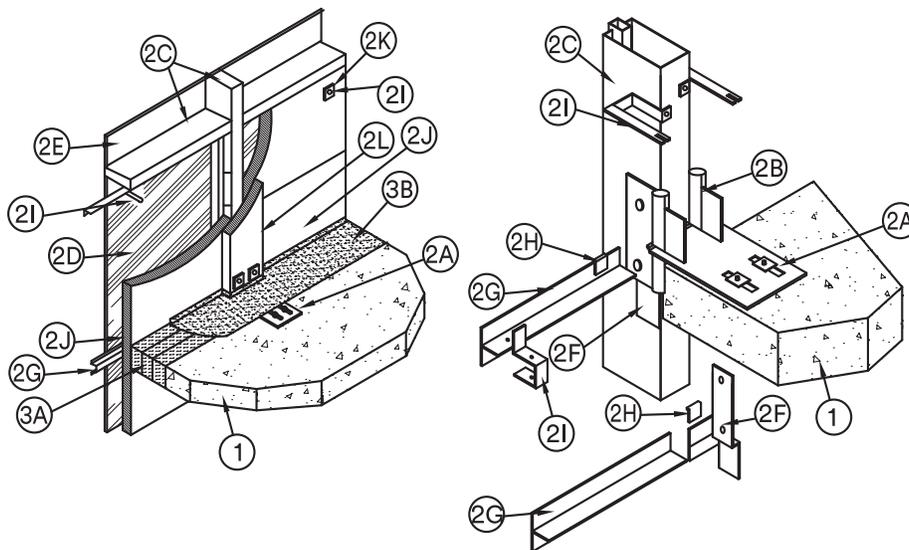

1. **Floor Assembly** – Min 4-1/2 in. (114 mm) thick reinforced lightweight or normal weight (100-150 pcf or 1600-2400 kg/m³) structural concrete.

2. **Curtain Wall Assembly** – The curtain wall assembly shall incorporate the following construction features:

- A. **Mullion Anchor Plates** – Nom 7 in. (178 mm) wide by 9-1/4 in. (235 mm) long by 5/8 in. (16 mm) thick extruded aluminum plates with a nominal 1-3/4 in. (44 mm) high raised lip along one end to engage hooked ends of mullion mounting clips (Item 2B). Plates anchored to top surface of floor at each mullion location with steel wedge anchor bolts in conjunction with extruded aluminum washers.
- B. **Mullion Mounting Clips** – Nominal 3 in. (76 mm) wide by 7 in. (178 mm) high extruded aluminum anchor slides with tapped holes and with separate extruded aluminum hooks designed to engage the raised lip of the anchor plate (Item 2A). Anchor slides bolted to each side of mullion at each floor with 1/2 in. (13 mm) diam stainless steel screws with locking washers. Anchor hooks secured to anchor slides with steel jacking screws and secured to raised lip of anchor plate with steel set screw.
- C. **Framing** – The one-piece or split rectangular tubing mullions (vertical members) and transoms (horizontal members) shall be min 2-1/2 in. (64 mm) wide by 6 in. (152 mm) deep and shall be formed from min 0.125 in. thick aluminum. Mullions spaced max 60 in. (1524 mm) OC and secured to mullion anchor plates (Item 2A) with mounting clips (Item 2B) at each floor level. Interior face of mullions to be max 4 in. (102 mm) from edge of floor assembly. Transoms to be spaced min 69 in. (1753 mm) OC. The minimum height from the top of the floor to the bottom of the vision panel sill is 33 in. (838 mm).
- D. **Spandrel Panels** – The spandrel panels shall consist of one of the following types:
 - a. **Glass Panels** – Nom 1/4 in. (6 mm) thick opaque heat-strengthened glass. Each panel secured in position with aluminum pressure plates in conjunction with glazing gaskets and steel screws.
 - b. **Aluminum Panels** – Nom 1/8 in. (3 mm) thick aluminum panels with 1/4 in. (6 mm) thick edges. Each panel secured in position with aluminum pressure plates in conjunction with gaskets and steel screws.
 - c. **Stone Panels** – Nom 1-3/16 in. (46 mm) thick polished granite spandrel panels with 1 in. (25 mm) thick gauged edges. Each panel secured in position with aluminum pressure plates in conjunction with gaskets and steel screws.
- E. **Vision Panels** – Nom 1 in. (25 mm) thick insulated glass units with two layers of nom 1/4 in. (6 mm) thick transparent heat-strengthened glass separated by a 1/2 in. (13 mm) air space. Each panel installed on silicone rubber setting blocks and secured in position with aluminum pressure plates in conjunction with glazing gaskets and steel screws.
- F. **Light Gauge Framing* – T-Bar Support Brackets** – Nom 2 in. (51 mm) wide brackets formed from galv steel and designed to bridge extruded aluminum anchor slides of mullion mounting clips (Item 2B). Each T Bar support bracket provided with nominal 3 in. (76 mm) wide by 3 in. (76 mm) high leg with a nominal 3/4 in. (19 mm) hemmed edge to receive the bottom edge of the T-Bar (Item 2G). T Bar support bracket secured to each side of mullion using the same bolts used to attach the anchor slides of the mullion mounting clips. The hemmed edge of the T Bar support bracket is to be located 3-1/2 in. (89 mm) below the top surface of the floor slab such that, when installed, the stem of the T Bar (Item 2G) will be located 2 in. (51 mm) below the top plane of the floor slab. Angle of T Bar support bracket to be recessed from interior face of framing as necessary to accommodate the thickness of the curtain wall insulation (Item 2J).

THERMAFIBER INC

- G. **Light Gauge Framing* – T-Bar** – Nom 3 in. (76 mm) wide by 1-1/2 in. (38 mm) high tee section formed from galv steel. T Bar installed between mullions at each floor level to restrain curtain wall insulation (Item 2J) against outward movement when forming material (Item 3A) is installed. The T Bar shall be installed with a clearance of 1 1/2 to 3/4 in. at each end. The bottom edge of the T Bar shall rest in and

be supported by the hemmed edge of the T Bar support bracket (Item 2F) at each end. The top edge of the T Bar shall be locked in place with a locking clip (Item 2H) at one end and by a min No. 10 by 1/2 in. (13 mm) long self-drilling, self-tapping steel screw at the opposite end. Each T Bar shall be located with its stem at an elevation 2 in. (51 mm) below the top plane of the floor.

THERMAFIBER INC

- H. Light Gauge Framing* – T-Bar Locking Clip** – Nom 1 × 1-1/4 in. (25 × 32 mm) clips formed from galv steel and designed to lock top of T Bar (Item 2G) to T Bar support brackets (Item 2F).

THERMAFIBER INC

- I. Light Gauge Framing* – Vertical and Horizontal Hangers** – Vertical and horizontal hangers formed from 1 in. (25 mm) wide galv steel strips, supplied in two configurations with length as needed to accommodate thickness of curtain wall insulation (Item 2J) and mullion cover (Item 2L). Vertical hangers (with 90 deg twist) screw-attached to interior face of mullions with No. 10 by min 1/2 in. (13 mm) long self-drilling, self-tapping steel screws. Vertical hangers on mullions to be located near each corner of each piece of curtain wall insulation except for the nominal 7 to 9 in. (178 to 914 mm) high piece of curtain wall insulation located immediately beneath the stem of the T Bar. The 7 to 9 in. (178 to 914 mm) high piece of curtain wall insulation immediately beneath the stem of the T Bar requires only one vertical hanger near its midheight at each end. Horizontal hangers (without twist) screw-attached to T Bar (Item 2G) and to transom at top of spandrel panel (sill of vision panel) with No. 10 by min 1/2 in. (13 mm) long self-drilling, self-tapping steel screws. Horizontal hangers on T Bar to be located within 6 in. of mullion at each end and spaced max 16 in. (406 mm) OC. Horizontal hanger on transom at top of spandrel panel to be located at center of transom. No hangers are to be used on the transom at the bottom of spandrel panel (lintel of vision panel).

THERMAFIBER INC

- J. Curtain Wall Insulation*** – Min 2 in. (51 mm) thick mineral wool batt insulation faced on one side with aluminum foil/scrim vapor retarder, supplied in min 36 in. (914 mm) wide batts. Insulation batts to be installed with no vertical seams. A horizontal seam is to be located 7 to 9 in. (178 to 914 mm) below the stem of the T Bar in each spandrel area and is to be sealed with aluminum foil tape. In the spandrel area beneath the stem of the T Bar, insulation panels tightly-fitted between vertical mullions and between the stem of the T Bar (Item 2G) and the transom, flush with the interior surface of framing. Insulation panels impaled on vertical and horizontal hangers (Item 2I) and secured in place with nom 2 × 2 in. (51 × 51 mm) steel locking washers (Item 2K).

THERMAFIBER INC – Firespan 90

- K. Light Gauge Framing* – Locking Washers** – Nom 2 × 2 in. (51 × 51 mm) clips formed from galv steel and designed to secure curtain wall insulation and mullion covers on vertical and horizontal hangers (Item 2I).

THERMAFIBER INC

- L. Mullion Covers – Curtain Wall Insulation*** – Nom 2 in. (51 mm) thick mineral wool batt insulation faced on one side with aluminum foil/scrim vapor retarder, supplied in min 24 × 48 in. (610 × 1219 mm) boards. Nom 12 in. (305 mm) wide strips to be centered over mullions and impaled on the same vertical hangers used to secure the spandrel panel insulation and secured in place with nom 2 × 2 in. (51 × 51 mm) locking washers (Item 2K). Mullion covers to abut the forming material (Item 3A) above and below the floor.

THERMAFIBER INC – Firespan 90

- M. Light Gauge Framing* – Spiral Anchor** (not shown) – As an alternate to the vertical hangers (Item 2I), galv steel wire spiral anchors may be used to secure the framing covers (Item 2L) to the curtain wall insulation (Item 2J) on each side of the mullion. Nom length of spiral anchors to be equal to thickness of curtain wall insulation plus thickness of framing cover. Spiral anchors driven through mullion covers and into curtain wall insulation and spaced max 12 in. (305 mm) OC.

THERMAFIBER INC

- 3. Safing System** – Max separation between the edge of the floor and the face of the framing members (at time of installation) is 4 in. (102 mm). The safing system is designed to accommodate vertical shear movement up to a max of 5 percent of its installed width. The safing system shall incorporate the following construction features:

- A. Forming Material*** – Nom 4 pcf density mineral wool batt insulation. Batt sections cut to a min 4-1/2 in. (114 mm) width and stacked to a thickness which is min 25 percent greater than the width of linear gap between the curtain wall insulation and the edge of the concrete floor slab to attain a min 20 percent compression in the thickness direction. The forming material is compressed and inserted cut-edge-first into the linear gap such that its top surface is flush with the top surface of the floor assembly. Forming material to extend completely beneath mullion mounting plate (Item 2A). A max of two tightly-butted seams are permitted in the forming material between mullions.

THERMAFIBER INC – Type SAF

- B. Fill, Void or Cavity Material*** – Min 1/8 in. (3 mm) wet thickness (min 1/16 in. or 1.6 mm dry thickness) of fill material spray-applied over top of forming material and lapping min 1/2 in. (13 mm) onto the top surface of the floor and onto the curtain wall insulation, mullion anchor plate (Item 2A) and framing covers. When 3M Fire Barrier Watertight Spray is used, min wet (and dry) thickness of spray is 1/10 in. (2.5 mm).

3M COMPANY

3M FIRE PROTECTION PRODUCTS – FireDam Spray 200, 3M Fire Barrier Watertight Spray

- B1. Fill, Void or Cavity Material* – Tape** – As an alternate to Item 3B, Tape cut to size and press applied to top surface of joint to completely cover mineral wool and overlap a min of 1 in. (25 mm) onto the top surface of the floor and onto the curtain wall insulation, mullion anchor plate (Item 2A) and framing covers. Tape shall be applied in min 1 ft (305 mm) lengths along the joint and adjoining lengths of Tape shall overlap min 1/2 in. (13 mm).

3M COMPANY

3M FIRE PROTECTION PRODUCTS – 3M Fire and Water Barrier Tape

*Indicates such products shall bear the UL or cUL Certification Mark for jurisdictions employing the UL or cUL Certification (such as Canada), respectively. 
 Reprinted from the Online Certifications Directory with permission from UL©

UL System No. CW-S-2004

March 20, 2017

F Rating – 2 Hr

T Rating – 1/4 Hr

Integrity Rating – 2 Hr

Insulation Rating – 1/4 Hr

Linear Opening Width – 8 in. max

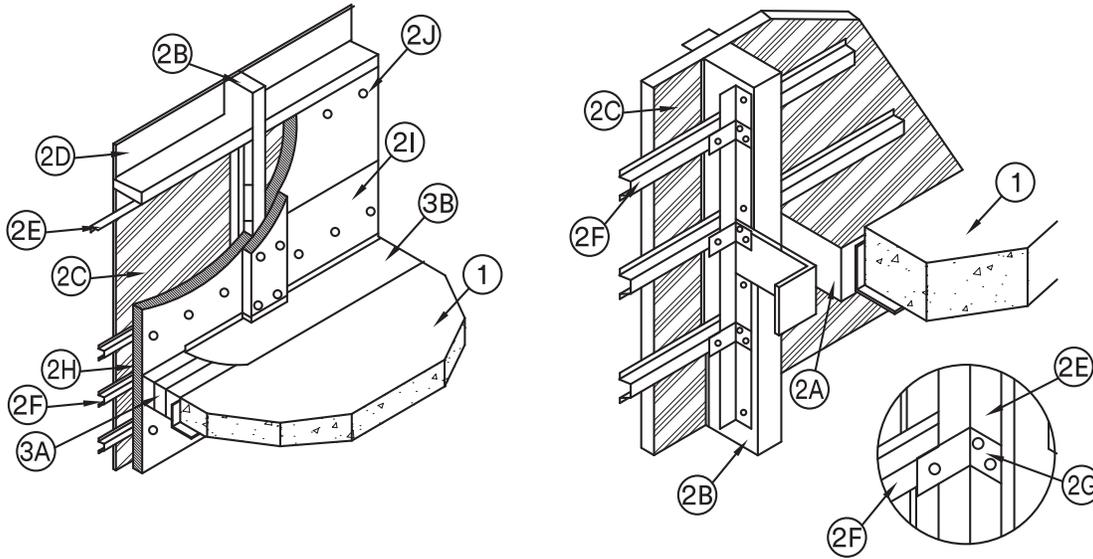

- 1. Floor Assembly** – Min 4-1/2 in. (114 mm) thick reinforced lightweight or normal weight (100-150 pcf or 1600-2400 kg/m³) structural concrete. Perimeter of floor assembly to be provided with min 4 × 4 × 1/4 in. (102 × 102 × 6 mm) thick cast-in-place structural steel angle for weld-attachment of mullion mounting clips (Item 2A).
- 2. Curtain Wall Assembly** – The curtain wall assembly shall incorporate the following construction features:
 - A. Mullion Mounting Clips** – Min 4 in. (102 mm) long angles with one nom 4 in. (102 mm) leg for attachment to edge of floor assembly and with one leg approx 4 in. (102 mm) longer than distance to nearest face of mullion. Clips welded to steel angle at edge of floor assembly (Item 1) on each side of vertical mullion (Item 2B) at each floor level. Top edge of each mounting angle to be recessed min 1/2 in. (13 mm) below top surface of floor.
 - B. Framing** – The rectangular tubing mullions (vertical members) and transoms (horizontal members) shall be minimum 2-1/2 in. (64 mm) wide by 5 in. (127 mm) deep and shall be formed from min 0.100 in. thick aluminum. Mullions spaced max 60 in. (1524 mm) OC and secured to mullion mounting clips (Item 2A) at each floor level with two 1/2 in. diam by 4 in. long hex head steel bolts in conjunction with steel nuts and washers. Interior face of mullions to be max 8 in. (203 mm) from edge of floor assembly. Transoms framing top and bottom edges of spandrel panels (Item 2C) to be spaced min 72 in. (1829 mm) OC. Transom forming sill of vision panel (Item 2D) to be located such that its bottom surface is at height of 33 in. (838 mm) above the top surface of the floor (Item 1).
 - C. Spandrel Panels** – Nom 1/4 in. (6 mm) thick opaque heat-strengthened glass. Each panel secured in position with aluminum pressure plates in conjunction with glazing gaskets and steel screws.
 - D. Vision Panels** – Nom 1/4 in. (6 mm) thick transparent heat-strengthened glass. Each panel secured in position with aluminum pressure plates in conjunction with glazing gaskets and steel screws.
 - E. Spandrel Panel Perimeter Angles** – Nom 1-1/2 × 1-1/2 in. (38 × 38 mm) No. 22 gauge galvanized steel angles installed around entire perimeter of each spandrel panel. Angles recessed from interior face of framing as necessary to accommodate thickness of curtain wall insulation (Item 2H). Angles notched as necessary to be continuous over mullion mounting clips (Item 2A). Angles screw-attached to mullions and transom along sides and top of each spandrel panel with No. 10 by 1/2 in. (13 mm) long self-drilling, self-tapping steel screws spaced max 12 in. (305 mm) OC. Angle along bottom of each spandrel panel to be screw-attached to leg of angle on mullion at each end without any direct attachment to transom.
 - F. Stiff Back Channel** – Nom 2-1/2 in. (64 mm) wide by 7/8 in. deep hat-shaped channel formed of 22 gauge galv steel to be installed to stiffen curtain wall insulation between mullions above, below and at elevation of safin joint. One stiff back channel to be located with its centerline approx 6 in. (152 mm) below floor and one stiff back channel to be located with its centerline approx 6 in. (152 mm) above floor. A third stiff back channel is to be located near the midheight of the safin joint. A clearance of 1/4 to 1/2 in. (6 to 13 mm) shall be maintained between the ends of the stiff back channels and the mullions. Stiff back channel secured to mullion at each end with channel attachment clip (Item 2G) in conjunction with a No. 8 by 1/2 in. (13 mm) long self-drilling, self-tapping wafer head steel screw or a 3/16 in. (4.8 mm) diam steel bolt with nut and washer.
 - G. Channel Attachment Clip** – Nom 1-1/2 × 2-1/2 × 1-1/2 in. (38 × 64 × 38 mm) long angle formed of 16 gauge galv steel. The 2-1/2 in. (64 mm) leg is provided with a 1/4 in. (6 mm) wide by 1-1/2 in. (38 mm) long slot along its centerline for attachment of the stiff back channel. Clips secured to mullions mounting clips (Item 2A) and mullions, through perimeter angles, with two No. 10 by 1/2 in. (13 mm) long self-drilling, self-tapping steel screws. Channel clips installed with 2-1/2 in. (64 mm) leg recessed from interior face of mullion to accommodate thickness of curtain wall insulation (Item 2H).

H. Curtain Wall Insulation* – Min 2 in. (51 mm) thick mineral wool board insulation, unfaced or faced on one side with aluminum foil/scrim vapor retarder, supplied in min 36 in. (914 mm) wide boards. Insulation boards to be installed with no vertical seams. A full-width board shall be centered at the midheight of floor and tightly-fitted between vertical mullions, flush with interior surface of framing. The centered board shall be secured to the stiff back channels (Item 2F) located approx 6 in. (152 mm) above and below the floor with cup head weld pins (Item 2J) spaced max 10 in. (254 mm) OC along each channel. The remainder of the spandrel panel framing above and below the centered full-width board shall be filled in with additional lengths of board cut to fit tightly between mullions and with the horizontal seams between board sections tightly butted. The boards shall be secured to the spandrel panel perimeter angles with cup head weld pins at each corner of each board and spaced max 10 in. (254 mm) OC. When faced boards are used, butted seams to be covered with min 4 in. (102 mm) wide aluminum foil tape.

ROCKWOOL MALAYSIA SDN BHD – CurtainRock 80

ROXUL INC – CurtainRock 80

I. Framing Covers – Curtain Wall Insulation* – Min 8 in. wide strips cut from the same min 2 in. (51 mm) thick mineral wool batt insulation used for the curtain wall insulation (Item 2H). Framing covers to be centered over mullions, and secured to the spandrel panel perimeter angles (Item 2E) with cup head weld pins (Item 2J) spaced max 12 in. (305 mm) OC. Where more than one spandrel panel occurs between vertically separated vision panels, the horizontal transom between spandrel panels shall also be covered with an 8 in. (203 mm) wide framing cover in the same manner as on the vertical mullions. Framing covers on mullions to abut the mineral wool batt safing material (Item 3A) above and below floor.

ROCKWOOL MALAYSIA SDN BHD – CurtainRock 80

ROXUL INC – CurtainRock 80

J. Weld Pin – No. 12 gauge galv steel weld pin with nom 1-3/16 in. (30 mm) diam galv steel cup head. Cup head weld pins provided in two lengths. One length to be equal to thickness of curtain wall insulation (Item 2H) and second length to be equal to thickness of curtain wall insulation plus thickness of framing cover (Item 2I). Cup head weld pins inserted through curtain wall insulation and mullion covers and welded to spandrel panel perimeter angles at max OC spacings referenced in Items 2H and 2I.

3. Perimeter Fire Containment System – The perimeter fire containment system shall incorporated the following construction features:

A. Forming Material* – Nom 4 in. (102 mm) thick, mineral wool batt safing material to be installed in continuous pieces between mullion clips. Safing material to be cut to a min 4-1/2 in. (114 mm) width and stacked to a thickness which is at least 25 percent greater than the width of the linear gap between the curtain wall and the edge of the concrete floor slab. The safing material is compressed and inserted cut-edge-first into the linear gap such that its top surface is flush with the top-surfaces of the floor assembly and such that it is friction-fit between mullion mounting angles. Additional pieces of safing material to be friction-fit into space between mullion mounting clips at each mullion location with top edges of mullion clips covered with a min 1/2 in. (13 mm) thickness of compressed safing material.

ROCKWOOL MALAYSIA SDN BHD – SAFE

ROXUL INC – SAFE

B. Fill, Void or Cavity Material* – Min 1/16 in. (1.6 mm) dry (1/8 in. or 3 mm wet) thickness of fill material spray-applied over top of forming material and lapping min 1 in. (25 mm) onto the top surface of the concrete floor and onto the curtain wall insulation and framing covers. When 3M Fire Barrier Watertight Spray is used, min wet (and dry) thickness of spray is 1/10 in. (2.5 mm).

3M COMPANY – FireDam™ Spray 200, 3M Fire Barrier Watertight Spray

B1. Fill, Void or Cavity Material* – Tape – As an alternate to Item 3B, Tape cut to size and press applied to top surface of joint to completely cover mineral wool and overlap a min of 1 in. (25 mm) onto the top surface of the floor and onto the curtain wall insulation and mullion covers. Tape shall be applied in minimum 1 ft (305 mm) lengths along the joint and adjoining lengths of Tape shall overlap min 1/2 in. (13 mm).

3M COMPANY – 3M Fire and Water Barrier Tape

*Indicates such products shall bear the UL or cUL Certification Mark for jurisdictions employing the UL or cUL Certification (such as Canada), respectively. 

Reprinted from the Online Certifications Directory with permission from UL©

UL System No. CW-S-2005

March 20, 2017

F Rating – 2 Hr

T Rating – 1/4 Hr

Integrity Rating – 2 Hr

Insulation Rating – 1/4 Hr

Linear Opening Width – 8 in. max

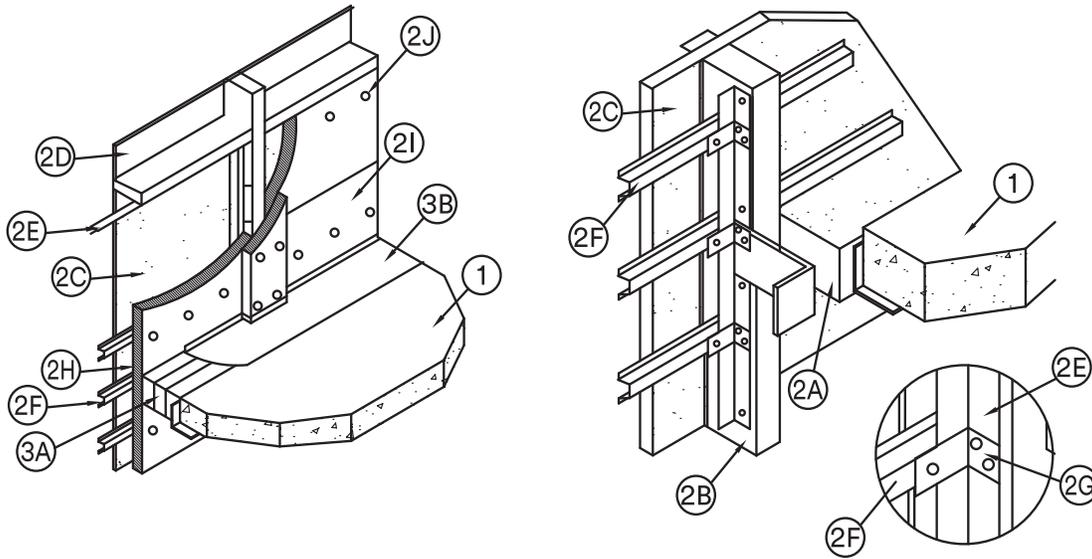

- 1. Floor Assembly** – Min 4-1/2 in. (114 mm) thick reinforced lightweight or normal weight (100-150 pcf or 1600-2400 kg/m³) structural concrete. Perimeter of floor assembly to be provided with min 4 × 4 × 1/4 in. (102 × 102 × 6 mm) thick cast-in-place structural steel angle for weld-attachment of mullion mounting clips (Item 2A).
- 2. Curtain Wall Assembly** – The curtain wall assembly shall incorporate the following construction features:
 - A. Mullion Mounting Clips** – Min 4 in. (102 mm) long angles with one nom 4 in. (102 mm) leg for attachment to edge of floor assembly and with one leg approx 4 in. (102 mm) longer than distance to nearest face of mullion. Clips welded to steel angle at edge of floor assembly (Item 1) on each side of vertical mullion (Item 2B) at each floor level. Top edge of each mounting angle to be recessed min 1/2 in. (13 mm) below top surface of floor.
 - B. Framing** – The rectangular tubing mullions (vertical members) and transoms (horizontal members) shall be minimum 2-1/2 in. (64 mm) wide by 5 in. (127 mm) deep and shall be formed from min 0.100 in. thick aluminum. Mullions spaced max 60 in. (1524 mm) OC and secured to mullion mounting clips (Item 2A) at each floor level with two 1/2 in. (13 mm) diam by 4 in. (102 mm) long hex head steel bolts in conjunction with steel nuts and washers. Interior face of mullions to be max 8 in. (203 mm) from edge of floor assembly. Transoms framing top and bottom edges of spandrel panels (Item 2C) to be spaced min 72 in. (1829 mm) OC. Transom forming sill of vision panel (Item 2D) to be located such that its bottom surface is at height of 33 in. (838 mm) above the top surface of the floor (Item 1).
 - C. Spandrel Panels** – Nom 1-3/16 in. (30 mm) thick polished granite spandrel panels with 1 in. (25 mm) thick gauged edges. Each panel secured in position with aluminum pressure plates in conjunction with gaskets and steel screws.
 - D. Vision Panels** – Nom 1/4 in. (6 mm) thick transparent heat-strengthened glass. Each panel secured in position with aluminum pressure plates in conjunction with glazing gaskets and steel screws.
 - E. Spandrel Panel Perimeter Angles** – Nom 1-1/2 × 1-1/2 in. (38 × 38 mm) by No. 22 gauge galvanized steel angles installed around entire perimeter of each spandrel panel. Angles recessed from interior face of framing as necessary to accommodate thickness of curtain wall insulation (Item 2H). Angles notched as necessary to be continuous over mullion mounting clips (Item 2A). Angles screw-attached to mullions and transom along sides and top of each spandrel panel with No. 10 by 1/2 in. long self-drilling, self-tapping steel screws spaced max 12 in. (305 mm) OC. Angle along bottom of each spandrel panel to be screw-attached to leg of angle on mullion at each end without any direct attachment to transom.
 - F. Stiff Back Channel** – Nom 2-1/2 in. (64 mm) wide by 7/8 in. (22 mm) deep hat-shaped channel formed of 22 gauge galv steel to be installed to stiffen curtain wall insulation between mullions above, below and at elevation of safing joint. One stiff back channel to be located with its centerline approx 6 in. (152 mm) below floor and one stiff back channel to be located with its centerline approx 6 in. (152 mm) above floor. A third stiff back channel is to be located near the midheight of the safing joint. A clearance of 1/4 to 1/2 in. (6 to 13 mm) shall be maintained between the ends of the stiff back channels and the mullions. Stiff back channel secured to mullion at each end with channel attachment clip (Item 2G) in conjunction with a No. 8 by 1/2 in. (13 mm) long self-drilling, self-tapping wafer head steel screw or a 3/16 in. (4.8 mm) diam steel bolt with nut and washer.
 - G. Channel Attachment Clips** – Nom 1-1/2 × 2-1/2 × 1-1/2 in. (38 × 64 × 38 mm) long angle formed of 16 gauge galv steel. The 2-1/2 in. (64 mm) leg is provided with a 1/4 in. (6 mm) wide by 1-1/2 in. (38 mm) long slot along its centerline for attachment of the stiff back channel. Clips secured to mullions mounting clips (Item 2A) and mullions, through perimeter angles, with two No. 10 by 1/2 in. (13 mm) long self-drilling, self-tapping steel screws. Channel clips installed with 2-1/2 in. (64 mm) leg recessed from interior face of mullion to accommodate thickness of curtain wall insulation (Item 2H).

H. Curtain Wall Insulation* – Min 2 in. (51 mm) thick mineral wool board insulation, unfaced or faced on one side with aluminum foil/scrim vapor retarder, supplied in min 36 in. (914 mm) wide boards. Insulation boards to be installed with no vertical seams. A full-width board shall be centered at the midheight of floor and tightly-fitted between vertical mullions, flush with interior surface of framing. The centered board shall be secured to the stiff back channels (Item 2F) located approx 6 in. (152 mm) above and below the floor with cup head weld pins (Item 2J) spaced max 10 in. (254 mm) OC along each channel. The remainder of the spandrel panel framing above and below the centered full-width board shall be filled in with additional lengths of board cut to fit tightly between mullions and with the horizontal seams between board sections tightly butted. The boards shall be secured to the spandrel panel perimeter angles with cup head weld pins at each corner of each board and spaced max 10 in. (254 mm) OC. When faced boards are used, butted seams to be covered with min 4 in. (102 mm) wide aluminum foil tape.

ROCKWOOL MALAYSIA SDN BHD – CurtainRock 80

ROXUL INC – CurtainRock 80

I. Framing Covers – Curtain Wall Insulation* – Min 8 in. (203 mm) wide strips cut from the same min 2 in. (51 mm) thick mineral wool batt insulation used for the curtain wall insulation (Item 2H). Framing covers to be centered over mullions, and secured to the spandrel panel perimeter angles (Item 2E) with cup head weld pins (Item 2J) spaced max 12 in. (305 mm) OC. Where more than one spandrel panel occurs between vertically separated vision panels, the horizontal transom between spandrel panels shall also be covered with an 8 in. (203 mm) wide framing cover in the same manner as on the vertical mullions. Framing covers on mullions to abut the mineral wool batt safing material (Item 3A) above and below floor.

ROCKWOOL MALAYSIA SDN BHD – CurtainRock 80

ROXUL INC – CurtainRock 80

J. Weld Pin – No. 12 gauge galv steel weld pin with nom 1-3/16 in. (30 mm) diam galv steel cup head. Cup head weld pins provided in two lengths. One length to be equal to thickness of curtain wall insulation (Item 2H) and second length to be equal to thickness of curtain wall insulation plus thickness of framing cover (Item 2I). Cup head weld pins inserted through curtain wall insulation and mullion covers and welded to spandrel panel perimeter angles at max OC spacings referenced in Items 2H and 2I.

3. Perimeter Fire Containment System – The perimeter fire containment system shall incorporate the following construction features:

A. Forming Material* – Nom 4 in. (102 mm) thick, mineral wool batt safing material to be installed in continuous pieces between mullion clips. Safing material to be cut to a min 4-1/2 in. (114 mm) width and stacked to a thickness which is at least 25 percent greater than the width of the linear gap between the curtain wall and the edge of the concrete floor slab. The safing material is compressed and inserted cut-edge-first into the linear gap such that its top surface is flush with the top-surfaces of the floor assembly and such that it is friction-fit between mullion mounting angles. Additional pieces of safing material to be friction-fit into space between mullion mounting clips at each mullion location with top edges of mullion clips covered with a min 1/2 in. (13 mm) thickness of compressed safing material.

ROCKWOOL MALAYSIA SDN BHD – SAFE

ROXUL INC – SAFE

B. Fill, Void or Cavity Material* – Min 1/16 in. (1.6 mm) dry (1/8 in. (3.2 mm) wet) thickness of fill material spray-applied over top of forming material and lapping min 1 in. (25 mm) onto the top surface of the concrete floor and onto the curtain wall insulation and framing covers. When 3M Fire Barrier Watertight Spray is used, min wet (and dry) thickness of spray is 1/10 in. (2.5 mm).

3M COMPANY – FireDam™ Spray 200, 3M Fire Barrier Watertight Spray

B1. Fill, Void or Cavity Material* – Tape – As an alternate to Item 3B, Tape cut to size and press applied to top surface of joint to completely cover mineral wool and overlap a min of 1 in. (25 mm) onto the top surface of the floor and onto the curtain wall insulation and framing covers. Tape shall be applied in min 1 ft (305 mm) lengths along the joint and adjoining lengths of Tape shall overlap min 1/2 in. (13 mm).

3M COMPANY – 3M Fire and Water Barrier Tape

*Indicates such products shall bear the UL or cUL Certification Mark for jurisdictions employing the UL or cUL Certification (such as Canada), respectively. 

Reprinted from the Online Certifications Directory with permission from UL©

UL System No. CW-S-2007

March 20, 2017

F Rating – 2 Hr

T Rating – 1/4 Hr

Integrity Rating – 2 Hr

Insulation Rating – 1/4 Hr

Linear Opening Width – 8 in. Max

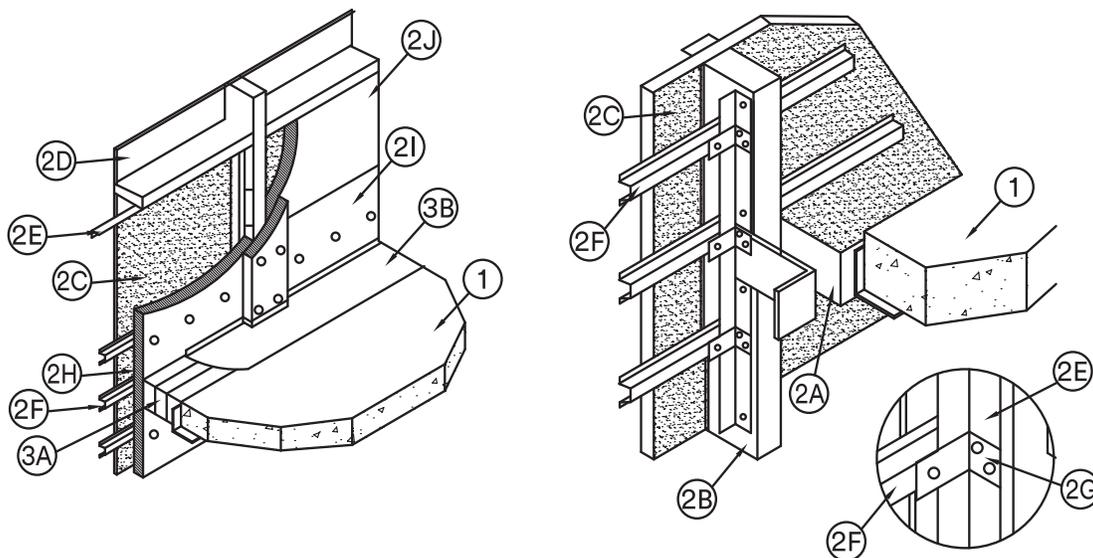

1. **Floor Assembly** – Min 4-1/2 in. (114 mm) thick reinforced lightweight or normal weight (100-150 pcf or 1600-2400 kg/m³) structural concrete. Perimeter of floor assembly to be provided with min 4 × 4 × 1/4 in. (102 × 102 × 6 mm) thick cast-in-place structural steel angle for weld-attachment of mullion mounting clips (Item 2A).
2. **Curtain Wall Assembly** – The curtain wall assembly shall incorporate the following construction features:
 - A. **Mullion Mounting Clips** – Min 4 in. (102 mm) long angles with one nom 4 in. (102 mm) leg for attachment to edge of floor assembly and with one leg approx 4 in. (102 mm) longer than distance to nearest face of mullion. Clips welded to steel angle at edge of floor assembly (Item 1) on each side of vertical mullion (Item 2B) at each floor level. Top edge of each mounting angle to be recessed min 1/2 in. (13 mm) below top surface of floor.
 - B. **Framing** – The rectangular tubing mullions (vertical members) and transoms (horizontal members) shall be minimum 2-1/2 in. (64 mm) wide by 5 in. (127 mm) deep and shall be formed from min 0.100 in. thick aluminum. Mullions spaced max 60 in. (1524 mm) OC and secured to mullion mounting clips (Item 2A) at each floor level with two 1/2 in. (13 mm) diam by 4 in. (102 mm) long hex head steel bolts in conjunction with steel nuts and washers. Interior face of mullions to be max 8 in. (204 mm) from edge of floor assembly. Transoms framing top and bottom edges of spandrel panels (Item 2C) to be spaced min 72 in. (1829 mm) OC. Transom forming sill of vision panel (Item 2D) to be located such that its bottom surface is at height of 33 in. (838 mm) above the top surface of the floor (Item 1).
 - C. **Spandrel Panels** – Nom 1/8 in. (3 mm) thick aluminum panels with 1/4 in. (6 mm) thick edges. Each panel secured in position with aluminum pressure plates in conjunction with gaskets and steel screws.
 - D. **Vision Panels** – Nom 1/4 in. (6 mm) thick transparent heat-strengthened glass. Each panel secured in position with aluminum pressure plates in conjunction with glazing gaskets and steel screws.
 - E. **Spandrel Panel Perimeter Angles** – Nom 1-1/2 × 1-1/2 in. (38 × 38 mm) by No. 22 gauge galvanized steel angles installed around entire perimeter of each spandrel panel. Angles recessed from interior face of framing as necessary to accommodate thickness of curtain wall insulation (Item 2H). Angles notched as necessary to be continuous over mullion mounting clips (Item 2A). Angles screw-attached to mullions and transom along sides and top of each spandrel panel with No. 10 by 1/2 in. (13 mm) long self-drilling, self-tapping steel screws spaced max 12 in. (305 mm) OC. Angle along bottom of each spandrel panel to be screw-attached to leg of angle on mullion at each end without any direct attachment to transom.
 - F. **Stiff Back Channel** – Nom 2-1/2 in. (64 mm) wide by 7/8 in. (22 mm) deep hat-shaped channel formed of 22 gauge galv steel to be installed to stiffen curtain wall insulation between mullions above, below and at elevation of safing joint. One stiff back channel to be located with its centerline approx 6 in. (152 mm) below floor and one stiff back channel to be located with its centerline approx 6 in. (152 mm) above floor. A third stiff back channel is to be located near the midheight of the safing joint. A clearance of 1/4 to 1/2 in. (6 to 13 mm) shall be maintained between the ends of the stiff back channels and the mullions. Stiff back channel secured to mullion at each end with channel attachment clip (Item 2G) in conjunction with a No. 8 by 1/2 in. (13 mm) long self-drilling, self-tapping wafer head steel screw or a 3/16 in. (4.8 mm) diam steel bolt with nut and washer.
 - G. **Channel Attachment Clips** – Nom 1-1/2 × 2-1/2 × 1-1/2 in. (38 × 64 × 38 mm) long angle formed of 16 gauge galv steel. The 2-1/2 in. (64 mm) leg is provided with a 1/4 in. (6 mm) wide by 1-1/2 in. (38 mm) long slot along its centerline for attachment of the stiff back channel. Clips secured to mullion mounting clips (Item 2A) and mullions, through perimeter angles, with two No. 10 by 1/2 in. (13 mm) long self-drilling, self-tapping steel screws. Channel clips installed with 2-1/2 in. (64 mm) leg recessed from interior face of mullion to accommodate thickness of curtain wall insulation (Item 2H).

H. Curtain Wall Insulation* – Min 2 in. (51 mm) thick mineral wool board insulation, unfaced or faced on one side with aluminum foil/scrim vapor retarder, supplied in min 36 in. (914 mm) wide boards. Insulation boards to be installed with no vertical seams. A full-width board shall be centered at the midheight of floor and tightly-fitted between vertical mullions, flush with interior surface of framing. The centered board shall be secured to the stiff back channels (Item 2F) located approx 6 in. (152 mm) above and below the floor with cup head weld pins (Item 2J) spaced max 10 in. (254 mm) OC along each channel. The remainder of the spandrel panel framing above and below the centered full-width board shall be filled in with additional lengths of board cut to fit tightly between mullions and with the horizontal seams between board sections tightly butted. The boards shall be secured to the spandrel panel perimeter angles with cup head weld pins at each corner of each board and spaced max 10 in. (254 mm) OC. When faced boards are used, butted seams to be covered with min 4 in. (102 mm) wide aluminum foil tape.

ROCKWOOL MALAYSIA SDN BHD – CurtainRock 80

ROXUL INC – CurtainRock 80

I. Framing Covers – Curtain Wall Insulation* – Min 8 in. wide strips cut from the same min 2 in. (51 mm) thick mineral wool batt insulation used for the curtain wall insulation (Item 2H). Framing covers to be centered over mullions and secured to the spandrel panel perimeter angles (Item 2E) with cup head weld pins (Item 2J) spaced max 12 in. (305 mm) OC. Where more than one spandrel panel occurs between vertically separated vision panels, the horizontal transom between spandrel panels shall also be covered with an 8 in. (203 mm) wide framing cover in the same manner as on the vertical mullions. Framing covers on mullions to abut the mineral wool batt safing material (Item 3A) above and below floor.

ROCKWOOL MALAYSIA SDN BHD – CurtainRock 80

ROXUL INC – CurtainRock 80

J. Weld Pin – No. 12 gauge galv steel weld pin with nom 1-3/16 in. (30 mm) diam galv steel cup head. Cup head weld pins provided in two lengths. One length to be equal to thickness of curtain wall insulation (Item 2H) and second length to be equal to thickness of curtain wall insulation plus thickness of framing cover (Item 2I). Cup head weld pins inserted through curtain wall insulation and mullion covers and welded to spandrel panel perimeter angles at max OC spacings referenced in Items 2H and 2I.

3. Perimeter Fire Containment System – The perimeter fire containment system shall incorporated the following construction features:

A. Forming Material* – Nom 4 in. (102 mm) thick mineral wool batt safing material to be installed in continuous pieces between mullion clips. Safing material to be cut to a min 4-1/2 in. (114 mm) width and stacked to a thickness which is at least 25 percent greater than the width of the linear gap between the curtain wall and the edge of the concrete floor slab. The safing material is compressed and inserted cut-edge-first into the linear gap such that its top surface is flush with the top surface of the floor assembly and such that it is friction-fit between mullion mounting angles. Additional pieces of safing material to be friction-fit into space between mullion mounting clips at each mullion location with top edges of mullion clips covered with a min 1/2 in. (13 mm) thickness of compressed safing material.

ROCKWOOL MALAYSIA SDN BHD – SAFE

ROXUL INC – SAFE

B. Fill, Void or Cavity Material* – Min 1/16 in. (1.6 mm) dry [1/8 in. (3.2 mm) wet] thickness of fill material spray-applied over top of forming material and lapping min 1 in. (25 mm) onto the top surface of the concrete floor and onto the curtain wall insulation and framing covers. When 3M Fire Barrier Watertight Spray is used, min wet (and dry) thickness of spray is 1/10 in. (2.5 mm).

3M COMPANY – FireDam™ Spray 200, 3M Fire Barrier Watertight Spray

B1. Fill, Void or Cavity Material* – Tape – As an alternate to Item 3B, Tape cut to size and press applied to top surface of joint to completely cover mineral wool and overlap a min of 1 in. (25 mm) onto the top surface of the floor and onto the curtain wall insulation (Item 2E) and mullion covers (Item 2F). Tape shall be applied in min 1 ft (305 mm) lengths along the joint and adjoining lengths of Tape shall overlap min 1/2 in. (13 mm).

3M COMPANY – 3M Fire and Water Barrier Tape

*Indicates such products shall bear the UL or cUL Certification Mark for jurisdictions employing the UL or cUL Certification (such as Canada), respectively. 

Reprinted from the Online Certifications Directory with permission from UL©



3M Firestop Systems

Construction Joints

Perimeter Joint

3MU/BPF

Perimeter Joint

3MU/JS

Perimeter Joint

3MU/PFB

Perimeter Joint

Quick Reference Guide

Perimeter Joint

| 3M Systems | "F" Rating | 3M Product | Application Details |
|----------------|------------|---|--|
| 3MU/BPF 120-01 | 2 | 3M™ FireDam™ Spray 200 3M™ Fire Barrier Water Tight Sealant 1000 NS 3M™ Fire Barrier Water Tight Sealant 1003 SL 3M™ Fire and Water Barrier Tape 3M™ Watertight Spray | Pre-cast concrete panels with max. 1 in. butt joints. Curtain wall insulation seams must be offset from panel joints. Optional vision glass. +/- 10% horizontal movement @25% compression. +/- 6.25% vertical shear movement @25% compression. Max 8 in. joint. 2 hour F Rating. 0 hour T Rating. Formerly known as CEJ371P. |
| 3MU/BPF 120-03 | 2 | 3M™ FireDam™ Spray 200 3M™ Watertight Spray 3M™ Fire and Water Barrier Tape 3M™ Fire Barrier Water Tight Sealant 1000 NS 3M™ Fire Barrier Water Tight Sealant 1003 SL | 2 hour curtain wall joint between a concrete floor or concrete beam and an aluminum framed glass panel curtain wall assembly. Max. 12 in. joint width. |
| 3MU/BPF 180-01 | 3 | 3M™ FireDam™ Spray 200 3M™ Fire Barrier Water Tight Sealant 1000 NS 3M™ Fire Barrier Water Tight Sealant 1003 SL 3M™ Fire and Water Barrier Tape 3M™ Watertight Spray | Concrete spandrel panels with steel stud framing. Interior surface concrete, optional foil faced curtain wall insulation. Max 8 in. joint. 3 hour design. Formerly CEJ162P. |
| 3MU/BPF 180-02 | 3 | 3M™ FireDam™ Spray 200 3M™ Watertight Spray 3M™ Fire and Water Barrier Tape 3M™ Fire Barrier Water Tight Sealant 1000 NS 3M™ Fire Barrier Water Tight Sealant 1003 SL | 2 hour flexible wrap protection for a circular or rectangular steel HVAC duct using Fire Barrier Duct Wrap 615+. Tested per ISO 6944. Also addresses through penetrations of rated horizontal or vertical assemblies. |
| 3MU/JS 120-05 | 2 | 3M™ FireDam™ Spray 200 3M™ Fire Barrier Water Tight Sealant 1000 NS 3M™ Fire Barrier Water Tight Sealant 1003 SL | Concrete spandrel panels. Steel stud framing. Foil faced curtain wall insulation (Optional). See system for details on packing material compression and movement capabilities. Max 8 in. joint. 2 hour F rating. |
| 3MU/JS 120-06 | 2 | 3M™ FireDam™ Spray 200 3M™ Fire Barrier Water Tight Sealant 1000 NS 3M™ Fire Barrier Water Tight Sealant 1003 SL | Aluminum spandrel panels. Steel stud framing. Interior surface gypsum. Foil faced curtain wall insulation is required. See system for details on packing material compression and movement capabilities. Max 8 in. joint. 2 hour design. Formerly known as CEJ120P. Also known as 3MUJS12006. |
| 3MU/JS 120-07 | 2 | 3M™ FireDam™ Spray 200 3M™ Fire Barrier Water Tight Sealant 1000 NS 3M™ Fire Barrier Water Tight Sealant 1003 SL | Glass spandrel panels. Steel stud framing. Interior surface gypsum. Foil faced curtain wall insulation is required. See system for details on packing material compression and movement capabilities. Max 8 in. joint. 2 hour design. Formerly known as CEJ121P. Also known as 3MUJS12007. |
| 3MU/JS 120-08 | 2 | 3M™ FireDam™ Spray 200 3M™ Fire Barrier Water Tight Sealant 1000 NS 3M™ Fire Barrier Water Tight Sealant 1003 SL | Aluminum spandrel panels. Steel stud framing. Interior surface foil faced, foil faced curtain wall insulation is required. See system for details on packing material compression and movement capabilities. 2 hour design. Formerly known as CEJ122P. Also known as 3MUJS12008. |
| 3MU/JS 120-09 | 2 | 3M™ FireDam™ Spray 200 3M™ Fire Barrier Water Tight Sealant 1000 NS 3M™ Fire Barrier Water Tight Sealant 1003 SL | Glass spandrel panels. Steel stud framing. Interior surface foil faced. Foil faced curtain wall insulation is required. See system for details on packing material compression and movement capabilities. Max 8 in. joint. 2 hour design. Formerly known as CEJ123P. Also known as 3MUJS12009 |
| 3MU/JS 120-10 | 2 | 3M™ FireDam™ Spray 200 3M™ Fire Barrier Water Tight Sealant 1000 NS 3M™ Fire Barrier Water Tight Sealant 1003 SL | Aluminum spandrel panels. Aluminum framing. Interior surface foil faced. Foil faced curtain wall insulation is required. See system for details on packing material compression and movement capabilities. Max 8 in. joint. 2 hour design. Formerly known as CEJ124P. Also known as 3MUJS12010. |
| 3MU/JS 120-11 | 2 | 3M™ FireDam™ Spray 200 3M™ Fire Barrier Water Tight Sealant 1000 NS 3M™ Fire Barrier Water Tight Sealant 1003 SL | Steel spandrel panels Aluminum framing. Interior surface foil faced. Foil faced curtain wall insulation is required. See system for details on packing material compression and movement capabilities. Max 8 in. joint. 2 hour design. Formerly known as CEJ125P. Also known as 3MUJS12011. |
| 3MU/JS 120-12 | 2 | 3M™ FireDam™ Spray 200 3M™ Fire Barrier Water Tight Sealant 1000 NS 3M™ Fire Barrier Water Tight Sealant 1003 SL | Concrete spandrel panels. Aluminum framing. Interior surface foil faced. Foil faced curtain wall insulation is required. See system for details on packing material compression and movement capabilities. Max 8 in. joint. 2 hour design. Previously known as CEJ126P. Also known as 3MUJS12012. |
| 3MU/JS 120-13 | 2 | 3M™ FireDam™ Spray 200 3M™ Fire Barrier Water Tight Sealant 1000 NS 3M™ Fire Barrier Water Tight Sealant 1003 SL | Tilt-up concrete panels attached directly to structural framing. Interior surface concrete. Optional curtain wall insulation. See system for details on packing material compression and movement capabilities. Max 8 in. joint. 2 hour design. Formerly known as CEJ158P. Also known as 3MUJS12013. |

Perimeter Joint

| 3M Systems | "F" Rating | 3M Product | Application Details |
|---------------|------------|---|---|
| 3MU/JS 120-14 | 2 | 3M™ FireDam™ Spray 200 3M™ Fire Barrier Water Tight Sealant 1000 NS 3M™ Fire Barrier Water Tight Sealant 1003 SL | Steel spandrel panels. Steel stud framing. Interior surface gypsum. Optional foil faced curtain wall insulation. 2 hour design. See system for details on packing material compression and movement capabilities. Max 8 in. joint. Formerly known as CEJ159P. Also known as 3MUJS12014. |
| 3MU/JS 120-15 | 2 | 3M™ FireDam™ Spray 200 3M™ Fire Barrier Water Tight Sealant 1000 NS 3M™ Fire Barrier Water Tight Sealant 1003 SL | Aluminum spandrel panels. Steel stud framing. Interior surface gypsum. Foil faced curtain wall insulation is required. See system for details on packing material compression and movement capabilities. Max 8 in. joint. 2 hour design. Formerly known as CEJ163P. Also known as 3MUJS12015. |
| 3MU/JS 120-16 | 2 | 3M™ FireDam™ Spray 200 3M™ Fire Barrier Water Tight Sealant 1000 NS 3M™ Fire Barrier Water Tight Sealant 1003 SL | Glass spandrel panels. Steel stud framing. Interior surface gypsum. Foil-faced curtain wall insulation required. See system for details on packing material compression and movement capabilities. Max 8 in. joint. 2 hour design. Formerly known as CEJ164P. Also known as 3MUJS12016. |
| 3MU/JS 120-17 | 2 | 3M™ FireDam™ Spray 200 3M™ Fire Barrier Water Tight Sealant 1000 NS 3M™ Fire Barrier Water Tight Sealant 1003 SL | Steel back-pan with aluminum framing. Glass spandrel on exterior. Vision glass. Foil faced curtain wall insulation is required. Max 6 in. joint. 2 hour design. 3/4 hour T. Horizontal movement 10 % + or - . Vertical shear movement 6.25% = or - . Formerly known as CEJ266P. Also known as 3MUJS12017. |
| 3MU/JS 120-18 | 2 | 3M™ FireDam™ Spray 200 3M™ Fire Barrier Water Tight Sealant 1000 NS 3M™ Fire Barrier Water Tight Sealant 1003 SL | Steel back-pan with aluminum tube framing. Aluminum spandrel on exterior. Vision glass. Foil faced curtain wall insulation is required. 2 hour design. 3/4 hour T. Max 6 in. joint. Horizontal movement 10 % + or - . Vertical shear movement 6.25% = or - . Formerly known as CEJ267P. Also known as 3MUJS12018. |
| 3MU/JS 120-19 | 2 | 3M™ FireDam™ Spray 200 3M™ Fire Barrier Water Tight Sealant 1000 NS 3M™ Fire Barrier Water Tight Sealant 1003 SL | Pre-cast concrete panels. Steel or aluminum framing. Vision glass. Foil faced curtain wall insulation is required. 2 hour design. See system for details on packing material compression and movement capabilities. Max 8 in. joint. Formerly known as CEJ288P. Also known as 3MUJS12019. |
| 3MU/JS 120-20 | 2 | 3M™ FireDam™ Spray 200 3M™ Fire Barrier Water Tight Sealant 1000 NS 3M™ Fire Barrier Water Tight Sealant 1003 SL | Pre-cast concrete panels Steel framing. Vision glass. Optional foil faced curtain wall insulation. 2 hour design. See system for details on packing material compression and movement capabilities. Max 8 in. joint. Formerly known as CEJ289P. Also known as 3MUJS12020. |
| 3MU/JS 120-21 | 2 | 3M™ FireDam™ Spray 200 3M™ Fire Barrier Water Tight Sealant 1000 NS 3M™ Fire Barrier Water Tight Sealant 1003 SL | Granite spandrel panels. Aluminum tube framing. Vision glass. Foil faced curtain wall insulation is required. 2 hour design. See system for details on packing material compression and movement capabilities. Max 8 in. joint. Formerly known as CEJ313P. Also known as 3MUJS12021. |
| 3MU/JS 120-22 | 2 | 3M™ FireDam™ Spray 200 3M™ Fire Barrier Water Tight Sealant 1000 NS 3M™ Fire Barrier Water Tight Sealant 1003 SL | Optional curtain wall insulation. Optional interior curtain wall surface, knee-wall. Exterior curtain wall finish: EIFS, glass panels, aluminum panels, brick, stucco, stone, siding, GFRC panels. Steel framing. Optional vision glass. 0% horizontal and vertical shear movement. Maximum 8-1/2 in. joint. 2 hour F rating. 1 hour T rating. Formerly known as CEJ370P. Also known as 3MUJS12022. |
| 3MU/JS 120-23 | 2 | 3M™ FireDam™ Spray 200 3M™ Fire Barrier Water Tight Sealant 1000 NS 3M™ Fire Barrier Water Tight Sealant 1003 SL | Pre-cast concrete panels with max. 1 in. butt joints. Curtain wall insulation seams must be offset from panel joints. Optional vision glass. +/- 10% horizontal movement @33% compression. +/- 6.25% vertical shear movement @33% compression. Max 8 in. joint. 2 hour F Rating. 0 hour T Rating. Formerly known as CEJ372P. Also known as 3MUJS12023. |
| 3MU/JS 180-01 | 3 | 3M™ FireDam™ Spray 200 3M™ Fire Barrier Water Tight Sealant 1000 NS 3M™ Fire Barrier Water Tight Sealant 1003 SL | Steel spandrel panels. Steel stud framing. Foil faced curtain wall insulation required. 3 hour design. See system for details on packing material compression and movement capabilities. Max 8 in. joint. Formerly known as CEJ160P. Also known as 3MUJS18001. |
| 3MU/JS 180-02 | 3 | 3M™ FireDam™ Spray 200 3M™ Fire Barrier Water Tight Sealant 1000 NS 3M™ Fire Barrier Water Tight Sealant 1003 SL 3M™ Fire and Water Barrier Tape 3M™ Watertight Spray | Glass spandrel panels, aluminum framing. Foil faced curtain wall insulation is required. See system for details on packing material compression and movement capabilities. Max 8 in. joint. 3 hour F rating. 2-1/2 hour T rating. Also known as 3MUJS18002. Formerly known as CEJ161P. |
| 3MU/JS 180-03 | 3 | 3M™ FireDam™ Spray 200 3M™ Fire Barrier Water Tight Sealant 1000 NS 3M™ Fire Barrier Water Tight Sealant 1003 SL | Aluminum spandrel panels with teal stud framing. Interior surface is foil faced curtain wall insulation. See system for details on packing material compression and movement capabilities. Max 8 in. joint. Formerly known as CEJ165P. Also known as 3MUJS18003. |

Quick Reference Guide

Perimeter Joint

| 3M Systems | "F" Rating | 3M Product | Application Details |
|----------------|------------|---|---|
| 3MU/JS 180-04 | 3 | 3M™ FireDam™ Spray 200 3M™ Fire Barrier Water Tight Sealant 1000 NS 3M™ Fire Barrier Water Tight Sealant 1003 SL | Glass spandrel panels. Steel stud framing. Interior surface is foil faced curtain wall insulation. See system for details on packing material compression and movement capabilities. Max 8 in. joint. Formerly known as CEJ166P. Also known as 3MUJS18004. |
| 3MU/JS 180-05 | 3 | 3M™ FireDam™ Spray 200 3M™ Fire Barrier Water Tight Sealant 1000 NS 3M™ Fire Barrier Water Tight Sealant 1003 SL 3M™ Fire and Water Barrier Tape 3M™ Watertight Spray | Aluminum spandrel panels, aluminum framing. Foil faced curtain wall insulation is required. See system for details on packing material compression and movement capabilities. Max 8 in. joint. 3 hour F rating. Formerly known as CEJ167P. Also known as 3MU/JS 180-05. |
| 3MU/JS 180-06 | 3 | 3M™ FireDam™ Spray 200 3M™ Fire Barrier Water Tight Sealant 1000 NS 3M™ Fire Barrier Water Tight Sealant 1003 SL 3M™ Fire and Water Barrier Tape 3M™ Watertight Spray | Steel spandrel panels with aluminum tube framing. Interior surface is foil faced curtain wall insulation. See system for details on packing material compression and movement capabilities. Max 8 in. joint. 3 hour design. Formerly known as CEJ168P. Also known as 3MUJS18006. |
| 3MU/JS 180-07 | 3 | 3M™ FireDam™ Spray 200 3M™ Fire Barrier Water Tight Sealant 1000 NS 3M™ Fire Barrier Water Tight Sealant 1003 SL 3M™ Fire and Water Barrier Tape 3M™ Watertight Spray | Max 8 in. perimeter joint between edge of slab and concrete panel with vision glass. Vertical framing max 60 in. OC. Horizontal framing max 48 in. OC. Transom minimum 20 in. above top surface of floor. |
| 3MU/JS 180-08 | 3 | 3M™ FireDam™ Spray 200 3M™ Fire Barrier Water Tight Sealant 1000 NS 3M™ Fire Barrier Water Tight Sealant 1003 SL 3M™ Fire and Water Barrier Tape | Max 8 in. perimeter joint between edge of slab and EIFS sandwich wall system with vision glass. |
| 3MU/JS 180-09 | 3 | 3M™ FireDam™ Spray 200 3M™ Fire Barrier Water Tight Sealant 1000 NS 3M™ Fire Barrier Water Tight Sealant 1003 SL 3M™ Fire and Water Barrier Tape 3M™ Watertight Spray | Max 8 in. perimeter joint between edge of slab and glass spandrel. Vertical framing max 60 in. OC. Horizontal framing max 48 in. OC. Transom minimum 20 in. above top surface of floor. |
| 3MU/JS 180-12 | 3 | 3M™ Fire Barrier Water Tight Sealant 1000 NS 3M™ Fire Barrier Water Tight Sealant 1003 SL 3M™ FireDam™ Spray 200 3M™ Fire and Water Barrier Tape 3M™ Watertight Spray3M | Pre-Cast concrete panel, optional vision glass. Optional curtain wall insulation with optional direct application to exterior wall or stand off with clutch clips. Max 6 in. joint. Overall 48 in. spandrel height. 5% horizontal movement at 33% compression. 3 hour F rating. O hour T rating. Also known as 3MJS18012. |
| 3MU/JS 180-13 | 3 | 3M™ Fire Barrier Water Tight Sealant 1000 NS 3M™ Fire Barrier Water Tight Sealant 1003 SL 3M™ FireDam™ Spray 200 | Pre-Cast concrete panel, optional vision glass. Curtain wall insulation required. Max 6 in. joint. Overall 48 in. spandrel height. 5% horizontal movement at 33% compression. 3 hour F rating. O hour T rating. Also known as 3MUJS18013. |
| 3MU/PFB 120-30 | 2 | 3M™ FireDam™ Spray 200 3M™ Fire Barrier Water Tight Sealant 1000 NS 3M™ Fire Barrier Water Tight Sealant 1003 SL | 12 in. Perimeter joint between concrete floor and glass spandrel. 85-1/2 in. OC vertical framing. 30-1/2 in. OC horizontal framing. Transom min 20 in. above floor. |

Intertek System No. BPF 120-01

February 17, 2017
(Formerly OPL Design No. CEJ 371P)

PERIMETER FIRE BARRIERS

3M Company
FireDam™ Spray 200, Fire Barrier Watertight Spray, Fire and Water Barrier Tape FWBT,
Fire Barrier 1000 NS Silicone Sealant and Fire Barrier 1003 SL Silicone Sealant

ASTM E 2307

T-Rating 0 hr
F-Rating 2 hr

ASTM E 2307/ASTM E 1399 Cycling

Class IV: 500 cycles @ 30 cpm

Rated for ± 10% horizontal movement @ 33% Compression (Reference Item 3A)
Rated for ± 6.25% vertical shear movement @ 33% Compression (Reference Item 3A)

UL 2079

L-Rating <1.0 SCFM/LF

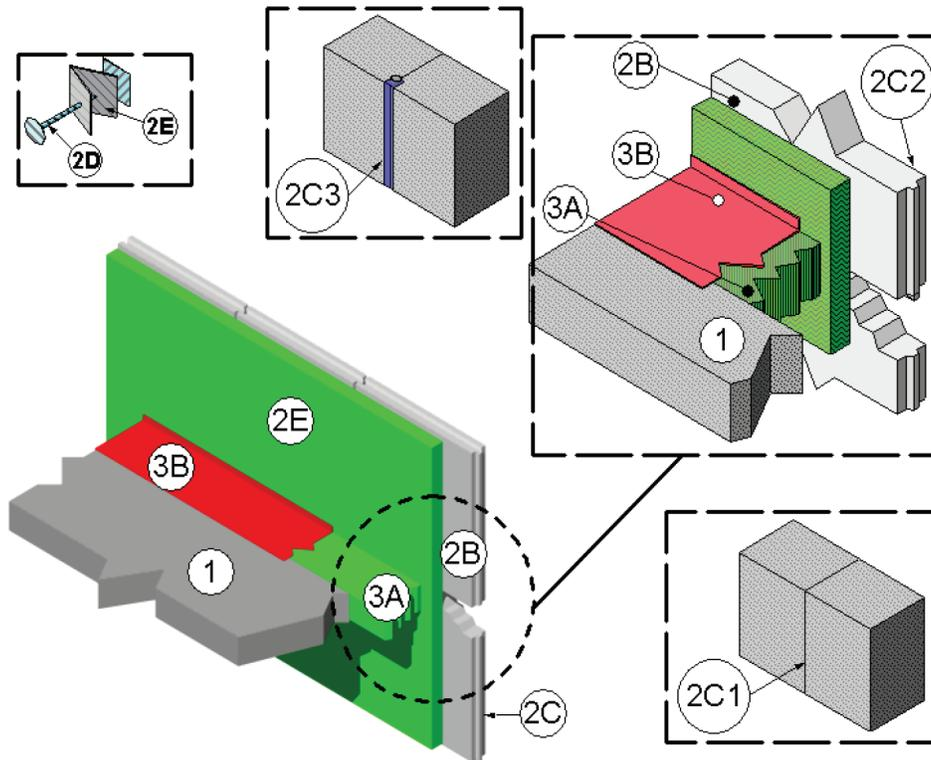

- 1. Concrete Floor Assembly** – Two-hour rated concrete floor assembly made from either lightweight or normal weight concrete with a density of 100 to 150 pound per cubic foot (pcf), having a min thickness of 4-1/2 in. at the joint face. When a longitudinal recess (blockout) is required to contain an architectural joint system, increase concrete floor assembly thickness to maintain a min thickness of 4-1/2 in. and accommodate depth of blockout formed in the concrete: blockout width unrestricted.
- 2. Curtain Wall Assembly** – Incorporate the following construction features:
 - A. Mounting Attachment** (not shown) – Attach pre-cast concrete panels (Item 2B) to the structural framing according to the curtain wall manufacturer's instructions. When required, connect the mounting attachments to the joint face of the concrete floor assembly (Item 1) according to the curtain wall manufacturer's instructions. Limit distance between mounting attachments to max 120 in.
 - B. Pre-Cast Concrete Panels** – Engineered structural panels: either tilt-up or formed panels, construct panels from steel-reinforced lightweight or normal weight (100-150 pcf) concrete, a min of 4 in. thick, 48 in. wide. Equip panels with structural mechanical attachments welded to the steel reinforcement within the panel for mechanical attachment to steel columns and spandrel beams in accordance with structural engineer's requirements. When anchors are located within the perimeter joint protection (Item 3), maintain a min recess of 1/2 in. from the top of the concrete floor assembly (Item 1) and max spacing of 120 in. on center (oc) between anchors.
 - C. Concrete Panel Joint** – No through joints recommended. When required, seal the surface of the concrete panel joints with gaskets or sealants. Option: Treat the concrete panel joint with any weatherproofing material Listed as a Class 1 material in accordance with ASTM E-84. Use only Intertek certified products meeting these min requirements. Use one of the following for vertical and horizontal concrete panel joints:

- i. **CERTIFIED MANUFACTURER** – 3M Company
CERTIFIED PRODUCT – Fire Barrier™ Sealant
MODEL – CP25WB+

Flush type (butt joint) (Item 2F1), Prefer butted joints but allow a max 1 in. joint width for vertical and horizontal concrete panel joints. When through void or space exists between panels, the void in the spandrel region must be treated by packing a min 4 pcf density, mineral wool into the joint to a min 33% compression (1-1/2 times width of opening), filling the entire void or space. Recess the mineral wool a min of 1/2 in. from each side of the wall. Install a min 1/2 in. thickness of 3M CP25WB+ firestop caulk on the internal surface of the wall assembly (Item 2). Use only Intertek certified products meeting these min requirements.

- ii. key way type (tongue and groove) (Item 2F2), or
- iii. recessed (Item 2F3).

D. Impaling Pins – Use with curtain wall insulation (Item 2F), locate, size and install impaling pins according to the curtain wall system manufacturer's guidelines, or be a min 4-1/2 in. long, 12 GA pin attached to one of the following: a nominal 2 × 2 in. plate; a nominal 2 × 2 × 2 in. long angle; or can be directly attached to the pre-cast concrete panels (Item 2B) using mechanical fasteners. Space impaling pins a max of 12 in. oc. Add additional pins spaced a max of 16 in. oc at the centerline of the packing material (Item 3A). Install impaling pins around the periphery of the curtain wall insulation (Item 2F). A min of two impaling pins required located above the floor line per piece of insulation that has been cut from standard size with at least one in each corner.

E. Clutch Clips (Installed over Impaling Pins) – Min 18 GA, steel clutch clips, max 1-1/4 in. Space clutch clips and impaling pins a max of 16 in. oc at the centerline of the packing material (Item 3A). Install a clutch clip for each impaling pin. Create an air space between the pre-cast concrete panels (Item 2B) and the curtain wall insulation (Item 2F) using the clutch clips.

F. Curtain Wall Insulation – When required, install the concrete panel joint treatment (Item 2C) before curtain wall insulation (Item 2F). Install either nominal 4 in. thick 4 pcf density, 3 in. thick 6 pcf density, or 2 in. thick 8 pcf density, mineral wool batt insulation faced on one side with aluminum foil scrim (vapor retarder) which is exposed to the room interior. Offset the seams between adjacent sections of curtain wall insulation a min 3 in. from the edge of any concrete panel joint (Item 2C). Secure with impaling pins (Item 2D). Seal all meeting edges of insulation with nominal 2 in. wide, pressure sensitive, aluminum foil faced tape. Terminate curtain wall insulation (Item 2F) against non-combustible surfaces above and below the perimeter joint protection (Item 3). Use only Intertek certified products meeting the above min requirements.

3. Perimeter Joint Protection – Do not exceed an 8 in. nominal joint width (joint width at installation). Incorporate the following construction features for the perimeter joint protection (also known as perimeter fire barrier system):

A. Packing Material – Use a min 4 in. thick, 4 pcf density, mineral wool batt insulation installed with the fibers running parallel to the edge of concrete floor assembly (Item 1) and curtain wall assembly (Item 2). Cut packing material width to achieve required compression, refer below, when installed in the nominal joint width. Compress the packing material into the perimeter joint. Tightly compress together splices (butt joints) in the lengths of packing material by using min 1/4 in. compression per piece of packing material. When a spray coating or tape is used, locate the top surface of the packing material flush with the top surface of the concrete floor assembly (Item 1). When the non-sag or self-leveling silicone sealant is used, recess the top surface of the packing material 1/4 in. from the top surface of the concrete floor assembly (Item 1). Use only Intertek certified products meeting the above min requirements.

- i. When 33% compression is required cut the width of the packing material 1.5 times wider than the nominal joint width.

B. CERTIFIED MANUFACTURER – 3M Company
CERTIFIED PRODUCT – FireDam™ or Fire Barrier
MODEL – FD Spray 200 (Elastomeric, Sprayable) Fire Barrier Watertight Spray (Elastomeric, Sprayable) or Fire and Water Barrier Tape FWBT (Tape) or FB 1000 N/S Silicone Sealant (Non-sag) or FB 1003 S/L (Self Leveling)

Fill, Void or Cavity Material – Apply either spray coating or sealant over the packing material (Item 3A) as follows:

Spray Coating – Spray apply the liquid to cover the exposed top surface of the packing material (Item 3A) compressed and installed in the perimeter joint. Apply a min wet film thickness of 1/8 in. and overlap the spray coating a min 1/2 in. onto the adjacent curtain wall assembly (Item 2) and concrete floor assembly (Item 1). When the spraying process is stopped and the applied spray coating cures to an elastomeric film before installation process is restarted, then overlap the edge of the cured spray coating at least 1/8 in. with the liquid spray coating.

Tape – Apply the tape such that there is a min 1 in. overlap onto the adjacent curtain wall assembly (Item 2) and the concrete floor assembly (Item 1). Overlap joints in the tape system by 1/2 in.

Sealant – Apply non-sag or self-leveling sealant to cover the exposed surface of the packing material (Item 3A) compressed and installed in the perimeter joint. Apply min 1/4 in. thickness non-sag or self-leveling sealant over the packing material (Item 3A) and finish flush with the top surface of the concrete floor assembly (Item 1).

Reprinted from the Directory of Building Products with permission from Intertek©

Intertek System No. BPF 120-03

February 17, 2017

PERIMETER FIRE BARRIERS

3M Company

FireDam™ Spray 200, Fire Barrier Watertight Spray, Fire and Water Barrier Tape FWBT,
Fire Barrier 1000 NS Silicone Sealant, and Fire Barrier 1003 SL Silicone Sealant

ASTM E 2307

T-Rating 0 Hour

F-Rating 2 Hour

ASTM E 2307/ASTM E 1399 Cycling

Class I: 500 cycles @ 1 cpm

Rated for ± 16.7% Horizontal Movement @ 50% Compression (Reference Item 3A)

Rated for ± 6.25% Vertical Shear Movement @ 50% Compression (Reference Item 3A)

Rated for ± 5% Horizontal Movement @ 20% Compression (Reference Item 3A)

UL 2079

L-Rating <1.0 SCFM/LF

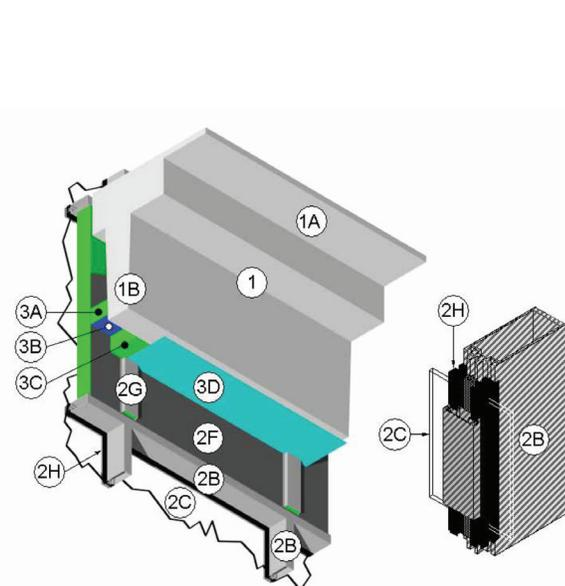

Figure 1 – Lower Left Wall Assembly Isometric and Aluminum Framing Extrusion Assembly (Transoms & Mullions) Isometric

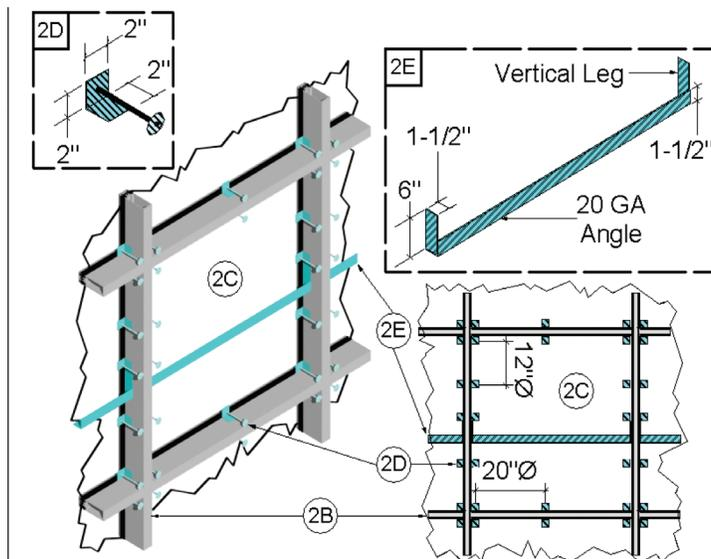

Figure 2 – Aluminum Framing Isometric, Aluminum Framing Elevation, Impaling Pin Isometric, and Reinforcement Angle Isometric

1. **Concrete Floor Assembly** – Refer to Figure 1. Min. 2 hour rated monolithic concrete floor assembly made from either lightweight or normal weight concrete with a density of 100 to 150 pcf density. When a longitudinal recess (blockout) is required to contain an architectural joint system, increase concrete floor assembly thickness to maintain a min. thickness of 4-1/2 in. and accommodate depth of blockout formed in the concrete: blockout width unrestricted.
 - A. **Concrete Floor** – Min. 2 hour rated, nominal 4-1/2 in. thick reinforced, slab increasing to nominal 16 in. thick at joint face (slab edge) created by cast-in-place technique integral with concrete beam (Item 1B).
 - B. **Concrete Beam** – Nominal 31 in. deep, 12 in. wide, 2 hour rated, pre-cast or cast-in-place reinforced concrete spandrel beam integral with concrete floor (Item 1A).
2. **Curtain Wall Assembly** – Refer to Figures 1 and 2. Incorporate the following construction features:
 - A. **Mounting Attachment** (not shown) – Attach aluminum framing (Item 2B) to the structural framing according to the curtain wall manufacturer's instructions. When required, connect the mounting attachments to the joint face of the concrete floor assembly (Item 1) according to the curtain wall manufacturer's instructions. Limit distance between mounting attachments a max. 120 in.
 - B. **Aluminum Framing** – Use hollow rectangular aluminum extruded tubing with min. overall dimensions of 0.100 in. thick, 5-1/2 in. high, and 2-1/2 in. wide. Locate mullions (vertical aluminum framing) nominally 85-1/2 in. on center (oc) and locate transoms (horizontal aluminum framing) a max. 30-1/2 in. oc. For the spandrel region, locate the upper transom (horizontal aluminum framing) a min. 20 in. above the perimeter joint protection (Item 3) as measured from the top surface of the packing material (Item 3A) to the underside of the transom (horizontal aluminum framing).
 - C. **Glass Panels** – Sized and installed into aluminum framing (Item 2B) according to the curtain wall system manufacturer's guidelines. Use min. 1/4 in. thick clear, heat strengthened (HS) glass or tempered glass with a max. width and height less than the aluminum framing (Item 2B) and pressure bar. Secure glass panels with a thermal break (rubber extrusion), pressure (aluminum extrusion), min. 1/4-20 × 5/8 in. long screws, and a snap face (aluminum extrusion).

- D. Impaling Pins** – Use with curtain wall insulation (Item 2E) and framing covers (Item 2F), locate, size, and install impaling pins according to the curtain wall system manufacturer’s guidelines, or be a min. 4-1/2 in. long, 12 GA pin attached to one of the following: a nominal 2 in. × 2 in. plate; a nominal 2 in. × 2 in. × 2 in. long angle; or can be directly attached to the aluminum framing (Item 2B) using a stud gun. Cap all pins using a nominal 1 in. diameter speed washer. Spacing impaling pins a max. of 12 in. oc vertically and 20 in. oc horizontally. Install impaling pins around the periphery of the curtain wall insulation (Item 2F) so that its interior face is flush with the interior face of the aluminum framing (Item 2B).
- E. Reinforcing Angle** – Locate reinforcing angle at all horizontal butt joints of the curtain wall insulation (Item 2F) in the field of the glass spandrel panels (Item 2C) and at the mid-height of the packing material (Item 3A). Mount a min. 1-1/2 × 7/8 in., 20 GA, galvanized steel angle to the vertical aluminum framing mullions (Item 2B), so that the vertical leg serves as a backer to the exterior face of the curtain wall insulation (Item 2F) and the horizontal leg extends away from the curtain wall insulation and is located at the centerline of the packing material (Item 3A). Size the angle 12 in. longer than the span between the interior edges of the vertical aluminum framing, mullions, (Item 2B) and form the angle so that it has a 6 in. vertical leg on each end. Secure the 6 in. vertical leg on each end to the vertical aluminum framing mullions, (Item 2B) on each side with two No. 10 steel self-tapping sheet metal screws placed in a stable fashion with a max. spacing of 2 in. oc, or fastening method of equal strength and stability.
- F. Curtain Wall Insulation** – Use only Intertek certified products meeting the following min. requirements. Use nominal 24 in. wide, 4 in. thick 4 pcf, density, 3 in. thick 6 pcf density, or 2 in. thick 8 pcf density, mineral wool batt insulation faced on one side with aluminum foil scrim (vapor retarder), which is exposed to the room interior and installed in the stud cavity. Install curtain wall insulation between aluminum framing (Item 2B). Secure curtain wall insulation with impaling pins (Item 2D) attached to aluminum framing (Item 2B). Seal all meeting edges of curtain wall insulation with nominal 3 in. wide, pressure sensitive, aluminum foil-faced tape centered over the junction so that approximately 1-1/2 in. of tape covers each edge of the adjacent curtain wall insulation. Apply pressure sensitive aluminum foil-faced tape over all meeting edges of curtain wall insulation and framing covers (Item 2F) so that approximately 2 in. covers each edge of the adjacent material. Install curtain wall insulation flush with the interior face of the aluminum framing (Item 2B). Install 24 in. wide curtain wall insulation spanning the full length and height between aluminum framing (Item 2B). Refer to Figure 3. For vertical insulation butt joints, first install back-to-back angles created from min. 20 GA steel having min. 2 in. legs. Position back-to-back angles in front of reinforcing angle (Item 2E). Mechanically fasten ends of steel back-to-back angles to horizontal framing (Item 2B). Locate horizontal seams in the curtain wall insulation at least 6 in. from the top surface of the perimeter joint protection (Item 3). Maintain 1-1/4 in. air cavity between curtain wall insulation and glass panels (Item 2C). Option: In lieu of filling the full depth of the stud cavity with 4 in. thick, 4 pcf density curtain wall insulation, use min. 2 in. thick 8 pcf density, or 3 in. thick 6 pcf density, curtain wall insulation mechanically secured (do not secure by friction fit) and use additional horizontal support angle (not shown). Locate a horizontal support angle consisting of a min. 20 GA steel angle, having 1-1/2 in. × 1-1/2 in. legs horizontally at the mid-height of the packing material (Item 3A) and attached to each mullion of aluminum framing (Item 2B) using min. No. 6, 1/2 in. long self-tapping sheet metal screws.
- G. Framing Covers** – Make from strips of min. 1 in. thick × min. 4 in. wide, 8 pcf density min., wool batt insulation faced on one side with aluminum foil scrim (vapor retarder), which is exposed to the room interior. Center framing covers over all aluminum framing (Item 2B) and secure using impaling pins or cup-head weld pins (Item 2D). Do not pass framing covers through the perimeter joint protection (Item 3). Allow framing covers to abut top and bottom surfaces of the perimeter joint protection (Item 3) provided that no deformation occurs. Use only Intertek certified products meeting the above min. requirements.
- H. Thermal Break Assembly** – Secure panels with a thermal break (thermal-set rubber extrusion) pressure bar (aluminum extrusion). Protect spandrel panels according to Item 2F.

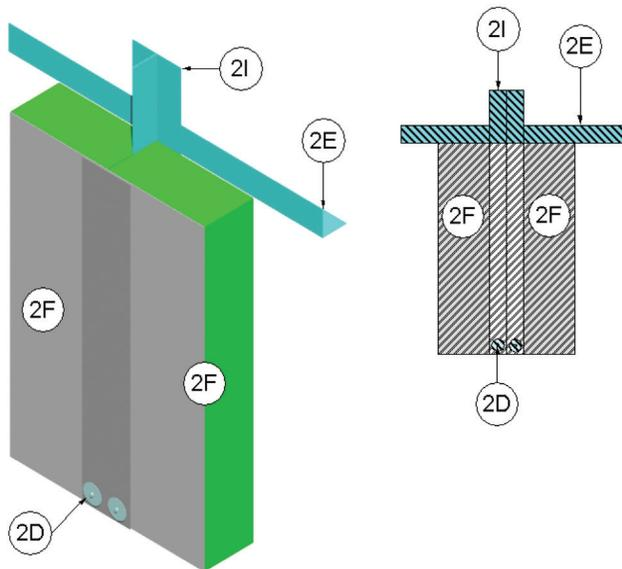

Figure 3 – Curtain Wall Insulation Vertical Butt Joint Isometric and Elevation

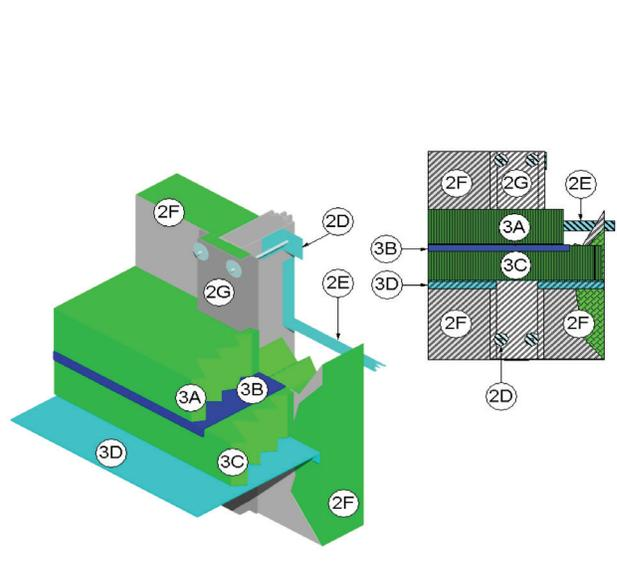

Figure 4 – Perimeter Joint Protection Isometric and Elevation

- 3. Perimeter Joint Protection** – Refer to Figures 1 and 4. Install impaling pins (Item 2D), reinforcement angle (Item 2E), and protect spandrel panels using curtain wall insulation (Item 2F) before installing perimeter joint protection. Do not install framing covers (Item 2G) until after perimeter joint protection. Do not exceed a 12 in. nominal joint width (joint width at installation). Install perimeter joint protection from bottom of concrete floor assembly (Item 1). Sandwich the fill, void, or cavity material (Item 3B) between two pieces of packing material (Items 3A and 3C). Incorporate the following construction features for the perimeter joint protection (also known as perimeter fire barrier system):
- A. Packing Material** – Use of min. 4 in. thick, 4 pcf density, mineral wool batt insulation installed with the fibers running parallel to the edge of concrete floor assembly (Item 1) and curtain wall assembly (Item 2). Cut packing material width to achieve required compression, refer below, when installed in the nominal joint width. Compress the packing material into the perimeter joint created between the curtain wall insulation (Item 2F) and the concrete spandrel beam (Item 1B). Create a recess at least 4 in. deep between the bottom of the packing material and the bottom surface of the concrete spandrel beam (Item 1B) to allow installation of the fill, void, or cavity material (Item 3B) and the second piece of packing material (Item 3C). Tightly compress together splices (butt joints) in the lengths of packing material by using min. 1/4 in. compression per piece of packing material. When a spray coating or tape is used, locate the top surface of the packing material flush with the top surface of the concrete floor assembly (Item 1). When the non-sag or self-leveling silicone sealant is used, recess the top surface of the packing material 1/4 in. from the top surface of the concrete floor assembly (Item 1). Use only Intertek certified products meeting the above min. requirements.
- i. When horizontal movement of $\pm 16.7\%$ and vertical shear of $\pm 6.25\%$ is required, install packing material at 50% compression. Cut the width of the packing material 2 times wider than the nominal joint width.
 - ii. When horizontal movement of $\pm 5\%$ is required, install packing material at 20% compression. Cut the width of the packing material 1-1/4 times wider than the nominal joint width.
- B. CERTIFIED MANUFACTURER** – 3M Company
CERTIFIED PRODUCT – FireDam™ or Fire Barrier™
MODEL – FD Spray 200 (Elastomeric, Sprayable), Fire Barrier Watertight Spray (Elastomeric, Sprayable), or Fire and Water Barrier Tape FWBT (Tape) or FB 1000 N/S Silicone Sealant (Non-sag) or FB 1003 S/L (Self-leveling)
- Fill, Void or Cavity Material** – Apply either spray coating or sealant over the packing material (Item 3A) as follows:
- Spray Coating** – Spray apply the liquid to cover the exposed top surface of the packing material (Item 3A) compressed and installed in the perimeter joint. Apply a min. wet film thickness of 1/8 in. and overlap the spray coating a min. 1/2 in. onto the adjacent curtain wall assembly (Item 2) and concrete floor assembly (Item 1). When the spraying process is stopped and the applied spray coating cures to an elastomeric film before installation process is restarted, then overlap the edge of the cured spray coating at least 1/8 in. with the liquid spray coating.
- Tape** – Apply the tape such that there is a min. 1 in. overlap onto the adjacent curtain wall assembly (Item 2) and the concrete floor assembly (Item 1). Overlap joints in the tape system by 1/2 in.
- Sealant** – Apply non-sag or self-leveling sealant to cover the exposed surface of the packing material (Item 3A) compressed and installed in the perimeter joint. Apply min. 1/4 in. thickness non-sag or self-leveling sealant over the packing material (Item 3A) and finish flush with the top surface of the concrete floor assembly (Item 1).
- C. Secondary Packing Material** – Install after the fill, void, or cavity material (Item 3B) is cured. Use a min. 4 in. thick, 4 pcf density, mineral wool batt insulation installed with the fibers running parallel to the edge of concrete floor assembly (Item 1) and curtain wall assembly (Item 2). Cut packing material width to achieve same compression as packing material (Item 3A). Compress the packing material into the perimeter joint created between the curtain wall insulation (Item 2F) and the concrete spandrel beam (Item 1B). Stagger butt joint of secondary packing material and packing material (Item 3A). Tightly compress together splices (butt joints) in the lengths of packing material by using min. 1/4 in. compression per piece of packing material. Verify finished installation flush with bottom of concrete spandrel beam (Item 1B). Use only Intertek certified products meeting the above min. requirements.
- D. Cover Plate** – Install a min. 18 GA, L-shaped, steel plate having a nominal 3 in. vertical leg and a horizontal leg sized to span the nominal joint width between the curtain wall insulation (Item 2F) and the concrete spandrel beam (Item 1B). Position the steel plate flush against bottom of concrete spandrel beam (Item 1B) and against the interior exposed vertical aluminum framing mullions (Item 2B). Attach the vertical leg of the L-shaped steel plate to each vertical aluminum framing mullion (Item 2B), using min. No. 10, self-tapping sheet metal screws nominally 2 in. below the horizontal leg. Space fasteners a max. of 48 in. oc and attach the horizontal leg of the L-shaped steel plate to the bottom of concrete spandrel beam (Item 1B) using Hilti XC-20 THP fasteners or equivalent pre-mounted, plastic top-head, concrete nails made of zinc-coated (5 to 13 μm thick), hardened steel, having a nominal 3/4 in. shank length, 0.138 in. diameter, cut-point and dome-head configuration.

Reprinted from the Directory of Building Products with permission from Intertek©

Intertek System No. BPF 180-01

February 17, 2017

(Formerly OPL Design No. CEJ 162 P)

PERIMETER FIRE BARRIERS

3M Company

FireDam™ Spray 200, Fire Barrier Watertight Spray, Fire and Water Barrier Tape FWBT,
Fire Barrier 1000 NS Silicone Sealant, and Fire Barrier 1003 SL Silicone Sealant

ASTM E 2307

T-Rating Refer to Compression Percentage

F-Rating 3 Hour

ASTM E 2307/ASTM E 1399 Cycling

Class IV: 500 cycles @ 30 cpm

‡Rated for ± 16.7% Horizontal Movement @ 50% Compression (Reference Item 3A): T-Rating 2-1/2 Hour

‡Rated for ± 11% Horizontal Movement @ 33% Compression (Reference Item 3A): T-Rating 1-1/2 Hour

Rated for ± 6.25% Vertical Shear Movement @ 50% Compression (Reference Item 3A)

UL 2079

L-Rating <1.0 SCFM/LF

‡: Fire Barrier Watertight Spray cycling rating limited to ±10% horizontal movement

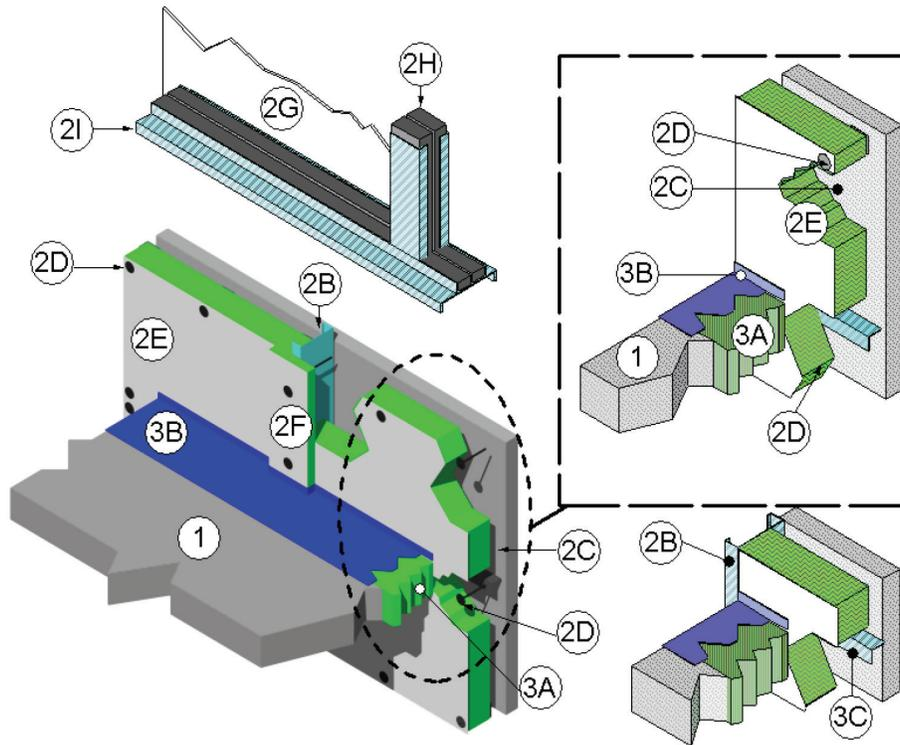

- Concrete Floor Assembly** – 3 hour rated concrete floor assembly made from either lightweight or normal weight concrete with a density of 100 to 150 pcf, having a min. thickness of 4-1/2 in. at the joint face. When a longitudinal recess (blockout) is required to contain an architectural joint system, increase concrete floor assembly thickness to maintain a min. thickness of 4-1/2 in. and accommodate depth of blockout formed in the concrete: blockout width unrestricted.
- Curtain Wall Assembly** – Incorporate the following construction features:
 - Panel Mounting Attachment** (not shown) – Attach steel framing (Item 2B) to the structural framing according to the curtain wall manufacturer's instructions. When required, connect the mounting attachments to the joint face of the concrete floor assembly (Item 1) according to the curtain wall manufacturer's instructions. Limit distance between mounting attachments to max. 120 in.
 - Steel Stud Framing** – Use min. 3-5/8 in. x 1-5/8 in., 18 GA, C-shaped steel studs as vertical framing. Attach according to the curtain wall system manufacturer's guidelines. Limit distance between vertical steel stud framing to max. 60 in. Limit distance between horizontal steel stud framing to min. 48 in. When required, install horizontal structural framing members according to the curtain wall system manufacturer's guidelines and, in the spandrel area, locate a min. of 20 in. above the top surface of the concrete floor assembly (Item 1).
 - Concrete Panels** – Use any non-combustible exterior concrete based panels. Use min. 1-1/2 in. thick, 12 in. high, 12 in. long panels. Attach concrete panels to steel stud framing (Item 2B) according to the curtain wall system manufacturer's requirements.
 - Impaling Pins** – Use with curtain wall insulation (Item 2E) and framing covers (Item 2F), locate, size, and install impaling pins according to the curtain wall system manufacturer's guidelines, or be a min. 4-1/2 in. long, 12 GA pin attached to one of the following: a nominal 2 in. x 2 in. plate; a nominal 2 in. x 2 in. x 2 in. long angle; or can be directly attached to the steel framing (Item 2B) using a stud gun. Space impaling pins a max. of 12 in. on center (oc) vertically and 20 in. oc horizontally. Install impaling pins around the periphery of the curtain wall insulation (Item 2E) so that its interior face is flush with the interior face of the steel framing (Item 2B).

- E. Curtain Wall Insulation** – Use nominal 24 in. wide, 4 in. thick 4 pcf density, 3 in. thick 6 pcf density, or 2 in. thick 8 pcf density, mineral wool batt insulation faced on one side with aluminum foil scrim (vapor retarder), which is exposed to the room interior and installed in the stud cavity. Install curtain wall insulation between steel framing (Item 2B). Secure curtain wall insulation with clips, impaling pins, or friction fit using curtain wall insulation length at least 1/4 in. longer than the distance between steel framing (Item 2B). Seal all meeting edges of curtain wall insulation with nominal 4 in. wide pressure sensitive aluminum foil-faced tape (not shown) centered over the junction so that approximately 2 in. of tape covers each edge of the adjacent curtain wall insulation. Apply pressure sensitive aluminum foil-faced tape over all meeting edges of curtain wall insulation and framing covers (Item 2F) so that approximately 2 in. covers each edge of the adjacent material. Install curtain wall insulation flush with the interior face of the steel framing (Item 2B). Install 24 in. wide curtain wall insulation without vertical seams, spanning the full length between steel framing (Item 2B). Locate horizontal seams in the curtain wall insulation at least 6 in. from the top surface of the perimeter joint protection (Item 3). Maintain 1-1/4 in. air cavity between curtain wall insulation and glass panels (Item 2C). Option: In lieu of filling the full depth of the stud cavity with 4 in. thick, 4 pcf density curtain wall insulation, use min. 2 in. thick, 8 pcf density curtain wall insulation mechanically secured (do not secure by friction fit) and use additional horizontal support angle (not shown). Use only Intertek certified products meeting the above min.requirements.
- F. Framing Covers** – Make from strips of min. 1 in. thick × min. 4 in. wide, 8 pcf density, mineral wool batt insulation faced on one side with aluminum foil scrim (vapor retarder), which is exposed to the room interior. Center framing covers over all steel framing (Item 2B) and secure using impaling pins (Item 2D). Do not pass framing covers through the perimeter joint protection (Item 3). Allow framing covers to abut top and bottom surfaces of the perimeter joint protection (Item 3) provided that no deformation occurs. Use only Intertek certified products meeting the above min.requirements.
- G. Reinforcing Angle** – Mount a min. 1-1/2 in. × 1-1/2 in., 20 GA, galvanized steel angle to the steel stud framing (Item 2B) so that the vertical leg serves as a backer to the exterior face of the curtain wall insulation (Item 2E), and the horizontal leg extends away from the curtain wall insulation, and is located at the centerline of the packing material (Item 3A). Size the angle 12 in. longer than the span between the interior edges of the steel stud framing (Item 2B) and form the angle so that it has a 6 in. vertical leg on each end. Secure the 6 in. vertical leg on each end to the steel stud framing (Item 2B) on each side with three No. 10 steel self-tapping sheet metal screws placed in a triangular fashion with a max. spacing of 2 in. oc.
- 3. Perimeter Joint Protection** – Do not exceed an 8 in. nominal joint width (joint width at installation). Incorporate the following construction features for the perimeter joint protection (also known as perimeter fire barrier system):
- A. Packing Material** – Use a min. 4 in. thick, 4 pcf density, mineral wool batt insulation installed with the fibers running parallel to the edge of concrete floor assembly (Item 1) and curtain wall assembly (Item 2). Cut packing material width to achieve required compression, refer below, when installed in the nominal joint width. Compress the packing material into the perimeter joint. Tightly compress together splices (butt joints) in the lengths of packing material by using min. 1/4 in. compression per piece of packing material. When a spray coating or tape is used, locate the top surface of the packing material flush with the top surface of the concrete floor assembly (Item 1). When the non-sag or self-leveling silicone sealant is used, recess the top surface of the packing material 1/4 in. from the top surface of the concrete floor assembly (Item 1). Use only Intertek certified products meeting the above min.requirements.
- I. When 50% compression is required cut the width of the packing material 2 times wider than the nominal joint width.
 - II. When 33% compression is required cut the width of the packing material 1-1/2 times wider than the nominal joint width.
- B. CERTIFIED MANUFACTURER** – 3M Company
CERTIFIED PRODUCT – FireDam™ or Fire Barrier™
MODEL – FD Spray 200 (Elastomeric, Sprayable), Fire Barrier Watertight Spray (Elastomeric, Sprayable), or Fire and Water Barrier Tape FWBT (Tape) or FB 1000 N/S Silicone Sealant (Non-sag) or FB 1003 S/L (Self-leveling)
Fill, Void or Cavity Material – Apply either spray coating or sealant over the packing material (Item 3A) as follows:
- Spray Coating** – Spray apply the liquid to cover the exposed top surface of the packing material (Item 3A) compressed and installed in the perimeter joint. Apply a min. wet film thickness of 1/8 in. and overlap the spray coating a min. 1/2 in. onto the adjacent curtain wall assembly (Item 2) and concrete floor assembly (Item 1). When the spraying process is stopped and the applied spray coating cures to an elastomeric film before installation process is restarted, then overlap the edge of the cured spray coating at least 1/8 in. with the liquid spray coating.
- Tape** – Apply the tape such that there is a min. 1 in. overlap onto the adjacent curtain wall assembly (Item 2) and the concrete floor assembly (Item 1). Overlap joints in the tape system by 1/2 in.
- Sealant** – Apply non-sag or self-leveling sealant to cover the exposed surface of the packing material (Item 3A) compressed and installed in the perimeter joint. Apply min. 1/4 in. thickness non-sag or self-leveling sealant over the packing material (Item 3A) and finish flush with the top surface of the concrete floor assembly (Item 1).
- C. Support Clips** (optional) – Recommended for installations subject to vertical shear movement. Use standard 20 GA galvanized steel Z-shaped clips having the following nominal dimensions: 1 in. wide × 3 in. high with a 2 in. upper leg and a 3 in. lower leg.

Reprinted from the Directory of Building Products with permission from Intertek©

Intertek System No. BPF 180-02

February 17, 2017

PERIMETER FIRE BARRIERS

3M Company

FireDam™ Spray 200, Fire Barrier Watertight Spray, Fire and Water Barrier Tape FWBT,
Fire Barrier 1000 NS Silicone Sealant and Fire Barrier 1003 SL Silicone Sealant

ASTM E 2307

T-Rating Refer to Compression Percentage

F-Rating 3 Hour

ASTM E 2307/ASTM E 1399 Cycling

Class IV: 500 cycles @ 30 cpm

‡Rated for ± 16.7% Horizontal Movement @ 50% Compression (Reference Item 3A): T-Rating 2-1/2 Hour

‡Rated for ± 11% Horizontal Movement @ 33% Compression (Reference Item 3A): T-Rating 1-1/2 Hour

Rated for ± 6.25% Vertical Shear Movement @ 50% Compression (Reference Item 3A)

UL 2079

L-Rating <1.0 SCFM/LF

‡: Fire Barrier Watertight Spray cycling rating limited to ±10% horizontal movement

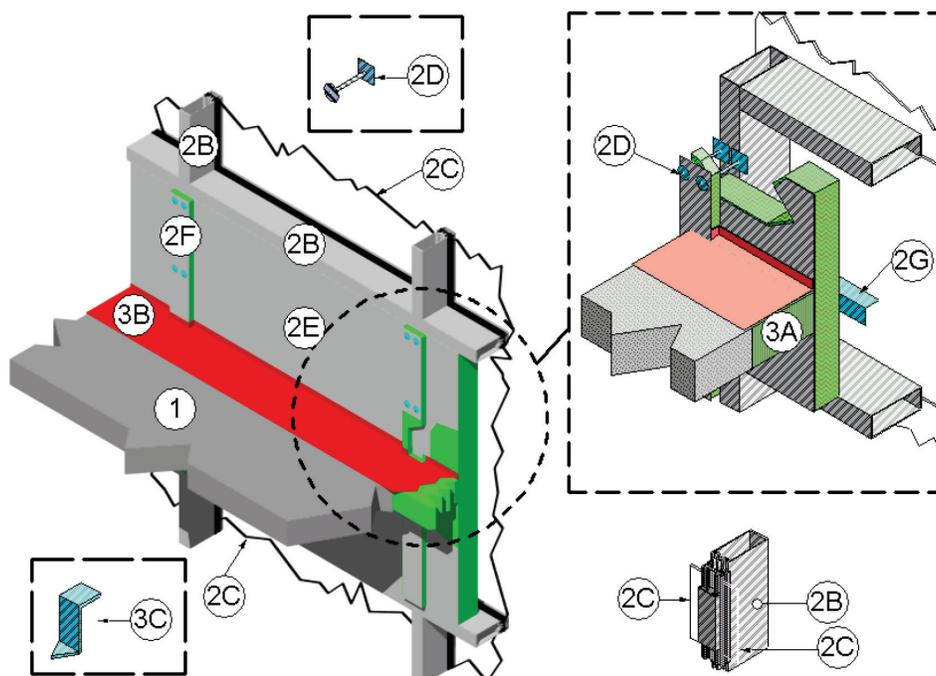

- 1. Concrete Floor Assembly** – Max 3 hour rated concrete floor assembly made from either lightweight or normal weight concrete with a density of 100-150 pcf, with a min thickness of 4-1/2 in. at the joint face. Overall slab thickness may vary to accommodate various blackout depths (longitudinal recesses) formed in the concrete, to house the architectural cover plate. The blackout width may also vary without restriction.
- 2. Curtain Wall Assembly:** The curtain wall assembly shall incorporate the following construction features:
 - A. Mounting Attachment** (not shown) – Attachment of the curtain wall framing to the structural framing shall be according to the curtain wall manufacturer's instructions. When required, the mounting attachments to the floor slab shall be connected to the joint face of the floor slab, according to the curtain wall manufacturer's instructions. Max distance between mounting attachments shall be 10 ft.
 - B. Aluminum Framing** – Rectangular aluminum tubing mullions and transoms, sized according to the curtain wall system manufacturer's guidelines. Min overall dimensions of framing required is 0.100 in. thick aluminum with a min 5-1/2 in. height and a min of 2-1/2 in. width of the extrusion. Mullion and transom covers are added to the external side of the framing, giving the framing system a total depth of nominal .8 in. Mullions are to be spaced a min 60 in. oc and transoms are to be spaced a min 48 in. oc. Transoms are to be located at a height of 20 in. above the top surface of the concrete floor assembly (as measured from the bottom of the transom).
 - C. Glass Panels** – Glass panels shall be sized and installed to curtain wall framing according to the curtain wall system manufacturer's guidelines. Use a min 1/4 in. thick clear, heat-strengthened (HS) glass or tempered glass with a max width and height less than the aluminum framing oc spacing, which allows the glass to be secured between the notched shoulder of the aluminum framing and pressure bar. Panels are secured with a thermal break (rubber extrusion), pressure bar (aluminum extrusion), min 1/4–20 × 5/8 in. long screws, and a snap face (aluminum extrusion).
 - D. Impaling Pins** – Min 12 GA steel pins shall be located, sized, and installed according to the curtain wall system manufacturer's guidelines, or be a min 1/2 in. longer than the thickness of the curtain wall insulation. Attach pins to a nominal 2 × 2 in. clip angle constructed with 20 GA galvanized sheet steel and secure the clips to the aluminum framing with No. 10 self-tapping sheet metal screws. Pins shall be spaced a max of 12 in. oc on the vertical framing members and a max of 20 in. oc on the horizontal framing members that make up the perimeter of the spandrel area. The interior face of the curtain wall insulation is to be installed so that it is flush with the interior face of the framing.

- E. Curtain Wall Insulation** – Install nominal 2 in. thick 8 pcf density mineral wool batt insulation faced on one side with aluminum foil scrim (vapor retarder) which is exposed to the room interior. Secure with angle clips and impaling pins (2D). All meeting edges of insulation are sealed with nominal 4 in. wide pressure sensitive aluminum foil-faced tape, centered over the junction so that approximately 2 in. of tape covers each edge of the adjacent insulation. In lieu of the nominal 2 in. 8 pcf mineral wool curtain wall insulation, nominal 3 in. 6 pcf or nominal 4 in. 4 pcf mineral wool may be installed using the same securing method described in Item 2D. The interior face of the batt insulation is, if required compressed, flush with the interior face of the curtain wall framing. When using nominal 2 in. thick 8 pcf density mineral wool batt insulation, a min 1-1/4 in. air space is created between the insulation and panel. The batt insulation shall be installed without vertical seams, with a continuous span across the full length between the vertical curtain wall framing members. Horizontal seams in the nominal 24 in. wide batt insulation are to be at least 6 in. from the top surface of the perimeter joint treatment.
- F. Framing Covers** – Framing covers, comprised of nominal 4 in. wide strips of 8 pcf density mineral wool batt insulation faced on one side with aluminum foil scrim (vapor retarder) which is exposed to the room interior, are centered over each vertical framing member and secured to the member with impaling pins and clips spaced a max 12 in. oc and attached in accordance with Item 2D. Framing covers below the perimeter joint treatment are nominal 2 in. thick, and those above the perimeter joint treatment are nominal 1 in. thick. Framing covers do not pass through the perimeter joint treatment. They are butted to the top and bottom surfaces of the perimeter joint treatment.
- G. Reinforcing Angle** – Mount a min 1-1/2 × 1-1/2 in. × 20 GA galvanized steel angle to the vertical framing members so that the vertical leg serves as a backer to the exterior face of the curtain wall insulation and the horizontal leg extends away from the curtain wall insulation, and the elevation is located at the centerline of the perimeter joint treatment. Size the angle 12 in. longer than the span between the interior edges of the vertical framing members and form the angle so that it has a 6 in. vertical leg on each end. Secure the 6 in. leg to the framing member on each side with three No. 10 steel self-tapping sheet metal screws placed in a triangular fashion with a max spacing of 2 in. oc.
- 3. Perimeter Joint Protection** – The perimeter joint (linear opening) shall not exceed an 8 in. nominal joint width (joint width at installation) and the perimeter joint treatment shall incorporate the following construction features:
- A. Packing Material** – Use a min 4 in. thick, 4 pcf density, mineral wool batt insulation installed with the fibers running parallel to the slab edge and curtain wall. The packing material shall be compressed 50% for 16.7% horizontal movement and 6.25% vertical shear, or 20% for 5% horizontal movement in the nominal joint width. Compress the batt insulation into the perimeter joint such that the top surface of the batt insulation is flush with the top surface of the concrete floor slab and its mid-depth is compressed against the interior surface of the curtain wall insulation (2F) which is supported by the 20 GA steel reinforcing angle (2E). Splices (butt joints) in the lengths of mineral wool batt insulation are to be tightly compressed together. When using the Fire Barrier™ 1000 or 1003 Sealants, recess the mineral wool packing material a min 1/4 in. from the top surface of the floor slab to accommodate the required installation depth of the sealant.
- B. CERTIFIED MANUFACTURER** – 3M Company
CERTIFIED PRODUCT – FireDam™ or Fire Barrier
MODEL – FD Spray 200 (Elastomeric, Sprayable) Fire Barrier Watertight Spray (Elastomeric, Sprayable) or Fire and Water Barrier Tape FWBT (Tape) or FB 1000 N/S Silicone Sealant (Non-sag) or FB 1003 S/L (Self Leveling)
Fill, Void or Cavity Material – Apply either spray coating or sealant over the packing material (Item 3A) as follows:
Spray Coating – Spray apply the liquid to cover the exposed top surface of the packing material (Item 3A) compressed and installed in the perimeter joint. Apply a min wet film thickness of 1/8 in. and overlap the spray coating a min 1/2 in. onto the adjacent curtain wall assembly (Item 2) and concrete floor assembly (Item 1). When the spraying process is stopped and the applied spray coating cures to an elastomeric film before installation process is restarted, then overlap the edge of the cured spray coating at least 1/8 in. with the liquid spray coating.
Tape – Apply the tape such that there is a min 1 in. overlap onto the adjacent curtain wall assembly (Item 2) and the concrete floor assembly (Item 1). Overlap joints in the tape system by 1/2 in.
Sealant – Apply non-sag or self-leveling sealant to cover the exposed surface of the packing material (Item 3A) compressed and installed in the perimeter joint. Apply min 1/4 in. thickness non-sag or self-leveling sealant over the packing material (Item 3A) and finish flush with the top surface of the concrete floor assembly (Item 1).
- C. Support Clips** (optional) – Recommended for installations subject to vertical shear movement. Use standard 20 GA galvanized steel Z-shaped clips having the following nominal dimensions: 1 in. wide by 3 in. high with a 2 in. upper leg and a 3 in. lower leg.

Reprinted from the Directory of Building Products with permission from Intertek©

Design Number 3MU/JS 120-05

(Formerly OPL Design No. CEJ 119 P)

September 15, 2011

PERIMETER FIRE BARRIERS

3M Company

FireDam™ Spray 200, Fire Barrier 1000 NS Silicone Sealant and

Fire Barrier 1003 SL Silicone Sealant

ASTM E 2307

T-Rating Refer to Compression Percentage

F-Rating 2 hr

ASTM E 2307/ASTM E 1399 Cycling

Class IV: 500 cycles @ 30 cpm

Rated for ± 16.7% horizontal movement @ 50% Compression (Reference Item 3A): T-Rating 1/4 hr

Rated for ± 11% horizontal movement @ 33% Compression (Reference Item 3A): T-Rating 0 hr

Rated for ± 5% horizontal movement @ 20% Compression (Reference Item 3A): T-Rating 0 hr

Rated for ± 6.25% vertical shear movement @ 50% Compression (Reference Item 3A)

UL 2079

L-Rating <1.0 SCFM/LF

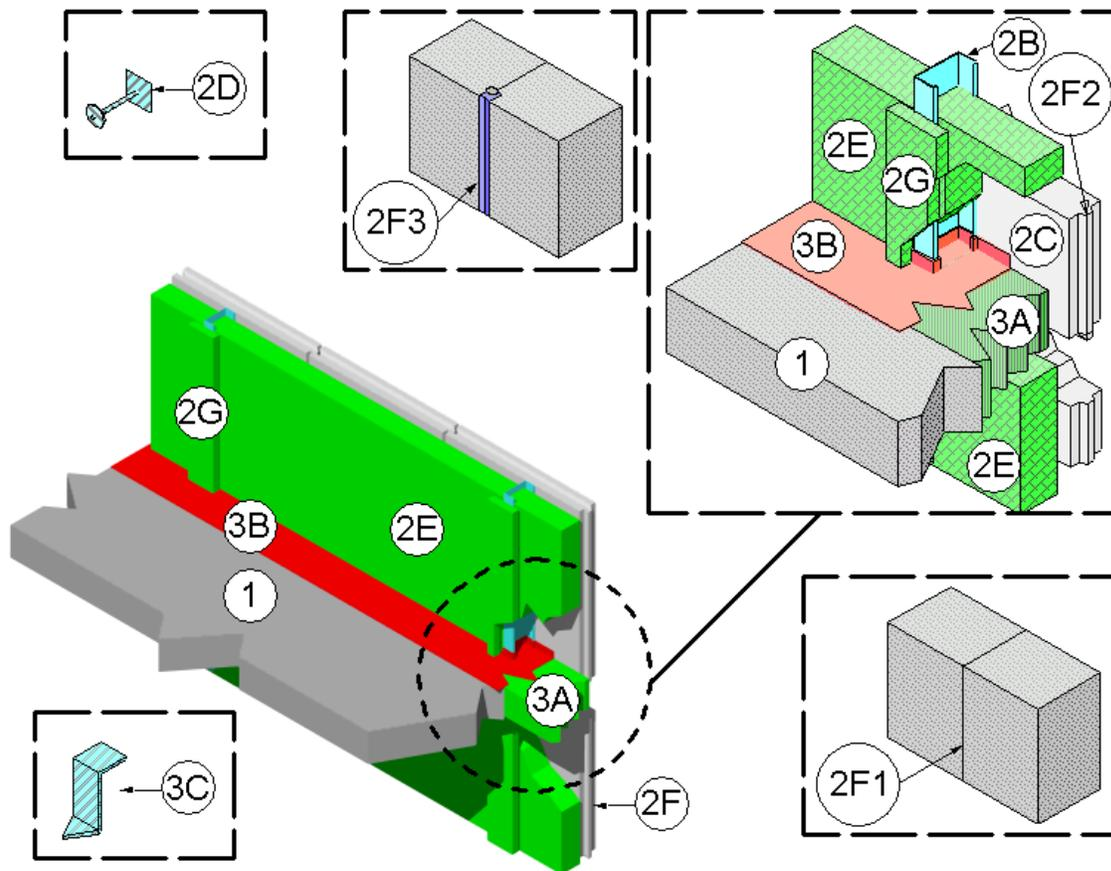

1. **CONCRETE FLOOR ASSEMBLY:** Two-hour rated concrete floor assembly made from either lightweight or normal weight concrete with a density of 100 to 150 pcf, having a minimum thickness of 4-1/2" at the joint face. When a longitudinal recess (blockout) is required to contain an architectural joint system, increase concrete floor assembly thickness to maintain a minimum thickness of 4-1/2" and accommodate depth of blockout formed in the concrete: blockout width unrestricted.
2. **CURTAIN WALL ASSEMBLY:** Incorporate the following construction features:
 - A. **Mounting Attachment:** (Not shown) Attach steel stud framing (Item 2B) to the structural framing according to the curtain wall manufacturer's instructions. When required, connect the mounting attachments to the joint face of the concrete floor assembly (Item 1) according to the curtain wall manufacturer's instructions. Limit distance between mounting attachments to maximum 120".
 - B. **Steel Stud Framing:** Use minimum 3-5/8" by 1-5/8", 18 GA, C-shaped steel studs as interior vertical framing. Attach according to the curtain wall system manufacturer's guidelines. Limit distance between steel stud framing to maximum 60". When required, install horizontal steel stud framing members according to the curtain wall system manufacturer's guidelines and, in the spandrel area, locate a minimum of 33" above the top surface of the concrete floor assembly (Item 1).
 - C. **Concrete Panels:** Use any non-combustible exterior concrete based panels. Use minimum 1-1/2" thick, 12" high, 12" long panels. Attach concrete panels to steel stud framing (Item 2B) according to the curtain wall system manufacturer's requirements.
 - D. **Impaling Pins:** (Optional) Use, locate, size, and install impaling pins according to the curtain wall system manufacturer's guidelines.
 - E. **Curtain Wall Insulation:** (Optional) When used, install either mineral wool or fiberglass batt curtain wall insulation after the perimeter joint protection (Item 3) without deforming it. Attach curtain wall insulation to steel stud framing (Item 2B) by friction fit or mechanical fasteners.

Design No. 3MU/JS 120-05 *continued*

Construction Joints

Perimeter Joint

- F. Concrete Panel Joint: No through joints allowed. When required, the surface of the concrete panel joints can be sealed with gaskets or sealants. Use one of the following for vertical and horizontal concrete panel joints:
- I. flush type (butt joint) (Item 2F1),
 - II. key way type (tongue and groove) (Item 2F2), or
 - III. recessed (Item 2F3).
- G. Framing Covers: (Optional) When used, locate, size, and install framing covers according to the curtain wall system manufacturer's guidelines. Do not pass framing covers through the perimeter joint protection (Item 3). Allow framing covers to abut top and bottom surfaces of the perimeter joint protection (Item 3) provided that no deformation occurs.
- H. Glass Vision Panels: (Optional) When used, locate glass vision panels above spandrel area and a minimum 33" above the top surface of the concrete floor assembly (Item 1). Install glass vision panels to window framing (Item 2I) according to manufacturer's guidelines. Use a minimum 1/4" thick, clear tempered glass with maximum width and height width and height as determined by the window framing (Item 2I).
- I. Window Gaskets: When glass vision panels (Item 2G) used, use a thermal break (thermo-set rubber extrusion) to secure glass vision panels (Item 2G).
- J. Window Framing: When glass vision panels used, use steel framing members a minimum 3-5/8" by 1-5/8", 18 GA steel, U-shaped channel or similar construction compatible with structural framing (Item 2B). Locate window framing at least 33" above the top surface of the concrete floor assembly (Item 1).
3. PERIMETER JOINT PROTECTION: Do not exceed an 8" nominal joint width (joint width at installation). Incorporate the following construction features for the perimeter joint protection (also known as perimeter fire barrier system):
- A. Packing Material: Use a minimum 4" thick, 4-pcf density, mineral wool batt insulation installed with the fibers running parallel to the edge of concrete floor assembly (Item 1) and curtain wall assembly (Item 2). Cut packing material width to achieve required compression, refer below, when installed in the nominal joint width. Compress the packing material into the perimeter joint. Tightly compress together splices (butt joints) in the lengths of packing material by using minimum 1/4" compression per piece of packing material. Use only Intertek certified products meeting the above minimum requirements. When a spray coating is used, locate the top surface of the packing material flush with the top surface of the concrete floor assembly (Item 1). When the non-sag or self leveling silicone sealant is used, recess the top surface of the packing material 1/4" from the top surface of the concrete floor assembly (Item 1). Use only Intertek certified products meeting the above minimum requirements.
- I. When 50% compression is required cut the width of the packing material 2 times wider than the nominal joint width.
 - II. When 33% compression is required cut the width of the packing material 1.5 times wider than the nominal joint width.
 - III. When 20% compression is required cut the width of the packing material 1.25 times wider than the nominal joint width.
- B. CERTIFIED MANUFACTURER: 3M Company
CERTIFIED PRODUCT: FireDam™ or Fire Barrier™
MODEL: FD Spray 200 (Elastomeric, Sprayable) or FB 1000 N/S Silicone Sealant (Non-sag) or FB 1003 S/L (Self Leveling) Sealant
Fill, Void or Cavity Material: Apply either spray coating or non-sag or self leveling silicone sealant over the packing material (Item 3A) as follows:
- Spray Coating – Spray apply the liquid to cover the exposed top surface of the packing material (Item 3A) compressed and installed in the perimeter joint. Apply a minimum wet film thickness of 1/8" and overlap the spray coating a minimum 1/2" onto the adjacent curtain wall assembly (Item 2) and concrete floor assembly (Item 1). When the spraying process is stopped and the applied spray coating cures to an elastomeric film before installation process is restarted, then overlap the edge of the cured spray coating at least 1/8" with the liquid spray coating.
- Sealant – Apply non-sag or self leveling sealant to cover the exposed surface of the packing material (Item 3A) compressed and installed in the perimeter joint. Apply minimum 1/4" thickness non-sag or self leveling sealant over the packing material (Item 3A) and finish flush with the top surface of the concrete floor assembly (Item 1).
- C. Support Clips: (Optional) Recommended for installations subject to vertical shear movement. Use standard 20 GA galvanized steel Z-shaped clips having the following nominal dimensions: 1" wide by 3" high with a 2" upper leg and a 3" lower leg.

This material was extracted and drawn by 3M Fire Protection Products from the 2012 Product Directory, © Intertek

JS

Design Number 3MU/JS 120-06

(Formerly OPL Design No. CEJ 120 P)

September 15, 2011

PERIMETER FIRE BARRIERS

3M Company

FireDam™ Spray 200, Fire Barrier 1000 NS Silicone Sealant and

Fire Barrier 1003 SL Silicone Sealant

ASTM E 2307

T-Rating Refer to Compression Percentage

F-Rating 2 hr

ASTM E 2307/ASTM E 1399 Cycling

Class IV: 500 cycles @ 30 cpm

Rated for ± 16.7% horizontal movement @ 50% Compression (Reference Item 3A): T-Rating 1/4 hr

Rated for ± 11% horizontal movement @ 33% Compression (Reference Item 3A): T-Rating 0 hr

Rated for ± 5% horizontal movement @ 20% Compression (Reference Item 3A): T-Rating 0 hr

Rated for ± 6.25% vertical shear movement @ 50% Compression (Reference Item 3A)

UL 2079

L-Rating <1.0 SCFM/LF

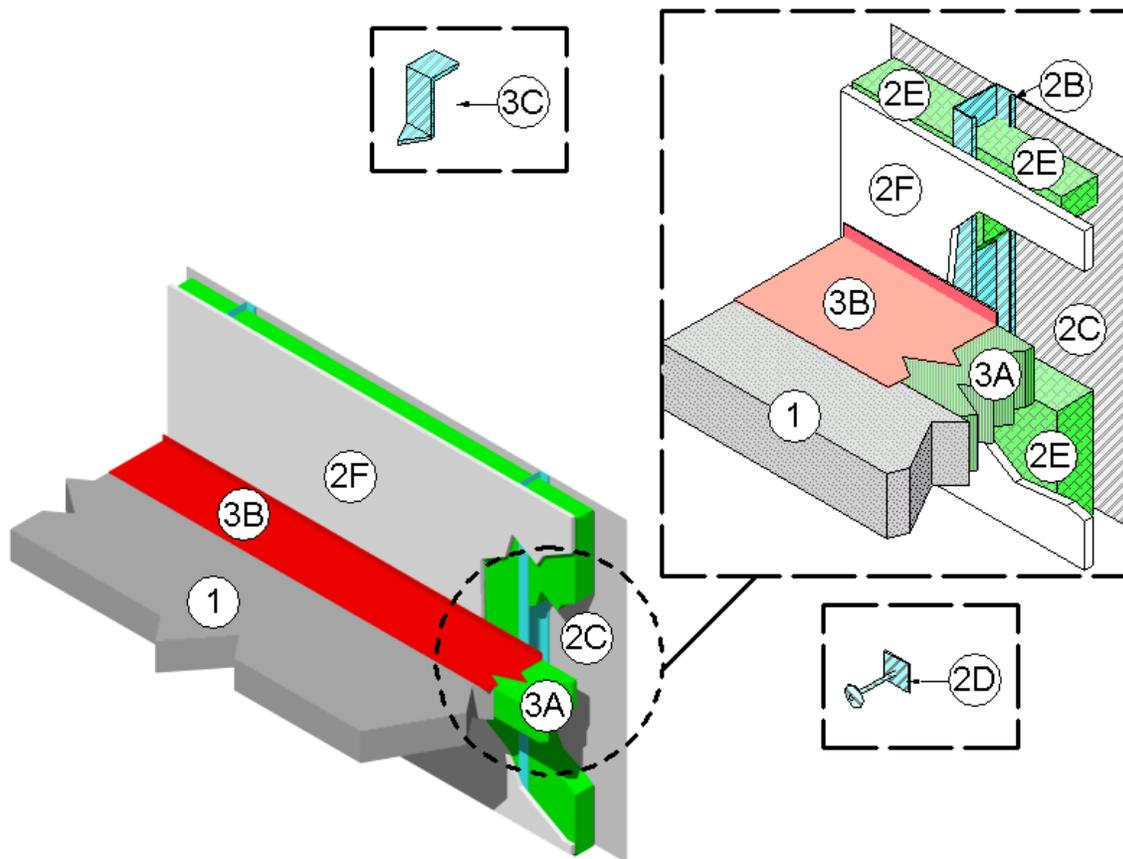

1. CONCRETE FLOOR ASSEMBLY: Two-hour rated concrete floor assembly made from either lightweight or normal weight concrete with a density of 100 to 150 pcf, having a minimum thickness of 4-1/2" at the joint face. When a longitudinal recess (blockout) is required to contain an architectural joint system, increase concrete floor assembly thickness to maintain a minimum thickness of 4-1/2" and accommodate depth of blockout formed in the concrete: blockout width unrestricted.
2. CURTAIN WALL ASSEMBLY: Incorporate the following construction features:
 - A. Mounting Attachment: (Not shown) Attach steel stud framing (Item 2B) to the structural framing according to the curtain wall manufacturer's instructions. When required, connect the mounting attachments to the joint face of the concrete floor assembly (Item 1) according to the curtain wall manufacturer's instructions. Limit distance between mounting attachments to maximum 120".
 - B. Steel Stud Framing: Use minimum 3-5/8" by 1-5/8", 18 GA, C-shaped steel studs as vertical framing. Attach according to the curtain wall system manufacturer's guidelines. Limit distance between steel stud framing to maximum 48". When required, install horizontal structural framing members according to the curtain wall system manufacturer's guidelines and, in the spandrel area, locate a minimum of 33" above the top surface of the concrete floor assembly (Item 1).
 - C. Aluminum Panels: Install minimum 1/8" thick aluminum panels with maximum dimensions of 48" by 144" to steel stud framing (Item 2B) according to the curtain wall system manufacturer's guidelines.
 - D. Impaling Pins: When used with curtain wall insulation (Item 2E), locate, size and install impaling pins according to the curtain wall system manufacturer's guidelines, or be a minimum 4-1/2" long, 12 GA pin attached to one of the following: a nominal 2" by 2" plate; a nominal 2" by 2" by 2" long angle; or can be directly attached to the steel stud framing (Item 2B) using a stud gun. Space impaling pins a maximum of 12" on center. Install impaling pins around the periphery of the curtain wall insulation (Item 2E) so that its interior face is flush with the interior face of the steel stud framing (Item 2B).

Design No. 3MU/JS 120-06 *continued*

Construction Joints

Perimeter Joint

- E. **Curtain Wall Insulation:** Use nominal 24" wide, 4" thick, 4-pcf density, 3" thick, 6-pcf density, or 2" thick, 8-pcf density, mineral wool batt insulation. Install curtain wall insulation by fitting in each stud cavity between steel stud framing (Item 2B) using clips, impaling pins (Item 2D), or friction fit by using a curtain wall insulation lengths at least 1/4" longer than the distance between steel stud framing (Item 2B). Maintain 1-1/4" air cavity between curtain wall insulation and aluminum panels (Item 2C). Completely fill the recess of the "C-shaped" steel stud framing (Item 2B) with curtain wall insulation. Tightly compress together butt joints in the lengths of curtain wall insulation by using minimum 1/4" compression per piece of curtain wall insulation material. Use only Intertek certified products meeting the above minimum requirements.
- F. **Interior Curtain Wall Surface:** Entirely cover interior face of steel stud framing (Item 2B) with one layer of 5/8" thick, Type X gypsum board. Fasten gypsum board to steel stud framing (Item 2B) using minimum #6, 1-1/8" long bugle-head phillips drywall screws spaced nominally 12" on center. Joint Tape and Compound – Apply vinyl or casein, dry or premixed joint compound to exposed face of gypsum board in two coats to all exposed screw heads and gypsum board joints. Embed minimum 2" wide paper, plastic, or fiberglass tape in first layer of premixed joint compound over joints in gypsum board. Create minimum 3-5/8" deep wall cavity between unexposed face of gypsum board to unexposed face of aluminum panel (Item 2C).
- G. **Glass Vision Panels:** (Optional) When used, locate glass vision panels above spandrel area and a minimum 33" above the top surface of the concrete floor assembly (Item 1). Install glass vision panels to window framing (Item 2I) according to manufacturer's guidelines. Use a minimum 1/4" thick, clear tempered glass with maximum width and height width and height as determined by the window framing (Item 2I).
- H. **Window Gaskets:** When glass vision panels (Item 2G) used, use a thermal break (thermo-set rubber extrusion) to secure glass vision panels (Item 2G).
- I. **Window Framing:** When glass vision panels used, use steel framing members a minimum 3-5/8" by 1-5/8", 18 GA steel, U-shaped channel or similar construction compatible with structural framing (Item 2B). Locate window framing at least 33" above the top surface of the concrete floor assembly (Item 1).
3. **PERIMETER JOINT PROTECTION:** Do not exceed an 8 inch nominal joint width (joint width at installation). Incorporate the following construction features for the perimeter joint protection (also known as perimeter fire barrier system):
- A. **Packing Material:** Use a minimum 4" thick, 4-pcf density, mineral wool batt insulation installed with the fibers running parallel to the edge of concrete floor assembly (Item 1) and curtain wall assembly (Item 2). Cut packing material width to achieve required compression, refer below, when installed in the nominal joint width. Compress the packing material into the perimeter joint. Tightly compress together splices (butt joints) in the lengths of packing material by using minimum 1/4" compression per piece of packing material. When a spray coating is used, locate the top surface of the packing material flush with the top surface of the concrete floor assembly (Item 1). When the non-sag or self leveling silicone sealant is used, recess the top surface of the packing material 1/4" from the top surface of the concrete floor assembly (Item 1). Use only Intertek certified products meeting the above minimum requirements.
- I. When 50% compression is required cut the width of the packing material 2 times wider than the nominal joint width.
- II. When 33% compression is required cut the width of the packing material 1.5 times wider than the nominal joint width.
- III. When 20% compression is required cut the width of the packing material 1.25 times wider than the nominal joint width.
- B. **CERTIFIED COMPANY:** 3M Company
CERTIFIED PRODUCT: FireDam™ or Fire Barrier™
MODEL: FD Spray 200 (Elastomeric, Sprayable) or FB 1000 N/S Silicone Sealant (Non-sag) or FB 1003 S/L (Self Leveling)
Fill, Void or Cavity Material: Apply either spray coating or sealant over the packing material (Item 3A) as follows:
Spray Coating – Spray apply the liquid to cover the exposed top surface of the packing material (Item 3A) compressed and installed in the perimeter joint. Apply a minimum wet film thickness of 1/8" and overlap the spray coating a minimum 1/2" onto the adjacent curtain wall assembly (Item 2) and concrete floor assembly (Item 1). When the spraying process is stopped and the applied spray coating cures to an elastomeric film before installation process is restarted, then overlap the edge of the cured spray coating at least 1/8" with the liquid spray coating.
Sealant – Apply non-sag or self leveling sealant to cover the exposed surface of the packing material (Item 3A) compressed and installed in the perimeter joint. Apply minimum 1/4" thickness non-sag or self leveling sealant over the packing material (Item 3A) and finish flush with the top surface of the concrete floor assembly (Item 1).
- C. **Support Clips:** (Optional) Recommended for installations subject to vertical shear movement. Use standard 20 GA galvanized steel Z-shaped clips having the following nominal dimensions: 1" wide by 3" high with a 2" upper leg and a 3" lower leg.

This material was extracted and drawn by 3M Fire Protection Products from the 2012 Product Directory, © Intertek

JS

Design Number 3MU/JS 120-07

(Formerly OPL Design No. CEJ 121 P)

September 15, 2011

PERIMETER FIRE BARRIERS

3M Company

FireDam™ Spray 200, Fire Barrier 1000 NS Silicone Sealant and

Fire Barrier 1003 SL Silicone Sealant

ASTM E 2307

T-Rating Refer to Compression Percentage

F-Rating 2 hr

ASTM E 2307/ASTM E 1399 Cycling

Class IV: 500 cycles @ 30 cpm

Rated for ± 16.7% horizontal movement @ 50% Compression (Reference Item 3A): T-Rating 1/4 hr

Rated for ± 11% horizontal movement @ 33% Compression (Reference Item 3A): T-Rating 0 hr

Rated for ± 5% horizontal movement @ 20% Compression (Reference Item 3A): T-Rating 0 hr

Rated for ± 6.25% vertical shear movement @ 50% Compression (Reference Item 3A)

UL 2079

L-Rating <1.0 SCFM/LF

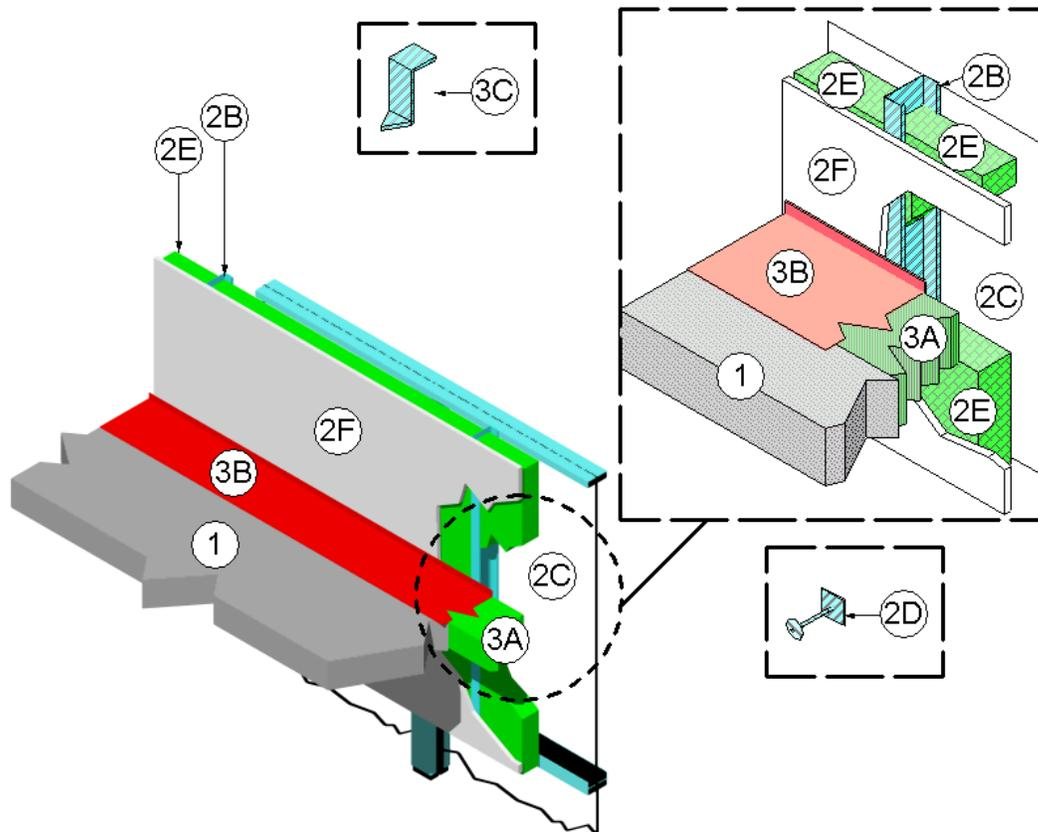

1. CONCRETE FLOOR ASSEMBLY: Two-hour rated concrete floor assembly made from either lightweight or normal weight concrete with a density of 100 to 150 pcf, having a minimum thickness of 4-1/2" at the joint face. When a longitudinal recess (blockout) is required to contain an architectural joint system, increase concrete floor assembly thickness to maintain a minimum thickness of 4-1/2" and accommodate depth of blockout formed in the concrete: blockout width unrestricted.
2. CURTAIN WALL ASSEMBLY: Incorporate the following construction features:
 - A. Mounting Attachment: (Not shown) Attach steel stud framing (Item 2B) to the structural framing according to the curtain wall manufacturer's instructions. When required, connect the mounting attachments to the joint face of the concrete floor assembly (Item 1) according to the curtain wall manufacturer's instructions. Limit distance between mounting attachments to maximum 120".
 - B. Steel Stud Framing: Use minimum 3-5/8" by 1-5/8", 18 GA, C-shaped steel studs as vertical framing. Attach according to the curtain wall system manufacturer's guidelines. Limit distance between vertical steel stud framing to maximum 48". Limit distance between horizontal steel stud framing to maximum 72". When required, install horizontal structural framing members according to the curtain wall system manufacturer's guidelines and, in the spandrel area, locate a minimum of 33" above the top surface of the concrete floor assembly (Item 1).
 - C. Glass Panels: Install glass panels to window framing according to manufacturer's guidelines. Use a minimum 1/4" thick, clear tempered glass with maximum width of 48" and height as determined by the window framing.
 - D. Impaling Pins: When used with curtain wall insulation (Item 2E), locate, size and install impaling pins according to the curtain wall system manufacturer's guidelines, or be a minimum 4-1/2" long, 12 GA pin attached to one of the following: a nominal 2" by 2" plate; a nominal 2" by 2" by 2" long angle; or can be directly attached to the steel stud framing (Item 2B) using a stud gun. Space impaling pins a maximum of 12" on center. Install impaling pins around the periphery of the curtain wall insulation (Item 2E) so that its interior face is flush with the interior face of the steel stud framing (Item 2B).

Design No. 3MU/JS 120-07 *continued*

Construction Joints

- E. **Curtain Wall Insulation:** Use nominal 24" wide, 4" thick, 4-pcf density, 3" thick, 6-pcf density, or 2" thick, 8-pcf density, mineral wool batt insulation. Install curtain wall insulation by fitting in each stud cavity between steel stud framing (Item 2B) using clips, impaling pins (Item 2D), or friction fit by using a curtain wall insulation lengths at least 1/4" longer than the distance between steel stud framing (Item 2B). Maintain 1-1/4" air cavity between curtain wall insulation and aluminum panels (Item 2C). Completely fill the recess of the "C-shaped" steel stud framing (Item 2B) with curtain wall insulation. Tightly compress together butt joints in the lengths of curtain wall insulation by using minimum 1/4" compression per piece of curtain wall insulation material. Locate horizontal seams in the curtain wall insulation at least 6" from the top surface of the perimeter joint protection (Item 3). Use only Intertek certified products meeting the above minimum requirements.
- F. **Interior Curtain Wall Surface:** Entirely cover interior face of steel stud framing (Item 2B) with one layer of 5/8" thick, Type X gypsum board. Fasten gypsum board to steel stud framing (Item 2B) using minimum #6, 1-1/8" long bugle-head phillips drywall screws spaced nominally 12" on center. Joint Tape and Compound – Apply vinyl or casein, dry or premixed joint compound to exposed face of gypsum board in two coats to all exposed screw heads and gypsum board joints. Embed minimum 2" wide paper, plastic, or fiberglass tape in first layer of premixed joint compound over joints in gypsum board. Create minimum 3-5/8" deep wall cavity between unexposed face of gypsum board to unexposed face of aluminum panel (Item 2C).

Perimeter Joint

- 3. **PERIMETER JOINT PROTECTION:** Do not exceed an 8" nominal joint width (joint width at installation). Incorporate the following construction features for the perimeter joint protection (also known as perimeter fire barrier system):
 - A. **Packing Material:** Use a minimum 4" thick, 4-pcf density, mineral wool batt insulation installed with the fibers running parallel to the edge of concrete floor assembly (Item 1) and curtain wall assembly (Item 2). Cut packing material width to achieve required compression, refer below, when installed in the nominal joint width. Compress the packing material into the perimeter joint. Tightly compress together splices (butt joints) in the lengths of packing material by using minimum 1/4" compression per piece of packing material. Use only Intertek certified products meeting the above minimum requirements. When a spray coating is used, locate the top surface of the packing material flush with the top surface of the concrete floor assembly (Item 1). When the non-sag or self leveling silicone sealant is used, recess the top surface of the packing material 1/4" from the top surface of the concrete floor assembly (Item 1). Use only Intertek certified products meeting the above minimum requirements.
 - I. When 50% compression is required cut the width of the packing material 2 times wider than the nominal joint width.
 - II. When 33% compression is required cut the width of the packing material 1.5 times wider than the nominal joint width.
 - III. When 20% compression is required cut the width of the packing material 1.25 times wider than the nominal joint width.
 - B. **CERTIFIED MANUFACTURER:** 3M Company
CERTIFIED PRODUCT: FireDam™ or Fire Barrier™
MODEL: FD Spray 200 (Elastomeric, Sprayable) or FB 1000 N/S Silicone Sealant (Non-sag) or FB 1003 S/L (Self Leveling) Sealant.
Fill, Void or Cavity Material: Apply either spray coating or sealant over the packing material (Item 3A) as follows:
Spray Coating – Spray apply the liquid to cover the exposed top surface of the packing material (Item 3A) compressed and installed in the perimeter joint. Apply a minimum wet film thickness of 1/8" and overlap the spray coating a minimum 1/2" onto the adjacent curtain wall assembly (Item 2) and concrete floor assembly (Item 1). When the spraying process is stopped and the applied spray coating cures to an elastomeric film before installation process is restarted, then overlap the edge of the cured spray coating at least 1/8" with the liquid spray coating.
Sealant – Apply non-sag or self leveling sealant to cover the exposed surface of the packing material (Item 3A) compressed and installed in the perimeter joint. Apply minimum 1/4" thickness non-sag or self leveling sealant over the packing material (Item 3A) and finish flush with the top surface of the concrete floor assembly (Item 1).
 - C. **Support Clips:** (Optional) Recommended for installations subject to vertical shear movement. Use standard 20 GA galvanized steel Z-shaped clips having the following nominal dimensions: 1" wide by 3" high with a 2" upper leg and a 3" lower leg.

This material was extracted and drawn by 3M Fire Protection Products from the 2012 Product Directory, © Intertek

JS

Design Number 3MU/JS 120-08

(Formerly OPL Design No. CEJ 122 P)

September 15, 2011

PERIMETER FIRE BARRIERS

3M Company

FireDam™ Spray 200, Fire Barrier 1000 NS Silicone Sealant and

Fire Barrier 1003 SL Silicone Sealant

ASTM E 2307

T-Rating Refer to Compression Percentage

F-Rating 2 hr

ASTM E 2307/ASTM E 1399 Cycling

Class IV: 500 cycles @ 30 cpm

Rated for ± 16.7% horizontal movement @ 50% Compression (Reference Item 3A): T-Rating 1/4 hr

Rated for ± 11% horizontal movement @ 33% Compression (Reference Item 3A): T-Rating 0 hr

Rated for ± 5% horizontal movement @ 20% Compression (Reference Item 3A): T-Rating 0 hr

Rated for ± 6.25% vertical shear movement @ 50% Compression (Reference Item 3A)

UL 2079

L-Rating <1.0 SCFM/LF

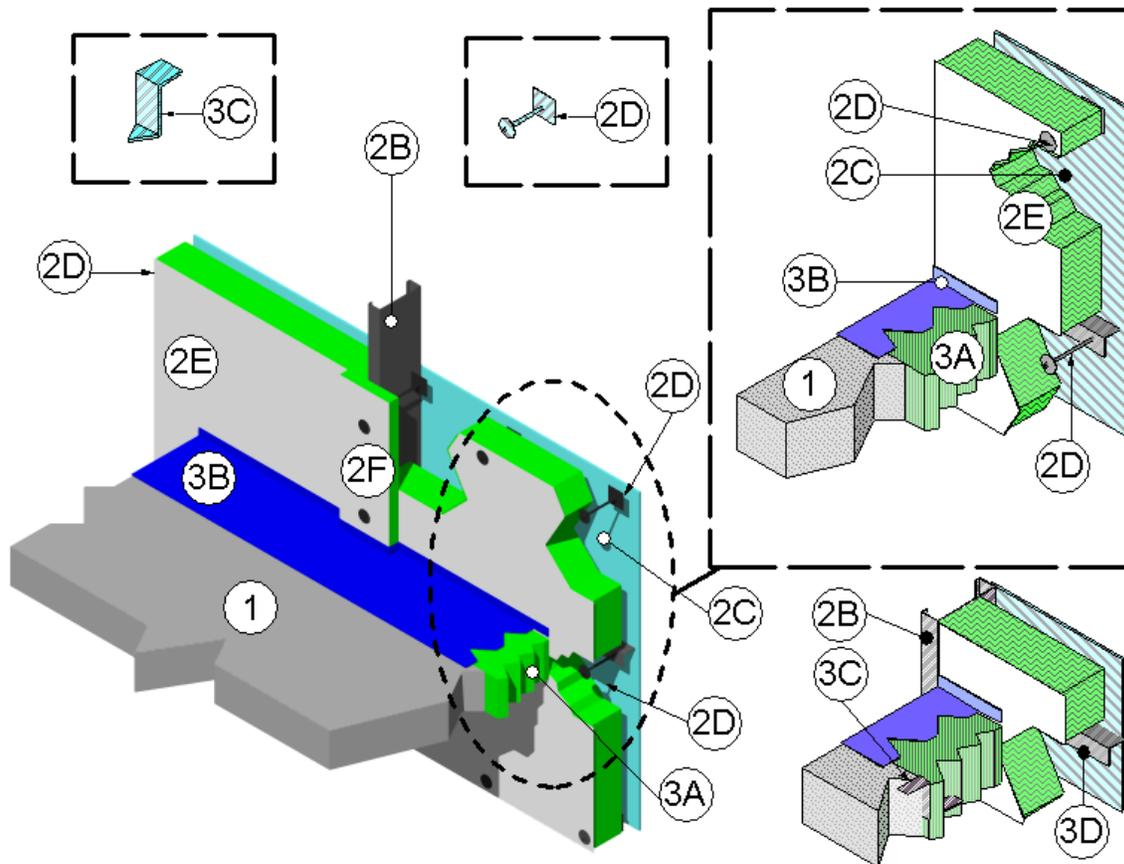

1. CONCRETE FLOOR ASSEMBLY: Two-hour rated concrete floor assembly made from either lightweight or normal weight concrete with a density of 100 to 150 pcf, having a minimum thickness of 4-1/2" at the joint face. When a longitudinal recess (blockout) is required to contain an architectural joint system, increase concrete floor assembly thickness to maintain a minimum thickness of 4-1/2" and accommodate depth of blockout formed in the concrete: blockout width unrestricted.
2. CURTAIN WALL ASSEMBLY: Incorporate the following construction features:
 - A. Mounting Attachment: (Not shown) Attach steel stud framing (Item 2B) to the structural framing according to the curtain wall manufacturer's instructions. When required, connect the mounting attachments to the joint face of the concrete floor assembly (Item 1) according to the curtain wall manufacturer's instructions. Limit distance between mounting attachments to maximum 120".
 - B. Steel Stud Framing: Use minimum 3-5/8" by 1-5/8", 18 GA, C-shaped steel studs as vertical framing. Attach according to the curtain wall system manufacturer's guidelines. Limit distance between steel stud framing to maximum 48". Install horizontal structural framing members according to the curtain wall system manufacturer's guidelines and, in the spandrel area, locate a minimum of 33" above the top surface of the concrete floor assembly (Item 1).
 - C. Aluminum Panels: Install minimum 1/8" thick aluminum panels with maximum dimensions of 48" by 144" to steel stud framing (Item 2B) according to the curtain wall system manufacturer's guidelines.
 - D. Impaling Pins: When used with curtain wall insulation (Item 2E), locate, size and install impaling pins according to the curtain wall system manufacturer's guidelines, or be a minimum 4-1/2" long, 12 GA pin attached to one of the following: a nominal 2" by 2" plate; a nominal 2" by 2" by 2" long angle; or can be directly attached to the steel stud framing (Item 2B) using a stud gun. Space impaling pins a maximum of 12" on center. Install impaling pins around the periphery of the curtain wall insulation (Item 2E) so that its interior face is flush with the interior face of the steel stud framing (Item 2B).

Design No. 3MU/JS 120-08 *continued*

Construction Joints

Perimeter Joint

- E. **Curtain Wall Insulation:** Install perimeter fire barrier reinforcement (Item 3D) prior to curtain wall insulation. Use nominal 24" wide, 4" thick, 4-pcf density, 3" thick, 6-pcf density, or 2" thick, 8-pcf density, mineral wool batt insulation, sealed on one side with aluminum foil scrim (vapor retarder), which faces the room interior. Install curtain wall insulation by fitting in each stud cavity between steel stud framing (Item 2B) using clips, impaling pins (Item 2D), or friction fit by using a curtain wall insulation lengths at least 1/4" longer than the distance between steel stud framing (Item 2B). Maintain 1-1/4" air cavity between curtain wall insulation and aluminum panels (Item 2C). Completely fill the recess of the "C-shaped" steel stud framing (Item 2B) with curtain wall insulation. Tightly compress together butt joints in the lengths of curtain wall insulation by using minimum 1/4" compression per piece of curtain wall insulation material. Tape all adjacent edges between curtain wall insulation, or between steel stud framing (Item 2B) and curtain wall insulation, with min. 4" wide pressure sensitive aluminum foil tape, centered over the seam. Locate horizontal seams in the curtain wall insulation at least 6" above or below the top surface of the perimeter joint protection (Item 3). Use only Intertek certified products meeting the above minimum requirements.
- F. **Framing Covers:** Make from strips of 1", 8 pcf density, mineral wool batt insulation faced on one side with aluminum foil scrim (vapor retarder), which is exposed to the room interior. Cut strips a minimum 1-1/2" wider than steel stud framing (Item 2B). Use only Intertek certified products meeting the above minimum requirements. Center framing covers over all steel stud framing (Item 2B) and secure using impaling pins (Item 2D). Do not pass framing covers through the perimeter joint protection (Item 3). Allow framing covers to abut the top and the bottom surfaces of the perimeter joint protection (Item 3) provided that no deformation occurs. Use only Intertek certified products meeting the above minimum requirements.
- G. **Glass Vision Panels:** (Optional) When used, locate glass vision panels above spandrel area and a minimum 33" above the top surface of the concrete floor assembly (Item 1). Install glass vision panels to window framing (Item 2I) according to manufacturer's guidelines. Use a minimum 1/4" thick, clear tempered glass with maximum width and height width and height as determined by the window framing (Item 2I).
- H. **Window Gaskets:** When glass vision panels (Item 2G) used, use a thermal break (thermo-set rubber extrusion) to secure glass vision panels (Item 2G).
- I. **Window Framing:** When glass vision panels used, use steel framing members a minimum 3-5/8" by 1-5/8", 18 GA steel, U-shaped channel or similar construction compatible with structural framing (Item 2B). Locate window framing at least 33" above the top surface of the concrete floor assembly (Item 1).
3. **PERIMETER JOINT PROTECTION:** Do not exceed an 8" nominal joint width (joint width at installation). Incorporate the following construction features for the perimeter joint protection (also known as perimeter fire barrier system):
- A. **Packing Material:** Use a minimum 4" thick, 4 pcf density, mineral wool batt insulation installed with the fibers running parallel to the edge of concrete floor assembly (Item 1) and curtain wall assembly (Item 2). Cut packing material width to achieve required compression, refer below, when installed in the nominal joint width. Compress the packing material into the perimeter joint. Tightly compress together splices (butt joints) in the lengths of packing material by using minimum 1/4" compression per piece of packing material. When a spray coating is used, locate the top surface of the packing material flush with the top surface of the concrete floor assembly (Item 1). When the non-sag or self leveling silicone sealant is used, recess the top surface of the packing material 1/4" from the top surface of the concrete floor assembly (Item 1). Use only Intertek certified products meeting the above minimum requirements.
- I. When 50% compression is required cut the width of the packing material 2 times wider than the nominal joint width.
- II. When 33% compression is required cut the width of the packing material 1.5 times wider than the nominal joint width.
- III. When 20% compression is required cut the width of the packing material 1.25 times wider than the nominal joint width.
- B. **CERTIFIED COMPANY:** 3M Company
CERTIFIED PRODUCT: FireDam™ or Fire Barrier™
MODEL: FD Spray 200 (Elastomeric, Sprayable) or FB 1000 N/S Silicone Sealant (Non-sag) or FB 1003 S/L (Self Leveling) Sealant
Fill, Void or Cavity Material: Apply either spray coating or sealant over the packing material (Item 3A) as follows:
Spray Coating – Spray apply the liquid to cover the exposed top surface of the packing material (Item 3A) compressed and installed in the perimeter joint. Apply a minimum wet film thickness of 1/8" and overlap the spray coating a minimum 1/2" onto the adjacent curtain wall assembly (Item 2) and concrete floor assembly (Item 1). When the spraying process is stopped and the applied spray coating cures to an elastomeric film before installation process is restarted, then overlap the edge of the cured spray coating at least 1/8" with the liquid spray coating.
Sealant – Apply non-sag or self leveling sealant to cover the exposed surface of the packing material (Item 3A) compressed and installed in the perimeter joint. Apply minimum 1/4" thickness non-sag or self leveling sealant over the packing material (Item 3A) and finish flush with the top surface of the concrete floor assembly (Item 1).
- C. **Support Clips:** (Optional) Recommended for installations subject to vertical shear movement. Use standard 20 GA galvanized steel Z-shaped clips having the following nominal dimensions: 1" wide by 3" high with a 2" upper leg and a 3" lower leg.
- D. **Perimeter Fire Barrier Reinforcement:** Use minimum 20 GA, steel angle having a 1-1/2" high vertical leg and a 1-1/2" wide horizontal leg. Fully embed horizontal leg into the curtain wall insulation (Item 2E) at the centerline of the packing material (Item 3A). Secure the vertical leg at each mullion interior face (steel stud framing – Item 2B) using at least two minimum 1/2" long, No. 10, sheet metal screws spaced nominally 1" on center. Install perimeter fire barrier reinforcement continuous along the length of the perimeter joint protection (Item 3). Overlap joints in the perimeter fire barrier reinforcement a minimum 12" and secure the overlap using at least three minimum 1/4" long, No. 10, sheet metal screws spaced nominally 4" on center, placed in both the vertical and horizontal legs of the angles.

This material was extracted and drawn by 3M Fire Protection Products from the 2012 Product Directory, © Intertek

JS

Design Number 3MU/JS 120-09

(Formerly OPL Design No. CEJ 123 P)

September 15, 2011

PERIMETER FIRE BARRIERS

3M Company

FireDam™ Spray 200, Fire Barrier 1000 NS Silicone Sealant and

Fire Barrier 1003 SL Silicone Sealant

ASTM E 2307

T-Rating Refer to Compression Percentage

F-Rating 2 hr

ASTM E 2307/ASTM E 1399 Cycling

Class IV: 500 cycles @ 30 cpm

Rated for ± 16.7% horizontal movement @ 50% Compression (Reference Item 3A): T-Rating 1/4 hr

Rated for ± 11% horizontal movement @ 33% Compression (Reference Item 3A): T-Rating 0 hr

Rated for ± 5% horizontal movement @ 20% Compression (Reference Item 3A): T-Rating 0 hr

Rated for ± 6.25% vertical shear movement @ 50% Compression (Reference Item 3A)

UL 2079

L-Rating <1.0 SCFM/LF

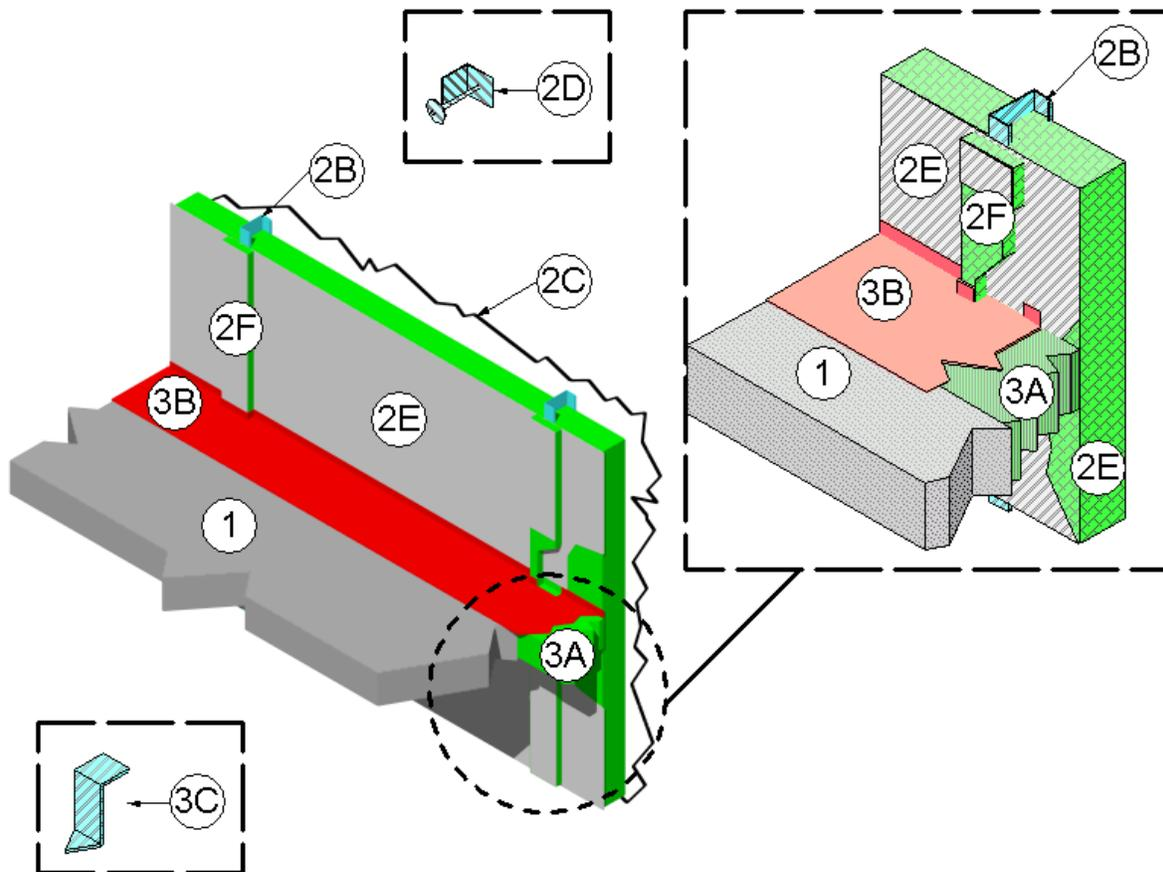

1. CONCRETE FLOOR ASSEMBLY: Two-hour rated concrete floor assembly made from either lightweight or normal weight concrete with a density of 100 to 150 pcf, having a minimum thickness of 4-1/2" at the joint face. When a longitudinal recess (blockout) is required to contain an architectural joint system, increase concrete floor assembly thickness to maintain a minimum thickness of 4-1/2" and accommodate depth of blockout formed in the concrete: blockout width unrestricted.
2. CURTAIN WALL ASSEMBLY: Incorporate the following construction features:
 - A. Mounting Attachment: (Not shown) Attach steel stud framing (Item 2B) to the structural framing according to the curtain wall manufacturer's instructions. When required, connect the mounting attachments to the joint face of the concrete floor assembly (Item 1) according to the curtain wall manufacturer's instructions. Limit distance between mounting attachments to maximum 120".
 - B. Steel Stud Framing: Use minimum 5-1/2" by 1-5/8", 18 GA, C-shaped steel studs as vertical framing. Attach according to the curtain wall system manufacturer's guidelines. Limit distance between steel stud framing to maximum 48". Install horizontal structural framing members to maximum 72" according to the curtain wall system manufacturer's guidelines and, in the spandrel area, locate a minimum of 33" above the top surface of the concrete floor assembly (Item 1).
 - C. Glass Panels: Install glass panels into curtain wall framing according to the curtain wall system manufacturer's guidelines. Use a minimum 1/4" thick, clear heat-strengthened (HS) or tempered glass with a maximum width of 48".
 - D. Impaling Pins: When used with curtain wall insulation (Item 2E), locate, size and install impaling pins according to the curtain wall system manufacturer's guidelines, or be a minimum 4-1/2" long, 12 GA pin attached to one of the following: a nominal 2" by 2" plate; a nominal 2" by 2" by 2" long angle; or can be directly attached to the steel stud framing (Item 2B) using a stud gun. Space impaling pins a maximum of 12" on center. Install impaling pins around the periphery of the curtain wall insulation (Item 2E) so that its interior face is flush with the interior face of the steel stud framing (Item 2B).

Design No. 3MU/JS 120-09 *continued*

Construction Joints

Perimeter Joint

- E. **Curtain Wall Insulation:** Use nominal 24" wide, 4" thick, 4-pcf density, 3" thick, 6-pcf density, or 2" thick, 8-pcf density, mineral wool batt insulation. Install curtain wall insulation by fitting in each stud cavity between steel stud framing (Item 2B) using clips, impaling pins (Item 2D), or friction fit by using a curtain wall insulation lengths at least 1/4" longer than the distance between steel stud framing (Item 2B). Maintain 1-1/4" air cavity between curtain wall insulation and glass panels (Item 2C). Completely fill the recess of the "C-shaped" steel stud framing (Item 2B) with curtain wall insulation. Tightly compress together butt joints in the lengths of curtain wall insulation by using minimum 1/4" compression per piece of curtain wall insulation material. Tape all adjacent edges between curtain wall insulation, or between steel stud framing (Item 2B) and curtain wall insulation, with min. 4" wide pressure sensitive aluminum foil tape, centered over the seam. Locate horizontal seams in the curtain wall insulation at least 6" above or below the top surface of the perimeter joint protection (Item 3). Use only Intertek certified products meeting the above minimum requirements.
- F. **Framing Covers:** Make from strips of 1", 8 pcf density, mineral wool batt insulation faced on one side with aluminum foil scrim (vapor retarder), which is exposed to the room interior. Cut strips a minimum 1-1/2" wider than steel stud framing (Item 2B). Center framing covers over all steel stud framing (Item 2B) and secure using impaling pins (Item 2D). Do not pass framing covers through the perimeter joint protection (Item 3). Allow framing covers to abut the top and the bottom surfaces of the perimeter joint protection (Item 3) provided that no deformation occurs. Use only Intertek certified products meeting the above minimum requirements.
3. **PERIMETER JOINT PROTECTION:** Do not exceed an 8" nominal joint width (joint width at installation). Incorporate the following construction features for the perimeter joint protection (also known as perimeter fire barrier system):
- A. **Packing Material:** Use a minimum 4" thick, 4 pcf density, mineral wool batt insulation installed with the fibers running parallel to the edge of concrete floor assembly (Item 1) and curtain wall assembly (Item 2). Cut packing material width to achieve required compression, refer below, when installed in the nominal joint width. Compress the packing material into the perimeter joint. Tightly compress together splices (butt joints) in the lengths of packing material by using minimum 1/4" compression per piece of packing material. When a spray coating is used, locate the top surface of the packing material flush with the top surface of the concrete floor assembly (Item 1). When the non-sag or self leveling silicone sealant is used, recess the top surface of the packing material 1/4" from the top surface of the concrete floor assembly (Item 1). Use only Intertek certified products meeting the above minimum requirements.
- I. When 50% compression is required cut the width of the packing material 2 times wider than the nominal joint width.
- II. When 33% compression is required cut the width of the packing material 1.5 times wider than the nominal joint width.
- III. When 20% compression is required cut the width of the packing material 1.25 times wider than the nominal joint width.
- B. **CERTIFIED COMPANY:** 3M Company
CERTIFIED PRODUCT: FireDam™ or Fire Barrier™
MODEL: FD Spray 200 (Elastomeric, Sprayable) or FB 1000 N/S Silicone Sealant (Non-sag) or FB 1003 S/L (Self Leveling) Sealant.
Fill, Void or Cavity Material: Apply either spray coating or sealant over the packing material (Item 3A) as follows:
Spray Coating – Spray apply the liquid to cover the exposed top surface of the packing material (Item 3A) compressed and installed in the perimeter joint. Apply a minimum wet film thickness of 1/8" and overlap the spray coating a minimum 1/2" onto the adjacent curtain wall assembly (Item 2) and concrete floor assembly (Item 1). When the spraying process is stopped and the applied spray coating cures to an elastomeric film before installation process is restarted, then overlap the edge of the cured spray coating at least 1/8" with the liquid spray coating.
Sealant – Apply non-sag or self leveling sealant to cover the exposed surface of the packing material (Item 3A) compressed and installed in the perimeter joint. Apply minimum 1/4" thickness non-sag or self leveling sealant over the packing material (Item 3A) and finish flush with the top surface of the concrete floor assembly (Item 1).
- C. **Support Clips:** (Optional) Recommended for installations subject to vertical shear movement. Use standard 20 GA galvanized steel Z-shaped clips having the following nominal dimensions: 1" wide by 3" high with a 2" upper leg and a 3" lower leg.
- D. **Reinforcing Angle:** (Not Shown) Locate reinforcing angle at all horizontal butt joints of the curtain wall insulation (Item 2E) in the field of the glass spandrel panels (Item 2C) and horizontal centerline of the perimeter joint protection (Item 3). Place two minimum 20 GA steel angles having 1.5" x 1.5" legs back to back to form a "T".

This material was extracted and drawn by 3M Fire Protection Products from the 2012 Product Directory, © Intertek

JS

Design Number 3MU/JS 120-10

(Formerly OPL Design No. CEJ 124 P)

November 11, 2011

PERIMETER FIRE BARRIERS

3M Company

FireDam™ Spray 200, Fire Barrier 1000 NS Silicone Sealant and

Fire Barrier 1003 SL Silicone Sealant

ASTM E 2307

T-Rating Refer to Compression Percentage

F-Rating 2 hr

ASTM E 2307/ASTM E 1399 Cycling

Class IV: 500 cycles @ 30 cpm

Rated for ± 16.7% horizontal movement @ 50% Compression (Reference Item 3A): T-Rating 1/4 hr

Rated for ± 11% horizontal movement @ 33% Compression (Reference Item 3A): T-Rating 0 hr

Rated for ± 5% horizontal movement @ 20% Compression (Reference Item 3A): T-Rating 0 hr

Rated for ± 6.25% vertical shear movement @ 50% Compression (Reference Item 3A)

UL 2079

L-Rating <1.0 SCFM/LF

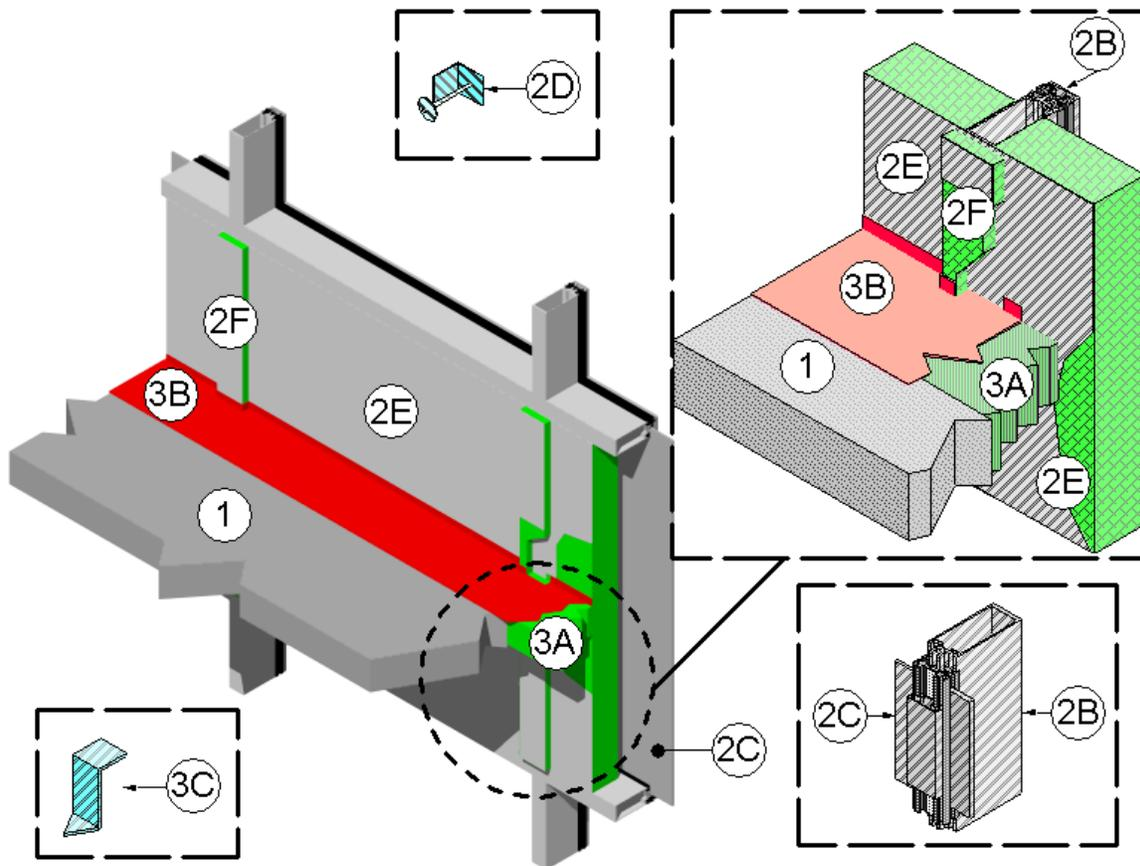

1. CONCRETE FLOOR ASSEMBLY: Two-hour rated concrete floor assembly made from either lightweight or normal weight concrete with a density of 100 to 150 pcf, having a minimum thickness of 4-1/2" at the joint face. When a longitudinal recess (blockout) is required to contain an architectural joint system, increase concrete floor assembly thickness to maintain a minimum thickness of 4-1/2" and accommodate depth of blockout formed in the concrete: blockout width unrestricted.
2. CURTAIN WALL ASSEMBLY: Incorporate the following construction features:
 - A. Mounting Attachment: (Not shown) Attach aluminum framing (Item 2B) to the structural framing according to the curtain wall manufacturer's instructions. When required, connect the mounting attachments to the joint face of the concrete floor assembly (Item 1) according to the curtain wall manufacturer's instructions. Limit distance between mounting attachments to maximum 120".
 - B. Aluminum Framing: Use rectangular aluminum tubing mullions and transoms, sized according to the curtain wall system manufacturer's guidelines. Minimum required framing dimensions, use 0.100" thick walls with minimum 6-1/2" depth and minimum 2-1/2" width. Space mullions minimum 56-1/2" on center and space transoms minimum 69" on center. Locate transoms at a height of 33" above the top surface of the concrete floor assembly (Item 1) as measured from the bottom of the transom.
 - C. Aluminum Panels: Install aluminum panels into curtain wall framing according to the curtain wall system manufacturer's guidelines. Use a minimum 1/8" thick sheet aluminum panel with maximum dimensions of 60" wide x 72" high.
 - D. Impaling Pins: When used with curtain wall insulation (Item 2E), locate, size and install impaling pins according to the curtain wall system manufacturer's guidelines, or be a minimum 4-1/2" long, 12 GA pin attached to one of the following: a nominal 2" by 2" plate; a nominal 2" by 2" by 2" long angle; or can be directly attached to the aluminum framing (Item 2B) using a stud gun. Space impaling pins a maximum of 12" on center. Install impaling pins around the periphery of the curtain wall insulation (Item 2E) so that its interior face is flush with the interior face of the aluminum framing (Item 2B).

Design No. 3MU/JS 120-10 *continued*

Construction Joints

Perimeter Joint

- E. **Curtain Wall Insulation:** Use nominal 24" wide, 4" thick, 4-pcf density, 3" thick, 6-pcf density, or 2" thick, 8-pcf density, mineral wool batt insulation. Install curtain wall insulation by fitting in each cavity between aluminum framing (Item 2B) using clips, impaling pins (Item 2D), or friction fit by using a curtain wall insulation lengths at least 1/4" longer than the distance between aluminum framing (Item 2B). Maintain 1-1/4" air cavity between curtain wall insulation and aluminum panels (Item 2C). Tightly compress together butt joints in the lengths of curtain wall insulation by using minimum 1/4" compression per piece of curtain wall insulation material. Tape all adjacent edges between curtain wall insulation, or between aluminum framing (Item 2B) and curtain wall insulation, with min. 4" wide pressure sensitive aluminum foil tape, centered over the seam. Locate horizontal seams in the curtain wall insulation at least 6" above or below the top surface of the perimeter joint protection (Item 3). Use only Intertek certified products meeting the above minimum requirements.
- F. **Framing Covers:** Make from strips of 1", 8 pcf density, mineral wool batt insulation faced on one side with aluminum foil scrim (vapor retarder), which is exposed to the room interior. Cut strips a minimum 1-1/2" wider than aluminum framing (Item 2B). Use only Intertek certified products meeting the above minimum requirements. Center framing covers over all aluminum framing (Item 2B) and secure using impaling pins (Item 2I). Do not pass framing covers through the perimeter joint protection (Item 3). Allow framing covers to abut the top and the bottom surfaces of the perimeter joint protection (Item 3) provided that no deformation occurs. Use only Intertek certified products meeting the above minimum requirements.
- G. **Glass Vision Panels: (Optional)** When used, locate glass vision panels above spandrel area and a minimum 33" above the top surface of the concrete floor assembly (Item 1). Install glass vision panels to window framing (Item 2I) according to manufacturer's guidelines. Use a minimum 1/4" thick, clear tempered glass with maximum width and height width and height as determined by the window framing (Item 2I).
- H. **Window Gaskets:** When glass vision panels (Item 2G) used, use a thermal break (thermo-set rubber extrusion) to secure glass vision panels (Item 2G).
- I. **Window Framing:** When glass vision panels are used, use aluminum framing members shall be a minimum 0.100" thick walls and a minimum 6-1/2" by 2-1/2" or similar construction compatible with structural framing (Item 2B). Locate window framing at least 33" above the top surface of the concrete floor assembly (Item 1).
3. **PERIMETER JOINT PROTECTION:** Do not exceed an 8" nominal joint width (joint width at installation). Incorporate the following construction features for the perimeter joint protection (also known as perimeter fire barrier system):
- A. **Packing Material:** Use a minimum 4" thick, 4 pcf density, mineral wool batt insulation installed with the fibers running parallel to the edge of concrete floor assembly (Item 1) and curtain wall assembly (Item 2). Cut packing material width to achieve required compression, refer below, when installed in the nominal joint width. Compress the packing material into the perimeter joint. Tightly compress together splices (butt joints) in the lengths of packing material by using minimum 1/4" compression per piece of packing material. When a spray coating is used, locate the top surface of the packing material flush with the top surface of the concrete floor assembly (Item 1). When the non-sag or self leveling silicone sealant is used, recess the top surface of the packing material 1/4" from the top surface of the concrete floor assembly (Item 1). Use only Intertek certified products meeting the above minimum requirements.
- I. When 50% compression is required cut the width of the packing material 2 times wider than the nominal joint width.
- II. When 33% compression is required cut the width of the packing material 1.5 times wider than the nominal joint width.
- III. When 20% compression is required cut the width of the packing material 1.25 times wider than the nominal joint width.
- B. **CERTIFIED COMPANY:** 3M Company
CERTIFIED PRODUCT: FireDam™ or Fire Barrier™
MODEL: FD Spray 200 (Elastomeric, Sprayable) or FB 1000 N/S Silicone Sealant (Non-sag) or FB 1003 S/L (Self Leveling) Sealant.
Fill, Void or Cavity Material: Apply either spray coating or sealant over the packing material (Item 3A) as follows:
Spray Coating – Spray apply the liquid to cover the exposed top surface of the packing material (Item 3A) compressed and installed in the perimeter joint. Apply a minimum wet film thickness of 1/8" and overlap the spray coating a minimum 1/2" onto the adjacent curtain wall assembly (Item 2) and concrete floor assembly (Item 1). When the spraying process is stopped and the applied spray coating cures to an elastomeric film before installation process is restarted, then overlap the edge of the cured spray coating at least 1/8" with the liquid spray coating.
Sealant – Apply non-sag or self leveling sealant to cover the exposed surface of the packing material (Item 3A) compressed and installed in the perimeter joint. Apply minimum 1/4" thickness non-sag or self leveling sealant over the packing material (Item 3A) and finish flush with the top surface of the concrete floor assembly (Item 1).
- C. **Support Clips: (Optional)** Recommended for installations subject to vertical shear movement. Use standard 20 GA galvanized steel Z-shaped clips having the following nominal dimensions: 1" wide by 3" high with a 2" upper leg and a 3" lower leg.

This material was extracted and drawn by 3M Fire Protection Products from the 2012 Product Directory, © Intertek

JS

Design Number 3MU/JS 120-11

(Formerly OPL Design No. CEJ 125 P)

November 11, 2011

PERIMETER FIRE BARRIERS

3M Company

FireDam™ Spray 200, Fire Barrier 1000 NS Silicone Sealant and

Fire Barrier 1003 SL Silicone Sealant

ASTM E 2307

T-Rating Refer to Compression Percentage

F-Rating 2 hr

ASTM E 2307/ASTM E 1399 Cycling

Class IV: 500 cycles @ 30 cpm

Rated for ± 16.7% horizontal movement @ 50% Compression (Reference Item 3A): T-Rating 1/4 hr

Rated for ± 11% horizontal movement @ 33% Compression (Reference Item 3A): T-Rating 0 hr

Rated for ± 5% horizontal movement @ 20% Compression (Reference Item 3A): T-Rating 0 hr

Rated for ± 6.25% vertical shear movement @ 50% Compression (Reference Item 3A)

UL 2079

L-Rating <1.0 SCFM/LF

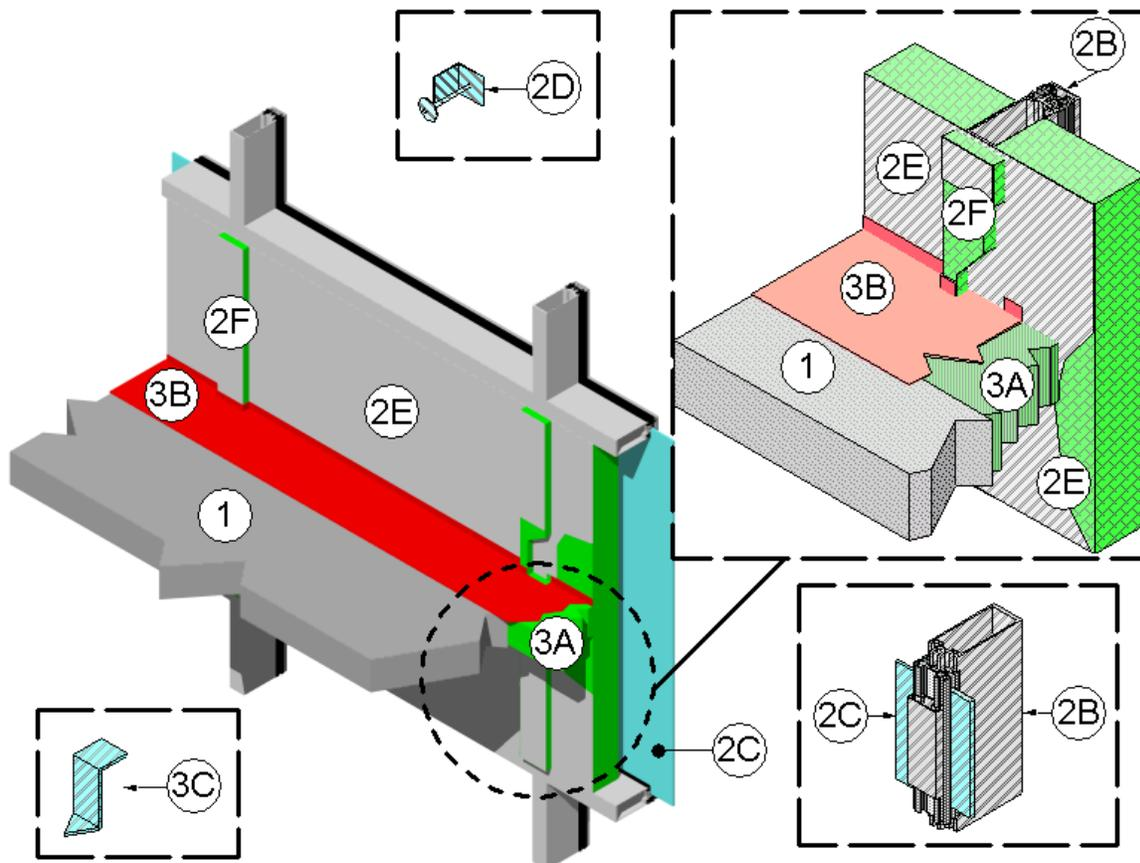

1. CONCRETE FLOOR ASSEMBLY: Two-hour rated concrete floor assembly made from either lightweight or normal weight concrete with a density of 100 to 150 pcf, having a minimum thickness of 4-1/2" at the joint face. When a longitudinal recess (blockout) is required to contain an architectural joint system, increase concrete floor assembly thickness to maintain a minimum thickness of 4-1/2" and accommodate depth of blockout formed in the concrete: blockout width unrestricted.
2. CURTAIN WALL ASSEMBLY: Incorporate the following construction features:
 - A. Mounting Attachment: (Not shown) Attach aluminum framing (Item 2B) to the structural framing according to the curtain wall manufacturer's instructions. When required, connect the mounting attachments to the joint face of the concrete floor assembly (Item 1) according to the curtain wall manufacturer's instructions. Limit distance between mounting attachments to maximum 120".
 - B. Aluminum Framing: Use rectangular aluminum tubing mullions and transoms, sized according to the curtain wall system manufacturer's guidelines. Minimum required framing dimensions, use 0.100" thick walls with minimum 6-1/2" depth and minimum 2-1/2" width. Space mullions minimum 56-1/2" oc and space transoms minimum 69" oc. Locate transoms at a height of 33" above the top surface of the concrete floor assembly (Item 1) as measured from the bottom of the transom.
 - C. Steel Panels: Install steel panels to curtain wall framing according to the curtain wall system manufacturer's guidelines. Use a minimum 20 GA sheet steel panel with maximum dimensions of 60" wide x 72" high.
 - D. Impaling Pins: When used with curtain wall insulation (Item 2E), locate, size and install impaling pins according to the curtain wall system manufacturer's guidelines, or be a minimum 4-1/2" long, 12 GA pin attached to one of the following: a nominal 2" by 2" plate; a nominal 2" by 2" by 2" long angle; or can be directly attached to the aluminum framing (Item 2B) using a stud gun. Space impaling pins a maximum of 12" oc. Install impaling pins around the periphery of the curtain wall insulation (Item 2E) so that its interior face is flush with the interior face of the aluminum framing (Item 2B).

Design No. 3MU/JS 120-11 *continued*

Construction Joints

Perimeter Joint

- E. **Curtain Wall Insulation:** Use nominal 24" wide, 4" thick, 4-pcf density, 3" thick, 6-pcf density, or 2" thick, 8-pcf density, mineral wool batt insulation. Install curtain wall insulation by fitting in each cavity between aluminum framing (Item 2B) using clips, impaling pins (Item 2D), or friction fit by using a curtain wall insulation lengths at least 1/4" longer than the distance between aluminum framing (Item 2B). Maintain 1-1/4" air cavity between curtain wall insulation and steel panels (Item 2C). Tightly compress together butt joints in the lengths of curtain wall insulation by using minimum 1/4" compression per piece of curtain wall insulation material. Tape all adjacent edges between curtain wall insulation, or between aluminum framing (Item 2B) and curtain wall insulation, with min. 4" wide pressure sensitive aluminum foil tape, centered over the seam. Locate horizontal seams in the curtain wall insulation at least 6" above or below the top surface of the perimeter joint protection (Item 3). Use only Intertek certified products meeting the above minimum requirements.
- F. **Framing Covers:** Make from strips of 1", 8 pcf density, mineral wool batt insulation faced on one side with aluminum foil scrim (vapor retarder), which is exposed to the room interior. Cut strips a minimum 1-1/2" wider than aluminum framing (Item 2B). Center framing covers over all aluminum framing (Item 2B) and secure using impaling pins (Item 2I). Do not pass framing covers through the perimeter joint protection (Item 3). Allow framing covers to abut the top and the bottom surfaces of the perimeter joint protection (Item 3) provided that no deformation occurs. Use only Intertek certified products meeting the above minimum requirements.
- G. **Glass Vision Panels:** (Optional) When used, locate glass vision panels above spandrel area and a minimum 33" above the top surface of the concrete floor assembly (Item 1). Install glass vision panels to window framing (Item 2I) according to manufacturer's guidelines. Use a minimum 1/4" thick, clear tempered glass with maximum width and height width and height as determined by the window framing (Item 2I).
- H. **Window Gaskets:** When glass vision panels (Item 2G) used, use a thermal break (thermal-set rubber extrusion) to secure glass vision panels (Item 2G).
- I. **Window Framing:** When glass vision panels are used, use aluminum framing members shall be a minimum 0.100" thick walls and a minimum 6-1/2" by 2-1/2" or similar construction compatible with structural framing (Item 2B). Locate window framing at least 33" above the top surface of the concrete floor assembly (Item 1).
3. **PERIMETER JOINT PROTECTION:** Do not exceed an 8" nominal joint width (joint width at installation). Incorporate the following construction features for the perimeter joint protection (also known as perimeter fire barrier system):
- A. **Packing Material:** Use a minimum 4" thick, 4-pcf density, mineral wool batt insulation installed with the fibers running parallel to the edge of concrete floor assembly (Item 1) and curtain wall assembly (Item 2). Cut packing material width to achieve required compression, refer below, when installed in the nominal joint width. Compress the packing material into the perimeter joint. Tightly compress together splices (butt joints) in the lengths of packing material by using minimum 1/4" compression per piece of packing material. When a spray coating is used, locate the top surface of the packing material flush with the top surface of the concrete floor assembly (Item 1). When the non-sag or self leveling silicone sealant is used, recess the top surface of the packing material 1/4" from the top surface of the concrete floor assembly (Item 1). Use only Intertek certified products meeting the above minimum requirements.
- I. When 50% compression is required cut the width of the packing material 2 times wider than the nominal joint width.
- II. When 33% compression is required cut the width of the packing material 1.5 times wider than the nominal joint width.
- III. When 20% compression is required cut the width of the packing material 1.25 times wider than the nominal joint width.
- B. **CERTIFIED COMPANY:** 3M Company
CERTIFIED PRODUCT: FireDam™ or Fire Barrier™
MODEL: FD Spray 200 (Elastomeric, Sprayable) or FB 1000 N/S Silicone Sealant (Non-sag) or FB 1003 S/L (Self Leveling)
Fill, Void or Cavity Material: Apply either spray coating or sealant over the packing material (Item 3A) as follows:
Spray Coating – Spray apply the liquid to cover the exposed top surface of the packing material (Item 3A) compressed and installed in the perimeter joint. Apply a minimum wet film thickness of 1/8" and overlap the spray coating a minimum 1/2" onto the adjacent curtain wall assembly (Item 2) and concrete floor assembly (Item 1). When the spraying process is stopped and the applied spray coating cures to an elastomeric film before installation process is restarted, then overlap the edge of the cured spray coating at least 1/8" with the liquid spray coating.
Sealant – Apply non-sag or self leveling sealant to cover the exposed surface of the packing material (Item 3A) compressed and installed in the perimeter joint. Apply minimum 1/4" thickness non-sag or self leveling sealant over the packing material (Item 3A) and finish flush with the top surface of the concrete floor assembly (Item 1).
- C. **Support Clips:** (Optional) Recommended for installations subject to vertical shear movement. Use standard 20 GA galvanized steel Z-shaped clips having the following nominal dimensions: 1" wide by 3" high with a 2" upper leg and a 3" lower leg.

This material was extracted and drawn by 3M Fire Protection Products from the 2012 Product Directory, © Intertek

JS

Design Number 3MU/JS 120-12

(Formerly OPL Design No. CEJ 126 P)

November 11, 2011

PERIMETER FIRE BARRIERS

3M Company

FireDam™ Spray 200, Fire Barrier 1000 NS Silicone Sealant and

Fire Barrier 1003 SL Silicone Sealant

ASTM E 2307

T-Rating Refer to Compression Percentage

F-Rating 2 hr

ASTM E 2307/ASTM E 1399 Cycling

Class IV: 500 cycles @ 30 cpm

Rated for ± 16.7% horizontal movement @ 50% Compression (Reference Item 3A): T-Rating 1/4 hr

Rated for ± 11% horizontal movement @ 33% Compression (Reference Item 3A): T-Rating 0 hr

Rated for ± 5% horizontal movement @ 20% Compression (Reference Item 3A): T-Rating 0 hr

Rated for ± 6.25% vertical shear movement @ 50% Compression (Reference Item 3A)

UL 2079

L-Rating <1.0 SCFM/LF

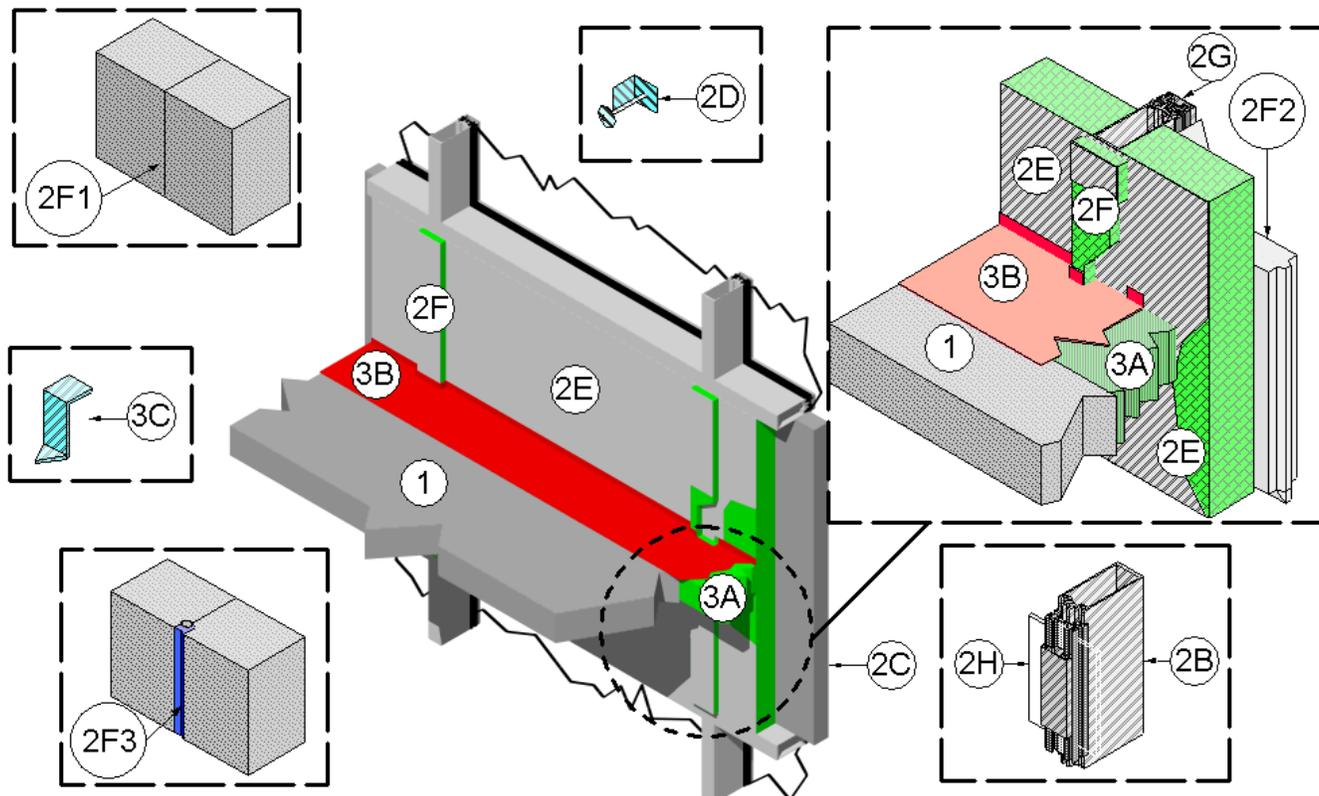

1. CONCRETE FLOOR ASSEMBLY: Two-hour rated concrete floor assembly made from either lightweight or normal weight concrete with a density of 100 to 150 pcf, having a minimum thickness of 4-1/2" at the joint face. When a longitudinal recess (blockout) is required to contain an architectural joint system, increase concrete floor assembly thickness to maintain a minimum thickness of 4-1/2" and accommodate depth of blockout formed in the concrete: blockout width unrestricted.
2. CURTAIN WALL ASSEMBLY: Incorporate the following construction features:
 - A. Mounting Attachment: (Not shown) Attach aluminum framing (Item 2B) to the structural framing according to the curtain wall manufacturer's instructions. When required, connect the mounting attachments to the joint face of the concrete floor assembly (Item 1) according to the curtain wall manufacturer's instructions. Limit distance between mounting attachments to maximum 120".
 - B. Aluminum Framing: Use rectangular aluminum tubing mullions and transoms, sized according to the curtain wall system manufacturer's guidelines. Minimum required framing dimensions, use 0.100" thick walls with minimum 6-1/2" depth and minimum 2-1/2" width. Space mullions minimum 56-1/2" oc and space transoms minimum 69" oc. Locate transoms at a height of 33" above the top surface of the concrete floor assembly (Item 1) as measured from the bottom of the transom.
 - C. Concrete Panels: Use any non-combustible exterior concrete based panels. Use minimum 1-1/2" thick, 12" high, 12" long panels. Attach concrete panels to aluminum framing (Item 2B) according to the curtain wall system manufacturer's requirements.
 - D. Impaling Pins: When used with curtain wall insulation (Item 2E), locate, size and install impaling pins according to the curtain wall system manufacturer's guidelines, or be a minimum 4-1/2" long, 12 GA pin attached to one of the following: a nominal 2" by 2" plate; a nominal 2" by 2" by 2" long angle; or can be directly attached to the aluminum framing (Item 2B) using a stud gun. Space impaling pins a maximum of 12" oc. Install impaling pins around the periphery of the curtain wall insulation (Item 2E) so that its interior face is flush with the interior face of the aluminum framing (Item 2B).

Design No. 3MU/JS 120-12 *continued*

Construction Joints

Perimeter Joint

- E. **Curtain Wall Insulation:** Use nominal 24" wide, 4" thick, 4-pcf density, 3" thick, 6-pcf density, or 2" thick, 8-pcf density, mineral wool batt insulation. Install curtain wall insulation by fitting in each stud cavity between aluminum framing (Item 2B) using clips, impaling pins (Item 2D), or friction fit by using a curtain wall insulation lengths at least 1/4" longer than the distance between aluminum framing (Item 2B). Maintain 1-1/4" air cavity between curtain wall insulation and concrete panels (Item 2C). Tightly compress together butt joints in the lengths of curtain wall insulation by using minimum 1/4" compression per piece of curtain wall insulation material. Tape all adjacent edges between curtain wall insulation, or between aluminum framing (Item 2B) and curtain wall insulation, with min. 4" wide pressure sensitive aluminum foil tape, centered over the seam. Locate horizontal seams in the curtain wall insulation at least 6" above or below the top surface of the perimeter joint protection (Item 3). Use only Intertek certified products meeting the above minimum requirements.
- F. **Concrete Panel Joint:** No through joints allowed. When required, the surface of the concrete panel joints can be sealed with gaskets or sealants. Use one of the following for vertical and horizontal concrete panel joints:
- I. flush type (butt joint) (Item 2F1),
 - II. key way type (tongue and groove) (Item 2F2), or
 - III. recessed (Item 2F3).
- G. **Framing Covers:** Make from strips of 1", 8 pcf density, mineral wool batt insulation faced on one side with aluminum foil scrim (vapor retarder), which is exposed to the room interior. Cut strips a minimum 1-1/2" wider than aluminum framing (Item 2B). Center framing covers over all aluminum framing (Item 2B) and secure using impaling pins (Item 2I). Do not pass framing covers through the perimeter joint protection (Item 3). Allow framing covers to abut the top and the bottom surfaces of the perimeter joint protection (Item 3) provided that no deformation occurs. Use only Intertek certified products meeting the above minimum requirements.
- H. **Glass Vision Panels:** When required, use optional glass vision panels a minimum 33" above the top surface of the floor assembly (Item 1). Install glass vision panels to curtain wall framing according to the curtain wall system manufacturer's guidelines. Use a minimum 1/4" thick, clear tempered glass with a nominal width and height as determined by the framing.
- I. **Window Gaskets:** When optional glass vision panels used, secure glass vision panels with a thermal break (thermal-set rubber extrusion).
- J. **Window Framing:** Use rectangular aluminum tubing mullions and transoms, sized according to the curtain wall system manufacturer's guidelines. Minimum required framing dimensions, use 0.100" thick walls with minimum 6-1/2" depth and minimum 2-1/2" width and window framing must be compatible with aluminum framing (2B). Locate window framing at least 33" above the top surface of the floor assembly.
3. **PERIMETER JOINT PROTECTION:** Do not exceed an 8" nominal joint width (joint width at installation). Incorporate the following construction features for the perimeter joint protection (also known as perimeter fire barrier system):
- A. **Packing Material:** Use a minimum 4" thick, 4 pcf density, mineral wool batt insulation installed with the fibers running parallel to the edge of concrete floor assembly (Item 1) and curtain wall assembly (Item 2). Cut packing material width to achieve required compression, refer below, when installed in the nominal joint width. Compress the packing material into the perimeter joint. Tightly compress together splices (butt joints) in the lengths of packing material by using minimum 1/4" compression per piece of packing material. When a spray coating is used, locate the top surface of the packing material flush with the top surface of the concrete floor assembly (Item 1). When the non-sag or self leveling silicone sealant is used, recess the top surface of the packing material 1/4" from the top surface of the concrete floor assembly (Item 1). Use only Intertek certified products meeting the above minimum requirements.
- I. When 50% compression is required cut the width of the packing material 2 times wider than the nominal joint width.
 - II. When 33% compression is required cut the width of the packing material 1.5 times wider than the nominal joint width.
 - III. When 20% compression is required cut the width of the packing material 1.25 times wider than the nominal joint width.
- B. **CERTIFIED COMPANY:** 3M Company
CERTIFIED PRODUCT: FireDam™ or Fire Barrier™
MODEL: FD Spray 200 (Elastomeric, Sprayable) or FB 1000 N/S Silicone Sealant (Non-sag) or FB 1003 S/L (Self Leveling) Sealant
Fill, Void or Cavity Material: Apply either spray coating or sealant over the packing material (Item 3A) as follows:
Spray Coating – Spray apply the liquid to cover the exposed top surface of the packing material (Item 3A) compressed and installed in the perimeter joint. Apply a minimum wet film thickness of 1/8" and overlap the spray coating a minimum 1/2" onto the adjacent curtain wall assembly (Item 2) and concrete floor assembly (Item 1). When the spraying process is stopped and the applied spray coating cures to an elastomeric film before installation process is restarted, then overlap the edge of the cured spray coating at least 1/8" with the liquid spray coating.
Sealant – Apply non-sag or self leveling sealant to cover the exposed surface of the packing material (Item 3A) compressed and installed in the perimeter joint. Apply minimum 1/4" thickness non-sag or self leveling sealant over the packing material (Item 3A) and finish flush with the top surface of the concrete floor assembly (Item 1).
- C. **Support Clips:** (Optional) Recommended for installations subject to vertical shear movement. Use standard 20 GA galvanized steel Z-shaped clips having the following nominal dimensions: 1" wide by 3" high with a 2" upper leg and a 3" lower leg.

This material was extracted and drawn by 3M Fire Protection Products from the 2012 Product Directory, © Intertek

JS

Design No. 3MU/JS 120-13 *continued*

Construction Joints

Perimeter Joint

- D. Impaling Pins: When used with curtain wall insulation (Item 2E), locate, size and install impaling pins according to the curtain wall system manufacturer's guidelines, or be a minimum 4-1/2" long, 12 GA pin attached to one of the following: a nominal 2" by 2" plate; a nominal 2" by 2" by 2" long angle; or can be directly attached to the steel stud framing (Item 2B) using a stud gun. Space impaling pins a maximum of 12" oc. Install impaling pins around the periphery of the curtain wall insulation (Item 2E) so that its interior face is flush with the interior face of the steel stud framing (Item 2B).
- E. Curtain Wall Insulation: Use nominal 24" wide, 4" thick, 4-pcf density, 3" thick, 6-pcf density, or 2" thick, 8-pcf density, mineral wool batt insulation. Install curtain wall insulation by fitting in each stud cavity between steel stud framing (Item 2B) using clips, impaling pins (Item 2D), or friction fit by using a curtain wall insulation lengths at least 1/4" longer than the distance between steel stud framing (Item 2B). Maintain 1-1/4" air cavity between curtain wall insulation and tilt-up panels (Item 2C). Completely fill the recess of the "C-shaped" steel stud framing (Item 2B) with curtain wall insulation. Tightly compress together butt joints in the lengths of curtain wall insulation by using minimum 1/4" compression per piece of curtain wall insulation material. Tape all adjacent edges between curtain wall insulation, or between steel stud framing (Item 2B) and curtain wall insulation, with min. 4" wide pressure sensitive aluminum foil tape, centered over the seam. Locate horizontal seams in the curtain wall insulation at least 6" above or below the top surface of the perimeter joint protection (Item 3). Use only Intertek certified products meeting the above minimum requirements.
- F. Concrete Panel Joint: No through joints allowed. When required, the surface of the concrete panel joints can be sealed with gaskets or sealants. Use one of the following for vertical and horizontal concrete panel joints:
- I. flush type (butt joint) (Item 2F1),
 - II. key way type (tongue and groove) (Item 2F2), or
 - III. recessed (Item 2F3).
- G. Framing Covers: Make from strips of 1", 8 pcf density, mineral wool batt insulation faced on one side with aluminum foil scrim (vapor retarder), which is exposed to the room interior. Cut strips a minimum 1-1/2" wider than steel stud framing (Item 2B). Center framing covers over all steel stud framing (Item 2B) and secure using impaling pins (Item 2D). Do not pass framing covers through the perimeter joint protection (Item 3). Allow framing covers to abut the top and the bottom surfaces of the perimeter joint protection (Item 3) provided that no deformation occurs. Use only Intertek certified products meeting the above minimum requirements.
- H. Glass Vision Panels: When required, use optional glass vision panels a minimum 33" above the top surface of the floor assembly (Item 1). Install glass vision panels to curtain wall framing according to the curtain wall system manufacturer's guidelines. Use a minimum 1/4" thick, clear tempered glass with a nominal width and height as determined by the framing.
- I. Window Gaskets: When optional glass vision panels used, secure glass vision panels with a thermal break (thermal-set rubber extrusion).
- J. Window Framing: When glass vision panels used, use steel framing members a minimum 3-5/8" by 1-5/8", 18 GA steel, U-shaped channel or similar construction compatible with structural framing (Item 2B). Locate window framing at least 33" above the top surface of the concrete floor assembly (Item 1).
3. PERIMETER JOINT PROTECTION: Do not exceed an 8" nominal joint width (joint width at installation). Incorporate the following construction features for the perimeter joint protection (also known as perimeter fire barrier system):
- A. Packing Material: Use a minimum 4" thick, 4 pcf density, mineral wool batt insulation installed with the fibers running parallel to the edge of concrete floor assembly (Item 1) and curtain wall assembly (Item 2). Cut packing material width to achieve required compression, refer below, when installed in the nominal joint width. Compress the packing material into the perimeter joint. Tightly compress together splices (butt joints) in the lengths of packing material by using minimum 1/4" compression per piece of packing material. When a spray coating is used, locate the top surface of the packing material flush with the top surface of the concrete floor assembly (Item 1). When the non-sag or self leveling silicone sealant is used, recess the top surface of the packing material 1/4" from the top surface of the concrete floor assembly (Item 1). Use only Intertek certified products meeting the above minimum requirements.
- I. When 50% compression is required cut the width of the packing material 2 times wider than the nominal joint width.
 - II. When 33% compression is required cut the width of the packing material 1.5 times wider than the nominal joint width.
 - III. When 20% compression is required cut the width of the packing material 1.25 times wider than the nominal joint width.
- B. CERTIFIED COMPANY: 3M Company
CERTIFIED PRODUCT: FireDam™ or Fire Barrier™
MODEL: FD Spray 200 (Elastomeric, Sprayable) or FB 1000 N/S Silicone Sealant (Non-sag) or FB 1003 S/L (Self Leveling)
Fill, Void or Cavity Material: Apply either spray coating or sealant over the packing material (Item 3A) as follows:
Spray Coating – Spray apply the liquid to cover the exposed top surface of the packing material (Item 3A) compressed and installed in the perimeter joint. Apply a minimum wet film thickness of 1/8" and overlap the spray coating a minimum 1/2" onto the adjacent curtain wall assembly (Item 2) and concrete floor assembly (Item 1). When the spraying process is stopped and the applied spray coating cures to an elastomeric film before installation process is restarted, then overlap the edge of the cured spray coating at least 1/8" with the liquid spray coating.
Sealant – Apply non-sag or self leveling sealant to cover the exposed surface of the packing material (Item 3A) compressed and installed in the perimeter joint. Apply minimum 1/4" thickness non-sag or self leveling sealant over the packing material (Item 3A) and finish flush with the top surface of the concrete floor assembly (Item 1).
- C. Support Clips: (Optional) Recommended for installations subject to vertical shear movement. Use standard 20 GA galvanized steel Z-shaped clips having the following nominal dimensions: 1" wide by 3" high with a 2" upper leg and a 3" lower leg.

This material was extracted and drawn by 3M Fire Protection Products from the 2012 Product Directory, © Intertek

JS

Design Number 3MU/JS 120-14

(Formerly OPL Design No. CEJ 159 P)

November 11, 2011

PERIMETER FIRE BARRIERS

3M Company

FireDam™ Spray 200, Fire Barrier 1000 NS Silicone Sealant and

Fire Barrier 1003 SL Silicone Sealant

ASTM E 2307

T-Rating Refer to Compression Percentage

F-Rating 2 hr

ASTM E 2307/ASTM E 1399 Cycling

Class IV: 500 cycles @ 30 cpm

Rated for ± 16.7% horizontal movement @ 50% Compression (Reference Item 3A): T-Rating 1/4 hr

Rated for ± 11% horizontal movement @ 33% Compression (Reference Item 3A): T-Rating 0 hr

Rated for ± 5% horizontal movement @ 20% Compression (Reference Item 3A): T-Rating 0 hr

Rated for ± 6.25% vertical shear movement @ 50% Compression (Reference Item 3A)

UL 2079

L-Rating <1.0 SCFM/LF

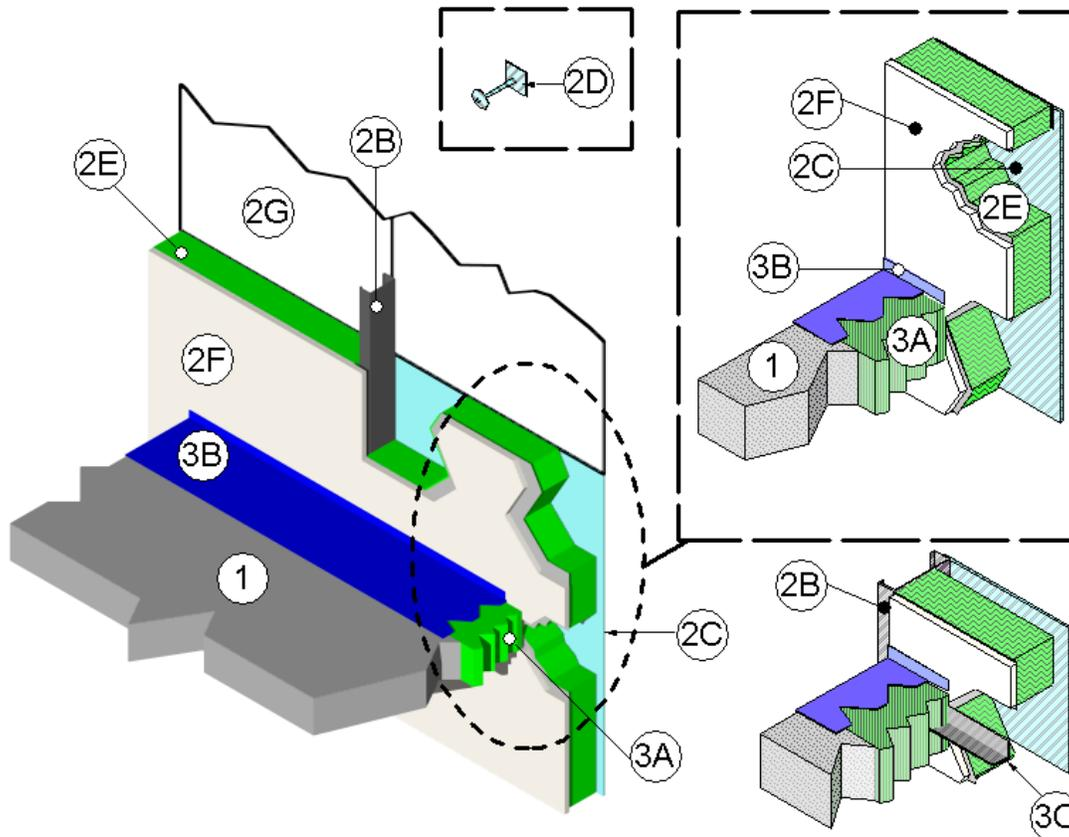

1. CONCRETE FLOOR ASSEMBLY: Two-hour rated concrete floor assembly made from either lightweight or normal weight concrete with a density of 100 to 150 pcf, having a minimum thickness of 4-1/2" at the joint face. When a longitudinal recess (blockout) is required to contain an architectural joint system, increase concrete floor assembly thickness to maintain a minimum thickness of 4-1/2" and accommodate depth of blockout formed in the concrete: blockout width unrestricted.
2. CURTAIN WALL ASSEMBLY: Incorporate the following construction features:
 - A. Mounting Attachment: (Not shown) Attach steel stud framing (Item 2B) to the structural framing according to the curtain wall manufacturer's instructions. When required, connect the mounting attachments to the joint face of the concrete floor assembly (Item 1) according to the curtain wall manufacturer's instructions. Limit distance between mounting attachments to maximum 120".
 - B. Steel Stud Framing: Use minimum 3-5/8" by 1-5/8", 18 GA, C-shaped steel studs as vertical framing. Attach according to the curtain wall system manufacturer's guidelines. Limit distance between vertical steel stud framing to maximum 48". Limit distance between horizontal steel stud framing to maximum 72". When required, install horizontal structural framing members according to the curtain wall system manufacturer's guidelines and, in the spandrel area, locate a minimum of 33" above the top surface of the concrete floor assembly (Item 1).
 - C. Steel Panels: Install steel panels to curtain wall framing according to the curtain wall system manufacturer's guidelines. Use a minimum 20 GA sheet steel panel with maximum dimensions of 48" wide x 144" high.
 - D. Impaling Pins: When used with curtain wall insulation (Item 2E), locate, size and install impaling pins according to the curtain wall system manufacturer's guidelines, or be a minimum 4-1/2" long, 12 GA pin attached to one of the following: a nominal 2" by 2" plate; a nominal 2" by 2" by 2" long angle; or can be directly attached to the steel stud framing (Item 2B) using a stud gun. Space impaling pins a maximum of 12" oc. Install impaling pins around the periphery of the curtain wall insulation (Item 2E) so that its interior face is flush with the interior face of the steel stud framing (Item 2B).

Design No. 3MU/JS 120-14 *continued*

Construction Joints

Perimeter Joint

- E. **Curtain Wall Insulation (Optional):** Use nominal 24" wide, 4" thick, 4-pcf density, 3" thick, 6-pcf density, or 2" thick, 8-pcf density, mineral wool batt insulation. Install curtain wall insulation by fitting in each stud cavity between steel stud framing (Item 2B) using clips, impaling pins (Item 2D), or friction fit by using a curtain wall insulation lengths at least 1/4" longer than the distance between steel stud framing (Item 2B). Completely fill the recess of the "C-shaped" steel stud framing (Item 2B) with curtain wall insulation. Tightly compress together butt joints in the lengths of curtain wall insulation by using minimum 1/4" compression per piece of curtain wall insulation material. Tape all adjacent edges between curtain wall insulation, or between steel stud framing (Item 2B) and curtain wall insulation, with min. 4" wide pressure sensitive aluminum foil tape, centered over the seam. Locate horizontal seams in the curtain wall insulation at least 6" above or below the top surface of the perimeter joint protection (Item 3). Use only Intertek certified products meeting the above minimum requirements.
- F. **Interior Curtain Wall Surface:** Continuously cover interior face of steel stud framing (Item 2B) with one layer of 5/8" thick, Type X gypsum board. Fasten gypsum board to steel stud framing (Item 2B) using minimum #6 1-1/8" long bugle-head phillips drywall screws spaced nominally 12" oc. Joint Tape and Compound – Apply vinyl or casein, dry or premixed joint compound to exposed face of gypsum board in two coats to all exposed screw heads and gypsum board joints. Embed minimum 2" wide paper, plastic, or fiberglass tape in first layer of premixed joint compound over joints in gypsum board. Create wall cavity between unexposed face of gypsum board to unexposed face of steel panel (Item 2C).
- G. **Glass Vision Panels:** When required, use optional glass vision panels a minimum 33" above the top surface of the floor assembly (Item 1). Install glass vision panels to curtain wall framing according to the curtain wall system manufacturer's guidelines. Use a minimum 1/4" thick, clear tempered glass with a nominal width and height as determined by the framing.
- H. **Window Gaskets:** (Not shown) When optional glass vision panels used, secure glass vision panels with a thermal break (thermal-set rubber extrusion).
- I. **Window Framing:** When glass vision panels used, use steel framing members a minimum 3-5/8" by 1-5/8", 18 GA steel, U-shaped channel or similar construction compatible with structural framing (Item 2B). Locate window framing at least 33" above the top surface of the concrete floor assembly (Item 1).
3. **PERIMETER JOINT PROTECTION:** Do not exceed an 8" nominal joint width (joint width at installation). Incorporate the following construction features for the perimeter joint protection (also known as perimeter fire barrier system):
- A. **Packing Material:** Install reinforcing angle (Item 3C). Use a minimum 4" thick, 4-pcf density, mineral wool batt insulation installed with the fibers running parallel to the edge of concrete floor assembly (Item 1) and curtain wall assembly (Item 2). Cut packing material width to achieve required compression, refer below, when installed in the nominal joint width. Compress the packing material into the perimeter joint. Tightly compress together splices (butt joints) in the lengths of packing material by using minimum 1/4" compression per piece of packing material. When a spray coating is used, locate the top surface of the packing material flush with the top surface of the concrete floor assembly (Item 1). When the non-sag or self leveling silicone sealant is used, recess the top surface of the packing material 1/4" from the top surface of the concrete floor assembly (Item 1). Use only Intertek certified products meeting the above minimum requirements.
- I. When 50% compression is required cut the width of the packing material 2 times wider than the nominal joint width.
- II. When 33% compression is required cut the width of the packing material 1.5 times wider than the nominal joint width.
- III. When 20% compression is required cut the width of the packing material 1.25 times wider than the nominal joint width.
- B. **CERTIFIED COMPANY:** 3M Company
CERTIFIED PRODUCT: FireDam™ or Fire Barrier™
MODEL: FD Spray 200 (Elastomeric, Sprayable) or FB 1000 N/S Silicone Sealant (Non-sag) or FB 1003 S/L (Self Leveling)
Fill, Void or Cavity Material: Apply either spray coating or sealant over the packing material (Item 3A) as follows:
Spray Coating – Spray apply the liquid to cover the exposed top surface of the packing material (Item 3A) compressed and installed in the perimeter joint. Apply a minimum wet film thickness of 1/8" and overlap the spray coating a minimum 1/2" onto the adjacent curtain wall assembly (Item 2) and concrete floor assembly (Item 1). When the spraying process is stopped and the applied spray coating cures to an elastomeric film before installation process is restarted, then overlap the edge of the cured spray coating at least 1/8" with the liquid spray coating.
Sealant – Apply non-sag or self leveling sealant to cover the exposed surface of the packing material (Item 3A) compressed and installed in the perimeter joint. Apply minimum 1/4" thickness non-sag or self leveling sealant over the packing material (Item 3A) and finish flush with the top surface of the concrete floor assembly (Item 1).
- C. **Reinforcing Angle:** Position reinforcing angle against interior curtain wall surface (Item 2I) and mechanically attach with minimum #8, 1-1/2" long screws at each vertical steel stud framing (Item 2B), install a nominal 1-1/2 by 1-1/2", 20 gauge, steel angle at mid depth of the packing material (Item 3A) and running perpendicular to the vertical steel stud framing (Item 2B).

This material was extracted and drawn by 3M Fire Protection Products from the 2012 Product Directory, © Intertek

JS

Design Number 3MU/JS 120-15

(Formerly OPL Design No. CEJ 163 P)

November 14, 2011

PERIMETER FIRE BARRIERS

3M Company

FireDam™ Spray 200, Fire Barrier 1000 NS Silicone Sealant and

Fire Barrier 1003 SL Silicone Sealant

ASTM E 2307

T-Rating 0 hr

F-Rating 2 hr

ASTM E 2307/ASTM E 1399 Cycling

Class IV: 500 cycles @ 30 cpm

Rated for ± 16.7% horizontal movement @ 25% Compression (Reference Item 3A)

UL 2079

L-Rating <1.0 SCFM/LF

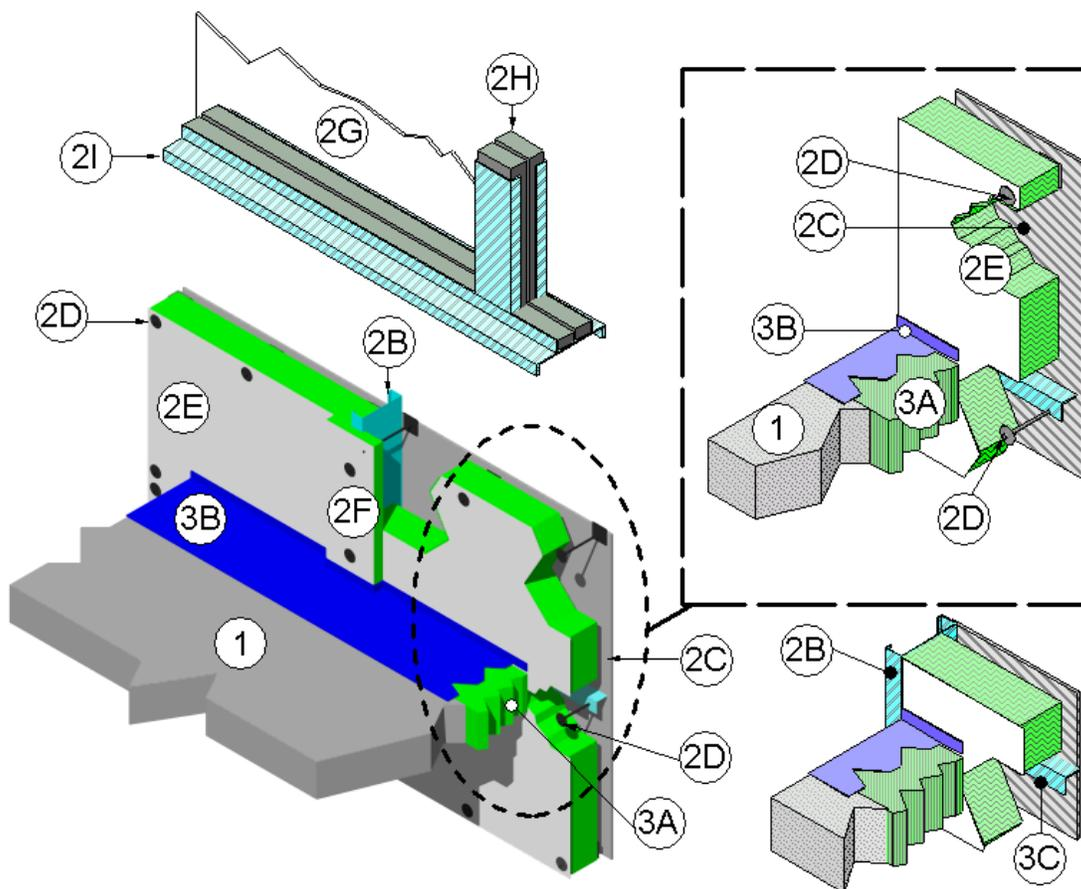

1. CONCRETE FLOOR ASSEMBLY: Two-hour rated concrete floor assembly made from either lightweight or normal weight concrete with a density of 100 to 150 pcf, having a minimum thickness of 4-1/2" at the joint face. When a longitudinal recess (blockout) is required to contain an architectural joint system, increase concrete floor assembly thickness to maintain a minimum thickness of 4-1/2" and accommodate depth of blockout formed in the concrete: blockout width unrestricted.
2. CURTAIN WALL ASSEMBLY: Incorporate the following construction features into the curtain wall assembly:
 - A. Panel Mounting Attachment: (Not shown) Install steel attachments to the tilt-up panels (Item 2C) and steel stud framing (Item 2B) according to the curtain wall manufacturer's instructions. When required, connect the steel mounting attachments to the joint face of the concrete floor assembly (Item 1) according to the curtain wall manufacturer's instructions. Limit distance between steel mounting attachments to maximum 120".
 - B. Steel Stud Framing: Use minimum 3-5/8" by 1-5/8", 18 GA, C-shaped steel studs as vertical framing. Attach according to the curtain wall system manufacturer's guidelines. Limit distance between vertical steel stud framing to maximum 48". Limit distance between horizontal steel stud framing to maximum 72". When required, install horizontal structural framing members according to the curtain wall system manufacturer's guidelines and, in the spandrel area, locate a minimum of 33" above the top surface of the concrete floor assembly (Item 1).
 - C. Aluminum Panels: Install minimum 1/8" thick aluminum panels with maximum dimensions of 48" by 144" to steel stud framing (Item 2B) according to the curtain wall system manufacturer's guidelines.
 - D. Impaling Pins: When used with curtain wall insulation (Item 2E), locate, size and install impaling pins according to the curtain wall system manufacturer's guidelines, or be a minimum 4-1/2" long, 12 GA pin attached to one of the following: a nominal 2" by 2" plate; a nominal 2" by 2" by 2" long angle; or can be directly attached to the steel stud framing (Item 2B) using a stud gun. Space impaling pins a maximum of 12" oc. Install impaling pins around the periphery of the curtain wall insulation (Item 2E) so that its interior face is flush with the interior face of the steel stud framing (Item 2B).

Design No. 3MU/JS 120-15 *continued*

Construction Joints

Perimeter Joint

- E. **Curtain Wall Insulation:** Use nominal 24" wide, 4" thick, 4-pcf density, 3" thick, 6-pcf density, or 2" thick, 8-pcf density, mineral wool batt insulation faced on one side with aluminum foil scrim (vapor retarder), which is exposed to the room interior and installed in the stud cavity. Install curtain wall insulation by fitting in each stud cavity between steel stud framing (Item 2B) using clips, impaling pins (Item 2D), or friction fit by using a curtain wall insulation lengths at least 1/4" longer than the distance between steel stud framing (Item 2B). Maintain 1-1/4" air cavity between curtain wall insulation and aluminum panels (Item 2C). Completely fill the recess of the "C-shaped" steel stud framing (Item 2B) with curtain wall insulation. Tightly compress together butt joints in the lengths of curtain wall insulation by using minimum 1/4" compression per piece of curtain wall insulation material. Tape all adjacent edges between curtain wall insulation, or between steel stud framing (Item 2B) and curtain wall insulation, with min. 4" wide pressure sensitive aluminum foil tape, centered over the seam. Locate horizontal seams in the curtain wall insulation at least 6" above or below the top surface of the perimeter joint protection (Item 3). Use only Intertek certified products meeting the above minimum requirements.
- F. **Framing Covers:** Make from strips of 1", 8 pcf density, mineral wool batt insulation faced on one side with aluminum foil scrim (vapor retarder), which is exposed to the room interior. Cut strips a minimum 1-1/2" wider than steel stud framing (Item 2B). Use only Intertek certified products meeting the above minimum requirements. Center framing covers over all steel stud framing (Item 2B) and secure using impaling pins (Item 2I). Do not pass framing covers through the perimeter joint protection (Item 3). Allow framing covers to abut the top and the bottom surfaces of the perimeter joint protection (Item 3) provided that no deformation occurs. Use only Intertek certified products meeting the above minimum requirements.
- G. **Glass Vision Panels:** When required, use optional glass vision panels a minimum 33" above the top surface of the floor assembly (Item 1). Install glass vision panels to curtain wall framing according to the curtain wall system manufacturer's guidelines. Use a minimum 1/4" thick, clear tempered glass with a nominal width and height as determined by the framing.
- H. **Window Gaskets:** When optional glass vision panels used, secure glass vision panels with a thermal break (thermo-set rubber extrusion).
- I. **Window Framing:** When glass vision panels used, use steel framing members a minimum 3-5/8" by 1-5/8", 18 GA steel, U-shaped channel or similar construction compatible with structural framing (Item 2B). Locate window framing at least 33" above the top surface of the floor assembly.
3. **PERIMETER JOINT PROTECTION:** Do not exceed an 8" nominal joint width (joint width at installation). Incorporate the following construction features for the perimeter joint protection (also known as perimeter fire barrier system):
- A. **Packing Material:** Install reinforcing angle (Item 3C). Use a minimum 4" thick, 4 pcf density, mineral wool batt insulation installed with the fibers running parallel to the edge of concrete floor assembly (Item 1) and curtain wall assembly (Item 2). Cut packing material width to achieve required compression, refer below, when installed in the nominal joint width. Compress the packing material into the perimeter joint. Tightly compress together splices (butt joints) in the lengths of packing material by using minimum 1/4" compression per piece of packing material. When a spray coating is used, locate the top surface of the packing material flush with the top surface of the concrete floor assembly (Item 1). When the non-sag or self leveling silicone sealant is used, recess the top surface of the packing material 1/4" from the top surface of the concrete floor assembly (Item 1). Use only Intertek certified products meeting the above minimum requirements.
- I. When 25% compression is required cut the width of the packing material 1.34 times wider than the nominal joint width.
- B. **CERTIFIED COMPANY:** 3M Company
CERTIFIED PRODUCT: FireDam™ or Fire Barrier™
MODEL: FD Spray 200 (Elastomeric, Sprayable) or FB 1000 N/S Silicone Sealant (Non-sag) or FB 1003 S/L (Self Leveling) Sealant
Fill, Void or Cavity Material: Apply either spray coating or sealant over the packing material (Item 3A) as follows:
Spray Coating – Spray apply the liquid to cover the exposed top surface of the packing material (Item 3A) compressed and installed in the perimeter joint. Apply a minimum wet film thickness of 1/8" and overlap the spray coating a minimum 1/2" onto the adjacent curtain wall assembly (Item 2) and concrete floor assembly (Item 1). When the spraying process is stopped and the applied spray coating cures to an elastomeric film before installation process is restarted, then overlap the edge of the cured spray coating at least 1/8" with the liquid spray coating.
Sealant – Apply non-sag or self leveling sealant to cover the exposed surface of the packing material (Item 3A) compressed and installed in the perimeter joint. Apply minimum 1/4" thickness non-sag or self leveling sealant over the packing material (Item 3A) and finish flush with the top surface of the concrete floor assembly (Item 1).
- C. **Reinforcing Angle:** Mount a minimum 1-1/2 x 1-1/2", 20 gauge, galvanized-steel angle to the steel stud framing (Item 2B) (vertical framing members) so that the vertical leg serves as a backer to the exterior face of the curtain wall insulation (Item 2E) and the horizontal leg extends away from the curtain wall insulation and is located at the centerline of the packing material (Item 3A). Size the angle 12" longer than the span between the interior edges of the steel stud framing (Item 2B) and form the angle so that it has a 6" vertical leg on each end. Secure the 6" vertical leg on each end to the steel stud framing (Item 2B) on each side with three #10 steel self-tapping sheet metal screws placed in a triangular fashion with a maximum spacing of 2" oc.

This material was extracted and drawn by 3M Fire Protection Products from the 2012 Product Directory, © Intertek

JS

Design Number 3MU/JS 120-16

(Formerly OPL Design No. CEJ 164 P)

November 14, 2011

PERIMETER FIRE BARRIERS

3M Company

FireDam™ Spray 200, Fire Barrier 1000 NS Silicone Sealant and

Fire Barrier 1003 SL Silicone Sealant

ASTM E 2307

T-Rating 0 hr

F-Rating 2 hr

ASTM E 2307/ASTM E 1399 Cycling

Class IV: 500 cycles @ 30 cpm

Rated for ± 16.7% horizontal movement @ 25% Compression (Reference Item 3A)

UL 2079

L-Rating <1.0 SCFM/LF

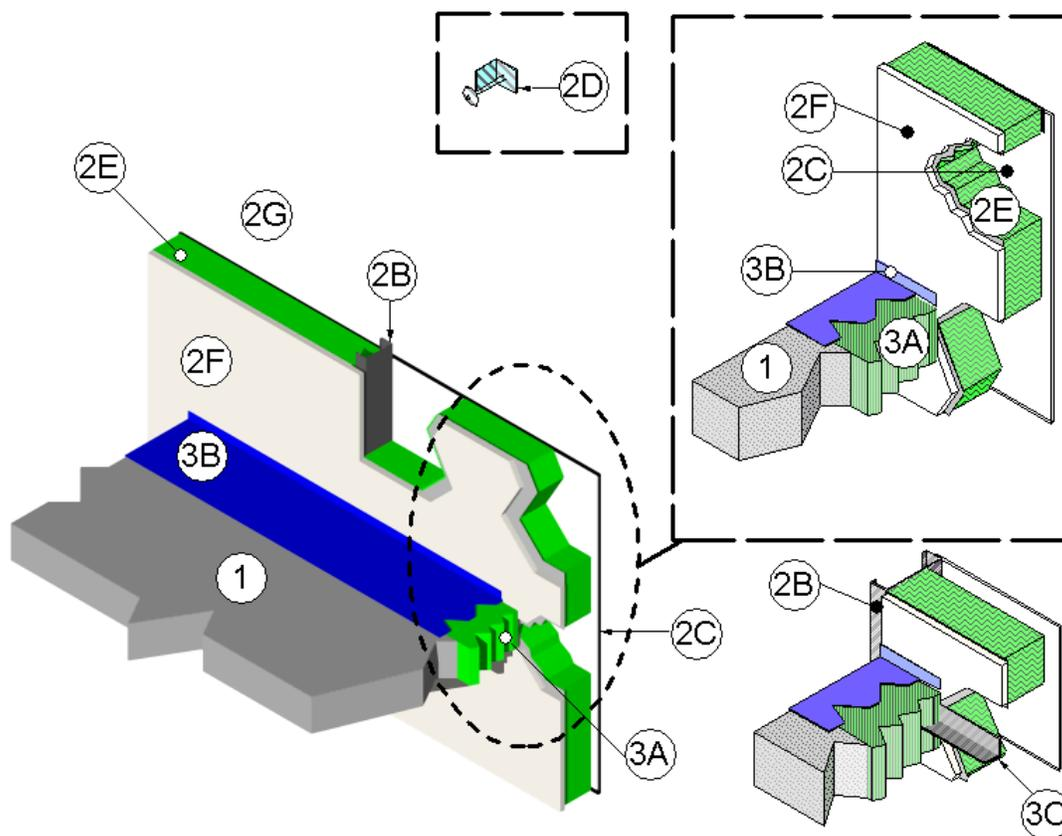

1. CONCRETE FLOOR ASSEMBLY: Two-hour rated concrete floor assembly made from either lightweight or normal weight concrete with a density of 100 to 150 pcf, having a minimum thickness of 4-1/2" at the joint face. When a longitudinal recess (blockout) is required to contain an architectural joint system, increase concrete floor assembly thickness to maintain a minimum thickness of 4-1/2" and accommodate depth of blockout formed in the concrete: blockout width unrestricted.
2. CURTAIN WALL ASSEMBLY: Incorporate the following construction features into the curtain wall assembly:
 - A. Panel Mounting Attachment: (Not shown) Install steel attachments to the structural framing (Item 2B) according to the curtain wall manufacturer's instructions. When required, connect the steel mounting attachments to the joint face of the concrete floor assembly (Item 1) according to the curtain wall manufacturer's instructions. Limit distance between steel mounting attachments to maximum 120".
 - B. Steel Stud Framing: Use minimum 3-5/8" by 1-5/8", 18 GA, C-shaped steel studs as vertical framing. Attach according to the curtain wall system manufacturer's guidelines. Limit distance between vertical steel stud framing to maximum 48". Limit distance between horizontal steel stud framing to maximum 72". When required, install horizontal structural framing members according to the curtain wall system manufacturer's guidelines and, in the spandrel area, locate a minimum of 33" above the top surface of the concrete floor assembly (Item 1).
 - C. Glass Panels: Sized and installed into steel framing (Item 2B) according to the curtain wall system manufacturer's guidelines. Use minimum 1/4" thick clear, heat strengthened (HS) glass or tempered glass with a maximum width and height less than the steel framing (Item 2B) oc spacing, which allows the glass to be secured between the notched shoulder of the steel framing (Item 2B) and pressure bar. Secure glass panels with a thermal break (rubber extrusion), pressure bar (aluminum extrusion), minimum 1/4-20 x 5/8" long screws, and a snap face (aluminum extrusion).
 - D. Impaling Pins: When used with curtain wall insulation (Item 2E), locate, size and install impaling pins according to the curtain wall system manufacturer's guidelines, or be a minimum 4-1/2" long, 12 GA pin attached to one of the following: a nominal 2" by 2" plate; a nominal 2" by 2" by 2" long angle; or can be directly attached to the steel stud framing (Item 2B) using a stud gun. Space impaling pins a maximum of 12" oc. Install impaling pins around the periphery of the curtain wall insulation (Item 2E) so that its interior face is flush with the interior face of the steel stud framing (Item 2B).

Design No. 3MU/JS 120-16 *continued*

Construction Joints

- E. **Curtain Wall Insulation:** Use nominal 24" wide, 4" thick, 4-pcf density, 3" thick, 6-pcf density, or 2" thick, 8-pcf density, mineral wool batt insulation. Install curtain wall insulation by fitting in each stud cavity between steel stud framing (Item 2B) using clips, impaling pins (Item 2D), or friction fit by using a curtain wall insulation lengths at least 1/4" longer than the distance between steel stud framing (Item 2B). Maintain 1-1/4" air cavity between curtain wall insulation and glass panels (Item 2C). Completely fill the recess of the "C-shaped" steel stud framing (Item 2B) with curtain wall insulation. Tightly compress together butt joints in the lengths of curtain wall insulation by using minimum 1/4" compression per piece of curtain wall insulation material. Tape all adjacent edges between curtain wall insulation, or between steel stud framing (Item 2B) and curtain wall insulation, with min. 4" wide pressure sensitive aluminum foil tape, centered over the seam. Locate horizontal seams in the curtain wall insulation at least 6" above or below the top surface of the perimeter joint protection (Item 3). Use only Intertek certified products meeting the above minimum requirements.
- F. **Interior Curtain Wall Surface:** Continuously cover interior face of steel stud framing (Item 2B) with one layer of 5/8" thick, Type X gypsum board. Fasten gypsum board to steel stud framing (Item 2B) using minimum #6 1-1/8" long bugle-head phillips drywall screws spaced nominally 12" oc. Joint Tape and Compound – Apply vinyl or casein, dry or premixed joint compound to exposed face of gypsum board in two coats to all exposed screw heads and gypsum board joints. Embed minimum 2" wide paper, plastic, or fiberglass tape in first layer of premixed joint compound over joints in gypsum board. Create wall cavity between unexposed face of gypsum board to unexposed face of steel panel (Item 2C).

Perimeter Joint

- 3. **PERIMETER JOINT PROTECTION:** Do not exceed an 8" nominal joint width (joint width at installation). Incorporate the following construction features for the perimeter joint protection (also known as perimeter fire barrier system):
 - A. **Packing Material:** Install reinforcing angle (Item 3C). Use a minimum 4" thick, 4-pcf density, mineral wool batt insulation installed with the fibers running parallel to the edge of concrete floor assembly (Item 1) and curtain wall assembly (Item 2). Cut packing material width to achieve required compression, refer below, when installed in the nominal joint width. Compress the packing material into the perimeter joint. Tightly compress together splices (butt joints) in the lengths of packing material by using minimum 1/4" compression per piece of packing material. When a spray coating is used, locate the top surface of the packing material flush with the top surface of the concrete floor assembly (Item 1). When the non-sag or self leveling silicone sealant is used, recess the top surface of the packing material 1/4" from the top surface of the concrete floor assembly (Item 1). Use only Intertek certified products meeting the above minimum requirements.
 - I. When 25% compression is required cut the width of the packing material 1.34 times wider than the nominal joint width.
 - B. **CERTIFIED COMPANY:** 3M Company
CERTIFIED PRODUCT: FireDam™ or Fire Barrier™
MODEL: FD Spray 200 (Elastomeric, Sprayable) or FB 1000 N/S Silicone Sealant (Non-sag) or FB 1003 S/L (Self Leveling)
Fill, Void or Cavity Material: Apply either spray coating or sealant over the packing material (Item 3A) as follows:
 - Spray Coating –** Spray apply the liquid to cover the exposed top surface of the packing material (Item 3A) compressed and installed in the perimeter joint. Apply a minimum wet film thickness of 1/8" and overlap the spray coating a minimum 1/2" onto the adjacent curtain wall assembly (Item 2) and concrete floor assembly (Item 1). When the spraying process is stopped and the applied spray coating cures to an elastomeric film before installation process is restarted, then overlap the edge of the cured spray coating at least 1/8" with the liquid spray coating.
 - Sealant –** Apply non-sag or self leveling sealant to cover the exposed surface of the packing material (Item 3A) compressed and installed in the perimeter joint. Apply minimum 1/4" thickness non-sag or self leveling sealant over the packing material (Item 3A) and finish flush with the top surface of the concrete floor assembly (Item 1).
 - C. **Reinforcing Angle:** Position reinforcing angle against interior curtain wall surface (Item 2F) and mechanically attach with minimum #8, 1-1/2" long screws at each vertical steel stud framing (Item 2B), install a nominal 1-1/2 by 1-1/2", 20 gauge, steel angle at mid depth of the packing material (Item 3A) and running perpendicular to the vertical steel stud framing (Item 2B).

This material was extracted and drawn by 3M Fire Protection Products from the 2012 Product Directory, © Intertek

JS

Design Number 3MU/JS 120-17

(Formerly OPL Design No. CEJ 266 P)
November 7, 2016

PERIMETER FIRE BARRIERS

3M Company
FireDam™ Spray 200, Fire Barrier Watertight Spray, Fire and Water Barrier Tape FWBT,
Fire Barrier 1000 NS Silicone Sealant and Fire Barrier 1003 SL Silicone Sealant

ASTM E 2307

T-Rating 3/4 hr
F-Rating 2 hr

ASTM E 2307/ASTM E 1399 Cycling

Class IV: 500 cycles @ 30 cpm

Rated for ± 10% horizontal movement @ 33% Compression (Reference Item 3A)
Rated for ± 6.25% vertical shear movement @ 33% Compression (Reference Item 3A)

UL 2079

L-Rating <1.0 SCFM/LF

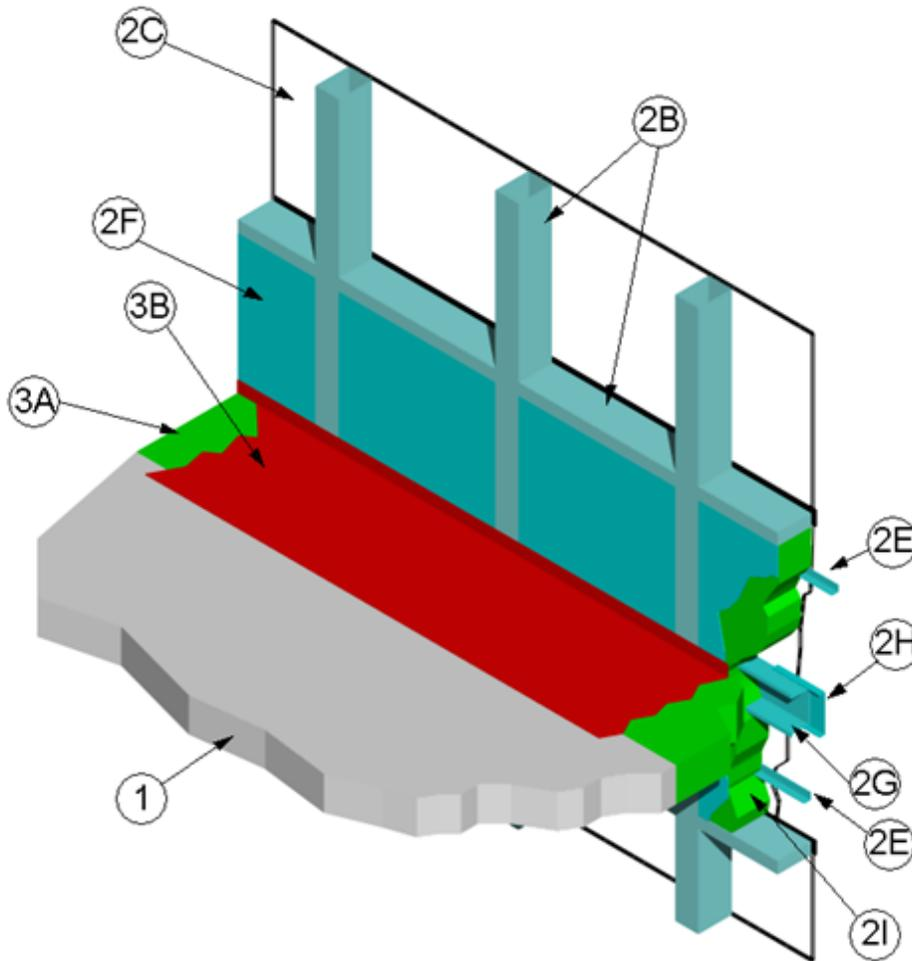

- CONCRETE FLOOR ASSEMBLY:** Two-hour rated concrete floor assembly made from either lightweight or normal weight concrete with a density of 100 to 150 pcf, having a min thickness of 4-1/2 in. at the joint face. When a longitudinal recess (blockout) is required to contain an architectural joint system, increase concrete floor assembly thickness to maintain a min thickness of 4-1/2 in. and accommodate depth of blockout formed in the concrete: blockout width unrestricted.
- CURTAIN WALL ASSEMBLY:** Incorporate the following construction features:
 - Mounting Attachment:** (Not shown) Attach aluminum framing (Item 2B) to the structural framing according to the curtain wall manufacturer's instructions. When required, connect the mounting attachments to the joint face of the concrete floor assembly (Item 1) according to the curtain wall manufacturer's instructions. Limit distance between mounting attachments to max 60 in. on center (oc).
 - Aluminum Framing:** Use hollow rectangular aluminum extruded tubing with min overall dimensions of 0.100 in. thick, 4 in. high and 2-1/2 in. wide. Locate mullions (vertical aluminum framing) minimum 60 in. oc and locate transoms (horizontal aluminum framing) a min 48-1/2 in. oc. For the spandrel region, locate the upper transom (horizontal aluminum framing) a min 20 in. above the concrete floor assembly (Item 1) as measured from the top surface of the concrete floor assembly (Item 1) to the underside of the transom (horizontal aluminum framing).
 - Glass Panels:** Sized and installed into aluminum framing (Item 2B) according to the curtain wall system manufacturer's guidelines. Use

Design No. 3MU/JS 120-17 *continued*

Construction Joints

Perimeter Joint

- min 1/4 in. thick clear, heat strengthened (HS) glass or tempered glass with a max width and height less than the aluminum framing (Item 2B) or spacing, which allows the glass to be secured between the notched shoulder of the aluminum framing (Item 2B) and pressure bar. Secure glass panels with a thermal break (rubber extrusion), pressure bar (aluminum extrusion), min 1/4-20 × 5/8 in. long screws, and a snap face (aluminum extrusion).
- D. Aluminum Anchor Brackets: (not shown) Use min 9/16 in. thick aluminum anchor brackets to serve as part of the mounting attachment (2A) and are rigidly secured to the aluminum framing (2B) with 1/2 in. diameter, 2-1/4 in. long, Grade 5, anchor bolts.
- E. Steel Retainer Angle – Place a min 22 GA, 1-1/2 in. × 1-1/2 in. angle horizontally 12 in. above and below the floor line in the spandrel area, and is secured to the aluminum framing (2B) with No. 10 sheet metal screws. Orient the angle so that the horizontal flange is below the vertical flange and situate the horizontal flange to fully embed into the curtain wall insulation of the steel back pan.
- F. Steel Backpan: Install min 22 GA, galvanized steel backpan filled with curtain wall insulation (2I) adhered to the back pan with latex adhesive and steel face facing the interior face of the aluminum framing in the spandrel region. Secure the backpan to the aluminum framing (2B) with 1 in. long, hex-head, sheet steel screws.
- G. Backpan Stiffener: Secure min 18 GA, galvanized, hat-shaped, stiffener placed horizontally and measuring 4 in. wide x 3 in. deep and having 1 in. flanges to the backpan with No. 10, sheet steel screws. Position the lower flange of the stiffener within the plane of the packing material (3A), and space the screw holding the top flange of the stiffener to the backpan (2F) a min of 2-7/32 in. above the top surface of the concrete floor assembly (Item 1).
- H. Steel Patches: Where required, horizontally place 6 in. wide, 22 GA, galvanized steel C-shaped patches measuring 6 in. wide and 1-1/2 in. deep, centered on the outside of the backpan stiffener (2G) and secure patches to the stiffener with No. 10, sheet steel screws.
- I. Curtain Wall Insulation: Fill the cavity of the steel backpan (Item 2F) with nominal 3 in. thick, 8-pcf density, mineral wool batt insulation faced on one side with aluminum foil scrim (vapor retarder), which faces the room interior. Tightly fit, compress at least 1/4 in. in all directions, the mineral wool batt insulation within the backpan (Item 2F) and adhere to the backpan with latex adhesive. Use only Intertek certified products meeting the above min requirements.
3. **PERIMETER JOINT PROTECTION:** Do not exceed an 6 in. nominal joint width (joint width at installation). Incorporate the following construction features for the perimeter joint protection (also known as perimeter fire barrier system):
- A. Packing Material: Use a min 4 in. thick, 4-pcf density, mineral wool batt insulation installed with the fibers running parallel to the edge of concrete floor assembly (Item 1) and curtain wall assembly (Item 2). Cut packing material width to achieve required compression, refer below, when installed in the nominal joint width. Compress the packing material into the perimeter joint. Tightly compress together splices (butt joints) in the lengths of packing material by using min 1/4 in. compression per piece of packing material. When a spray coating is used, locate the top surface of the packing material flush with the top surface of the concrete floor assembly (Item 1). When the non-sag or self-leveling silicone sealant is used, recess the top surface of the packing material 1/4 in. from the top surface of the concrete floor assembly (Item 1). Use only Intertek certified products meeting the above min requirements.
- i. When 33% compression is required cut the width of the packing material 1.5 times wider than the nominal joint width.
- B. CERTIFIED MANUFACTURER: 3M Company
CERTIFIED PRODUCT: FireDam™ or Fire Barrier™
MODEL: FD Spray 200 (Elastomeric, Sprayable) Fire Barrier Watertight Spray (Elastomeric, Sprayable) or Fire and Water Barrier Tape FWBT (Tape) or FB 1000 N/S Silicone Sealant (Non-sag) or FB 1003 S/L (Self Leveling)
- Fill, Void or Cavity Material: Apply either spray coating or sealant over the packing material (Item 3A) as follows:
- Spray Coating – Spray apply the liquid to cover the exposed top surface of the packing material (Item 3A) compressed and installed in the perimeter joint. Apply a min wet film thickness of 1/8 in. and overlap the spray coating a min 1/2 in. onto the adjacent curtain wall assembly (Item 2) and concrete floor assembly (Item 1). When the spraying process is stopped and the applied spray coating cures to an elastomeric film before installation process is restarted, then overlap the edge of the cured spray coating at least 1/8 in. with the liquid spray coating.
- Tape – Apply the tape such that there is a min 1 in. overlap onto the adjacent curtain wall assembly (Item 2) and the concrete floor assembly (Item 1). Overlap joints in the tape system by 1/2 in.
- Sealant – Apply non-sag or self leveling sealant to cover the exposed surface of the packing material (Item 3A) compressed and installed in the perimeter joint. Apply min 1/4 in. thickness non-sag or self leveling sealant over the packing material (Item 3A) and finish flush with the top surface of the concrete floor assembly (Item 1).
- C. Support Clips: (Optional) Recommended for installations subject to vertical shear movement. Use standard 20 GA galvanized steel Z-shaped clips having the following nominal dimensions: 1 in. wide by 3 in. high with a 2 in. upper leg and a 3 in. lower leg.

This material was extracted and drawn by 3M Fire Protection Products from the 2016 Product Directory, © Intertek

JS

Design Number 3MU/JS 120-18

(Formerly OPL Design No. CEJ 267 P)

November 14, 2011

PERIMETER FIRE BARRIERS

3M Company

FireDam™ Spray 200, Fire Barrier 1000 NS Silicone Sealant and

Fire Barrier 1003 SL Silicone Sealant

ASTM E 2307

T-Rating 3/4 hr

F-Rating 2 hr

ASTM E 2307/ASTM E 1399 Cycling

Class IV: 500 cycles @ 30 cpm

Rated for ± 10% horizontal movement @ 33% Compression (Reference Item 3A)

Rated for ± 6.25% vertical shear movement @ 33% Compression (Reference Item 3A)

UL 2079

L-Rating <1.0 SCFM/LF

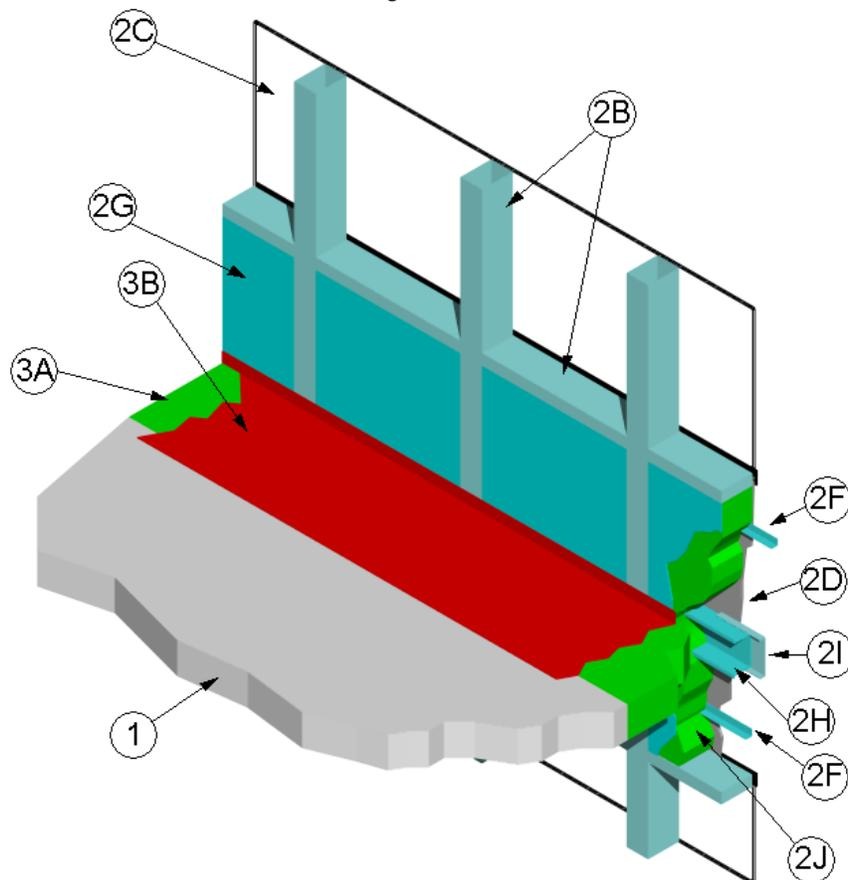

1. CONCRETE FLOOR ASSEMBLY: Two-hour rated concrete floor assembly made from either lightweight or normal weight concrete with a density of 100 to 150 pcf, having a minimum thickness of 4-1/2" at the joint face. When a longitudinal recess (blockout) is required to contain an architectural joint system, increase concrete floor assembly thickness to maintain a minimum thickness of 4-1/2" and accommodate depth of blockout formed in the concrete: blockout width unrestricted.
2. CURTAIN WALL ASSEMBLY: Incorporate the following construction features:
 - A. Mounting Attachment: (Not shown) Attach aluminum framing (Item 2B) to the structural framing according to the curtain wall manufacturer's instructions. When required, connect the mounting attachments to the joint face of the concrete floor assembly (Item 1) according to the curtain wall manufacturer's instructions. Limit distance between mounting attachments to maximum 60".
 - B. Aluminum Framing: Use hollow rectangular aluminum extruded tubing with minimum overall dimensions of 0.100" thick, 4" high and 2-1/2" wide. Locate mullions (vertical aluminum framing) minimum 60" oc and locate transoms (horizontal aluminum framing) a minimum 48-1/2" oc. For the spandrel region, locate the upper transom (horizontal aluminum framing) a minimum 20" above the concrete floor assembly (Item 1) as measured from the top surface of the concrete floor assembly (Item 1) to the underside of the transom (horizontal aluminum framing).
 - C. Glass Panels: Sized and installed into aluminum framing (Item 2B) according to the curtain wall system manufacturer's guidelines. Use minimum 1/4" thick clear, heat strengthened (HS) glass or tempered glass with a maximum width and height less than the aluminum framing (Item 2B) oc spacing, which allows the glass to be secured between the notched shoulder of the aluminum framing (Item 2B) and pressure bar. Secure glass panels with a thermal break (rubber extrusion), pressure bar (aluminum extrusion), minimum 1/4-20 x 5/8" long screws, and a snap face (aluminum extrusion).
 - D. Aluminum Spandrel Panel: Use minimum 1/8" thick, aluminum spandrel panel, having a minimum height of 48-1/2" and a minimum width of 60" as determined by the mullion and transom spacing. Span the aluminum spandrel panel across the spandrel area and mechanically secure it to the aluminum framing members (Item 2B), in accordance with the manufacturer's instructions

Design No. 3MU/JS 120-18 *continued*

Construction Joints

Perimeter Joint

- E. Aluminum Anchor Brackets: (not shown) Use minimum 9/16" thick aluminum anchor brackets to serve as part of the mounting attachment (2A) and are rigidly secured to the aluminum framing (2B) with 1/2" diameter, 2-1/4" long, Grade 5, anchor bolts.
 - F. Steel Retainer Angle – Place a minimum 22 GA, 1-1/2 x 1-1/2" angle horizontally 12" above and below the floor line in the spandrel area, and is secured to the aluminum framing (2B) with No. 10 sheet metal screws. Orient the angle so that the horizontal flange is below the vertical flange and situate the horizontal flange to fully embed into the curtain wall insulation of the steel back pan.
 - G. Steel Backpan: Install minimum 22 GA, galvanized steel backpan filled with curtain wall insulation (2I) adhered to the back pan with latex adhesive and steel face facing the interior face of the aluminum framing in the spandrel region. Secure the backpan to the aluminum framing (2B) with 1" long, hex-head, sheet steel screws.
 - H. Backpan Stiffener: Secure minimum 18 GA, galvanized, hat-shaped, stiffener placed horizontally and measuring 4" wide x 3" deep and having 1" flanges to the backpan with No. 10, sheet steel screws. Position the lower flange of the stiffener within the plane of the packing material (3A), and space the screw holding the top flange of the stiffener to the backpan (2F) a minimum of 2-7/32" above the top surface of the concrete floor assembly (Item 1).
 - I. Steel Patches: Where required, horizontally place 6" wide, 22 GA, galvanized steel C-shaped patches measuring 6" wide and 1-1/2" deep, centered on the outside of the backpan stiffener (2G) and secure patches to the stiffener with No. 10, sheet steel screws.
 - J. Curtain Wall Insulation: Fill the cavity of the steel backpan (Item 2F) with nominal 3" thick, 8-pcf density, mineral wool batt insulation faced on one side with aluminum foil scrim (vapor retarder), which faces the room interior. Tightly fit, compress at least 1/4" in all directions, the mineral wool batt insulation within the backpan (Item 2F) and adhere to the backpan with latex adhesive. Use only Intertek certified products meeting the above minimum requirements.
3. PERIMETER JOINT PROTECTION: Do not exceed a 6" nominal joint width (joint width at installation). Incorporate the following construction features for the perimeter joint protection (also known as perimeter fire barrier system):
- A. Packing Material: Use a minimum 4" thick, 4-pcf density, mineral wool batt insulation installed with the fibers running parallel to the edge of concrete floor assembly (Item 1) and curtain wall assembly (Item 2). Cut packing material width to achieve required compression, refer below, when installed in the nominal joint width. Compress the packing material into the perimeter joint. Tightly compress together splices (butt joints) in the lengths of packing material by using minimum 1/4" compression per piece of packing material. When a spray coating is used, locate the top surface of the packing material flush with the top surface of the concrete floor assembly (Item 1). When the non-sag or self leveling silicone sealant is used, recess the top surface of the packing material 1/4" from the top surface of the concrete floor assembly (Item 1). Use only Intertek certified products meeting the above minimum requirements.
 - i. When 33% compression is required cut the width of the packing material 1.5 times wider than the nominal joint width.
 - B. CERTIFIED MANUFACTURER: 3M Company
CERTIFIED PRODUCT: FireDam™ or Fire Barrier™
MODEL: FD Spray 200 (Elastomeric, Sprayable) or FB 1000 N/S Silicone Sealant (Non-sag) or FB 1003 S/L (Self Leveling) Sealant
Fill, Void or Cavity Material: Apply either spray coating or sealant over the packing material (Item 3A) as follows:
Spray Coating – Spray apply the liquid to cover the exposed top surface of the packing material (Item 3A) compressed and installed in the perimeter joint. Apply a minimum wet film thickness of 1/8" and overlap the spray coating a minimum 1/2" onto the adjacent curtain wall assembly (Item 2) and concrete floor assembly (Item 1). When the spraying process is stopped and the applied spray coating cures to an elastomeric film before installation process is restarted, then overlap the edge of the cured spray coating at least 1/8" with the liquid spray coating.
Sealant – Apply non-sag or self leveling sealant to cover the exposed surface of the packing material (Item 3A) compressed and installed in the perimeter joint. Apply minimum 1/4" thickness non-sag or self leveling sealant over the packing material (Item 3A) and finish flush with the top surface of the concrete floor assembly (Item 1).
 - C. Support Clips: (Optional) Recommended for installations subject to vertical shear movement. Use standard 20 GA galvanized steel Z-shaped clips having the following nominal dimensions: 1" wide by 3" high with a 2" upper leg and a 3" lower leg.

This material was extracted and drawn by 3M Fire Protection Products from the 2012 Product Directory, © Intertek

JS

Design Number 3MU/JS 120-19

(Formerly OPL Design No. CEJ 288 P)

May 2, 2012

PERIMETER FIRE BARRIERS

3M Company

FireDam™ Spray 200, Fire Barrier 1000 NS Silicone Sealant and

Fire Barrier 1003 SL Silicone Sealant

ASTM E 2307

T-Rating Refer to Compression Percentage

F-Rating 2 hr

ASTM E 2307/ASTM E 1399 Cycling

Class IV: 500 cycles @ 30 cpm

Rated for ± 16.7% horizontal movement @ 50% Compression (Reference Item 3A): T-Rating 1/4 hr

Rated for ± 11% horizontal movement @ 33% Compression (Reference Item 3A): T-Rating 0 hr

Rated for ± 5% horizontal movement @ 20% Compression (Reference Item 3A): T-Rating 0 hr

Rated for ± 6.25% vertical shear movement @ 50% Compression (Reference Item 3A)

UL 2079

L-Rating <1.0 SCFM/LF

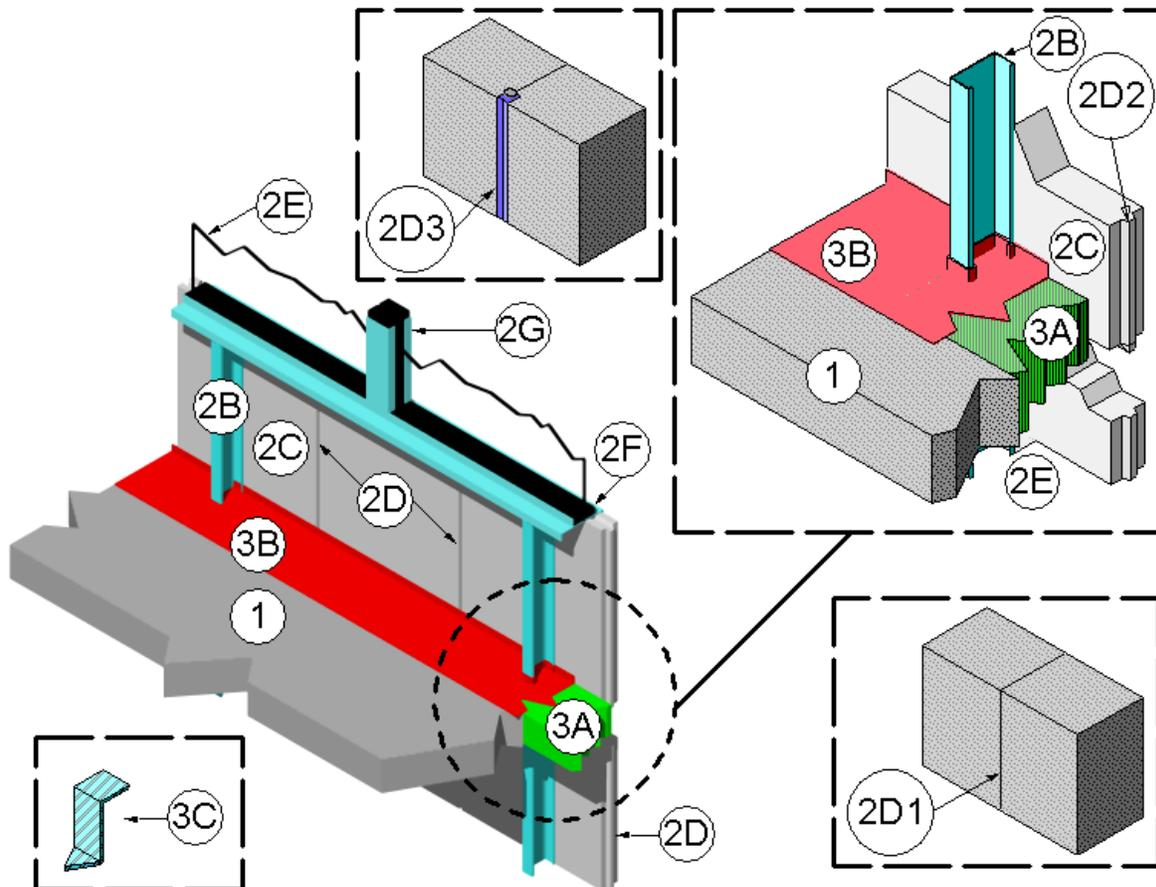

1. CONCRETE FLOOR ASSEMBLY: Two-hour rated concrete floor assembly made from either lightweight or normal weight concrete with a density of 100 to 150 pcf, having a minimum thickness of 4-1/2 in. at the joint face. When a longitudinal recess (blockout) is required to contain an architectural joint system, increase concrete floor assembly thickness to maintain a minimum thickness of 4-1/2 in. and accommodate depth of blockout formed in the concrete: blockout width unrestricted.
2. CURTAIN WALL ASSEMBLY: Incorporate the following construction features:
 - A. Mounting Attachment: (Not shown) Attach steel stud framing (Item 2B) to the structural framing according to the curtain wall manufacturer's instructions. When required, connect the mounting attachments to the joint face of the concrete floor assembly (Item 1) according to the curtain wall manufacturer's instructions. Limit distance between mounting attachments to maximum 120 in..
 - B. Steel Stud Framing: Use minimum 3-5/8 in. by 1-5/8 in., 18 GA, C-shaped steel studs as interior vertical framing. Attach according to the curtain wall system manufacturer's guidelines. Limit distance between steel stud framing to maximum 60 in.. When required, install horizontal steel stud framing members according to the curtain wall system manufacturer's guidelines and, in the spandrel area, locate a minimum of 33 in. above the top surface of the concrete floor assembly (Item 1).
 - C. Concrete Panels: Use any non-combustible exterior concrete based panels. Use minimum 1-1/2 in. thick, 12 in. high, 12 in. long panels. Attach concrete panels to steel stud framing (Item 2B) according to the curtain wall system manufacturer's requirements. Option – Treat the exterior side of the concrete panels with any weatherproofing material Listed as a Class 1 material in accordance with ASTM E-84. Use only Intertek certified products meeting these minimum requirements
 - D. Concrete Panel Joint: Through joints not recommended. When required, the surface of the concrete panel joints can be sealed with gaskets or sealants. Use one of the following for vertical and horizontal concrete panel joints:

Design No. 3MU/JS 120-19 *continued*

Construction Joints

Perimeter Joint

I. CERTIFIED MANUFACTURER: 3M Company

CERTIFIED PRODUCT: Fire Barrier™ Sealant

MODEL: CP25WB+

Flush type (butt joint) (Item 2F1), Prefer butted joints but allow a maximum 1 in. joint width for vertical and horizontal concrete panel joints. When through void or space exists between panels, the void in the spandrel region must be treated by packing a minimum 4 pcf density, mineral wool into the joint to a minimum 33% compression (1-1/2 times width of opening), filling the entire void or space. Recess the mineral wool a minimum of 1/2 in. from each side of the wall. Install a minimum 1/2 in. thickness of 3M CP25WB+ firestop caulk on the internal surface of the wall assembly (Item 2). Use only Intertek certified products meeting these minimum requirements

II. key way type (tongue and groove) (Item 2F2), or

III. recessed (Item 2F3).

E. Glass Vision Panels: When required, use optional glass vision panels a minimum 33 in. above the top surface of the floor assembly (Item 1). Install glass vision panels to curtain wall framing according to the curtain wall system manufacturer's guidelines. Use a minimum 1/4 in. thick, clear tempered glass with a nominal width and height as determined by the framing.

F. Window Gaskets: When optional glass vision panels used, secure glass vision panels with a thermal break (thermo-set rubber extrusion).

G. Window Framing: When glass vision panels used, use steel framing members a minimum 3-5/8 in. by 1-5/8 in., 18 GA steel, U-shaped channel or similar construction compatible with structural framing (Item 2B). Locate window framing at least 33 in. above the top surface of the floor assembly.

3. PERIMETER JOINT PROTECTION: Do not exceed an 8 in. nominal joint width (joint width at installation). Incorporate the following construction features for the perimeter joint protection (also known as perimeter fire barrier system):

A. Packing Material: Use a minimum 4 in. thick, 4-pcf density, mineral wool batt insulation installed with the fibers running parallel to the edge of concrete floor assembly (Item 1) and curtain wall assembly (Item 2). Cut packing material width to achieve required compression, refer below, when installed in the nominal joint width. Compress the packing material into the perimeter joint. Tightly compress together splices (butt joints) in the lengths of packing material by using minimum 1/4 in. compression per piece of packing material. When a spray coating is used, locate the top surface of the packing material flush with the top surface of the concrete floor assembly (Item 1). When the non-sag or self leveling silicone sealant is used, recess the top surface of the packing material 1/4 in. from the top surface of the concrete floor assembly (Item 1). Use only Intertek certified products meeting the above minimum requirements.

I. When 50% compression is required cut the width of the packing material 2 times wider than the nominal joint width.

II. When 33% compression is required cut the width of the packing material 1.5 times wider than the nominal joint width.

III. When 20% compression is required cut the width of the packing material 1.25 times wider than the nominal joint width.

B. CERTIFIED MANUFACTURER: 3M Company

CERTIFIED PRODUCT: FireDam™ or Fire Barrier™

MODEL: FD Spray 200 (Elastomeric, Sprayable) or FB 1000 N/S Silicone Sealant (Non-sag) or FB 1003 S/L (Self Leveling) Sealant

Fill, Void or Cavity Material: Apply either spray coating or non-sag or self leveling silicone sealant over the packing material (Item 3A) as follows:

Spray Coating – Spray apply the liquid to cover the exposed top surface of the packing material (Item 3A) compressed and installed in the perimeter joint. Apply a minimum wet film thickness of 1/8 in. and overlap the spray coating a minimum 1/2 in. onto the adjacent curtain wall assembly (Item 2) and concrete floor assembly (Item 1). When the spraying process is stopped and the applied spray coating cures to an elastomeric film before installation process is restarted, then overlap the edge of the cured spray coating at least 1/8 in. with the liquid spray coating.

Sealant – Apply non-sag or self leveling sealant to cover the exposed surface of the packing material (Item 3A) compressed and installed in the perimeter joint. Apply minimum 1/4 in. thickness non-sag or self leveling sealant over the packing material (Item 3A) and finish flush with the top surface of the concrete floor assembly (Item 1).

C. Support Clips: (Optional) Recommended for installations subject to vertical shear movement. Use standard 20 GA galvanized steel Z-shaped clips having the following nominal dimensions: 1 in. wide by 3 in. high with a 2 in. upper leg and a 3 in. lower leg.

This material was extracted and drawn by 3M Fire Protection Products from the 2012 Product Directory, © Intertek

JS

Design Number 3MU/JS 120-20

(Formerly OPL Design No. CEJ 289 P)

May 2, 2012

PERIMETER FIRE BARRIERS

3M Company

FireDam™ Spray 200, Fire Barrier 1000 NS Silicone Sealant and

Fire Barrier 1003 SL Silicone Sealant

ASTM E 2307

T-Rating Refer to Compression Percentage

F-Rating 2 hr

ASTM E 2307/ASTM E 1399 Cycling

Class IV: 500 cycles @ 30 cpm

Rated for ± 16.7% horizontal movement @ 50% Compression (Reference Item 3A): T-Rating 1/4 hr

Rated for ± 11% horizontal movement @ 33% Compression (Reference Item 3A): T-Rating 0 hr

Rated for ± 5% horizontal movement @ 20% Compression (Reference Item 3A): T-Rating 0 hr

Rated for ± 6.25% vertical shear movement @ 50% Compression (Reference Item 3A)

UL 2079

L-Rating <1.0 SCFM/LF

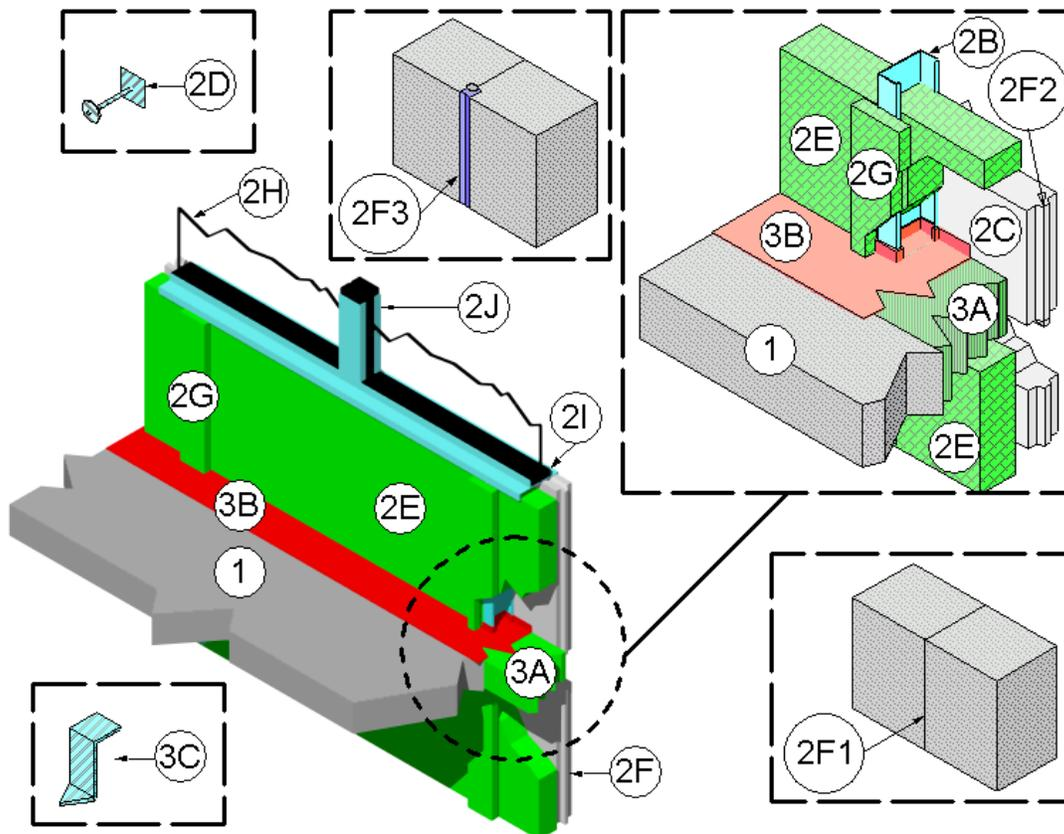

1. CONCRETE FLOOR ASSEMBLY: Two-hour rated concrete floor assembly made from either lightweight or normal weight concrete with a density of 100 to 150 pcf, having a minimum thickness of 4-1/2 in. at the joint face. When a longitudinal recess (blockout) is required to contain an architectural joint system, increase concrete floor assembly thickness to maintain a minimum thickness of 4-1/2 in. and accommodate depth of blockout formed in the concrete: blockout width unrestricted.
2. CURTAIN WALL ASSEMBLY: Incorporate the following construction features:
 - A. Mounting Attachment: (Not shown) Attach steel stud framing (Item 2B) to the structural framing according to the curtain wall manufacturer's instructions. When required, connect the mounting attachments to the joint face of the concrete floor assembly (Item 1) according to the curtain wall manufacturer's instructions. Limit distance between mounting attachments to maximum 120 in..
 - B. Steel Stud Framing: Use minimum 3-5/8 in. by 1-5/8 in., 18 GA, C-shaped steel studs as interior vertical framing. Attach according to the curtain wall system manufacturer's guidelines. Limit distance between steel stud framing to maximum 60 in.. When required, install horizontal steel stud framing members according to the curtain wall system manufacturer's guidelines and, in the spandrel area, locate a minimum of 33 in. above the top surface of the concrete floor assembly (Item 1).
 - C. Concrete Panels: Use any non-combustible exterior concrete based panels. Use minimum 1-1/2 in. thick, 12 in. high, 12 in. long panels. Attach concrete panels to steel stud framing (Item 2B) according to the curtain wall system manufacturer's requirements. Option – Treat the exterior side of the concrete panels with any weatherproofing material Listed as a Class 1 material in accordance with ASTM E-84. Use only Intertek certified products meeting these minimum requirements
 - D. Impaling Pins: (Optional) Use, locate, size, and install impaling pins according to the curtain wall system manufacturer's guidelines.
 - E. Curtain Wall Insulation: (Optional) When used, install either mineral wool or fiberglass batt curtain wall insulation after the perimeter joint protection (Item 3) without deforming it. Attach curtain wall insulation to steel stud framing (Item 2B) by friction fit or mechanical fasteners.

Design No. 3MU/JS 120-20 *continued*

Construction Joints

Perimeter Joint

- F. Concrete Panel Joint: No through joints allowed. When required, the surface of the concrete panel joints can be sealed with gaskets or sealants. Use one of the following for vertical and horizontal concrete panel joints:
- I. CERTIFIED MANUFACTURER: 3M Company
CERTIFIED PRODUCT: Fire Barrier™ Sealant
MODEL: CP25WB+
Flush type (butt joint) (Item 2F1), Prefer butt joints but allow a maximum 1 in. joint width for vertical and horizontal concrete panel joints. When through void or space exists between panels, the void in the spandrel region must be treated by packing a minimum 4 pcf density, mineral wool into the joint to a minimum 33% compression (1-1/2 times width of opening), filling the entire void or space. Recess the mineral wool a minimum of 1/2 in. from each side of the wall. Install a minimum 1/2 in. thickness of 3M CP25WB+ firestop caulk on the internal surface of the wall assembly (Item 2). Use only Intertek certified products meeting these minimum requirements
 - II. key way type (tongue and groove) (Item 2F2), or
 - III. recessed (Item 2F3).

- G. Framing Covers: (Optional) When used, locate, size, and install framing covers according to the curtain wall system manufacturer's guidelines. Do not pass framing covers through the perimeter joint protection (Item 3). Allow framing covers to abut top and bottom surfaces of the perimeter joint protection (Item 3) provided that no deformation occurs.
- H. Glass Vision Panels: When required, use optional glass vision panels a minimum 33 in. above the top surface of the floor assembly (Item 1). Install glass vision panels to curtain wall framing according to the curtain wall system manufacturer's guidelines. Use a minimum 1/4 in. thick, clear tempered glass with a nominal width and height as determined by the framing.
- I. Window Gaskets: When optional glass vision panels used, secure glass vision panels with a thermal break (thermo-set rubber extrusion).
- J. Window Framing: When glass vision panels used, use steel framing members a minimum 3-5/8 in. by 1-5/8 in., 18 GA steel, U-shaped channel or similar construction compatible with structural framing (Item 2B). Locate window framing at least 33 in. above the top surface of the floor assembly.

3. PERIMETER JOINT PROTECTION: Do not exceed an 8 in. nominal joint width (joint width at installation). Incorporate the following construction features for the perimeter joint protection (also known as perimeter fire barrier system):

- A. Packing Material: Use a minimum 4 in. thick, 4-pcf density, mineral wool batt insulation installed with the fibers running parallel to the edge of concrete floor assembly (Item 1) and curtain wall assembly (Item 2). Cut packing material width to achieve required compression, refer below, when installed in the nominal joint width. Compress the packing material into the perimeter joint. Tightly compress together splices (butt joints) in the lengths of packing material by using minimum 1/4 in. compression per piece of packing material. When a spray coating is used, locate the top surface of the packing material flush with the top surface of the concrete floor assembly (Item 1). When the non-sag or self leveling silicone sealant is used, recess the top surface of the packing material 1/4 in. from the top surface of the concrete floor assembly (Item 1). Use only Intertek certified products meeting the above minimum requirements.
- I. When 50% compression is required cut the width of the packing material 2 times wider than the nominal joint width.
 - II. When 33% compression is required cut the width of the packing material 1.5 times wider than the nominal joint width.
 - III. When 20% compression is required cut the width of the packing material 1.25 times wider than the nominal joint width.

- B. CERTIFIED MANUFACTURER: 3M Company
CERTIFIED PRODUCT: FireDam™ or Fire Barrier™
MODEL: FD Spray 200 (Elastomeric, Sprayable) or FB 1000 N/S Silicone Sealant (Non-sag) or FB 1003 S/L (Self Leveling) Sealant
Fill, Void or Cavity Material: Apply either spray coating or non-sag or self leveling silicone sealant over the packing material (Item 3A) as follows:

Spray Coating – Spray apply the liquid to cover the exposed top surface of the packing material (Item 3A) compressed and installed in the perimeter joint. Apply a minimum wet film thickness of 1/8 in. and overlap the spray coating a minimum 1/2 in. onto the adjacent curtain wall assembly (Item 2) and concrete floor assembly (Item 1). When the spraying process is stopped and the applied spray coating cures to an elastomeric film before installation process is restarted, then overlap the edge of the cured spray coating at least 1/8 in. with the liquid spray coating.

Sealant – Apply non-sag or self leveling sealant to cover the exposed surface of the packing material (Item 3A) compressed and installed in the perimeter joint. Apply minimum 1/4 in. thickness non-sag or self leveling sealant over the packing material (Item 3A) and finish flush with the top surface of the concrete floor assembly (Item 1).

- C. Support Clips: (Optional) Recommended for installations subject to vertical shear movement. Use standard 20 GA galvanized steel Z-shaped clips having the following nominal dimensions: 1 in. wide by 3 in. high with a 2 in. upper leg and a 3 in. lower leg.

This material was extracted and drawn by 3M Fire Protection Products from the 2012 Product Directory, © Intertek

JS

Design Number 3MU/JS 120-21

(Formerly OPL Design No. CEJ 313 P)

May 2, 2012

PERIMETER FIRE BARRIERS

3M Company

FireDam™ Spray 200, Fire Barrier 1000 NS Silicone Sealant and

Fire Barrier 1003 SL Silicone Sealant

ASTM E 2307

T-Rating Refer to Compression Percentage

F-Rating 2 hr

Rated for ± 16.7% horizontal movement @ 50% Compression (Reference Item 3A): T-Rating 2 hrs

Rated for ± 11% horizontal movement @ 33% Compression (Reference Item 3A): T-Rating 1 hr

Rated for ± 5% horizontal movement @ 25% Compression (Reference Item 3A): T-Rating 1/2 hr

Rated for ± 6.25% vertical shear movement @ 50% Compression (Reference Item 3A)

UL 2079

L-Rating <1.0 SCFM/LF

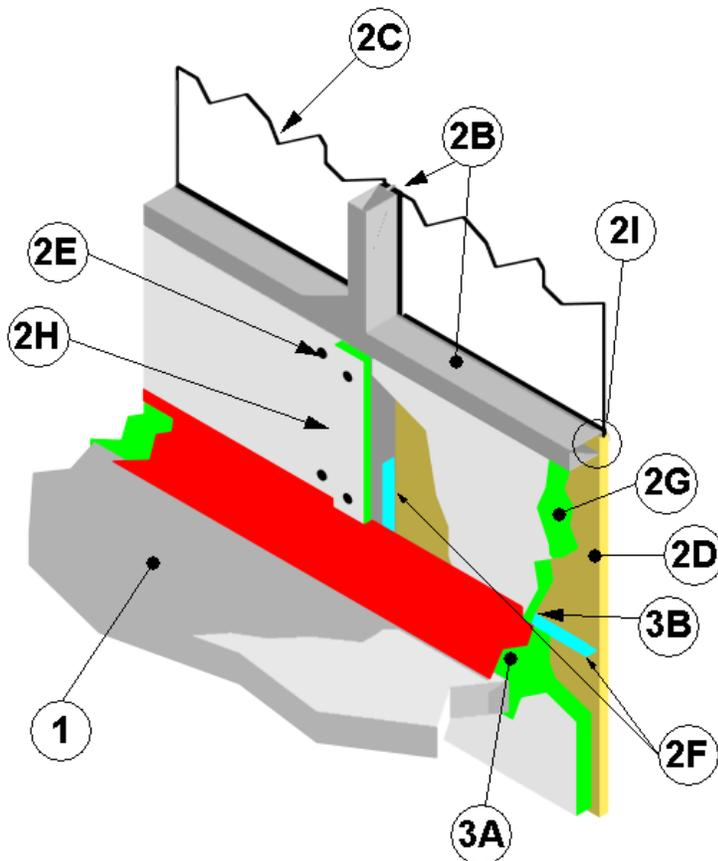

1. CONCRETE FLOOR ASSEMBLY: Two-hour rated concrete floor assembly made from either lightweight or normal weight concrete with a density of 100 to 150 pcf, having a minimum thickness of 4-1/2 in. at the joint face. When a longitudinal recess (blockout) is required to contain an architectural joint system, increase concrete floor assembly thickness to maintain a minimum thickness of 4-1/2 in. and accommodate depth of blockout formed in the concrete: blockout width unrestricted.
2. CURTAIN WALL ASSEMBLY: Incorporate the following construction features:
 - A. Mounting Attachment: (Not shown) Attach the curtain wall framing (Item 2B) to the structural framing according to the curtain wall manufacturer's instructions. When required, connect the mounting attachments to the joint face of the concrete floor assembly (Item 1) according to the curtain wall manufacturer's instructions. Limit distance between mounting attachments to maximum 120 in..
 - B. Aluminum Framing: Use hollow rectangular aluminum extruded tubing with minimum overall dimensions of 0.100 in. thick, 5-1/2 in. high and 2-1/2 in. wide. Add covers to mullion and transom on the external side of the framing: creates total framing depth of nominal 8 in.. Locate mullions (vertical aluminum framing) minimum 60 in. oc and locate transoms (horizontal aluminum framing) a minimum 48 in. oc. For the spandrel region, locate the upper transom a minimum 20 in. above the concrete floor assembly (Item 1) as measured from the top surface of the concrete floor assembly (Item 1) to the underside of the transom (horizontal aluminum framing).
 - C. Vision Glass Panels: Size and install vision glass panels to aluminum framing (Item 2B) according to the curtain wall system manufacturer's guidelines. Use a minimum 1/4 in. thick clear, heat-strengthened (HS) glass or tempered glass with a maximum width and height less than the aluminum framing (Item 2B) on center spacing, which allows the glass to be secured between the notched shoulder of the aluminum framing and pressure bar. Secure panels with a thermal break (thermo-set rubber extrusion), pressure bar (aluminum extrusion), minimum 1/4-20 x 5/8 in. long screws, and a snap face (aluminum extrusion).
 - D. Spandrel Panels: Use nominal 1-3/16 in. thick, polished, granite panels having nominal 1 in. thick edges. Size panels in accordance with the perimeter boundary requirements for the spandrel framing, as described in Item 2B. Install panels with aluminum pressure plates, glazing gaskets, and steel screws in accordance with the curtain wall manufacturer's instructions.

Design No. 3MU/JS 120-21 *continued*

Construction Joints

Perimeter Joint

- E. Impaling Pins: Use minimum 12 GA steel pins and locate, size, and install according to the curtain wall system manufacturer's guidelines, or be a minimum 1/2 in. longer than the thickness of the curtain wall insulation. Attach pins to a nominal 2 by 2 in. clip angle constructed with 20 GA, galvanized sheet steel and secure the clips to the aluminum framing (Item 2B) with No. 10, self-tapping, sheet metal screws. Space pins a maximum of 12 in. oc on the vertical framing members and a maximum of 20 in. oc on the horizontal framing members that make up the perimeter of the spandrel area. Install the interior face of the curtain wall insulation (Item 2F) so that it is flush with the interior face of the aluminum framing (Item 2B).
- F. Reinforcing Angle: Mount a minimum 1-1/2 in. by 1-1/2 in., 20 GA galvanized, steel angle to the vertical framing members so that the vertical leg serves as a backer to the exterior face of the curtain wall insulation (Item 2G) and the horizontal leg extends away from the curtain wall insulation (Item 2G) and locate at the centerline of the perimeter joint protection (Item 3). Size the angle 12 in. longer than the span between the interior edges of the vertical framing members and form the angle so that it has a 6 in. vertical leg on each end. Secure the 6 in. vertical leg to the vertical framing member on each side with three, No. 10, steel, self-tapping, sheet metal screws placed in a triangular fashion with a maximum spacing of 2 in. oc.
- G. Curtain Wall Insulation: Use nominal 24 in. wide, 4 in. thick, 4-pcf density, 3 in. thick, 6-pcf density, or 2 in. thick, 8-pcf density, mineral wool batt insulation faced on one side with aluminum foil scrim (vapor retarder), which is exposed to the room interior and installed in the stud cavity. Install curtain wall insulation between aluminum framing (Item 2B). Secure curtain wall insulation with clips, impaling pins, or friction fit using curtain wall insulation length at least 1/4 in. longer than the distance between aluminum framing (Item 2B). Seal all meeting edges of curtain wall insulation with nominal 4 in. wide pressure sensitive aluminum foil faced tape (not shown) centered over the junction so that approximately 2 in. of tape covers each edge of the adjacent curtain wall insulation. Apply pressure sensitive aluminum foil faced tape over all meeting edges of curtain wall insulation and framing covers (Item 2H) so that approximately 2 in. covers each edge of the adjacent material. Install curtain wall insulation flush with the interior face of the aluminum framing (Item 2B). Install 24 in. wide curtain wall insulation without vertical seams, spanning the full length between aluminum framing (Item 2B). Locate horizontal seams in the curtain wall insulation at least 6 in. from the top surface of the perimeter joint protection (Item 3). Maintain 1-1/4 in. air cavity between curtain wall insulation and the spandrel panel (Item 2D). Option – in lieu of filling the full depth of the stud cavity with 4 in. thick, 4-pcf density curtain wall insulation, use either minimum 6-pcf density, or 2 in. thick, or 2 in. thick, 8-pcf density curtain wall insulation mechanically secured (do not secure by friction fit). Install perimeter fire barrier reinforcement (Item 2F). Use only Intertek certified products meeting the above minimum requirements.
- H. Framing Covers: Make framing covers, of nominal 4 in. wide strips of 8 pcf density, mineral wool batt insulation faced on one side with aluminum foil scrim (vapor retarder) which is exposed to the room interior, are centered over each vertical framing member and secured to the member with impaling pins and clips spaced a maximum 12 in. oc and attached in accord with Item 2E. Make framing covers below the perimeter joint protection (Item 3) nominal 2 in. thick, and those above the perimeter joint treatment are nominal 1 in. thick. Do not pass framing covers through the perimeter joint protection (Item 3). Abut framing covers to the top and bottom surfaces of the perimeter joint protection (Item 3). Use only Intertek certified products meeting the above minimum requirements.
- I. Secure panels with a thermal break (thermo-set rubber extrusion), pressure bar (aluminum extrusion), 1/4-20 x 5/8 in. long screws, and a snap face (aluminum extrusion). Insulate spandrel panels to Item 2F.
3. PERIMETER JOINT PROTECTION: Do not exceed an 8 in. nominal joint width (joint width at installation). Incorporate the following construction features for the perimeter joint protection (also known as perimeter fire barrier system):
- A. Packing Material: Use a minimum 4 in. thick, 4-pcf density, mineral wool batt insulation installed with the fibers running parallel to the edge of concrete floor assembly (Item 1) and curtain wall assembly (Item 2). Cut packing material width to achieve required compression, refer below, when installed in the nominal joint width. Compress the packing material into the perimeter joint. Tightly compress together splices (butt joints) in the lengths of packing material by using minimum 1/4 in. compression per piece of packing material. When a spray coating is used, locate the top surface of the packing material flush with the top surface of the concrete floor assembly (Item 1). When the non-sag or self leveling silicone sealant is used, recess the top surface of the packing material 1/4 in. from the top surface of the concrete floor assembly (Item 1). Use only Intertek certified products meeting the above minimum requirements.
- When 50% compression is required cut the width of the packing material 2 times wider than the nominal joint width.
 - When 33% compression is required cut the width of the packing material 1.5 times wider than the nominal joint width.
 - When 25% compression is required cut the width of the packing material 1.33 times wider than the nominal joint width.
- B. CERTIFIED MANUFACTURER: 3M Company
CERTIFIED PRODUCT: FireDam™ or Fire Barrier™
MODEL: FD Spray 200 (Elastomeric, Sprayable) or FB 1000 N/S Silicone Sealant (Non-sag) or FB 1003 S/L (Self Leveling) Sealant
Fill, Void or Cavity Material: Apply either spray coating or sealant over the packing material (Item 3A) as follows:
Spray Coating – Spray apply the liquid to cover the exposed top surface of the packing material (Item 3A) compressed and installed in the perimeter joint. Apply a minimum wet film thickness of 1/8 in. and overlap the spray coating a minimum 1/2 in. onto the adjacent curtain wall assembly (Item 2) and concrete floor assembly (Item 1). When the spraying process is stopped and the applied spray coating cures to an elastomeric film before installation process is restarted, then overlap the edge of the cured spray coating at least 1/8 in. with the liquid spray coating.
Sealant – Apply non-sag or self leveling sealant to cover the exposed surface of the packing material (Item 3A) compressed and installed in the perimeter joint. Apply minimum 1/4 in. thickness non-sag or self leveling sealant over the packing material (Item 3A) and finish flush with the top surface of the concrete floor assembly (Item 1).

This material was extracted and drawn by 3M Fire Protection Products from the 2012 Product Directory, © Intertek

JS

Design Number 3MU/JS 120-22

(Formerly OPL Design No. CEJ 370P)

November 7, 2016

PERIMETER FIRE BARRIERS

3M Company

FireDam™ Spray 200, Fire Barrier Watertight Spray, Fire and Water Barrier Tape FWBT,
Fire Barrier 1000 NS Silicone Sealant and Fire Barrier 1003 SL Silicone Sealant

ASTM E 2307

T-Rating 1 hr

F-Rating 2 hr

ASTM E 2307/ASTM E 1399 Cycling

Class: Static

Rated for ± 0% horizontal movement @ 20% Compression (Reference Item 3A)

Rated for ± 0% vertical shear movement @ 20% Compression (Reference Item 3A)

UL 2079

L-Rating <1.0 SCFM/LF

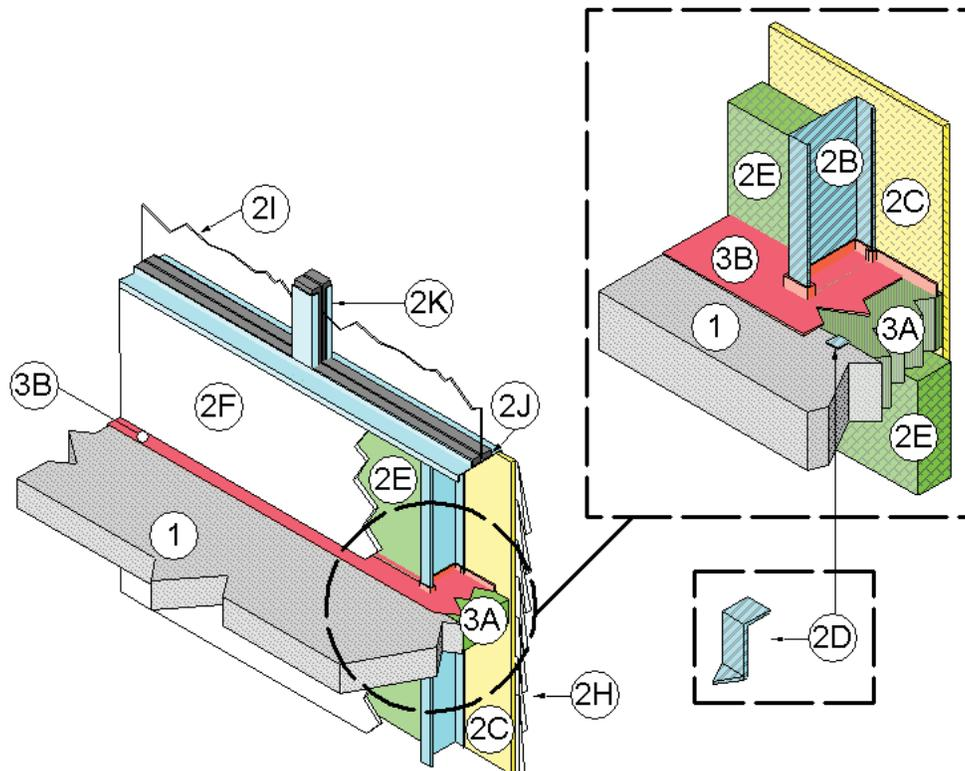

- 1. CONCRETE FLOOR ASSEMBLY:** Two-hour rated concrete floor assembly made from either lightweight or normal weight concrete with a density of 100 to 150 pcf, having a minimum thickness of 4-1/2 in. at the joint face. When a longitudinal recess (blockout) is required to contain an architectural joint system, increase concrete floor assembly thickness to maintain a min thickness of 4-1/2 in. and accommodate depth of blockout formed in the concrete: blockout width unrestricted.
- 2. CURTAIN WALL ASSEMBLY:** Incorporate the following construction features:
 - A. Mounting Attachment:** (Not shown) Attach steel-stud framing (Item 2B) to the structural framing according to the curtain wall manufacturer's instructions. When required, connect the mounting attachments to the joint face of the concrete floor assembly (Item 1) according to the curtain wall manufacturer's instructions. Limit distance between mounting attachments to max 120 in.
 - B. Steel-Stud Framing:** Vertical framing members min 6 in. by 1-5/8 in., 16 GA, steel "C" studs secured in 16 GA steel tracks, top and bottom, using min #6 × 1.25 in., Bugle head, SD, PT screws. Max vertical framing spacing of 24 in. on center (oc). Secure the steel-stud framing to the concrete floor assembly (Item 1) with curtain wall clips.
 - C. Sandwiched Wall Surface:** Use min 5/8 in. thick, 48 in. wide by 96 in. long, exterior grade, fiberglass sheathed, gypsum board placed over and secured to steel stud framing (Item 2B) with min 1-1/4 in. long, Type S, drywall screws placed nominally 8 in. oc.
 - D. Curtain Wall Clips:** Affix min 18 GA, steel, "stair-like", clip measuring min 1 in. wide to each vertical steel stud framing (Item 2B) using 5/8 in. long sheet metal screws and to the surface of the concrete floor assembly (Item 1) using min 1/4 in. diameter, 1 in. long, concrete screws. Option: weld clips to the vertical steel stud framing (Item 2B) and to the structural pour stop at the edge of the concrete floor assembly (Item 1) provided that this method does not interfere with the installation of the perimeter joint protection (Item 3).
 - E. Optional Curtain Wall Insulation:** When desired, install curtain wall insulation above or below the perimeter joint protection (Item 3). When used, secure the insulation in accordance with the manufacturer's installation instructions. Acceptable materials: mineral wool or glass fiber batt insulation.
 - F. Optional Interior Curtain Wall Surface:** When desired, install an interior curtain wall surface. Install above or below the perimeter joint protection (Item 3). When used, secure the interior curtain wall surface in accordance with the manufacturer's installation instructions. Acceptable material: gypsum board.

Design No. 3MU/JS 120-22 *continued*

Construction Joints

Perimeter Joint

- G. **Optional Knee-Wall:** When desired, install a “knee-wall” above the perimeter joint protection (Item 3). Option: When using a knee-wall with 6 in. steel stud construction, replace the curtain wall clips with the 6 in. wide steel track at the bottom of the knee-wall. Attach the 6 in. steel track to each vertical steel stud framing (Item 2B) using 5/8 in. long, sheet metal screws and to the concrete floor assembly (Item 1) using min 1/4 in. diameter by 1 in. long concrete screws.
- H. **Exterior Curtain Wall Finish:** Create no voids or openings in the exterior curtain wall finish or in the sandwiched wall surface (Item 2C) and extend exterior curtain wall finish at least 8 in. above and at least 24 in. below the surface of the concrete floor assembly (Item 1). Acceptable finishes are:
- I. **Exterior Insulation Finish System:** Use any Listed and Labeled EIFS composed of expanded polystyrene foam (EPS) insulation, and an Exterior Curtain Wall Finish consisting of the following. Apply a plaster base coat and reinforcing mesh over the sandwiched wall surface. Precut, as needed, the mesh, which is a woven fiberglass reinforcement fabric that is compatible with the plaster base coat and finish coat materials. Apply 1/16 in. to 1/8 in. thick plaster base coat to the exposed surface of the EPS foam boards, which nominally measure 24 in. wide by 48 in. long by a max of 4 in. thick with a nominal 1-pcf density. Attach the EPS foam to the sandwiched wall surface (Item 2C) using mechanical fasteners or an adhesive in accordance with manufacturer’s recommendations. Install the EPS boards in a running bond (brick-like) pattern and staggered over sandwiched wall surface (Item 2C) joints. Apply pressure to the EPS boards to assist in the bonding process. Butt together all EPS boards with no gaps or voids between them. When using adhesive, allow 12 hours min before continuing the application process. When needed, rasp the EPS boards to remove all irregular seams and establish a continuous flat surface. Apply the mesh over the EPS; embed the mesh into the plaster base coat using a trowel. Start at the middle and work outwards towards edges. Establish a final thickness of the plaster base coat with the mesh embedded of approximately 1/16 in. Let the base coat dry completely before applying the plaster finish coat. Plaster finish coat is a gypsum based material, which may contain silica sand or marble aggregates. Apply the plaster finish coat using a trowel in the same manner as the plaster base coat. Other installation techniques are acceptable when detailed by the manufacturer. The EIFS system is a monolithic assembly without expansion or control joints.
 - II. **Glass Panels:** Size and install glass panels into steel stud framing (Item 2B) according to the curtain wall system manufacturer’s guidelines. Use a min 1/4 in. thick, clear, heat-strengthened (HS), glass or tempered glass with a max width and height less than the steel stud framing (Item 2B) oc spacing, which allows the glass to be secured between the notched shoulder of the steel stud framing (Item 2B) and pressure bar. Secure panels with a thermal break (thermo-set rubber extrusion), pressure bar (extrusion), min 1/4-20 x 5/8 in. long screws, and a snap face (extrusion) or other manner as detailed by the manufacturer. The system is a monolithic assembly without expansion or control joints.
 - III. **Aluminum Panels:** Secure min 1/8 in. thick, aluminum panels to the steel stud framing (Item 2B) in accordance with the manufacturer’s installation instructions. When framing for the aluminum panels is required, it is to be compatible with the steel stud framing (Item 2B) and installed with the manufacturer’s installation instructions. The system is a monolithic assembly without expansion or control joints.
 - IV. **Brick:** Use any conventional brick, mortar type, and pattern. Do not exceed 7/8 in. wide mortar joints. Secure bricks to wall assembly (Item 2) using conventional acceptable masonry construction techniques. The system is a monolithic assembly without expansion or control joints.
 - V. **Stucco:** Use any Listed and Labeled stucco system provided that the following is met: When EPS is used, measure and verify EPS foam boards are 4 in. thick max with a nominal 1-pcf density. Confirm stucco is compatible with the sandwiched wall surface (Item 2C) with the stucco manufacturer. The system is a monolithic assembly without expansion or control joints.
 - VI. **Stone:** Use any conventional stone or stone panel measuring at least 1 in. thick, mortar type, and pattern. Do not exceed 7/8 in. wide mortar joints. Secure stone or stone panel to wall assembly (Item 2) using conventional acceptable masonry construction techniques. The system is a monolithic assembly without expansion or control joints.
 - VII. **Siding:** Use any Listed and Labeled siding system provided that the following is met: Verify that the siding is classified as non-combustible. The system is a monolithic assembly without expansion or control joints.
 - VIII. **GFRC Panels:** Use glass fiber reinforced concrete panels at least 1 in. thick and attached in accordance with the manufacturer’s installation instructions. The system is a monolithic assembly without expansion or control joints.
 - I. **Glass Vision Panels:** When required, use optional glass vision panels a min 8 in. above the top surface of the floor assembly (Item 1). Install glass vision panels to curtain wall framing according to the curtain wall system manufacturer’s guidelines. Use a min 1/4 in. thick, clear, tempered glass with a nominal width and height as determined by the window framing (Item 2K).
 - J. **Window Gaskets:** When optional glass vision panels used, secure glass vision panels with a thermal break (thermo-set rubber extrusion).
 - K. **Window Framing:** When glass vision panels used, use steel framing members a min 6 in. by 1-5/8 in., 16 GA steel, U-shaped channel or similar construction compatible with structural framing (Item 2B). Locate window framing at least 8 in. above the top surface of the floor assembly (Item 1).
3. **PERIMETER JOINT PROTECTION:** Do not exceed an 8-1/2 in. nominal joint width (joint width at installation). Incorporate the following construction features for the perimeter joint protection (also known as perimeter fire barrier system):
- A. **Packing Material:** Use a min 4 in. thick, 4-pcf density, mineral wool batt insulation installed in the following two step process.
(1) Cut and install the mineral wool batt insulation with the fibers running perpendicular to the slab edge and the curtain wall. Cut the mineral wool batt insulation at least 1/4 in. longer than the length between the vertical framing members and 1/8 in. greater than the depth of the steel studs. There shall be no voids. (2) Install pieces of mineral wool batt insulation in the longitudinal void created between the vertical face of the concrete floor assembly and the mineral wool batt insulation. Cut and install the mineral wool batt insulation with the fibers running parallel to the slab edge and the curtain wall. Install the packing material as specified below to achieve required compression when installed in the nominal joint width. Compress the packing material into the perimeter joint. Tightly compress together splices (butt joints) in the lengths of packing material by using min 1/4 in. compression per piece of packing material. When a spray coating is used, locate the top surface of the packing material flush with the top surface of the concrete floor assembly (Item 1). When the non-sag or self leveling silicone sealant is used, recess the top surface of the packing material 1/4 in. from the top surface of the concrete floor assembly (Item 1). Use only Intertek certified products meeting the above min requirements.
 - i. When 20% compression is required cut the width of the packing material 1.25 times wider than the nominal joint width.
 - B. **CERTIFIED MANUFACTURER:** 3M Company
CERTIFIED PRODUCT: FireDam™ or Fire Barrier™

JS

Design No. 3MU/JS 120-22 *continued*

MODEL: FD Spray 200 (Elastomeric, Sprayable) Fire Barrier Watertight Spray (Elastomeric, Sprayable) or Fire and Water Barrier Tape FWBT (Tape) or FB 1000 N/S Silicone Sealant (Non-sag) or FB 1003 S/L (Self Leveling) Sealant

Fill, Void or Cavity Material: Apply either spray coating or sealant over the packing material (Item 3A) as follows:

Spray Coating – Spray apply the liquid to cover the exposed top surface of the packing material (Item 3A) compressed and installed in the perimeter joint. Apply a min wet film thickness of 1/8 in. and overlap the spray coating a min 1/2 in. onto the adjacent curtain wall assembly (Item 2) and concrete floor assembly (Item 1). When the spraying process is stopped and the applied spray coating cures to an elastomeric film before installation process is restarted, then overlap the edge of the cured spray coating at least 1/8 in. with the liquid spray coating.

Tape – Apply the tape such that there is a min 1 in. overlap onto the adjacent curtain wall assembly (Item 2) and the concrete floor assembly (Item 1). Overlap joints in the tape system by 1/2 in.

Sealant – Apply non-sag or self leveling sealant to cover the exposed surface of the packing material (Item 3A) compressed and installed in the perimeter joint. Apply min 1/4 in. thickness non-sag or self leveling sealant over the packing material (Item 3A) and finish flush with the top surface of the concrete floor assembly (Item 1).

This material was extracted and drawn by 3M Fire Protection Products from the 2016 Product Directory, © Intertek

Construction Joints

Perimeter Joint

JS

Design Number 3MU/JS 120-23

(Formerly OPL Design No. CEJ 372P)

May 2, 2012

PERIMETER FIRE BARRIERS

3M Company

FireDam™ Spray 200, Fire Barrier 1000 NS Silicone Sealant and

Fire Barrier 1003 SL Silicone Sealant

ASTM E 2307

T-Rating 0 hr

F-Rating 2 hr

ASTM E 2307/ASTM E 1399 Cycling

Class IV: 500 cycles @ 30 cpm

Rated for ± 10% horizontal movement @ 33% Compression (Reference Item 3A)

Rated for ± 6.25% vertical shear movement @ 33% Compression (Reference Item 3A)

UL 2079

L-Rating <1.0 SCFM/LF

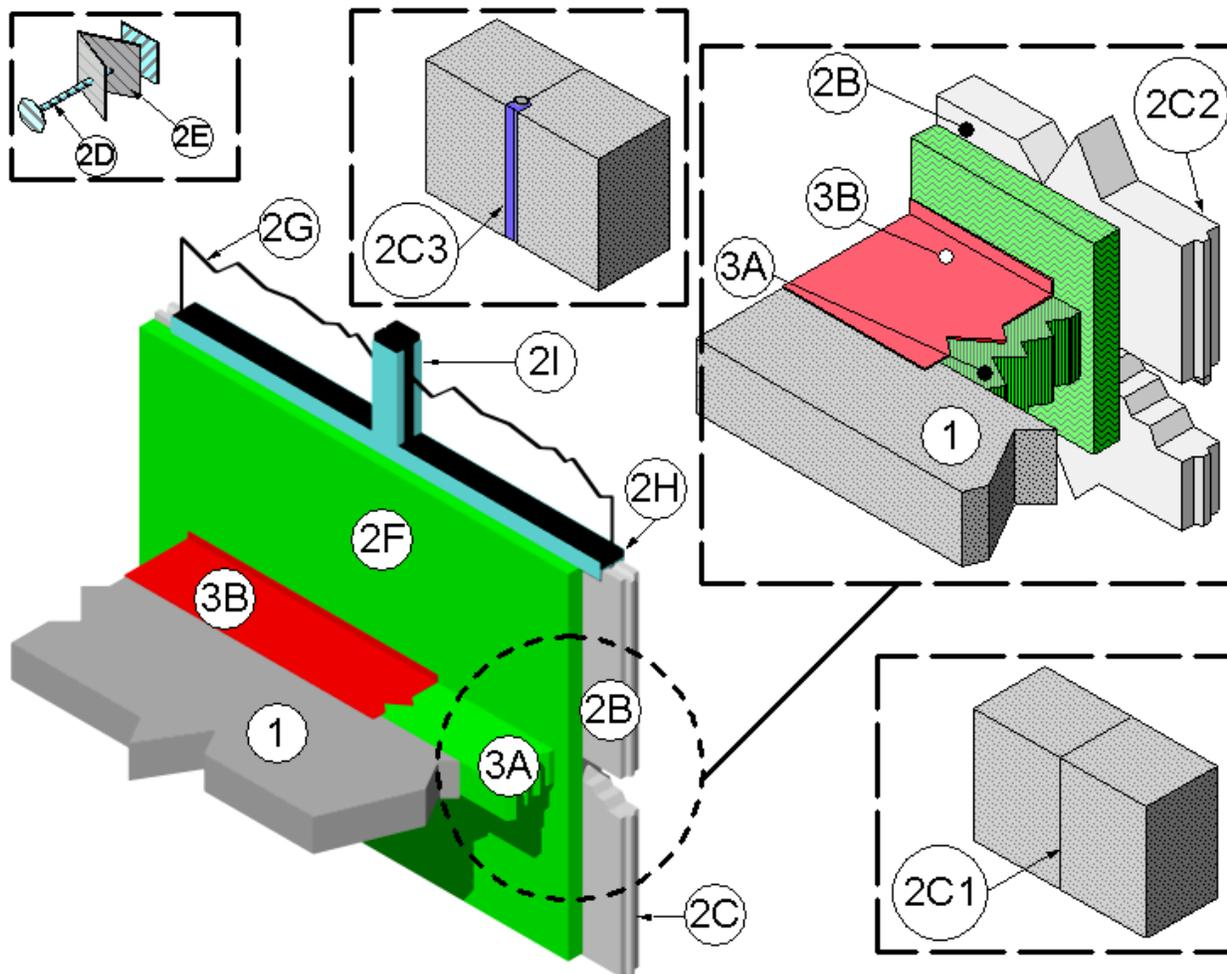

1. CONCRETE FLOOR ASSEMBLY: Two-hour rated concrete floor assembly made from either lightweight or normal weight concrete with a density of 100 to 150 pcf, having a minimum thickness of 4-1/2 in. at the joint face. When a longitudinal recess (blockout) is required to contain an architectural joint system, increase concrete floor assembly thickness to maintain a minimum thickness of 4-1/2 in. and accommodate depth of blockout formed in the concrete: blockout width unrestricted.
2. CURTAIN WALL ASSEMBLY: Incorporate the following construction features:
 - A. Mounting Attachment: (Not shown) Attach pre-cast concrete panels (Item 2B) to the structural framing according to the curtain wall manufacturer's instructions. When required, connect the mounting attachments to the joint face of the concrete floor assembly (Item 1) according to the curtain wall manufacturer's instructions. Limit distance between mounting attachments to maximum 120 in..
 - B. Pre-Cast Concrete Panels: Engineered structural panels: either tilt-up or formed panels, construct panels from steel-reinforced lightweight or normal weight (100-150 pcf) concrete, a minimum of 4 in. thick, 48 in. wide. Equip panels with structural mechanical attachments welded to the steel reinforcement within the panel for mechanical attachment to steel columns and spandrel beams in accordance with structural engineer's requirements. When anchors are located within the perimeter joint protection (Item 3), maintain a minimum recess of 1/2 in. from the top of the concrete floor assembly (Item 1) and maximum spacing of 120 in. oc between anchors.
 - C. Concrete Panel Joint: No through joints recommended. When required, seal the surface of the concrete panel joints with gaskets or sealants. Option: Treat the concrete panel joint with any weatherproofing material Listed as a Class 1 material in accordance with ASTM E-84. Use only Intertek certified products meeting these minimum requirements. Use one of the following for vertical and horizontal concrete panel joints:

Design No. 3MU/JS 120-23 *continued*

Construction Joints

Perimeter Joint

- i. CERTIFIED MANUFACTURER: 3M Company
CERTIFIED PRODUCT: Fire Barrier™ Sealant
MODEL: CP25WB+

Flush type (butt joint) (Item 2F1), Prefer butted joints but allow a maximum 1 in. joint width for vertical and horizontal concrete panel joints. When through void or space exists between panels, the void in the spandrel region must be treated by packing a minimum 4 pcf density, mineral wool into the joint to a minimum 33% compression (1-1/2 times width of opening), filling the entire void or space. Recess the mineral wool a minimum of 1/2 in. from each side of the wall. Install a minimum 1/2 in. thickness of 3M CP25WB+ firestop caulk on the internal surface of the wall assembly (Item 2). Use only Intertek certified products meeting these minimum requirements.

- ii. key way type (tongue and groove) (Item 2F2), or
- iii. recessed (Item 2F3).

- D. Impaling Pins: Use with curtain wall insulation (Item 2F), locate, size and install impaling pins according to the curtain wall system manufacturer's guidelines, or be a minimum 4-1/2 in. long, 12 GA pin attached to one of the following: a nominal 2 in. by 2 in. plate; a nominal 2 in. by 2 in. by 2 in. long angle; or can be directly attached to the pre-cast concrete panels (Item 2B) using mechanical fasteners. Space impaling pins a maximum of 12 in. oc. Add additional pins spaced a maximum of 16 in. oc at the centerline of the packing material (Item 3A). Install impaling pins around the periphery of the curtain wall insulation (Item 2F). A minimum of two impaling pins required located above the floor line per piece of insulation that has been cut from standard size with at least one in each corner.
- E. Clutch Clips: (Installed over Impaling Pins) Minimum 18 GA, steel clutch clips, maximum 1-1/4 in.. Space clutch clips and impaling pins a maximum of 16 in. oc at the centerline of the packing material (Item 3A). Install a clutch clip for each impaling pin. Create an air space between the pre-cast concrete panels (Item 2B) and the curtain wall insulation (Item 2F) using the clutch clips.
- F. Curtain Wall Insulation: When required, install the concrete panel joint treatment (Item 2C) before curtain wall insulation (Item 2F). Install either nominal 4 in. thick 4 pcf density, 3 in. thick 6 pcf density, or 2 in. thick 8 pcf density, mineral wool batt insulation faced on one side with aluminum foil scrim (vapor retarder) which is exposed to the room interior. Offset the seams between adjacent sections of curtain wall insulation a minimum 3 in. from the edge of any concrete panel joint (Item 2C). Secure with impaling pins (Item 2D). Seal all meeting edges of insulation with nominal 2 in. wide, pressure sensitive, aluminum foil faced tape. Terminate curtain wall insulation (Item 2F) at the window framing (Item 2I) above the perimeter joint protection (Item 3). Use only Intertek certified products meeting the above minimum requirements.
- G. Glass Vision Panels: When required, use optional glass vision panels a minimum 20 in. above the top surface of the floor assembly (Item 1). Install glass vision panels to curtain wall framing according to the curtain wall system manufacturer's guidelines. Use a minimum 1/4 in. thick, clear tempered glass with a nominal width and height as determined by the framing.
- H. Window Gaskets: When optional glass vision panels used, secure glass vision panels with a thermal break (thermo-set rubber extrusion).
- I. Window Framing: Use mullions and transoms, sized according to the curtain wall system manufacturer's guidelines. Minimum required framing dimensions; window framing must be compatible with pre-cast concrete panels (Item 2B). Locate window framing at least 20 in. above the top surface of the floor assembly (Item 1).

- 3. PERIMETER JOINT PROTECTION: Do not exceed an 8 in. nominal joint width (joint width at installation). Incorporate the following construction features for the perimeter joint protection (also known as perimeter fire barrier system):

- A. Packing Material: Use a minimum 4 in. thick, 4-pcf density, mineral wool batt insulation installed with the fibers running parallel to the edge of concrete floor assembly (Item 1) and curtain wall assembly (Item 2). Cut packing material width to achieve required compression, refer below, when installed in the nominal joint width. Compress the packing material into the perimeter joint. Tightly compress together splices (butt joints) in the lengths of packing material by using minimum 1/4 in. compression per piece of packing material. When a spray coating is used, locate the top surface of the packing material flush with the top surface of the concrete floor assembly (Item 1). When the non-sag or self leveling silicone sealant is used, recess the top surface of the packing material 1/4 in. from the top surface of the concrete floor assembly (Item 1). Use only Intertek certified products meeting the above minimum requirements.

- i. When 33% compression is required cut the width of the packing material 1.5 times wider than the nominal joint width.

- B. CERTIFIED MANUFACTURER: 3M Company

CERTIFIED PRODUCT: FireDam™ or Fire Barrier™

MODEL: FD Spray 200 (Elastomeric, Sprayable) or FB 1000 N/S Silicone Sealant (Non-sag) or FB 1003 S/L (Self Leveling) Sealant

Fill, Void or Cavity Material: Apply either spray coating or sealant over the packing material (Item 3A) as follows:

Spray Coating – Spray apply the liquid to cover the exposed top surface of the packing material (Item 3A) compressed and installed in the perimeter joint. Apply a minimum wet film thickness of 1/8 in. and overlap the spray coating a minimum 1/2 in. onto the adjacent curtain wall assembly (Item 2) and concrete floor assembly (Item 1). When the spraying process is stopped and the applied spray coating cures to an elastomeric film before installation process is restarted, then overlap the edge of the cured spray coating at least 1/8 in. with the liquid spray coating.

Sealant – Apply non-sag or self leveling sealant to cover the exposed surface of the packing material (Item 3A) compressed and installed in the perimeter joint. Apply minimum 1/4 in. thickness non-sag or self leveling sealant over the packing material (Item 3A) and finish flush with the top surface of the concrete floor assembly (Item 1).

This material was extracted and drawn by 3M Fire Protection Products from the 2012 Product Directory, © Intertek

JS

Design Number 3MU/JS 180-01

(Formerly OPL Design No. CEJ 160 P)

November 14, 2011

PERIMETER FIRE BARRIERS

3M Company

FireDam™ Spray 200, Fire Barrier 1000 NS Silicone Sealant and

Fire Barrier 1003 SL Silicone Sealant

ASTM E 2307

T-Rating Refer to Compression Percentage

F-Rating 3 hr

ASTM E 2307/ASTM E 1399 Cycling

Class IV: 500 cycles @ 30 cpm

Rated for ± 16.7% horizontal movement @ 50% Compression (Reference Item 3A): T-Rating 2-1/2 hr

Rated for ± 11% horizontal movement @ 33% Compression (Reference Item 3A): T-Rating 1-1/2 hr

Rated for ± 6.25% vertical shear movement @ 50% Compression (Reference Item 3A)

UL 2079

L-Rating <1.0 SCFM/LF

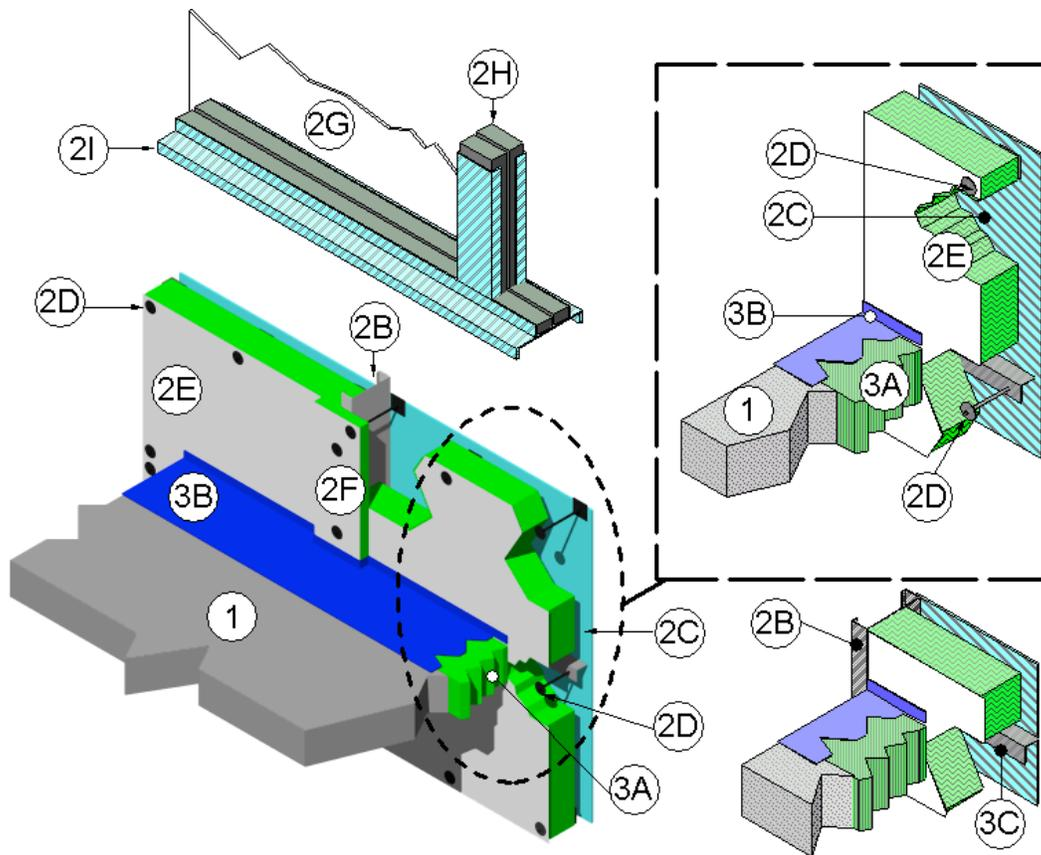

1. CONCRETE FLOOR ASSEMBLY: Three-hour rated concrete floor assembly made from either lightweight or normal weight concrete with a density of 100 to 150 pcf, having a minimum thickness of 4-1/2" at the joint face. When a longitudinal recess (blockout) is required to contain an architectural joint system, increase concrete floor assembly thickness to maintain a minimum thickness of 4-1/2" and accommodate depth of blockout formed in the concrete: blockout width unrestricted.
2. CURTAIN WALL ASSEMBLY: Incorporate the following construction features into the curtain wall assembly:
 - A. Panel Mounting Attachment: (Not shown) Install steel attachments to the structural framing (Item 2B) according to the curtain wall manufacturer's instructions. When required, connect the steel mounting attachments to the joint face of the concrete floor assembly (Item 1) according to the curtain wall manufacturer's instructions. Limit distance between steel mounting attachments to maximum 120".
 - B. Steel Stud Framing: Use minimum 3-5/8" by 1-5/8", 18 GA, C-shaped steel studs as vertical framing. Attach according to the curtain wall system manufacturer's guidelines. Limit distance between vertical steel stud framing to maximum 48". Limit distance between horizontal steel stud framing to maximum 72". When required, install horizontal structural framing members according to the curtain wall system manufacturer's guidelines and, in the spandrel area, locate a minimum of 30" above the top surface of the concrete floor assembly (Item 1).
 - C. Steel Panels: Install steel panels to curtain wall framing according to the curtain wall system manufacturer's guidelines. Use a minimum 20 GA sheet steel panel with maximum dimensions of 48" wide x 144" high.
 - D. Impaling Pins: When used with curtain wall insulation (Item 2E), locate, size and install impaling pins according to the curtain wall system manufacturer's guidelines, or be a minimum 4-1/2" long, 12 GA pin attached to one of the following: a nominal 2" by 2" plate; a nominal 2" by 2" by 2" long angle; or can be directly attached to the steel stud framing (Item 2B) using a stud gun. Space impaling pins a maximum of 12" oc. Install impaling pins around the periphery of the curtain wall insulation (Item 2E) so that its interior face is flush with the interior face of the steel stud framing (Item 2B).

Design No. 3MU/JS 180-01 *continued*

Construction Joints

Perimeter Joint

- E. **Curtain Wall Insulation:** Use nominal 24" wide, 2" thick, 8-pcf density, mineral wool batt insulation faced on one side with aluminum foil scrim (vapor retarder), which is exposed to the room interior and installed in the stud cavity. Install curtain wall insulation by fitting in each stud cavity between steel stud framing (Item 2B) using clips, impaling pins (Item 2D), or friction fit by using a curtain wall insulation lengths at least 1/4" longer than the distance between steel stud framing (Item 2B). Maintain 1-1/4" air cavity between curtain wall insulation and steel panels (Item 2C). Completely fill the recess of the "C-shaped" steel stud framing (Item 2B) with curtain wall insulation. Tightly compress together butt joints in the lengths of curtain wall insulation by using minimum 1/4" compression per piece of curtain wall insulation material. Tape all adjacent edges between curtain wall insulation, or between steel-stud framing (Item 2B) and curtain wall insulation, with minimum 4" wide pressure sensitive aluminum foil tape, centered over the seam. Locate horizontal seams in the curtain wall insulation at least 6" above or below the top surface of the perimeter joint protection (Item 3). Use only Intertek certified products meeting the above minimum requirements.
- F. **Framing Covers:** Make from strips of 1", 8 pcf density, mineral wool batt insulation faced on one side with aluminum foil scrim (vapor retarder), which is exposed to the room interior. Cut strips a minimum 1-1/2" wider than steel stud framing (Item 2B). Center framing covers over all steel stud framing (Item 2B) and secure using impaling pins (Item 2I). Do not pass framing covers through the perimeter joint protection (Item 3). Allow framing covers to abut the top and the bottom surfaces of the perimeter joint protection (Item 3) provided that no deformation occurs. Use only Intertek certified products meeting the above minimum requirements.
- G. **Glass Vision Panels:** When required, use optional glass vision panels a minimum 20" above the top surface of the floor assembly (Item 1). Install glass vision panels to curtain wall framing according to the curtain wall system manufacturer's guidelines. Use a minimum 1/4" thick, clear tempered glass with a nominal width and height as determined by the framing.
- H. **Window Gaskets:** (Not shown) When optional glass vision panels used, secure glass vision panels with a thermal break (thermo-set rubber extrusion).
- I. **Window Framing:** (Not shown) When glass vision panels used, use steel framing members a minimum 3-5/8" by 1-5/8", 18 GA steel, U-shaped channel or similar construction compatible with structural framing (Item 2B). Locate window framing at least 20" above the top surface of the floor assembly.
3. **PERIMETER JOINT PROTECTION:** Do not exceed an 8" nominal joint width (joint width at installation). Incorporate the following construction features for the perimeter joint protection (also known as perimeter fire barrier system):
- A. **Packing Material:** Install reinforcing angle (Item 3C). Use a minimum 4" thick, 4-pcf density, mineral wool batt insulation installed with the fibers running parallel to the edge of concrete floor assembly (Item 1) and curtain wall assembly (Item 2). Cut packing material width to achieve required compression, refer below, when installed in the nominal joint width. Compress the packing material into the perimeter joint. Tightly compress together splices (butt joints) in the lengths of packing material by using minimum 1/4" compression per piece of packing material. When a spray coating is used, locate the top surface of the packing material flush with the top surface of the concrete floor assembly (Item 1). When the non-sag or self leveling silicone sealant is used, recess the top surface of the packing material 1/4" from the top surface of the concrete floor assembly (Item 1). Use only Intertek certified products meeting the above minimum requirements.
- I. When 50% compression is required cut the width of the packing material 2 times wider than the nominal joint width.
- II. When 33% compression is required cut the width of the packing material 1.5 times wider than the nominal joint width.
- B. **CERTIFIED COMPANY:** 3M Company
CERTIFIED PRODUCT: FireDam™ or Fire Barrier™
MODEL: FD Spray 200 (Elastomeric, Sprayable) or FB 1000 N/S Silicone Sealant (Non-sag) or FB 1003 S/L (Self Leveling)
Fill, Void or Cavity Material: Apply either spray coating or sealant over the packing material (Item 3A) as follows:
Spray Coating – Spray apply the liquid to cover the exposed top surface of the packing material (Item 3A) compressed and installed in the perimeter joint. Apply a minimum wet film thickness of 1/8" and overlap the spray coating a minimum 1/2" onto the adjacent curtain wall assembly (Item 2) and concrete floor assembly (Item 1). When the spraying process is stopped and the applied spray coating cures to an elastomeric film before installation process is restarted, then overlap the edge of the cured spray coating at least 1/8" with the liquid spray coating.
Sealant – Apply non-sag or self leveling sealant to cover the exposed surface of the packing material (Item 3A) compressed and installed in the perimeter joint. Apply minimum 1/4" thickness non-sag or self leveling sealant over the packing material (Item 3A) and finish flush with the top surface of the concrete floor assembly (Item 1).
- C. **Reinforcing Angle:** Mount a minimum 1-1/2" x 1-1/2", 20 GA, galvanized-steel angle to the steel stud framing (Item 2B) (vertical framing members) so that the vertical leg serves as a backer to the exterior face of the curtain wall insulation (Item 2F) and the horizontal leg extends away the curtain wall insulation and is located at the centerline of the packing material (Item 3A). Size the angle 12" longer than the span between the interior edges of the steel stud framing (Item 2B) and form the angle so that it has a 6" vertical leg on each end. Secure the 6" vertical leg on each end to the steel stud framing (Item 2B) on each side with three #10 steel self-tapping sheet metal screws placed in a triangular fashion with a maximum spacing of 2" oc.

This material was extracted and drawn by 3M Fire Protection Products from the 2012 Product Directory, © Intertek

JS

Design Number 3MU/JS 180-02

(Formerly OPL Design No. CEJ 161 P)

November 7, 2016

PERIMETER FIRE BARRIERS

3M Company

FireDam™ Spray 200, Fire Barrier Watertight Spray, Fire and Water Barrier Tape FWBT,
Fire Barrier 1000 NS Silicone Sealant and Fire Barrier 1003 SL Silicone Sealant

ASTM E 2307

T-Rating Refer to Compression Percentage

F-Rating 3 hr

ASTM E 2307/ASTM E 1399 Cycling

Class IV: 500 cycles @ 30 cpm

‡Rated for ± 16.7% horizontal movement @ 50% Compression (Reference Item 3A): T-Rating 2-1/2 hr

‡Rated for ± 11% horizontal movement @ 33% Compression (Reference Item 3A): T-Rating 1-1/2 hr

Rated for ± 6.25% vertical shear movement @ 50% Compression (Reference Item 3A)

UL 2079

L-Rating <1.0 SCFM/LF

‡: Fire Barrier Watertight Spray cycling rating limited to ±10% horizontal movement

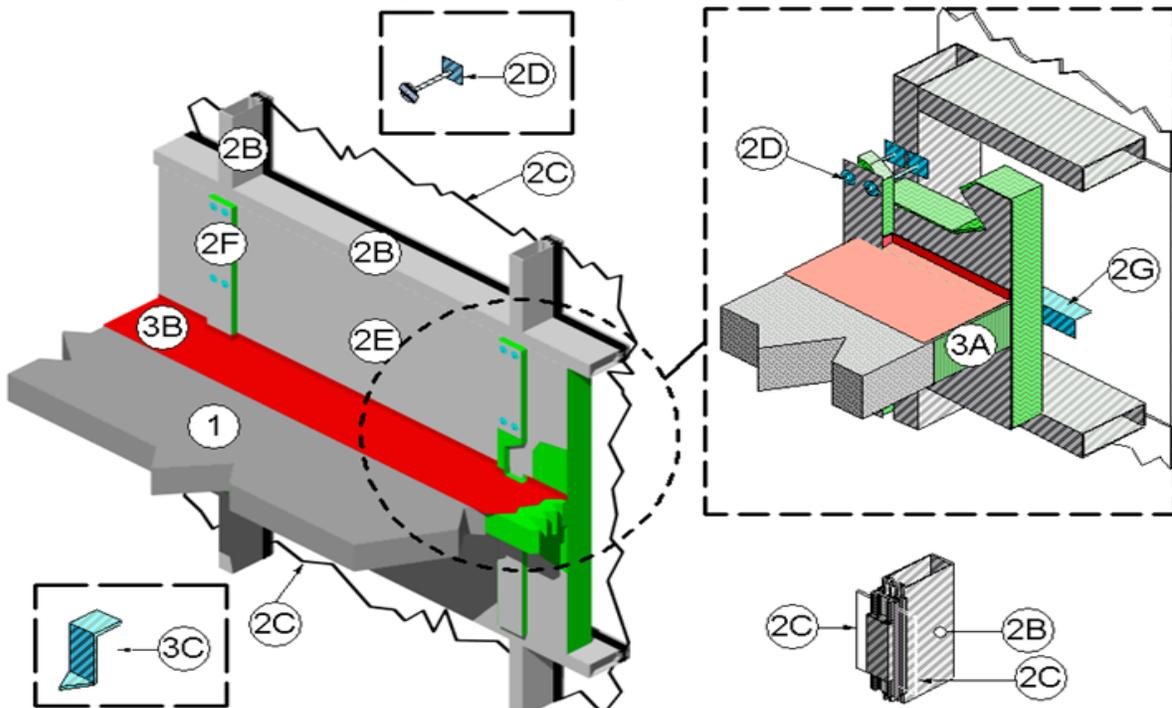

- CONCRETE FLOOR ASSEMBLY:** Three-hour rated concrete floor assembly made from either lightweight or normal weight concrete with a density of 100 to 150 pcf, having a min thickness of 4-1/2 in. at the joint face. When a longitudinal recess (blockout) is required to contain an architectural joint system, increase concrete floor assembly thickness to maintain a min thickness of 4-1/2 in. and accommodate depth of blockout formed in the concrete: blockout width unrestricted.
- CURTAIN WALL ASSEMBLY:** Incorporate the following construction features:
 - Mounting Attachment:** (Not shown) Attach aluminum framing (Item 2B) to the structural steel framing (not shown) according to the curtain wall manufacturer's instructions. When required, connect the mounting attachments to the joint face of the concrete floor assembly (Item 1) according to the curtain wall manufacturer's instructions. Limit distance between mounting attachments to max 120 in.
 - Aluminum Framing:** Use hollow rectangular aluminum extruded tubing with min overall dimensions of 0.100 in. thick, 5-1/2 in. high and 2-1/2 in. wide. Locate mullions (vertical aluminum framing) max 60 in. on center (oc) and locate transoms (horizontal aluminum framing) a min 48 in. oc. For the spandrel region, locate the upper transom a max 20 in. above the concrete floor assembly (Item 1) as measured from the top surface of the concrete floor assembly (Item 1) to the underside of the transom.
 - Glass Panels:** Sized and installed into aluminum framing (Item 2B) according to the curtain wall system manufacturer's guidelines. Use min 1/4 in. thick clear, heat strengthened (HS) glass or tempered glass with a max width and height less than the aluminum framing (Item 2B) oc spacing, which allows the glass to be secured between the notched shoulder of the aluminum framing (Item 2B) and pressure bar. Secure glass panels with a thermal break (rubber extrusion), pressure bar (aluminum extrusion), min 1/4-20 x 5/8 in. long screws, and a snap face (aluminum extrusion).
 - Impaling Pins:** When used with curtain wall insulation (Item 2E) and framing covers (Item 2F), locate, size and install impaling pins according to the curtain wall system manufacturer's guidelines, or be a min 4-1/2 in. long, 12 GA pin attached to one of the following: a nominal 2 in. by 2 in. plate; a nominal 2 in. by 2 in. long angle; or can be directly attached to the aluminum framing (Item 2B) using a stud gun. Space impaling pins a max of 12 in. oc vertically and 20 in. oc horizontally. Install impaling pins around the periphery of the curtain wall insulation (Item 2E) so that its interior face is flush with the interior face of the aluminum framing (Item 2B).
 - Curtain Wall Insulation:** Use nominal 24 in. wide, 4 in. thick, 4-pcf density, 3 in. thick, 6-pcf density, or 2 in. thick, 8-pcf density, mineral

System No. 3MU/JS 180-02 *continued*

wool batt insulation faced on one side with aluminum foil scrim (vapor retarder), which is exposed to the room interior and installed in the stud cavity. Install curtain wall insulation between aluminum framing (Item 2B). Secure curtain wall insulation with clips, impaling pins, or friction fit using curtain wall insulation length at least 1/4 in. longer than the distance between aluminum framing (Item 2B). Seal all meeting edges of curtain wall insulation with nominal 4 in. wide pressure sensitive aluminum foil faced tape (not shown) centered over the junction so that approximately 2 in. of tape covers each edge of the adjacent curtain wall insulation. Apply pressure sensitive aluminum foil faced tape over all meeting edges of curtain wall insulation and framing covers (Item 2F) so that approximately 2 in. covers each edge of the adjacent material. Install curtain wall insulation flush with the interior face of the aluminum framing (Item 2B). Install 24 in. wide curtain wall insulation without vertical seams, spanning the full length between aluminum framing (Item 2B). Locate horizontal seams in the curtain wall insulation at least 6 in. from the top surface of the perimeter joint protection (Item 3). Maintain 1-1/4 in. air cavity between curtain wall insulation and glass panels (Item 2C). Option – in lieu of filling the full depth of the stud cavity with 4 in. thick, 4-pcf density curtain wall insulation, use minimum 2 in. thick, 8-pcf density curtain wall insulation mechanically secured (do not secure by friction fit) and use additional horizontal support angle (not shown). Locate a horizontal support angle consisting of a minimum 20 GA steel angle, having 1.5 in. × 1.5 in. legs horizontally at the mid height of the packing material (Item 3A) and attached to each mullion of aluminum framing (Item 2B) using min #6, 1/2 in. long self-tapping sheet metal screws. Use only Intertek certified products meeting the above min requirements.

- F. Framing Covers: Make from strips of min 1 in. thick by min 4 in. wide, 8 pcf density, mineral wool batt insulation faced on one side with aluminum foil scrim (vapor retarder), which is exposed to the room interior. Center framing covers over all aluminum framing (Item 2B) and secure using impaling pins (Item 2D). Do not pass framing covers through the perimeter joint protection (Item 3). Allow framing covers to abut top and bottom surfaces of the perimeter joint protection (Item 3) provided that no deformation occurs. Use only Intertek certified products meeting the above min requirements.
 - G. Reinforcing Angle: Locate reinforcing angle at all horizontal butt joints of the curtain wall insulation (Item 2E) in the field of the glass spandrel panels (Item 2C) and at the mid height of the packing material (Item 3A). Mount a min 1-1/2 × 1-1/2 in., 20 gauge, galvanized-steel angle to the aluminum mullions (Item 2B) (vertical framing members) so that the vertical leg serves as a backer to the exterior face of the curtain wall insulation (Item 2E) and the horizontal leg extends away from the curtain wall insulation and is located at the centerline of the packing material (Item 3A). Size the angle 12 in. longer than the span between the interior edges of the aluminum mullions (Item 2B) and form the angle so that it has a 6 in. vertical leg on each end. Secure the 6 in. vertical leg on each end to the aluminum mullions (Item 2B) on each side with three #10 steel self-tapping sheet metal screws placed in a triangular fashion with a max spacing of 2 in. oc. When horizontal butt joint is located at the horizontal centerline of the perimeter joint protection (Item 3) additional horizontal support angle (not shown) not required.
3. **PERIMETER JOINT PROTECTION:** Do not exceed an 8 in. nominal joint width (joint width at installation). Incorporate the following construction features for the perimeter joint protection (also known as perimeter fire barrier system):
- A. Packing Material: Use a min 4 in. thick, 4 pcf density, mineral wool batt insulation installed with the fibers running parallel to the edge of concrete floor assembly (Item 1) and curtain wall assembly (Item 2). Cut packing material width to achieve required compression, refer below, when installed in the nominal joint width. Compress the packing material into the perimeter joint. Tightly compress together splices (butt joints) in the lengths of packing material by using min 1/4 in. compression per piece of packing material. When a spray coating is used, locate the top surface of the packing material flush with the top surface of the concrete floor assembly (Item 1). When the non-sag or self-leveling silicone sealant is used, recess the top surface of the packing material 1/4 in. from the top surface of the concrete floor assembly (Item 1). Use only Intertek certified products meeting the above mini requirements.
 - i. When 50% compression is required cut the width of the packing material 2 times wider than the nominal joint width.
 - ii. When 33% compression is required cut the width of the packing material 1.5 times wider than the nominal joint width.
 - B. CERTIFIED MANUFACTURER: 3M Company
CERTIFIED PRODUCT: FireDam™ or Fire Barrier™
MODEL: FD Spray 200 (Elastomeric, Sprayable) or Fire Barrier Watertight Spray (Elastomeric, Sprayable) or Fire and Water Barrier Tape FWBT (Tape) or FB 1000 N/S Silicone Sealant (Non-sag) or FB 1003 S/L (Self Leveling) Sealant
Fill, Void or Cavity Material: Apply either spray coating or sealant over the packing material (Item 3A) as follows:
Spray Coating – Spray apply the liquid to cover the exposed top surface of the packing material (Item 3A) compressed and installed in the perimeter joint. Apply a min wet film thickness of 1/8 in. and overlap the spray coating a min 1/2 in. onto the adjacent curtain wall assembly (Item 2) and concrete floor assembly (Item 1). When the spraying process is stopped and the applied spray coating cures to an elastomeric film before installation process is restarted, then overlap the edge of the cured spray coating at least 1/8 in. with the liquid spray coating.
Tape – Apply the tape such that there is a min 1 in. overlap onto the adjacent curtain wall assembly (Item 2) and the concrete floor assembly (Item 1). Overlap joints in the tape system by 1/2 in.
Sealant – Apply non-sag or self-leveling sealant to cover the exposed surface of the packing material (Item 3A) compressed and installed in the perimeter joint. Apply min 1/4 in. thickness non-sag or self-leveling sealant over the packing material (Item 3A) and finish flush with the top surface of the concrete floor assembly (Item 1).
 - C. Support Clips: (Optional) Recommended for installations subject to vertical shear movement. Use standard 20 GA galvanized steel Z-shaped clips having the following nominal dimensions: 1 in. wide by 3 in. high with a 2 in. upper leg and a 3 in. lower leg.

This material was extracted and drawn by 3M Fire Protection Products from the 2016 Product Directory, © Intertek

Design Number 3MU/JS 180-03

(Formerly OPL Design No. CEJ 165 P)

November 14, 2011

PERIMETER FIRE BARRIERS

3M Company

FireDam™ Spray 200, Fire Barrier 1000 NS Silicone Sealant and

Fire Barrier 1003 SL Silicone Sealant

ASTM E 2307

T-Rating Refer to Compression Percentage

F-Rating 3 hr

ASTM E 2307/ASTM E 1399 Cycling

Class IV: 500 cycles @ 30 cpm

Rated for ± 16.7% horizontal movement @ 50% Compression (Reference Item 3A): T-Rating 2-1/2 hr

Rated for ± 11% horizontal movement @ 33% Compression (Reference Item 3A): T-Rating 1-1/2 hr

Rated for ± 6.25% vertical shear movement @ 50% Compression (Reference Item 3A)

UL 2079

L-Rating <1.0 SCFM/LF

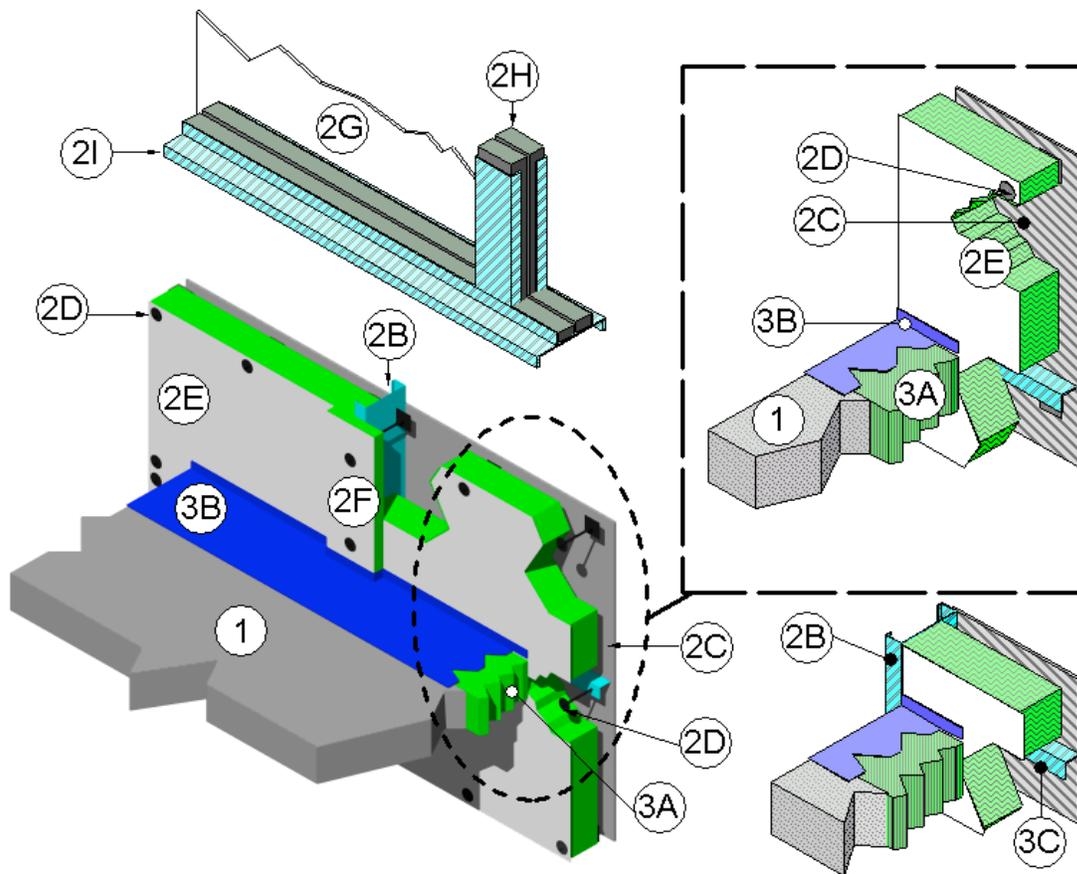

1. CONCRETE FLOOR ASSEMBLY: Three-hour rated concrete floor assembly made from either lightweight or normal weight concrete with a density of 100 to 150 pcf, having a minimum thickness of 4-1/2" at the joint face. When a longitudinal recess (blockout) is required to contain an architectural joint system, increase concrete floor assembly thickness to maintain a minimum thickness of 4-1/2" and accommodate depth of blockout formed in the concrete: blockout width unrestricted.
2. CURTAIN WALL ASSEMBLY: Incorporate the following construction features into the curtain wall assembly:
 - A. Panel Mounting Attachment: (Not shown) Install steel attachments to the structural framing (Item 2B) according to the curtain wall manufacturer's instructions. When required, connect the steel mounting attachments to the joint face of the concrete floor assembly (Item 1) according to the curtain wall manufacturer's instructions. Limit distance between steel mounting attachments to maximum 120".
 - B. Steel Stud Framing: Use minimum 3-5/8" by 1-5/8", 18 GA, C-shaped steel studs as vertical framing. Attach according to the curtain wall system manufacturer's guidelines. Limit distance between vertical steel stud framing to maximum 48". Limit distance between horizontal steel stud framing to maximum 72". When required, install horizontal structural framing members according to the curtain wall system manufacturer's guidelines and, in the spandrel area, locate a minimum of 20" above the top surface of the concrete floor assembly (Item 1).
 - C. Aluminum Panels: Install minimum 1/8" thick aluminum panels with maximum dimensions of 48" by 144" to steel stud framing (Item 2B) according to the curtain wall system manufacturer's guidelines.
 - D. Impaling Pins: When used with curtain wall insulation (Item 2E), locate, size and install impaling pins according to the curtain wall system manufacturer's guidelines, or be a minimum 4-1/2" long, 12 GA pin attached to one of the following: a nominal 2" by 2" plate; a nominal 2" by 2" by 2" long angle; or can be directly attached to the steel stud framing (Item 2B) using a stud gun. Space impaling pins a maximum of 12" oc vertically and 20" oc horizontally. Install impaling pins around the periphery of the curtain wall insulation (Item 2E) so that its interior face is flush with the interior face of the steel stud framing (Item 2B).

Design No. 3MU/JS 180-03 *continued*

Construction Joints

Perimeter Joint

- E. **Curtain Wall Insulation:** Use nominal 24" wide, 4" thick, 4-pcf density, 3" thick, 6-pcf density, or 2" thick, 8-pcf density, mineral wool batt insulation faced on one side with aluminum foil scrim (vapor retarder), which is exposed to the room interior and installed in the stud cavity. Install curtain wall insulation by fitting in each stud cavity between steel stud framing (Item 2B) using clips, impaling pins (Item 2D), or friction fit by using a curtain wall insulation lengths at least 1/4" longer than the distance between steel stud framing (Item 2B). Maintain 1-1/4" air cavity between curtain wall insulation and aluminum panels (Item 2C). Completely fill the recess of the "C-shaped" steel stud framing (Item 2B) with curtain wall insulation. Tightly compress together butt joints in the lengths of curtain wall insulation by using minimum 1/4" compression per piece of curtain wall insulation material. Tape all adjacent edges between curtain wall insulation, or between steel stud framing (Item 2B) and curtain wall insulation, with minimum 4" wide pressure sensitive aluminum foil tape, centered over the seam. Locate horizontal seams in the curtain wall insulation at least 6" above or below the top surface of the perimeter joint protection (Item 3). Use only Intertek certified products meeting the above minimum requirements.
- F. **Framing Covers:** Make from strips of 1", 8 pcf density, mineral wool batt insulation faced on one side with aluminum foil scrim (vapor retarder), which is exposed to the room interior. Cut strips a minimum 1-1/2" wider than steel stud framing (Item 2B). Center framing covers over all steel stud framing (Item 2B) and secure using impaling pins (Item 2D). Do not pass framing covers through the perimeter joint protection (Item 3). Allow framing covers to abut the top and the bottom surfaces of the perimeter joint protection (Item 3) provided that no deformation occurs. Use only Intertek certified products meeting the above minimum requirements.
- G. **Glass Vision Panels:** When required, use optional glass vision panels a minimum 20" above the top surface of the floor assembly (Item 1). Install glass vision panels to curtain wall framing according to the curtain wall system manufacturer's guidelines. Use a minimum 1/4" thick, clear tempered glass with a nominal width and height as determined by the framing.
- H. **Window Gaskets:** (Not shown) When optional glass vision panels used, secure glass vision panels with a thermal break (thermo-set rubber extrusion).
- I. **Window Framing:** (Not shown) When glass vision panels used, use steel framing members a minimum 3-5/8" by 1-5/8", 18 GA steel, U-shaped channel or similar construction compatible with structural framing (Item 2B). Locate window framing at least 20" above the top surface of the floor assembly.
3. **PERIMETER JOINT PROTECTION:** Do not exceed an 8" nominal joint width (joint width at installation). Incorporate the following construction features for the perimeter joint protection (also known as perimeter fire barrier system):
- A. **Packing Material:** Install reinforcing angle (Item 3C). Use a minimum 4" thick, 4 pcf density, mineral wool batt insulation installed with the fibers running parallel to the edge of concrete floor assembly (Item 1) and curtain wall assembly (Item 2). Cut packing material width to achieve required compression, refer below, when installed in the nominal joint width. Compress the packing material into the perimeter joint. Tightly compress together splices (butt joints) in the lengths of packing material by using minimum 1/4" compression per piece of packing material. When a spray coating is used, locate the top surface of the packing material flush with the top surface of the concrete floor assembly (Item 1). When the non-sag or self leveling silicone sealant is used, recess the top surface of the packing material 1/4" from the top surface of the concrete floor assembly (Item 1). Use only Intertek certified products meeting the above minimum requirements.
- I. When 50% compression is required cut the width of the packing material 2 times wider than the nominal joint width.
- II. When 33% compression is required cut the width of the packing material 1.5 times wider than the nominal joint width.
- B. **CERTIFIED COMPANY:** 3M Company
CERTIFIED PRODUCT: FireDam™ or Fire Barrier™
MODEL: FD Spray 200 (Elastomeric, Sprayable) or FB 1000 N/S Silicone Sealant (Non-sag) or FB 1003 S/L (Self Leveling) Sealant
Fill, Void or Cavity Material: Apply either spray coating or sealant over the packing material (Item 3A) as follows:
Spray Coating – Spray apply the liquid to cover the exposed top surface of the packing material (Item 3A) compressed and installed in the perimeter joint. Apply a minimum wet film thickness of 1/8" and overlap the spray coating a minimum 1/2" onto the adjacent curtain wall assembly (Item 2) and concrete floor assembly (Item 1). When the spraying process is stopped and the applied spray coating cures to an elastomeric film before installation process is restarted, then overlap the edge of the cured spray coating at least 1/8" with the liquid spray coating.
Sealant – Apply non-sag or self leveling sealant to cover the exposed surface of the packing material (Item 3A) compressed and installed in the perimeter joint. Apply minimum 1/4" thickness non-sag or self leveling sealant over the packing material (Item 3A) and finish flush with the top surface of the concrete floor assembly (Item 1).
- C. **Reinforcing Angle:** Mount a minimum 1-1/2" x 1-1/2", 20 GA galvanized-steel angle to the steel stud framing (Item 2B) so that the vertical leg serves as a backer to the exterior face of the curtain wall insulation (Item 2E) and the horizontal leg extends away from the curtain wall insulation and is located at the centerline of the packing material (Item 3A). Size the angle 12" longer than the span between the interior edges of the steel stud framing (Item 2B) and form the angle so that it has a 6" vertical leg on each end. Secure the 6" vertical leg on each end to the steel stud framing (Item 2B) on each side with three #10 steel self-tapping sheet metal screws placed in a triangular fashion with a maximum spacing of 2" oc.

This material was extracted and drawn by 3M Fire Protection Products from the 2012 Product Directory, © Intertek

JS

Design Number 3MU/JS 180-04

(Formerly OPL Design No. CEJ 166 P)

November 14, 2011

PERIMETER FIRE BARRIERS

3M Company

FireDam™ Spray 200, Fire Barrier 1000 NS Silicone Sealant and

Fire Barrier 1003 SL Silicone Sealant

ASTM E 2307

T-Rating Refer to Compression Percentage

F-Rating 3 hr

ASTM E 2307/ASTM E 1399 Cycling

Class IV: 500 cycles @ 30 cpm

Rated for ± 16.7% horizontal movement @ 50% Compression (Reference Item 3A): T-Rating 2-1/2 hr

Rated for ± 11% horizontal movement @ 33% Compression (Reference Item 3A): T-Rating 1-1/2 hr

Rated for ± 6.25% vertical shear movement @ 50% Compression (Reference Item 3A)

UL 2079

L-Rating <1.0 SCFM/LF

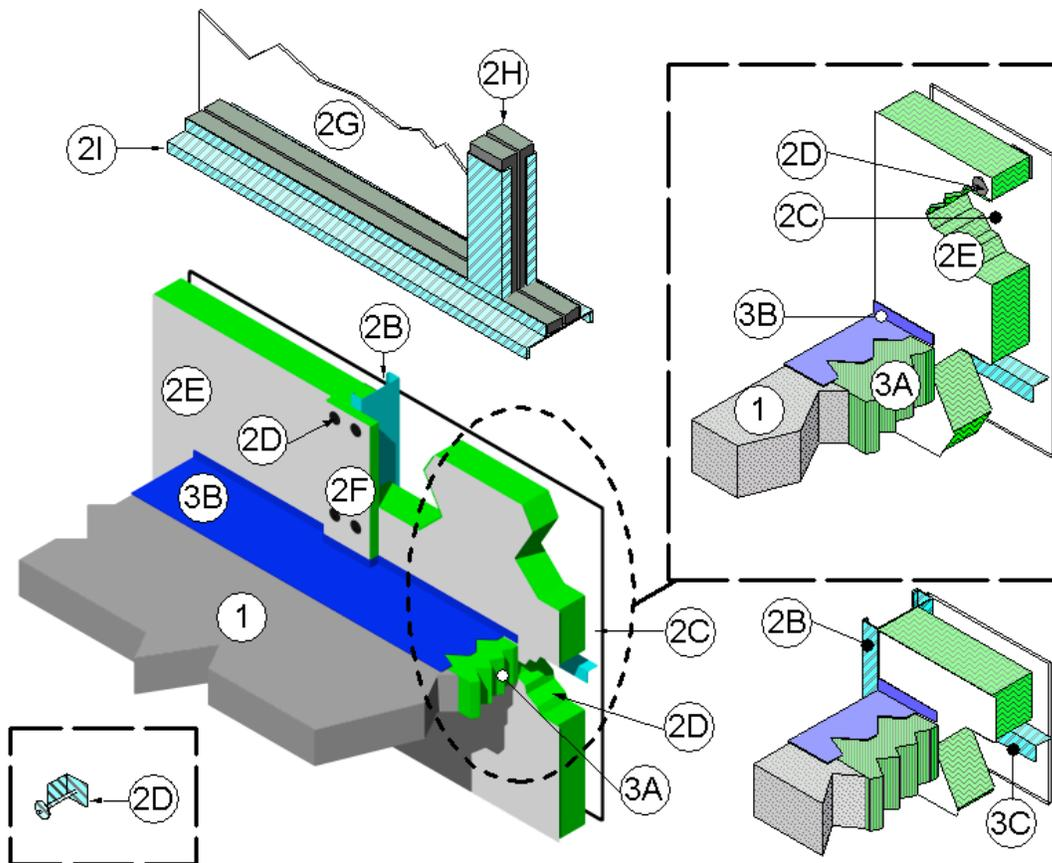

1. CONCRETE FLOOR ASSEMBLY: Three-hour rated concrete floor assembly made from either lightweight or normal weight concrete with a density of 100 to 150 pcf, having a minimum thickness of 4-1/2" at the joint face. When a longitudinal recess (blockout) is required to contain an architectural joint system, increase concrete floor assembly thickness to maintain a minimum thickness of 4-1/2" and accommodate depth of blockout formed in the concrete: blockout width unrestricted.
2. CURTAIN WALL ASSEMBLY: Incorporate the following construction features into the curtain wall assembly:
 - A. Panel Mounting Attachment: (Not shown) Install steel attachments to the steel stud framing (Item 2B) according to the curtain wall manufacturer's instructions. When required, connect the steel mounting attachments to the joint face of the concrete floor assembly (Item 1) according to the curtain wall manufacturer's instructions. Limit distance between steel mounting attachments to maximum 120".
 - B. Steel Stud Framing: Use minimum 3-5/8" by 1-5/8", 18 GA, C-shaped steel studs as vertical framing. Attach according to the curtain wall system manufacturer's guidelines. Limit distance between vertical steel stud framing to maximum 48". Limit distance between horizontal steel stud framing to maximum 72". When required, install horizontal structural framing members according to the curtain wall system manufacturer's guidelines and, in the spandrel area, locate a minimum of 20" above the top surface of the concrete floor assembly (Item 1).
 - C. Glass Panels: Secure glass panels to curtain wall framing according to the curtain wall system manufacturer's guidelines. Use a minimum 1/4" thick clear, heat-strengthened (HS) or tempered glass with a maximum width of 48".
 - D. Impaling Pins: When used with curtain wall insulation (Item 2E), locate, size and install impaling pins according to the curtain wall system manufacturer's guidelines, or be a minimum 4-1/2" long, 12 GA pin attached to one of the following: a nominal 2" by 2" plate; a nominal 2" by 2" by 2" long angle; or can be directly attached to the steel stud framing (Item 2B) using a stud gun. Space impaling pins a maximum of 12" oc vertically and 20" oc horizontally. Install impaling pins around the periphery of the curtain wall insulation (Item 2E) so that its interior face is flush with the interior face of the steel stud framing (Item 2B).

Design No. 3MU/JS 180-04 *continued*

Construction Joints

Perimeter Joint

- E. **Curtain Wall Insulation:** Use nominal 24" wide, 4" thick, 4-pcf density, 3" thick, 6-pcf density, or 2" thick, 8-pcf density, mineral wool batt insulation faced on one side with aluminum foil scrim (vapor retarder), which is exposed to the room interior and installed in the stud cavity. Install curtain wall insulation by fitting in each stud cavity between steel stud framing (Item 2B) using clips, impaling pins (Item 2D), or friction fit by using a curtain wall insulation lengths at least 1/4" longer than the distance between steel stud framing (Item 2B). Maintain 1-1/4" air cavity between curtain wall insulation and aluminum panels (Item 2C). Completely fill the recess of the "C-shaped" steel stud framing (Item 2B) with curtain wall insulation. Tightly compress together butt joints in the lengths of curtain wall insulation by using minimum 1/4" compression per piece of curtain wall insulation material. Tape all adjacent edges between curtain wall insulation, or between steel stud framing (Item 2B) and curtain wall insulation, with minimum 4" wide pressure sensitive aluminum foil tape, centered over the seam. Locate horizontal seams in the curtain wall insulation at least 6" above or below the top surface of the perimeter joint protection (Item 3). Use only Intertek certified products meeting the above minimum requirements.
- F. **Framing Covers:** Make from strips of 1", 8-pcf density, mineral wool batt insulation faced on one side with aluminum foil scrim (vapor retarder), which is exposed to the room interior. Cut strips a minimum 1-1/2" wider than steel stud framing (Item 2B). Center framing covers over all steel stud framing (Item 2B) and secure using impaling pins (Item 2D). Do not pass framing covers through the perimeter joint protection (Item 3). Allow framing covers to abut the top and the bottom surfaces of the perimeter joint protection (Item 3) provided that no deformation occurs. Use only Intertek certified products meeting the above minimum requirements.
- G. **Glass Vision Panels:** When required, use optional glass vision panels a minimum 20" above the top surface of the floor assembly (Item 1). Install glass vision panels to curtain wall framing according to the curtain wall system manufacturer's guidelines. Use a minimum 1/4" thick, clear tempered glass with a nominal width and height as determined by the framing.
- H. **Window Gaskets:** When optional glass vision panels used, secure glass vision panels with a thermal break (thermo-set rubber extrusion).
- I. **Window Framing:** When glass vision panels used, use steel framing members a minimum 3-5/8" by 1-5/8", 18 GA steel, U-shaped channel or similar construction compatible with structural framing (Item 2B). Locate window framing at least 20" above the top surface of the floor assembly.
3. **PERIMETER JOINT PROTECTION:** Do not exceed an 8" nominal joint width (joint width at installation). Incorporate the following construction features for the perimeter joint protection (also known as perimeter fire barrier system):
- A. **Packing Material:** Install reinforcing angle (Item 3C). Use a minimum 4" thick, 4-pcf density, mineral wool batt insulation installed with the fibers running parallel to the edge of concrete floor assembly (Item 1) and curtain wall assembly (Item 2). Cut packing material width to achieve required compression, refer below, when installed in the nominal joint width. Compress the packing material into the perimeter joint. Tightly compress together splices (butt joints) in the lengths of packing material by using minimum 1/4" compression per piece of packing material. When a spray coating is used, locate the top surface of the packing material flush with the top surface of the concrete floor assembly (Item 1). When the non-sag or self leveling silicone sealant is used, recess the top surface of the packing material 1/4" from the top surface of the concrete floor assembly (Item 1). Use only Intertek certified products meeting the above minimum requirements.
- I. When 50% compression is required cut the width of the packing material 2 times wider than the nominal joint width.
- II. When 33% compression is required cut the width of the packing material 1.5 times wider than the nominal joint width.
- B. **CERTIFIED COMPANY:** 3M Company
CERTIFIED PRODUCT: FireDam™ or Fire Barrier™
MODEL: FD Spray 200 (Elastomeric, Sprayable) or FB 1000 N/S Silicone Sealant (Non-sag) or FB 1003 S/L (Self Leveling) Sealant
Fill, Void or Cavity Material: Apply either spray coating or sealant over the packing material (Item 3A) as follows:
Spray Coating – Spray apply the liquid to cover the exposed top surface of the packing material (Item 3A) compressed and installed in the perimeter joint. Apply a minimum wet film thickness of 1/8" and overlap the spray coating a minimum 1/2" onto the adjacent curtain wall assembly (Item 2) and concrete floor assembly (Item 1). When the spraying process is stopped and the applied spray coating cures to an elastomeric film before installation process is restarted, then overlap the edge of the cured spray coating at least 1/8" with the liquid spray coating.
Sealant – Apply non-sag or self leveling sealant to cover the exposed surface of the packing material (Item 3A) compressed and installed in the perimeter joint. Apply minimum 1/4" thickness non-sag or self leveling sealant over the packing material (Item 3A) and finish flush with the top surface of the concrete floor assembly (Item 1).
- C. **Reinforcing Angle:** Mount a minimum 1-1/2" x 1-1/2", 20 GA galvanized-steel angle to the steel stud framing (Item 2B) so that the vertical leg serves as a backer to the exterior face of the curtain wall insulation (Item 2E) and the horizontal leg extends away from the curtain wall insulation and is located at the centerline of the packing material (Item 3A). Size the angle 12" longer than the span between the interior edges of the steel stud framing (Item 2B) and form the angle so that it has a 6" vertical leg on each end. Secure the 6" vertical leg on each end to the steel stud framing (Item 2B) on each side with three No. 10 steel self-tapping sheet metal screws placed in a triangular fashion with a maximum spacing of 2" oc.

This material was extracted and drawn by 3M Fire Protection Products from the 2012 Product Directory, © Intertek

JS

Design Number 3MU/JS 180-05

(Formerly OPL Design No. CEJ 167 P)

November 14, 2011

PERIMETER FIRE BARRIERS

3M Company

FireDam™ Spray 200, Fire Barrier 1000 NS Silicone Sealant and

Fire Barrier 1003 SL Silicone Sealant

ASTM E 2307

T-Rating Refer to Compression Percentage

F-Rating 3 hr

ASTM E 2307/ASTM E 1399 Cycling

Class IV: 500 cycles @ 30 cpm

Rated for ± 16.7% horizontal movement @ 50% Compression (Reference Item 3A): T-Rating 2-1/2 hr

Rated for ± 11% horizontal movement @ 33% Compression (Reference Item 3A): T-Rating 1-1/2 hr

Rated for ± 6.25% vertical shear movement @ 50% Compression (Reference Item 3A)

UL 2079

L-Rating <1.0 SCFM/LF

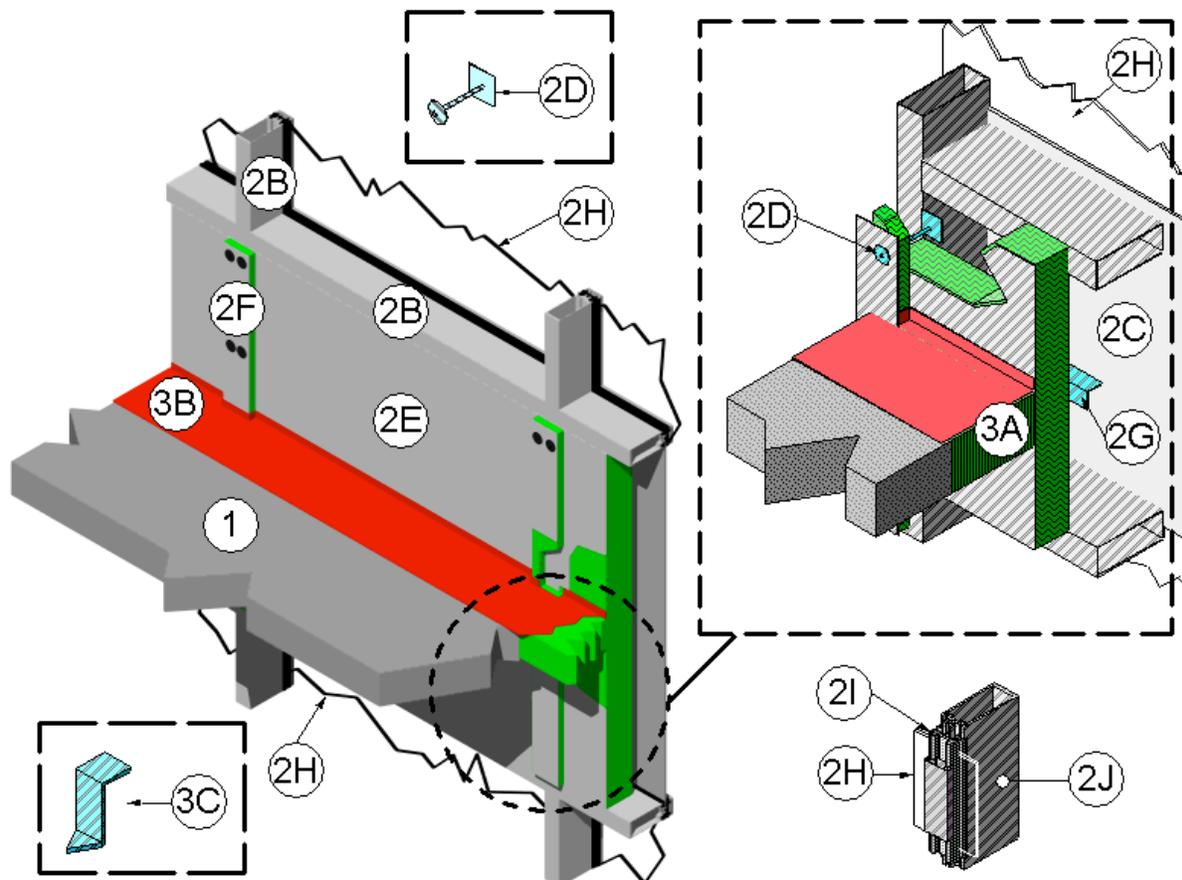

1. CONCRETE FLOOR ASSEMBLY: Three-hour rated concrete floor assembly made from either lightweight or normal weight concrete with a density of 100 to 150 pcf, having a minimum thickness of 4-1/2" at the joint face. When a longitudinal recess (blockout) is required to contain an architectural joint system, increase concrete floor assembly thickness to maintain a minimum thickness of 4-1/2" and accommodate depth of blockout formed in the concrete: blockout width unrestricted.
2. CURTAIN WALL ASSEMBLY: Incorporate the following construction features:
 - A. Mounting Attachment: (Not shown) Attach aluminum framing (Item 2B) to the structural framing according to the curtain wall manufacturer's instructions. When required, connect the mounting attachments to the joint face of the concrete floor assembly (Item 1) according to the curtain wall manufacturer's instructions. Limit distance between mounting attachments to maximum 120".
 - B. Aluminum Framing: Use hollow rectangular aluminum extruded tubing with minimum overall dimensions of 0.100" thick, 5-1/2" high and 2-1/2" wide. Locate mullions (vertical aluminum framing) minimum 60" oc and locate transoms (horizontal aluminum framing) a minimum 48" oc. For the spandrel region, locate the upper transom a minimum 20" above the concrete floor assembly (Item 1) as measured from the top surface of the concrete floor assembly (Item 1) to the underside of the transom.
 - C. Aluminum Panels: Install minimum 1/8" thick aluminum panels with minimum dimensions of 48" by 60" to aluminum framing (Item 2B) according to the curtain wall system manufacturer's guidelines.
 - D. Impaling Pins: Use with curtain wall insulation (Item 2E) and framing covers (Item 2F), locate, size and install impaling pins according to the curtain wall system manufacturer's guidelines, or be a minimum 4-1/2" long, 12 GA pin attached to one of the following: a nominal 2" by 2" plate; a nominal 2" by 2" by 2" long angle; or can be directly attached to the aluminum framing (Item 2B) using a stud gun. Space impaling pins a maximum of 12" oc vertically and 20" oc horizontally. Install impaling pins around the periphery of the curtain wall insulation (Item 2E) so that its interior face is flush with the interior face of the aluminum framing (Item 2B).

Design No. 3MU/JS 180-05 *continued*

Construction Joints

Perimeter Joint

- E. **Curtain Wall Insulation:** Use nominal 24" wide, 4" thick, 4-pcf density, 3" thick, 6-pcf density, or 2" thick, 8-pcf density, mineral wool batt insulation faced on one side with aluminum foil scrim (vapor retarder), which is exposed to the room interior and installed in the stud cavity. Install curtain wall insulation between aluminum framing (Item 2B). Secure curtain wall insulation with clips or impaling pins. Seal all meeting edges of curtain wall insulation with nominal 4" wide pressure sensitive aluminum foil faced tape (not shown) centered over the junction so that approximately 2" of tape covers each edge of the adjacent curtain wall insulation. Apply pressure sensitive aluminum foil faced tape over all meeting edges of curtain wall insulation and framing covers (Item 2F) so that approximately 2" covers each edge of the adjacent material. Install curtain wall insulation flush with the interior face of the aluminum framing (Item 2B). Install 24" wide curtain wall insulation without vertical seams, spanning the full length between aluminum framing (Item 2B). Locate horizontal seams in the curtain wall insulation at least 6" from the top surface of the perimeter joint protection (Item 3). Maintain 1-1/4" air cavity between curtain wall insulation and aluminum panels (Item 2C). Option – in lieu of filling the full depth of the stud cavity with 4" thick, 4-pcf density curtain wall insulation, use minimum 2" thick, 8-pcf density curtain wall insulation mechanically secured (do not secure by friction fit) and use additional horizontal support angle (not shown). Locate a horizontal support angle consisting of a minimum 20 GA steel angle, having 1.5" x 1.5" legs horizontally at the mid height of the packing material (Item 3A) and attached to each mullion of aluminum framing (Item 2B) using minimum #6, 1/2" long self-tapping sheet metal screws. Use only Intertek certified products meeting the above minimum requirements.
- F. **Framing Covers:** Make from strips of minimum 1" thick by minimum 4" wide, 8-pcf density, mineral wool batt insulation faced on one side with aluminum foil scrim (vapor retarder), which is exposed to the room interior. Center framing covers over all aluminum framing (Item 2B) and secure using impaling pins (Item 2D). Do not pass framing covers through the perimeter joint protection (Item 3). Allow framing covers to abut top and bottom surfaces of the perimeter joint protection (Item 3) provided that no deformation occurs. Use only Intertek certified products meeting the above minimum requirements.
- G. **Reinforcing Angle:** Mount a minimum 1-1/2 x 1-1/2", 20 gauge, galvanized-steel angle to the aluminum mullions (Item 2B) so that the vertical leg serves as a backer to the exterior face of the curtain wall insulation (Item 2E) and the horizontal leg extends away from the curtain wall insulation and is located at the centerline of the packing material (Item 3A). Size the angle 12" longer than the span between the interior edges of the aluminum mullions (Item 2B) and form the angle so that it has a 6" vertical leg on each end. Secure the 6" vertical leg on each end to the steel stud framing (Item 2B) on each side with three No. 10 steel self-tapping sheet metal screws placed in a triangular fashion with a maximum spacing of 2" oc.
- H. **Glass Vision Panels:** When required, use optional glass vision panels a minimum 20" above the top surface of the floor assembly (Item 1). Install glass vision panels to curtain wall framing according to the curtain wall system manufacturer's guidelines. Use a minimum 1/4" thick, clear tempered glass with a nominal width and height as determined by the framing.
- I. **Window Gaskets:** When optional glass vision panels used, secure glass vision panels with a thermal break (thermo-set rubber extrusion).
- J. **Window Framing:** Use tubing mullions and transoms, sized according to the curtain wall system manufacturer's guidelines. Minimum required framing dimensions, use 0.100" thick walls with minimum 5-1/2" depth and minimum 2-1/2" width and window framing must be compatible with steel framing (Item 2B). Locate window framing at least 20" above the top surface of the floor assembly.
3. **PERIMETER JOINT PROTECTION:** Do not exceed an 8" nominal joint width (joint width at installation). Incorporate the following construction features for the perimeter joint protection (also known as perimeter fire barrier system):
- A. **Packing Material:** Use a minimum 4" thick, 4-pcf density, mineral wool batt insulation installed with the fibers running parallel to the edge of concrete floor assembly (Item 1) and curtain wall assembly (Item 2). Cut packing material width to achieve required compression, refer below, when installed in the nominal joint width. Compress the packing material into the perimeter joint. Tightly compress together splices (butt joints) in the lengths of packing material by using minimum 1/4" compression per piece of packing material. Use only Intertek certified products meeting the above minimum requirements. When a spray coating is used, locate the top surface of the packing material flush with the top surface of the concrete floor assembly (Item 1). When the non-sag or self leveling silicone sealant is used, recess the top surface of the packing material 1/4" from the top surface of the concrete floor assembly (Item 1).
- When 50% compression is required cut the width of the packing material 2 times wider than the nominal joint width.
 - When 33% compression is required cut the width of the packing material 1.5 times wider than the nominal joint width.
- B. **CERTIFIED MANUFACTURER:** 3M Company
CERTIFIED PRODUCT: FireDam™ or Fire Barrier™
MODEL: FD Spray 200 (Elastomeric, Sprayable) or FB 1000 N/S Silicone Sealant (Non-sag) or FB 1003 S/L (Self Leveling) Sealant
Fill, Void or Cavity Material: Apply either spray coating or sealant over the packing material (Item 3A) as follows:
Spray Coating – Spray apply the liquid to cover the exposed top surface of the packing material (Item 3A) compressed and installed in the perimeter joint. Apply a minimum wet film thickness of 1/8" and overlap the spray coating a minimum 1/2" onto the adjacent curtain wall assembly (Item 2) and concrete floor assembly (Item 1). When the spraying process is stopped and the applied spray coating cures to an elastomeric film before installation process is restarted, then overlap the edge of the cured spray coating at least 1/8" with the liquid spray coating.
Sealant – Apply non-sag or self leveling sealant to cover the exposed surface of the packing material (Item 3A) compressed and installed in the perimeter joint. Apply minimum 1/4" thickness non-sag or self leveling sealant over the packing material (Item 3A) and finish flush with the top surface of the concrete floor assembly (Item 1).
- C. **Support Clips:** (Optional) Recommended for installations subject to vertical shear movement. Use standard 20 GA galvanized steel Z-shaped clips having the following nominal dimensions: 1" wide by 3" high with a 2" upper leg and a 3" lower leg.

This material was extracted and drawn by 3M Fire Protection Products from the 2012 Product Directory, © Intertek

JS

Design Number 3MU/JS 180-06

(Formerly OPL Design No. CEJ 168 P)

November 14, 2011

PERIMETER FIRE BARRIERS

3M Company

FireDam™ Spray 200, Fire Barrier 1000 NS Silicone Sealant and

Fire Barrier 1003 SL Silicone Sealant

ASTM E 2307

T-Rating Refer to Compression Percentage

F-Rating 3 hr

ASTM E 2307/ASTM E 1399 Cycling

Class IV: 500 cycles @ 30 cpm

Rated for ± 16.7% horizontal movement @ 50% Compression (Reference Item 3A): T-Rating 2-1/2 hr

Rated for ± 11% horizontal movement @ 33% Compression (Reference Item 3A): T-Rating 1-1/2 hr

Rated for ± 6.25% vertical shear movement @ 50% Compression (Reference Item 3A)

UL 2079

L-Rating <1.0 SCFM/LF

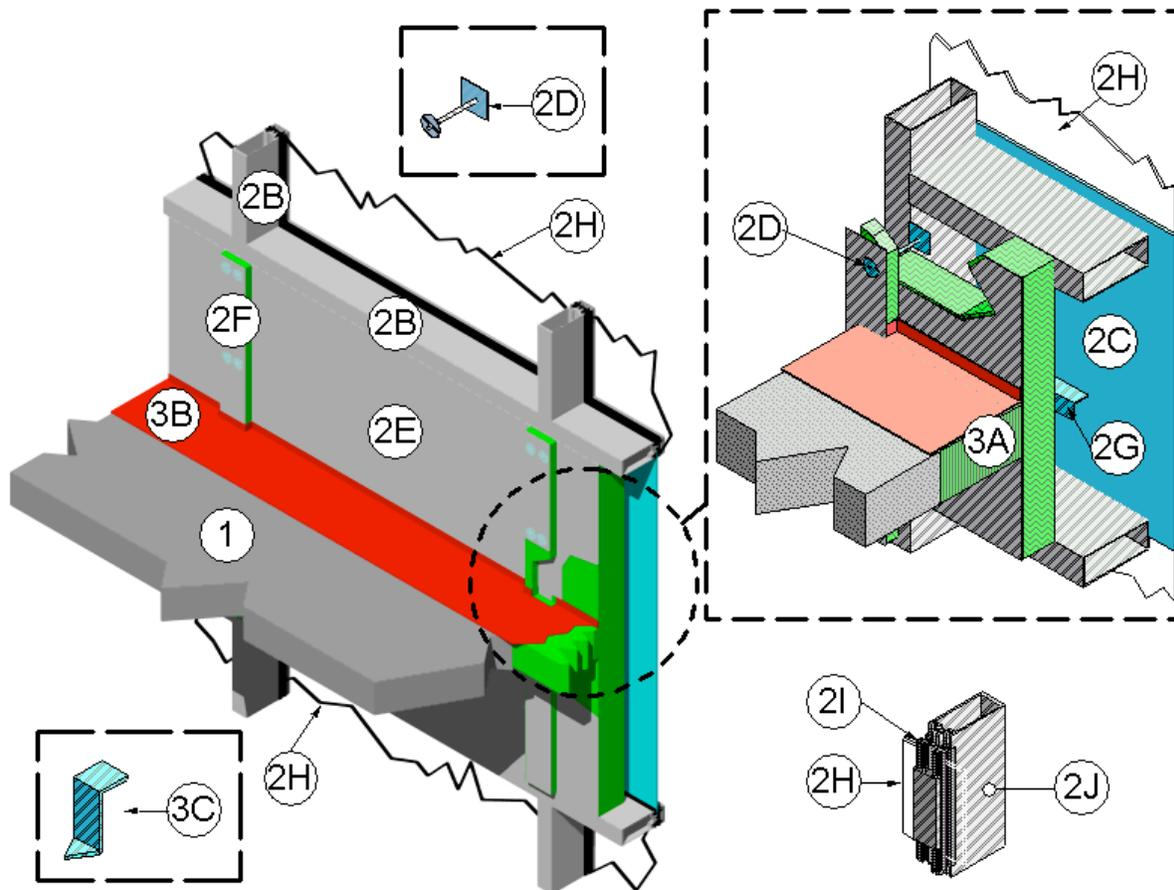

1. CONCRETE FLOOR ASSEMBLY: Three-hour rated concrete floor assembly made from either lightweight or normal weight concrete with a density of 100 to 150 pcf, having a minimum thickness of 4-1/2" at the joint face. When a longitudinal recess (blockout) is required to contain an architectural joint system, increase concrete floor assembly thickness to maintain a minimum thickness of 4-1/2" and accommodate depth of blockout formed in the concrete: blockout width unrestricted.
2. CURTAIN WALL ASSEMBLY: Incorporate the following construction features:
 - A. Mounting Attachment: (Not shown) Attach aluminum framing (Item 2B) to the structural framing according to the curtain wall manufacturer's instructions. When required, connect the mounting attachments to the joint face of the concrete floor assembly (Item 1) according to the curtain wall manufacturer's instructions. Limit distance between mounting attachments to maximum 120".
 - B. Aluminum Framing: Use hollow rectangular aluminum extruded tubing with minimum overall dimensions of 0.100" thick, 5-1/2" high and 2-1/2" wide. Locate mullions (vertical aluminum framing) minimum 60" oc and locate transoms (horizontal aluminum framing) a minimum 48" oc. For the spandrel region, locate the upper transom a minimum 20" above the concrete floor assembly (Item 1) as measured from the top surface of the concrete floor assembly (Item 1) to the underside of the transom.
 - C. Steel Panels: Install minimum 20 GA steel panels with minimum dimensions of 48" by 60" to aluminum framing (Item 2B) according to the curtain wall system manufacturer's guidelines.
 - D. Impaling Pins: Use with curtain wall insulation (Item 2E) and framing covers (Item 2F), locate, size and install impaling pins according to the curtain wall system manufacturer's guidelines, or be a minimum 4-1/2" long, 12 GA pin attached to one of the following: a nominal 2" by 2" plate; a nominal 2" by 2" by 2" long angle; or can be directly attached to the aluminum framing (Item 2B) using a stud gun. Space impaling pins a maximum of 12" oc vertically and 20" oc horizontally. Install impaling pins around the periphery of the curtain wall insulation (Item 2E) so that its interior face is flush with the interior face of the aluminum framing (Item 2B).

Design No. 3MU/JS 180-06 *continued*

Construction Joints

Perimeter Joint

- E. **Curtain Wall Insulation:** Use nominal 24" wide, 4" thick, 4-pcf density, 3" thick, 6-pcf density, or 2" thick, 8-pcf density, mineral wool batt insulation faced on one side with aluminum foil scrim (vapor retarder), which is exposed to the room interior and installed in the stud cavity. Install curtain wall insulation between aluminum framing (Item 2B). Secure curtain wall insulation with clips, impaling pins, or friction fit using curtain wall insulation length at least 1/4" longer than the distance between aluminum framing (Item 2B). Seal all meeting edges of curtain wall insulation with nominal 4" wide pressure sensitive aluminum foil faced tape (not shown) centered over the junction so that approximately 2" of tape covers each edge of the adjacent curtain wall insulation. Apply pressure sensitive aluminum foil faced tape over all meeting edges of curtain wall insulation and framing covers (Item 2F) so that approximately 2" covers each edge of the adjacent material. Install curtain wall insulation flush with the interior face of the aluminum framing (Item 2B). Install 24" wide curtain wall insulation without vertical seams, spanning the full length between aluminum framing (Item 2B). Locate horizontal seams in the curtain wall insulation at least 6" from the top surface of the perimeter joint protection (Item 3). Maintain 1-1/4" air cavity between curtain wall insulation and steel panels (Item 2C). Option – in lieu of filling the full depth of the stud cavity with 4" thick, 4-pcf density curtain wall insulation, use minimum 2" thick, 8-pcf density curtain wall insulation mechanically secured (do not secure by friction fit) and use additional horizontal support angle (not shown). Use only Intertek certified products meeting the above minimum requirements.
- F. **Framing Covers:** Make from strips of minimum 1" thick by minimum 4" wide, 8-pcf density, mineral wool batt insulation faced on one side with aluminum foil scrim (vapor retarder), which is exposed to the room interior. Center framing covers over all aluminum framing (Item 2B) and secure using impaling pins (Item 2D). Do not pass framing covers through the perimeter joint protection (Item 3). Allow framing covers to abut top and bottom surfaces of the perimeter joint protection (Item 3) provided that no deformation occurs. Use only Intertek certified products meeting the above minimum requirements.
- G. **Reinforcing Angle:** Mount a minimum 1-1/2" x 1-1/2", 20 GA galvanized-steel angle to the aluminum mullions (Item 2B) so that the vertical leg serves as a backer to the exterior face of the curtain wall insulation (Item 2E) and the horizontal leg extends away from the curtain wall insulation and is located at the centerline of the packing material (Item 3A). Size the angle 12" longer than the span between the interior edges of the aluminum mullions (Item 2B) and form the angle so that it has a 6" vertical leg on each end. Secure the 6" vertical leg on each end to the steel stud framing (Item 2B) on each side with three #10 steel self-tapping sheet metal screws placed in a triangular fashion with a maximum spacing of 2" oc.
- H. **Glass Vision Panels:** When required, use optional glass vision panels a minimum 20" above the top surface of the floor assembly (Item 1). Install glass vision panels to curtain wall framing according to the curtain wall system manufacturer's guidelines. Use a minimum 1/4" thick, clear tempered glass with a nominal width and height as determined by the framing.
- I. **Window Gaskets:** When optional glass vision panels used, secure glass vision panels with a thermal break (thermo-set rubber extrusion).
- J. **Window Framing:** Use tubing mullions and transoms, sized according to the curtain wall system manufacturer's guidelines. Minimum required framing dimensions, use 0.100" thick walls with minimum 5-1/2" depth and minimum 2-1/2" width and window framing must be compatible with steel framing (Item 2B). Locate window framing at least 20" above the top surface of the floor assembly.
3. **PERIMETER JOINT PROTECTION:** Do not exceed an 8" nominal joint width (joint width at installation). Incorporate the following construction features for the perimeter joint protection (also known as perimeter fire barrier system):
- A. **Packing Material:** Use a minimum 4" thick, 4-pcf density, mineral wool batt insulation installed with the fibers running parallel to the edge of concrete floor assembly (Item 1) and curtain wall assembly (Item 2). Cut packing material width to achieve required compression, refer below, when installed in the nominal joint width. Compress the packing material into the perimeter joint. Tightly compress together splices (butt joints) in the lengths of packing material by using minimum 1/4" compression per piece of packing material. When a spray coating is used, locate the top surface of the packing material flush with the top surface of the concrete floor assembly (Item 1). When the non-sag or self leveling silicone sealant is used, recess the top surface of the packing material 1/4" from the top surface of the concrete floor assembly (Item 1). Use only Intertek certified products meeting the above minimum requirements.
- When 50% compression is required cut the width of the packing material 2 times wider than the nominal joint width.
 - When 33% compression is required cut the width of the packing material 1.5 times wider than the nominal joint width.
- B. **CERTIFIED MANUFACTURER:** 3M Company
CERTIFIED PRODUCT: FireDam™ or Fire Barrier™
MODEL: FD Spray 200 (Elastomeric, Sprayable) or FB 1000 N/S Silicone Sealant (Non-sag) or FB 1003 S/L (Self Leveling) Sealant
Fill, Void or Cavity Material: Apply either spray coating or sealant over the packing material (Item 3A) as follows:
Spray Coating – Spray apply the liquid to cover the exposed top surface of the packing material (Item 3A) compressed and installed in the perimeter joint. Apply a minimum wet film thickness of 1/8" and overlap the spray coating a minimum 1/2" onto the adjacent curtain wall assembly (Item 2) and concrete floor assembly (Item 1). When the spraying process is stopped and the applied spray coating cures to an elastomeric film before installation process is restarted, then overlap the edge of the cured spray coating at least 1/8" with the liquid spray coating.
Sealant – Apply non-sag or self leveling sealant to cover the exposed surface of the packing material (Item 3A) compressed and installed in the perimeter joint. Apply minimum 1/4" thickness non-sag or self leveling sealant over the packing material (Item 3A) and finish flush with the top surface of the concrete floor assembly (Item 1).
- C. **Support Clips:** (Optional) Recommended for installations subject to vertical shear movement. Use standard 20 GA galvanized steel Z-shaped clips having the following nominal dimensions: 1" wide by 3" high with a 2" upper leg and a 3" lower leg.

This material was extracted and drawn by 3M Fire Protection Products from the 2012 Product Directory, © Intertek

JS

Design Number 3MU/JS 180-07

(Formerly OPL Design No. CEJ 169 P)

June 1, 2011

PERIMETER FIRE BARRIERS

3M Company

FireDam™ Spray 200, Fire Barrier 1000 NS Silicone Sealant and

Fire Barrier 1003 SL Silicone Sealant

ASTM E 2307

T-Rating Refer to Compression Percentage

F-Rating 3 hr

ASTM E 2307/ASTM E 1399 Cycling

Class IV: 500 cycles @ 30 cpm

Rated for ± 16.7% horizontal movement @ 50% Compression (Reference Item 3A): T-Rating 2-1/2 hr

Rated for ± 11% horizontal movement @ 33% Compression (Reference Item 3A): T-Rating 1-1/2 hr

Rated for ± 6.25% vertical shear movement @ 50% Compression (Reference Item 3A)

UL 2079

L-Rating <1.0 SCFM/LF

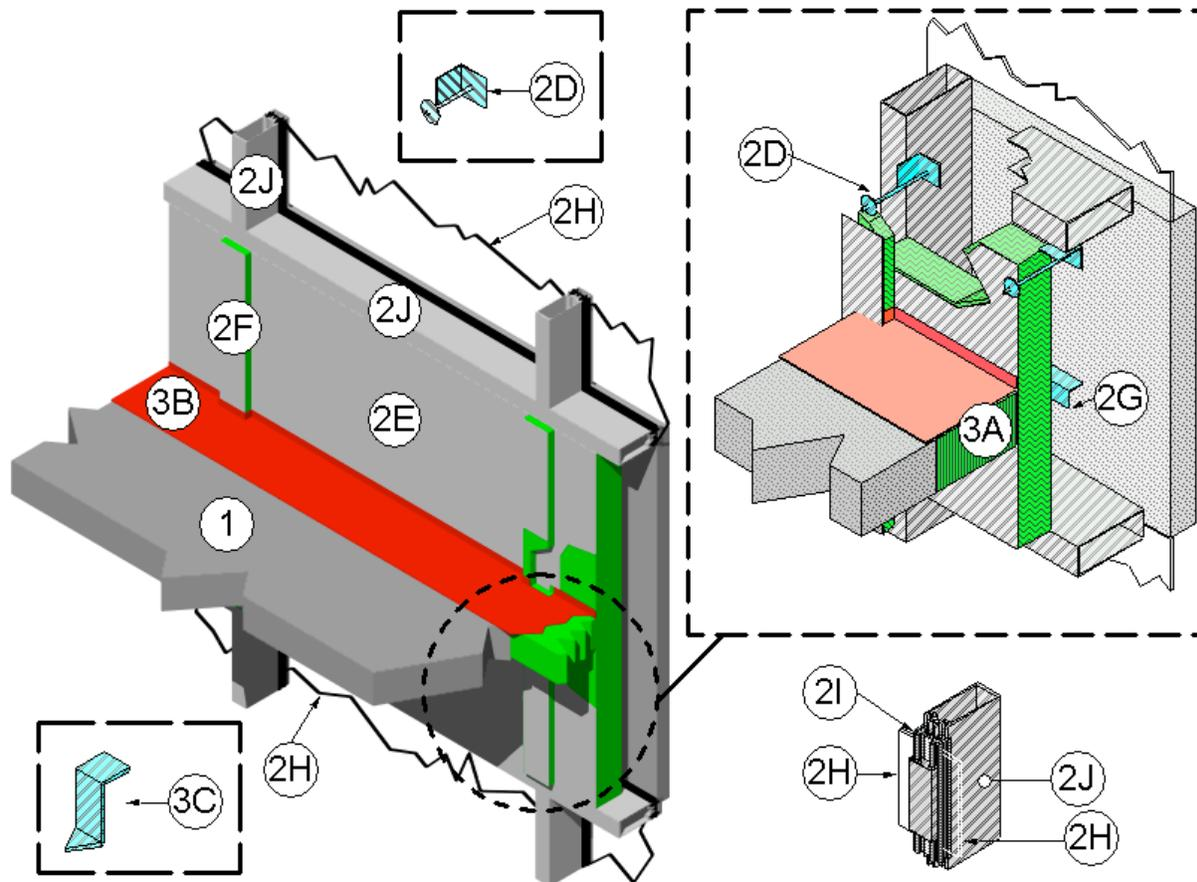

1. CONCRETE FLOOR ASSEMBLY: Three-hour rated concrete floor assembly made from either lightweight or normal weight concrete with a density of 100 to 150 pcf, having a minimum thickness of 4-1/2 in. at the joint face. When a longitudinal recess (blockout) is required to contain an architectural joint system, increase concrete floor assembly thickness to maintain a minimum thickness of 4-1/2 in. and accommodate depth of blockout formed in the concrete: blockout width unrestricted.
2. CURTAIN WALL ASSEMBLY: Incorporate the following construction features:
 - A. Mounting Attachment: (Not shown) Attach aluminum framing (Item 2B) to the structural framing according to the curtain wall manufacturer's instructions. When required, connect the mounting attachments to the joint face of the concrete floor assembly (Item 1) according to the curtain wall manufacturer's instructions. Limit distance between mounting attachments to maximum 120 in..
 - B. Aluminum Framing: Use hollow rectangular aluminum extruded tubing with minimum overall dimensions of 0.100 in. thick, 5-1/2 in. high and 2-1/2 in. wide. Locate mullions (vertical aluminum framing) minimum 60 in. oc and locate transoms (horizontal aluminum framing) a minimum 48 in. oc. For the spandrel region, locate the upper transom a minimum 20 in. above the concrete floor assembly (Item 1) as measured from the top surface of the concrete floor assembly (Item 1) to the underside of the transom.
 - C. Concrete Panels: Use any non-combustible exterior concrete based panels. Use minimum 1-1/2 in. thick, 12 in. high, 12 in. long panels. Attach concrete panels to aluminum framing (Item 2B) according to the curtain wall system manufacturer's requirements.
 - D. Impaling Pins: Use with curtain wall insulation (Item 2E) and framing covers (Item 2F), locate, size and install impaling pins according to the curtain wall system manufacturer's guidelines, or be a minimum 4-1/2 in. long, 12 GA pin attached to one of the following: a nominal 2 in. by 2 in. plate; a nominal 2 in. by 2 in. by 2 in. long angle; or can be directly attached to the aluminum framing (Item 2B) using a stud gun. Space impaling pins a maximum of 12 in. oc. Install impaling pins around the periphery of the curtain wall insulation (Item 2E) so that its interior face is flush with the interior face of the aluminum framing (Item 2B).

Design No. 3MU/JS 180-07 *continued*

Construction Joints

Perimeter Joint

- E. **Curtain Wall Insulation:** Use nominal 24 in. wide, 4 in. thick, 4-pcf density, 3 in. thick, 6-pcf density, or 2 in. thick, 8-pcf density, mineral wool batt insulation faced on one side with aluminum foil scrim (vapor retarder), which is exposed to the room interior and installed in the aluminum framing cavity. Install curtain wall insulation between aluminum framing (Item 2B). Secure curtain wall insulation with clips, impaling pins, or friction fit using curtain wall insulation length at least 1/4 in. longer than the distance between aluminum framing (Item 2B). Seal all meeting edges of curtain wall insulation with nominal 4 in. wide pressure sensitive aluminum foil faced tape (not shown) centered over the junction so that approximately 2 in. of tape covers each edge of the adjacent curtain wall insulation. Apply pressure sensitive aluminum foil faced tape over all meeting edges of curtain wall insulation and framing covers (Item 2F) so that approximately 2 in. covers each edge of the adjacent material. Install curtain wall insulation flush with the interior face of the aluminum framing (Item 2B). Install 24 in. wide curtain wall insulation without vertical seams, spanning the full length between aluminum framing (Item 2B). Locate horizontal seams in the curtain wall insulation at least 6 in. from the top surface of the perimeter joint protection (Item 3). Maintain 1-1/4 in. air cavity between curtain wall insulation and concrete panels (Item 2C). Option – in lieu of filling the full depth of the aluminum framing with 4 in. thick, 4-pcf density curtain wall insulation, use minimum 2 in. thick, 8-pcf density curtain wall insulation mechanically secured (do not secure by friction fit) and use additional horizontal support angle (not shown). Locate a horizontal support angle consisting of a minimum 20 GA steel angle, having 1.5 in. x 1.5 in. legs horizontally at the mid height of the packing material (Item 3A) and attached to each mullion of aluminum framing (Item 2B) using minimum #6, 1/2 in. long self-tapping sheet metal screws. Use only Intertek certified products meeting the above minimum requirements.
- F. **Framing Covers:** Make from strips of minimum 1 in. thick by minimum 4 in. wide, 8-pcf density, mineral wool batt insulation faced on one side with aluminum foil scrim (vapor retarder), which is exposed to the room interior. Center framing covers over all aluminum framing (Item 2B) and secure using impaling pins (Item 2D). Do not pass framing covers through the perimeter joint protection (Item 3). Allow framing covers to abut top and bottom surfaces of the perimeter joint protection (Item 3) provided that no deformation occurs. Use only Intertek certified products meeting the above minimum requirements.
- G. **Reinforcing Angle:** Locate reinforcing angle at all horizontal butt joints of the curtain wall insulation (Item 2E) in the field of the concrete spandrel panels (Item 2C). When horizontal butt joint is located at the horizontal centerline of the perimeter joint protection (Item 3) additional horizontal support angle (not shown) not required.
- H. **Glass Vision Panels:** When required, use optional glass vision panels a minimum 20 in. above the top surface of the floor assembly (Item 1). Install glass vision panels to curtain wall framing according to the curtain wall system manufacturer's guidelines. Use a minimum 1/4 in. thick, clear tempered glass with a nominal width and height as determined by the framing.
- I. **Window Gaskets:** When optional glass vision panels used, secure glass vision panels with a thermal break (thermo-set rubber extrusion).
- J. **Window Framing:** Use tubing mullions and transoms, sized according to the curtain wall system manufacturer's guidelines. Minimum required framing dimensions, use 0.100 in. thick walls with minimum 6-1/2 in. depth and minimum 2-1/2 in. width and window framing must be compatible with steel framing (2B). Locate window framing at least 20 in. above the top surface of the floor assembly.
3. **PERIMETER JOINT PROTECTION:** Do not exceed an 8 in. nominal joint width (joint width at installation). Incorporate the following construction features for the perimeter joint protection (also known as perimeter fire barrier system):
- A. **Packing Material:** Use a minimum 4 in. thick, 4-pcf density, mineral wool batt insulation installed with the fibers running parallel to the edge of concrete floor assembly (Item 1) and curtain wall assembly (Item 2). Cut packing material width to achieve required compression, refer below, when installed in the nominal joint width. Compress the packing material into the perimeter joint. Tightly compress together splices (butt joints) in the lengths of packing material by using minimum 1/4 in. compression per piece of packing material. When a spray coating is used, locate the top surface of the packing material flush with the top surface of the concrete floor assembly (Item 1). When the non-sag or self leveling silicone sealant is used, recess the top surface of the packing material 1/4 in. from the top surface of the concrete floor assembly (Item 1). Use only Intertek certified products meeting the above minimum requirements.
- When 50% compression is required cut the width of the packing material 2 times wider than the nominal joint width.
 - When 33% compression is required cut the width of the packing material 1.5 times wider than the nominal joint width.
- B. **CERTIFIED MANUFACTURER:** 3M Company
CERTIFIED PRODUCT: FireDam™ or Fire Barrier™
MODEL: FD Spray 200 (Elastomeric, Sprayable) or FB 1000 N/S Silicone Sealant (Non-sag) or FB 1003 S/L (Self Leveling) Sealant
Fill, Void or Cavity Material: Apply either spray coating or sealant over the packing material (Item 3A) as follows:
Spray Coating – Spray apply the liquid to cover the exposed top surface of the packing material (Item 3A) compressed and installed in the perimeter joint. Apply a minimum wet film thickness of 1/8 in. and overlap the spray coating a minimum 1/2 in. onto the adjacent curtain wall assembly (Item 2) and concrete floor assembly (Item 1). When the spraying process is stopped and the applied spray coating cures to an elastomeric film before installation process is restarted, then overlap the edge of the cured spray coating at least 1/8 in. with the liquid spray coating.
Sealant – Apply non-sag or self leveling sealant to cover the exposed surface of the packing material (Item 3A) compressed and installed in the perimeter joint. Apply minimum 1/4 in. thickness non-sag or self leveling sealant over the packing material (Item 3A) and finish flush with the top surface of the concrete floor assembly (Item 1).
- C. **Support Clips:** (Optional) Recommended for installations subject to vertical shear movement. Use standard 20 GA galvanized steel Z-shaped clips having the following nominal dimensions: 1 in. wide by 3 in. high with a 2 in. upper leg and a 3 in. lower leg.

This material was extracted and drawn by 3M Fire Protection Products from the 2012 Product Directory, © Intertek

JS

Intertek System No. JS 180-08

February 17, 2017
(Formerly OPL Design No. CEJ 238 P)

PERIMETER FIRE BARRIERS

3M Company
FireDam™ Spray 200, Fire Barrier Watertight Spray, Fire and Water Barrier Tape FWBT,
Fire Barrier 1000 NS Silicone Sealant and Fire Barrier 1003 SL Silicone Sealant

ASTM E 2307

T-Rating 1-1/2 hr
F-Rating 3 hr

ASTM E 2307/ASTM E 1399 Cycling

Class: Static

Rated for ± 0% horizontal movement @ 25% Compression (Reference Item 3A)
Rated for ± 0% vertical shear movement @ 25% Compression (Reference Item 3A)

UL 2079

L-Rating <1.0 SCFM/LF

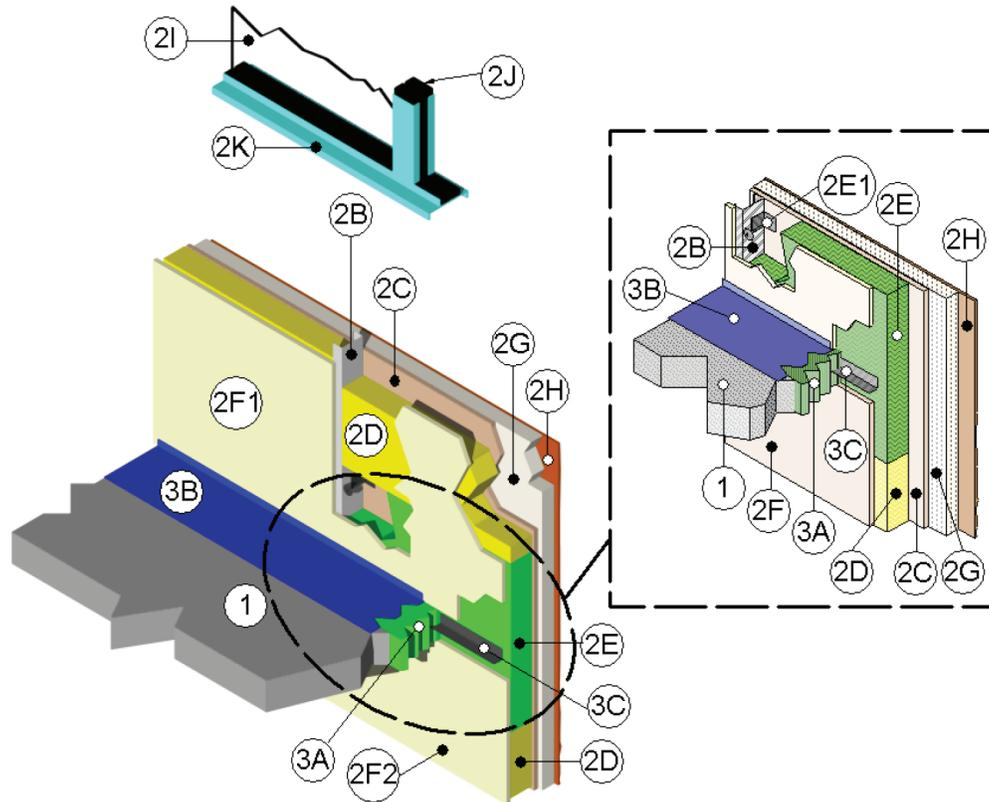

- Concrete Floor Assembly** – Three-hour rated concrete floor assembly made from either lightweight or normal weight concrete with a density of 100 to 150 pcf, having a min thickness of 4-1/2 in. at the joint face. When a longitudinal recess (blockout) is required to contain an architectural joint system, increase concrete floor assembly thickness to maintain a min thickness of 4-1/2 in. and accommodate depth of blockout formed in the concrete: blockout width unrestricted.
- Curtain Wall Assembly** – Incorporate the following construction features:
 - Mounting Attachment** (not shown) – Attach steel-stud framing (Item 2B) to the structural framing according to the curtain wall manufacturer's instructions. When required, connect the mounting attachments to the joint face of the concrete floor assembly (Item 1) according to the curtain wall manufacturer's instructions. Limit distance between mounting attachments to max 120 in.
 - Steel-Stud Framing** – Erect vertical framing members using a min 3-5/8 × 1-5/8 in., 18 GA steel "C" studs. Erect vertical framing, and when required install horizontal framing members, according to the curtain wall system manufacturer's guidelines. Max 24 in. on center (oc) vertical framing spacing.
 - Sandwiched Wall Surface** – Use a min 1/2 in. thick, 48 in. wide by 96 in. long, exterior grade gypsum wallboard (ASTM C 79), placed over and secured to framing (Item 2B) with min 1-1/4 in. long Type S drywall screws spaced 8 in. oc.
 - Curtain Wall Insulation** – Use nominal 24 in. wide, 4 in. thick, 4 pcf density, 3 in. thick, 6 pcf density, or 2 in. thick, 8 pcf density, mineral wool batt insulation faced on one side with aluminum foil scrim (vapor retarder), which is exposed to the room interior and installed in the stud cavity. Install curtain wall insulation between steel-stud framing (Item 2B). Secure curtain wall insulation with clips, impaling pins, or friction fit using curtain wall insulation length at least 1/4 in. longer than the distance between steel-stud framing (Item 2B). Seal all meeting edges of curtain wall insulation with nominal 4-inch wide pressure sensitive aluminum foil faced tape (not shown) centered over the junction so that approximately 2 in. of tape covers each edge of the adjacent curtain wall insulation. Apply pressure sensitive

aluminum foil faced tape over all meeting edges of curtain wall insulation and framing covers (Item 2F) so that approximately 2 in. covers each edge of the adjacent material. Install curtain wall insulation flush with the interior face of the steel-stud framing (Item 2B). Install 24 in. wide curtain wall insulation without vertical seams, spanning the full length between steel-stud framing (Item 2B). Locate horizontal seams in the curtain wall insulation at least 6 in. from the top surface of the perimeter joint protection (Item 3). Maintain 1-1/4 in. air cavity between curtain wall insulation and sandwiched wall surface (Item 2C). Option – in lieu of filling the full depth of the stud cavity with 4 in. thick, 4 pcf density curtain wall insulation, use either min 6 pcf density, or 2 in. thick, or 2 in. thick, 8 pcf density curtain wall insulation mechanically secured (do not secure by friction fit) and use additional horizontal support angle (not shown). Install perimeter fire barrier reinforcement (Item 3C). Use only Intertek certified products meeting the above min requirements.

E. Interior Curtain Wall Surface – Install perimeter joint treatment (Item 3) before this material. Cover interior face of steel-stud framing (Item 2B) with one layer of min 1/2 in. thick, Type X gypsum board (ASTM C 36). The joint face of the curtain wall assembly (Item 2) is not covered as shown with the 1/2 in. thick, Type X gypsum board (ASTM C 36). Fasten 1/2 in. thick, Type X gypsum board (ASTM C 36) to steel-stud framing (Item 2B) with min #6, 1-1/8 in. long bugle-head phillips drywall screws spaced 12 in. on center. Continuously place gypsum wallboard a min 72 in. above surface of perimeter joint protection (Item 3). Optional gypsum wallboard below the floor assembly (Item 1).

- i. Joint Tape and Compound** – Apply vinyl or casein, dry or premixed joint compound to face layer of gypsum board (Item 2E) in two coats to all exposed screw heads and gypsum board steel-stud framing (Item 2B) butt joints. A min 2 in. wide paper, plastic or fiberglass tape embedded in first layer of compound over joints in gypsum board (Item 2E).
- ii.** Create a min 3-5/8 in. cavity between unexposed side of sandwiched wall surface (Item 2C) to unexposed side of interior curtain wall surface (Item 2E).

F. Exterior Curtain Wall Insulation – Create an Exterior Insulation Finish System (EIFS) composed of expanded polystyrene foam (EPS) insulation, and an exterior curtain wall finish (Item 2H). Use a monolithic assembly without expansion or control joints as the EIFS system. Use EPS foam boards measuring nominal 24 in. wide by 48 in. long by 4 in. thick with a nominal density of 1 pcf. Attach the EPS foam to the sandwiched wall surface (Item 2C) using mechanical fasteners or an adhesive in accordance with manufacturer's recommendations. Install the EPS boards in a running bond (brick-like) pattern and staggered over sandwiched wall surface (Item 2C) joints. Apply pressure to the EPS boards to assist in the bonding process. Butt all EPS boards together with no gaps or voids between them. Allow a min of 12 hours before continuing the application process when using adhesive. Rasp the EPS boards to remove all irregular seams and establish a continuous flat surface.

G. Exterior Curtain Wall Finish – Apply the plaster base coat and reinforcing mesh over the exterior curtain wall insulation (Item 2G). Precut the mesh, which is a woven fiberglass reinforcement fabric that is compatible with the plaster base coat and finish coat materials. Apply 1/16 to 1/8 in. thick plaster base coat to the exposed surface of the EPS foam. Apply the mesh; embed the mesh into the plaster base coat using a trowel. Start at the middle and work outwards towards edges. Established a final thickness of approximately 1/16 in. of the plaster base coat with the mesh embedded. Let the plaster base coat dry completely before applying the plaster finish coat, which is a plaster-based wall coating which may contain silica sand or marble aggregates. Apply the plaster finish coat using a trowel in the same manner as the plaster base coat.

H. Glass Vision Panels – When required, use optional glass vision panels a min 20 in. above the top surface of the floor assembly (Item 1). Install glass vision panels to curtain wall framing according to the curtain wall system manufacturer's guidelines. Use a min 1/4 in. thick, clear tempered glass with a nominal width and height as determined by the framing.

I. Window Gaskets – When optional glass vision panels used, secure glass vision panels with a thermal break (thermal-set rubber extrusion).

J. Window Framing – Use tubing mullions and transoms, sized according to the curtain wall system manufacturer's guidelines. Minimum required framing dimensions, use 0.100 in. thick walls with min 6-1/2 in. depth and min 2-1/2 in. width and window framing must be compatible with steel framing (2B). Locate window framing at least 20 in. above the top surface of the floor assembly (Item 1).

3. Perimeter Joint Protection – Do not exceed an 8 in. nominal joint width (joint width at installation). Incorporate the following construction features for the perimeter joint protection (also known as perimeter fire barrier system):

A. Packing Material – Use a min 4 in. thick, 4 pcf density, mineral wool batt insulation installed with the fibers running parallel to the edge of concrete floor assembly (Item 1) and curtain wall assembly (Item 2). Cut packing material width to achieve required compression, refer below, when installed in the nominal joint width. Compress the packing material into the perimeter joint. Tightly compress together splices (butt joints) in the lengths of packing material by using min 1/4 in. compression per piece of packing material. Use only Intertek certified products meeting the above min requirements. When a spray coating or tape is used, locate the top surface of the packing material flush with the top surface of the concrete floor assembly (Item 1). When the non-sag or self-leveling silicone sealant is used, recess the top surface of the packing material 1/4 in. from the top surface of the concrete floor assembly (Item 1).

- i.** When 25% compression is required cut the width of the packing material 1.34 times wider than the nominal joint width.

B. CERTIFIED MANUFACTURER – 3M Company

CERTIFIED PRODUCT – FireDam™ or Fire Barrier

MODEL – FD Spray 200 (Elastomeric, Sprayable) or Fire Barrier Watertight Spray (Elastomeric, Sprayable) or

Fire and Water Barrier Tape FWBT (Tape) or FB 1000 N/S Silicone Sealant (Non-sag) or FB 1003 S/L (Self Leveling) Sealant

Fill, Void or Cavity Material – Apply either spray coating or sealant over the packing material (Item 3A) as follows:

Spray Coating – Spray apply the liquid to cover the exposed top surface of the packing material (Item 3A) compressed and installed in the perimeter joint. Apply a min wet film thickness of 1/8 in. and overlap the spray coating a min 1/2 in. onto the adjacent curtain wall assembly (Item 2) and concrete floor assembly (Item 1). When the spraying process is stopped and the applied spray coating cures to an elastomeric film before installation process is restarted, then overlap the edge of the cured spray coating at least 1/8 in. with the liquid spray coating.

Tape – Apply the tape such that there is a min 1 in. overlap onto the adjacent curtain wall assembly (Item 2) and the concrete floor assembly (Item 1). Overlap joints in the tape system by 1/2 in.

Intertek System No. JS 180-08 (cont.)

Sealant – Apply non-sag or self-leveling sealant to cover the exposed surface of the packing material (Item 3A) compressed and installed in the perimeter joint. Apply min 1/4 in. thickness non-sag or self-leveling sealant over the packing material (Item 3A) and finish flush with the top surface of the concrete floor assembly (Item 1).

- C. Perimeter Fire Barrier Reinforcement** – Use when either min 6 pcf density, or 2 in. thick, or 2 in. thick, 8 pcf density curtain wall insulation installed. Use min 20 GA, steel angle having a 1-1/2 in. high vertical leg and a 1-1/2 in. wide horizontal leg. Fully embed horizontal leg into the curtain wall insulation (Item 2E) at the centerline of the packing material (Item 3A). Secure the vertical leg at each mullion interior face (aluminum framing – Item 2B) using at least two min. 1/2 in. long, No. 10, sheet metal screws spaced nominally 1 in. oc. Install perimeter fire barrier reinforcement continuous along the length of the perimeter joint protection (Item 3). Overlap joints in the perimeter fire barrier reinforcement a min 12 in. and secure the overlap using at least three min 1/4 in. long, No. 10, sheet metal screws spaced nominally 4 in. oc, placed in both the vertical and horizontal legs of the angles.

Reprinted from the Directory of Building Products with permission from Intertek©

Construction Joints

Perimeter Joint

JS



Design Number 3MU/JS 180-09

June 26, 2018
 3M Company
 Perimeter Fire Barrier System
 FireDam™ Spray 200
 Fire Barrier Watertight Spray
 Fire and Water Barrier Tape FWBT
 Fire Barrier 1000 NS Silicone Sealant
 Fire Barrier 1003 SL Silicone Sealant
 ASTM E2307, ASTM E1399, UL 2079 (Air Leakage)
 Rating: See Table 1

| | Fire Barrier Watertight Spray (Item 3B) | | FireDam™ Spray 200, FWBT, Fire Barrier 1000 NS Silicone Sealant, Fire Barrier 1003 SL Silicone Sealant (Item 3B) | |
|---|---|----------------------------------|--|------------------------------------|
| | Mineral Wool Compression (See Item 3A) | | Mineral Wool Compression (See Item 3A) | |
| | 33% | 50% | 33% | 50% |
| F-Rating per ASTM E2307 | 3 Hour | 3 Hour | 3 Hour | 3 Hour |
| T-Rating per ASTM E2307 | 1-1/2 Hour | 2-1/2 Hour | 1-1/2 Hour | 2-1/2 Hour |
| ASTM E1399 Class IV: 500 cycles@ 30 cpm Cycling (%) | Horizontal 10% Vertical n/a | Horizontal 10% Vertical 6.25% | Horizontal 11% Vertical n/a | Horizontal 16.7% Vertical 6.25% |
| L-Rating per UL 2079 | < 1.0 SCFM/LF | < 1.0 SCFM/LF | < 1.0 SCFM/LF | < 1.0 SCFM/LF |

Table 1 - Ratings

- CONCRETE FLOOR ASSEMBLY:** Use a 3 hour rated concrete floor assembly made from either lightweight or normal weight concrete with a density of 100 to 150 pcf, having a min. thickness of 4-1/2 in. at the joint face. Increase floor assembly thickness as required for concrete type to meet the specified rating period. When a longitudinal recess (blockout) is required to contain an architectural joint system, increase concrete floor assembly thickness to maintain a min. thickness of 4-1/2 in. and accommodate depth of blockout formed in the concrete: blockout width unrestricted.

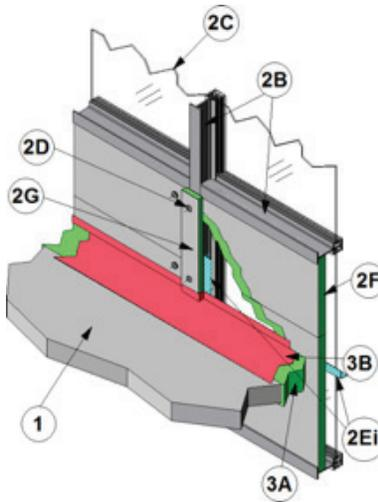

FIGURE 1 – Perimeter Fire Barrier System with Angle Reinforcement

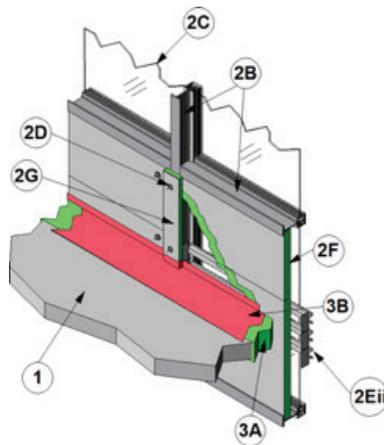

FIGURE 2 – Perimeter Fire Barrier System with Hat Channel Reinforcement

2. **CURTAIN WALL ASSEMBLY:** The curtain wall assembly shall incorporate the following construction features:

- A. MOUNTING ATTACHMENT (Not Shown)** – Attach aluminum framing (Item 2B) to the structural framing according to the curtain wall manufacturer's instructions. When required, connect the mounting attachments to the joint face of the concrete floor assembly (Item 1) according to the curtain wall manufacturer's instructions. Limit distance between mounting attachments to max. 120 in.
- B. ALUMINUM FRAMING** – Install I-shaped mullions and transoms, sized according to the curtain wall system manufacturer's guidelines. Min. overall dimensions of mullion framing extrusions: 0.125 in. thick with a min. 5-1/2 in. height and a min. of 2-1/2 in. width. Min. overall dimensions of transom framing is 0.125 in. thick with a min. 2 in. height and a min. of 2 in. width of the extrusion. Mullions are to be spaced a min. 60 in. on center (oc) and transoms are to be spaced a min. 48 in. oc. Transoms are to be located at a height of 20 in. above the top surface of the concrete floor assembly (Item 1) (as measured from the bottom of the transom).
- C. GLASS PANELS** – Size and install glass panels to aluminum framing (Item 2B) according to the curtain wall system manufacturer's guidelines. Use a min. 1/4 in. thick clear, heat-strengthened (HS) glass or tempered glass with a max. width and height less than the aluminum framing (Item 2B) oc spacing, which allows the glass to be secured between the notched shoulder of the aluminum framing and pressure bar. Secure panels with a thermal break (rubber extrusion), pressure bar (aluminum extrusion), min. 1/4-20 × 5/8 in. long screws, and a snap face (aluminum extrusion).
- D. IMPALING PINS** – Use min. 12 GA steel pins, a min. 1/2 in. longer than the thickness of the curtain wall insulation. Attach pins to a nominal 2 × 2 in. clip angle constructed with 20 GA, galvanized sheet steel and secure the clips to the aluminum framing (Item 2B) with No. 10, self-tapping, sheet metal screws. Space pins a max. of 12 in. oc on the vertical framing members and a max. of 20 in. oc on the horizontal framing members that make up the perimeter of the spandrel area. Install the interior face of the curtain wall insulation (Item 2F) so that it is flush with the interior face of the aluminum framing (Item 2B).
- E. REINFORCING MEMBERS** – Reinforce and support the back side of the curtain wall insulation (Item 2F) using one of the following two options:
 - i. Reinforcing Angle:** (See Figure 1) Mount a min. 1-1/2 × 1-1/2 in., 20 GA galvanized, steel angle to the vertical framing members so that the vertical leg serves as a backer to the exterior face of the curtain wall insulation (Item 2F) and the horizontal leg extends away from the curtain wall insulation (Item 2F) and locate at the centerline of the perimeter joint protection (Item 3). Size the angle 12 in. longer than the span between the interior edges of the vertical framing members and form the angle so that it has a 6 in. vertical leg on each end. Secure the 6 in. vertical leg to the vertical framing member on each side with three, No. 10, steel, self-tapping, sheet metal screws placed in a triangular fashion with a max. spacing of 2 in. oc.
 - ii. Reinforcing Hat Channel:** (See Figure 2) Install galvanized steel, 24 GA, hat channel, nominally 2-1/2 in. wide × 7/8 in. deep, to span the mullion-to- mullion space for the attachment of the curtain wall insulation. Orient each hat channel section with the wide section facing the curtain wall glazing. Cut each section to a min. 4 in. longer than the mullion spacing, with the ends cut, flattened and folded across the narrow width (toward the joint system) into mounting flanges perpendicular to the hat channel length. These flanges will each be nominally 2 in. long and will be attached to the inside faces of the mullions with No. 10 × 1 in. long self-drilling, self-tapping screws. Install three such hat channel stiffening channels with the flattened flanges in contact with each other to set the spacing, with the central hat channel centered on the joint centerline. The curtain wall insulation is to be supported by, and fastened into, these stiffening hat channel sections.
- F. CURTAIN WALL INSULATION** – Use only Intertek certified products meeting the following min. requirements. Use nominal 24 in. wide, 4 in. thick, 4 pcf density; nominal 3 in. thick, 6 pcf density; or nominal 2 in. thick, 8 pcf density, mineral wool batt insulation faced on one side with aluminum foil scrim (vapor retarder), which is exposed to the room interior. Install curtain wall insulation between aluminum framing (Item 2B). Install curtain wall insulation flush with the interior face of the aluminum framing (Item 2B). Secure curtain wall insulation with clips and impaling pins for 2 in. thick 8 pcf insulation or 3 in. thick 6 pcf insulation. Friction fit 4 in. thick 4 pcf insulation using curtain wall insulation length at least 1/4 in. longer than the distance between aluminum framing (Item 2B). Install 24 in. wide curtain wall insulation without vertical seams, spanning the full length between aluminum framing (Item 2B). Locate horizontal seams in the curtain wall insulation at least 6 in. from the top surface of the perimeter joint protection (Item 3). Maintain 1-1/4 in. air cavity

between curtain wall insulation and glass panel surface (Item 2C). Seal all meeting edges of curtain wall insulation with nominal 4 in. wide pressure sensitive aluminum foil faced tape (not shown) centered over the junction so that approximately 2 in. of tape covers each edge of the adjacent curtain wall insulation. Option – in lieu of filling the full depth of the space between aluminum framing (Item 2B) with 4 in. thick, 4 pcf density curtain wall insulation, use either min. 3 in. thick 6 pcf density, or 2 in. thick 8 pcf density curtain wall insulation mechanically secured (do not secure by friction fit). Install perimeter fire barrier reinforcement (Item 3C).

G. FRAMING COVERS – Use only Intertek certified products meeting the following min. requirements. Make framing covers, of nominal 4 in. wide strips of 8 pcf density, mineral wool batt insulation faced on one side with aluminum foil scrim (vapor retarder). Install with aluminum foil scrim exposed to the room interior. Install framing covers centered over each vertical framing member and secured to the member with impaling pins and clips spaced a max. 12 in. oc and attached in accordance with Item 2D. Make framing covers below the perimeter joint protection (Item 3) nominal 2 in. thick and those above the perimeter joint treatment, nominal 1 in. thick. Do not pass framing covers through the perimeter joint protection (Item 3). Abut framing covers to the top and bottom surfaces of the perimeter joint protection (Item 3). Apply pressure sensitive aluminum foil faced tape (not shown) over all meeting edges of curtain wall insulation and framing covers (Item 2G) so that approximately 2 in. covers each edge of the adjacent material.

3. PERIMETER JOINT PROTECTION: The perimeter joint (linear opening) is not to exceed an 8 in. nominal joint width (joint width at installation). The perimeter joint treatment shall incorporate the following construction features:

A. PACKING MATERIAL – Use only Intertek certified products meeting the following min. requirements. Use a min. 4 in. thick, 4 pcf density, mineral wool batt insulation. Cut insulation into 4 in wide strips and install with the fibers running parallel to the edge of concrete floor assembly (Item 1) and curtain wall assembly (Item 2). Stack 4 in wide packing material strips to achieve required compression (refer below) when installed in the nominal joint width at the required 4 in. depth. Compress the packing material into the perimeter joint. Tightly compress together splices (butt joints) in the lengths of packing material by using min. 1/4 in. compression per piece of packing material. When a spray coating or tape is used as the fill, void, or cavity material (Item 3B), locate the top surface of the packing material flush with the top surface of the concrete floor assembly (Item 1). When the non-sag or self-leveling silicone sealant is used as the fill, void, or cavity material (Item 3B), recess the top surface of the packing material 1/4 in. from the top surface of the concrete floor assembly (Item 1).

- i. When 50% compression is required stack the width of the packing material 2 times wider than the nominal joint width.
- ii. When 33% compression is required stack the width of the packing material 1.5 times wider than the nominal joint width.

B. FILL, VOID, OR CAVITY MATERIAL – Apply either spray coating or sealant over the packing material (Item 3A) as follows:

i. CERTIFIED MANUFACTURER: 3M Company

CERTIFIED PRODUCT: Joint Sealant Spray

CERTIFIED MODEL: FD Spray 200 (Elastomeric, Sprayable)

Spray apply the liquid to cover the exposed top surface of the packing material (Item 3A) compressed and installed in the perimeter joint. Apply a min. wet film thickness of 1/8 in. and overlap the spray coating a min. 1/2 in. onto the adjacent curtain wall assembly (Item 2) and concrete floor assembly (Item 1). When the spraying process is stopped and the applied spray coating cures to an elastomeric film before installation process is restarted, then overlap the edge of the cured spray coating at least 1/8 in. with the liquid spray coating.

ii. CERTIFIED MANUFACTURER: 3M Company

CERTIFIED PRODUCT: Joint Sealant Spray

CERTIFIED MODEL: Fire Barrier Watertight Spray (Elastomeric, Sprayable)

Spray apply the liquid to cover the exposed top surface of the packing material (Item 3A) compressed and installed in the perimeter joint. Apply a min. wet film thickness of 1/8 in. and overlap the spray coating a min. 1/2 in. onto the adjacent curtain wall assembly (Item 2) and concrete floor assembly (Item 1). When the spraying process is stopped and the applied spray coating cures to an elastomeric film before installation process is restarted, then overlap the edge of the cured spray coating at least 1/8 in. with the liquid spray coating.

iii. CERTIFIED MANUFACTURER: 3M Company

CERTIFIED PRODUCT: Joint Sealant Tape

CERTIFIED MODEL: Fire and Water Barrier Tape FWBT (Tape)

Apply the tape such that there is a min. 1 in. overlap onto the adjacent curtain wall assembly (Item 2) and the concrete floor assembly (Item 1). Overlap joints in the tape system by 1/2 in.

iv. CERTIFIED MANUFACTURER: 3M Company

CERTIFIED PRODUCT: Joint Sealant

CERTIFIED MODEL: FB 1000 N/S Silicone Sealant (Non-sag)

Apply non-sag or self-leveling sealant to cover the exposed surface of the packing material (Item 3A) compressed and installed in the perimeter joint. Apply min. 1/4 in. thickness non-sag or self-leveling sealant over the packing material (Item 3A) and finish flush with the top surface of the concrete floor assembly (Item 1).

v. CERTIFIED MANUFACTURER: 3M Company

CERTIFIED PRODUCT: Joint Sealant

CERTIFIED MODEL: FB 1003 S/L (Self-leveling) Sealant

Apply non-sag or self-leveling sealant to cover the exposed surface of the packing material (Item 3A) compressed and installed in the perimeter joint. Apply min. 1/4 in. thickness non-sag or self-leveling sealant over the packing material (Item 3A) and finish flush with the top surface of the concrete floor assembly (Item 1).

- C. PERIMETER FIRE BARRIER REINFORCEMENT (Not Shown)** – Use when either 3 in. thick 6 pcf density, or 2 in. thick 8 pcf density curtain wall insulation (Item 2F) is installed. Use min. 20 GA, steel angle having a 1-1/2 in. high vertical leg and a 1-1/2 in. wide horizontal leg. Fully embed horizontal leg into the packing material (Item 3A) at the vertical centerline of the packing material. Secure the vertical leg at each mullion interior face (aluminum framing – Item 2B) using at least two min. 1/2 in. long, No. 10, sheet metal screws spaced nominally 1 in. oc. Install perimeter fire barrier reinforcement continuous along the length of the perimeter joint protection (Item 3). Overlap joints in the perimeter fire barrier reinforcement a min. 12 in. and secure the overlap using at least three min. 1/4 in. long, No. 10, sheet metal screws spaced nominally 4 in. oc, placed in both the vertical and horizontal legs of the angles.



This material was extracted and drawn by 3M Fire Protection Products from the 2018 Product Directory, © Intertek

Design Number 3MU/JS 180-12

November 7, 2016

PERIMETER FIRE BARRIERS

3M Company

FireDam™ Spray 200, Fire Barrier Watertight Spray, Fire and Water Barrier Tape FWBT,
Fire Barrier 1000 NS Silicone Sealant and Fire Barrier 1003 SL Silicone Sealant

ASTM E 2307

T-Rating 0 hr

F-Rating 3 hr

ASTM E 2307/ASTM E 1399 Cycling

Class 4 Movement Cycling

Rated for ± 5% Horizontal Movement @ 33% Compression

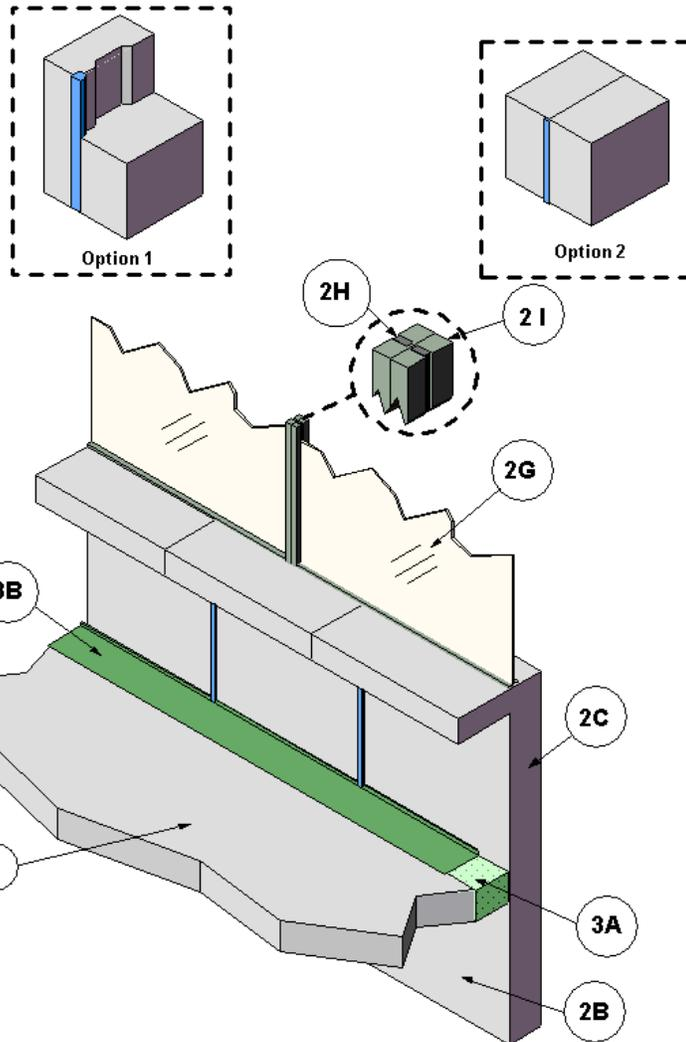

- 1. CONCRETE FLOOR ASSEMBLY:** Three-hour rated concrete floor assembly made from either lightweight or normal weight concrete with a density of 100 to 150 pcf, having a min thickness of 5.7 in. at the joint face. When a longitudinal recess (blockout) is required to contain an architectural joint system, increase concrete floor assembly thickness to maintain a min thickness of 5.7 in. at the joint face and accommodate depth of blockout formed in the concrete: blockout width unrestricted.
- 2. CURTAIN WALL ASSEMBLY:** Incorporate the following construction features:
 - A. Mounting Attachment:** (Not shown) Attach the pre-cast concrete panels (Item 2B) to the joint face or top of the concrete floor assembly (Item 1), according to the curtain wall manufacturer's instructions. Max distance horizontally between mounting attachments shall be 10 ft.
 - B. Pre-Cast Concrete Panels:** Use engineered structural pre-cast concrete panels made from steel reinforced lightweight or normal weight (100 to 150 pcf) concrete min 4 in. thick and 48 in. high. Equip panels with structural mounting attachments (Item 2A). When anchors are located at the joint face within the perimeter joint protection (Item 3), maintain a min recess of 1/2 in. from the top of the concrete floor assembly (Item 1) and max spacing of 120 in. on center (oc) between anchors.
 - C. CERTIFIED MANUFACTURER:** 3M
CERTIFIED PRODUCT: Joint sealant
MODEL: Fire Barrier™ 2000 Silicone Joint Sealant
Concrete Panel Joint: Use the following concrete panel joints: either key way type (tongue and groove, option 1) or butt joint type (flush, option 2). Apply a 1/2 in. bead of joint sealant along the pre-cast concrete panel joints on the interior side. When curtain wall insulation

System No. 3MU/JS 180-12 *continued*

(Item 2F) is used, the joint sealant may be omitted provided that the seams between adjacent sections of curtain wall insulation (Item 2F) are offset a min of 3 in. from the edge of any joint in the pre-cast concrete panels. Then treat the concrete panel joint with any weatherproofing material Listed as having a flame spread index (FSI) less than or equal to 25 and a smoke developed index (SI) of less than or equal to 450 in accordance with ASTM E84. Use only Intertek certified products meeting the above requirements.

- D. Impaling Pins (Optional, not shown): Use only when curtain wall insulation (Item 2F) is installed. Install min 12 GA steel impaling pins spaced 24 in. oc in all directions on the interior face of the pre-cast concrete panels (Item 2B). Equip each impaling pin with a min 1-1/2 in. diameter locking washer. For a piece of curtain wall insulation (Item 2F) having a width equal to or greater than 3 in., install a min of two impaling pins located above the floor line with at least one in each bottom corner of the piece of curtain wall insulation (Item 2F). For a piece of curtain wall insulation (Item 2F) having a width of less than 3 in., install one impaling pin located above the floor line at the bottom center of the piece of curtain wall insulation (Item 2F).
 - E. Clutch Clips (Optional, not shown): Install min 18 GA steel, max 1-1/4 in. clutch clips placed over impaling pins (Item 2D). When this option is used, install a clutch clip with each impaling pin. When clutch clips are installed, create an air space between the pre-cast concrete panels (Item 2B) and the curtain wall insulation (Item 2F).
 - F. Curtain Wall Insulation (Optional, not shown): Install one of the following: nominal 4 in. thick 4 pcf, 3 in. thick 6 pcf, or 2 in. 8 pcf density mineral wool batt insulation faced on one side with aluminum foil scrim (vapor retarder), which is exposed to the room interior. Secure the curtain wall insulation with impaling pins (Item 2D). Seal all meeting edges of curtain wall insulation with nominal 2 in. wide pressure sensitive aluminum foil faced tape. Install curtain wall insulation tightly above and below the perimeter joint protection (Item 3) and terminate at the concrete panel return above the perimeter joint protection (Item 3). Use only Intertek certified products meeting the above min requirements.
 - G. Glass Vision Panels (Optional): Install glass vision panels outside spandrel area a min 20 in. above the top surface of the floor assembly (Item 1) and a min of 28 in. below the top surface of the floor assembly (Item 1). Install glass vision panels in window framing (Item 2I) according to the curtain wall system manufacturer's guidelines. Use a min 1/4 in. thick, clear heat-strengthened glass with a nominal width and height as determined by the window framing (Item 2I).
 - H. Window Gaskets (Optional): Secure glass vision panels (Item 2G) with a thermal break (thermal-set rubber extrusion).
 - I. Window Framing (Optional): Use steel or aluminum framing members with a min 3-5/8 in. by 1-5/8 in. 18 GA steel "U" channel or similar construction that is compatible with the pre-cast concrete panels (Item 2B) and concrete panel joints (Item 2C). Locate window framing at least 20 in. above the top surface of the concrete floor assembly (Item 1) and a min of 28 in. below the top surface of the floor assembly (Item 1).
3. **PERIMETER JOINT PROTECTION:** Do not exceed a 6 in. nominal joint width (joint width at installation). Incorporate the following construction features for the perimeter joint protection (also known as perimeter fire barrier system):
- A. Packing Material: Install min 4 in. thick, 4 pcf mineral wool batt insulation with the fibers parallel to the edge of the concrete floor assembly (Item 1) and the curtain wall assembly (Item 2). Compress the packing material 33% in the nominal joint width. Compress the splices (butt joints) in the lengths of mineral wool batt insulation tightly together. When using non-sag or self-leveling joint sealants (Item 3B), recess the mineral wool packing material a min 1/4 in. from the top surface of the concrete floor assembly (Item 1) to accommodate the required installation depth of the non-sag or self-leveling joint sealants (Item 3B). Use only Intertek certified products meeting the above min requirements.
 - B. CERTIFIED MANUFACTURER: 3M Company
CERTIFIED PRODUCT: FireDam™ or Fire Barrier™
MODEL: FD Spray 200 (Elastomeric, Sprayable) Fire Barrier Watertight Spray (Elastomeric, Sprayable) or Fire and Water Barrier Tape FWBT (Tape) or FB 1000 N/S Silicone Sealant (Non-sag) or FB 1003 S/L (Self Leveling) Sealant
- Fill, Void or Cavity Material: Apply either spray coating or sealant over the packing material (Item 3A) as follows:
- Spray Coating – Spray apply the liquid to cover the exposed top surface of the packing material (Item 3A) compressed and installed in the perimeter joint. Apply a min wet film thickness of 1/8 in. and overlap the spray coating a min 1/2 in. onto the adjacent curtain wall assembly (Item 2) and concrete floor assembly (Item 1). When the spraying process is stopped and the applied spray coating cures to an elastomeric film before installation process is restarted, then overlap the edge of the cured spray coating at least 1/8 in. with the liquid spray coating.
- Tape – Apply the tape such that there is a min 1 in. overlap onto the adjacent curtain wall assembly (Item 2) and the concrete floor assembly (Item 1). Overlap joints in the tape system by 1/2 in.
- Sealant – Apply non-sag or self leveling sealant to cover the exposed surface of the packing material (Item 3A) compressed and installed in the perimeter joint. Apply min 1/4 in. thickness non-sag or self leveling sealant over the packing material (Item 3A) and finish flush with the top surface of the concrete floor assembly (Item 1).

This material was extracted and drawn by 3M Fire Protection Products from the 2016 Product Directory, © Intertek

Design No. 3MU/JS 180-13

May 22, 2009

PERIMETER FIRE BARRIERS

3M Company

FireDam™ Spray 200, Fire Barrier 1000 NS Sealant and Fire Barrier 1003 SL Sealant

ASTM E 2307

T Rating – 0 hr.

F-Rating – 3 hr.

L-Rating < 1 SCFM/LF

ASTM E 1399/ASTM E 2307

Cycling – Class 4

Rated for 5% Horizontal Movement @ 33% Compression

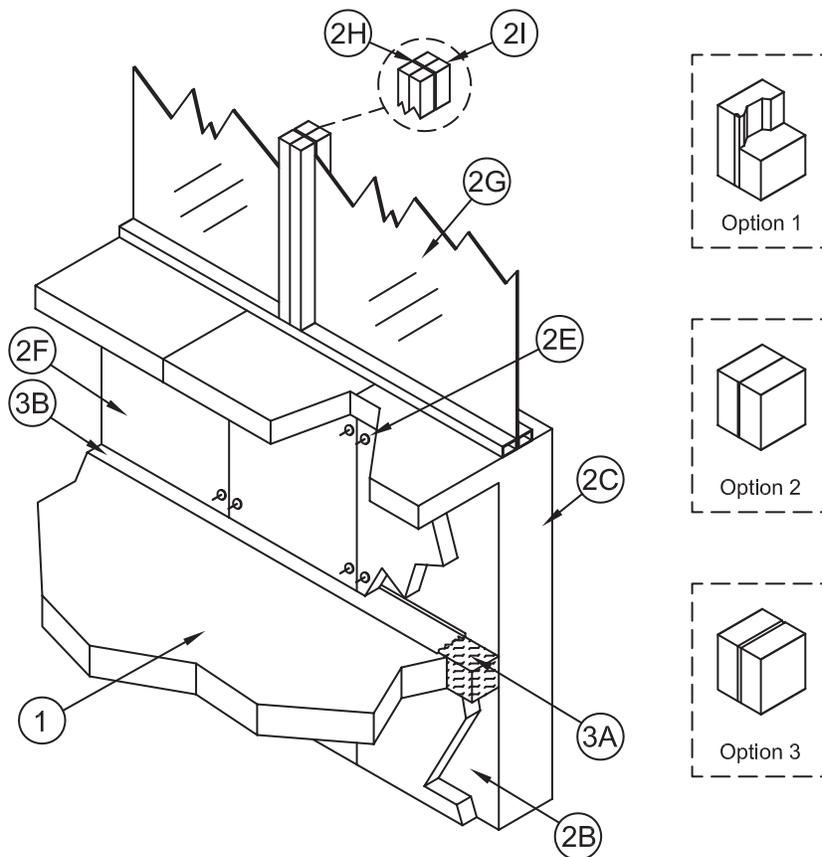

1. **CONCRETE FLOOR ASSEMBLY:** Three-hour rated concrete floor assembly made from either lightweight or normal weight concrete with a density of 100 to 150 pcf, having a minimum thickness of 5.7 inches at the joint face. When a longitudinal recess (blockout) is required to contain an architectural joint system, increase concrete floor assembly thickness to maintain a minimum thickness of 5.7 inches at the joint face and accommodate depth of blockout formed in the concrete: blockout width unrestricted.
2. **CURTAIN WALL ASSEMBLY:** The curtain wall assembly shall incorporate the following construction features:
 - A. **Mounting Attachments:** (Not shown) Attach the pre-cast concrete panels (Item 2B) to the joint face or top of the concrete floor assembly (Item 1), according to the curtain wall manufacturer's instructions. Maximum distance horizontally between mounting attachments shall be 10 feet.
 - B. **Pre-Cast Concrete Panels:** Use engineered structural pre-cast concrete panels made from steel-reinforced lightweight or normal weight (100-150 pcf) concrete, minimum 4 inches thick and 48 inches high. Equip panels with structural mounting attachments (Item 2A). When anchors are located at the joint face within the perimeter joint protection (Item 3), maintain a minimum recess of 1/2-inch from the top of the concrete floor assembly (Item 1) and maximum spacing of 120 inches on center between anchors.
 - C. **CERTIFIED MANUFACTURER:** 3M
CERTIFIED PRODUCT: Joint Sealant
MODEL: Fire Barrier™ 2000 Silicone Joint Sealant
Concrete Panel Joint: Use the following concrete panel joints: either key way type (tongue and groove) (Option 1), butt joint type (flush) (Option 2) or butt joint type with maximum 1-inch gap (Option 3). When using Option 1 or 2, as an option, apply a 1/2-in. bead of joint sealant along the pre-cast concrete panel joints on the interior side.

When using Option 3, tightly pack 4-pcf mineral wool batt insulation in the concrete joint space. Pack the mineral wool insulation 3 inches deep, recessed 1/2 inch from the interior side of the pre-cast concrete panels (Item 2B). Fill the 1/2-inch recess with joint sealant along the concrete panel joints on the interior side. *Use only Intertek certified products meeting the above minimum requirements.* Offset the seams between adjacent sections of curtain wall insulation (Item 2F) a minimum of 3 inches from the edge of any concrete panel joints. Then treat the concrete panel joint with any weatherproofing material Listed as having a flame spread index ≤ 25 and a smoke developed index ≤ 450 in accordance with ASTM E-84. *Use only Intertek certified products meeting the above minimum requirements.*

Design No. 3MU/JS 180-13 *continued*

- D. Impaling Pins: Install minimum 12 GA steel impaling pins spaced 24 inches on center in all directions on the interior face of the pre-cast concrete panels (Item 2B). Equip each impaling pin with a minimum 1-1/2-inch diameter locking washer. For a piece of curtain wall insulation (Item 2F) having a width equal to or greater than 3 inches, install a minimum of two impaling pins located above the floor line with at least one in each bottom corner of the piece of curtain wall insulation (Item 2F). For a piece of curtain wall insulation (Item 2F) having a width less than 3 inches, install one impaling pin located above the floor line at the bottom center of the piece of curtain wall insulation (Item 2F).
 - E. Clutch Clips (Optional – Not shown): Install minimum 18 GA steel, maximum 1-1/4-inch clutch clips placed over impaling pins (Item 2D). When this option is used, install a clutch clip with each impaling pin. When clutch clips are installed, create an air space between the precast concrete panels (Item 2B) and the curtain wall insulation (Item 2F).
 - F. Curtain Wall Insulation: Use one of the following materials: nominal 4-inch thick 4-pcf, 3-inch thick 6-pcf, or 2-inch thick 8-pcf density mineral wool batt insulation faced on one side with aluminum foil scrim (vapor retarder). When the concrete panel joint (Item 2C) is installed with sealant and mineral wool batt insulation (packed tightly), install the sealant and mineral wool batt insulation before the curtain wall insulation. Install the curtain wall insulation with the aluminum foil scrim side exposed to the room interior. Secure with impaling pins (Item 2D). Seal all mating edges with nominal 2-inch wide pressure sensitive aluminum foil faced tape. Install curtain wall insulation tightly above and below the perimeter joint protection (Item 3) and terminate at the concrete panel return above the perimeter joint protection (item 3). *Use only Intertek certified products meeting the above minimum requirements*
 - G. Glass Vision Panels: (Optional) Install glass vision panels outside spandrel area a minimum 20 inches above the top surface of the floor assembly (Item 1) and a minimum of 28 inches below the top surface of the floor assembly (Item 1). Install glass vision panels in window framing (Item 2I) according to the curtain wall system manufacturer's guidelines. Use a minimum 1/4-inch thick, clear heat-strengthened glass with a nominal width and height as determined by the window framing (Item 2I).
 - H. Window Gaskets: (Optional) Secure glass vision panels (Item 2G) with a thermal break (thermal-set rubber extrusion).
 - I. Window Framing: (Optional) Use steel or aluminum framing members with a minimum 3-5/8-inch by 1-5/8-inch 18 GA steel "U" channel or similar construction that is compatible with the pre-cast concrete panels (Item 2B) and concrete panel joints (Item 2C). Locate window framing at least 20 inches above the top surface of the concrete floor assembly (Item 1) and a minimum of 28 inches below the top surface of the floor assembly (Item 1).
3. PERIMETER JOINT PROTECTION: Do not exceed a 6-inch nominal joint width (joint width at installation). Incorporate the following construction features for the perimeter joint protection (also known as perimeter fire barrier system):
- A. Packing Material: Install minimum 4-inch thick, 4-pcf mineral wool batt insulation with the fibers parallel to the edge of the concrete floor assembly (Item 1) and the curtain wall assembly (Item 2). Compress the packing material 33% in the nominal joint width. Compress the splices (butt joints) in the lengths of mineral wool batt insulation tightly together. When using non-sag or self leveling joint sealants (Item 3B), recess the mineral wool packing material a minimum 1/4-inch from the top surface of the concrete floor assembly (Item 1) to accommodate the required installation depth of the non-sag or self leveling joint sealants (Item 3B). *Use only Intertek certified products meeting the above minimum requirements.*
 - B. CERTIFIED MANUFACTURER: 3M
CERTIFIED PRODUCT: Joint Sealant
MODEL: FireDam™ Spray 200 (Elastomeric, Spray), Fire Barrier 1000 NS Sealant (Non-sag) or Fire Barrier 1003 SL Sealant (Self Leveling)
Fill, Void or Cavity Material: Apply joint sealant (sprayed, brushed, or troweled as indicated by the manufacturer's installation instructions) to cover the top exposed surface of the mineral wool installed in the nominal joint width.
When using a spray apply a minimum wet film thickness of 1/8-inch and overlap the spray a minimum 1/2-inch onto the adjacent curtain wall assembly (Item 2) and concrete floor assembly (Item 1). When the application process is stopped and the applied spray has cured to an elastomeric film before the application process is restarted, overlap at least 1/8-inch with the new spray the edge of the cured spray.
When using the non-sag or self leveling joint sealants, apply in a minimum 1/4-inch thick layer.

This material was extracted and drawn by 3M Fire Protection Products from the 2012 Product Directory, © Intertek

Intertek System No. PFB 120-30

August 6, 2010

PERIMETER FIRE BARRIER SYSTEMS

3M Company

FireDam™ Spray 200, Fire Barrier 1000 NS Silicone Sealant and Fire Barrier 1003 SL Silicone Sealant

ASTM E 2307-04

T-Rating: 0 Hr

F-Rating: 2 hr

ASTM E 2307/ASTM E 1399 Cycling

Class I: 500 cycles @ 1 cpm

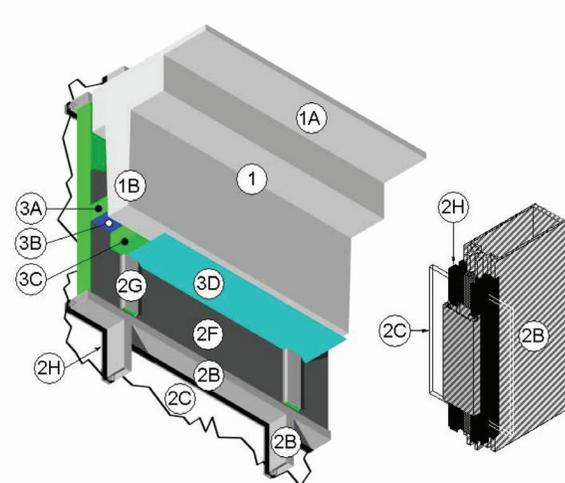

Figure 1 – Lower Left Wall Assembly Isometric and Aluminum Framing Extrusion Assembly (Transoms & Mullions) Isometric

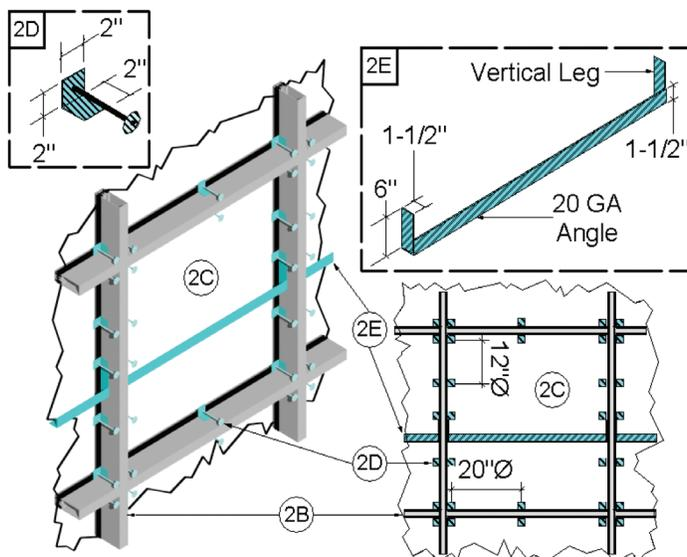

Figure 2 – Aluminum Framing Isometric, Aluminum Framing Elevation, Impaling Pin Isometric, and Reinforcement Angle Isometric

1. **Concrete Floor Assembly** – Refer to Figure 1. Minimum 2-hour rated monolithic concrete floor assembly made from either lightweight or normal weight concrete with a density of 100 to 150-pcf density. When a longitudinal recess (blockout) is required to contain an architectural joint system, increase concrete floor assembly thickness to maintain a minimum thickness of 4-1/2 in. and accommodate depth of blockout formed in the concrete: blockout width unrestricted.
 - A. **Concrete Floor** – Minimum 2-hour rated, nominal 4-1/2 in. thick, reinforced, slab increasing to nominal 16 in. thick at joint face (slab edge) created by cast-in-place technique integral with concrete beam (Item 1B).
 - B. **Concrete Beam** – Nominal, 31 in. deep, 12 in. wide, 2-hour rated, pre-cast or cast-in-place reinforced concrete spandrel beam integral with concrete floor (Item 1A).
2. **Curtain Wall Assembly** – Refer to Figures 1 and 2. Incorporate the following construction features:
 - A. **Mounting Attachment** (not shown) – Attach aluminum framing (Item 2B) to the structural framing according to the curtain wall manufacturer's instructions. When required, connect the mounting attachments to the joint face of the concrete floor assembly (Item 1) according to the curtain wall manufacturer's instructions. Limit distance between mounting attachments to maximum 120 in..
 - B. **Aluminum Framing** – Use hollow rectangular aluminum extruded tubing with minimum overall dimensions of 0.100 in. thick, 5-1/2 in. high and 2-1/2 in. wide. Locate mullions (vertical aluminum framing) nominally 85.5 in. on center and locate transoms (horizontal aluminum framing) a maximum 30-1/2 in. on center. For the spandrel region, locate the upper transom (horizontal aluminum framing) a minimum 20 in. above the perimeter joint protection (Item 3) as measured from the top surface of the packing material (Item 3A) to the underside of the transom (horizontal aluminum framing).
 - C. **Glass Panels** – Sized and installed into aluminum framing (Item 2B) according to the curtain wall system manufacturer's guidelines. Use minimum 1/4 in. thick clear, heat strengthened (HS) glass or tempered glass with a maximum width and height less than the aluminum framing (Item 2B) on center spacing, which allows the glass to be secured between the notched shoulder of the aluminum framing (Item 2B) and pressure bar. Secure glass panels with a thermal break (rubber extrusion), pressure bar (aluminum extrusion), minimum 1/4–20 × 5/8 in. long screws, and a snap face (aluminum extrusion).
 - D. **Impaling Pins** – Use with curtain wall insulation (Item 2E) and framing covers (Item 2F), locate, size and install impaling pins according to the curtain wall system manufacturer's guidelines, or be a minimum 4-1/2 in. long, 12 GA pin attached to one of the following: a nominal 2 × 2 in. plate; a nominal 2 × 2 × 2 in. long angle; or can be directly attached to the aluminum framing (Item 2B) using a stud gun. Cap all pins using a nominal 1 in. diameter speed washer. Space impaling pins a maximum of 12 in. on center vertically and 20 in. on center horizontally. Install impaling pins around the periphery of the curtain wall insulation (Item 2F) so that its interior face is flush with the interior face of the aluminum framing (Item 2B).
 - E. **Reinforcing Angle** – Locate reinforcing angle at all horizontal butt joints of the curtain wall insulation (Item 2F) in the field of the glass spandrel panels (Item 2C) and at the mid height of the packing material (Item 3A). Mount a minimum 1-1/2 × 7/8 in., 20 gauge, galvanized-steel angle to the vertical aluminum framing, mullions, (Item 2B) so that the vertical leg serves as a backer to the exterior face of the curtain wall insulation (Item 2F) and the horizontal leg extends away from the curtain wall insulation and is located at the centerline

of the packing material (Item 3A). Size the angle 12 in. longer than the span between the interior edges of the vertical aluminum framing, mullions, (Item 2B) and form the angle so that it has a 6 in. vertical leg on each end. Secure the 6 in. vertical leg on each end to the vertical aluminum framing, mullions, (Item 2B) on each side with two No. 10 steel self-tapping sheet metal screws placed in a stable fashion with a maximum spacing of 2 in. on center, or fastening method of equal strength and stability.

- F. Curtain Wall Insulation** – Use only Intertek certified products meeting following minimum requirements. Use nominal 24 in. wide, 4 in. thick, 4-pcf density, 3 in. thick, 6-pcf density, or 2 in. thick, 8-pcf density, mineral wool batt insulation faced on one side with aluminum foil scrim (vapor retarder), which is exposed to the room interior and installed in the stud cavity. Install curtain wall insulation between aluminum framing (Item 2B). Secure curtain wall insulation with impaling pins (Item 2D) attached to aluminum framing (Item 2B). Seal all meeting edges of curtain wall insulation with nominal 3 in. wide, pressure sensitive, aluminum-foil-faced tape centered over the junction so that approximately 1-1/2 in. of tape covers each edge of the adjacent curtain wall insulation. Apply pressure sensitive aluminum foil faced tape over all meeting edges of curtain wall insulation and framing covers (Item 2F) so that approximately 2 in. covers each edge of the adjacent material. Install curtain wall insulation flush with the interior face of the aluminum framing (Item 2B). Install 24 in. wide curtain wall insulation spanning the full length and height between aluminum framing (Item 2B). Refer to Figure 3. For vertical insulation butt joints, first install back-to-back angles created from minimum, 20 GA, steel having minimum 2 in. legs. Position back-to-back angles in front of reinforcing angle (Item 2E). Mechanically fasten ends of steel back-to-back angles to horizontal framing (Item 2B). Locate horizontal seams in the curtain wall insulation at least 6 in. from the top surface of the perimeter joint protection (Item 3). Maintain 1-1/4 in. air cavity between curtain wall insulation and glass panels (Item 2C). Option – in lieu of filling the full depth of the stud cavity with 4 in. thick, 4-pcf density curtain wall insulation, use minimum 2 in. thick, 8-pcf density or 3 in. thick, 6-pcf density curtain wall insulation mechanically secured (do not secure by friction fit) and use additional horizontal support angle (not shown). Locate a horizontal support angle consisting of a minimum 20 GA steel angle, having 1.5 × 1.5 in. legs horizontally at the mid height of the packing material (Item 3A) and attached to each mullion of aluminum framing (Item 2B) using minimum #6, 1/2 in. long self-tapping sheet metal screws.
- G. Framing Covers** – Make from strips of minimum 1 in. thick by minimum 4 in. wide, 8-pcf density, mineral wool batt insulation faced on one side with aluminum foil scrim (vapor retarder), which is exposed to the room interior. Center framing covers over all aluminum framing (Item 2B) and secure using impaling pins or cup-head weld pins (Item 2D). Do not pass framing covers through the perimeter joint protection (Item 3). Allow framing covers to abut top and bottom surfaces of the perimeter joint protection (Item 3) provided that no deformation occurs. Use only Intertek certified products meeting the above minimum requirements.
- H. Thermal Break Assembly** – Secure panels with a thermal break (thermal-set rubber extrusion), pressure bar (aluminum extrusion), 1/4–20 × 5/8 in. long screws, and a snap face (aluminum extrusion). Protect spandrel panels according to Item 2F.

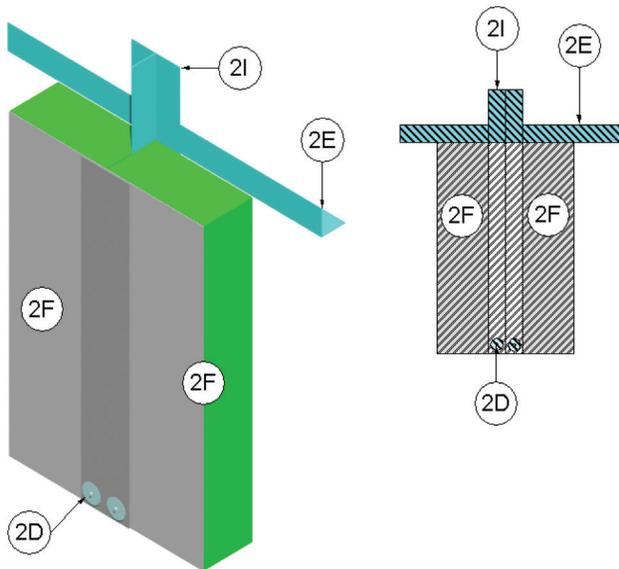

Figure 3 – Curtain Wall Insulation Vertical Butt Joint Isometric and Elevation

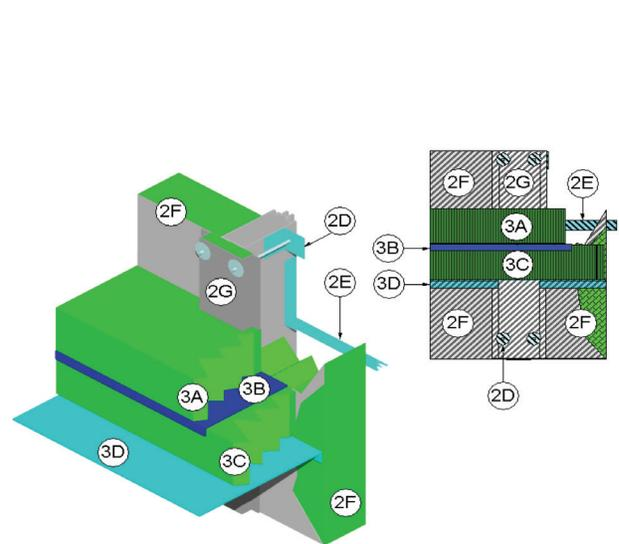

Figure 4 – Perimeter Joint Protection Isometric and Elevation

- 3. Perimeter Joint Protection** – Refer to Figures 1 and 4. Install impaling pins (Item 2D), reinforcement angle (Item 2E), and protect spandrel panels using curtain wall insulation (Item 2F) before installing perimeter joint protection. Do not install framing covers (Item 2G) until after perimeter joint protection. Do not exceed a 12 in. nominal joint width (joint width at installation). Install perimeter joint protection from bottom of concrete floor assembly (Item 1). Sandwich the fill, void or cavity material (Item 3B) between two pieces of packing material (Item 3A and Item 3C). Incorporate the following construction features for the perimeter joint protection (also known as perimeter fire barrier system):
- A. Packing Material** – Use a minimum 4 in. thick, 4-pcf density, mineral wool batt insulation installed with the fibers running parallel to the edge of concrete floor assembly (Item 1) and curtain wall assembly (Item 2). Cut packing material width to achieve required compression, refer below, when installed in the nominal joint width. Compress the packing material into the perimeter joint created between the curtain wall insulation (Item 2F) and the concrete spandrel beam (Item 1B). Create a recess at least 4 in. deep between the bottom of the packing material and the bottom surface of the concrete spandrel beam (Item 1B) to allow installation of the fill, void or cavity material (Item 3B) and the second piece of packing material (Item 3C). Tightly compress together splices (butt joints) in the lengths of packing material by using minimum 1/4 in. compression per piece of packing material. Use only Intertek certified products meeting the above minimum requirements.

Intertek System No. PFB 120-30 (cont.)

- i. When horizontal movement of $\pm 16.7\%$ and vertical shear of $\pm 6.25\%$ is required, install packing material at 50% compression. Cut the width of the packing material 2 times wider than the nominal joint width.
 - ii. When horizontal movement of $\pm 5\%$ is required, install packing material at 20% compression. Cut the width of the packing material 1.25 times wider than the nominal joint width.
- B. CERTIFIED MANUFACTURER** – 3M Company
CERTIFIED PRODUCT – FireDam™ or Fire Barrier
MODEL – FD Spray 200 (Elastomeric, Sprayable) or FB 1000 N/S Silicone Sealant (Non-sag) or FB 1003 S/L (Self Leveling)
- Fill, Void or Cavity Material** – Apply either spray coating or sealant over the bottom of the packing material (Item 3A) as follows:
- Spray Coating** – Spray apply the liquid to cover the exposed bottom surface of the packing material (Item 3A) compressed and installed in the perimeter joint. Apply a minimum wet film thickness of 1/8 in. and overlap the spray coating a minimum 1/2 in. onto the adjacent curtain wall insulation (Item 2F) and concrete spandrel beam (Item 1B). When the spraying process is stopped and the applied spray coating cures to an elastomeric film before installation process is restarted, then overlap the edge of the cured spray coating at least 1/8 in. with the liquid spray coating.
- Sealant** – Apply non-sag sealant to cover the bottom of the exposed surface of the packing material (Item 3A) compressed and installed in the perimeter joint. Apply minimum 1/4 in. thickness non-sag sealant over the bottom of the packing material (Item 3A) and finish flush against the adjacent curtain wall insulation (Item 2F) and concrete spandrel beam (Item 1B).
- C. Secondary Packing Material** – Install after the fill, void or cavity material (Item 3B) is cured. Use a minimum 4 in. thick, 4-pcf density, mineral wool batt insulation installed with the fibers running parallel to the edge of concrete floor assembly (Item 1) and curtain wall assembly (Item 2). Cut packing material width to achieve same compression as packing material (Item 3A). Compress the packing material into the perimeter joint created between the curtain wall insulation (Item 2F) and the concrete spandrel beam (Item 1B). Stagger butt joints of secondary packing material and packing material (Item 3A). Tightly compress together splices (butt joints) in the lengths of packing material by using minimum 1/4 in. compression per piece of packing material. Verify finished installation flush with bottom of concrete spandrel beam (Item 1B). Use only Intertek certified products meeting the above minimum requirements.
- D. Cover Plate** – Install a minimum 18 GA, L-shaped, steel plate having a nominal 3 in. vertical leg and a horizontal leg sized to span the nominal joint width between the curtain wall insulation (Item 2F) and the concrete spandrel beam (Item 1B). Position the steel plate flush against bottom of concrete spandrel beam (Item 1B) and against the interior exposed vertical aluminum framing, mullions, (Item 2B). Attach the vertical leg of the L-shaped, steel plate to each vertical aluminum framing, mullion, (Item 2B) using minimum #10, self-tapping sheet metal screws nominally 2 in. below the horizontal leg. Space fasteners a maximum of 48 in. on center and attach the horizontal leg of the L-shaped, steel plate to the bottom of concrete spandrel beam (Item 1B) using Hilti XC-20 THP fasteners or equivalent pre-mounted, plastic top-head, concrete nails made of zinc-coated (5 to 13 μ m thick), hardened steel having a nominal 3/4 in. shank length, 0.138 in. diameter, cut point, and dome head configuration.

Reprinted from the Directory of Building Products with permission from Intertek©

3M Firestop Systems

Construction Joints

Head of Wall

CEJ

Head of Wall Dynamic

Quick Reference Guide

Head-of-Wall

| 3M Systems | "F" Rating | 3M Product | Application Details |
|------------|------------|----------------------------------|---|
| CEJ 480 H | 1 | 3M™ Fire Barrier Sealant FD 150+ | Max 1 in. head of wall joint between concrete floor and gypsum wall. 18.25% vertical movement |
| CEJ 481 H | 1 | 3M™ Fire Barrier Sealant FD 150+ | Max 1 in. head of wall joint between fluted metal deck/concrete floor and gypsum wall. 18.25% vertical movement |
| CEJ 482 H | 1 | 3M™ Fire Barrier Sealant FD 150+ | Max 1 in. head of wall joint between concrete floor and gypsum wall. 18.25% vertical movement |

Design No. CEJ 480 H

March 08, 2007

HEAD OF WALL JOINT SYSTEM

ASTME 1966-01

T Rating – 1 hr.

F Rating – 1 hr.

Rated for + 18.25% vertical movement

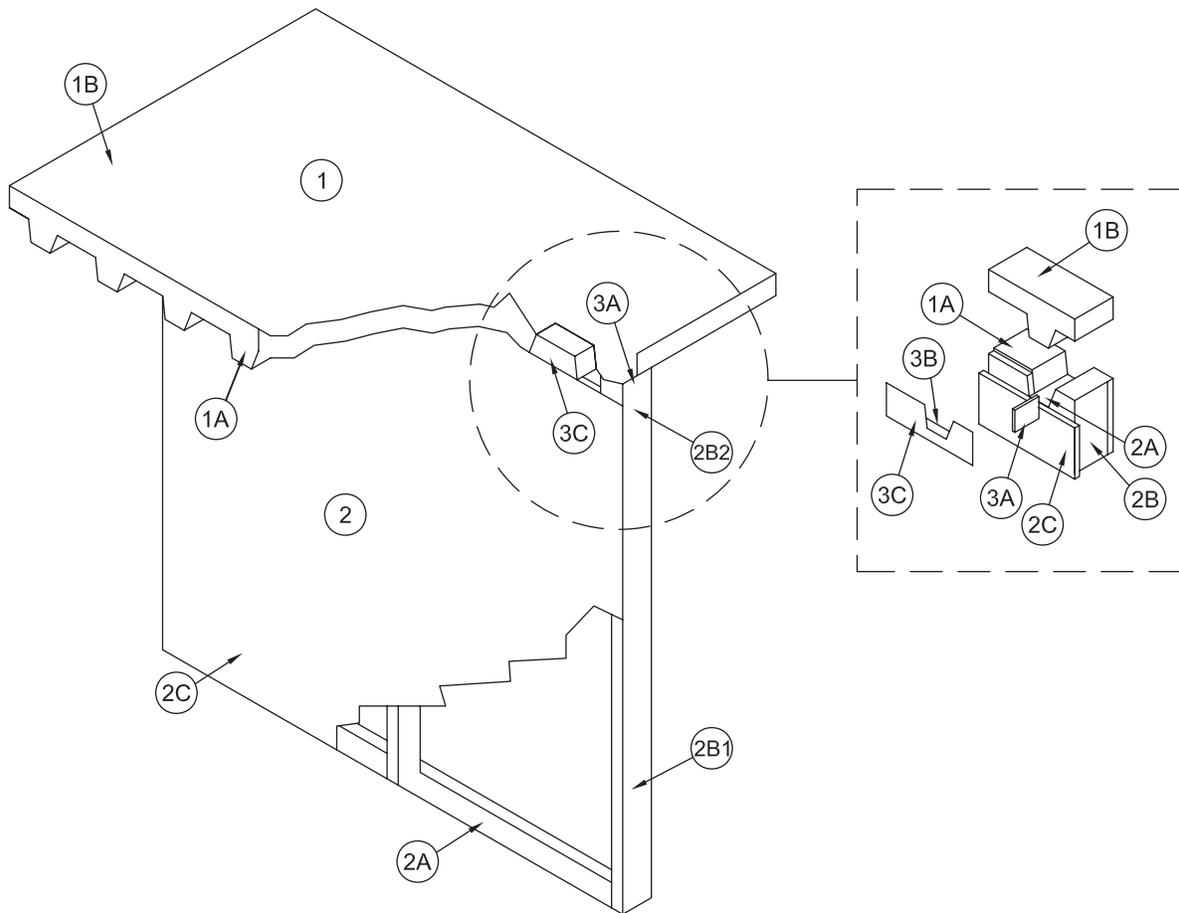

1. FLOOR ASSEMBLY – The floor assembly consists of the following:

- A. Steel Floor and Steel Units – Minimum 18 GA steel fluted decking with open flutes measuring nominally 6-1/2 inches wide at the base, nominally 5-1/4 inches wide at the top, and nominally 3 inches deep. The direction of the flutes is perpendicular to the top of the wall assembly (Item 2).
- B. Concrete – Steel fluted decking (Item 1A) covered with normal weight concrete (approximately 150 pcf and nominally 2000 psi) nominally 2 inches deep at its minimum thickness above the flutes in the steel fluted decking (Item 1A).

2. WALL ASSEMBLY – Non-loadbearing wall assembly positioned perpendicular to the floor ceiling assembly (Item 1) and consisting of the following:

- A. Steel Floor Tracks and Ceiling Runners – Two “C-shaped” roll formed nominal 0.030 inch thick steel tracks nominally measuring 3-5/8 inches wide with two 1-3/8 inch vertical legs. Use nominal 3/16 inch diameter, 1-1/4-inch long, Tapcons, hexhead concrete screws, to attach one track perpendicular to the flutes in the steel decking (Item 1A) on the bottom of floor ceiling assembly (Item 1) and the other track to the top of the floor assembly (Item 1) so that it is aligned plumb with the top track.

Listed Manufacturer:

Trakloc International LLC
358TTS-030-138 Tracks (Item 2A)

- B. Studs – Use “C-shaped” roll formed nominal 0.030 inch thick telescoping steel stud assemblies measuring 3-5/8 inches wide with two 1-3/8 inch vertical legs. Telescoping stud assembly consists of a stud (Item 2B1) and an extension stud (Item 2B2) inserted into the stud. Snap lock steel studs into the steel tracks (Item 2A) at nominal 24-inches on center.

Listed Manufacturer:

Trakloc International LLC
358TSA-030-114 Telescoping Stud Assembly (Item 2B)
358TSO-030-114 Stud (Item 2B1)
358TSE-030-114 Extension Stud (Item 2B2)

Design No. CEJ 480 H *continued*

- C. Gypsum Board – Affix one layer of Type X 5/8-inch thick gypsum board affixed to each side of the telescoping stud assemblies (Item 2B) and tracks (Item 2A) using #8 1-1/2-inch bugle head screws spaced nominally 8-inches on center in the field and around the perimeter. Place no screws nominally 4-inches from the top of the Type X 5/8-inch thick gypsum board. Create a maximum 1-inch head of wall joint at the top of the wall assembly (Item 2) by cutting the Type X 5/8-inch thick gypsum board 1-inch shorter than the height between the steel tracks (Item 2A).
3. JOINT TREATMENT – Maximum 1-inch joint.
- A. Flute Packing Material – Use only mineral wool bearing an Intertek Certified Product Label and meeting the following minimum requirements. Fill the voids created between the flutes in the steel decking (Item 1A) with minimum 4 pcf mineral wool cut into trapezoidal “plug” shapes measuring nominally 3/4 inches less in length than the distance from exposed face to exposed face between the Type X 5/8-inch thick gypsum board (Item 2C) and larger than the trapezoidal openings being filled. Install the trapezoidal “plug” shapes measuring minimum 7-3/4 inches wide at the base, 5 inches wide at the top, and 4 inches deep into the open flutes in the steel decking (Item 1A).
- B. Joint Packing Material – Use only mineral wool bearing an Intertek Certified Product Label and meeting the following minimum requirements. Fill the joint created between the flute packing material (Item 3A) and the top edge of the Type X 5/8-inch thick gypsum board (Item 2C) with 4 pcf mineral wool cut into two filler strips nominally measuring 1-1/2 inches wide by 3/8-inch thick by 24-inches long. Install the filler strips and compress their butt joints. The surface of the flute packing material (trapezoidal shapes) (Item 3A) and the filler strips make a flush recessed surface. Confirm nominal 1/4-inch recess from the exposed face of the Type X 5/8-inch thick gypsum board (Item 2C) to the flush face of the mineral wool insulation.
- C. FILL, VOID OR CAVITY MATERIAL – Fill the nominal 1/4-inch recess with sealant measuring minimum 1/4-inch thick. Trowel-apply sealant over all of the flute packing material (Item 3A) and the joint packing material (Item 3B) overlapping the sealant onto the Type X 5/8-inch thick gypsum board (Item 2C) nominally 1/2 inch.

Listed Manufacturer:

3M Joint Sealant

Interam™ FireDam™ 150+ Caulk (Item 3C)

This material was extracted and drawn by 3M Fire Protection Products from the 2010 Product Directory, © Intertek

Design No. CEJ 481 H

March 08, 2007

HEAD OF WALL JOINT SYSTEM

ASTME 1966-01

T Rating – 1 hr.

F Rating – 1 hr.

Rated for + 18.25% vertical movement

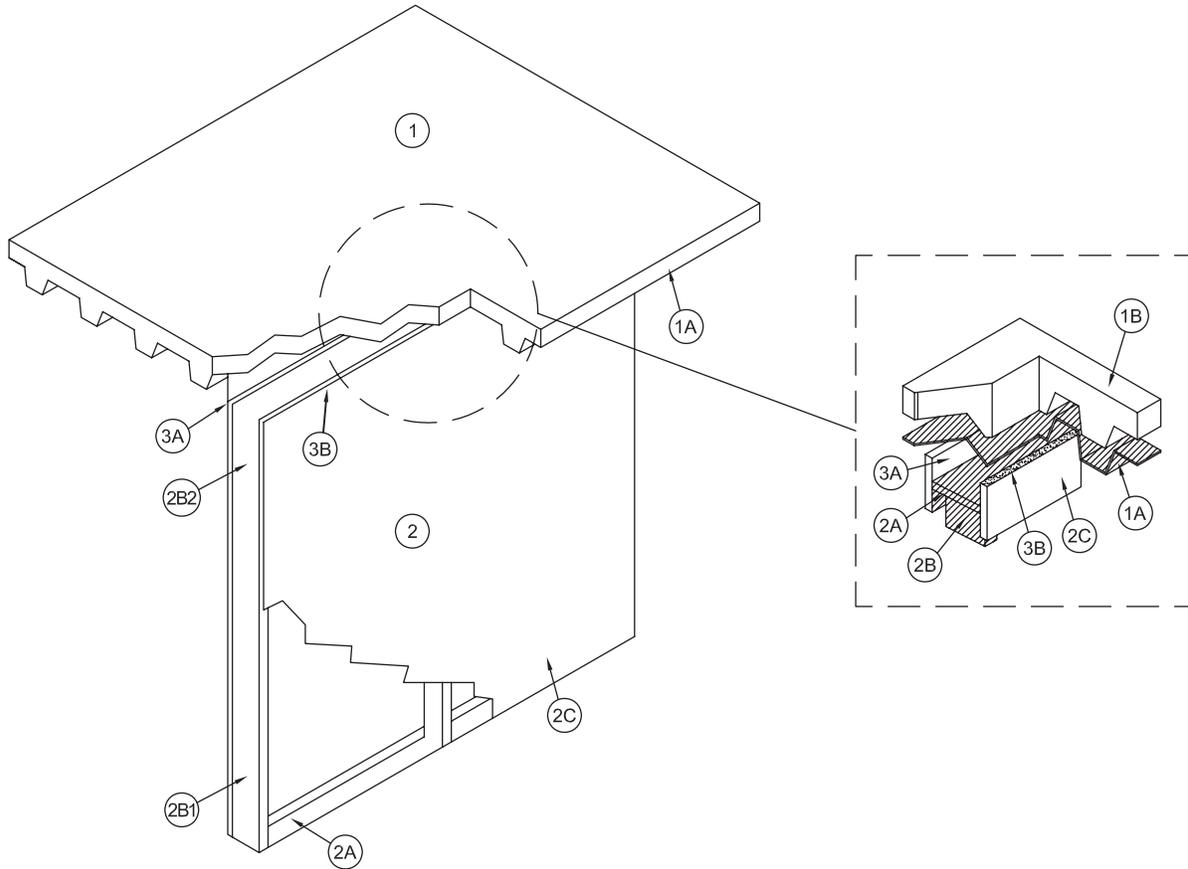

1. FLOOR ASSEMBLY – The floor assembly consists of the following:
 - A. Steel Floor and Steel Units – Minimum 18 GA steel fluted decking with open flutes measuring nominally 6-1/2 inches wide at the base, nominally 5-1/4 inches wide at the top, and nominally 3 inches deep. The direction of the flutes is parallel to the top of the wall assembly (Item 2).
 - B. Concrete – Steel fluted decking (Item 1A) covered with normal weight concrete (approximately 150 pcf and nominally 2000 psi) nominally 2 inches deep at its minimum thickness above the flutes in the steel fluted decking (Item 1A).
2. WALL ASSEMBLY – Non-loadbearing wall assembly positioned perpendicular to the floor ceiling assembly (Item 1) and consisting of the following:
 - A. Steel Floor Tracks and Ceiling Runners – Two “C-shaped” roll formed nominal 0.030 inch thick steel tracks nominally measuring 3-5/8 inches wide with two 1-3/8 inch vertical legs. Use nominal 3/16-inch diameter, 1-1/4-inch long, Tapcons, hexhead concrete screws, to attach one track to the bottom of a flute (parallel to the remaining flutes) in the steel fluted decking (Item 1A) on the bottom of floor ceiling assembly (Item 1) and the other track to the top of the floor assembly (Item 1) so that it is aligned plumb with the top track.

Listed Manufacturer:**Trakloc International LLC****358TTS-030-138 Tracks (Item 2A)**

- B. Studs – Use “C-shaped” roll formed nominal 0.030 inch thick telescoping steel stud assemblies measuring 3-5/8 inches wide with two 1-3/8 inch vertical legs. Telescoping stud assembly consists of a stud (Item 2B1) and an extension stud (Item 2B2) inserted into the stud. Snap lock steel studs into the steel tracks (Item 2A) at nominal 24-inches on center.

Listed Manufacturer:**Trakloc International LLC****358TSA-030-114 Telescoping Stud Assembly (Item 2B)****358TSO-030-114 Stud (Item 2B1)****358TSE-030-114 Extension Stud (Item 2B2)**

Design No. CEJ 481 H *continued*

- C. Gypsum Board – Affix one layer of Type X 5/8-inch thick gypsum board affixed to each side of the telescoping stud assemblies (Item 2B) and tracks (Item 2A) using #8 1-1/2-inch bugle head screws spaced nominally 8-inches on center in the field and around the perimeter. Place no screws nominally 4-inches from the top of the Type X 5/8-inch thick gypsum board. Create a maximum 1-inch head of wall joint at the top of the wall assembly (Item 2) by cutting the Type X 5/8-inch thick gypsum board 1-inch shorter than the height between the top of the flute in the steel fluted decking (Item 1A) and the bottom steel track (Item 2A) attached to the top of the concrete (Item 1B) in the floor assembly (Item 1).
3. JOINT TREATMENT – Maximum 1-inch joint.
- A. Joint Packing Material – Use only mineral wool bearing an Intertek Certified Product Label and meeting the following minimum requirements. Fill the joint created between the top of the flute in the steel fluted decking (Item 1A) and the top edge of the Type X 5/8-inch thick gypsum board (Item 2C) with 4 pcf mineral wool cut into two filler strips nominally measuring 1-1/2 inches wide by 3/8-inch thick by 24-inches long. Install the filler strips and compress their butt joints. Confirm nominal 1/4-inch recess from the exposed face of the Type X 5/8-inch thick gypsum board (Item 2C) to the flush face of the mineral wool insulation.
- B. FILL VOID OR CAVITY MATERIAL – Fill the nominal 1/4-inch recess with sealant measuring minimum 1/4-inch thick. Trowel-apply sealant over all of the joint packing material (Item 3A) overlapping the sealant onto the Type X 5/8-inch thick gypsum board (Item 2C) nominally 1/2 inch.

Listed Manufacturer:

3M Joint Sealant

Interam™ FireDam™ 150+ Caulk (Item 3C)

This material was extracted and drawn by 3M Fire Protection Products from the 2010 Product Directory, © Intertek

Design No. CEJ 482 H

March 08, 2007

HEAD OF WALL JOINT SYSTEM

ASTME 1966-01

T Rating – 1 hr.

F Rating – 1 hr.

Rated for + 18.25% vertical movement

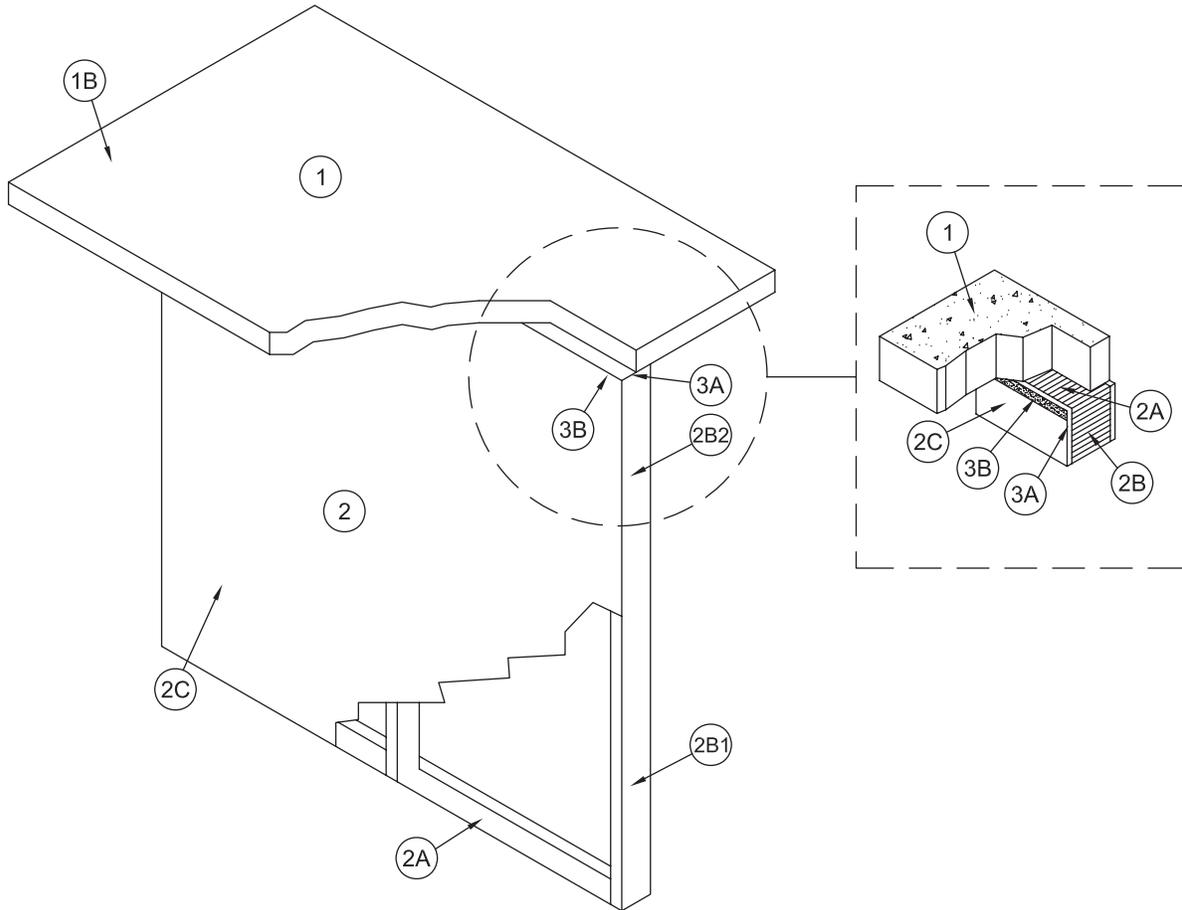

1. FLOOR ASSEMBLY – The floor assembly consists of the following:
 - A. Concrete – Poured-in-place normal weight concrete (approximately 150 pcf and nominally 2000 psi) nominally 4.5 inches deep at its minimum thickness with steel rebar reinforcement.
2. WALL ASSEMBLY – Non-loadbearing wall assembly positioned perpendicular to the floor ceiling assembly (Item 1) and consisting of the following:
 - A. Steel Floor Tracks and Ceiling Runners – Two “C-shaped” roll formed nominal 0.030 inch thick steel tracks nominally measuring 3-5/8 inches wide with two 1-3/8 inch vertical legs. Use nominal 3/16 inch diameter, 1-1/4-inch long, Tapcons, hexhead concrete screws, to attach one track to the bottom of floor ceiling assembly (Item 1) and the other track to the top of the floor assembly (Item 1) so that it is aligned plumb with the top track.

Listed Manufacturer:**Trakloc International LLC****358TTS-030-138 Tracks (Item 2A)**

- B. Studs – Use “C-shaped” roll formed nominal 0.030 inch thick telescoping steel stud assemblies measuring 3-5/8 inches wide with two 1-3/8 inch vertical legs. Telescoping stud assembly consists of a stud (Item 2B1) and an extension stud (Item 2B2) inserted into the stud. Snap lock steel studs into the steel tracks (Item 2A) at nominal 24-inches on center.

Listed Manufacturer:**Trakloc International LLC****358TSA-030-114 Telescoping Stud Assembly (Item 2B)****358TSO-030-114 Stud (Item 2B1)****358TSE-030-114 Extension Stud (Item 2B2)**

- C. Gypsum Board – Affix one layer of Type X 5/8-inch thick gypsum board affixed to each side of the telescoping stud assemblies (Item 2B) and tracks (Item 2A) using #8 1-1/2-inch bugle head screws spaced nominally 8-inches on center in the field and around the perimeter. Place no screws nominally 4-inches from the top of the Type X 5/8-inch thick gypsum board. Create a maximum 1 inch head of wall joint at the top of the wall assembly (Item 2) by cutting the Type X 5/8-inch thick gypsum board 1 inch shorter than the height between the bottom of floor ceiling assembly (Item 1) and the bottom steel track attached to the top of the concrete (Item 1A) in the floor assembly (Item 1).

Design No. CEJ 482 H *continued*

3. JOINT TREATMENT – Maximum 1-inch joint.

- A. Joint Packing Material - Use only mineral wool bearing an Intertek Certified Product Label and meeting the following minimum requirements. Fill the joint created between the bottom of floor ceiling assembly (Item 1) and the top edge of the Type X 5/8-inch thick gypsum board (Item 2C) with 4 pcf mineral wool cut into two filler strips nominally measuring 1-1/2 inch wide by 3/8-inch thick by 24-inches long. Install the filler strips and compress their butt joints. Confirm nominal 1/4-inch recess from the exposed face of the Type X 5/8-inch thick gypsum board (Item 2C) to the flush face of the mineral wool insulation.
- B. FILL, VOID OR CAVITY MATERIAL – Fill the nominal 1/4-inch recess with sealant measuring minimum 1/4-inch thick. Trowel-apply sealant over all of the joint packing material (Item 3A) overlapping the sealant onto the Type X 5/8-inch thick gypsum board (Item 2C) nominally 1/2 inch.

Listed Manufacturer:

3M Joint Sealant

Interam™ FireDam™ 150+ Caulk (Item 3C)

This material was extracted and drawn by 3M Fire Protection Products from the 2010 Product Directory, © Intertek

Duct Wraps

FRD

Grease Duct Protection

DI • V • FRD

Ventilation Duct Protection

FRD

Chemical Fume Exhaust Duct Protection

Penetration Systems – Duct Wrap

PV

Through Wall Assembly

PH

Through Floor Assembly

Plenum Wraps

FRD • BI

Plenum Protection Systems

Duct Wraps

FRD

Grease Duct Protection

DI • V • FRD

Ventilation Duct Protection

FRD

Chemical Fume Exhaust Duct Protection

Grease Duct Protection

| 3M Systems | "F" Rating | 3M Product | Application Details |
|----------------|------------|--|---|
| 3MU/FRD 120-18 | 2 | 3M™ Fire Barrier Duct Wrap 615+ | 2 hour flexible wrap protection for a rectangular grease duct with a maximum 2304 square inch area and maximum 48 inch dimension. Tested per ASTM E 2336. |
| 3MU/FRD 120-19 | 2 | 3M™ Fire Barrier Duct Wrap 615+ | 2 hour flexible wrap protection for a round grease duct with a maximum 1809 square inch area and maximum 48 inch diameter. Tested per ASTM E 2336. |
| FRD-19 | 1, 2 | 3M™ Fire Barrier Duct Wrap 615 3M™ Fire Barrier Sealant IC 15WB+ 3M™ Fire Barrier Sealant CP 25WB+ 3M™ Fire Barrier Water Tight Sealant 1000 NS 3M™ Fire Barrier Water Tight Sealant 1003 SL 3M™ Fire Barrier Water Tight Sealant 3000 WT | Grease duct per NFPA 96 with .93 sq.m. max area with one dimension max 1219mm. System addresses wrap installation and through penetration firestop. 1 & 2 hour F rating. Also known as FRD19. |
| 3MU/BI 120-03 | 2 | 3M Fire Barrier™ Duct Wrap 615+ 3M™ Fire Barrier Sealant CP 25WB+ 3M™ Fire Barrier Water Tight Sealant 1000 NS 3M™ Fire Barrier Water Tight Sealant 1003 SL 3M™ Fire Barrier Silicone Sealant 2000+ | Grease Duct Max 2304 sq. in. with max 48 in. dimension. Wrapped using 615+. Tested per CAN/ULC S114-12 |

Design Number 3MU/FRD 120-18

October 29, 2012

FIRE RESISTANT GREASE DUCT

3M Company

3M Fire Barrier™ Duct Wrap 615+

ASTM E 2336-04 (2009) and

ICC-ES Acceptance Criteria for Grease Duct Enclosure Systems (AC101)

Noncombustibility Test (ASTM E 136) – Pass

Fire Resistance Test (ASTM E 119) – 2 hr

Durability Test (ASTM C 518 modified) – Pass

Internal Fire Test – 4 hr @ 500°F and 30 minutes @ 2000°F – Pass

Fire-Engulfment Test (ASTM E 119 Exposure) – 2 hr

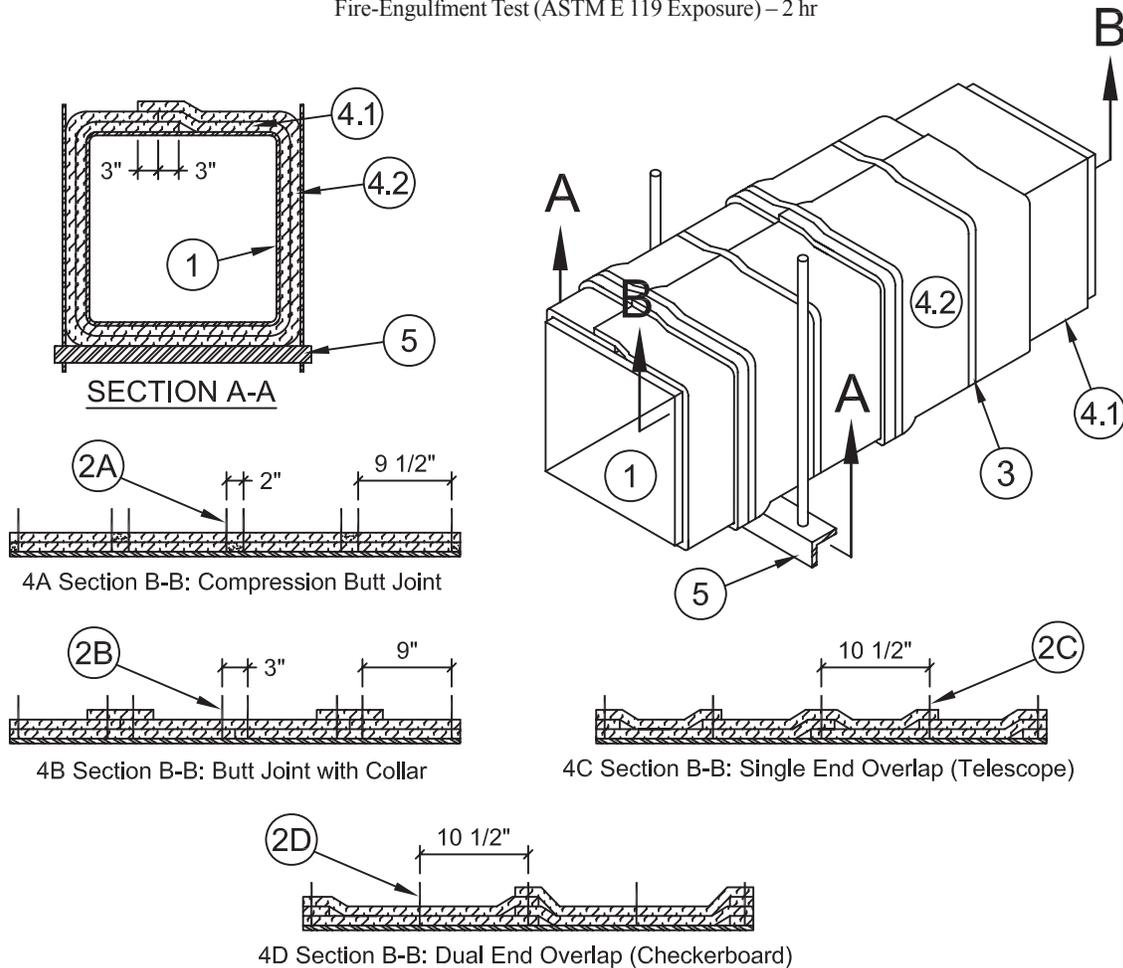

Figure 1

- GREASE DUCT: Use a continuously-welded, liquid-tight, L-shaped, rectangular duct system with horizontal and vertical shafts constructed of 16 GA sheet steel with a maximum 2304 inch² area and a maximum 48-inch dimension. When required, equip the duct with a pre-fabricated access door (Item 6) or field-fabricated access door (Item 7).
 - Construct the grease duct using sections affixed to each other with welded joints.
 - Reinforce the grease duct to IMC or NFPA 96 requirements designed to carry the weight of the grease duct assembly covered with two layers of insulation (Item 4) under a fire load equivalent to the ASTM E 2336 exposure and the ASTM E 119 time-temperature curve.
 - Rigidly support the grease duct (Item 1) as specified in Item 5 or in accordance with IMC or NFPA 96 requirements when those requirements are greater.
 - Protect the annular space around the grease duct (Item 1) passing through a fire-rated assembly with an Intertek-certified, compatible, 3M, penetration firestop system, refer to Section 10, having the same fire rating as the assembly.
- FASTENERS: Refer to Figure 1. Weld minimum 12 GA, 6-1/2-inch long, copper-coated, steel insulation pins or 12 GA, insulated cup head steel pins to the grease duct (Item 1). Match the following fastener method with corresponding insulation (Item 4) method.
 - Compression Butt Joint: Refer to 4A Section View B-B. Locate pins at all blanket overlaps, on all sides of the grease duct (Item 1), and meet the following requirements.
 - Space pins maximum 12 inches apart in rows across the width of grease duct (Item 1). Locate pins maximum 6-3/4 inches from the edges of the grease duct (Item 1). Refer to section view A-A.
 - Space the rows of pins as follows: use pattern nominal 9 inches apart, then maximum 2 inches apart, then nominal 9 inches apart along the length of the grease duct (Item 1). Refer to Item 4A section view B-B.

¹ ACCEPTANCE CRITERIA FOR GREASE DUCT ENCLOSURE ASSEMBLIES, AC101, Approved April 2001 (Editorially revised October 2004) states, "The system may be installed with zero clearance from the insulating materials to combustibles."

DESIGN NO. 3MU/FRD 120-18 *continued*

Flexible Wraps

- iii. After insulation (Item 4A) is installed, place minimum 2-1/2 x 2-1/2-inch square, galvanized steel, self locking washer clips onto all insulation pins.
 - iv. After clips are installed, cut off or bend flush with insulation (Item 4A) the pins that are too long.
- B. Butt Joint with Collar: Refer to 4B Section View B-B. Locate pins at all blanket overlaps, on all sides of the grease duct (Item 1), and meet the following requirements.
- i. Space pins maximum 12 inches apart in rows across the width of grease duct (Item 1). Locate pins maximum 6-3/4 inches from the edges of the grease duct (Item 1). Refer to section view A-A.
 - ii. Space the rows of pins as follows: use pattern nominal 9 inches apart, then maximum 3 inches apart, then nominal 9 inches apart along the length of the grease duct (Item 1). Refer to Item 4B section view B-B.
 - iii. After insulation (Item 4B) is installed, place minimum 2-1/2 x 2-1/2-inch square, galvanized steel, self-locking washer clips onto all insulation pins.
 - iv. After clips are installed, cut off or bend flush with insulation (Item 4B) the pins that are too long.
- C. Single End Overlap (Telescope): Refer to 4C Section View B-B. Locate pins at all blanket overlaps, on all sides of the grease duct (Item 1), and meet the following requirements.

Duct Wrap

- i. Space pins maximum 12 inches apart in rows across the width of grease duct (Item 1). Locate pins maximum 6-3/4 inches from the edges of the grease duct (Item 1). Refer to section view A-A.
 - ii. Space the rows of pins maximum 10-1/2 inches apart along the length grease duct (Item 1). Where pieces of insulation (Item 4C) are butted together, space pins a maximum 1-1/2 inches from the edge of the insulation. Refer to Item 4C section view B-B.
 - iii. After insulation (Item 4C) is installed, place minimum 2-1/2 x 2-1/2-inch square, galvanized steel, self-locking washer clips onto all insulation pins.
 - iv. After clips are installed, cut off or bend flush with insulation (Item 4C) the pins that are too long.
- D. Dual End Overlap (Checkerboard): Refer to 4D Section View B-B. Locate pins at all blanket overlaps, on all sides of the grease duct (Item 1), and meet the following requirements.
- i. Space pins maximum 12 inches apart in rows across the width of grease duct (Item 1). Locate pins maximum 6-3/4 inches from the edges of the grease duct (Item 1). Refer to section view A-A.
 - ii. Space the rows of pins maximum 10-1/2 inches apart along the length grease duct (Item 1). Where pieces of insulation (Item 4D) are butted together, space pins a maximum 1-1/2 inches from the edge of the insulation. Refer to Item 4D section view B-B.
 - iii. After insulation (Item 4D) is installed, place minimum 2-1/2 x 2-1/2-inch square, galvanized steel, self-locking washer clips onto all insulation pins.
 - iv. After clips are installed, cut off or bend flush with insulation (Item 4D) pins that are too long.

3. BANDING: Do not use banding for the installation of insulation method (Item 4A), Compression Butt Joint. Banding is an option to fastener methods (Items 2B, 2C and 2D) but not fastener method (Item 2A). After insulation (Item 4) is installed, apply minimum 1/2 inch wide, 0.015-inch thick stainless steel bands or minimum 1/2 inch wide, 0.020-inch thick carbon steel bands and secured with minimum 1-inch long stainless or carbon steel crimp clamps to be used with corresponding banding type. When needed to ease installation, use filament tape as a temporary hold for the insulation (Item 4) prior to banding. Place banding a maximum 1-1/2 inches from all insulation (Item 4) edges and a maximum of 10-1/2 inches on center (O.C.). Tension the banding to hold the insulation (Item 4) in place without cutting or damaging the insulation (Item 4) or grease duct (Item 1).

4. CERTIFIED MANUFACTURER: 3M Company

CERTIFIED PRODUCT: 3M Fire Barrier™ Duct Wrap

MODEL: 615+

INSULATION: Apply the non-combustible (ASTM E136) and durable (ASTM C518) insulation in two layers of nominal 1-1/2-inches thick, 6-pcf density blanket, made of calcium-, silica-, and magnesium-oxide (CSM) fibers, encapsulated with polypropylene-foil or aluminized polyester-foil scrim over the entire surface of the grease duct (Item 1). Apply the inner first layer (Figure 1, 4.1) in accord with one of the four methods (A, B, C, or D) that follow. Offset the second outer layer (Figure 1, 4.2) one half the width of the inner first layer (Figure 1, 4.1) so that the joints of the inner first layer (Figure 1, 4.1) are covered by and approximately in the center of the second outer layer (Figure 1, 4.2). Apply the second outer layer (Figure 1, 4.2) in accord with the same method selected for the first inner layer (Figure 1, 4.1). Use blanket, available in various widths, that is fully encapsulated or single faced with a polypropylene-foil or polyester-foil scrim. Expose a foil-faced side of insulation to view. Wrap one layer of insulation around the grease duct (Item 1) perimeter so that each terminating end of insulation overlaps onto the starting end of insulation a minimum of 3 inches at all transverse joints. Stagger the transverse overlap location so that no two consecutive adjacent overlaps align. Refer to section view A-A for transverse overlap section view. Cover all visually-exposed ends and edges of insulation with nominal 4-inch wide, pressure-sensitive, aluminum foil tape.

- A. Compression Butt Joint: Refer to Item 4A section view B-B. Wrap the grease duct (Item 1) with two layers of insulation installed with compression butt joints at all circumferential joints. Apply the first layer, center pieces of insulation (Item 4A) over 2-inch-wide pin bay, so that each piece nominal 24-inch-wide blanket occupies two (2) full 9-inch-wide bays and three (3) full 2-inch-wide bays. Compress each edge of each piece of insulation together and butt to preceding edge of insulation in 2-inch-wide bays. After installation, each piece of installed insulation width is 2 inches less than insulation nominal width. (Example: each piece of nominal 24-inch-wide insulation when installed is 22 inches wide.) Verify all insulation butt joints are compressed minimum 50% at compression butt joints. Offset the second layer of insulation so that the compression butt joint of the first layer of insulation is centered under the second layer of insulation and install in same manner as first layer of insulation.

- B. Butt Joint with Collar: Refer to Item 4B section view B-B. Wrap the grease duct (Item 1) with two layers of insulation installed with butt joints at all circumferential joints. Apply the first layer, center pieces of insulation (Item 4A) over 3 inch wide pin bay, so that each piece nominal 24-inch-wide blanket occupies two (2) full 9-inch-wide bays and one (1) full 3-inch-wide bays and half of two (2) 3-inch-wide bays at each circumferential edge. Butt each end of each piece of insulation together with preceding edge of insulation. Each piece of installed insulation width is its nominal width. (Example: each piece of nominal 24-inch-wide insulation when installed

Grease Duct

FRD

DESIGN NO. 3MU/FRD 120-18 *continued*

is 24 inches wide.) Offset the second layer of insulation so that the butt joint of the first layer of insulation is centered under the second layer of insulation and install in same manner as first layer of insulation. Place and center 6-inch-wide collar of insulation over the butt joint. Overlap 6-inch-wide collar onto each adjacent insulation 3 inches. Verify all insulation butt joints with collars are three layers of insulation in overall thickness.

- C. Single End Overlap (Telescope): Refer to Item 4C section view B-B. Wrap the grease duct (Item 1) with two layers of insulation installed with 3-inch minimum overlaps at all longitudinal joints. Overlap each adjacent insulation edge with the edge of the next piece of insulation. Verify all insulation overlaps are three layers of insulation in overall thickness.
- Starting at one end of the grease duct (Item 1), apply the first piece of insulation around the grease duct (Item 1) to overlap fasteners (Item 2C). Refer section view A-A.
 - Position and overlap the leading edge of the second piece of insulation nominally 3 inches over the flush edge of the first piece of insulation. Place the opposite edge of the second piece of insulation flush against the surface of the grease duct (Item 1). An “S-shaped” cross section of the insulation is created. Refer to Item 4C section view B-B.
 - Apply all additional pieces of insulation as “S-shaped” cross section of the insulation in compliance with Item 4Cii.
 - Position the second layer of insulation so that the joint of the first layer of insulation is centered under the second layer of insulation and install in same manner as first layer of insulation.
- D. Dual End Overlap (Checkerboard): Refer to Item 4D section view B-B. Verify all insulation overlaps are a minimum 3 inches in overall thickness. Do not align two consecutive insulation end overlaps. Overlap each full width insulation edge with the edge of the “gull wing” (v) shaped piece of insulation. Install insulation with zero clearance at the overlaps, or in the field between overlaps. Verify all insulation overlaps are four layers of insulation in overall thickness.
- Wrap the first piece of insulation around the grease duct (Item 1) so that the insulation is flush against the surface of the grease duct (Item 1). Position the starting end of the insulation to overlap pins (Item 2A) a minimum of 1-1/2 inches while the edges of the insulation overlap the rows of pins (Item 2B) a minimum of 1-1/2 inches.
 - Position the second piece of insulation nominally 18 inches from the edge of the first piece of insulation. Install the second piece in the same manner as the first.
 - Cover the grease duct (Item 1) that is exposed between the edges of the first two pieces of insulation with another piece of insulation. Position the starting end of the insulation to overlap pins (Item 2A) a minimum of 1-1/2 inches while the edges of the insulation overlap the adjacent edges of the two pieces installed insulation a minimum of 1-1/2 inches.
 - Position the second layer of insulation so that the first layer of insulation is centered under the second layer of insulation and install in same manner as first layer of insulation.
5. SUPPORTS: If the grease duct is 24-inches x 24-inches or smaller, support the grease duct (Item 1) with insulation (Item 4) using a un-insulated “trapeze” system composed of a minimum 2 x 2 x 1/8-inch steel angle as the trapeze cross-member and two (2), minimum 3/8-inch diameter, all-thread, steel rods connected using nuts and washers. For ducts larger than 24-inches x 24-inches, support the grease duct (Item 1) with insulation (Item 4) using a un-insulated “trapeze” system composed of a minimum 2 x 2 x 1/4-inch steel angle as the trapeze cross-member and two (2), minimum 1/2-inch diameter, all-thread, steel rods connected using nuts and washers. Connect the all-thread steel rods to the bottom of the floor assembly using an attachment method designed to carry the weight of the grease duct (Item 1) with insulation (Item 4) under a fire load equivalent to ASTM E 119 time-temperature curve. Place one (1) all-thread steel rod at each end of trapeze cross-member. Center grease duct (Item 1) with insulation (Item 4) on trapeze cross-member. Space all-thread steel rods a maximum 6 inches from surface of the insulated grease duct or allowing all-thread steel rods to contact with the insulation (Item 4) at the minimum distance. Extend trapeze cross-member at least 2 inches past each all-thread, steel rod. Space trapeze supports a maximum 60 inches on center.
6. CERTIFIED MANUFACTURER: 3M Company
CERTIFIED PRODUCT: 3M Fire Barrier™ Grease Duct Access Door
MODELS:
 - 000-51115-16584-9 (door for 20x20 opening),
 - 000-51115-16583-2 (door for 12x8 opening), and
 - 000-51115-16582-5 (door for 10x6 opening)CERTIFIED MANUFACTURER: Ductmate Industries, Inc.
CERTIFIED PRODUCT: Grease Duct Access Door
MODELS: Ductmate ULtimate Door™
 - D2020ULWS (door for 20x20 opening),
 - D128ULWS (door for 12x8 opening), and
 - D106ULWS (door for 10x6 opening)ACCESS DOOR ASSEMBLY: When required, apply an access door and insulated cover plate as described:
- A. OPTIONAL PRE-FABRICATED ACCESS DOOR: Mark a clean-out access opening location on the grease duct (Item 1) with insulation (Item 4) at its mid-height along the horizontal section. Cut an opening (maximum 22 x 22 inches) in the insulation (Item 4) the same size as the outside dimension of the desired pre-fabricated access door model. Remove and discard the cut insulation (Item 4). Cut an opening (maximum 20 x 20 inches) into the side of the grease duct (Item 1) according to the manufacturer’s instructions for the size of the pre-fabricated access door to be installed. Install and tightly secure the pre-fabricated access door in accordance with the manufacturer’s instructions to the grease duct (Item 1). Fit pre-fabricated access door with four (4), 3/8-inch diameter, corner-thumb bolts through the exterior face.
- B. CERTIFIED MANUFACTURER: 3M Company
CERTIFIED PRODUCT: 3M Fire Barrier™ Duct Wrap
MODEL: 615+

Flexible Wraps

Duct Wrap

Grease Duct

FRD

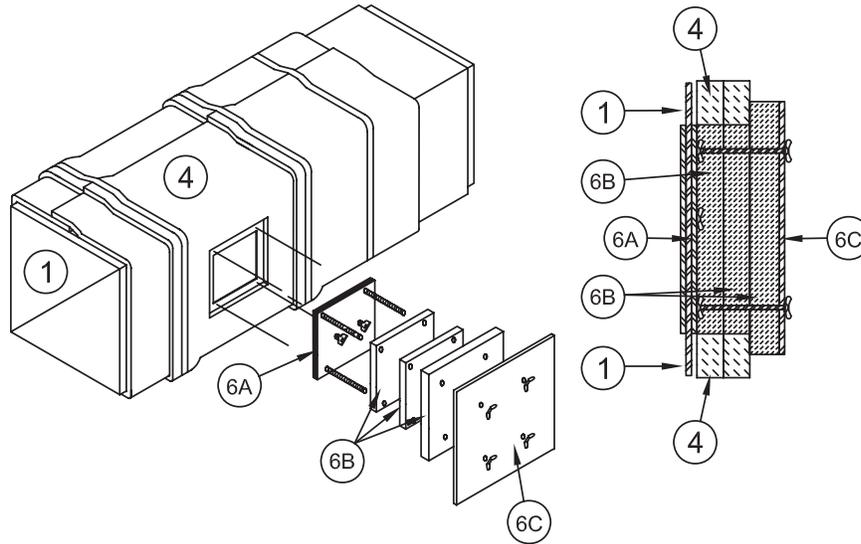

Figure 2 – 3M Pre-fabricated Access Door

Figure 2 – 3M or Ductmate Pre-fabricated Access Door

ACCESS INSULATION: Remove the four (4), 3/8-inch diameter, corner-thumb bolts and replace them with four (4), 3/8-inch diameter, all-thread, steel rods extending from pre-fabricated access door (Item 6A). Apply three (3) layers of access insulation over the pre-fabricated access door (Item 6A) as follows. Cut the first piece of rectangular access insulation a minimum 1/4 inch larger than the clean-out access opening. Position, square, and impale the first piece of the access insulation over the four (4), 3/8-inch diameter, all-thread, steel rods extending from pre-fabricated access door (Item 6A). Press the first piece of access insulation flush over the pre-fabricated access door (Item 6A). Compress and abut the cut edges of the first piece of the access insulation against the cut edges of opening in the insulation (Item 4). Cut a second piece of access insulation the same size as the first piece of access insulation. Press the second piece of access insulation flush over the first piece of access insulation. Compress and abut the cut edges of the first piece of the access insulation against the cut edges of opening in the insulation (Item 4). Cut a third piece of rectangular access insulation a minimum of 2 inches larger than the second piece of access insulation on all sides. Seal cut edges of the third piece of access insulation with nominal 4-inch-wide aluminum foil tape. Position, square, and impale the third piece of the access insulation over the four (4), 3/8-inch diameter, all-thread, steel rods extending from pre-fabricated access door (Item 6A). Press the third piece of access insulation flush over second piece of access insulation.

C. COVER PLATE: Cut a cover plate to the same dimensions as the third piece of access insulation (Item 6B) using a minimum 16 GA steel sheet. Drill holes in the cover plate that match the location of the four (4), 3/8-inch diameter, all-thread, steel rods and locate the holes so that the cover plate is squared to the third piece of access insulation (Item 6B). After all three (3) layers of access insulation (Item 6B) are impaled over the four (4), 3/8-inch diameter, all-thread, steel rods install the cover plate. Pass the four (4), 3/8-inch diameter, all-thread, steel rods through the cover plate. Place washers and wing nuts onto each of the four (4), 3/8-inch diameter, all-thread, steel rods. Secure the cover plate by tightening wing nuts.

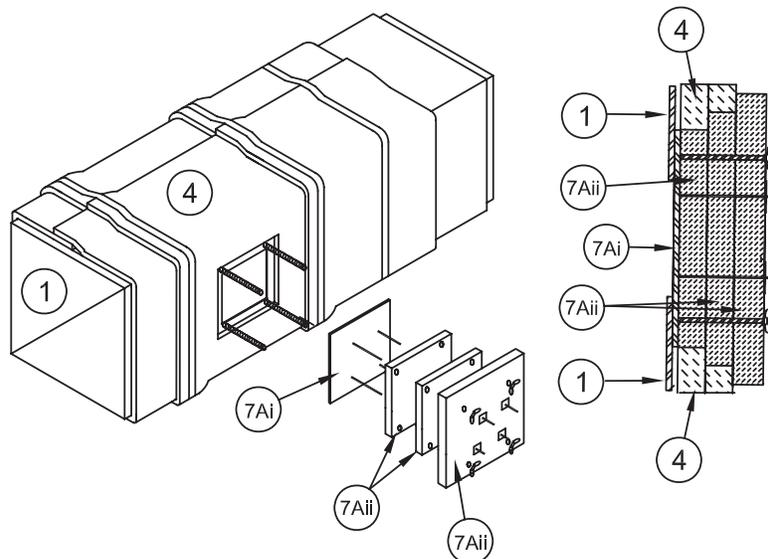

Figure 3 – Field Fabricated Access Door Option A

7. **OPTIONAL FIELD-FABRICATED ACCESS DOORS:** Mark a clean-out access opening location on the grease duct (Item 1) with insulation (Item 4) at its mid-height along the horizontal section. Use either Option A or B.
 - A. (OPTION A) Cut a 12x12-inch opening in the insulation (Item 4). Remove and discard the cut insulation (Item 4). Cut and center a 10x10-inch opening into the side of the grease duct (Item 1) by maintaining a 1-inch clearance between the perimeter of the opening and the cut insulation (Item 4). Remove and discard the cut steel. Weld four (4), minimum 4-inch long, 1/4-inch diameter, all-thread, steel

DESIGN NO. 3MU/FRD 120-18

rods to the grease duct (Item 1). Locate one (1) steel rod at each corner of the grease duct (Item 1) opening so that they are 11 inches on center and squared within the insulation (Item 4) opening.

- i. **ACCESS DOOR:** Cut a 12x12-inch, 16 GA, steel plate to be used as an access door. Drill clearance holes in the access door to match the all-thread, steel rod pattern. Place the access door over the all-thread, steel rods. Seal the opening in the grease duct (Item 1) by overlapping the access door over the opening cut in the insulation (Item 4) by 1 inch on all sides. Weld four (4), minimum 6-1/2-inch long, 12 GA, copper-coated, steel insulation pins to the access door corners so that the insulation pins are 9 inches on center.
 - ii. **CERTIFIED MANUFACTURER:** 3M Company
CERTIFIED PRODUCT: 3M Fire Barrier™ Duct Wrap
MODEL: 615+
ACCESS INSULATION: Apply three (3) layers of access insulation over the access door. Cut the first piece of access insulation into a 12x12-inch square and install it over the insulation pins and cover the access door (Item 7Ai). Cut the second piece of access insulation into a 14x14-inch square. Square it and install it over the insulation pins. Cover the first piece of access insulation so that a 1-inch overlap exists. Cut the third piece of access insulation into a 16x16-inch square. Square it and install it over the insulation pins. Cover the second piece of access insulation so that a 1-inch overlap exists. Secure access insulation to the insulation pins with 1-1/2-inch square or round, galvanized or stainless steel, speed clips. Turn down or cut off insulation pins that extend beyond the second piece of access insulation. Place maximum 4-inch long, steel tubing over each all-thread, steel rods. Apply washers and wing nuts over the all-thread, steel rods. Secure the access door by tightening the wing nuts.
- B. (OPTION B)** Cut a maximum 16x16-inch opening into the insulation (Item 4) and the grease duct (Item 1). Remove and discard the cut insulation (Item 4) and steel. Weld together four (4) pieces of 1-1/2 x 1-1/4 x 1/8-inch steel angle, with the flange outward, to form a 1-1/2-inch tall, flanged frame. Position, center, and continuously weld the flanged frame around the opening in the grease duct (Item 1). Position one (1), minimum 4-inch long, 1/4-inch diameter, all-thread, steel rod in the center of each of the four (4) corners of the flange and weld them in place.
- i. **ACCESS DOOR:** Cut an 18-1/2 x 18-1/2-inch, 16 GA, steel plate to be used as an access door. Drill clearance holes in the access door to match the all-thread, steel rod pattern on the flange. Place the access door over the all-thread, steel rods.
 - ii. **COVER PLATE:** Cut a 20-1/2 x 20-1/2-inch external cover plate out of 16 GA steel sheet and drill clearance holes matching the locations of the all-thread, steel rods on the flange. Weld minimum four (4), 12 GA, copper-coated, steel insulation pins onto the internal surface of the cover plate, spaced minimum 14 inches on center. Limit insulation pin length to one-half total access insulation thickness. Install access insulation (Item 7Bii). Position the cover plate with access insulation over the all-thread, steel rods flush to access door. Apply washers and wing nuts over the all-thread, steel rods. Secure the access door by tightening the wing nuts.

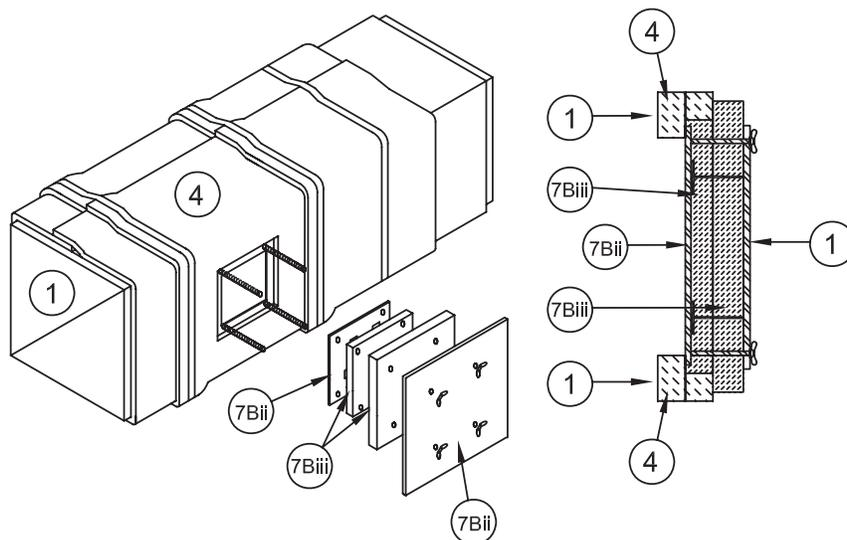

Figure 4 – Field Fabricated Access Door Option B

- iii. **CERTIFIED MANUFACTURER:** 3M Company
CERTIFIED PRODUCT: 3M Fire Barrier™ Duct Wrap
MODEL: 615+

ACCESS INSULATION: Apply two layers of access insulation over the interior of the cover plate. Cut the first piece of access insulation into a 20-1/2 x 20-1/2-inch square and install it over the insulation pins on the internal surface of the cover plate. Cut the second piece of access insulation into a 24 x 24-inch square. Square it to and install it over the insulation pins. Cover the first piece of access insulation so that a 1-3/4-inch overlap exists. Secure access insulation to insulation pins with 1-1/2-inch square or round, galvanized or stainless steel speed clips. Turn down or cut off insulation pins that extend beyond the second piece of access insulation.

8. **NONCOMBUSTBLE² SUPPORTING CONSTRUCTION:** Refer to Figures 3 and 4. Use one of the following wall or floor assemblies.
 - A. **GYPSUM WALL ASSEMBLY:** Symmetrical two-hour rated gypsum wall assembly constructed of the following:
 - i. **Steel Studs** – Minimum 25 GA galvanized steel studs measuring 3-5/8 inch wide with 1-1/4-inch legs spaced maximum 24 inch on center (O.C.). Attach studs with minimum #6 x 3/8-inch steel stud framing screws to floor and ceiling tracks.

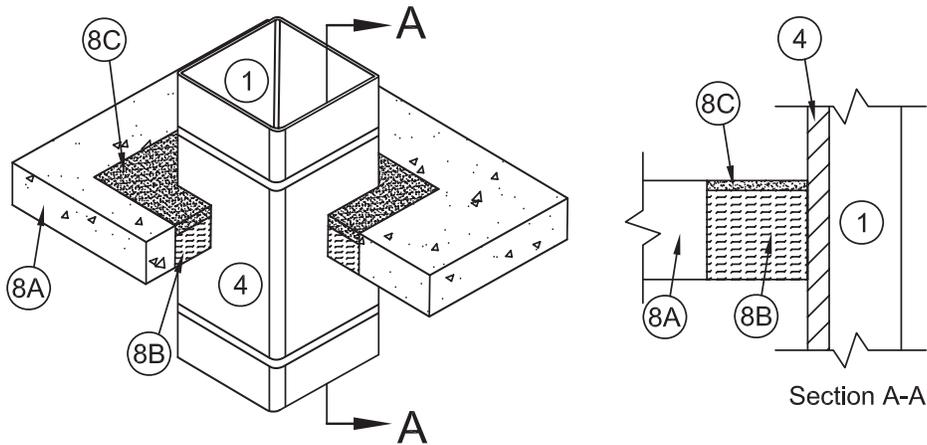

Figure 5 – Noncombustible Supporting Constructions

- ii. Tracks – Channel U-shaped floor and ceiling runners measuring 1/2-inch deep by 3-5/8-inch wide, which are secured to floor and ceiling with 1-inch long fasteners suitable for the mounting to substrate and spaced maximum 18-inch O.C.
- iii. Gypsum Board – Cover studs and runners with two layers of 5/8 inch thick, Type X gypsum board on each face. Fasten base layer of gypsum board to steel studs with #6 1-1/8 inch bugle head phillips drywall screws spaced maximum 12 inch O.C. Fasten face layer of gypsum board with #6, 1-5/8 inch long bugle phillips drywall screws spaced maximum 8 inches O.C. Apply vinyl or casein, dry or premixed joint compound to face layers of gypsum board in two coats to all exposed screw heads and gypsum board joints. Embed minimum 2 inch wide paper, plastic or fiberglass tape in first layer of joint compound over joints in gypsum board. Minimum wall assembly thickness of 6 inches measured from face layer of gypsum board to opposite face layer of gypsum board.

B. SHAFT WALL ASSEMBLY:

Asymmetrical two-hour rated gypsum shaft wall assembly constructed of the following:

- i. Visual Gypsum Board – Cover studs and runners with two layers of minimum 1/2 inch thick, Type X gypsum board on each face. Fasten base layer of gypsum board to steel studs with #6 1-1/8 inch bugle head phillips drywall screws spaced maximum 12 inch O.C. Fasten face layer of gypsum board with #6, 1-5/8 inch long bugle phillips drywall screws spaced maximum 8 inches O.C. Apply vinyl or casein, dry or premixed joint compound to face layers of gypsum board in two coats to all exposed screw heads and gypsum board joints. Embed minimum 2 inch wide paper, plastic or fiberglass tape in first layer of joint compound over joints in gypsum board. Minimum wall assembly thickness of 4-1/2 inches measured from face layer of gypsum board to opposite face layer of gypsum board.
- ii. Interior Gypsum Board – Cut 1-inch thick Type X gypsum board 1-inch less than floor to ceiling height. Insert the longitudinal edges of the 1-inch thick Type X gypsum board into the C-T or C-H studs. Secure the transverse edge of the 1-inch thick Type X gypsum board to the long leg of J-runner using its tabs or minimum 1-5/8-inch long Type S self-tapping bugle head steel screws spaced maximum 12 inches on center.
- iii. Steel Studs – Cut minimum 25 GA galvanized steel C-T or C-H studs measuring minimum 2-1/2 inches wide with minimum 1-1/2-inch flanges 3/4-inches less than floor to ceiling height and spaced maximum 24 inch on center (O.C.) in runners with T or H section abutting long leg of runner.
- iv. Runners – Use minimum 2-1/2- inch wide J-runner compatible with studs and having unequal vertical legs: minimum 1-inch short leg and minimum 2-inch long leg. Position J-runners with short leg towards visual face of shaft wall. Attach to floor and ceiling using steel fasteners located a maximum of 2-inches from each end and a maximum of 24 inch O.C.

C. CONCRETE WALL ASSEMBLY: Symmetrical, two-hour rated, solid concrete, wall assembly made from reinforced lightweight or normal weight (100-150 pcf or 1600-2400 kg/m³) concrete, which may also be used as a shaft wall assembly. Constructed of solid concrete with a minimum concrete thickness measured from exposed face to exposed face using one of the following:

- i. lightweight concrete is 3.6 inches;
- ii. sand-lightweight concrete is 3.8 inches;
- iii. carbonate aggregate concrete is 4.6 inches; and
- iv. siliceous aggregate concrete is 5.0 inches.

D. MASONRY WALL ASSEMBLY: Symmetrical, two-hour rated, nominal 8 x 8 x 16 CMU, wall assembly made from lightweight or normal weight (100-150 pcf or 1600-2400 kg/m³) concrete, which may also be used as a shaft wall assembly.

E. CONCRETE FLOOR ASSEMBLY: Symmetrical two-hour rated solid concrete floor assembly made from reinforced lightweight or normal weight (100-150 pcf or 1600-2400 kg/m³) concrete. Constructed of solid concrete with a minimum concrete thickness measured from exposed face to exposed face using one of the following:

- i. lightweight concrete is 3.6 inches;
- ii. sand-lightweight concrete is 3.8 inches;
- iii. carbonate aggregate concrete is 4.6 inches; and
- iv. siliceous aggregate concrete is 5.0 inches

² Refers to building construction referenced in the building codes.

DESIGN NO. 3MU/FRD 120-18 *continued*

9. OPENING – Create an opening in the assembly. Position the grease duct (Item 1) concentrically or eccentrically in the opening so that the annular space ranges from minimum 0.5 inch to maximum 4-1/2 inches. Establish an opening designed to house the grease duct (Item 1) covered with insulation (Item 4) and the desired annular space but not exceeding a cross-sectional area of maximum 3136 inch² and a maximum dimension of 59.5 inches

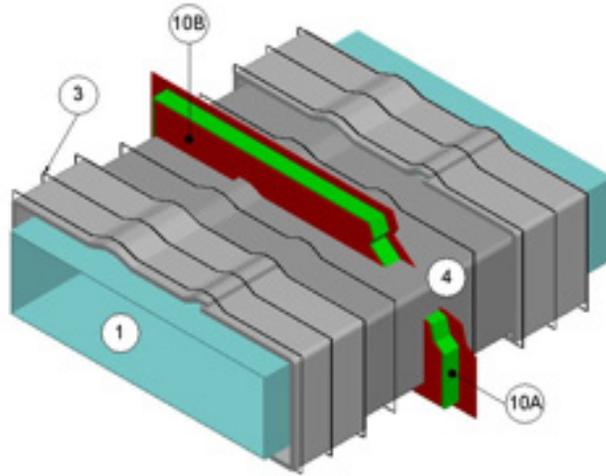

Symmetrical Firestops for Horizontal Grease Ducts with Insulation Through Noncombustible Wall Assemblies

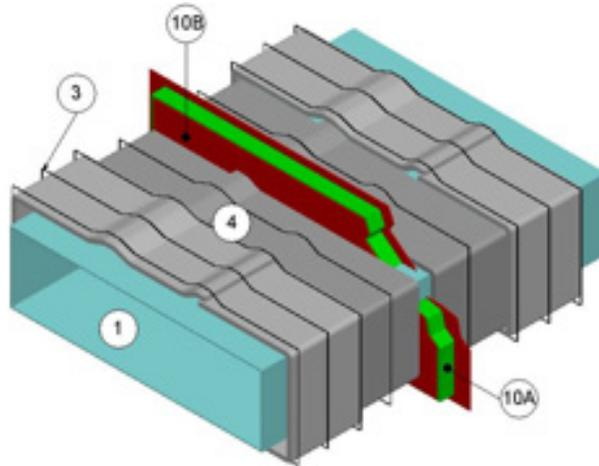

Symmetrical Firestops for Horizontal Grease Ducts without Insulation Through Noncombustible Wall Assemblies

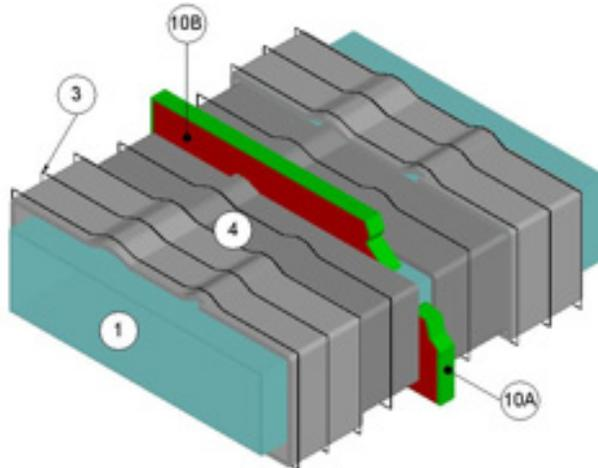

Asymmetrical Firestops for Horizontal Grease Ducts without Insulation Through Noncombustible Shaft Assemblies

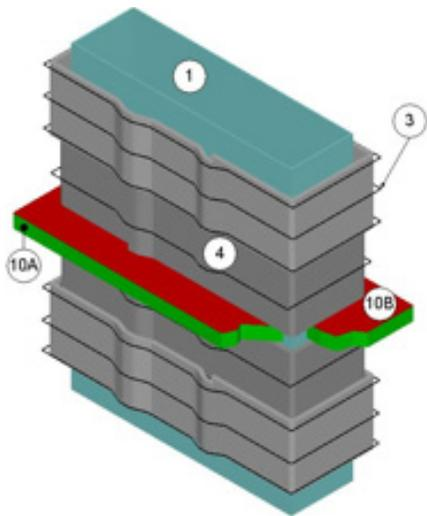

Asymmetrical Firestops for Vertical Grease Ducts without Insulation Through Noncombustible Floor Assemblies

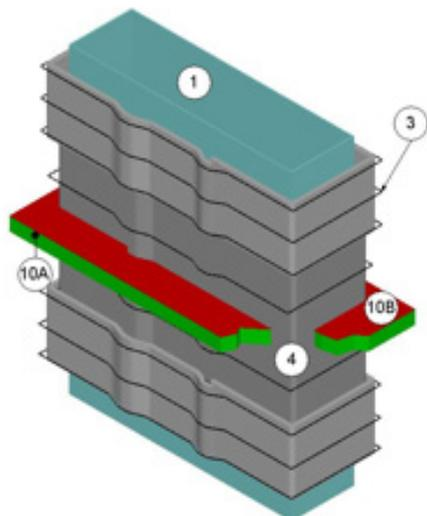

Asymmetrical Firestops for Vertical Grease Ducts with Insulation Through Noncombustible Floor Assemblies

Figure 6 – Penetration Firestops for Noncombustible Supporting Constructions

10. PENETRATION FIRESTOP: Install two-hour, fire-resistant, ASTM E 814, firestop system. Install firestop between the supporting construction (Item 6) and the grease duct (Item 1) or the grease duct (Item 1) protected with the insulation (Item 4). Use a symmetrical wall penetration firestop, an asymmetrical shaft penetration firestop, or an asymmetrical floor penetration firestop constructed of the following components.

A. CERTIFIED MANUFACTURER: 3M Company

CERTIFIED PRODUCT: 3M Fire Barrier™ Duct Wrap

MODEL: 615+

PACKING MATERIAL: Fill the entire annular space's width with minimum 4-pcf density mineral wool or certified insulation without the encapsulation (foil scrim).

Cut the packing material into strips not less than one and one half (1-1/2) times the width of the annular space to be filled. Compress packing material nominally 33% and insert packing material into the annular space.

For wall assemblies, recess the surface of packing material nominally 5/8 inches from surfaces of both faces of the supporting construction (Item 8).

For floor assemblies, recess the surface of packing material nominally 5/8 inches from the visual surface of the supporting construction (Items 8) and install a minimum depth of 4-inches.

B. CERTIFIED MANUFACTURER: 3M Company

CERTIFIED PRODUCT: 3M™ Fire Barrier™ Sealant

MODEL: Water-Tight 1000-NS Silicone, 1003-SL Silicone (Floor Assembly Only), 2000+ Silicone, or CP 25 WB+

FILL, VOID OR CAVITY MATERIAL:

Install minimum 5/8-inch depth of fill material into the recess over the entire surface of the packing material (Item 7A). Screenshot the fill material flush with the surface of the supporting construction (Item 8). Overlap a minimum of 1/4 inches, the fill material onto face of supporting construction (Item 8).

This material was extracted and drawn by 3M Fire Protection Products from the 2012 Product Directory, © Intertek

Design Number 3MU/FRD 120-19

October 29, 2012

FIRE RESISTANT GREASE DUCT

3M Company

3M Fire Barrier™ Duct Wrap 615+

ASTM E 2336-04 (2009) and

ICC-ES Acceptance Criteria for Grease Duct Enclosure Systems (AC101)

Noncombustibility Test (ASTM E 136) – Pass

Fire Resistance Test (ASTM E 119) – 2 hr

Durability Test (ASTM C 518 modified) – Pass

Internal Fire Test – 4 hr @ 500°F and 30 minutes @ 2000°F – Pass

Fire-Engulfment Test (ASTM E 119 Exposure) – 2 hr

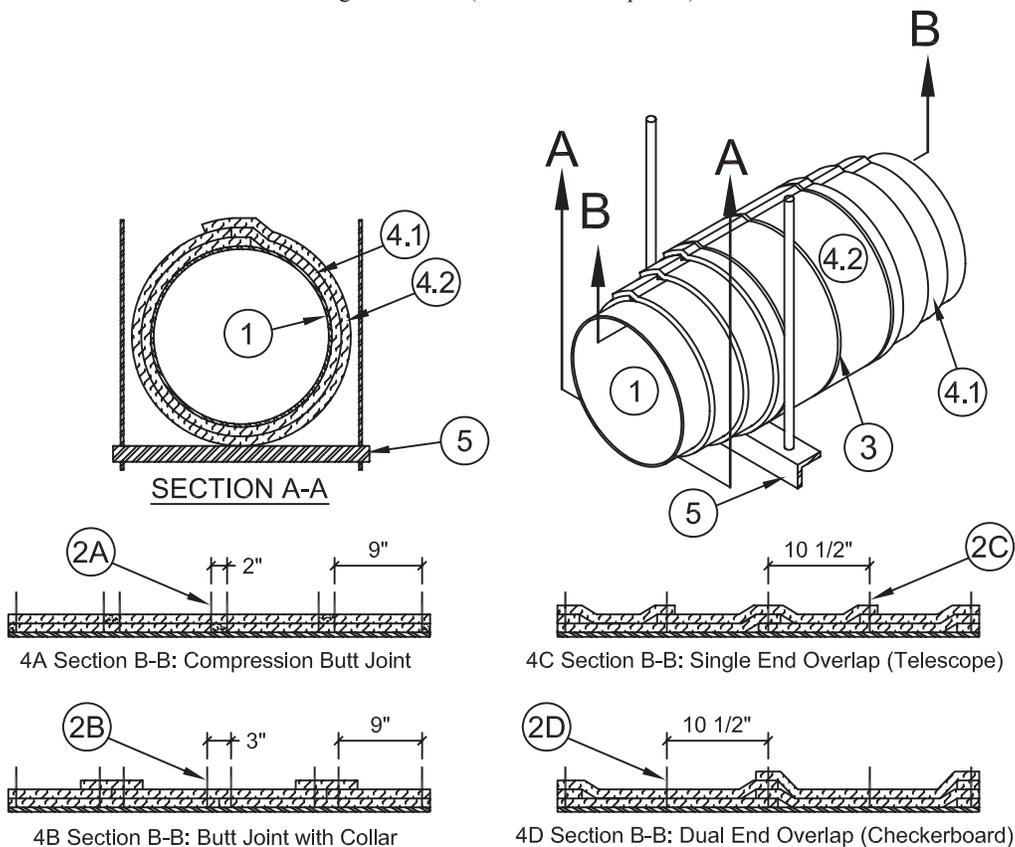

Figure 1

- GREASE DUCT: Use a continuously-welded, liquid-tight, L-shaped, circular duct system with horizontal and vertical shafts constructed of 16 GA sheet steel with a maximum 1809 inch² area and a maximum 48-inch diameter. When required, equip the duct with a pre-fabricated access door (Item 6) or field-fabricated access door (Item 7).
 - Construct the grease duct using sections affixed to each other with welded joints.
 - Reinforce the grease duct to IMC or NFPA 96 requirements designed to carry the weight of the grease duct assembly covered with two layers of insulation (Item 4) under a fire load equivalent to the ASTM E 2336 exposure and the ASTM E 119 time-temperature curve.
 - Rigidly support the grease duct (Item 1) as specified in Item 5 or in accordance with IMC or NFPA 96 requirements when those requirements are greater.
 - Protect the annular space around the grease duct (Item 1) passing through a fire-rated wall assembly with an Intertek-certified, compatible, 3M, penetration firestop system, refer to section 10, having the same fire rating as the assembly.
- FASTENERS: Refer to Figure 1. Weld minimum 12 GA, 6-1/2-inch long, copper-coated, steel insulation pins or 12 GA, insulated cup head steel pins to the grease duct (Item 1). Match the following fastener method with corresponding insulation (Item 4) method.
 - Compression Butt Joint: Refer to 4A Section View B-B. Locate pins at all blanket overlaps, on all sides of the grease duct (Item 1), and meet the following requirements.
 - Space pins maximum 12 inches apart in rows across the width of grease duct (Item 1). Locate pins maximum 6-3/4 inches from the edges of the grease duct (Item 1). Refer to section view A-A.
 - Space the rows of pins as follows: use pattern nominal 9 inches apart, then maximum 2 inches apart, then nominal 9 inches apart along the length of the grease duct (Item 1). Refer to Item 4A section view B-B.
 - After insulation (Item 4A) is installed, place minimum 2-1/2 x 2-1/2-inch square, galvanized steel, self locking washer clips onto all insulation pins.
 - After clips are installed, cut off or bend flush with insulation (Item 4A) the pins that are too long.

¹ ACCEPTANCE CRITERIA FOR GREASE DUCT ENCLOSURE ASSEMBLIES, AC101, Approved April 2001 (Editorially revised October 2004) states, "The system may be installed with zero clearance from the insulating materials to combustibles."

DESIGN NO. 3MU/FRD 120-19 *continued*

Flexible Wraps

- B. Butt Joint with Collar: Refer to 4B Section View B-B. Locate pins at all blanket overlaps, on all sides of the grease duct (Item 1), and meet the following requirements.
- Space pins maximum 12 inches apart in rows across the width of grease duct (Item 1). Locate pins maximum 6-3/4 inches from the edges of the grease duct (Item 1). Refer to section view A-A.
 - Space the rows of pins as follows: use pattern nominal 9 inches apart, then maximum 3 inches apart, then nominal 9 inches apart along the length of the grease duct (Item 1). Refer to Item 4B section view B-B.
 - After insulation (Item 4B) is installed, place minimum 2-1/2 x 2-1/2-inch square, galvanized steel, self-locking washer clips onto all insulation pins.
 - After clips are installed, cut off or bend flush with insulation (Item 4B) the pins that are too long.

Duct Wrap

- C. Single End Overlap (Telescope): Refer to 4C Section View B-B. Locate pins at all blanket overlaps, on all sides of the grease duct (Item 1), and meet the following requirements.
- Space pins maximum 12 inches apart in rows across the width of grease duct (Item 1). Locate pins maximum 6-3/4 inches from the edges of the grease duct (Item 1). Refer to section view A-A.
 - Space the rows of pins maximum 10-1/2 inches apart along the length grease duct (Item 1). Where pieces of insulation (Item 4C) are butted together, space pins a maximum 1-1/2 inches from the edge of the insulation. Refer to Item 4C section view B-B.
 - After insulation (Item 4C) is installed, place minimum 2-1/2 x 2-1/2-inch square, galvanized steel, self-locking washer clips onto all insulation pins.
 - After clips are installed, cut off or bend flush with insulation (Item 4C) the pins that are too long.

- D. Dual End Overlap (Checkerboard): Refer to 4D Section View B-B. Locate pins at all blanket overlaps, on all sides of the grease duct (Item 1), and meet the following requirements.
- Space pins maximum 12 inches apart in rows across the width of grease duct (Item 1). Locate pins maximum 6-3/4 inches from the edges of the grease duct (Item 1). Refer to section view A-A.
 - Space the rows of pins maximum 10-1/2 inches apart along the length grease duct (Item 1). Where pieces of insulation (Item 4D) are butted together, space pins a maximum 1-1/2 inches from the edge of the insulation. Refer to Item 4D section view B-B.
 - After insulation (Item 4D) is installed, place minimum 2-1/2 x 2-1/2-inch square, galvanized steel, self-locking washer clips onto all insulation pins.
 - After clips are installed, cut off or bend flush with insulation (Item 4D) pins that are too long.

3. BANDING: Do not use banding for the installation of insulation method (Item 4A), Compression Butt Joint. Banding is an option to fastener methods (Items 2B, 2C and 2D) but not fastener method (Item 2A). After insulation (Item 4) is installed, apply minimum 1/2 inch wide, 0.015-inch thick stainless steel bands or minimum 1/2 inch wide, 0.020-inch thick carbon steel bands and secured with minimum 1-inch long stainless or carbon steel crimp clamps to be used with corresponding banding type. When needed to ease installation, use filament tape as a temporary hold for the insulation (Item 4) prior to banding. Place banding a maximum 1-1/2 inches from all insulation (Item 4) edges and a maximum of 10-1/2 inches on center (O.C.). Tension the banding to hold the insulation (Item 4) in place without cutting or damaging the insulation (Item 4) or grease duct (Item 1).

4. CERTIFIED MANUFACTURER: 3M Company

CERTIFIED PRODUCT: 3M Fire Barrier™ Duct Wrap

MODEL: 615+

INSULATION: Apply the non-combustible (ASTM E136) and durable (ASTM C518) insulation in two layers of nominal 1-1/2-inches thick, 6-pcf density blanket, made of calcium-, silica-, and magnesium-oxide (CSM) fibers, encapsulated with polypropylene-foil or aluminized polyester-foil scrim over the entire surface of the grease duct (Item 1). Apply the inner first layer (Figure 1, 4.1) in accord with one of the four methods (A, B, C, or D) that follow. Offset the second outer layer (Figure 1, 4.2) one half the width of the inner first layer (Figure 1, 4.1) so that the joints of the inner first layer (Figure 1, 4.1) are covered by and approximately in the center of the second outer layer (Figure 1, 4.2). Apply the second outer layer (Figure 1, 4.2) in accord with the same method selected for the first inner layer (Figure 1, 4.1). Use blanket, available in various widths, that is fully encapsulated or single faced with a polypropylene-foil or polyester-foil scrim. Expose a foil-faced side of insulation to view. Wrap one layer of insulation around the grease duct (Item 1) perimeter so that each terminating end of insulation overlaps onto the starting end of insulation a minimum of 3 inches at all transverse joints. Stagger the transverse overlap location so that no two consecutive adjacent overlaps align. Refer to section view A-A for transverse overlap section view. Cover all visually-exposed ends and edges of insulation with nominal 4-inch wide, pressure-sensitive, aluminum foil tape.

- A. Compression Butt Joint: Refer to Item 4A section view B-B. Wrap the grease duct (Item 1) with two layers of insulation installed with compression butt joints at all circumferential joints. Apply the first layer, center pieces of insulation (Item 4A) over 2-inch-wide pin bay, so that each piece nominal 24-inch-wide blanket occupies two (2) full 9-inch-wide bays and three (3) full 2-inch-wide bays. Compress each edge of each piece of insulation together and butt to preceding edge of insulation in 2-inch-wide bays. After installation, each piece of installed insulation width is 2 inches less than insulation nominal width. (Example: each piece of nominal 24-inch-wide insulation when installed is 22 inches wide.) Verify all insulation butt joints are compressed minimum 50% at compression butt joints. Offset the second layer of insulation so that the compression butt joint of the first layer of insulation is centered under the second layer of insulation and install in same manner as first layer of insulation.

- B. Butt Joint with Collar: Refer to Item 4B section view B-B. Wrap the grease duct (Item 1) with two layers of insulation installed with butt joints at all circumferential joints. Apply the first layer, center pieces of insulation (Item 4A) over 3 inch wide pin bay, so that each piece nominal 24-inch-wide blanket occupies two (2) full 9-inch-wide bays and one (1) full 3-inch-wide bays and half of two (2) 3-inch-wide bays at each circumferential edge. Butt each end of each piece of insulation together with preceding edge of insulation. Each piece of installed insulation width is its nominal width. (Example: each piece of nominal 24-inch-wide insulation when installed is 24 inches wide.) Offset the second layer of insulation so that the butt joint of the first layer of insulation is centered under the second layer of insulation and install in same manner as first layer of insulation. Place and center 6-inch-wide collar of insulation over the butt joint. Overlap 6-inch-wide collar onto each adjacent insulation 3 inches. Verify all insulation butt joints with collars are three layers of insulation in overall thickness.

Grease Duct

FRD

DESIGN NO. 3MU/FRD 120-19 *continued*

- C. Single End Overlap (Telescope): Refer to Item 4C section view B-B. Wrap the grease duct (Item 1) with two layers of insulation installed with 3-inch minimum overlaps at all longitudinal joints. Overlap each adjacent insulation edge with the edge of the next piece of insulation. Verify all insulation overlaps are three layers of insulation in overall thickness.
- Starting at one end of the grease duct (Item 1), apply the first piece of insulation around the grease duct (Item 1) to overlap fasteners (Item 2C). Refer section view A-A.
 - Position and overlap the leading edge of the second piece of insulation nominally 3 inches over the flush edge of the first piece of insulation. Place the opposite edge of the second piece of insulation flush against the surface of the grease duct (Item 1). An “S-shaped” cross section of the insulation is created. Refer to Item 4C section view B-B.
 - Apply all additional pieces of insulation as “S-shaped” cross section of the insulation in compliance with Item 4Cii.
 - Position the second layer of insulation so that the joint of the first layer of insulation is centered under the second layer of insulation and install in same manner as first layer of insulation.
- D. Dual End Overlap (Checkerboard): Refer to Item 4D section view B-B. Verify all insulation overlaps are a minimum 3 inches in overall thickness. Do not align two consecutive insulation end overlaps. Overlap each full width insulation edge with the edge of the “gull wing” (v) shaped piece of insulation. Install insulation with zero clearance at the overlaps, or in the field between overlaps. Verify all insulation overlaps are four layers of insulation in overall thickness.
- Wrap the first piece of insulation around the grease duct (Item 1) so that the insulation is flush against the surface of the grease duct (Item 1). Position the starting end of the insulation to overlap pins (Item 2A) a minimum of 1-1/2 inches while the edges of the insulation overlap the rows of pins (Item 2B) a minimum of 1-1/2 inches.
 - Position the second piece of insulation nominally 18 inches from the edge of the first piece of insulation. Install the second piece in the same manner as the first.
 - Cover the grease duct (Item 1) that is exposed between the edges of the first two pieces of insulation with another piece of insulation. Position the starting end of the insulation to overlap pins (Item 2A) a minimum of 1-1/2 inches while the edges of the insulation overlap the adjacent edges of the two pieces installed insulation a minimum of 1-1/2 inches.
 - Position the second layer of insulation so that the first layer of insulation is centered under the second layer of insulation and install in same manner as first layer of insulation.
5. SUPPORTS: When the grease duct (Item 1) is 24-inches in diameter or smaller, support the grease duct (Item 1) with insulation (Item 4) using a un-insulated “trapeze” system composed of a minimum 2 x 2 x 1/8-inch steel angle as the trapeze cross-member and two (2), minimum 3/8-inch diameter, all-thread, steel rods connected using nuts and washers. For grease ducts (Item 1) larger than 24-inches in diameter, support the grease duct (Item 1) with insulation (Item 4) using a un-insulated “trapeze” system composed of a minimum 2 x 2 x 1/4-inch steel angle as the trapeze cross-member and two (2), minimum 1/2-inch diameter, all-thread, steel rods connected using nuts and washers. Connect the all-thread steel rods to the bottom of the floor assembly using an attachment method designed to carry the weight of the grease duct (Item 1) with insulation (Item 4) under a fire load equivalent to ASTM E 119 time-temperature curve. Place one (1) all-thread steel rod at each end of trapeze cross-member. Center grease duct (Item 1) with insulation (Item 4) on trapeze cross-member. Space all-thread steel rods a maximum 6 inches from surface of the insulated grease duct or allowing all-thread steel rods to contact with the insulation (Item 4) at the minimum distance. Extend trapeze cross-member at least 2 inches past each all-thread, steel rod. Space trapeze supports a maximum 60 inches on center.
6. CERTIFIED MANUFACTURER: Ductmate Industries, Inc.
CERTIFIED PRODUCT: Grease Duct Access Door
MODELS: Ductmate ULtimate Door™
- DR106†UL (Door for 10x6 opening),
 - DR128†UL (Door for 12x8 opening), and
 - DR1814†UL (Door for 18x14 opening)
- † *Insert duct diameter. (All doors are available for duct diameters of 12” and larger in 2” increments.)*
- ACCESS DOOR ASSEMBLY: When required, apply an access door and insulated cover plate as described:
- A. OPTIONAL PRE-FABRICATED ACCESS DOOR: Mark a clean-out access opening location on the grease duct (Item 1) with insulation (Item 4) at its mid-height along the horizontal section. Cut an opening (maximum 22 x 22 inches) in the insulation (Item 4) the same size as the outside dimension of the desired pre-fabricated access door model. Remove and discard the cut insulation (Item 4). Cut an opening (maximum 20 x 20 inches) into the side of the grease duct (Item 1) according to the manufacturer’s instructions for the size of the pre-fabricated access door to be installed. Install and tightly secure the pre-fabricated access door in accordance with the manufacturer’s instructions to the grease duct (Item 1). Fit pre-fabricated access door with four (4), 3/8-inch diameter, corner-thumb bolts through the exterior face.
- B. CERTIFIED MANUFACTURER: 3M Company
CERTIFIED PRODUCT: 3M Fire Barrier™ Duct Wrap
MODEL: 615+

Note: Section view not curved for clarity.

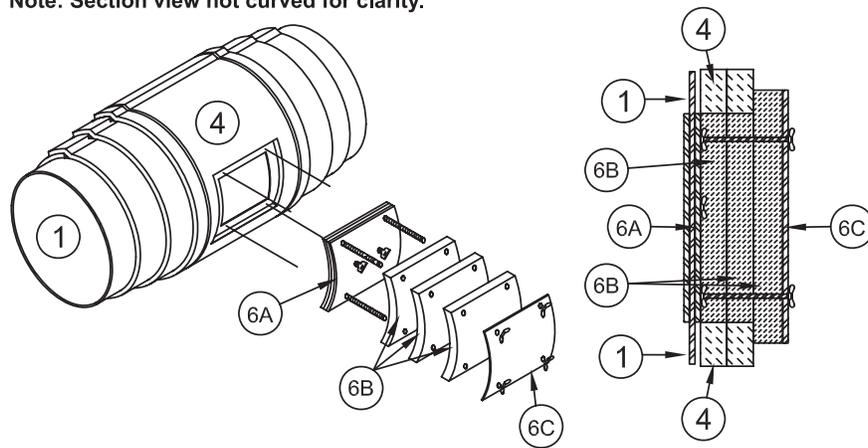

Figure 2 –Ductmate Pre-fabricated Access Door

ACCESS INSULATION: Remove the four (4), 3/8-inch diameter, corner-thumb bolts and replace them with four (4), 3/8-inch diameter, all-thread, steel rods extending from pre-fabricated access door (Item 6A). Apply three (3) layers of access insulation over the pre-fabricated access door (Item 6A) as follows. Cut the first piece of rectangular access insulation a minimum 1/4 inch larger than the clean-out access opening. Position, square, and impale the first piece of the access insulation over the four (4), 3/8-inch diameter, all-thread, steel rods extending from pre-fabricated access door (Item 6A). Press the first piece of access insulation flush over the pre-fabricated access door (Item 6A). Compress and abut the cut edges of the first piece of the access insulation against the cut edges of opening in the insulation (Item 4). Cut a second piece of access insulation the same size as the first piece of access insulation. Press the second piece of access insulation flush over the first piece of access insulation. Compress and abut the cut edges of the first piece of the access insulation against the cut edges of opening in the insulation (Item 4). Cut a third piece of rectangular access insulation a minimum of 2 inches larger than the second piece of access insulation on all sides. Seal cut edges of the third piece of access insulation with nominal 4-inch-wide aluminum foil tape. Position, square, and impale the third piece of the access insulation over the four (4), 3/8-inch diameter, all-thread, steel rods extending from pre-fabricated access door (Item 6A). Press the third piece of access insulation flush over second piece of access insulation.

C. COVER PLATE: Cut a cover plate to the same dimensions as the third piece of access insulation (Item 6B) using a minimum 16 GA steel sheet. Drill holes in the cover plate that match the location of the four (4), 3/8-inch diameter, all-thread, steel rods and locate the holes so that the cover plate is squared to the third piece of access insulation (Item 6B). After all three (3) layers of access insulation (Item 6B) are impaled over the four (4), 3/8-inch diameter, all-thread, steel rods install the cover plate. Pass the four (4), 3/8-inch diameter, all-thread, steel rods through the cover plate. Place washers and wing nuts onto each of the four (4), 3/8-inch diameter, all-thread, steel rods. Secure the cover plate by tightening wing nuts.

Note: Section view not curved for clarity.

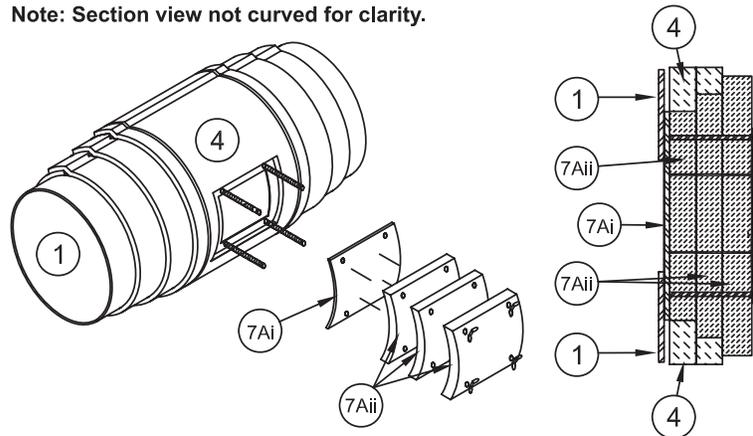

Figure 3 – Field Fabricated Access Door Option A

6. OPTIONAL FIELD-FABRICATED ACCESS DOORS: Mark a clean-out access opening location on the grease duct (Item 1) with insulation (Item 4) at its mid-height along the horizontal section. Use either Option A or B.
 - A. (OPTION A) Cut a 12x12-inch opening in the insulation (Item 4). Remove and discard the cut insulation (Item 4). Cut and center a 10x10-inch opening into the side of the grease duct (Item 1) by maintaining a 1-inch clearance between the perimeter of the opening and the cut insulation (Item 4). Remove and discard the cut steel. Weld four (4), minimum 4-inch long, 1/4-inch diameter, all-thread, steel rods to the grease duct (Item 1). Locate one (1) steel rod at each corner of the grease duct (Item 1) opening so that they are 11 inches on center and squared within the insulation (Item 4) opening.
 - i. ACCESS DOOR: Cut a 12x12-inch, 16 GA, steel plate to be used as an access door. Drill clearance holes in the access door to match the all-thread, steel rod pattern. Place the access door over the all-thread, steel rods. Seal the opening in the grease duct (Item 1) by overlapping the access door over the opening cut in the insulation (Item 4) by 1 inch on all sides. Weld four (4), minimum 6-1/2-inch long, 12 GA, copper-coated, steel insulation pins to the access door corners so that the insulation pins are 9 inches on center.

- ii. CERTIFIED MANUFACTURER: 3M Company
 CERTIFIED PRODUCT: 3M Fire Barrier™ Duct Wrap
 MODEL: 615+

ACCESS INSULATION: Apply three (3) layers of access insulation over the access door. Cut the first piece of access insulation into a 12x12-inch square and install it over the insulation pins and cover the access door (Item 7Ai). Cut the second piece of access insulation into a 14x14-inch square. Square it and install it over the insulation pins. Cover the first piece of access insulation so that a 1-inch overlap exists. Cut the third piece of access insulation into a 16x16-inch square. Square it and install it over the insulation pins. Cover the second piece of access insulation so that a 1-inch overlap exists. Secure access insulation to the insulation pins with 1-1/2-inch square or round, galvanized or stainless steel, speed clips. Turn down or cut off insulation pins that extend beyond the second piece of access insulation. Place maximum 4-inch long, steel tubing over each all-thread, steel rods. Apply washers and wing nuts over the all-thread, steel rods. Secure the access door by tightening the wing nuts.

- B. (OPTION B) Cut a maximum 16x16-inch opening into the insulation (Item 4) and the grease duct (Item 1). Remove and discard the cut insulation (Item 4) and steel. Weld together four (4) pieces of 1-1/2 x 1-1/4 x 1/8-inch steel angle, with the flange outward, to form a 1-1/2-inch tall, flanged frame. Position, center, and continuously weld the flanged frame around the opening in the grease duct (Item 1). Position one (1), minimum 4-inch long, 1/4-inch diameter, all-thread, steel rod in the center of each of the four (4) corners of the flange and weld them in place.
 - i. ACCESS DOOR: Cut an 18-1/2 x 18-1/2-inch, 16 GA, steel plate to be used as an access door. Drill clearance holes in the access door to match the all-thread, steel rod pattern on the flange. Place the access door over the all-thread, steel rods.
 - ii. COVER PLATE: Cut a 20-1/2 x 20-1/2-inch external cover plate out of 16 GA steel sheet and drill clearance holes matching the locations of the all-thread, steel rods on the flange. Weld minimum four (4), 12 GA, copper-coated, steel insulation pins onto the internal surface of the cover plate, spaced minimum 14 inches on center. Limit insulation pin length to one-half total access insulation thickness. Install access insulation (Item 7Biii). Position the cover plate with access insulation over the all-thread, steel rods flush to access door. Apply washers and wing nuts over the all-thread, steel rods. Secure the access door by tightening the wing nuts.

Note: Section view not curved for clarity.

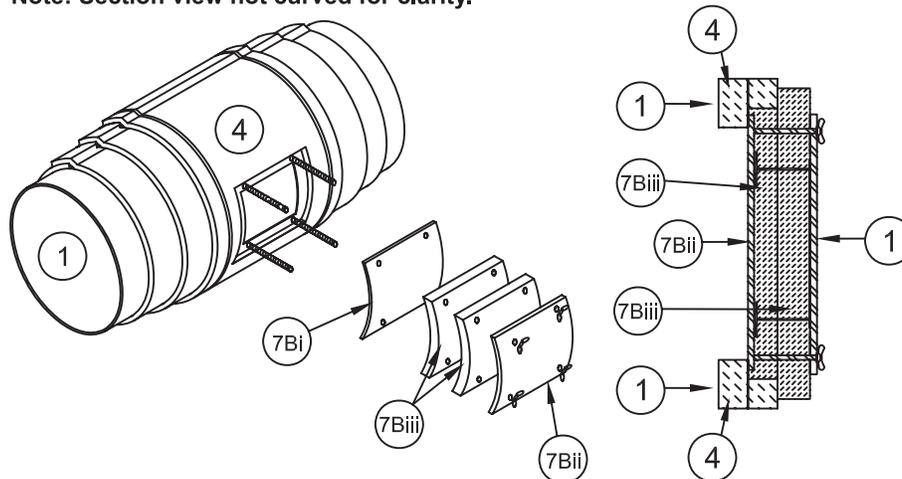

Figure 4 – Field Fabricated Access Door Option B

- iii. CERTIFIED MANUFACTURER: 3M Company
 CERTIFIED PRODUCT: 3M Fire Barrier™ Duct Wrap
 MODEL: 615+

ACCESS INSULATION: Apply two layers of access insulation over the interior of the cover plate. Cut the first piece of access insulation into a 20-1/2 x 20-1/2-inch square and install it over the insulation pins on the internal surface of the cover plate. Cut the second piece of access insulation into a 24 x 24-inch square. Square it to and install it over the insulation pins. Cover the first piece of access insulation so that a 1-3/4-inch overlap exists. Secure access insulation to insulation pins with 1-1/2-inch square or round, galvanized or stainless steel speed clips. Turn down or cut off insulation pins that extend beyond the second piece of access insulation.

- 7. NONCOMBUSTIBLE² SUPPORTING CONSTRUCTION: Refer to Figures 3 and 4. Use one of the following wall or floor assemblies.
 - A. GYPSUM WALL ASSEMBLY: Symmetrical two-hour rated gypsum wall assembly constructed of the following:
 - i. Steel Studs – Minimum 25 GA galvanized steel studs measuring 3-5/8 inch wide with 1-1/4-inch legs spaced maximum 24 inch on center (O.C.). Attach studs with minimum #6 x 3/8-inch steel stud framing screws to floor and ceiling tracks.

² Refers to building construction referenced in the building codes.

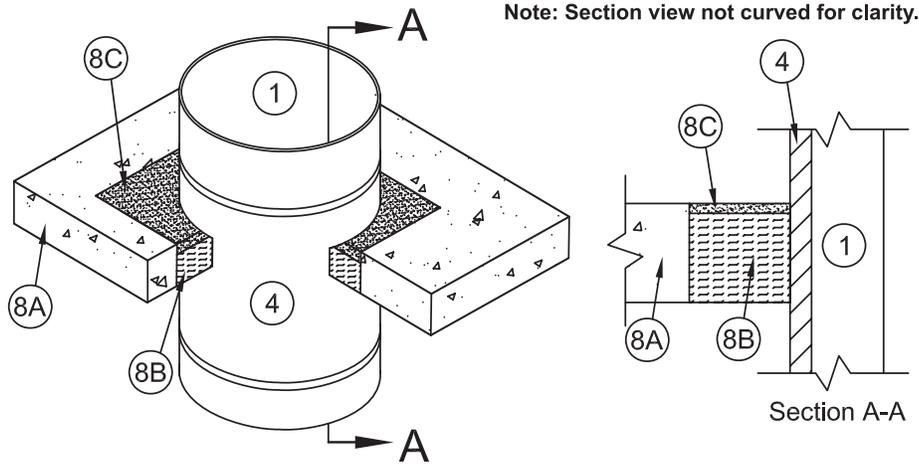
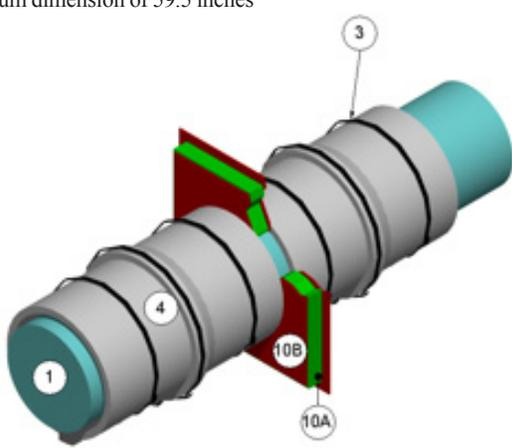

Figure 5 – Noncombustible Supporting Constructions

- ii. Tracks – Channel U-shaped floor and ceiling runners measuring 1/2-inch deep by 3-5/8-inch wide, which are secured to floor and ceiling with 1-inch long fasteners suitable for the mounting to substrate and spaced maximum 18-inch O.C.
 - iii. Gypsum Board – Cover studs and runners with two layers of 5/8 inch thick, Type X gypsum board on each face. Fasten base layer of gypsum board to steel studs with #6 1-1/8 inch bugle head phillips drywall screws spaced maximum 12 inch O.C. Fasten face layer of gypsum board with #6, 1-5/8 inch long bugle phillips drywall screws spaced maximum 8 inches O.C. Apply vinyl or casein, dry or premixed joint compound to face layers of gypsum board in two coats to all exposed screw heads and gypsum board joints. Embed minimum 2 inch wide paper, plastic or fiberglass tape in first layer of joint compound over joints in gypsum board. Minimum wall assembly thickness of 6 inches measured from face layer of gypsum board to opposite face layer of gypsum board.
- B. SHAFT WALL ASSEMBLY:**
- Asymmetrical two-hour rated gypsum shaft wall assembly constructed of the following:
- i. Visual Gypsum Board – Cover studs and runners with two layers of minimum 1/2 inch thick, Type X gypsum board on each face. Fasten base layer of gypsum board to steel studs with #6 1-1/8 inch bugle head phillips drywall screws spaced maximum 12 inch O.C. Fasten face layer of gypsum board with #6, 1-5/8 inch long bugle phillips drywall screws spaced maximum 8 inches O.C. Apply vinyl or casein, dry or premixed joint compound to face layers of gypsum board in two coats to all exposed screw heads and gypsum board joints. Embed minimum 2 inch wide paper, plastic or fiberglass tape in first layer of joint compound over joints in gypsum board. Minimum wall assembly thickness of 4-1/2 inches measured from face layer of gypsum board to opposite face layer of gypsum board.
 - ii. Interior Gypsum Board – Cut 1-inch thick Type X gypsum board 1-inch less than floor to ceiling height. Insert the longitudinal edges of the 1-inch thick Type X gypsum board into the C-T or C-H studs. Secure the transverse edge of the 1-inch thick Type X gypsum board to the long leg of J-runner using its tabs or minimum 1-5/8-inch long Type S self-tapping bugle head steel screws spaced maximum 12 inches on center.
 - iii. Steel Studs – Cut minimum 25 GA galvanized steel C-T or C-H studs measuring minimum 2-1/2 inches wide with minimum 1-1/2-inch flanges 3/4-inches less than floor to ceiling height and spaced maximum 24 inch on center (O.C.) in runners with T or H section abutting long leg of runner.
 - iv. Runners – Use minimum 2-1/2- inch wide J-runner compatible with studs and having unequal vertical legs: minimum 1-inch short leg and minimum 2-inch long leg. Position J-runners with short leg towards visual face of shaft wall. Attach to floor and ceiling using steel fasteners located a maximum of 2-inches from each end and a maximum of 24 inch O.C.
- C. CONCRETE WALL ASSEMBLY:** Symmetrical, two-hour rated, solid concrete, wall assembly made from reinforced lightweight or normal weight (100-150 pcf or 1600-2400 kg/m³) concrete, which may also be used as a shaft wall assembly. Constructed of solid concrete with a minimum concrete thickness measured from exposed face to exposed face using one of the following:
- i. lightweight concrete is 3.6 inches;
 - ii. sand-lightweight concrete is 3.8 inches;
 - iii. carbonate aggregate concrete is 4.6 inches; and
 - iv. siliceous aggregate concrete is 5.0 inches.
- D. MASONRY WALL ASSEMBLY:** Symmetrical, two-hour rated, nominal 8 x 8 x 16 CMU, wall assembly made from lightweight or normal weight (100-150 pcf or 1600-2400 kg/m³) concrete, which may also be used as a shaft wall assembly.
- E. CONCRETE FLOOR ASSEMBLY:** Symmetrical two-hour rated solid concrete floor assembly made from reinforced lightweight or normal weight (100-150 pcf or 1600-2400 kg/m³) concrete. Constructed of solid concrete with a minimum concrete thickness measured from exposed face to exposed face using one of the following:
- i. lightweight concrete is 3.6 inches;
 - ii. sand-lightweight concrete is 3.8 inches;
 - iii. carbonate aggregate concrete is 4.6 inches; and
 - iv. siliceous aggregate concrete is 5.0 inches

DESIGN NO. 3MU/FRD 120-19 *continued*

8. OPENING – Create an opening in the assembly. Position the grease duct (Item 1) concentrically or eccentrically in the opening so that the annular space ranges from minimum 0.5 inch to maximum 4-1/2 inches. Establish an opening designed to house the grease duct (Item 1) covered with insulation (Item 4) and the desired annular space but not exceeding a cross-sectional area of maximum 3136 inch² and a maximum dimension of 59.5 inches



Symmetrical Firestops for Horizontal Grease Ducts without Insulation Through Noncombustible Wall Assemblies

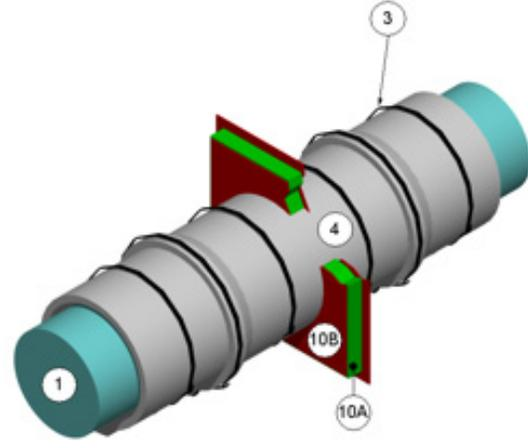

Symmetrical Firestops for Horizontal Grease Ducts with Insulation Through Noncombustible Wall Assemblies

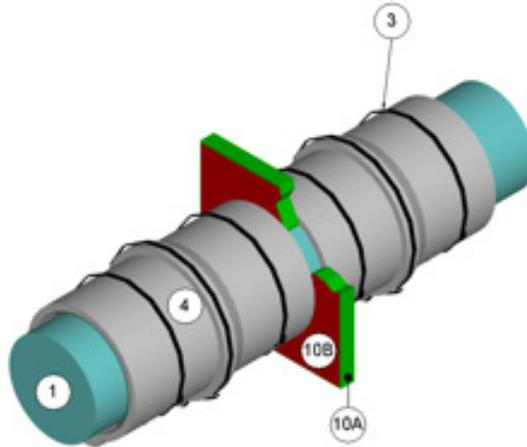

Asymmetrical Firestops for Horizontal Grease Ducts without Insulation Through Noncombustible Shaft Assemblies

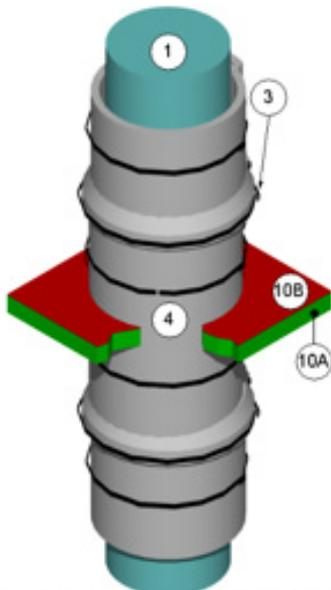

Asymmetrical Firestops for Vertical Grease Ducts with Insulation Through Noncombustible Floor Assemblies

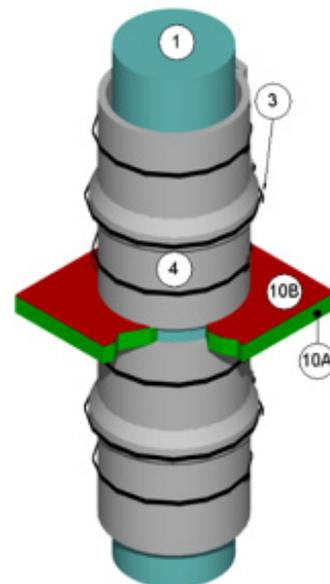

Asymmetrical Firestops for Vertical Grease Ducts Through Noncombustible Floor Assemblies

DESIGN NO. 3MU/FRD 120-19 *continued*

Figure 6 – Penetration Firestops for Noncombustible Supporting Constructions

9. PENETRATION FIRESTOP: Install two-hour, fire-resistant, ASTM E 814, firestop system. Install firestop between the supporting construction (Item 6) and the grease duct (Item 1) or the grease duct (Item 1) protected with the insulation (Item 4). Use a symmetrical wall penetration firestop, an asymmetrical shaft penetration firestop or an asymmetrical floor penetration firestop constructed of the following components.
- A. CERTIFIED MANUFACTURER: 3M Company
CERTIFIED PRODUCT: 3M Fire Barrier™ Duct Wrap
MODEL: 615+
PACKING MATERIAL: Fill the entire annular space's width with minimum 4-pcf density mineral wool or certified insulation without the encapsulation (foil scrim).
Cut the packing material into strips not less than one and one half (1-1/2) times the width of the annular space to be filled. Compress packing material nominally 33% and insert packing material into the annular space.
For wall assemblies, recess the surface of packing material nominally 5/8 inches from surfaces of both faces of the supporting construction (Item 8).
For floor assemblies, recess the surface of packing material nominally 5/8 inches from the visual surface of the supporting construction (Items 8) and install a minimum depth of 4-inches.
- B. CERTIFIED MANUFACTURER: 3M Company
CERTIFIED PRODUCT: 3M™ Fire Barrier™ Sealant
MODEL: Water-Tight 1000-NS Silicone, 1003-SL Silicone (Floor Assembly Only), 2000+ Silicone, or CP25 WB+
FILL, VOID OR CAVITY MATERIAL:
Install minimum 5/8-inch depth of fill material into the recess over the entire surface of the packing material (Item 7A). Screed the fill material flush with the surface of the supporting construction (Item 8). Overlap a minimum of 1/4 inches, the fill material onto face of supporting construction (Item 8).

This material was extracted and drawn by 3M Fire Protection Products from the 2012 Product Directory, © Intertek

Flexible Wraps

Duct Wrap

Grease Duct

FRD

Design No. FRD-19

March 12, 2010

| | Duct A | Duct B |
|------------------------|-----------------------|--------|
| Fire-resistance rating | 1 or 2 h (See item 1) | – |

(Ratings applicable for Ventilation Ducts installed with or without branches)

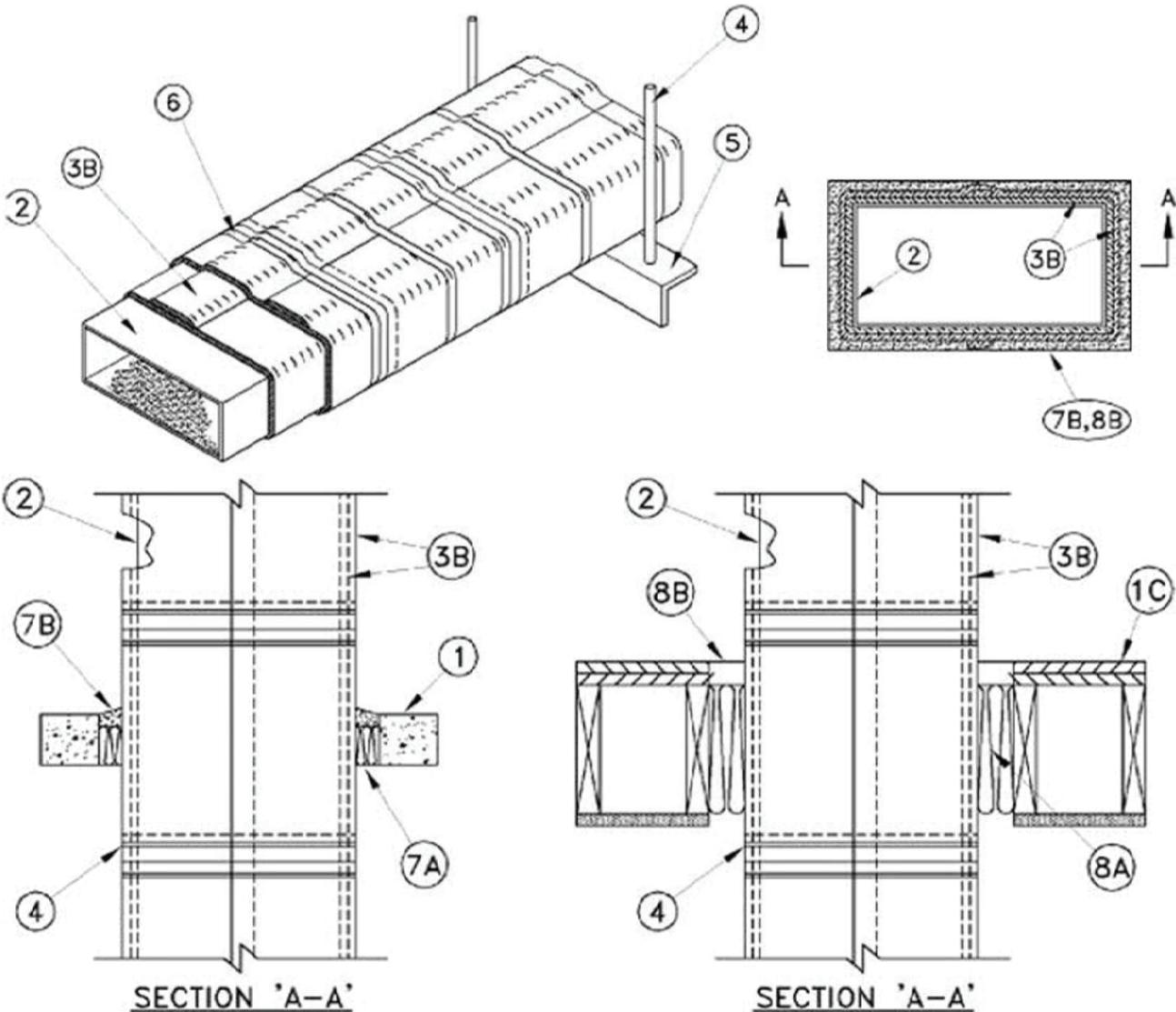

Maximum Size of Duct – 0.93m² maximum area with no dimension exceeding 1219 mm.

Support Spacing – 1525 mm maximum.

Duct Use Limitation – Duct is intended for use in exhaust systems serving commercial and institutional kitchen cooking appliances. **Duct system, when constructed of the materials and in the manner described below, also meets the intent of NFPA 96, Standard for Ventilation Control and Fire Protection of Commercial Cooking Operations. Clearance to combustible materials - 0 mm.**

1. Fire Separation –

- (a) **Masonry Wall or Floor** – Minimum depth or thickness as necessary for the grade of fire separation but not less than 115 mm. Normal-density or low-density concrete wall can also be constructed of nominal 190 mm thick concrete block laid up with mortar.

OR

- (b) **Wall Assembly** – The fire-rated gypsum wallboard and steel or wood stud assembly shall be constructed of the materials and in the manner described in the individual Wall or Partition design in the ULC Fire Resistance directory.

OR

- (c) **Floor/Ceiling Assembly** – The fire-rated combustible floor/ceiling assembly shall be constructed of the materials and in the manner described in the individual Floor-Ceiling design in the ULC Fire Resistance directory.

The Fire Resistance Rating of a wrapped duct penetrating a combustible floor/ceiling assembly is limited to the fire resistance rating of the combustible floor/ceiling assembly.

- 2. Grease Duct** – Duct to be constructed in accordance with the requirements of the Standard for Ventilation Control and Fire Protection of Commercial Cooking Operations, NFPA 96. Minimum thickness of steel permitted, 1.6 mm thick carbon steel or 1.2 mm thick stainless steel; maximum size of duct 1219 mm by 762 mm nominal.

Design No. FRD-19 *continued*

Flexible Wraps

- 3. **Grease Duct Insulation** – (YYETC) – See ULC Heating and Ventilating Equipment and Flammable Liquids and Gases Equipment Directory. Two layers of 38 mm thick, Calcium-Magnesium-Silicate (CMS) duct wrap, installed in accordance with the manufacturer's installation instructions including the following features:
 - (a) Copper-coated steel insulation pins (not shown), inductive weld pins or cup-head weld pins, nominal 3 mm thick, minimum 102 mm long, shall be stud welded to the bottom surface of steel duct on horizontal runs and on the widest surface on vertical runs of the steel duct at 300 mm OC maximum.
 - (b) The base layer of the duct wrap shall be installed around the duct with an overlap of minimum 76 mm. The face layer of duct wrap shall be wrapped around the base layer with overlapping joints staggered minimum 267 mm. All first and second layer joints are to be covered with minimum 76 mm wide aluminum tape.
 - (c) The layers of blanket are locked into place over the insulation pins with 25 mm by 25 mm speed clips (not shown). Banding material (Item 6), 13 mm wide and minimum 0.3 mm thick, shall be installed with a tensioning tool and spaced a maximum 267 mm OC and within 38 mm of edges of perimeter overlapped seams.

3M COMPANY – 3M Fire Barrier Duct Wrap 615

- 4. **Support Rod** – Steel threaded rod, nominal 13 mm minimum diameter, shall be used. For ducts not exceeding a duct perimeter of 2235 mm, steel threaded rod of nominal 10 mm diameter through Cradle (Item 5) and mounted to concrete floor by:
 - (a) Passing through pre-drilled hole and bolting with nut and washer on top of floor, or
 - (b) Carbon steel or stainless steel masonry anchors, nominal 13 mm or 10 mm diameter by 50 mm long, drop-in style anchors embedded a minimum of 50 mm into concrete, or nominal 13 mm or 10 mm diameter stud wedge/expansion type anchors embedded a minimum of 60 mm into concrete.
- 5. **Cradle** – Steel angle, 50 mm by 50 mm by 5 mm or Unistrut® P5500 channel, used to support wrapped duct at 1525 mm OC maximum. Hung from concrete floor with Support Rods (Item 4).

For ducts not exceeding a duct perimeter of 2235 mm, steel angle 38 mm by 38 mm by 4 mm or Unistrut® P2000 channel can be used.

- 6. **Steel Band** – Nominal 13 mm wide, 0.3 mm thick, made of carbon or stainless steel for 1 h rating and stainless steel for 2 h rating, installed on wrapped duct with tensioning tool and spaced at minimum 267 mm OC. Firestop System Installation

The duct shall be installed within the opening such that the annular space between the wrapped duct and the edges of the opening is maximum 82 mm. For installations in gypsum wallboard assemblies, the opening to accommodate the duct shall be framed on all sides using lengths of stud installed between vertical studs and secured to the vertical studs.

For installations in combustible floor/ceiling assemblies the maximum and minimum annular spaces to be 82 and 22 mm respectively. The opening to accommodate the duct to be framed on all sides using lengths of nominal 38 mm by minimum 240 mm solid wood joists.

Firestop System Installation through Non-Combustible Floor or Combustible or Non-Combustible Wall Opening

- 7(a) **Firestop Insulation** – Unfaced scrap duct wrap (Item 3) or ULC labelled mineral wool insulation with minimum 64 kg/m³ density compressed 50% minimum and installed into the opening to a minimum depth of 100 mm. Material to be recessed 6.4 mm from top surface of floor or 16 mm from both surfaces of wall to allow for the installation of sealant (Item 7b).
- 7(b) **Firestop System Component** – (XHJZC) – Sealant applied over insulation (Item 7a) to a minimum depth of 6.4 mm flush with top surface of floor or 16 mm symmetrically to both surfaces of wall.
3M COMPANY – 3M Fire Barrier Sealants CP25 WB+, 1003 SL (for floors only), 1000 NS, IC 15WB+ or 3000 WT

Firestop System Installation Through Combustible Floor/Ceiling Opening

- 8(a). **Firestop Insulation** – (HNNZC) – Unfaced scrap duct wrap (Item 3) or ULC labelled mineral wool insulation with minimum 64 kg/m³ density compressed 50% minimum and installed into the opening to a minimum depth of 240 mm. Material to be recessed from surface of floor to accommodate required thickness of sealant (Item 8b).
- 8(b). **Firestop System Component** – (XHJZC) – Sealant applied over insulation (Item 8a) to a minimum depth of 6.4 mm flush with top surface of floor.
3M COMPANY – 3M Fire Barrier Sealants CP-25WB+, 1003 SL, 1000 NS, IC 15WB+ or 3000 WT.

Reprinted from the ULC Online Directories with permission from Underwriters Laboratories of Canada Inc.
Copyright © 2013 Underwriters Laboratories of Canada Inc.



Duct Wrap

Canada

FRD

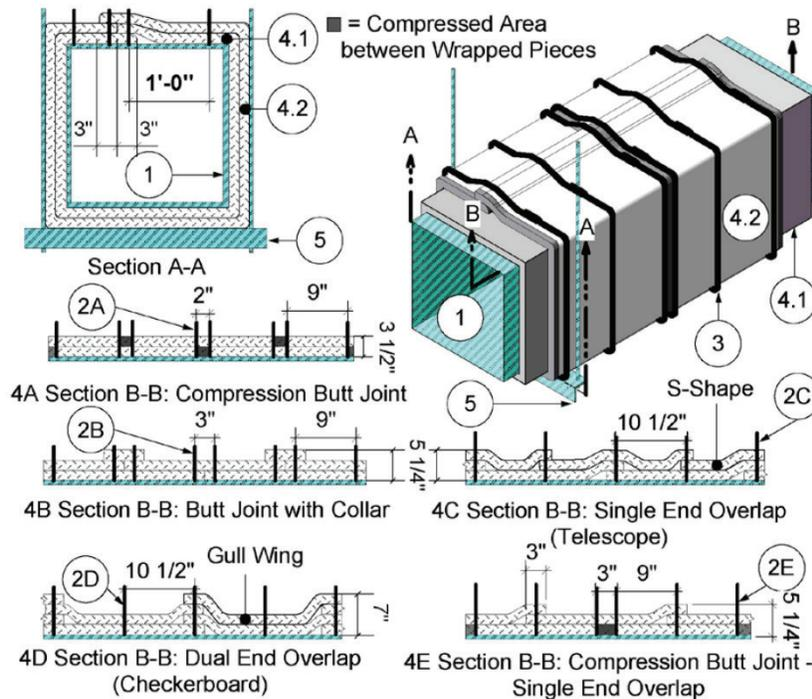

Figure 1

1. **GREASE DUCT:** Use a continuously-welded, liquid-tight, L-shaped, rectangular duct system with horizontal and vertical shafts constructed of 16 GA sheet steel with a max. 2304 in.² area and a max. 48 in. dimension. When required, equip the duct with a pre-fabricated access door (Item 6) or field-fabricated access door (Item 7).
 - A. Construct the grease duct using sections affixed to each other with welded joints.
 - B. Reinforce the grease duct to IMC or NFPA 96 requirements designed to carry the weight of the grease duct assembly covered with two layers of insulation (Item 4) under a fire load equivalent to the ASTM E 2336 exposure and the ASTM E 119 time-temperature curve.
 - C. Rigidly support the grease duct (Item 1) as specified in Item 5 or in accordance with IMC or NFPA 96 requirements when those requirements are greater.
 - D. Protect the annular space around the grease duct (Item 1) passing through a fire-rated assembly with an Intertek- certified, compatible, 3M, penetration firestop system, refer to Section 10, having the same fire rating as the assembly.
2. **FASTENERS:** Refer to Figure 1. Weld min. 12 GA, 6-1/2 in. long, copper-coated, steel insulation pins or 12 GA, insulated cup head steel pins to the grease duct (Item 1). Match the following fastener method with corresponding insulation (Item 4) method.
 - A. **Compression Butt Joint:** Refer to 4A Section View B-B. Locate pins at all blanket overlaps, on all sides of the grease duct (Item 1), and meet the following requirements.
 - i. Space pins max. 12 in. apart in rows across the width of grease duct (Item 1). Locate pins max. 6-3/4 in. from the edges of the grease duct (Item 1). Refer to section view A-A.
 - ii. Space the rows of pins as follows: use pattern nominal 9 in. apart, then max. 2 in. apart, then nominal 9 in. apart along the length of the grease duct (Item 1). Refer to Item 4A section view B-B.
 - iii. After insulation (Item 4A) is installed, place min. 2-1/2 × 2-1/2 in. square, galvanized steel, self locking washer clips onto all insulation pins.
 - iv. After clips are installed, cut off or bend flush with insulation (Item 4A) the pins that are too long.
 - B. **Butt Joint with Collar:** Refer to 4B Section View B-B. Locate pins at all blanket overlaps, on all sides of the grease duct (Item 1), and meet the following requirements.
 - i. Space pins max. 12 in. apart in rows across the width of grease duct (Item 1). Locate pins max. 6-3/4 in. from the edges of the grease duct (Item 1). Refer to section view A-A.

- ii. Space the rows of pins as follows: use pattern nominal 9 in. apart, then max. 3 in. apart, then nominal 9 in. apart along the length of the grease duct (Item 1). Refer to Item 4B section view B-B.
- iii. After insulation (Item 4B) is installed, place min. 2-1/2 × 2-1/2 in. square, galvanized steel, self-locking washer clips onto all insulation pins.
- iv. After clips are installed, cut off or bend flush with insulation (Item 4B) the pins that are too long.

C. Single End Overlap (Telescope): Refer to 4C Section View B-B. Locate pins at all blanket overlaps, on all sides of the grease duct (Item 1), and meet the following requirements.

- i. Space pins max. 12 in. apart in rows across the width of grease duct (Item 1). Locate pins max. 6-3/4 in. from the edges of the grease duct (Item 1). Refer to section view A-A.
- ii. Space the rows of pins max. 10-1/2 in. apart along the length grease duct (Item 1). Where pieces of insulation (Item 4C) are butted together, space pins a max. 1-1/2 in. from the edge of the insulation. Refer to Item 4C section view B-B.
- iii. After insulation (Item 4C) is installed, place min. 2-1/2 × 2-1/2 in. square, galvanized steel, self-locking washer clips onto all insulation pins.
- iv. After clips are installed, cut off or bend flush with insulation (Item 4C) the pins that are too long.

D. Dual End Overlap (Checkerboard): Refer to 4D Section View B-B. Locate pins at all blanket overlaps, on all sides of the grease duct (Item 1), and meet the following requirements.

- i. Space pins max. 12 in. apart in rows across the width of grease duct (Item 1). Locate pins max. 6-3/4 in. from the edges of the grease duct (Item 1). Refer to section view A-A.
- ii. Space the rows of pins max. 10-1/2 in. apart along the length grease duct (Item 1). Where pieces of insulation (Item 4D) are butted together, space pins a max. 1-1/2 in. from the edge of the insulation. Refer to Item 4D section view B-B.
- iii. After insulation (Item 4D) is installed, place min. 2-1/2 × 2-1/2 in. square, galvanized steel, self-locking washer clips onto all insulation pins.
- iv. After clips are installed, cut off or bend flush with insulation (Item 4D) pins that are too long.

E. Compression Butt Joint – Single End Overlap: Refer to 4E Section View B-B. Locate pins at all blanket overlaps, on all sides of the grease duct (Item 1), and meet the following requirements.

- i. Space pins max. 12 in. apart in rows across the width of grease duct (Item 1). Locate pins max. 6-3/4 in. from the edges of the grease duct (Item 1). Refer to section view A-A.
- ii. Space the rows of pins as follows: use pattern nominal 9 in. apart, then max. 3 in. apart, then nominal 9 in. apart along the length of the grease duct (Item 1). Refer to Item 4E section view B-B.
- iii. After insulation (Item 4E) is installed, place min. 2-1/2 × 2-1/2 in. square, galvanized steel, self-locking washer clips onto all insulation pins.
- iv. After clips are installed, cut off or bend flush with insulation (Item 4A) the pins that are too long.

3. BANDING: Do not use banding for the installation of insulation method (Item 4A or 4E), Compression Butt Joint. Banding is an option to fastener methods (Items 2B, 2C and 2D) but not fastener method (Item 2A or 2E). After insulation (Item 4) is installed, apply min. 1/2 in. wide, 0.015 in. thick stainless steel bands or min. 1/2 in. wide, 0.020 in. thick carbon steel bands and secured with min. 1 in. long stainless or carbon steel crimp clamps to be used with corresponding banding type. When needed to ease installation, use filament tape as a temporary hold for the insulation (Item 4) prior to banding. Place banding a max. 1-1/2 in. from all insulation (Item 4) edges and a max. of 10-1/2 in. on center (oc). Tension the banding to hold the insulation (Item 4) in place without cutting or damaging the insulation (Item 4) or grease duct (Item 1).

4. CERTIFIED MANUFACTURER: 3M Company

CERTIFIED PRODUCT: 3M Fire Barrier™ Duct Wrap

MODEL: 615+

INSULATION: Apply the non-combustible (ASTM E136) and durable (ASTM C518) insulation in two layers of nominal 1-1/2 in. thick, 6 pcf density blanket, made of calcium-, silica-, and magnesium-oxide (CSM) fibers, encapsulated with polypropylene-foil or aluminized polyester- foil scrim over the entire surface of the grease duct (Item 1). Apply the inner first layer (Figure 1, 4.1) in accord with one of the four methods (A, B, C, or D) that follow. Offset the second outer layer (Figure 1, 4.2) one half the width of the inner first layer (Figure 1, 4.1) so that the joints of the inner first layer (Figure 1, 4.1) are covered by and approximately in the center of the second outer layer (Figure 1, 4.2). Apply the second outer layer (Figure 1, 4.2) in accord with the same method selected for the first inner layer (Figure 1, 4.1). Use blanket, available in various widths, that is fully encapsulated or single faced with a polypropylene-foil or polyester-foil scrim. Expose a foil-faced side of insulation to view. Wrap one layer of insulation around the grease duct (Item 1) perimeter so that each terminating end of insulation overlaps onto the starting end of insulation a min. of 3 in. at all transverse joints. Stagger the transverse overlap location so that no two consecutive adjacent overlaps align. Refer to section view A-A for transverse overlap section view. Cover all visually-exposed ends and edges of insulation with nominal 4 in. wide, pressure- sensitive, aluminum foil tape.

A. Compression Butt Joint: Refer to Item 4A section view B-B. Wrap the grease duct (Item 1) with two layers of insulation installed with compression butt joints at all circumferential joints. Apply the first layer, center pieces of insulation (Item 4A) over 2 in. wide pin bay, so that each piece nominal 24 in. wide blanket occupies two (2) full 9 in. wide bays and three (3) full 2 in. wide bays. Compress each edge of each piece of insulation together and butt to preceding edge of insulation in 2 in. wide bays. After installation, each piece of installed insulation width is 2 in. less than insulation nominal width. (Example: each piece of nominal 24 in.-wide insulation when installed is 22 in. wide.) Verify all insulation butt joints are compressed min. 50% at compression butt joints. Offset the second layer of insulation so that

the compression butt joint of the first layer of insulation is centered under the second layer of insulation and install in same manner as first layer of insulation.

- B. Butt Joint with Collar:** Refer to Item 4B section view B-B. Wrap the grease duct (Item 1) with two layers of insulation installed with butt joints at all circumferential joints. Apply the first layer, center pieces of insulation (Item 4A) over 3 in. wide pin bay, so that each piece nominal 24 in. wide blanket occupies two (2) full 9 in.-wide bays and one (1) full 3 in. wide bays and half of two (2) 3 in. wide bays at each circumferential edge. Butt each end of each piece of insulation together with preceding edge of insulation. Each piece of installed insulation width is its nominal width. (Example: each piece of nominal 24 in. wide insulation when installed is 24 in. wide.) Offset the second layer of insulation so that the butt joint of the first layer of insulation is centered under the second layer of insulation and install in same manner as first layer of insulation. Place and center 6 in. wide collar of insulation over the butt joint. Overlap 6 in. wide collar onto each adjacent insulation 3 in. Verify all insulation butt joints with collars are three layers of insulation in overall thickness.
- C. Single End Overlap (Telescope):** Refer to Item 4C section view B-B. Wrap the grease duct (Item 1) with two layers of insulation installed with 3 in. min. overlaps at all longitudinal joints. Overlap each adjacent insulation edge with the edge of the next piece of insulation. Verify all insulation overlaps are three layers of insulation in overall thickness.
- Starting at one end of the grease duct (Item 1), apply the first piece of insulation around the grease duct (Item 1) to overlap fasteners (Item 2C). Refer section view A-A.
 - Position and overlap the leading edge of the second piece of insulation nominally 3 in. over the flush edge of the first piece of insulation. Place the opposite edge of the second piece of insulation flush against the surface of the grease duct (Item 1). An "S-shaped" cross section of the insulation is created. Refer to Item 4C section view B-B.
 - Apply all additional pieces of insulation as "S-shaped" cross section of the insulation in compliance with Item 4Cii.
 - Position the second layer of insulation so that the joint of the first layer of insulation is centered under the second layer of insulation and install in same manner as first layer of insulation.
- D. Dual End Overlap (Checkerboard):** Refer to Item 4D section view B-B. Verify all insulation overlaps are a min. 3 in. in overall thickness. Do not align two consecutive insulation end overlaps. Overlap each full width insulation edge with the edge of the "gull wing" (-V-) shaped piece of insulation. Install insulation with zero clearance at the overlaps, or in the field between overlaps. Verify all insulation overlaps are four layers of insulation in overall thickness.
- Wrap the first piece of insulation around the grease duct (Item 1) so that the insulation is flush against the surface of the grease duct (Item 1). Position the starting end of the insulation to overlap pins (Item 2A) a min. of 1-1/2 in. while the edges of the insulation overlap the rows of pins (Item 2B) a min. of 1-1/2 in.
 - Position the second piece of insulation nominally 18 in. from the edge of the first piece of insulation. Install the second piece in the same manner as the first.
 - Cover the grease duct (Item 1) that is exposed between the edges of the first two pieces of insulation with another piece of insulation. Position the starting end of the insulation to overlap pins (Item 2A) a min. of 1-1/2 in. while the edges of the insulation overlap the adjacent edges of the two pieces installed insulation a min. of 1-1/2 in..
 - Position the second layer of insulation so that the first layer of insulation is centered under the second layer of insulation and install in same manner as first layer of insulation.
- E. Compression Butt Joint – Single End Overlap:** Refer to Item 4E section view B-B. Wrap the grease duct (Item 1) with one layer of insulation installed with compression butt joints at all circumferential joints and a second layer with single end overlap joints. Apply the first layer, center pieces of insulation (Item 4) over 3 in.-wide pin bay, so that each piece nominal 24 in. wide blanket occupies two (2) full 9 in. wide bays and two (2) full 3 in. wide bays. Compress each edge of each piece of insulation together and butt to preceding edge of insulation in 3 in. wide bays. After installation, each piece of installed insulation width is 3 in. less than insulation nominal width. (Example: each piece of nominal 24 in. wide insulation when installed is 21 in. wide.) Verify all insulation butt joints are compressed min. 50% at compression butt joints. Offset the second layer of insulation so that the compression butt joint of the first layer of insulation is centered under the second layer of insulation.
- 5. SUPPORTS:** If the grease duct is 24 in. x 24 in. or smaller, support the grease duct (Item 1) with insulation (Item 4) using a un- insulated "trapeze" system composed of a min. 2 x 2 x 1/8 in. steel angle as the trapeze cross-member and two (2), min. 3/8 in. diameter, all-thread, steel rods connected using nuts and washers. For ducts larger than 24 in. x 24 in., support the grease duct (Item 1) with insulation (Item 4) using a un-insulated "trapeze" system composed of a min. 2 x 2 x 1/4 in. steel angle as the trapeze cross-member and two (2), min. 5/8 in. diameter, all-thread, steel rods connected using nuts and washers. Connect the all-thread steel rods to the bottom of the floor assembly using an attachment method designed to carry the weight of the grease duct (Item 1) with insulation (Item 4) under a fire load equivalent to ASTM E 119 time- temperature curve. Place one (1) all-thread steel rod at each end of trapeze cross-member. Center grease duct (Item 1) with insulation (Item 4) on trapeze cross-member. Space all-thread steel rods a max. 6 in. from surface of the insulated grease duct or allowing all- thread steel rods to contact with the insulation (Item 4) at the min. distance. Extend trapeze cross-member at least 2 in. past each all-thread, steel rod. Space trapeze supports a max. 60 in. oc.
- 6. CERTIFIED MANUFACTURER:** 3M Company
- CERTIFIED PRODUCT:** 3M Fire Barrier™ Grease Duct Access Door
- MODELS:**
- 000-51115-16584-9 (20x20 Door),
 - 000-51115-16583-2 (12x8 Door), and
 - 000-51115-16582-5 (10x6 Door)

ACCESS DOOR ASSEMBLY: When required, apply an access door and insulated cover plate as described:

- A. OPTIONAL PRE-FABRICATED ACCESS DOOR:** Mark a clean-out access opening location on the grease duct (Item 1) with insulation (Item 4) at its mid-height along the horizontal section. Cut an opening (max. 22 × 22 in.) in the insulation (Item 4) the same size as the outside dimension of the desired pre-fabricated access door model. Remove and discard the cut insulation (Item 4). Cut an opening (max. 20 × 20 in.) into the side of the grease duct (Item 1) according to the manufacturer's instructions for the size of the pre-fabricated access door to be installed. Install and tightly secure the pre-fabricated access door in accordance with the manufacturer's instructions to the grease duct (Item 1). Fit pre-fabricated access door with four (4), 3/8 in. diameter, corner-thumb bolts through the exterior face.
- B. CERTIFIED MANUFACTURER:** 3M Company
CERTIFIED PRODUCT: 3M Fire Barrier™ Duct Wrap
MODEL: 615+

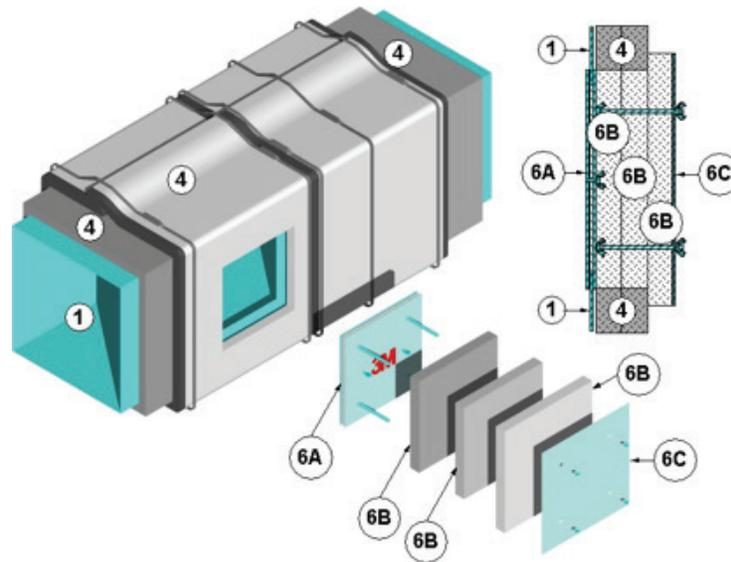

Figure 2 – 3M Pre-fabricated Access Door

ACCESS INSULATION: Remove the four (4), 3/8 in. diameter, corner-thumb bolts and replace them with four (4), 3/8 in. diameter, all-thread, steel rods extending from pre-fabricated access door (Item 6A). Apply three (3) layers of access insulation over the pre-fabricated access door (Item 6A) as follows. Cut the first piece of rectangular access insulation a min. 1/4 in. larger than the clean-out access opening. Position, square, and impale the first piece of the access insulation over the four (4), 3/8 in. diameter, all-thread, steel rods extending from pre-fabricated access door (Item 6A). Press the first piece of access insulation flush over the pre-fabricated access door (Item 6A). Compress and abut the cut edges of the first piece of the access insulation against the cut edges of opening in the insulation (Item 4). Cut a second piece of access insulation the same size as the first piece of access insulation. Press the second piece of access insulation flush over the first piece of access insulation. Compress and abut the cut edges of the first piece of the access insulation against the cut edges of opening in the insulation (Item 4). Cut a third piece of rectangular access insulation a min. of 2 in. larger than the second piece of access insulation on all sides. Seal cut edges of the third piece of access insulation with nominal 4 in.- wide aluminum foil tape. Position, square, and impale the third piece of the access insulation over the four (4), 3/8 in. diameter, all-thread, steel rods extending from pre-fabricated access door (Item 6A). Press the third piece of access insulation flush over second piece of access insulation.

- C. COVER PLATE:** Cut a cover plate to the same dimensions as the third piece of access insulation (Item 6B) using a min. 16 GA steel sheet. Drill holes in the cover plate that match the location of the four (4), 3/8 in. diameter, all-thread, steel rods and locate the holes so that the cover plate is squared to the third piece of access insulation (Item 6B). After all three (3) layers of access insulation (Item 6B) are impaled over the four (4), 3/8 in. diameter, all-thread, steel rods install the cover plate. Pass the four (4), 3/8 in. diameter, all-thread, steel rods through the cover plate. Place washers and wing nuts onto each of the four (4), 3/8 in. diameter, all-thread, steel rods. Secure the cover plate by tightening wing nuts.

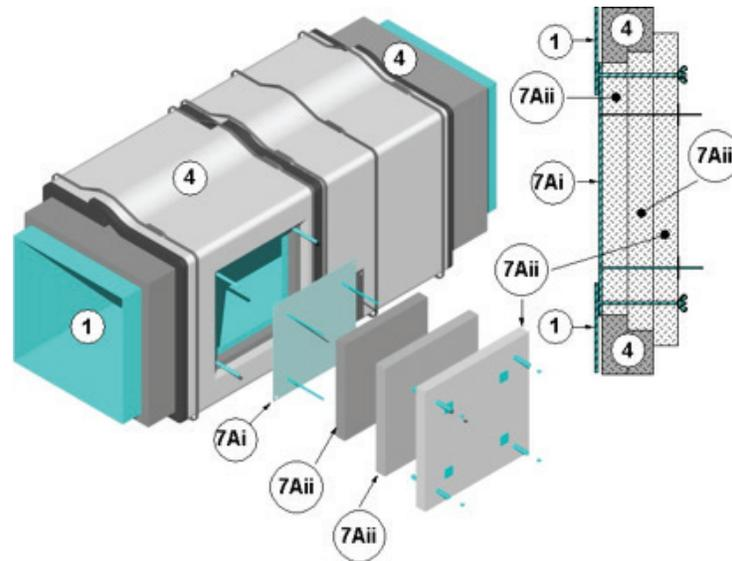

Figure 3 – Option A

- 7. OPTIONAL FIELD-FABRICATED ACCESS DOORS:** Mark a clean-out access opening location on the grease duct (Item 1) with insulation (Item 4) at its mid-height along the horizontal section. Use either Option A or B.
- A. (OPTION A)** Cut a 12×12 in. opening in the insulation (Item 4). Remove and discard the cut insulation (Item 4). Cut and center a 10×10 in. opening into the side of the grease duct (Item 1) by maintaining a 1 in. clearance between the perimeter of the opening and the cut insulation (Item 4). Remove and discard the cut steel. Weld four (4), min. 4 in. long, 1/4 in. diameter, all-thread, steel rods to the grease duct (Item 1). Locate one (1) steel rod at each corner of the grease duct (Item 1) opening so that they are 11 in. oc and squared within the insulation (Item 4) opening.
- i. ACCESS DOOR:** Cut a 12×12 in., 16 GA, steel plate to be used as an access door. Drill clearance holes in the access door to match the all-thread, steel rod pattern. Place the access door over the all-thread, steel rods. Seal the opening in the grease duct (Item 1) by overlapping the access door over the opening cut in the insulation (Item 4) by 1 in. on all sides. Weld four (4), min. 6-1/2 in. long, 12 GA, copper-coated, steel insulation pins to the access door corners so that the insulation pins are 9 in. oc.
 - ii. CERTIFIED MANUFACTURER:** 3M Company
CERTIFIED PRODUCT: 3M Fire
Barrier™ Duct Wrap MODEL: 615+
ACCESS INSULATION: Apply three (3) layers of access insulation over the access door. Cut the first piece of access insulation into a 12×12 in. square and install it over the insulation pins and cover the access door (Item 7Ai). Cut the second piece of access insulation into a 14×14 in. square. Square it and install it over the insulation pins. Cover the first piece of access insulation so that a 1 in. overlap exists. Cut the third piece of access insulation into a 16×16 in. square. Square it and install it over the insulation pins. Cover the second piece of access insulation so that a 1 in. overlap exists. Secure access insulation to the insulation pins with 1-1/2 in. square or round, galvanized or stainless steel, speed clips. Turn down or cut off insulation pins that extend beyond the second piece of access insulation. Place max. 4 in. long, steel tubing over each all-thread, steel rods. Apply washers and wing nuts over the all-thread, steel rods. Secure the access door by tightening the wing nuts.
- B. (OPTION B)** Cut a max. 16×16 in. opening into the insulation (Item 4) and the grease duct (Item 1). Remove and discard the cut insulation (Item 4) and steel. Weld together four (4) pieces of 1- 1/2 × 1-1/4 × 1/8 in. steel angle, with the flange outward, to form a 1-1/2 in. tall, flanged frame. Position, center, and continuously weld the flanged frame around the opening in the grease duct (Item 1). Position one (1), min. 4 in. long, 1/4 in. diameter, all-thread, steel rod in the center of each of the four (4) corners of the flange and weld them in place.
- i. ACCESS DOOR:** Cut an 18-1/2 × 18-1/2 in., 16 GA, steel plate to be used as an access door. Drill clearance holes in the access door to match the all-thread, steel rod pattern on the flange. Place the access door over the all-thread, steel rods.
 - ii. COVER PLATE:** Cut a 20-1/2 × 20-1/2 in. external cover plate out of 16 GA steel sheet and drill clearance holes matching the locations of the all-thread, steel rods on the flange. Weld min. four (4), 12 GA, copper-coated, steel insulation pins onto the internal surface of the cover plate, spaced min. 14 in. oc. Limit insulation pin length to one-half total access insulation thickness. Install access insulation (Item 7Biii). Position the cover plate with access insulation over the all-thread, steel rods flush to access door. Apply washers and wing nuts over the all-thread, steel rods. Secure the access door by tightening the wing nuts.

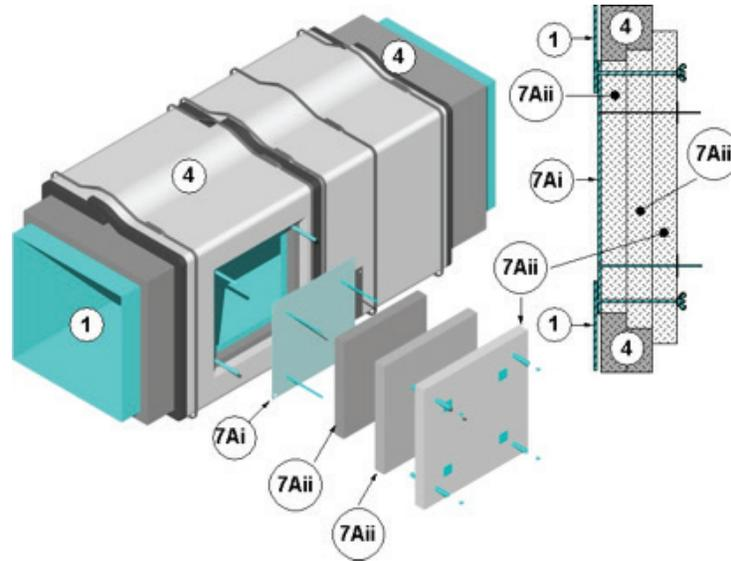

Figure 4 – Option B

iii. **CERTIFIED MANUFACTURER:** 3M Company

CERTIFIED PRODUCT: 3M Fire Barrier™ Duct Wrap

MODEL: 615+

ACCESS INSULATION: Apply two layers of access insulation over the interior of the cover plate. Cut the first piece of access insulation into a 20-1/2 × 20-1/2 in. square and install it over the insulation pins on the internal surface of the cover plate. Cut the second piece of access insulation into a 24 × 24 in. square. Square it to and install it over the insulation pins. Cover the first piece of access insulation so that a 1-3/4 in. overlap exists. Secure access insulation to insulation pins with 1-1/2 in. square or round, galvanized or stainless steel speed clips. Turn down or cut off insulation pins that extend beyond the second piece of access insulation.

8. NONCOMBUSTBLE² SUPPORTING CONSTRUCTION: Refer to Figures 3 and 4. Use one of the following wall or floor assemblies.

A. GYPSUM WALL ASSEMBLY: Symmetrical two-hour rated gypsum wall assembly constructed of the following:

- i. **Steel Studs** – Min. 25 GA galvanized steel studs measuring 3-5/8 in. wide with 1-1/4 in. legs spaced max. 24 in. oc. Attach studs with min. #6 × 3/8 in. steel stud framing screws to floor and ceiling tracks.

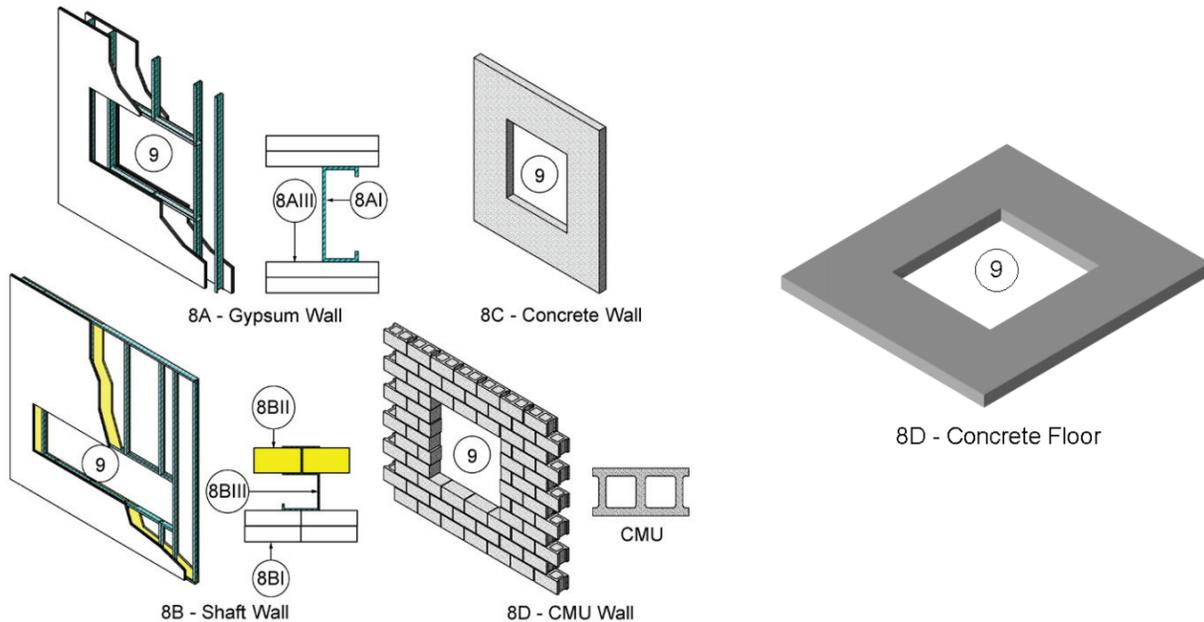

Figure 5 – Noncombustible Supporting Constructions

² Refers to building construction referenced in the building codes

- ii. **Tracks** – Channel U-shaped floor and ceiling runners measuring 1/2 in. deep by 3-5/8 in. wide, which are secured to floor and ceiling with 1 in. long fasteners suitable for the mounting to substrate and spaced max. 18 in. oc.
- iii. **Gypsum Board** – Cover studs and runners with two layers of 5/8 in. thick, Type X gypsum board on each face. Fasten base layer of gypsum board to steel studs with #6 1-1/8 in. bugle head phillips drywall screws spaced max. 12 in. oc. Fasten face layer of gypsum board with #6, 1-5/8 in. long bugle phillips drywall screws spaced max. 8 in. oc. Apply vinyl or casein, dry or premixed joint compound to face layers of gypsum board in two coats to all exposed screw heads and gypsum board joints. Embed min. 2 in. wide paper, plastic or fiberglass tape in first layer of joint compound over joints in gypsum board. Min. wall assembly thickness of 6 in. measured from face layer of gypsum board to opposite face layer of gypsum board.

B. SHAFT WALL ASSEMBLY: Asymmetrical two-hour rated gypsum shaft wall assembly constructed of the following:

- i. **Visual Gypsum Board** – Cover studs and runners with two layers of min. 1/2 in. thick, Type X gypsum board on each face. Fasten base layer of gypsum board to steel studs with #6 1-1/8 in. bugle head phillips drywall screws spaced max. 12 in. oc. Fasten face layer of gypsum board with #6, 1-5/8 in. long bugle phillips drywall screws spaced max. 8 in. oc. Apply vinyl or casein, dry or premixed joint compound to face layers of gypsum board in two coats to all exposed screw heads and gypsum board joints. Embed min. 2 in. wide paper, plastic or fiberglass tape in first layer of joint compound over joints in gypsum board. Min. wall assembly thickness of 4-1/2 in. measured from face layer of gypsum board to opposite face layer of gypsum board.
- ii. **Interior Gypsum Board** – Cut 1 in. thick Type X gypsum board 1 in. less than floor to ceiling height. Insert the longitudinal edges of the 1 in. thick Type X gypsum board into the C-T or C-H studs. Secure the transverse edge of the 1 in. thick Type X gypsum board to the long leg of J-runner using its tabs or min. 1-5/8 in. long Type S self-tapping bugle head steel screws spaced max. 12 in. oc.
- iii. **Steel Studs** – Cut min. 25 GA galvanized steel C-T or C-H studs measuring min. 2-1/2 in. wide with min. 1-1/2 in. flanges 3/4 in. less than floor to ceiling height and spaced max. 24 in. oc in runners with T or H section abutting long leg of runner.
- iv. **Runners** – Use min. 2-1/2 in. wide J-runner compatible with studs and having unequal vertical legs: min. 1 in. short leg and min. 2 in. long leg. Position J-runners with short leg towards visual face of shaft wall. Attach to floor and ceiling using steel fasteners located a max. of 2 in. from each end and a max. of 24 in. oc.

C. CONCRETE WALL ASSEMBLY: Symmetrical, two-hour rated, solid concrete, wall assembly made from reinforced lightweight or normal weight (100–150 pcf or 1600–2400 kg/m³) concrete, which may also be used as a shaft wall assembly. Constructed of solid concrete with a min. concrete thickness measured from exposed face to exposed face using one of the following:

- i. lightweight concrete is 3.6 in.;
- ii. sand-lightweight concrete is 3.8 in.;
- iii. carbonate aggregate concrete is 4.6 in.; and
- iv. siliceous aggregate concrete is 5.0 in.

D. MASONRY WALL ASSEMBLY: Symmetrical, two-hour rated, nominal 8 × 8 × 16 CMU, wall assembly made from lightweight or normal weight (100–150 pcf or 1600–2400 kg/m³) concrete, which may also be used as a shaft wall assembly.

E. CONCRETE FLOOR ASSEMBLY: Symmetrical two-hour rated solid concrete floor assembly made from reinforced lightweight or normal weight (100–150 pcf or 1600–2400 kg/m³) concrete. Constructed of solid concrete with a min. concrete thickness measured from exposed face to exposed face using one of the following:

- i. lightweight concrete is 3.6 in.;
- ii. sand-lightweight concrete is 3.8 in.;
- iii. carbonate aggregate concrete is 4.6 in.; and
- iv. siliceous aggregate concrete is 5.0 in.

9. **OPENING** – Create an opening in the assembly. Position the grease duct (Item 1) concentrically or eccentrically in the opening so that the annular space ranges from min. 0.5 in. to max. 4-1/2 in.. Establish an opening designed to house the grease duct (Item 1) covered with insulation (Item 4) and the desired annular space but not exceeding a cross-sectional area of max. 3136 in.² and a max. dimension of 59.5 in.

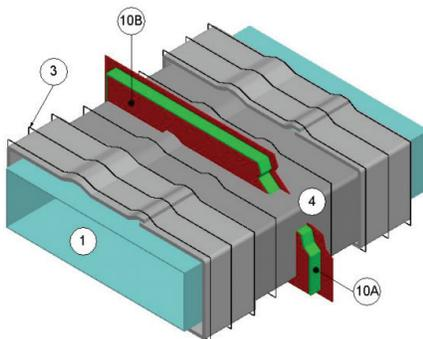

Symmetrical Firestops for Horizontal Grease Ducts
with Insulation Through Noncombustible Wall Assemblies

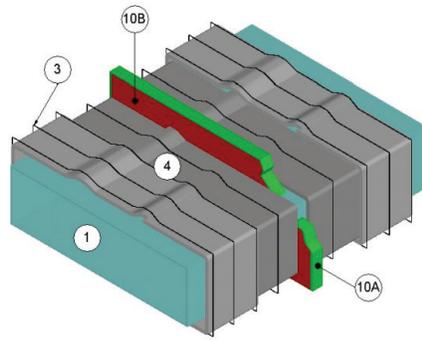

Asymmetrical Firestops for Horizontal Grease Ducts without Insulation Through Noncombustible Shaft Assemblies

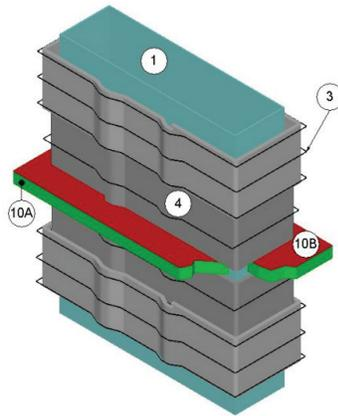

Asymmetrical Firestops for Vertical Grease Ducts without Insulation Through Noncombustible Floor Assemblies

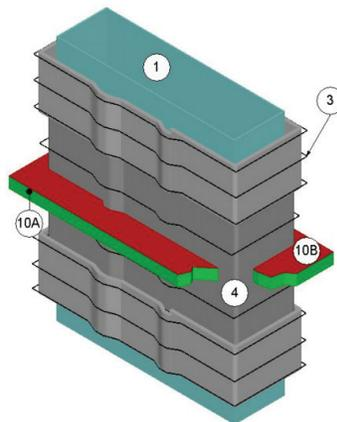

Asymmetrical Firestops for Vertical Grease Ducts with Insulation Through Noncombustible Floor Assemblies

Figure 6 – Penetration Firestops for Noncombustible Supporting Constructions

10. PENETRATION FIRESTOP: Install two-hour, fire-resistant, ASTM E 814, firestop system. Install firestop between the supporting construction (Item 6) and the grease duct (Item 1) or the grease duct (Item 1) protected with the insulation (Item 4). Use a symmetrical wall penetration firestop, an asymmetrical shaft penetration firestop, or an asymmetrical floor penetration firestop constructed of the following components.

3MU/BI 120-03 (cont.)

A. CERTIFIED MANUFACTURER: 3M Company

CERTIFIED PRODUCT: 3M Fire Barrier™ Duct Wrap MODEL: 615+

PACKING MATERIAL: Fill the entire annular space's width with min. 4 pcf density mineral wool or certified insulation without the encapsulation (foil scrim). Cut the packing material into strips not less than one and one half (1-1/2) times the width of the annular space to be filled. Compress packing material nominally 33% and insert packing material into the annular space.

For wall assemblies, recess the surface of packing material nominally 5/8 in. from surfaces of both faces of the supporting construction (Item 8).

For floor assemblies, recess the surface of packing material nominally 5/8 in. from the visual surface of the supporting construction (Items 8) and install a min. depth of 4 in.

B. CERTIFIED MANUFACTURER: 3M Company

CERTIFIED PRODUCT: 3M™ Fire Barrier™ Sealant

MODEL: Water-Tight 1000-NS Silicone, 1003-SL Silicone (Floor Assembly Only), 2000+ Silicone, or CP 25 WB+

FILL, VOID OR CAVITY MATERIAL: Install min. 5/8 in. depth of fill material into the recess over the entire surface of the packing material (Item 7A). Screed the fill material flush with the surface of the supporting construction (Item 8). Overlap a min. of 1/4 in., the fill material onto face of supporting construction (Item 8).

Flexible Wraps

Duct Wrap

Grease Duct

BI

This material was extracted and drawn by 3M Fire Protection Products from the 2018 Product Directory, © Intertek



Ventilation Duct Protection

| 3M Systems | "F" Rating | 3M Product | Application Details |
|---------------|------------|--|---|
| 3MU/DI 120-01 | 2 | 3M™ Fire Barrier Duct Wrap 615+ 3M™ Fire Barrier Duct Wrap 615 3M™ Fire Barrier Water Tight Sealant 1003 SL 3M™ Fire Barrier Water Tight Sealant 1000 NS 3M™ Fire Barrier Sealant CP 25WB+ 3M™ Fire Barrier Water Tight Sealant 3000 WT | 1 hour flexible wrap protection for a circular or rectangular steel HVAC duct using Fire Barrier Duct Wrap 615+. Tested per ISO 6944. Also addresses through penetrations of rated horizontal or vertical assemblies. |
| 3MU/DI 60-01 | 1 | 3M™ Fire Barrier Duct Wrap 615+ 3M™ Fire Barrier Duct Wrap 615 3M™ Fire Barrier Water Tight Sealant 1003 SL 3M™ Fire Barrier Water Tight Sealant 1000 NS 3M™ Fire Barrier Sealant CP 25WB+ 3M™ Fire Barrier Water Tight Sealant 3000 WT | 1 hour flexible wrap protection for a circular or rectangular steel HVAC duct using Fire Barrier Duct Wrap 615+. Tested per ISO 6944. Also addresses through penetrations of rated horizontal or vertical assemblies. |
| V-20 | 2 | 3M™ Fire Barrier Duct Wrap 615+ 3M™ Fire Barrier Duct Wrap 615 | Max 24" x 60" steel air duct. 2 layers of Duct Wrap. Duct to be firestopped per UL System C-AJ-7096. 2 hour Stability, Integrity, and Insulation ratings. Also known as V20. |
| V-27 | 1, 2 | 3M™ Fire Barrier Duct Wrap 615+ 3M™ Fire Barrier Duct Wrap 615 | Max 85 in. x 24 in. min 22 ga. steel air duct. One layer of Fire Barrier Duct Wrap 615. Telescope, checkerboard, or butt-joint and collar pattern installation. 2 hour rating. Firestop in accordance with UL System W-J-7104 or W-L-7180. Also known as V27. |
| V-31 | 2 | 3M™ Fire Barrier Duct Wrap 615 3M™ Fire Barrier Duct Wrap 615+ | Max 85 in. x 24 in. min 22 gauge steel duct. Duct max 8 in. from 2 hour F rated assembly. Two or three sided wrap. One layer of wrap required. Butt joint and collar or overlap installation method. 2 hour F rating. |
| FRD-17 | 1, 2 | 3M™ Fire Barrier Duct Wrap 615 3M™ Fire Barrier Sealant IC 15WB+ 3M™ Fire Barrier Sealant CP 25WB+ 3M™ Fire Barrier Water Tight Sealant 1000 NS 3M™ Fire Barrier Water Tight Sealant 1003 SL 3M™ Fire Barrier Water Tight Sealant 3000 WT | Air duct per SMACNA guidelines with 1.32sq.m. max area with one dimension max 2.16m. System addresses wrap installation and through penetration firestop. 1 & 2 hour F rating. Also known as FRD17. |
| FRD-19 | 1, 2 | 3M™ Fire Barrier Duct Wrap 615 3M™ Fire Barrier Sealant IC 15WB+ 3M™ Fire Barrier Sealant CP 25WB+ 3M™ Fire Barrier Water Tight Sealant 1000 NS 3M™ Fire Barrier Water Tight Sealant 1003 SL 3M™ Fire Barrier Water Tight Sealant 3000 WT | Grease duct per NFPA 96 with .93 sq.m. max area with one dimension max 1219mm. System addresses wrap installation and through penetration firestop. 1 & 2 hour F rating. Also known as FRD19. |
| FRD-23 | 2 | 3M™ Fire Barrier Duct Wrap 615 3M™ Fire Barrier Sealant IC 15WB+ 3M™ Fire Barrier Sealant CP 25WB+ 3M™ Fire Barrier Water Tight Sealant 1000 NS 3M™ Fire Barrier Water Tight Sealant 1003 SL 3M™ Fire Barrier Water Tight Sealant 3000 WT | Air duct per SMACNA guidelines with 1.32sq.m. max area with one dimension max 2.16m. System addresses wrap installation and through penetration firestop. 2-sided and 3-sided installation of wrap. 2 hour F rating. Also known as FRD23. |
| FRD-27 | 1, 2 | 3M™ Fire Barrier Duct Wrap 615 3M™ Fire Barrier Sealant IC 15WB+ 3M™ Fire Barrier Sealant CP 25WB+ 3M™ Fire Barrier Water Tight Sealant 1000 NS 3M™ Fire Barrier Water Tight Sealant 1003 SL 3M™ Fire Barrier Water Tight Sealant 3000 WT | Air duct per NFPA 96 with 1.32sq.m. max area with one dimension max 2.16m. System addresses wrap installation and through penetration firestop. 1 & 2 hour F rating. Also known as FRD27. |

Design No. 3MU/DI 120-01

November 25, 2014

VENTILATION DUCT PROTECTION

3M Company

3M™ Fire Barrier™ Duct Wraps: 615 and 615+

3M™ Fire Barrier™ Sealants: Water-Tight 1000-NS Silicone,

Water-Tight 1003-SL Silicone (floors only),

2000+ Silicone, and CP 25 WB+

ISO 6944 (1985) Duct A

Stability – 2 hr

Insulation – 2 hr

Integrity – 2 hr

ASTM E 814

F-Rating – 2 hr

T-Rating – 2 hr

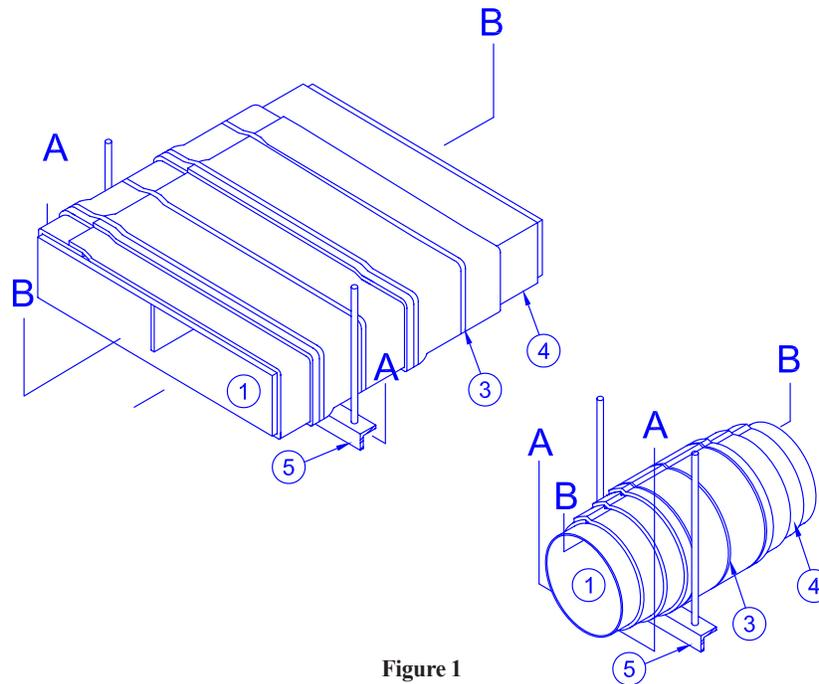
**Figure 1**

1. VENTILATION DUCT: Refer to Figure 1. Continuous, air-tight, rectangular or circular duct system with either horizontally or vertically oriented shafts constructed of sheet steel with a max. area and a max. dimension as referenced in the Table 1. When required, equip the ventilation duct with transition fittings, e.g. elbows, tees, reducers, etcetera.

| Ventilation Duct for Items 7 References | Shape | Min Gauge | Max Dimension | Max Diameter | Max Area |
|---|-------------|-----------|---------------|--------------|----------|
| R1 | Rectangular | 26 | 12 | -- | 144 |
| R2 | Rectangular | 24 | 40 | -- | 400 |
| R3 | Rectangular | 22 | 60 | -- | 1440 |
| R4 | Rectangular | 22 | 85 | -- | 2040 |
| C1 | Circular | 26 | -- | 13 | 133 |
| C2 | Circular | 24 | -- | 21 | 346 |
| C3 | Circular | 20 | -- | 40 | 1257 |

- A. Construct the ventilation duct using sections affixed to each other with seams or flanges.
- B. Reinforce the ventilation duct to IMC, SMACNA* or NFPA 90A requirements designed to carry the weight of the ventilation duct assembly covered with insulation (Item 4) under a fire load equivalent to ASTM E 119 time-temperature curve.
*Exception: SMACNA 3rd Edition - 2005, RT3 Drawband Joint or equivalent are not approved for use under this design listing with circular ventilation ducts.
- C. Rigidly support the ventilation duct in accordance with IMC, SMACNA or NFPA 90A requirements designed to carry the weight of the ventilation duct assembly covered with insulation (Item 4) under a fire load equivalent to ASTM E 119 time-temperature curve or as specified in Item 5.
- D. Protect the annular space around the ventilation duct passing through a fire rated wall assembly with an Intertek certified, compatible, 3M, penetration firestop system, refer to Section 8, having the same fire rating as the wall assembly.

Design No. 3MU/DI 120-01 continued

2. FASTENERS: Refer to Figure 2. Weld min. 12 GA, 4-1/2 in. long, copper-coated steel insulation pins or 12 GA insulated cup head pins to the ventilation duct (Item 1). Match fastener method with corresponding insulation (Item 4) method.
 - A. Compression Butt Joint: Refer to 4A Section View B-B. Locate pins at all blanket overlaps, on all sides of the ventilation duct (Item 1), and meet the following requirements.
 - I. Space pins max. 12 in. apart in rows across the width of ventilation duct (Item 1). Locate pins max. 6-3/4 in. from the edges of the rectangular ventilation duct (Item 1).
 - II. Space the rows of pins max. 9-1/2 in. apart along the length ventilation duct (Item 1). Where pieces of insulation (Item 4A) are to be butted together, space the pins a max. of 2 in. apart.
 - III. After insulation (Item 4A) is installed, place min. 2.5 in. x 2.5 in. square, galvanized steel, self locking washer clips onto all insulation pins.
 - IV. After clips are installed, cut off or bend flush with insulation (Item 4) the pins that are too long.
 - B. Butt Joint with Collar: Refer to 4B Section View B-B. Locate pins at all blanket overlaps, on all sides of the ventilation duct (Item 1), and meet the following requirements.
 - I. Space pins max. 12 in. apart in rows around the circumference for circular ventilation ducts (Item 1) or on all sides for rectangular ventilation ducts (Item 1). For rectangular ventilation ducts (Item 1), locate pins max. 6-3/4 in. from the edges.
 - II. Space the rows of pins max. 9 in. apart along the length ventilation duct (Item 1). Where pieces of insulation (Item 4B) are to be butted together, space the pins a max. of 3 in. apart.
 - III. After insulation (Item 4B) is installed, place min. 2.5 in. x 2.5 in. square, galvanized steel, self locking washer clips onto all insulation pins.
 - IV. After clips are installed, cut off or bend flush with insulation (Item 4B) the pins that are too long.
 - C. Single End Overlap (Telescope): Refer to 4C Section View B-B. Locate pins at all blanket overlaps, on all sides of the ventilation duct (Item 1), and meet the following requirements.
 - I. Space pins max. 12 in. apart in rows across the width of ventilation duct (Item 1). Locate pins max. 6-3/4 in. from the edges of the rectangular ventilation duct (Item 1).
 - II. Space the rows of pins max. 10-1/2 in. apart along the length ventilation duct (Item 1). Where pieces of insulation (Item 4C) are to be butted together, space the pins a max. 1-1/2 in. apart.
 - III. After insulation (Item 4C) is installed, place min. 2.5 in. x 2.5 in. square, galvanized steel, self locking washer clips onto all insulation pins.
 - IV. After clips are installed, cut off or bend flush with insulation (Item 4C) the pins that are too long.
 - D. Dual End Overlap (Checkerboard): Refer to 4D Section View B-B. Locate pins at all blanket overlaps, on all sides of the ventilation duct (Item 1), and meet the following requirements.
 - I. Space pins max. 12 in. apart in rows across the width of ventilation duct (Item 1). Locate pins max. 6-3/4 in. from the edges of the rectangular ventilation duct (Item 1).
 - II. Space the rows of pins max. 10-1/2 in. apart along the length ventilation duct (Item 1). Where pieces of insulation (Item 4D) are to be butted together, space the pins a max. of 1-1/2 in. apart.
 - III. After insulation (Item 4D) is installed, place min. 2.5 in. x 2.5 in. square, galvanized steel, self locking washer clips onto all insulation pins.
 - IV. After clips are installed, cut off or bend flush with insulation (Item 4D) the pins that are too long.

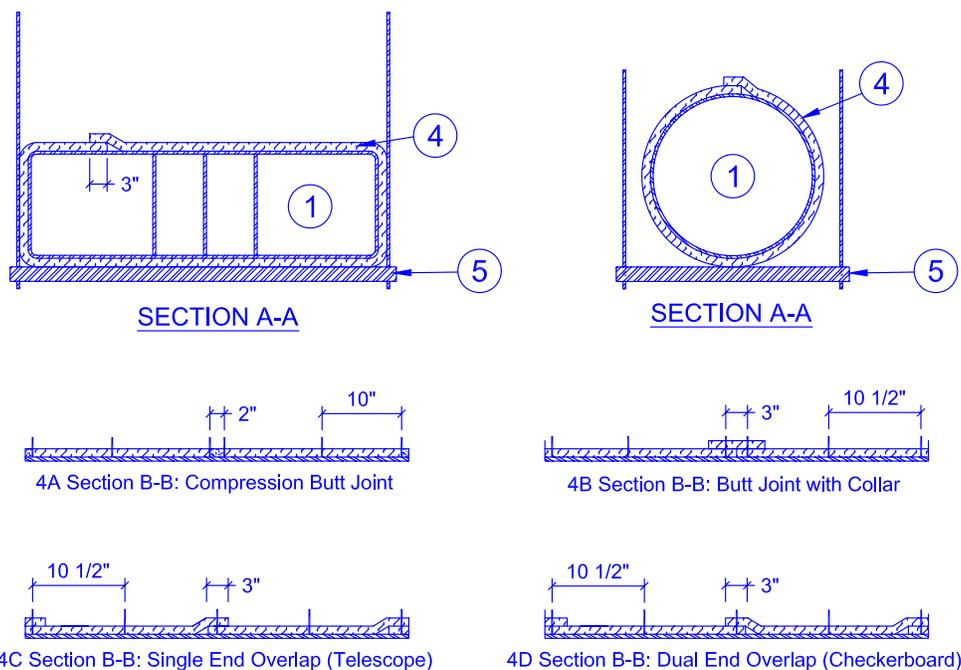

Figure 2

Design No. 3MU/DI 120-01 *continued*

Flexible Wraps

3. **BANDING:** Do not use banding for the installation of insulation method (Item 4A), Compression Butt Joint. Banding is an option to fastener methods (Items 2B, 2C and 2D) but not fastener method (Item 2A). After insulation (Item 4) is installed, apply min. 1/2 in. wide, 0.015 in. thick stainless steel bands or min. 1/2 in. wide, 0.020 in. thick carbon steel bands and secured with min. 1 in. long stainless or carbon steel crimp clamps to be used with corresponding banding type. When needed to ease installation, use filament tape as a temporary hold for the insulation (Item 4) prior to banding. Place banding a max. 1-1/2 in. from all insulation (Item 4) edges and a max. of 10-1/2 in. on center (oc). Tension the banding to hold the insulation (Item 4) in place without cutting or damaging the insulation (Item 4) or ventilation duct (Item 1).

4. **CERTIFIED MANUFACTURER:** 3M Company

CERTIFIED PRODUCT: 3M™ Fire Barrier Duct Wrap

MODEL: 615 or 615+

INSULATION: Refer to Figure 2. Apply one layer of nominal 1-1/2 in. thick, 6 pcf blanket, made of fibers, encapsulated with foil scrim over the entire surface of the ventilation duct (Item 1) and a collar on each side of the penetration firestop (Item 1D). Apply the insulation in accord with one of the four methods (A, B, C, or D) that follow. Use blanket that is encapsulated with a polypropylene/foil scrim or an aluminized polyester/scrim/foil. Wrap one layer of insulation around the ventilation duct (Item 1) perimeter so that each terminating end of insulation overlaps onto the starting end of insulation a min. of 3 in. at all transverse joints. Alternate the transverse overlap location so that no two consecutive adjacent overlaps align. Refer to Section View A-A for transverse overlap section view. Cover and seal all visually exposed ends and edges of insulation with nominal 4 in. wide pressure-sensitive aluminum foil tape.

- A. **Compression Butt Joint:** Refer to 4A Section View B-B. Wrap the ventilation duct (Item 1) with one layer of insulation installed with compression butt joints at all longitudinal joints. Compress each end of each piece of insulation together and butt to preceding edge of insulation. Each piece of installed insulation width is 2 in. less than insulation nominal width. (Example: each piece of nominal 24 in. wide insulation when installed is 22 in. wide.) Install the insulation overlap in contact (pressed against) with the insulation being overlapped. Verify all insulation butt joints are a min. 1-1/2 in. in overall thickness at compression butt joints.
 - B. **Butt Joint with Collar:** Refer to 4B Section View B-B. Wrap the ventilation duct (Item 1) with one layer of insulation installed with butt joints at all longitudinal joints. Butt each end of each piece of insulation together with preceding edge of insulation. Each piece of installed insulation width is its nominal width. (Example: each piece of nominal 24 in. wide insulation when installed is 24 in. wide.) Install the insulation overlap in contact (pressed against) with the insulation being overlapped. Place and center 6 in. wide collar of insulation over the butt joint. Overlap 6 in. wide collar onto each adjacent insulation 3 in. Verify all insulation butt joints with collars are a min. 3 in. in overall thickness.
 - C. **Single End Overlap (Telescope):** Refer to 4C Section View B-B. Wrap the ventilation duct (Item 1) with one layer of insulation installed with 3 in. min. overlaps at all longitudinal joints. Overlap each adjacent insulation edge with the edge of the next piece of insulation. Install the insulation overlap in contact (pressed against) with the insulation being overlapped. Verify all insulation overlaps are nominally 3 in. in overall thickness.
 - I. Starting at one end of the ventilation duct (Item 1), apply the first piece of insulation around the ventilation duct (Item 1) to overlap fasteners (Item 2C). Refer section view A-A.
 - II. Position and overlap the leading edge of the second piece of insulation nominally 3 in. over the flush edge of the first piece of insulation. Place the opposite edge of the second piece of insulation flush against the surface of the ventilation duct (Item 1). An “S-shaped” cross section of the insulation is created. Refer to 4C section view B-B.
 - III. Apply all additional pieces of insulation as “S-shaped” cross section of the insulation in compliance with Item 4CII.
 - D. **Dual End Overlap (Checkerboard):** Refer to 4D Section View B-B. Verify all insulation overlaps are a min. 3 in. in overall thickness. Do not align two consecutive insulation end overlaps. Overlap each full-width insulation edge with the edge of the “Gull Wing”, **U** shaped insulation. Install the insulation overlap in contact (pressed against) with the insulation being overlapped. Verify all insulation overlaps are nominally 3 in. in overall thickness.
 - I. Wrap the first piece of insulation around the ventilation duct (Item 1) so that the insulation is flush against the surface of the ventilation duct (Item 1). Position the starting end of the insulation to overlap pins (Item 2A) a min. of 1-1/2 in. while the edges of the insulation overlap the rows of pins (Item 2B) a min. of 1-1/2 in.
 - II. Position the second piece of insulation nominally 18 in. from the edge of the first piece of insulation. Install the second piece in the same manner as the first.
 - III. Cover the ventilation duct (Item 1) that is exposed between the edges of the first two pieces of insulation with another piece of insulation. Position the starting end of the insulation to overlap pins (Item 2A) a min. of 1-1/2 in. while the edges of the insulation overlap the adjacent edges of the two pieces installed insulation a min. of 1-1/2 in.
5. **SUPPORTS:** Support the insulated ventilation duct (Item 1) using a support system composed of min. 3/8 in. diameter steel, all-thread rods and min. 2 x 2 x 1/4 in. steel angle cross-member for rectangular ducts or a min. 2 x 2 x 1/4 in. steel angle ring cross-member for circular ducts. Connect all-thread steel rods (insulation (Item 4) not required) to the angle or angle ring cross-member using nuts and washers. Connect the all-thread steel rods to the bottom of the floor assembly using an attachment method designed to carry the weight of the ventilation duct (Item 1) with insulation (Item 4) under a fire load equivalent to ASTM E119 time-temperature curve. Center ventilation duct (Item 1) with insulation (Item 4) on support cross-member. Space all-thread steel rods a max. distance of 6 in. from surface of the insulated ventilation duct or allowing all-thread steel rods to contact with the insulation (Item 4) at the min. distance. Extend support cross-member at least 2 in. past each all-thread steel rod. Space supports a max. 60 in. oc.

Duct Wrap

Ventilation Duct

DI

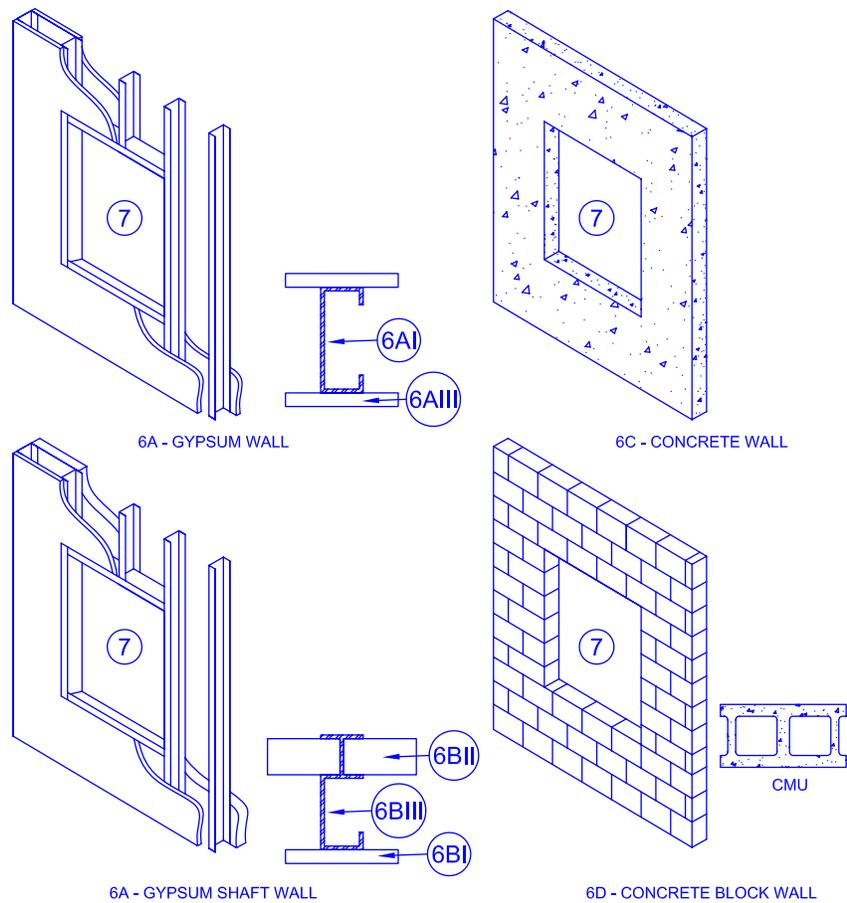

Figure 3

6. SUPPORTING CONSTRUCTION: Refer to Figures 3 and 4. Use one of the following wall or floor assemblies.

A. GYPSUM WALL ASSEMBLY: Symmetrical two-hour rated gypsum wall assembly, which may also be used as a shaft wall assembly, constructed of the following:

- I. Steel Studs – Min. 25 GA galvanized steel studs measuring 3-5/8 in. wide with 1-1/4 in. legs spaced max. 24 in. oc. Attach studs with min. #6 x 3/8 in. steel stud framing screws to floor and ceiling tracks.
- II. Tracks – Channel U-shaped floor and ceiling runners measuring 1/2 in. deep by 3-5/8 in. wide, which are secured to floor and ceiling with 1 in. long fasteners suitable for the mounting to substrate and spaced max. 18 in. oc.
- III. Gypsum Board – Cover studs and runners with two layers of 5/8 in. thick, Type X gypsum board on each face. Fasten base layer of gypsum board to steel studs with #6 1-1/8 in. bugle head phillips drywall screws spaced max. 12 in. oc. Fasten face layer of gypsum board with #6, 1-5/8 in. long bugle phillips drywall screws spaced max. 8 in. oc. Apply vinyl or casein, dry or premixed joint compound to face layers of gypsum board in two coats to all exposed screw heads and gypsum board joints. Embed min. 2 in. wide paper, plastic or fiberglass tape in first layer of joint compound over joints in gypsum board. Min. wall assembly thickness of 6 in. measured from face layer of gypsum board to opposite face layer of gypsum board.

B. SHAFT WALL ASSEMBLY: Asymmetrical two-hour rated gypsum shaft wall assembly constructed of the following:

- I. Visual Gypsum Board – Cover studs and runners with two layers of min. 1/2 in. thick, Type X gypsum board on each face. Fasten base layer of gypsum board to steel studs with #6 1-1/8 in. bugle head phillips drywall screws spaced max. 12 in. oc. Fasten face layer of gypsum board with #6, 1-5/8 in. long bugle phillips drywall screws spaced max. 8 in. oc. Apply vinyl or casein, dry or premixed joint compound to face layers of gypsum board in two coats to all exposed screw heads and gypsum board joints. Embed min. 2 in. wide paper, plastic or fiberglass tape in first layer of joint compound over joints in gypsum board. Min. wall assembly thickness of 4-1/2 in. measured from face layer of gypsum board to opposite face layer of gypsum board.
- II. Interior Gypsum Board – Cut 1 in. thick Type X gypsum board 1 in. less than floor to ceiling height. Insert the longitudinal edges of the 1 in. thick Type X gypsum board into the C-T or C-H studs. Secure the transverse edge of the 1 in. thick Type X gypsum board to the long leg of J-runner using its tabs or min. 1-5/8 in. long Type S self-tapping bugle head steel screws spaced max. 12 in. oc.
- III. Steel Studs – Cut min. 25 GA galvanized steel C-T or C-H studs measuring min. 2-1/2 in. wide with min. 1-1/2 in. flanges 3/4 in. less than floor to ceiling height and spaced max. 24 in. oc in runners with T or H section abutting long leg of runner.
- IV. Runners – Use min. 2-1/2 in. wide J-runner compatible with studs and having unequal vertical legs: min. 1 in. short leg and min. 2 in. long leg. Position J-runners with short leg towards visual face of shaft wall. Attach to floor and ceiling using steel fasteners located a max. of 2 in. from each end and a max. of 24 in. oc.

Design No. 3MU/DI 120-01 *continued*

- C. **CONCRETE WALL ASSEMBLY:** Symmetrical, two-hour rated, solid concrete, wall assembly made from reinforced lightweight or normal weight (100-150 pcf or 1600-2400 kg/m³) concrete, which may also be used as a shaft wall assembly. Constructed of solid concrete with a min. concrete thickness measured from exposed face to exposed face using one of the following:
- I. lightweight concrete is 3.6 in.;
 - II. sand-lightweight concrete is 3.8 in.;
 - III. carbonate aggregate concrete is 4.6 in.; and
 - IV. siliceous aggregate concrete is 5.0 in..
- D. **MASONRY WALL ASSEMBLY:** Symmetrical, two-hour rated, nominal 8 x 8 x 16 CMU, wall assembly made from lightweight or normal weight (100-150 pcf or 1600-2400 kg/m³) concrete, which may also be used as a shaft wall assembly.

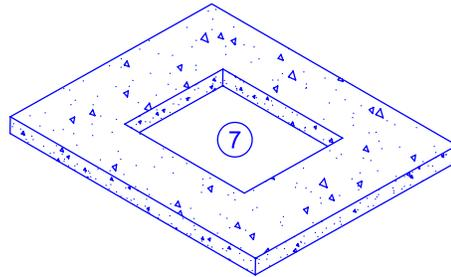

6E - CONCRETE FLOOR

Figure 4

- E. **CONCRETE FLOOR ASSEMBLY:** Symmetrical two-hour rated solid concrete floor assembly made from reinforced lightweight or normal weight (100-150 pcf or 1600-2400 kg/m³) concrete. Constructed of solid concrete with a min. concrete thickness measured from exposed face to exposed face using one of the following:
- I. lightweight concrete is 3.6 in.;
 - II. sand-lightweight concrete is 3.8 in.;
 - III. carbonate aggregate concrete is 4.6 in.; and
 - IV. siliceous aggregate concrete is 5.0 in..
7. **OPENING:** – Refer to Figures 3 and 4. Create an opening in the supporting construction (wall or floor assembly). Determine the opening shape and size to house the ventilation duct's (Item 1), whether with or without insulation (item 4) passing through the opening, shape and size. Position the penetrating item (Item 1) concentrically or eccentrically in the opening so that the annular space ranges from min. to max. as in Table 2. Make the opening with in accord with the following:
- A. For gypsum wall assemblies (Item 6A) and shaft wall assemblies (Item 6B), frame the opening with steel studs (Item 6A1) and tracks (Item 6A11).

| Table 2 Opening Information | | | | |
|---|--|-------------------------------|-------------------------|-------------------------|
| Ventilation Duct Requirements Refer to Table 1 | Maximum | | Annular space | |
| | Cross Sectional Area (inches²) | Dimension (inches) | Min (inches) | Max (inches) |
| R1 | 506 | 22.5 | 1 | 3-1/2 |
| R2 | 1035 | 50.5 | 1 | 3-1/2 |
| R3 | 2432 | 70.5 | 1 | 3-1/2 |
| R4 | 2492 | 89 | 1 | 3 |
| C1 | 241 | 17.5 | 1 | 3-1/2 |
| C2 | 511 | 25.5 | 1 | 3-1/2 |
| C3 | 1555 | 44.5 | 1 | 3-1/2 |

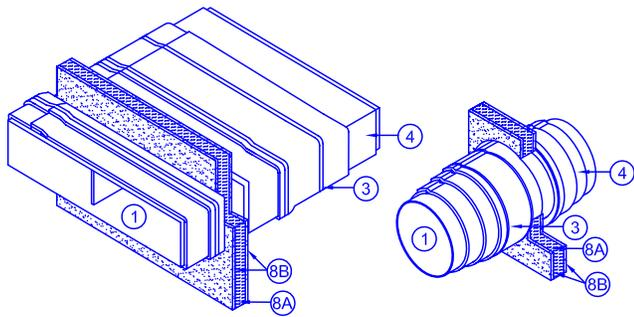

SYMMETRICAL FIRESTOPS FOR HORIZONTAL VENTILATION DUCTS WITHOUT INSULATION THROUGH WALL ASSEMBLIES

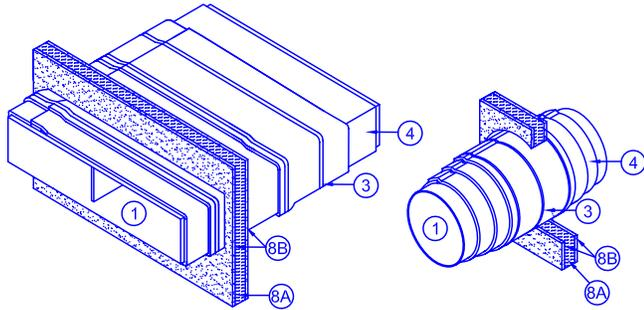

SYMMETRICAL FIRESTOPS FOR HORIZONTAL VENTILATION DUCTS WITH INSULATION THROUGH WALL ASSEMBLIES

Figure 5

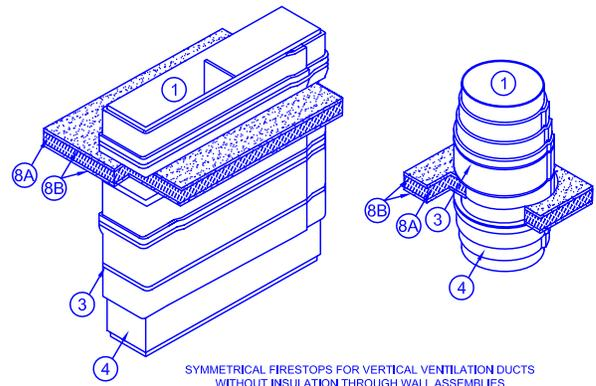

SYMMETRICAL FIRESTOPS FOR VERTICAL VENTILATION DUCTS WITHOUT INSULATION THROUGH WALL ASSEMBLIES

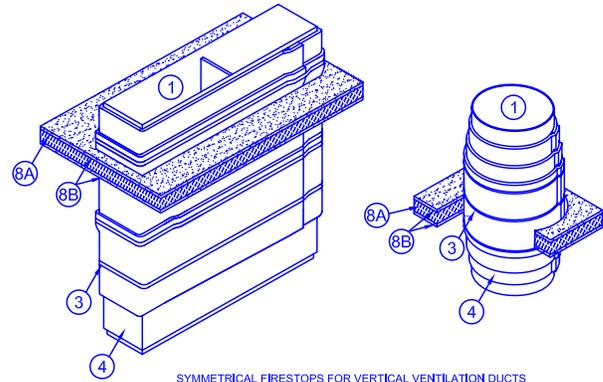

SYMMETRICAL FIRESTOPS FOR VERTICAL VENTILATION DUCTS WITH INSULATION THROUGH WALL ASSEMBLIES

Figure 7

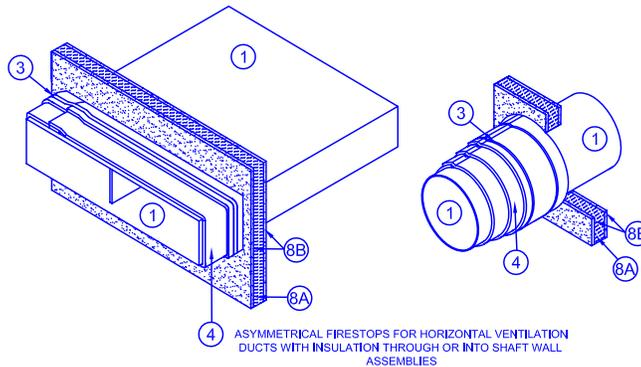

ASYMMETRICAL FIRESTOPS FOR HORIZONTAL VENTILATION DUCTS WITH INSULATION THROUGH OR INTO SHAFT WALL ASSEMBLIES

Figure 6

Table 3 – Fire Ratings for ONLY Figure 6: Asymmetrical Firestops for Horizontal Ventilation Ducts without Insulation Through or Into Shaft Assemblies

| All other Figures and Assemblage References are 2 Hour F-Rating & T Rating | | |
|--|------------------|------------------|
| Fire Exposure | F-Rating (Hours) | T-Rating (Hours) |
| “Uninsulated Side” Designation on Drawing | 2 | 2 |
| Insulated Side | 2 | 0 |

Design No. 3MU/DI 120-01 *continued*

8. PENETRATION FIRESTOP: Install firestop between the supporting construction (Item 6) and the ventilation duct (Item 1) or the ventilation duct (Item 1) protected with the insulation (Item 4). Use a symmetrical wall penetration firestop, an asymmetrical shaft penetration firestop, or an asymmetrical floor penetration firestop constructed of the following components:
- A. CERTIFIED MANUFACTURER: 3M Company
CERTIFIED PRODUCT: 3M™ Fire Barrier Duct Wrap Insulation
MODEL: 615 or 615+
PACKING MATERIAL: Fill the entire annular space's width and a min. depth of 4 in. with min. 4 pcf density mineral wool or certified insulation without the encapsulation (foil scrim). Cut the packing material into strips not less than one and one half (1-1/2) times the width of the annular space to be filled. Compress packing material nominally 33% and insert packing material into the annular space. For wall assemblies, recess the surface of packing material nominally 5/8 in. from surfaces of both faces of the supporting construction (Item 6). For floor and shaft wall assemblies, recess the surface of packing material nominally 5/8 in. from the visual surface of the supporting construction (Items 6).
 - B. CERTIFIED MANUFACTURER: 3M Company
CERTIFIED PRODUCT: 3M™ Fire Barrier™ Sealant
MODEL: Water-Tight 1000-NS Silicone, Water-Tight 1003-SL Silicone (floors only), 2000+ Silicone, or CP 25 WB+
FILL, VOID OR CAVITY MATERIAL: Install min. 5/8 in. depth of fill material into the recess over the entire surface of the packing material (Item 7A). Screed the fill material flush with the surface of the supporting construction (Item 6). Overlap a min. of 1/4 in., the fill material onto face of supporting construction (Item 6).
 - C. CERTIFIED MANUFACTURER: 3M Company
CERTIFIED PRODUCT: 3M™ Fire Barrier Duct Wrap Insulation
MODEL: 615 or 615+
 - D. COLLAR: Required for R4 ventilation ducts (Item 1) in Table 1. After the ventilation duct (Item 1) is covered with insulation (Item 4), install a collar, which is another layer of min. 24 in. wide, min. 6 pcf density, insulation (Item 4) over the insulated ventilation duct (Item 1) on each side of the supporting construction (Item 6). Match and use the same installation method as used to install the insulation (Item 4) applied to the ventilation duct (Item 1) creating two (2) layers of insulation (Item 4) on the ventilation duct (Item 1) adjacent to the supporting construction (Item 6). Abut one perimeter edge of each collar to the exposed surface supporting construction (Item 6).
 - E. STEEL ANGLE: Required for R4 ventilation ducts (Item 1) in Table 1. Before the ventilation duct (Item 1) is covered with insulation (Item 4) and after the packing material (Item 7A) and fill material (Item 7B) are installed, install a nominal 16 GA 2 x 1-1/2 in. steel angle around the perimeter of the ventilation duct (Item 1) with notched ends to create a continuous frame. Place the 1-1/2 in. leg of the steel angle flush against the surface of the supporting construction (Item 6). Attach the 2 in. leg of the steel angle to the ventilation duct (Item 1) using self drilling, 12-24x2 hex head, screws with a #5 point, spaced a max. of 6 in. oc.

This material was extracted and drawn by 3M Fire Protection Products from the 2015 Product Directory, © Intertek

Flexible Wraps

Duct Wrap

Ventilation Duct

DI

Design No. 3MU/DI 60-01

December 23, 2010

VENTILATION DUCT PROTECTION

3M Company

3M™ Fire Barrier™ Duct Wraps: 615 and 615+
 3M™ Fire Barrier™ Sealants: Water-Tight 1000-NS Silicone,
 Water-Tight 1003-SL Silicone (floors only),
 2000+ Silicone, and CP 25 WB+

ISO 6944 (1985) Duct A

Stability – 1 hr

Insulation – 1 hr

Integrity – 1 hr

ASTM E 814

F-Rating – 1 hr

T-Rating – 1 hr

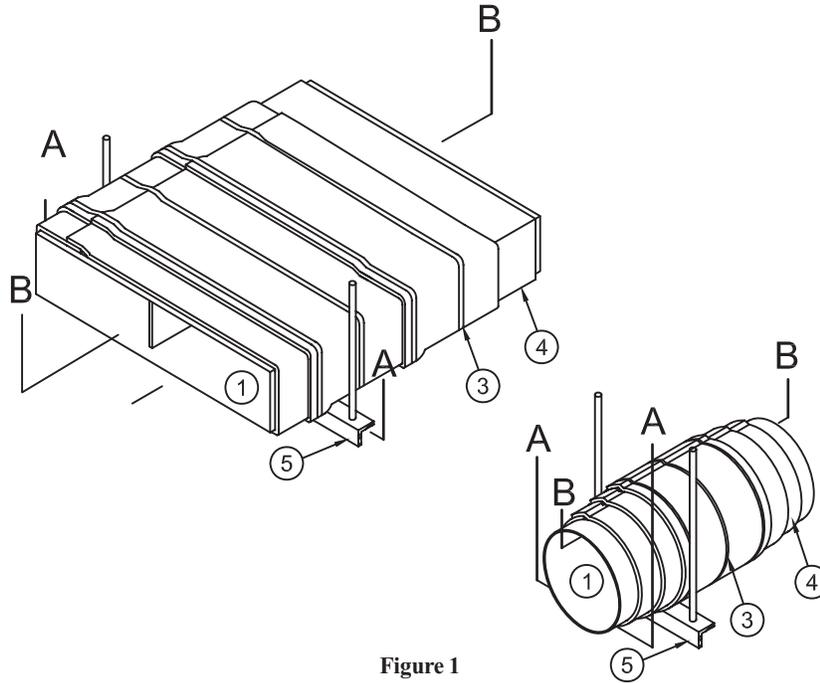

Figure 1

1. VENTILATION DUCT: Refer to Figure 1. Continuous, air-tight, rectangular or circular duct system with either horizontally or vertically oriented shafts constructed of sheet steel with a maximum area and a maximum dimension as referenced in the Table 1. When required, equip the ventilation duct with transition fittings, e.g. elbows, tees, reducers, etcetera.

| Ventilation Duct for Items 6, 7 & 8 References | Shape | Min Gauge | Max Dimension | Max Diameter | Max Area |
|--|-------------|-----------|---------------|--------------|----------|
| R1 | Rectangular | 26 | 12 | -- | 144 |
| R2 | Rectangular | 24 | 40 | -- | 400 |
| R3 | Rectangular | 22 | 60 | -- | 1440 |
| R4 | Rectangular | 22 | 85 | -- | 2040 |
| C1 | Circular | 20 | -- | 40 | 1257 |

- A. Construct the ventilation duct using sections affixed to each other with seams or flanges.
 - B. Reinforce the ventilation duct to IMC, SMACNA or NFPA 90A requirements designed to carry the weight of the ventilation duct assembly covered with insulation (Item 4) under a fire load equivalent to ASTM E 119 time-temperature curve.
 - C. Rigidly support the ventilation duct in accordance with IMC, SMACNA or NFPA 90A requirements designed to carry the weight of the ventilation duct assembly covered with insulation (Item 4) under a fire load equivalent to ASTM E 119 time-temperature curve or as specified in Item 5.
 - D. Protect the annular space around the ventilation duct passing through a fire rated wall assembly with an Intertek certified, compatible, 3M, penetration firestop system, refer to Section 8, having the same fire rating as the wall assembly.
2. FASTENERS: Refer to Figure 2. Weld minimum 12 GA, 4-1/2-inch long, copper-coated steel insulation pins or 12 GA insulated cup head pins to the ventilation duct (Item 1). Match fastener method with corresponding insulation (Item 4) method.
 - A. Compression Butt Joint: Refer to 4A Section View B-B. Locate pins at all blanket overlaps, on all sides of the ventilation duct (Item 1), and meet the following requirements.
 - I. Space pins maximum 12 inches apart in rows across the width of ventilation duct (Item 1). Locate pins maximum 6-3/4 inches from the edges of the rectangular ventilation duct (Item 1).

Design No. 3MU/DI 60-01 *continued*

Flexible Wraps

Duct Wrap

Ventilation Duct

DI

- II. Space the rows of pins maximum 9-1/2 inches apart along the length ventilation duct (Item 1). Where pieces of insulation (Item 4A) are to be butted together, space the pins a maximum of 2 inches apart.
 - III. After insulation (Item 4A) is installed, place minimum 2.5 in. x 2.5 in. square, galvanized steel, self locking washer clips onto all insulation pins.
 - IV. After clips are installed, cut off or bend flush with insulation (Item 4) the pins that are too long.
- B. Butt Joint with Collar: Refer to 4B Section View B-B. Locate pins at all blanket overlaps, on all sides of the ventilation duct (Item 1), and meet the following requirements.
- I. Space pins maximum 12 inches apart in rows around the circumference for circular ventilation ducts (Item 1) or on all sides for rectangular ventilation ducts (Item 1). For rectangular ventilation ducts (Item 1), locate pins maximum 6-3/4 inches from the edges.
 - II. Space the rows of pins maximum 9 inches apart along the length ventilation duct (Item 1). Where pieces of insulation (Item 4B) are to be butted together, space pins a maximum of 3 inches apart.
 - III. After insulation (Item 4B) is installed, place minimum 2.5 in. x 2.5 in. square, galvanized steel, self locking washer clips onto all insulation pins.
 - IV. After clips are installed, cut off or bend flush with insulation (Item 4B) the pins that are too long.
- C. Single End Overlap (Telescope): Refer to 4C Section View B-B. Locate pins at all blanket overlaps, on all sides of the ventilation duct (Item 1), and meet the following requirements.
- I. Space pins maximum 12 inches apart in rows across the width of ventilation duct (Item 1). Locate pins maximum 6-3/4 inches from the edges of the rectangular ventilation duct (Item 1).
 - II. Space the rows of pins maximum 10-1/2 inches apart along the length ventilation duct (Item 1). Where pieces of insulation (Item 4C) are to be butted together, space the pins a maximum 1-1/2 inches apart.
 - III. After insulation (Item 4C) is installed, place minimum 2.5 in. x 2.5 in. square, galvanized steel, self locking washer clips onto all insulation pins.
 - IV. After clips are installed, cut off or bend flush with insulation (Item 4C) the pins that are too long.
- D. Dual End Overlap (Checkerboard): Refer to 4D Section View B-B. Locate pins at all blanket overlaps, on all sides of the ventilation duct (Item 1), and meet the following requirements.
- I. Space pins maximum 12 inches apart in rows across the width of ventilation duct (Item 1). Locate pins maximum 6-3/4 inches from the edges of the rectangular ventilation duct (Item 1).
 - II. Space the rows of pins maximum 10-1/2 inches apart along the length ventilation duct (Item 1). Where pieces of insulation (Item 4D) are to be butted together, space the pins a maximum of 1-1/2 inches apart.
 - III. After insulation (Item 4D) is installed, place minimum 2.5 in. x 2.5 in. square, galvanized steel, self locking washer clips onto all insulation pins.
 - IV. After clips are installed, cut off or bend flush with insulation (Item 4D) the pins that are too long.
3. BANDING: Do not use banding for the installation of insulation method (Item 4A), Compression Butt Joint. Banding is an option to fastener methods (Items 2B, 2C and 2D) but not fastener method (Item 2A). After insulation (Item 4) is installed, apply minimum 1/2 inch wide, 0.015-inch thick stainless steel bands or minimum 1/2 inch wide, 0.020-inch thick carbon steel bands and secured with minimum 1-inch long stainless or carbon steel crimp clamps to be used with corresponding banding type. When needed to ease installation, use filament tape as a temporary hold for the insulation (Item 4) prior to banding. Place banding a maximum 1-1/2 inches from all insulation (Item 4) edges and a maximum of 10-1/2 inches on center (O.C.). Tension the banding to hold the insulation (Item 4) in place without cutting or damaging the insulation (Item 4) or ventilation duct (Item 1).

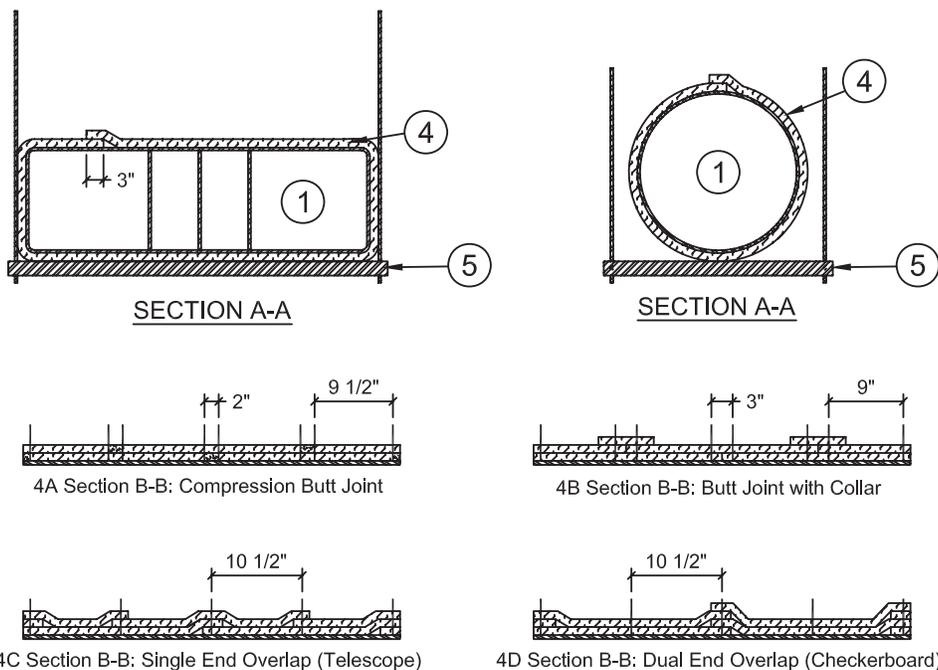

Figure 2

Design No. 3MU/DI 60-01 *continued*

4. CERTIFIED MANUFACTURER: 3M Company
CERTIFIED PRODUCT: 3M™ Fire Barrier Duct Wrap
MODEL: 615 or 615+

INSULATION: Refer to Figure 2. Apply one layer of nominal 1-1/2 in. thick, 6-pcf blanket, made of fibers, encapsulated with foil scrim over the entire surface of the ventilation duct (Item 1) and a collar on each side of the penetration firestop (Item 1D). Apply the insulation in accord with one of the four methods (A, B, C, or D) that follow. Use blanket that is encapsulated with a polypropylene/foil scrim or an aluminized polyester/scrim/foil. Wrap one layer of insulation around the ventilation duct (Item 1) perimeter so that each terminating end of insulation overlaps onto the starting end of insulation a minimum of 3 inches at all transverse joints. Alternate the transverse overlap location so that no two consecutive adjacent overlaps align. Refer to Section View A-A for transverse overlap section view. Cover and seal all visually exposed ends and edges of insulation with nominal 4-inch wide pressure-sensitive aluminum foil tape.

- A. **Compression Butt Joint:** Refer to 4A Section View B-B. Wrap the ventilation duct (Item 1) with one layer of insulation installed with compression butt joints at all longitudinal joints. Compress each end of each piece of insulation together and butt to preceding edge of insulation. Each piece of installed insulation width is 2 inches less than insulation nominal width. (Example: each piece of nominal 24-inch wide insulation when installed is 22-inches wide.) Install the insulation overlap in contact (pressed against) with the insulation being overlapped. Verify all insulation butt joints are a minimum 1-1/2 inches in overall thickness at compression butt joints.
- B. **Butt Joint with Collar:** Refer to 4B Section View B-B. Wrap the ventilation duct (Item 1) with one layer of insulation installed with butt joints at all longitudinal joints. Butt each end of each piece of insulation together with preceding edge of insulation. Each piece of installed insulation width is its nominal width. (Example: each piece of nominal 24-inch wide insulation when installed is 24-inches wide.) Install the insulation overlap in contact (pressed against) with the insulation being overlapped. Place and center 6-inch wide collar of insulation over the butt joint. Overlap 6-inch wide collar onto each adjacent insulation 3-inches. Verify all insulation butt joints with collars are a minimum 3 inches in overall thickness.
- C. **Single End Overlap (Telescope):** Refer to 4C Section View B-B. Wrap the ventilation duct (Item 1) with one layer of insulation installed with 3-inch minimum overlaps at all longitudinal joints. Overlap each adjacent insulation edge with the edge of the next piece of insulation. Install the insulation overlap in contact (pressed against) with the insulation being overlapped. Verify all insulation overlaps are nominally 3 inches in overall thickness.
- I. Starting at one end of the ventilation duct (Item 1), apply the first piece of insulation around the ventilation duct (Item 1) to overlap fasteners (Item 2C). Refer section view A-A.
- II. Position and overlap the leading edge of the second piece of insulation nominally 3 inches over the flush edge of the first piece of insulation. Place the opposite edge of the second piece of insulation flush against the surface of the ventilation duct (Item 1). An “S-shaped” cross section of the insulation is created. Refer to 4C section view B-B.
- III. Apply all additional pieces of insulation as “S-shaped” cross section of the insulation in compliance with Item 4CII.
- D. **Dual End Overlap (Checkerboard):** Refer to 4D Section View B-B. Verify all insulation overlaps are a minimum 3 inches in overall thickness. Do not align two consecutive insulation end overlaps. Overlap each full-width insulation edge with the edge of the “Gull Wing”, “U” shaped insulation. Install the insulation overlap in contact (pressed against) with the insulation being overlapped. Verify all insulation overlaps are nominally 3 inches in overall thickness.
- I. Wrap the first piece of insulation around the ventilation duct (Item 1) so that the insulation is flush against the surface of the ventilation duct (Item 1). Position the starting end of the insulation to overlap pins (Item 2A) a minimum of 1-1/2 inches while the edges of the insulation overlap the rows of pins (Item 2B) a minimum of 1-1/2 inches.
- II. Position the second piece of insulation nominally 18 inches from the edge of the first piece of insulation. Install the second piece in the same manner as the first.
- III. Cover the ventilation duct (Item 1) that is exposed between the edges of the first two pieces of insulation with another piece of insulation. Position the starting end of the insulation to overlap pins (Item 2A) a minimum of 1-1/2 inches while the edges of the insulation overlap the adjacent edges of the two pieces installed insulation a minimum of 1-1/2 inches.
5. **SUPPORTS:** Support the ventilation duct (Item 1) with insulation (Item 4) using a “trapeze” system composed of a minimum 2 x 2 x 1/4-inch steel angle as the trapeze cross-member and minimum 3/8-inch diameter rods. Connect all-thread steel rods (insulation (Item 4) not required) to the trapeze cross-member using nuts and washers. Connect the all-thread steel rods to the bottom of the floor assembly using an attachment method designed to carry the weight of the ventilation duct (Item 1) with insulation (Item 4) under a fire load equivalent to ASTM E119 time-temperature curve. Center ventilation duct (Item 1) with insulation (Item 4) on trapeze cross-member. Space all-thread steel rods a maximum distance of 6 inches from surface of the insulated ventilation duct or allowing all-thread steel rods to contact with the insulation (Item 4) at the minimum distance. Extend trapeze cross-member at least 2-inches past each all-thread steel rod. Space trapeze supports a maximum 60-inches O.C.

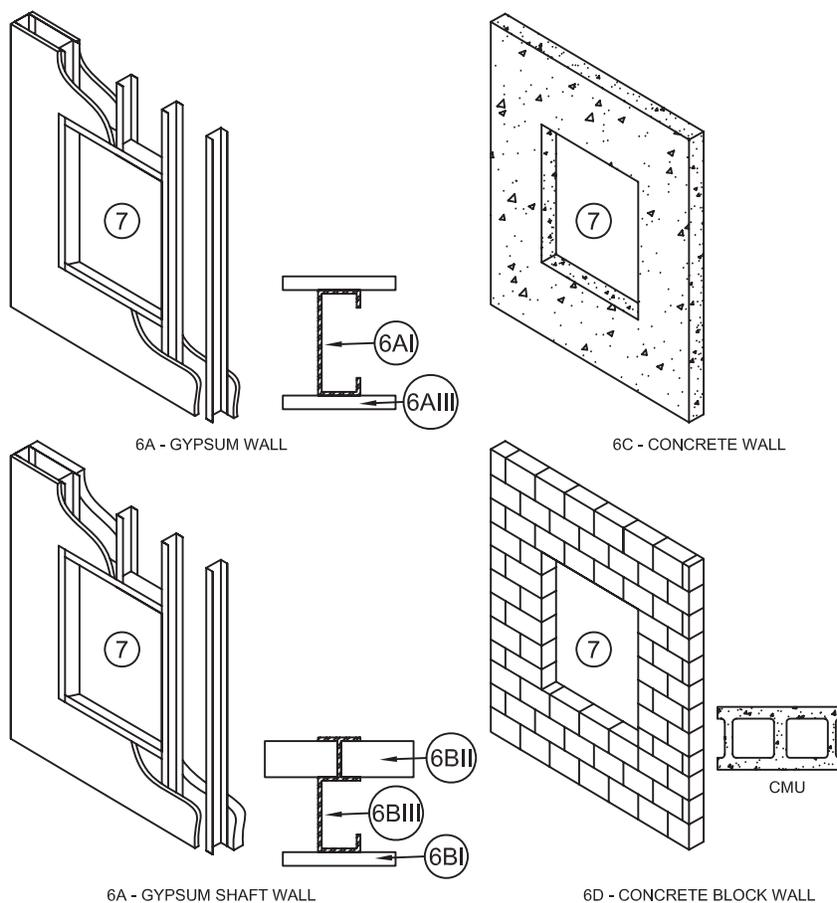

Figure 3

6. SUPPORTING CONSTRUCTION: Refer to Figures 3 and 4. Use one of the following wall or floor assemblies.

A. GYPSUM WALL ASSEMBLY: Symmetrical one-hour rated gypsum wall assembly, which may also be used as a shaft wall assembly, constructed of the following:

- I. Steel Studs – Minimum 25 GA galvanized steel studs measuring 3-5/8 inch wide with 1-1/4-inch legs spaced maximum 24 inch on center (O.C.). Attach studs with minimum #6 x 3/8-inch steel stud framing screws to floor and ceiling tracks.
- II. Tracks – Channel U-shaped floor and ceiling runners measuring 1/2-inch deep by 3-5/8-inch wide, which are secured to floor and ceiling with 1-inch long fasteners suitable for the mounting to substrate and spaced maximum 18-inch O.C.
- III. Gypsum Board – Cover studs and runners with one layer of 5/8 inch thick, Type X gypsum board on each face. Fasten the layer of gypsum board to steel studs with #6 1-1/8 inch bugle head phillips drywall screws spaced maximum 8 inch O.C. Apply vinyl or casein, dry or premixed joint compound to face layers of gypsum board in two coats to all exposed screw heads and gypsum board joints. Embed minimum 2 inch wide paper, plastic or fiberglass tape in first layer of joint compound over joints in gypsum board. Minimum wall assembly thickness of 4-3/4 inches measured from face layer of gypsum board to opposite face layer of gypsum board.

B. SHAFT WALL ASSEMBLY: Asymmetrical one-hour rated gypsum shaft wall assembly constructed of the following:

- I. Visual Gypsum Board – Cover studs and runners with one layer of minimum 5/8 inch thick, Type X gypsum board on each face. Fasten gypsum board to steel studs with #6 1-5/8 inch bugle head phillips drywall screws spaced maximum 8 inch O.C. Apply vinyl or casein, dry or premixed joint compound to face layers of gypsum board in two coats to all exposed screw heads and gypsum board joints. Embed minimum 2 inch wide paper, plastic or fiberglass tape in first layer of joint compound over joints in gypsum board. Minimum wall assembly thickness of 6 inches measured from face layer of gypsum board to opposite face layer of gypsum board.
- II. Interior Gypsum Board – Cut 1-inch thick Type X gypsum board 1-inch less than floor to ceiling height. Insert the longitudinal edges of the 1-inch thick Type X gypsum board into the C-T or C-H studs. Secure the transverse edge of the 1-inch thick Type X gypsum board to the long leg of J-runner using its tabs or minimum 1-5/8-inch long Type S self-tapping bugle head steel screws spaced maximum 12 inches on center.
- III. Steel Studs – Cut minimum 25 GA galvanized steel C-T or C-H studs measuring minimum 2-1/2 inches wide with minimum 1-1/2-inch flanges 3/4-inch less than floor to ceiling height and spaced maximum 24 inch on center (O.C.) in runners with T or H section abutting long leg of runner.
- IV. Runners – Use minimum 2-1/2-inch wide J-runner compatible with studs and having unequal vertical legs: minimum 1-inch short leg and minimum 2-inch long leg. Position J-runners with short leg towards visual face of shaft wall. Attach to floor and ceiling using steel fasteners located a maximum of 2-inches from each end and a maximum of 24 inch O.C.

Design No. 3MU/DI 60-01 *continued*

- C. **CONCRETE WALL ASSEMBLY:** Symmetrical, one-hour rated, solid concrete, wall assembly made from reinforced lightweight or normal weight (100-150 pcf or 1600-2400 kg/m³) concrete, which may also be used as a shaft wall assembly. Constructed of solid concrete with a minimum concrete thickness measured from exposed face to exposed face using one of the following:
 - I. lightweight concrete is 3.6 inches;
 - II. sand-lightweight concrete is 3.8 inches;
 - III. carbonate aggregate concrete is 4.6 inches; and
 - IV. siliceous aggregate concrete is 5.0 inches.
- D. **MASONRY WALL ASSEMBLY:** Symmetrical, minimum one-hour rated, nominal 8 x 8 x 16 CMU, wall assembly made from lightweight or normal weight (100-150 pcf or 1600-2400 kg/m³) concrete, which may also be used as a shaft wall assembly.

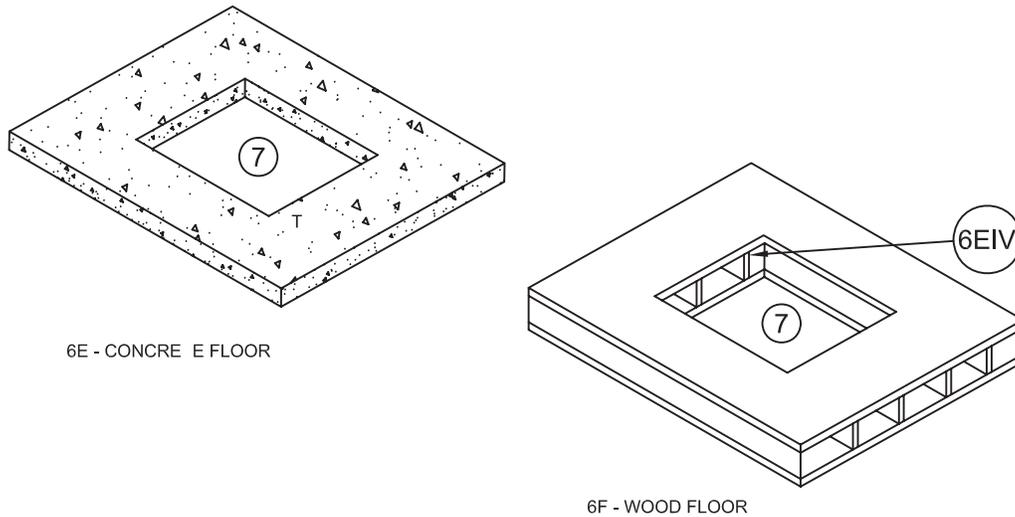
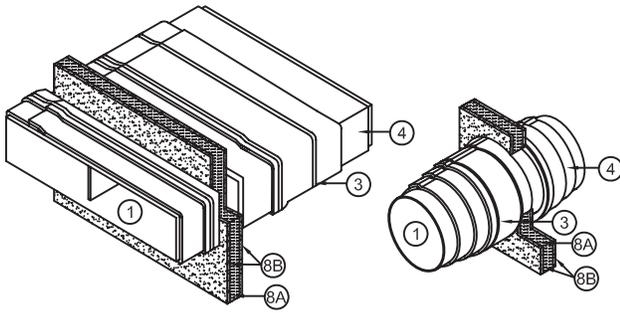

Figure 4

- E. **CONCRETE FLOOR ASSEMBLY:** Symmetrical one-hour rated solid concrete floor assembly made from reinforced lightweight or normal weight (100-150 pcf or 1600-2400 kg/m³) concrete. Constructed of solid concrete with a minimum concrete thickness measured from exposed face to exposed face using one of the following:
 - I. lightweight concrete is 3.6 inches;
 - II. sand-lightweight concrete is 3.8 inches;
 - III. carbonate aggregate concrete is 4.6 inches; and
 - IV. siliceous aggregate concrete is 5.0 inches.
- F. **WOOD FLOOR ASSEMBLY:** Asymmetrical ASTM E 119 (UL 263 or NFPA 251) one-hour fire-rated floor assembly having the following components as part of its construction:
 - I. Joists – Minimum 2 x 10 wood joists spaced a maximum 18-1/2 inches on center (OC).
 - II. Flooring – Minimum 3/4-inch thick plywood attached to the top of wood joists.
 - III. Gypsum Board – Minimum one layer of 5/8-inch thick, Type X, gypsum board attached to the bottom of wood joists with minimum #8, 1-5/8-inch long, bugle head screws.
 - IV. Reinforcement – When the opening (Item 6G) penetrates the joists, additional 2 x 10 solid wood perimeter framing is required to maintain the floor assembly's strength at that location.
- 7. **OPENING:** – Refer to Figures 3 and 4. Create an opening in the supporting construction (wall or floor assembly). Determine the opening shape and size to house the ventilation duct's (Item 1), whether with or without insulation (item 4) passing through the opening, shape and size. Position the penetrating item (Item 1) concentrically or eccentrically in the opening so that the annular space ranges from minimum to maximum as in Table 2. Make the opening with in accord with the following:
 - A. For gypsum wall assemblies (Item 6A) and shaft wall assemblies (Item 6B), frame the opening with steel studs (Item 6AI) and tracks (Item 6AII).

| Table 2 Opening Information | | | | |
|--|--|-----------------------|-----------------|-----------------|
| Ventilation Duct Requirements Refer to Table 1 | Maximum | | Annular space | |
| | Cross Sectional Area (inches ²) | Dimension (inches) | Min (inches) | Max (inches) |
| R1 | 506 | 22.5 | 1 | 3-1/2 |
| R2 | 1035 | 50.5 | 1 | 3-1/2 |
| R3 | 2432 | 70.5 | 1 | 3-1/2 |
| R4 | 2492 | 89 | 1 | 3 |
| C1 | 1555 | 44.5 | 1 | 3-1/2 |



SYMMETRICAL FIRESTOPS FOR HORIZONTAL VENTILATION DUCTS WITHOUT INSULATION THROUGH WALL ASSEMBLIES

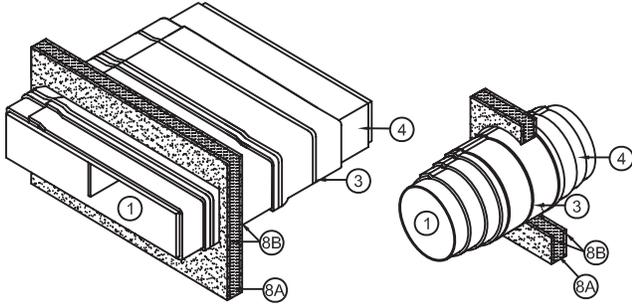

SYMMETRICAL FIRESTOPS FOR HORIZONTAL VENTILATION DUCTS WITH INSULATION THROUGH WALL ASSEMBLIES

Figure 5

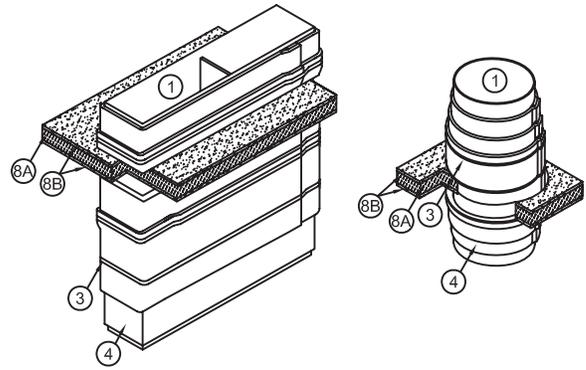

SYMMETRICAL FIRESTOPS FOR VERTICAL VENTILATION DUCTS WITHOUT INSULATION THROUGH WALL ASSEMBLIES

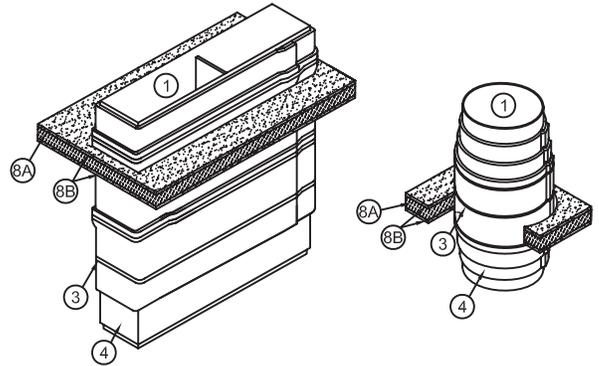

SYMMETRICAL FIRESTOPS FOR VERTICAL VENTILATION DUCTS WITH INSULATION THROUGH WALL ASSEMBLIES

Figure 7

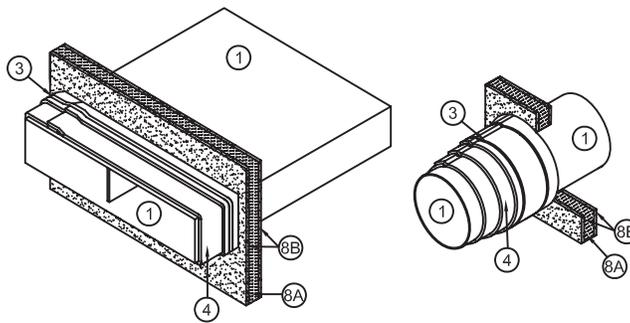

ASYMMETRICAL FIRESTOPS FOR HORIZONTAL VENTILATION DUCTS WITH INSULATION THROUGH OR INTO SHAFT WALL ASSEMBLIES

Figure 6

Table 3 – Fire Ratings for ONLY Figure 6: *Asymmetrical Firestops for Horizontal Ventilation Ducts without Insulation Through or Into Shaft Assemblies*

All other Figures and Assemblage References are 1 Hour F-Rating & T Rating

| Fire Exposure | F-Rating (Hours) | T-Rating (Hours) |
|---|------------------|------------------|
| “Uninsulated Side” Designation on Drawing | 1 | 1 |
| “Insulated Side” | 1 | 1 |

Design No. 3MU/DI 60-01 *continued*

8. PENETRATION FIRESTOP: The following firestop assemblies have be firestop between the supporting construction (Item 6) and the ventilation duct (Item 1) or the ventilation duct (Item 1) protected with the insulation (Item 4). Use a symmetrical wall penetration firestop, an asymmetrical shaft penetration firestop, or an asymmetrical floor penetration firestop constructed of the following components:
- A. CERTIFIED MANUFACTURER: 3M Company
CERTIFIED PRODUCT: 3M™ Fire Barrier Duct Wrap Insulation
MODEL: 615 or 615+
PACKING MATERIAL: Fill the entire annular space's width and a minimum depth of 4-inches with minimum 4-pcf density mineral wool or certified insulation without the encapsulation (foil scrim).
Cut the packing material into strips not less than one and one half (1-1/2) times the width of the annular space to be filled. Compress packing material nominally 33% and insert packing material into the annual space.
For wall assemblies, recess the surface of packing material nominally 5/8 inches from surfaces of both faces of the supporting construction (Item 6).
For floor and shaft wall assemblies, recess the surface of packing material nominally 5/8 inches from the visual surface of the supporting construction (Items 6).
- B. CERTIFIED MANUFACTURER: 3M Company
CERTIFIED PRODUCT: 3M™ Fire Barrier™ Sealant
MODEL: Water-Tight 1000-NS Silicone, Water-Tight 1003-SL Silicone (floors only), 2000+ Silicone, or CP 25 WB+
FILL, VOID OR CAVITY MATERIAL: Install minimum 5/8-inch depth of fill material into the recess over the entire surface of the packing material (Item 7A). Screenshot the fill material flush with the surface of the supporting construction (Item 6). Overlap a minimum of 1/4 inches, the fill material onto face of supporting construction (Item 6).
- C. CERTIFIED MANUFACTURER: 3M Company
CERTIFIED PRODUCT: 3M™ Fire Barrier Duct Wrap Insulation
MODEL: 615 or 615+
- D. COLLAR: Required for R4 ventilation ducts (Item 1) in Table 1. After the ventilation duct (Item 1) is covered with insulation (Item 4), install a collar, which is another layer of minimum 24-inch wide, minimum 6-pcf density, insulation (Item 4) over the insulated ventilation duct (Item 1) on each side of the supporting construction (Item 6). Match and use the same installation method as used to install the insulation (Item 4) applied to the ventilation duct (Item 1) creating two (2) layers of insulation (Item 4) on the ventilation duct (Item 1) adjacent to the supporting construction (Item 6). Abut one perimeter edge of each collar to the exposed surface supporting construction (Item 6).
- E. STEEL ANGLE: Required for R4 ventilation ducts (Item 1) in Table 1. Before the ventilation duct (Item 1) is covered with insulation (Item 4) and after the packing material (Item 7A) and fill material (Item 7B) are installed, install a nominal 16 GA 2 x 1-1/2-inch steel angle around the perimeter of the ventilation duct (Item 1) with notched ends to create a continuous frame. Place the 1-1/2-inch leg of the steel angle flush against the surface of the supporting construction (Item 6). Attach the 2-inch leg of the steel angle to the ventilation duct (Item 1) using self drilling, 12-24x2 hex head, screws with a #5 point, spaced a maximum of 6 inches on center.

Assembly No. V-20

February 16, 2010

Duct A

Fire Resistance Rating – 2 Hr

(Ratings applicable for Ventilation Ducts installed with or without branches)

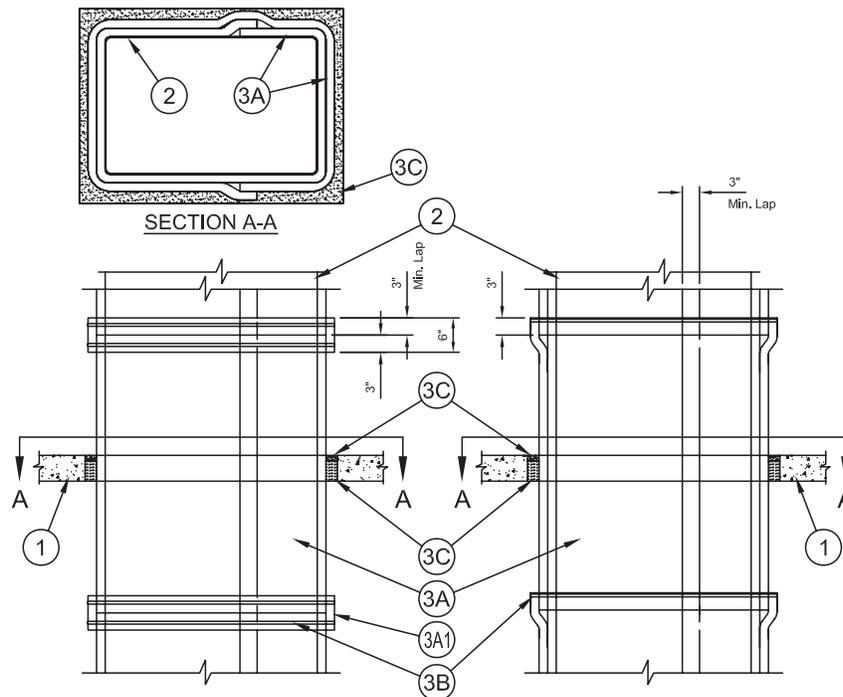

1. **Floor or Wall Assembly** – Min 4-1/2 in. (114 mm) thick reinforced lightweight or normal weight (100-150 pcf or 1600-2400 kg/m³) concrete floor or min 5-1/4 in. (133 mm) thick reinforced lightweight or normal weight concrete wall. Wall may also be constructed of any UL Classified **Concrete Blocks**.
See **Concrete Blocks** (CAZT) category in the Fire Resistance Directory for names of manufacturers.
2. **Steel Air Duct** – Min 0.035 in. (0.9 mm) thick (or heavier) steel duct having a max perimeter of 168 in. (1.52 m) with max individual dimension of 60 in. (1.52 m) and constructed in accordance with SMACNA HVAC Duct Construction standards. The sections shall be assembled using bolted flanges or SMACNA approved Transverse Joint Reinforcements. Duct to be rigidly supported in accordance with SMACNA requirement and as specified in Item 4.
3. **Fire Resistive System** – The fire resistive system shall consist of the following:
 - A. **Batts and Blankets*** – Min 1-1/2 in. (38 mm) thick, totally encapsulated within foil-scrim facers. The steel duct shall be wrapped with two layers of duct wrap installed with 3 in. (76 mm) transverse and longitudinal overlaps, or tightly butted transverse joints, in accordance with the manufacturer's installation instructions. All cut edges and ends shall be sealed with 3 in. (76 mm) wide pressure sensitive aluminum foil tape.
3M COMPANY – 3M FireBarrier Duct Wrap 15A, 3M FireBarrier Duct Wrap 20A, 3M FireBarrier Duct Wrap 615 or 3M FireBarrier Duct Wrap 615+
 - A1. **Batts and Blankets* – Collars** – Min 1-1/2 in. (38 mm) thick, 6 in. (152 mm) wide collars, totally encapsulated within foil-scrim facers. The transverse butt joints shall be wrapped using a collar. The collar shall be centered over each butt joint with a 3 in. (76 mm) longitudinal overlap.
3M COMPANY – 3M FireBarrier Duct Wrap 15A Collars, 3M FireBarrier Duct Wrap 20A Collars, 3M FireBarrier Duct Wrap 615 Collars or 3M FireBarrier Duct Wrap 615+ Collars
 - B. **Steel Banding Straps** – Min 1/2 in. (13 mm) wide by 0.015 in. (0.4 mm) thick stainless steel banding straps used in conjunction with min 1 in. (25 mm) long stainless steel crimp clips. Banding straps spaced a max 12 in. (305 mm) OC and 1-1/2 in. (38 mm) from edges of collars.
 - B1. **Steel Pins** (Not shown) – Min 0.118 in. (3 mm) thick, 4 in. (102 mm) long copper coated steel insulation pins used in conjunction with 1 by 1 in. (25 by 25 mm) square 0.020 in. (0.5 mm) thick, galvanized steel speed clips. Pins spaced max 10 in. (254 mm) max, transversely around the duct and secured to the duct wrap in accordance with the manufacturers installation instructions.
 - C. **Firestop System** – When the ventilation duct passes through a fire rated wall or floor assembly, the through openings shall be firestopped in accordance with Through-Penetration System No. C-AJ-7096. See Through-Penetration Firestop Systems in Vol. 2 of the Fire Resistance Directory.
4. **Hanger System** – (Not shown)–No additional protection is required for hanger systems providing that a min 1/2 in. (13 mm) diameter threaded steel hanger rod is used in conjunction with min 3 by 3 by 3/8 in. (76 by 76 by 10 mm) steel angle with steel drop in or wedge expansion type masonry anchors.

*Bearing the UL Classification Mark

Reprinted from the Online Certifications Directory with permission from Underwriters Laboratories Inc.

Copyright © 2010 Underwriters Laboratories Inc.®

Assembly No. V-27

February 16, 2010

Duct A

Fire Resistance Rating – 1 or 2 Hr

(Ratings applicable for Ventilation Ducts installed with or without branches)

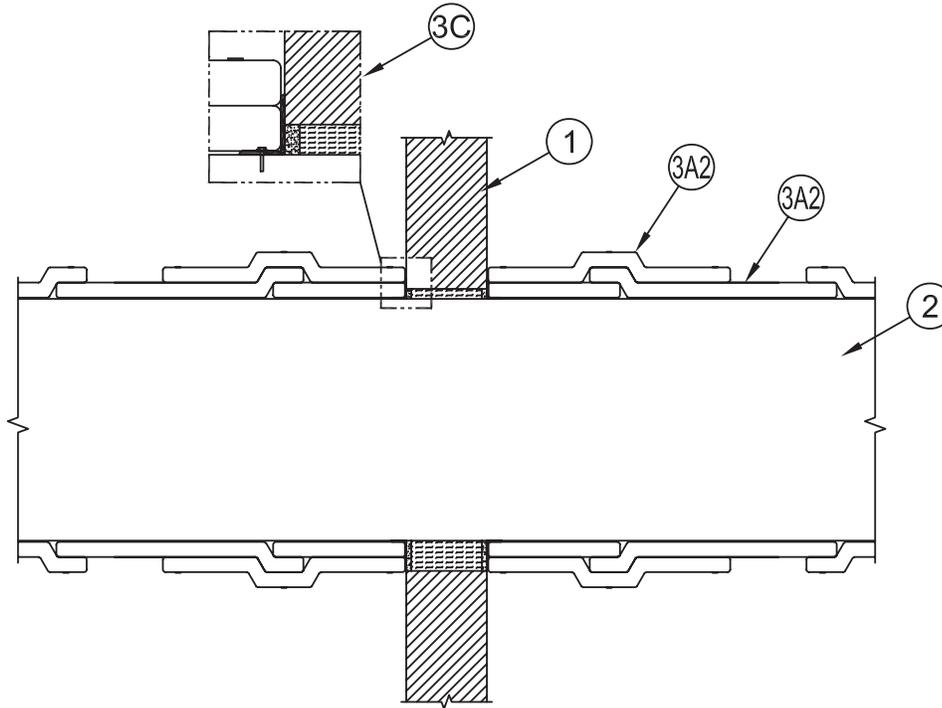

1. Wall or Floor Assembly –

A. **Masonry Wall** – Min 7-1/2 in. (190 mm) thick reinforced lightweight or normal weight concrete wall. Wall may also be constructed of any UL Classified **Concrete Blocks**.

OR

B. **Gypsum Board Wall Assembly** – The 2 hr fire-rated gypsum board/stud wall assembly shall be constructed of the materials and in the manner specified in the individual U400 or V400 Series Wall and Partition Designs in the UL Fire Resistance Directory and shall include the following construction features:

B1. **Studs** – Wall framing shall consist of steel “C” studs min 3-5/8 in. (92 mm) wide and spaced max 24 in. (610 mm) OC. Additional framing members shall be used to completely frame around opening.

B2. **Gypsum Board*** – Min 5/8 in. (15.9 mm) thick, 4 ft (1220 mm) wide with square or tapered edges as specified in the individual U400 or V400 Wall and Partition Design.

See **Gypsum Board** (CKNX) category in the Fire Resistance Directory for names of manufacturers.

OR

C. **Floor-Ceiling Assembly** – The 1 hr fire-rated solid wood joist floor-ceiling assembly shall be constructed of the materials and in the manner described in the individual L500 Series Design in the UL Fire Resistance Directory. The general construction features of the floor-ceiling assembly are summarized below:

C1. **Flooring System** – Lumber or plywood subfloor with finish floor as specified in the individual Floor-Ceiling Design.

C2. **Wood Joists** – Nom 10 in. (240 mm) deep (or deeper) wood joists with bridging as required and with ends firestopped. Opening to be framed on all 4 sides with sections of solid wood joist.

C3. **Gypsum Board*** – Thickness, type, number of layers and fasteners shall be as specified in individual Floor-Ceiling Design.

See **Concrete Blocks** (CAZT) category in the Fire Resistance Directory for names of manufacturers.

2. **Steel Air Duct** – Min 0.030 in. (0.76 mm) thick (or heavier) steel duct having a max perimeter of 218 in. (5.54 m) with max individual dimension of 85 in. (2.16 m) and constructed in accordance with SMACNA HVAC Duct Construction Standards - Metal and Flexible. The sections shall be assembled using bolted flanges or SMACNA approved Transverse Joint Reinforcements. Duct to be rigidly supported in accordance with SMACNA requirement and as specified in Item 4.

3. **Fire Resistive System** – The fire resistive system shall consist of the following:

A1. **Batts and Blankets*** – Min 1-1/2 in. (38 mm) thick, totally encapsulated within foil-scrim facers. The steel duct shall be wrapped with one layer of duct wrap installed in a telescope, checkerboard or butt-joint-and-collar pattern with 3 in. (76 mm) transverse and longitudinal overlaps, in accordance with the manufacturer’s installation instructions. All cut edges and ends shall be sealed with 3 in. (76 mm) wide pressure sensitive aluminum foil tape.

3M COMPANY

3M FIRE PROTECTION PRODUCTS – 3M FireBarrier Duct Wrap 615 or 3M FireBarrier Duct Wrap 615+

Flexible Wraps

Duct Wrap

Ventilation Duct

V

Assembly No. V-27 continued

A2. **Batts and Blankets*** – **Collars** – Min 1-1/2 in. (38 mm) thick, 6 in. (152 mm) wide collars, totally encapsulated within foil-scrim facers. The transverse butt joints shall be wrapped using a collar. The collar shall be centered over each butt joint with a 3 in. (76 mm) longitudinal overlap.

3M COMPANY

3M FIRE PROTECTION PRODUCTS – 3M FireBarrier Duct Wrap 615 Collars or 3M FireBarrier Duct Wrap 615+Collars

B1. **Steel Banding Straps** (Not shown) – Min 1/2 in. (13 mm) wide by 0.015 in. (0.4 mm) thick stainless steel banding straps used in conjunction with min 1 in. (25 mm) long stainless steel crimp clips. Banding straps spaced a max 12 in. (305 mm) OC and 1-1/2 in. (38 mm) from edges of collars.

B2. **Steel Pins** (Not shown) – Min 0.118 in. (3 mm) thick, 6 in. (150 mm) long copper coated steel insulation pins used in conjunction with 2-1/2 by 2-1/2 in. (63 by 63 mm) square 0.020 in. (0.5 mm) thick, galvanized steel speed clips. Pins spaced 12 in. max transversely and 10-1/2 in. (267 mm) max lengthwise along the ends and bottom of the duct and secured to the duct wrap in accordance with the manufacturers installation instructions.

C. **Firestop System** – When the ventilation duct passes through a fire separation, the through openings shall be firestopped in accordance with Through-Penetration System No. W-J-7104 (masonry wall), W-L-7180 (gypsum board wall) or F-C-7054 (combustible floor-ceiling). See Through-Penetration Firestop Systems in Vol. 2 of the Fire Resistance Directory.

4. **Support Rod** – Steel threaded rod, nominal minimum diameter as shown in the table below, mounted to concrete floor by passing through pre-drilled hole and bolting with nut and washer on top of floor, or or with steel drop-in or wedge expansion type concrete anchors sized as follows:

| Load carried by each rod | Minimum rod diameter | Minimum embedment, drop-in anchor | Minimum embedment, wedge anchor |
|--------------------------|----------------------|-----------------------------------|---------------------------------|
| 55 lb or less | 3/8 in. | 1-5/8 in. | 1-1/2 in. |
| Over 55 lb to 95 lb | 1/2 in. | 2 in. | 2-1/4 in. |

5. **Cradle** – Steel angle, 75 mm by 75 mm by 6.3 mm, used to support wrapped duct at 1500 mm OC maximum. Hung from concrete floor with Support Rods (Item 4).

For ducts not exceeding 1525 mm in width, steel angle 51 mm by 51 mm by 4.8 mm or Unistrut P5500 channel can be used.

*Bearing the UL Classification Mark

Reprinted from the Online Certifications Directory with permission from Underwriters Laboratories Inc.
Copyright © 2010 Underwriters Laboratories Inc.®

Flexible Wraps

Duct Wrap

Ventilation Duct

V

Assembly No. V-31

November 14, 2012

Duct A

Fire-resistance rating – 2 hr

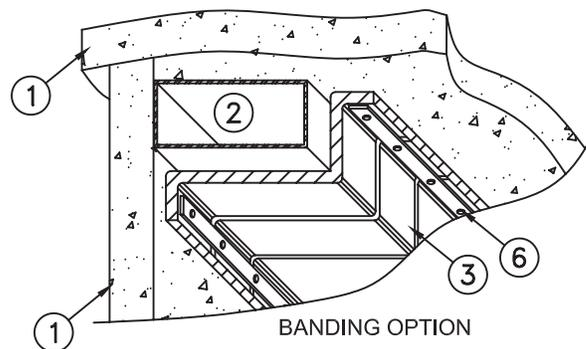
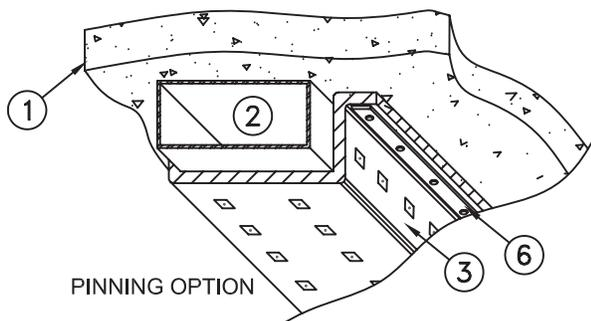
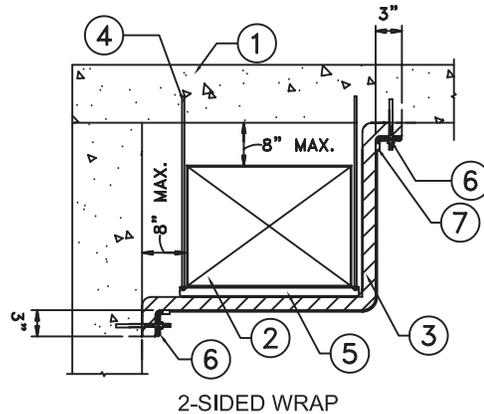
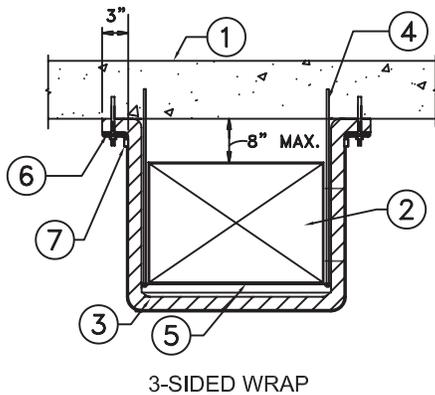

1. Wall or Floor Assembly –

- A. **Floor or Wall Assembly** – Min 4-1/2 in. thick reinforced lightweight or normal weight (100-150 pcf) concrete floor or wall. Wall may also be constructed of any **UL Classified Concrete Block***.

See **Concrete Blocks (CAZT)** category in the Fire Resistance Directory for names of manufacturers.

OR

- B. **Gypsum Board Wall Assembly** – The 2 hr fire-rated gypsum board/stud wall assembly shall be constructed of the materials and in the manner specified in the individual U400 or V400 Series Wall and Partition Designs in the UL Fire Resistance Directory and shall include the following construction features:

- B1. **Studs** – Wall framing shall consist of steel “C” studs min 3-5/8 in. (92 mm) wide and spaced max 24 in. (610 mm) OC or min. 2 in. by 4 in. wood studs spaced max 16 in. OC. Additional framing members shall be used to completely frame around opening.
- B2. **Gypsum Board*** – Thickness, type, number of layers and fasteners shall be as specified in individual Floor-Ceiling Design as specified in the individual U400 or V400 Wall and Partition Design.

See **Gypsum Board (CKNX)** category in the Fire Resistance Directory for names of manufacturers.

OR

- C. **Floor-Ceiling Assembly** – The 2 hr fire-rated solid wood joist floor-ceiling assembly shall be constructed of the materials and in the manner described in the individual L500 Series Design in the UL Fire Resistance Directory. The general construction features of the floor-ceiling assembly are summarized below:

- C1. **Flooring System** – Lumber or plywood subfloor with finish floor as specified in the individual Floor-Ceiling Design.
- C2. **Wood Joists** – Nom 2 in. by 10 in. (240 mm) deep (or deeper) wood joists with bridging as required and with ends firestopped. Opening to be framed on all 4 sides with sections of solid wood joist.

- C3. **Gypsum Board*** – Thickness, type, number of layers and fasteners shall be as specified in individual Floor-Ceiling Design.

2. **Steel Air Duct** – Min 0.028 in. (22 gauge) thick (or heavier) steel duct having a max perimeter dimension of 218 in. and a max individual dimension of 85 in. When installed in a Combustible Floor-Ceiling Assembly the maximum perimeter dimension shall be 136 in. and a maximum individual dimension of 48 in. Duct sections are intended to be assembled using bolted flanges or SMACNA-approved transverse joint reinforcements. Duct intended to be rigidly supported in accordance with SMACNA requirement and as specified in Item 4. For duct requiring a three-sided wrap, top surface of duct to be located a maximum of 8 in. from the bottom face of floor. Ducts requiring a two-sided wrap shall be installed such that top surface and one side of duct is located maximum 8 in. from bottom surface of floor and adjacent surface of wall assembly.

For ducts with any dimension greater than 60 in. a 1-1/2 in. by 1-1/2 in. by 1/8 in thick transverse stiffening angle, approximately 2 in. less than the maximum dimension, shall be screw attached 8 in OC to the duct, maximum 4 in. beyond the top surface of floor and both surfaces of wall (at the floor or wall penetration).

3. **Fire-resistive System** – The fire-resistive system shall consist of the following:

Assembly No. V-31 *continued*

- A. **Batts and Blankets*** – The Duct Insulation fire-resistive system shall consist of Calcium-Magnesium-Silicate (CMS) duct wrap, 1-1/2 in. thick, installed in accordance with the manufacturer's installation instructions and shall include the following features:
- (a) Copper-coated steel insulation pins (not shown), inductive weld pins or cup-head weld pins, nominal 0.012 in. (3 mm) thick, minimum 1-1/2 in. long, shall be stud-welded to the surfaces of steel duct to be wrapped at 12 in. OC maximum across the width of the duct and 10-1/2 in. mm OC maximum along the length of the duct. Pins are required on the bottom surface of all ducts wider than 12 in.
 - (b) Banding, Item 7, may be omitted where pins are used on the side(s) as well as the bottom surface.

The duct wrap material is installed using either a butt joint and collar method or an overlap method as described below:

A1. **Butt Joint and Collar Method**

A1.1. - One layer of 1-1/2 in. thick duct wrap shall be installed around the duct and cradle support (Items 4 and 5) with perimeter joints tightly butted together. The duct wrap is installed on the bottom of the duct and over the cradle supports and around the vertical sides of the duct with an overlap of minimum 3 in. onto the bottom surface of floor slab or to the wall and the floor slab on both sides of the duct to allow for the installation of Clamping Bar (Item 6). All cut edges to be taped with pressure sensitive aluminum foil tape, 3 in. wide.

A1.2. - Collars, minimum 6 in. wide, shall be installed over each of the perimeter joints. Collar shall be installed with an overlap of minimum 3 in. onto the bottom face of the floor slab to allow for the installation of Clamping Bar (Item 6).

A1.3. - The collars and duct wrap shall be secured to the duct using pins (Item 3A.a) located 1-1/2 in. from the edges of each collar (two rows per collar) or banding material (Item 7), 1/2 in. wide and minimum 0.012 in. (0.3 mm) thick, installed with a tensioning tool and located 1-1/2 in. from the edges of each collar (two per collar) and at maximum 10-1/2 in. OC along the length of the duct.

A1.4. - The banding material (where used) is looped and crimped 10-1/2 in. OC maximum over the Clamping Bar (Item 6) which is secured to the floor slab or wall on top of the 3 in. blanket overlap using 1/4 in. diameter by 4 in. long masonry screws.

A2. - **Overlap Method**

A2.1. - Duct wrap shall be installed around the duct with the perimeter joints overlapped minimum 3 in. The duct wrap is installed on the bottom of the duct and over the cradle supports and around the vertical side(s) of the duct with an overlap of minimum 3 in. onto the bottom surface of floor slab or to the wall and the floor slab on both sides of the duct to allow for the installation of Clamping Bar (Item 6). All cut edges to be taped with pressure sensitive aluminum foil tape, 3 in. wide.

A2.2. - The layer(s) of blanket are locked into place over the insulation pins with 1 in. by 1 in. galvanized steel speed clips. The duct wrap shall be secured to the duct using pins located 1-1/2 in. from the edges of each collar (two rows per collar) or banding material (Item 7), 13 mm wide and minimum 0.012 in. (0.3 mm) thick, installed with a tensioning tool and spaced at maximum 10-1/2 in. OC along the length of the duct.

A2.3. - **The banding material** (where used) is looped over the Clamping Bar (Item 6) which is secured to the floor slab or wall on top of the 3 in. blanket overlap using 1/4 in. diameter by 4 in. long masonry screws.

3M COMPANY

3M FIRE PROTECTION PRODUCTS – 3M Fire Barrier Duct Wrap 615 and 3M Fire Barrier Duct Wrap 615+

- B. **Firestop System** – When the ventilation duct passes through a fire separation, the through openings shall be firestopped in accordance with Through-Penetration System No. W-J-7104 (masonry wall), W-L-7180 (gypsum board wall) or F-C-7054 (combustible floor-ceiling). See Through-Penetration Firestop Systems in Vol. 2 of the Fire Resistance Directory.
4. **Hanger System** – (Not shown) Steel threaded rod, nominal 1/2 in. minimum diameter, shall be used. For ducts not exceeding a duct perimeter of 146 in., steel threaded rod of nominal 3/8 in. diameter can be used through Cradle (Item 4) and mounted to concrete floor by:
- (a) Passing through pre-drilled hole and bolting with nut and washer on top of floor, or
 - (b) Carbon steel or stainless steel masonry anchors, nominal 1/2 in. or 3/8 in. diameter by 2 in. long, drop-in style anchors embedded a minimum of 2 in. into concrete, or nominal 1/2 in. or 3/8 in. diameter stud wedge/expansion type anchors embedded a minimum of 2-1/2 in. into concrete.
5. **Cradle** – Steel angle, 2 in. by 2 in. by 1/4 in. or Unistrut® P5500 channel, used to support wrapped duct at 60 in. OC maximum. Hung from concrete floor with Support Rods (Item 4). For ducts not exceeding a duct perimeter of 146 in., steel angle 1-1/2 in. by 1-1/2 in. by 3/16 in. or Unistrut® P2000 channel can be used.
6. **Clamping Bar** – Minimum 1-1/2 in. by 3/16 in. thick steel flat bar with pre-drilled nominal 1/4 in. diameter holes at 8 in. OC used to clamp wrap material against bottom of floor slab and adjacent surface of wall. The Clamping Bar is secured to the floor slab or wall using 1/4 in. diameter by 4 in. long masonry screws.
7. **Banding** – Nominal 1/2 in. wide, 0.015 in. thick, stainless steel, installed on wrapped duct with tensioning tool.

*Bearing the UL Classification Mark

Reprinted from the Online Certifications Directory with permission from UL
© 2013 UL LLC



Design No. FRD-17

March 12, 2010

| | Duct A | Duct B |
|------------------------|-----------------------|--------|
| Fire-resistance rating | 1 or 2 h (See item 1) | – |

(Ratings applicable for Ventilation Ducts installed with or without branches)

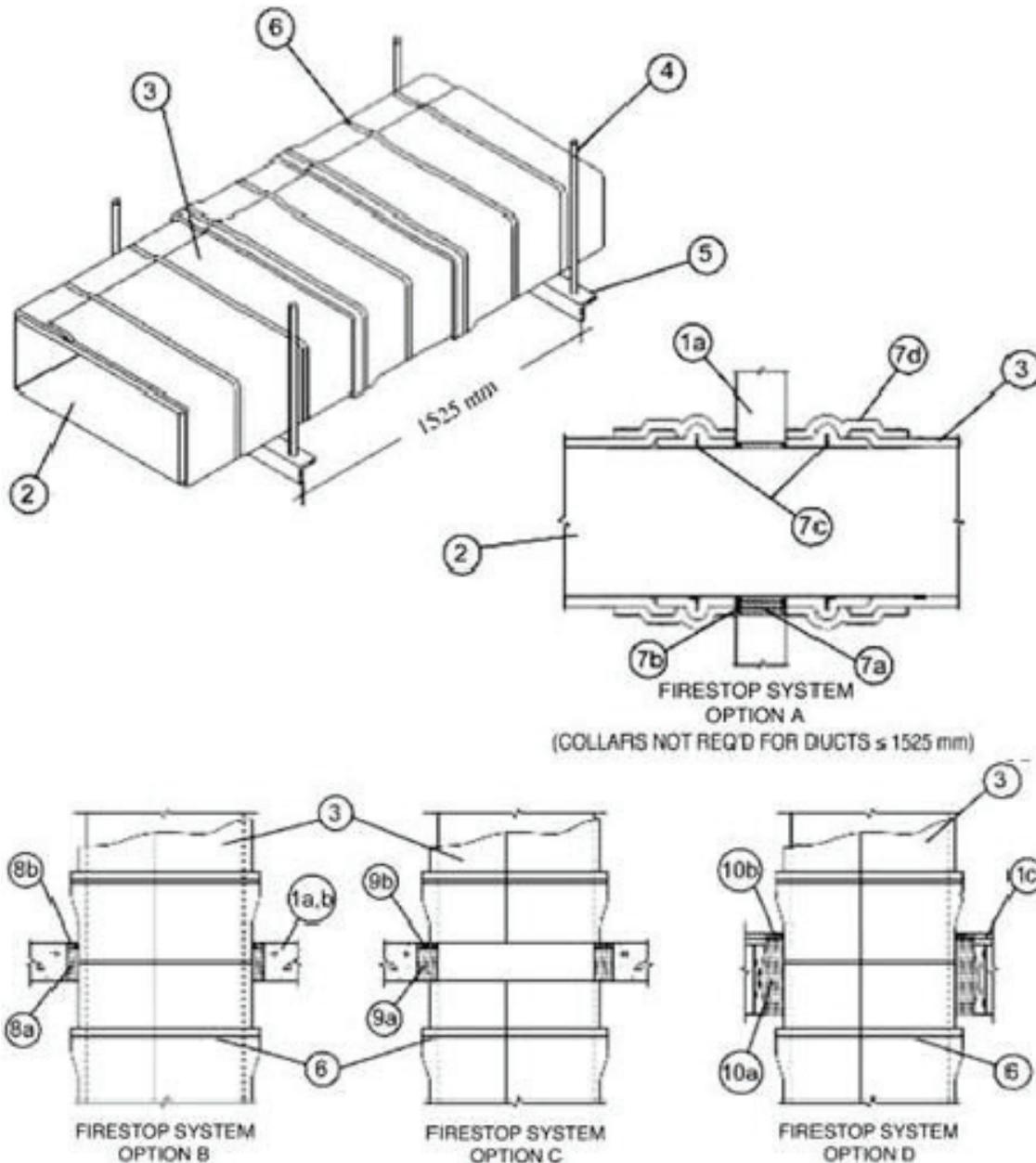

Maximum Size of Duct - Noncombustible Wall or Floor – 1.32 m² maximum area with no dimension exceeding 2.16 m.

Support Spacing – 1 525 mm maximum.

Duct Use Limitation – Duct is intended for use in pressurization situations or maximum negative pressure 300 Pa within duct.

1(a). **Masonry Wall or Floor** – Minimum thickness or depth as necessary for the grade of fire separation but not less than 115 mm for floors and 152 mm for walls. Normal-density or low-density concrete. Wall can also be constructed of nominal 190 mm thick concrete block laid up with mortar.

OR

1(b). **Gypsum Board Wall Assembly** – The fire-rated gypsum wallboard and steel or wood stud assembly shall be constructed of the materials and in the manner described in the individual Wall or Partition design in the ULC Fire Resistance directory.

OR

1(c). **Combustible Floor-Ceiling Assembly** – Maximum duct size 0.62 m² in area with no dimension exceeding 1.22 m. Constructed using minimum 38 by 240 mm wood joists as described in the individual floor-ceiling design in the ULC Fire Resistance directory.

The Fire Resistance Rating of a wrapped duct penetrating a combustible floor-ceiling assembly is limited to the fire resistance rating of the floor-ceiling assembly.

Design No. FRD-17 *continued*

Flexible Wraps

2. **Ventilation Air Duct** – Duct to be constructed in accordance with the requirements of the Standard for the Installation of Air Conditioning and Ventilation Systems, NFPA 90A, 1993 Edition. Minimum thickness of steel permitted, 0.70 mm thick galvanized steel; maximum size of duct as noted above.
3. **Duct Insulation** – (HNNZC) – 38 mm thick, Calcium-Magnesium-Silicate (CMS) duct wrap, installed in accordance with the manufacturer's installation instructions and including the following features:
 - (a) Copper-coated steel insulation pins, nominal 3 mm thick - capacitor discharge weld pins minimum 102 mm long or cup-head weld pins, minimum 38 mm long, shall be stud-welded to the bottom surface of steel ducts over 305 mm in width on horizontal runs and on the widest surface on vertical runs of the steel duct at 305 mm OC maximum lateral, and 267 mm OC maximum longitudinal.
 - (b) The duct wrap material is installed using one of the options described below:

Overlap Method

- (i) One layer of duct wrap is installed around duct. All perimeter and longitudinal joints to overlap by a minimum of 75 mm. Cut ends of duct wrap to be sealed with 76 mm wide aluminum tape. Taping of all joint seams is optional. The blanket is locked into place over the insulation pins with 63 mm by 63 mm by 0.5 mm thick galvanized steel speed clips, when weld pins are required. Banding material (Item 6) shall be installed with a tensioning tool and spaced at minimum 267 mm OC and within 38 mm of all perimeter joints.

Butt Joint and Collar Method

- (ii) One layer of wrap is installed around duct, with perimeter joints tightly butted and all longitudinal joints overlapped 75 mm. Cut ends of duct wrap to be sealed with 76 mm wide aluminum tape. Taping of all joint seams is optional. The blanket is locked into place over the insulation pins with 63 mm by 63 mm by 0.5 mm thick galvanized steel speed clips, when weld pins are required. Collars, minimum 152 mm wide, to be installed and centered over each of the perimeter joints. The collars and duct wrap to be secured to the duct using banding material (Item 6), to be installed with a tensioning tool and located 38 mm from the edges of each collar (two bands per collar) and at maximum 267 mm OC.

3M COMPANY – 3M FireBarrier Duct Wrap 615

Note: Steel shafts or threaded rod up to 19 mm in diameter, if required for the operation of mechanical accessories or for duct support, may penetrate the duct and duct wrap through a close-fitting hole at a spacing of 1525 mm or one per duct section, whichever is less. Application of sealant (Item 7) is not required.

4. **Support Rod** – Steel threaded rod, nominal 13 mm minimum diameter, shall be used. For ducts not exceeding a duct perimeter of 3710 mm, steel threaded rod of nominal 10 mm diameter through Cradle (Item 5) and mounted to concrete floor by:
 - (a) Passing through pre-drilled hole and bolting with nut and washer on top of floor, or
 - (b) Carbon steel or stainless steel masonry anchors, nominal 13 mm or 10 mm diameter by 50 mm long, drop-in style anchors embedded a minimum of 50 mm into concrete, or nominal 13 mm or 10 mm diameter stud wedge/expansion type anchors embedded a minimum of 60 mm into concrete.
5. **Cradle** – Steel angle, 50 mm by 50 mm by 5 mm or Unistrut® P5500 channel, used to support wrapped duct at 1525 mm OC maximum. Hung from concrete floor with Support Rods (Item 4).

For ducts not exceeding a duct perimeter of 3710 mm, steel angle 38 mm by 38 mm by 4 mm or Unistrut® P2000 channel can be used.

As an option, the cradle assembly can be encased within the duct wrap (cocoon wrap) during the installation of duct wrap (Item 3). To encase the cradle support, the duct wrap is slit maximum 152 mm to allow for the threaded rod. A generous application of ULC labelled sealant (Item 11) is applied along the seam. The seam is taped over with minimum 76 mm wide aluminum tape. Additional material is installed such that a crown of sealant minimum 13 mm is formed around the circumference of the threaded rod. The duct wrap adjacent to the threaded rod must be installed with enough overlap to cover the seam.

6. **Steel Band** – (Not shown) Nominal 13 mm wide, 0.4 mm thick, made of carbon or stainless steel for 1 h rating and stainless steel for 2 h rating, installed on wrapped duct with tensioning tool and spaced at minimum 267 mm OC.

Firestop System Installation

The duct shall be installed within the opening such that the annular space between the bare or wrapped duct and the edges of the opening is minimum 25 mm, maximum 76 mm. For installations in gypsum wallboard assemblies, the opening to accommodate the duct shall be framed on all sides using lengths of stud installed between vertical studs and secured to the vertical studs.

For installations in combustible floor/ceiling assemblies, only Option D shall be used. The maximum and minimum annular spaces shall be 82 and 22 mm respectively. The opening to accommodate the duct shall be framed on all sides using lengths of minimum 38 mm by 240 mm wood joists.

Option A

(Duct Wrap Terminated at Masonry Wall - Maximum Duct Dimension 2.16 m)

- 7(a). **Firestop Insulation** – Scrap duct wrap or ULC labelled mineral wool insulation with minimum 64 kg/m³ density compressed 50% minimum and installed into the opening to a minimum depth of 100 mm. Material to be recessed 16 mm from both surfaces of wall to allow for the installation of sealant (Item 7b).
- 7(b). **Firestop System Component** – (XHJZC) – Sealant applied over insulation (Item 7a) to a minimum depth of 16 mm flush with exposed surface of wall.
3M COMPANY – 3M Fire Barrier Sealants CP25 WB+, 1000 NS, IC 15WB+ or 3000 WT
- 7(c). **Steel Angle** – For ducts with any dimension greater than 1525 mm, stiffening angle 38 mm by 38 mm by 3 mm thick applied around the perimeter of the duct within 100 mm of wall, secured with No. 10 steel screws spaced 200 mm OC.
- 7(d). **Duct Insulation (Collar)** – (HNNZC) – For ducts with any dimension greater than 1525 mm, duct wrap minimum 610 mm wide, applied over Item 3(b) adjacent to the wall. Collar to be tightly butted to each side of wall, or alternatively, collar may be installed

Duct Wrap

Canada

FRD

Design No. FRD-17 *continued*

continuously through wall provided collar projects a minimum of 610 mm from each side of wall.

3M COMPANY – 3M FireBarrier Duct Wrap 615

Option B

(Duct Wrap Continuous Through Non-Combustible Floor or Combustible or Non-Combustible Wall Opening - Maximum Duct Dimension 2.16 m)

- 8(a). **Firestop Insulation** – Scrap duct wrap or ULC labelled mineral wool insulation with minimum 64 kg/m³ density compressed 50% minimum and installed into the opening to a minimum depth of 100 mm. Material to be recessed 6.4 mm from top surface of floor or 16 mm from both surfaces of wall to allow for the installation of sealant (Item 7b).
- 8(b). **Firestop System Component** – (XHJZC) – Sealant applied over insulation (Item 7a) to a minimum depth of 6.3 mm flush with top surface of floor or 16 mm flush with both surfaces of wall.
- 3M COMPANY** – 3M Fire Barrier Sealants CP25 WB+, 1003 SL (for floors only), 1000 NS, IC 15WB+ or 3000 WT
- 8(c). **Steel Angle** – (Not shown) – For ducts with any dimension greater than 1525 mm, stiffening angles 38 mm by 38 mm by 3 mm thick are applied around the perimeter of the duct within 100 mm of wall, secured with No. 10 steel screws spaced 200 mm OC.
- 8(d). **Duct Insulation (Collar)** – (HNNZC) – For ducts with any dimension greater than 1525 mm, duct wrap minimum 610 mm wide, applied over Item 3(b) adjacent to the wall. Collar to be tightly butted to each side of wall, or alternatively, collar may be installed continuously through wall provided collar projects a minimum of 610 mm from each side of wall.

3M COMPANY – 3M FireBarrier Duct Wrap 615

Option C

(Duct Wrap Terminated at Non-Combustible Floor - Maximum Duct Dimension 2.16 m)

- 9(a). **Firestop Insulation** – Scrap duct wrap or ULC labelled mineral wool insulation with minimum 64 kg/m³ density compressed 50% minimum and installed into the opening to a minimum depth of 100 mm. Material to be recessed 6.4 mm from top surface of floor to allow for the installation of sealant (Item 7b).
- For floor assemblies, the firestop insulation is installed to full depth of floor. The insulation is recessed 6.4 mm from the top surface of floor to allow for the installation of sealant (Item 7b).
- 9(b). **Firestop System Component** – (XHJZC) – Sealant applied over insulation (Item 7a) to a minimum depth of 6.4 mm flush with top surface of floor.

3M COMPANY – 3M Fire Barrier Sealants CP25 WB+, 1003 SL (for floors only), 1000 NS, IC 15WB+ or 3000 WT

Option D

(Duct Wrap Continuous Through Combustible Floor-Ceiling Opening - Maximum Duct Dimension 1.22 m)

- 10(a). **Firestop Insulation** – Unfaced scrap duct wrap or ULC labelled mineral wool insulation with minimum 64 kg/m³ density compressed 50% minimum and installed into the opening to a minimum depth of 240 mm. Material to be recessed from surface of floor to accommodate required thickness of sealant (Item 7b).
- 10(b). **Firestop System Component** – (XHJZC) – Sealant applied over insulation (Item 7a) to a minimum depth of 6.4 mm flush with top surface of floor.
- 3M COMPANY** – 3M Fire Barrier Sealants CP25 WB+, 1003 SL (for floors only), 1000 NS, IC 15WB+ or 3000 WT
11. **Firestop System Component** – (Not Shown). Caulk for use in “cocoon wrap” applications if crack penetrates the wrap.

3M COMPANY – 3M Fire Barrier Sealants CP25 WB+, 1000 NS, IC 15WB+ or 3000 WT

Reprinted from the ULC Online Directories with permission from Underwriters Laboratories of Canada Inc.
Copyright © 2013 Underwriters Laboratories of Canada Inc.



Design No. FRD-23

January 08, 2010

(Fire Resistance Ratings)

Stability, Integrity and Insulation - 2 h (see Item 4)

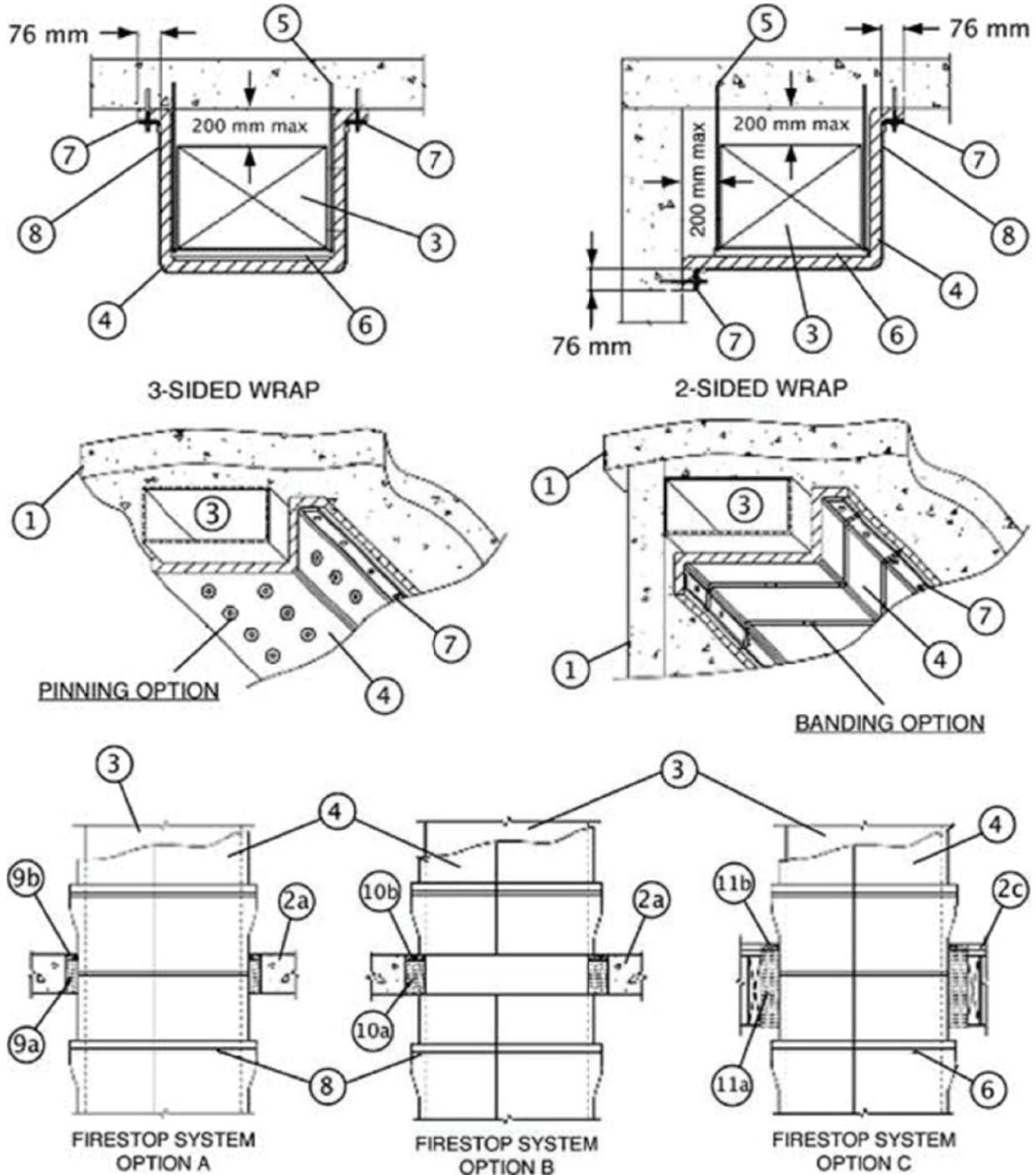

Maximum Size of Duct – 1.32 m² maximum area with no dimension exceeding 2.16 m. For ducts penetrating combustible floor/ceiling assemblies, maximum area 0.62m² with no dimension exceeding 1.22 m.

Support Spacing – 1525 mm max.

Duct Use Limitation – Duct is intended for use in pressurization situations or maximum negative pressure 300 Pa within duct.

1. **Masonry Wall and/or Floor By Which Duct is Supported** – Minimum depth or thickness as necessary for the grade of fire separation but not less than 115 mm. Normal-density or low-density concrete. Wall can also be constructed of nominal 190 mm thick concrete block laid up with mortar.
2. **Fire Separation Penetrated by Duct** –
 - (a) **Masonry Wall or Floor** – Minimum depth or thickness as necessary for the grade of fire separation but not less than 115 mm for floors and 152 mm for walls. Normal-density or low-density concrete. Wall can also be constructed of nominal 190 mm thick concrete block laid up with mortar.

OR

Design No. FRD-23 *continued*

- (b) **Wall Assembly** – The fire-rated gypsum wallboard and steel or wood stud assembly shall be constructed of the materials and in the manner described in the individual Wall or Partition design in the ULC List of Equipment and Materials, Fire Resistance Ratings.

OR

- (c) **Combustible Floor-Ceiling Assembly** – Maximum duct size 0.62 m² in area with no dimension exceeding 1.22 m. Constructed using minimum 38 by 240 mm wood joists as described in the individual floor-ceiling design in the ULC List of Equipment and Materials, Fire Resistance Ratings.

Note: The Stability, Integrity and Insulation Rating of a wrapped duct penetrating a combustible floor-ceiling assembly is limited to the fire resistance rating of the floor-ceiling assembly.

3. **Ventilation Air Duct** – Duct to be constructed in accordance with the requirements of the Standard for the Installation of Air Conditioning and Ventilation Systems, NFPA 90A. Minimum thickness of steel permitted, 0.7 mm thick galvanized steel; maximum size of duct 600 mm by 2160 mm nominal (1.2 m² maximum area with no dimension exceeding 2.16 m).

For duct requiring a three-sided wrap, top surface of duct to be located a maximum of 200 mm from the bottom face of floor. Ducts requiring a two-sided wrap, shall be installed such that top surface and one side of duct is located maximum 200 mm from bottom surface of floor and adjacent surface of wall assembly.

For ducts with any dimension greater than 1525 mm, a 38 mm by 38 mm by 3 mm thick transverse stiffening angle, approximately 50 mm less than the maximum dimension, shall be screw attached 204 mm OC to the duct, 102 mm beyond the top surface of floor and both surfaces of wall (at the floor or wall penetration).

4. **Duct Insulation** – (HNNZC). Calcium-Magnesium-Silicate (CMS) duct wrap, 38 mm thick, installed in accordance with the manufacturer's installation instructions and shall include the following features:
- (a) Copper-coated steel insulation pins (not shown), inductive weld pins or cup-head weld pins, nominal 3 mm thick, minimum 38 mm long, shall be stud-welded to the surfaces of steel duct to be wrapped at 305 mm OC maximum across the width of the duct and 267 mm OC maximum along the length of the duct. Pins are required on the bottom surface of all ducts wider than 305 mm.
 - (b) Banding, Item 8, may be omitted where pins are used on the side(s) as well as the bottom surface.

The duct wrap material is installed using one of the options described below:

TWO- AND THREE-SIDED WRAP

Butt joint and collar method

- (i) One layer of 38 mm thick duct wrap shall be installed around the duct and cradle support (Items 5 and 6) with perimeter joints tightly butted tightly. The duct wrap is installed on the bottom of the duct and over the cradle supports and around the vertical sides of the duct with an overlap of minimum 76 mm onto the bottom surface of floor slab or to the wall and the floor slab on both sides of the duct to allow for the installation of Clamping Bar (Item 7). All cut edges to be taped with pressure sensitive aluminum foil tape, 76 mm wide.
- (ii) Collars, minimum 152 mm wide, shall be installed over each of the perimeter joints. Collar shall be installed with an overlap of minimum 76 mm onto the bottom face of the floor slab to allow for the installation of Clamping Bar (Item 7).
- (iii) The collars and duct wrap shall be secured to the duct using pins (Item 4a) located 38 mm from the edges of each collar (two rows per collar) or banding material (Item 8), 13 mm wide and minimum 0.3 mm thick, installed with a tensioning tool and located 38 mm from the edges of each collar (two per collar) and at maximum 267 mm OC along the length of the duct.
- (iv) The banding material (where used) is looped and crimped 267 mm OC maximum over the Clamping Bar (Item 7) which is secured to the floor slab or wall on top of the 76 mm blanket overlap using 6 mm diameter by 100 mm long masonry screws.

Overlap Method

- (v) Duct wrap shall be installed around the duct with the perimeter joints overlapped minimum 76 mm. The duct wrap is installed on the bottom of the duct and over the cradle supports and around the vertical side(s) of the duct with an overlap of minimum 76 mm onto the bottom surface of floor slab or to the wall and the floor slab on both sides of the duct to allow for the installation of Clamping Bar (Item 7). All cut edges to be taped with pressure sensitive aluminum foil tape, 76 mm wide.
- (vi) The layer(s) of blanket are locked into place over the insulation pins with 25 mm by 25 mm galvanized steel speed clips. The duct wrap shall be secured to the duct using pins (Item 4a) located 38 mm from the edges of each collar (two rows per collar) or banding material (Item 8), 13 mm wide and minimum 0.3 mm thick, installed with a tensioning tool and spaced at maximum 267 mm OC along the length of the duct.
- (vii) The banding material (where used) is looped over the Clamping Bar (Item 7) which is secured to the floor slab or wall on top of the 76 mm blanket overlap using 6 mm diameter by 100 mm long masonry screws.

3M COMPANY – Fire Barrier Duct Wrap 615

5. **Support Rod** – Steel threaded rod, nominal 13 mm minimum diameter, shall be used. For ducts not exceeding a duct perimeter of 3710 mm, steel threaded rod of nominal 10 mm diameter can be used through Cradle (Item 5) and mounted to concrete floor by:
- (a) Passing through pre-drilled hole and bolting with nut and washer on top of floor, or
 - (b) Carbon steel or stainless steel masonry anchors, nominal 13 mm or 10 mm diameter by 50 mm long, drop-in style anchors embedded a minimum of 50 mm into concrete, or nominal 13 mm or 10 mm diameter stud wedge/expansion type anchors embedded a minimum of 60 mm into concrete.
6. **Cradle** – Steel angle, 50 mm by 50 mm by 5 mm or Unistrut® P5500 channel, used to support wrapped duct at 1525 mm OC maximum. Hung from concrete floor with Support Rods (Item 5).

For ducts not exceeding a duct perimeter of 3710 mm, steel angle 38 mm by 38 mm by 4 mm or Unistrut® P2000 channel can be used.

7. **Clamping Bar** – Minimum 38 mm by 4 mm thick steel flat bar with pre-drilled nominal 6 mm diameter holes at 204 mm OC used to clamp wrap material against bottom of floor slab and adjacent surface of wall. The Clamping Bar is secured to the floor slab or wall using 6 mm diameter by 100 mm long masonry screws.
8. **Banding** – Nominal 13 mm wide, 0.5 mm thick, stainless steel, installed on wrapped duct with tensioning tool.

Design No. FRD-23 *continued*

Firestop System Installation

The duct shall be installed within the opening such that the annular space between the wrapped duct (for Firestop Option A), or steel duct (for Firestop Option B), and the edges of the opening is maximum 76 mm. For installations in gypsum wallboard assemblies, the opening to accommodate the duct shall be framed on all sides using lengths of stud installed between vertical studs and secured to the vertical studs.

For installations in combustible floor/ceiling assemblies, only Option C shall be used. The maximum and minimum annular spaces shall be 82 and 22 mm respectively. The opening to accommodate the duct shall be framed on all sides using lengths of nominal 38 mm by minimum 240 mm wood joists.

Option A

(Duct Wrap Continuous Through Non-Combustible Floor or Combustible or Non-combustible Wall Opening)

9(a). **Firestop Insulation** – (HNNZC). Unfaced scrap duct wrap or ULC labelled mineral wool insulation with minimum 64 kg/m³ density compressed 50% minimum and installed into the opening to a minimum depth of 100 mm. Material to be recessed 6.4 mm from top surface of floor or 16 mm from both surfaces of wall to allow for the installation of sealant (Item 9b).

3M COMPANY – Fire Barrier Duct Wrap 615

9(b). **Firestop System Component** – (XHJZC). Sealant applied over insulation (Item 9a) to a minimum depth of 6.3 mm, flush with top surface of floor or to a minimum depth of 16 mm symmetrically to both surfaces of wall.

3M COMPANY – 3M Fire Barrier Sealants CP25 WB+, 1003 SL (for floors only), 1000 NS, IC 15WB+ or 3000 WT

Option B

(Duct Wrap Terminated at Masonry Floor or Wall Opening)

10(a). **Firestop Insulation** – Unfaced scrap duct wrap or ULC labelled mineral wool insulation with minimum 64 kg/m³ density compressed 50% minimum and installed into the opening to a minimum depth of 100 mm.

For floor assemblies, the insulation is installed to full depth of floor and butted tightly against the duct wrap at the bottom surface of floor. The insulation is recessed 6.4 mm from the top surface of floor to allow for the installation of sealant (Item 10b).

For wall assemblies, the insulation material is recessed 16 mm from both surfaces of wall to allow for the installation of sealant (Item 10b).

10(b). **Firestop System Component** – (XHJZC). Sealant applied over insulation (Item 10a) to a minimum depth of 6.3 mm, flush with top surface of floor or symmetrically to both surfaces of wall.

Additional sealant to be installed around the interface of duct wrap to ensure that no gap exists between sealant and duct wrap material.

3M COMPANY – 3M Fire Barrier Sealants CP25 WB+, 1003 SL (for floors only), 1000 NS, IC 15WB+ or 3000 WT

Option C

(Duct Wrap Continuous Through Combustible Floor/Ceiling Opening)

11(a). **Firestop Insulation** – (HNNZC). Unfaced scrap duct wrap or ULC labelled mineral wool insulation with minimum 64 kg/m³ density compressed 50% minimum and installed into the opening to a minimum depth of 240 mm. Material to be recessed from surface of floor to accommodate required thickness of sealant (Item 11b).

11(b). **Firestop System Component** – (XHJZC) – Sealant applied over insulation (Item 11a) to a minimum depth of 6.3 mm, flush with top surface of floor.

3M COMPANY – 3M Fire Barrier Sealants CP25 WB+, 1003 SL (for floors only), 1000 NS, IC 15WB+ or 3000 WT

Reprinted from the ULC Online Directories with permission from Underwriters Laboratories of Canada Inc.

Copyright © 2013 Underwriters Laboratories of Canada Inc.



Design No. FRD-27

March 12, 2010

| | Duct A | Duct B |
|------------------------|------------------------------|--------|
| Fire-resistance rating | 1 or 2 h (See items 1 and 7) | - |

(Ratings applicable for Ventilation Ducts installed with or without branches)

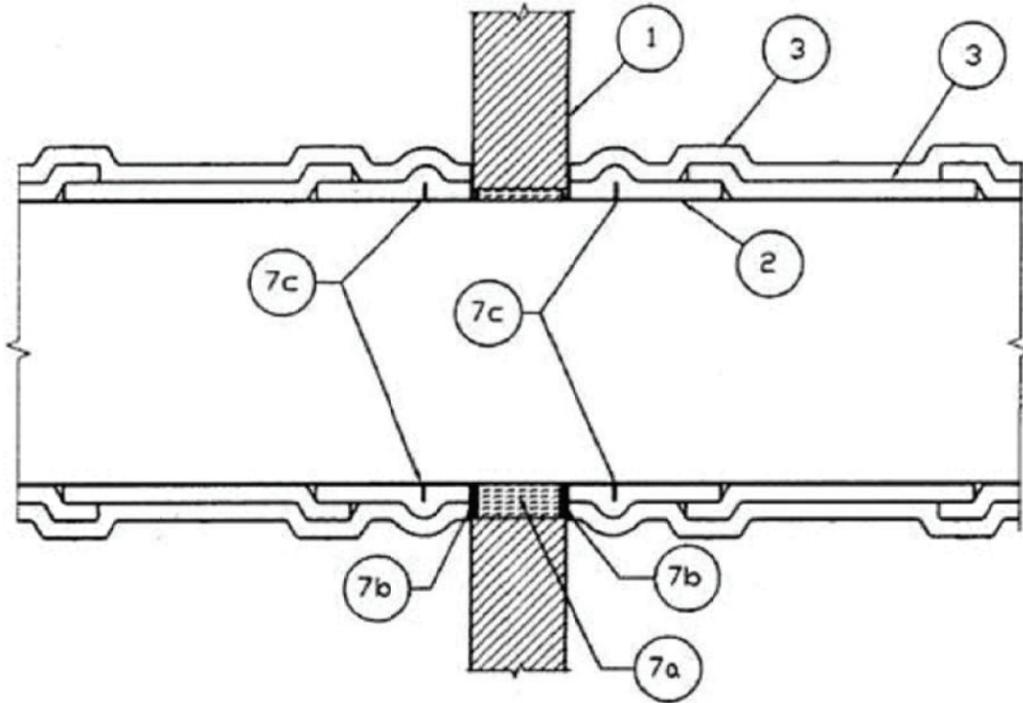

FIRESTOP SYSTEM

OPTION A

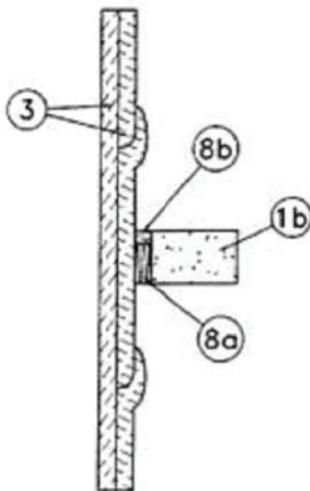

**FIRESTOP SYSTEM
OPTION B**

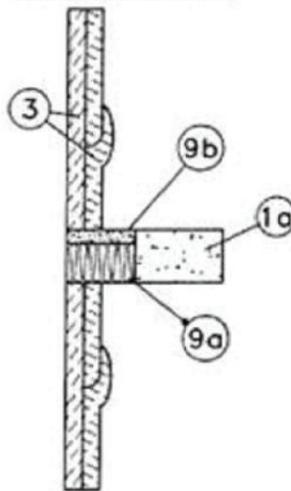

**FIRESTOP SYSTEM
OPTION C**

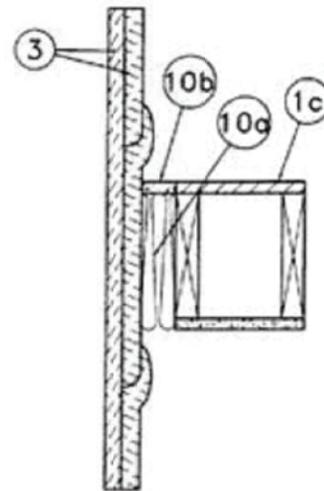

**FIRESTOP SYSTEM
OPTION D**

Maximum Size of Duct – 1.32 m² maximum area with no dimension exceeding 2.16 m.

Support Spacing – 1525 mm maximum.

Duct Use Limitation – Duct is intended for use in pressurization situations or maximum negative pressure 300 Pa within duct.

1(a). **Masonry Wall or Floor** – Minimum depth or thickness as necessary for the grade of fire separation but not less than 115 mm. Normal-density or low-density concrete. Wall can also be constructed of nominal 190 mm thick concrete block laid up with mortar.

OR

1(b). **Wall Assembly** – The fire-rated gypsum wallboard and steel or wood stud assembly shall be constructed of the materials and in the manner described in the individual Wall or Partition design in the ULC Fire Resistance directory.

OR

Design No. FRD-27 *continued*

Flexible Wraps

Duct Wrap

Canada

FRD

- 1(c). **Combustible Floor-Ceiling Assembly** – Maximum duct size 0.62 m² in area with no dimension exceeding 1.22 m. Constructed using minimum 38 by 240 mm wood joists as described in the individual floor-ceiling design in the ULC Fire Resistance directory.
The Fire Resistance Rating of a wrapped duct penetrating a combustible floor-ceiling assembly is limited to the fire resistance rating of the floor-ceiling assembly.
2. **Ventilation Air Duct** – Duct to be constructed in accordance with the requirements of the Standard for the Installation of Air Conditioning and Ventilation Systems, NFPA 90A, 1993 Edition. Minimum thickness of steel permitted, 0.70 mm thick galvanized steel; maximum size of duct 600 mm by 2160 mm nominal (1.32 m² maximum area with no dimension exceeding 2.16 m).
3. **Duct Insulation** – (HNNZC) – Two layers of 38 mm thick, Calcium-Magnesium-Silicate (CMS) Duct Wrap installed in accordance with the manufacturer's installation instructions and shall include the following features:
- (a). Copper-coated steel insulation pins, Capacitor discharge weld pins or cup-head duct pins, nominal 3 mm thick, minimum 102 mm long, shall be stud-welded to the bottom surface of steel duct over 305 mm in width on horizontal runs and on the widest surface on vertical runs of the steel duct at 305 mm OC maximum lateral, and 267 mm OC maximum longitudinal.
 - (b). the duct wrap material is installed using one of the options shown below:

Butt joint and collar Method

- (i). The first layer of duct wrap to be installed around the duct with the perimeter and longitudinal joints butted tightly together and held in place with tape. A second layer of duct wrap blanket to be installed over the first layer with perimeter and longitudinal joints overlapped minimum 76 mm. Cut ends of duct wrap to be sealed with 76 mm wide aluminum tape. Taping of all joints is optional with pressure sensitive aluminum foil.
- (ii). The layers of blanket are locked into place over the insulation pins with 63 mm by 63 mm galvanized steel speed clips when weld pins are required. The duct wrap shall be secured to the duct using banding material (Item 6), 13 mm wide and minimum 0.3 mm thick, installed with a tensioning tool and spaced at maximum 267 mm Oc and within 38 mm of all perimeter joints.

Overlap Method

- (i). The first layer of duct wrap to be installed around the duct with the perimeter and longitudinal joints butted tightly together and held in place with aluminum tape. A second layer of duct wrap to be installed over the first layer with perimeter joints butted tightly. The longitudinal joints are overlapped minimum 76 mm. Cut ends of duct wrap to be sealed with 76 mm wide aluminum tape. Taping of all joints is optional with pressure sensitive aluminum foil.
- (ii). The layers of blanket are locked into place over the insulation pins with 63 mm by 63 mm galvanized steel speed clips, when weld pins are required. "3M Fire Barrier Duct Wrap 615" blanket, minimum 150 mm wide, shall be installed as collars and centered over each of the perimeter joints. Collar shall be installed with a longitudinal overlap of minimum 76 mm. The collars and duct wrap shall be secured to the duct using banding material (Item 6), 13 mm wide and minimum 0.3 mm thick, installed with a tensioning tool and located 38 mm from the edges of each collar (two per collar) and at maximum 267 min OC.

3M COMPANY

3M FIRE PROTECTION PRODUCTS – 3M FireBarrier Duct Wrap 615

Note: Steel shafts or threaded rod up to 19 mm in diameter, if required for the operation of mechanical accessories or for duct support, may penetrate the duct and duct wrap through a close-fitting hole at a spacing of 1525 mm or one per duct section, whichever is less. Application of sealant (Item 7) is not required.

4. **Support Rod** – Steel threaded rod, nominal diameter of 13 mm shall be used. For ducts not exceeding a duct perimeter of 2700 mm, steel threaded rod of nominal 10 mm diameter shall be used through cradle (item 5) and mounted to concrete by:
- (a) Passing through pre-drilled hole and bolting with nut and washer on top of floor, or
 - (b) Carbon steel or stainless steel masonry anchors, nominal 13 mm or 10 mm diameter by 50 mm long, drop-in style anchors embedded a minimum of 50 mm into concrete, or nominal 13 mm or 10 mm diameter stud wedge/expansion anchors embedded a minimum of 60 mm into concrete
5. **Cradle** – Steel angle, 50 mm by 50 mm by 5 mm or P-5500 channel, used to support wrapped duct at 1525 mm OC maximum. Hung from concrete floor with Support Rods (Item 4).
For ducts not exceeding a duct perimeter of 2700 mm, steel angle 38 mm by 38 mm by 4 mm or Unistrut P2000 channel can be used.
As an option, the cradle assembly can be encased within the duct wrap (cocoon wrap) during the installation of duct wrap (Item 3). To encase the cradle support, the duct wrap is slit maximum 152 mm to allow for the threaded rod. A generous application of ULC labelled sealant (Item 11) is applied along the seam. The seam is taped over with minimum 76 mm wide aluminum tape. Additional material is installed such that a crown of minimum 13 mm is formed around the circumference of the threaded rod. The adjacent duct wrap to the threaded rod must be installed with enough overlap to cover the seam.
6. **Steel Band** – Nominal 13 mm wide, 0.4 mm thick, made of made of carbon or stainless steel for 1 h rating and stainless steel for 2 h rating, installed on wrapped duct with tensioning tool and spaced at minimum 267 mm OC.

Firestop System Installation

The duct shall be installed within the opening such that the annular space between the bare or wrapped duct and the edges of the opening is maximum 76 mm and a minimum of 25 mm. For installations in gypsum wallboard assemblies, the opening to accommodate the duct shall be framed on all sides using lengths of stud installed between vertical studs and secured to the vertical studs.

For installations in combustible floor/ceiling assemblies, only Option D shall be used. The maximum and minimum annular spaces shall be 82 and 22 mm respectively. The opening to accommodate the duct shall be framed on all sides using lengths of minimum 38 mm by 240 mm wood joists.

Option A

(Duct Wrap Terminated at Non-Combustible Wall - Maximum Duct Dimension 2.16 m)

Design No. FRD-27 *continued*

Flexible Wraps

- 7(a). **Firestop Insulation** – Minimum 64 kg/m³ density scrap duct wrap or ULC labelled mineral wool insulation with minimum 64 kg/m³ density compressed 50% minimum and installed into the opening to a minimum depth of 100 mm. Material to be recessed 16 mm from exposed surface of wall to allow for the installation of sealant (Item 7b).
3M COMPANY
3M FIRE PROTECTION PRODUCTS – 3M FireBarrier Duct Wrap 615
- 7(b). **Firestop System Component** – (XHJZC) – Sealant applied over insulation (Item 7a) to a minimum depth of 16 mm flush with exposed surface of wall.
3M COMPANY
3M FIRE PROTECTION PRODUCTS – 3M FireBarrier - Sealants CP-25 WB+, 1000 NS, IC 15WB+ or 3000 WT
- 7(c). **Steel Angle** – For ducts with any dimension greater than 1525 mm, stiffening angle 38 mm by 38 mm by 3 mm thick applied around the perimeter of the duct on both sides of wall 100 mm from the wall, secured with No. 10 steel screws spaced 200 mm OC.

Option B

(Duct Wrap Continuous Through Non-Combustible Floor or Combustible or Non-Combustible Wall Opening - Maximum Duct Dimension 2.160 m)

- 8(a). **Firestop Insulation** – Unfaced scrap duct wrap or ULC labelled mineral wool insulation with minimum 64 kg/m³ density compressed 50% minimum and installed into the opening to a minimum depth of 100 mm. Material to be recessed 6.4 mm from top surface of floor or 16 mm from both surfaces of wall floor to allow for the installation of sealant (Item 8b).
- 8(b). **Firestop System Component** – (XHJZC) – Sealant applied over insulation (Item 8a) to a minimum depth of 6.4 mm flush with top surface of floor or 16 mm flush with both surfaces of wall.
3M COMPANY
3M FIRE PROTECTION PRODUCTS – 3M Fire Barrier Sealants 1003 SL (for floors only), 1000 NS, IC 15 WB+, 3000 WT or CP25 WB+.
- 8(c). **Steel Angle** – (Not shown) – For ducts with any dimension greater than 1525 mm, stiffening angles 38 mm by 38 mm by 3 mm thick are applied around the perimeter of the duct within 100 mm of wall, secured with No. 10 steel screws spaced 200 mm OC.

Option C

(Duct Wrap Terminated at Non-Combustible Floor - Maximum Duct Dimension 2.160 m)

- 9(a). **Firestop Insulation** – Scrap duct wrap or ULC labelled mineral wool insulation with minimum 64 kg/m³ density compressed 50% minimum and installed into the opening to a minimum depth of 100 mm.
For floor assemblies, the insulation is installed to full depth of floor and butted tightly against the duct at the bottom surface of floor. The insulation is recessed 6.4 mm from the top surface of floor to allow for the installation of sealant (Item 9b).
- 9(b). **Firestop System Component** – (XHJZC) – Sealant applied over insulation (Item 9a) to a minimum depth of 6.4 mm flush with top surface of floor.
3M COMPANY
3M FIRE PROTECTION PRODUCTS – 3M Fire Barrier Sealants 1003 SL (for floors only), 1000 NS, IC 15 WB+, 3000 WT or CP-25 WB+.

Option D

(Duct Wrap Continuous Through Combustible Floor-Ceiling Opening - Maximum Duct Dimension 1.22 m)

- 10(a). **Firestop Insulation** – Scrap Duct Wrap or ULC labelled mineral wool insulation with minimum 64 kg/m³ density compressed 50% minimum and installed into the opening to a minimum depth of 240 mm. Material to be recessed from surface of floor to accommodate required thickness of sealant (Item 10b).
The Fire Resistance Rating of a wrapped duct penetrating a combustible floor-ceiling assembly is limited to the fire resistance rating of the floor-ceiling assembly.
- 10(b). **Firestop System Component** – (XHJZC) – Sealant applied over insulation (Item 10a) to a minimum depth of 6.4 mm flush with top surface of floor.
3M COMPANY
3M FIRE PROTECTION PRODUCTS – 3M Fire Barrier Sealants 1003 SL (for floors only), 1000 NS, IC 15WB+, 3000 WT or CP-25 WB+.
- 11. **Firestop System Component** – (XHJZC) – (Not shown) Sealant for use in “cocoon wrap” applications if cradle penetrates the wrap.
3M COMPANY
3M FIRE PROTECTION PRODUCTS – 3M Fire Barrier Sealants CP25 WB+, 1000 NS, IC 15WB+ or 3000 WT

Reprinted from the ULC Online Directories with permission from Underwriters Laboratories of Canada Inc.
Copyright © 2013 Underwriters Laboratories of Canada Inc.



Duct Wrap

Canada

FRD

Chemical Fume Exhaust Duct Protection

Flexible Wraps • Chemical Fume Exhaust Duct Protection

| 3M Systems | "F" Rating | 3M Product | Application Details |
|----------------|------------|---------------------------------|--|
| 3MU/FRD 120-10 | 2 | 3M™ Fire Barrier Duct Wrap 615+ | 2 hour flexible wrap protection for a rectangular chemical fume exhaust duct with a maximum 1440 square inch area and maximum 48 inch dimension. |
| 3MU/FRD 120-11 | 2 | 3M™ Fire Barrier Duct Wrap 615+ | 2 hour flexible wrap protection for a round chemical exhaust fume duct with a maximum 1320 square inch area and maximum 41 inch diameter. |

Design No. 3MU/FRD 120-10

April 03, 2013

OPL Design Number: CFD 500 F
CHEMICAL FUME EXHAUST DUCT PROTECTION

3M Company

3M Fire Barrier™ Duct Wrap 15A or 3M Fire Barrier™ Duct Wrap 615+
UL 1978 (June 25, 2002)

Section 12 Temperature Test – Pass

Section 13 Abnormal Temperature Test – Pass

ICC-ES Acceptance Criteria for Grease Duct Enclosure Systems (AC101)

Section 4.5 Fire-Engulfment Test (ASTM E 119 Exposure) – 2 hr

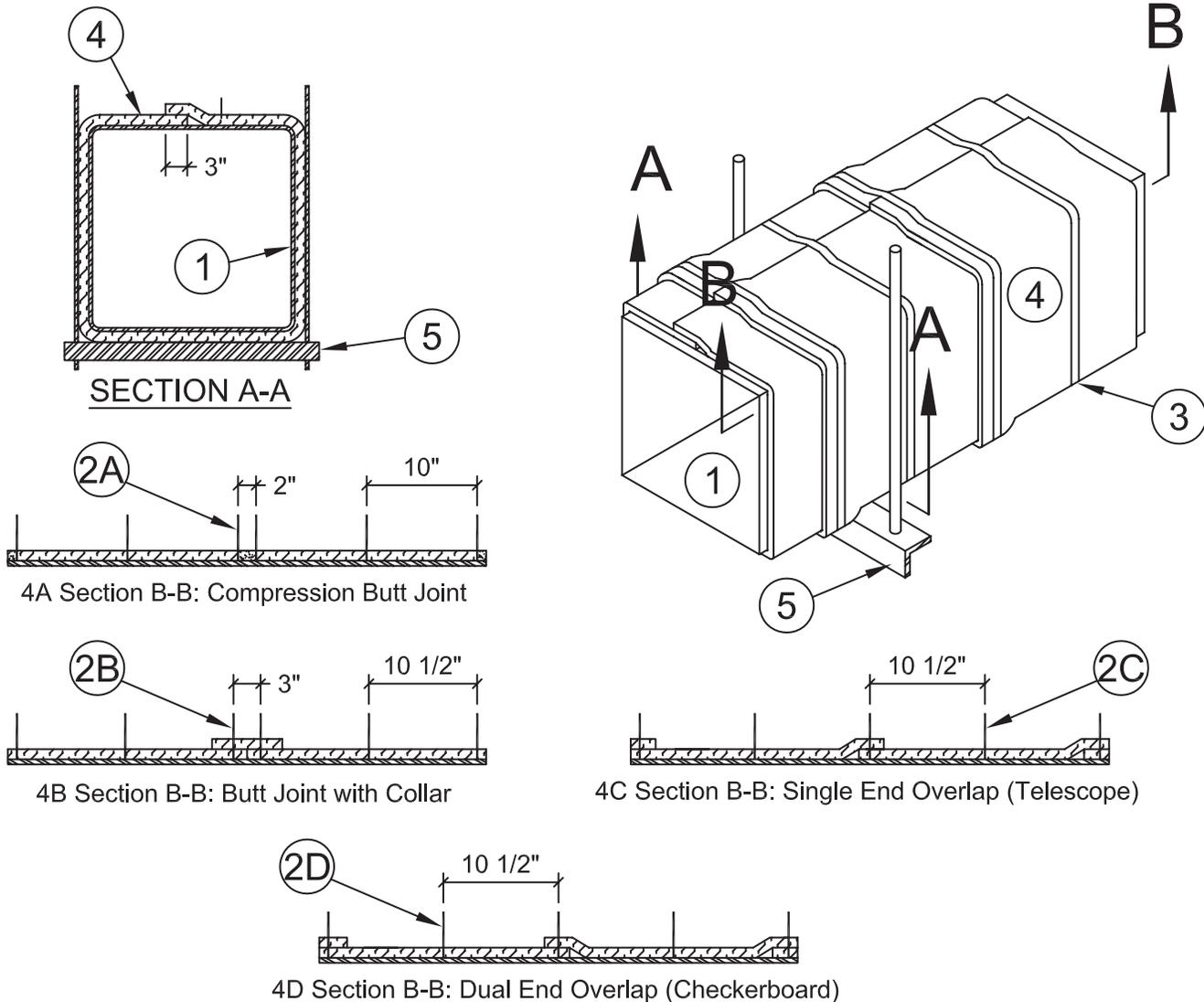

1. CHEMICAL FUME EXHAUST DUCT: Continuously-welded, liquid-tight L-shaped rectangular duct system with horizontal and vertical shafts constructed of 16 GA sheet steel or 18 GA stainless steel with a maximum 1440 inch² area and a maximum 48 inch dimension. When required, equip the duct with a prefabricated access door (Item 6) or field fabricated access door (Item 7).
 - A. Construct the duct using sections affixed to each other with welded seams.
 - B. Reinforce the duct to IMC or NFPA 96 requirements designed to carry the weight of the chemical fume exhaust duct assembly covered with insulation under a fire load equivalent to UL 1978 exposure and the ASTM E 119 time-temperature curve.
 - C. Rigidly support the duct in accordance with IMC or NFPA 96 requirements or as specified in Item 5.
 - D. Protect the annular space around the duct passing through a fire-rated wall assembly with an Intertek-certified, compatible, 3M penetration firestop system having the same fire rating as the wall or floor assembly.
2. FASTENERS: Weld minimum 12 GA, 4-1/2-inch-long, copper-coated steel insulation pins or 12 GA insulated cup head pins to the chemical fume exhaust duct (Item 1). Match fastener method with corresponding insulation (Item 4) method.
 - A. Compression Butt Joint: Locate pins at all blanket overlaps, on all sides of the chemical fume exhaust duct (Item 1), and meet the following requirements.
 - I. Space pins maximum 12 inches apart in rows across the width of the chemical fume exhaust duct (Item 1). Locate pins maximum 6-3/4 inches from the edges of the chemical fume exhaust duct (Item 1). Refer to Section view A-A.

Design No. 3MU/FRD 120-10 *continued*

Flexible Wraps

Duct Wrap

Chemical Fume Exhaust Ducts

FRD

- II. Space the rows of pins maximum 10 inches apart along the length of the chemical fume exhaust duct (Item 1). Where pieces of insulation (Item 4A) are butted together, space edge pins of the insulation (Item 4A) a maximum 2 inches apart. Refer to Section view B-B.
 - III. After insulation (Item 4A) is installed, place minimum 2.5-in. x 2.5-inch-square, galvanized steel, self-locking washer clips onto all insulation pins.
 - IV. After clips are installed, cut off or bend flush with insulation (Item 3) pins that are too long.
- B. Butt Joint with Collar: Locate pins at all blanket overlaps, on all sides of the chemical fume exhaust duct (Item 1), and meet the following requirements.
- I. Space pins maximum 12 inches apart in rows across the width of the chemical fume exhaust duct (Item 1). Locate pins maximum 6-3/4 inches from the edges of the chemical fume exhaust duct (Item 1). Refer to Section view A-A.
 - II. Space the rows of pins maximum 10-1/2 inches apart along the length of the chemical fume exhaust duct (Item 1). Where pieces of insulation (Item 4B) are overlapped, space pins a maximum 1-1/2 inches from the edge of the insulation. Refer to Section view B-B.
 - III. After insulation (Item 4B) is installed, place minimum 2.5-inch x 2.5-inch-square, galvanized steel, self locking washer clips onto all insulation pins.
 - IV. After clips are installed, cut off or bend flush with insulation (Item 4B) pins that are too long.
- C. Single End Overlap (Telescope): Locate pins at all blanket overlaps, on all sides of the chemical fume exhaust duct (Item 1), and meet the following requirements.
- I. Space pins maximum 12 inches apart in rows across the width of the chemical fume exhaust duct (Item 1). Locate pins maximum 6-3/4 inches from the edges of the chemical fume exhaust duct (Item 1). Refer to Section view A-A.
 - II. Space the rows of pins maximum 10-1/2 inches apart along the length of the chemical fume exhaust duct (Item 1). Where pieces of insulation (Item 4C) are butted together, space pins a maximum 1-1/2 inches from the edge of the insulation. Refer to Section view B-B.
 - III. After insulation (Item 4C) is installed, place minimum 2.5-inch x 2.5-inch-square, galvanized steel, self-locking washer clips onto all insulation pins.
 - IV. After clips are installed, cut off or bend flush with insulation (Item 4C) pins that are too long.
- D. Dual End Overlap (Checkerboard): Locate pins at all blanket overlaps, on all sides of the chemical fume exhaust duct (Item 1), and meet the following requirements.
- I. Space pins maximum 12 inches apart in rows across the width of the chemical fume exhaust duct (Item 1). Locate pins maximum 6-3/4 inches from the edges of the chemical fume exhaust duct (Item 1). Refer to Section view A-A.
 - II. Space the rows of pins maximum 10-1/2 inches apart along the length of the chemical fume exhaust duct (Item 1). Where pieces of insulation (Item 4D) are butted together, space pins a maximum 1-1/2 inches from the edge of the insulation. Refer to Section view B-B.
 - III. After insulation (Item 4D) is installed, place minimum 2.5-inch x 2.5-inch-square, galvanized steel, self-locking washer clips onto all insulation pins.
 - IV. After clips are installed, cut off or bend flush with insulation (Item 4D) pins that are too long.
3. BANDING: Not applicable to Item 2A. Option to fasteners Items 2B, 2C and 2D. After insulation (Item 4) is installed, apply minimum 1/2-inch-wide, 0.015-inch-thick stainless steel bands and secured with minimum 1-inch-long stainless steel crimp clamps. When needed to ease installation, use filament tape as a temporary hold for the insulation (Item 4) prior to banding. Place banding a maximum 1-1/2 inches from all insulation (Item 4) edges and a maximum of 10-1/2 inches on center (O.C.). Tension the banding to hold the insulation (Item 4) in place without cutting or damaging the insulation (Item 4) or chemical fume exhaust duct (Item 1).
4. CERTIFIED COMPANY: 3M Company
CERTIFIED PRODUCT: Duct Insulation
MODEL: 3M Fire Barrier™ Duct Wrap 15A- Nominal 1-1/2-inch thick, 8-pcf blanket, made of mineral fibers and encapsulated with aluminum foil scrim.
Or
CERTIFIED COMPANY: 3M Company
CERTIFIED PRODUCT: Duct Insulation
MODEL: 3M Fire Barrier™ Duct Wrap 615+- Nominal 1-1/2-inch thick, 6-pcf density blanket, made of calcium-, silica-, and magnesium-oxide (CSM) fibers, encapsulated with polypropylene-foil or aluminized polyester scrim.
INSULATION: Apply one layer of duct insulation over the entire surface of the chemical fume exhaust duct (Item 1). Use blanket, available in various widths, that is fully-encapsulated or single-faced scrim. Expose the foil-faced side of insulation to view. Wrap one layer of insulation around the chemical fume exhaust duct (Item 1) circumference so that each terminating end of insulation overlaps onto the starting end of insulation a minimum of 3 inches at all transverse joints. Alternate the transverse overlap location so that no two consecutive adjacent overlaps align. Refer to Section view A-A for transverse overlap section view. Cover all visually exposed ends and edges of insulation with nominal 4-inch-wide pressure-sensitive aluminum foil tape.
- A. Compression Butt Joint: Refer to 4A section view B-B. Wrap the chemical fume exhaust duct (Item 1) with one layer of insulation installed with compression butt joints at all longitudinal joints. Compress each end of each piece of insulation together and butt to preceding edge of insulation. Each piece of installed insulation width is 2 inches less than insulation nominal width. (Example: each piece of nominal 24 inch-wide insulation when installed is 22 inches wide.) Install insulation with zero clearance at the surface and mating edges, or in the field between overlaps. Verify all insulation butt joints are a minimum 1-1/2 inches in overall thickness at compression butt joints.

Design No. 3MU/FRD 120-10 *continued*

- B. **Butt Joint with Collar:** Refer to 4B section view B-B. Wrap the chemical fume exhaust duct (Item 1) with one layer of insulation installed with butt joints at all longitudinal joints. Butt each end of each piece of insulation together with preceding edge of insulation. Each piece of installed insulation width is its nominal width. (Example: each piece of nominal 24-inch-wide insulation when installed is 24 inches wide.) Install insulation with zero clearance at the overlaps, or in the field between overlaps. Place and center 6-inch wide-collar of insulation over the butt joint. Overlap 6-inch-wide collar onto each adjacent insulation 3 inches. Verify all insulation butt joints with collars are a minimum 3 inches in overall thickness.
- C. **Single End Overlap (Telescope):** Refer to 4C section view B-B. Wrap the chemical fume exhaust duct (Item 1) with one layer of insulation installed with 3-inch-minimum overlaps at all longitudinal joints. Overlap each adjacent insulation edge with the edge of the next piece of insulation. Install insulation with zero clearance at the overlaps, or in the field between overlaps. Verify all insulation overlaps are nominally 3 inches in overall thickness.
- I. Starting at one end of the chemical fume exhaust duct (Item 1), apply the first piece of insulation around the chemical fume exhaust duct (Item 1) to overlap fasteners (Item 2C). Refer section view A-A.
 - II. Position and overlap the leading edge of the second piece of insulation nominally 3 inches over the flush edge of the first piece of insulation. Place the opposite edge of the second piece of insulation flush against the surface of the chemical fume exhaust duct (Item 1). An “S-shaped” cross section of the insulation is created. Refer to 4C section view B-B.
 - III. Apply all additional pieces of insulation as “S-shaped” cross section of the insulation in compliance with Item 4CII.
- D. **Dual End Overlap (Checkerboard):** Refer to 4D section view B-B. Verify all insulation overlaps are a minimum 3 inches in overall thickness. Do not align two consecutive insulation end overlaps. Overlap each full-width insulation edge with the edge of the “gull wing” (-v-) shaped piece of insulation. Install insulation with zero clearance at the overlaps, or in the field between overlaps. Verify all insulation overlaps are nominally 3 inches in overall thickness.
- I. Wrap the first piece of insulation around the chemical fume exhaust duct (Item 1) so that the insulation is flush against the surface of the chemical fume exhaust duct (Item 1). Position the starting end of the insulation to overlap pins (Item 2A) a minimum of 1-1/2 inches while the edges of the insulation overlap the rows of pins (Item 2B) a minimum of 1-1/2 inches.
 - II. Position the second piece of insulation nominally 18 inches from the edge of the first piece of insulation. Install the second piece in the same manner as the first.
 - III. Cover the chemical fume exhaust duct (Item 1) that is exposed between the edges of the first two pieces of insulation with another piece of insulation. Position the starting end of the insulation to overlap pins (Item 2A) a minimum of 1-1/2 inches while the edges of the insulation overlap the adjacent edges of the two pieces installed insulation a minimum of 1-1/2 inches.
5. **SUPPORTS:** Support the chemical fume exhaust duct (Item 1) with insulation (Item 4) using a “trapeze” system composed of a minimum 2 x 2 x 1/4-inch steel angle as the trapeze cross-member and minimum 3/8-inch diameter rods. Connect all-thread steel rods (insulation (Item 4) not required) to the trapeze cross-member using nuts and washers. Connect the all-thread steel rods to the bottom of the floor assembly using an attachment method designed to carry the weight of the chemical fume exhaust duct (Item 1) with insulation (Item 4) under a fire load equivalent to ASTM E 119 time-temperature curve. Place one all-thread steel rod 2 inches from each end of trapeze cross-member. Center chemical fume exhaust duct (Item 1) with insulation (Item 4) on trapeze cross-member. Space all-thread steel rods a maximum 6 inches from surface of the insulated chemical fume exhaust duct. Extend trapeze cross-member at least 2 inches past each all-thread steel rod. Space trapeze supports a maximum 60 inches O.C.
6. **CERTIFIED MANUFACTURER:** 3M Company
CERTIFIED PRODUCT: 3M Fire Barrier™ Grease Duct Access Door
MODELS: 000-51115-16584-9 (20 x 20), 000-51115-16583-2 (12 x 8), and 000-51115-16582-5 (10 x 6)
ACCESS DOOR ASSEMBLY: (Not shown) When required, apply an access door and insulated cover plate as described:
- A. **OPTIONAL PRE-FABRICATED ACCESS DOOR:** Mark a clean-out access opening location on the chemical fume exhaust duct (Item 1) with insulation (Item 4) at its mid-height along the horizontal section. Cut an opening (maximum 22 x 22 inches) in the insulation (Item 4) 2 inches larger than the outside dimension of the pre-fabricated access door (maximum 20 x 20 inches). Remove and discard the cut insulation (Item 4). Cut an opening (maximum 20 x 20 inches) into the side of the chemical fume exhaust duct (Item 1) according to the manufacturer’s instructions for the size of the pre-fabricated access door to be installed. Install and tightly secure the pre-fabricated access door in accordance with the manufacturer’s instructions to the chemical fume exhaust duct (Item 1). Pre-fabricated access door fitted with four 3/8-inch diameter corner thumb bolts through the exterior face.
- B. **CERTIFIED COMPANY:** 3M Company
CERTIFIED PRODUCT: Duct Insulation
MODEL: 3M Fire Barrier™ Duct Wrap 15A
CERTIFIED COMPANY: 3M Company
CERTIFIED PRODUCT: Duct Insulation
MODEL: 3M Fire Barrier™ Duct Wrap 615+
ACCESS INSULATION: (Not Shown) Remove the four corner 3/8-inch diameter thumb bolts and replace them with four 3/8-inch-diameter all-thread steel rods extending from prefabricated access door (Item 6A). Apply 2 layers of access insulation over the pre-fabricated access door (Item 6A) as follows. Cut the first piece of access insulation a minimum 1/4 inch larger than the clean-out access opening. Position, square and impale the first piece of the access insulation over the four 3/8-inch diameter all-thread steel rods extending from pre-fabricated access door (Item 6A). Press the first piece of access insulation flush over the prefabricated access door (Item 6A). Compress and abut the cut edges of the first piece of the access insulation against the cut edges of opening in the insulation (Item 4). Cut a second piece of access insulation a minimum of 2 inches larger than first piece of access insulation on all sides. Seal cut edges of the second piece of access insulation with nominal 4-inch wide aluminum foil tape. Position, square and impale the second piece of the access insulation over the four 3/8-inch-diameter all-thread steel rods extending from pre-fabricated access door (Item 6A). Press the second piece of access insulation flush over first piece of access insulation.

Design No. 3MU/FRD 120-10 *continued*

Flexible Wraps

Duct Wrap

Chemical Fume Exhaust Ducts

FRD

- C. COVER PLATE: Cut a cover plate to the same dimensions as the second piece of access insulation (Item 6B) using a minimum 16 GA steel sheet. Drill holes in the cover plate that match the location of the four 3/8-inch diameter all-thread steel rods and locate the holes so that the cover plate is squared to the second piece of access insulation (Item 6B). After both layers of access insulation (Item 6B) are impaled over the four 3/8-inch diameter all-thread steel rods install the cover plate. Pass the four 3/8-inch diameter all-thread steel rods through the cover plate. Place washers and wing nuts onto each of the four 3/8 inch-diameter all-thread steel rods. Secure the cover plate by tightening wing nuts.
7. OPTIONAL FIELD FABRICATED ACCESS DOORS: (Not shown) Mark a clean-out access opening location on the chemical fume exhaust duct (Item 1) with insulation (Item 4) at its mid-height along the horizontal section. Use either option A or B.
- A. (OPTION A) Cut a 13 x 13-inch opening in the insulation (Item 4). Remove and discard the cut insulation (Item 4). Cut a 10 x 10-inch opening into the side of the chemical fume exhaust duct (Item 1) maintaining a 1-inch clearance around the perimeter of the opening and the cut insulation (Item 4). Remove and discard the cut steel. Weld four 4 x 1/4-inch all-thread rods to the chemical fume exhaust duct (Item 1). Locate one at each corner of the chemical fume exhaust duct (Item 1) so that they are 11 inches O.C. and squared within the insulation (Item 4) opening.
- I. ACCESS DOOR: Cut a 13 x 13-inch, 16 GA steel plate to be used as an access door. Drill clearance holes in the access door to match the all-thread steel rod pattern. Place the access door over the all-thread steel rods. Seal the opening in the chemical fume exhaust duct (Item 1) by overlapping the access door over the opening cut in the insulation (Item 4) by 1-1/2-inches on all sides. Weld four 6-1/2-inch-long, 12 GA copper-coated steel insulation pins to the access door corners so that the pins are 9 inches O.C.
- III. CERTIFIED COMPANY: 3M Company
CERTIFIED PRODUCT: Duct Insulation
MODEL: 3M Fire Barrier™ Duct Wrap 15A
CERTIFIED COMPANY: 3M Company
CERTIFIED PRODUCT: Duct Insulation
MODEL: 3M Fire Barrier™ Duct Wrap 615+
ACCESS INSULATION: Apply two layers of access insulation over the access door. Cut the first piece of access insulation into a 13 x 13-inch square and install it over the insulation pins and covering the access door (Item 7AI). Cut the second piece of access insulation into a 15 x 15 inch square. Square it to and install it over the insulation pins. Cover the first piece of access insulation so that a 1-inch overlap exists. Secure blanket to pins with 1-1/2-inch square or round, galvanized or stainless steel speed clips. Turn down or cut off insulation pins that extend beyond the second piece of access insulation. Place steel tubing over each all-thread steel rods. Apply washers and wing nuts over the all-thread steel rods. Secure the access door by tightening the wing nuts.
- B. (OPTION B) Cut a maximum 16 x 16-inch opening into the insulation (Item 4) and the chemical fume exhaust duct (Item 1). Remove and discard the cut insulation (Item 4) and steel. Weld together 4 pieces of 1-1/2 x 1-1/4 x 1/8-inch steel angle to form a flanged frame. The narrow frame edge is welded to the visual surface of the chemical fume exhaust duct (Item 1) at the perimeter of the opening that positions the 1-1/2-inch flange 1-1/4 inches off the chemical fume exhaust duct (Item 1). The flange extends away from the opening. Weld four minimum 4-inch-long 1/4-inch-diameter all-thread steel rods to the flange. Locate one each in the center of each corner.
- I. ACCESS DOOR: Cut an 18-1/2 x 18-1/2-inch 16 GA steel plate to be used as an access door. Drill clearance holes in the access door to match the all-thread steel rod pattern on the flange. Place the access door over the all-thread steel rods.
- II. COVER PLATE: Cut a 20-1/2 x 20-1/2-inch external cover plate out of 16 GA steel and drill clearance holes matching the locations of the all-thread steel rods on the flange. Weld minimum four 12 GA copper-coated steel impaling pins onto the internal surface of the cover plate, spaced minimum 14 inches O.C. Install access insulation (Item 7BIII). Position the cover plate with access insulation over the all-thread steel rods flush to access door. Apply washers and wing nuts over the all-thread steel rods. Secure the access door by tightening the wing nuts.
- III. CERTIFIED COMPANY: 3M Company
CERTIFIED PRODUCT: Duct Insulation
MODEL: 3M Fire Barrier™ Duct Wrap 15A
CERTIFIED COMPANY: 3M Company
CERTIFIED PRODUCT: Duct Insulation
MODEL: 3M Fire Barrier™ Duct Wrap 615+
ACCESS INSULATION: Apply two layers of access insulation over the interior of the cover plate. Cut the first piece of access insulation into a 20-1/2 x 20-1/2-inch square and install it over the insulation pins on the internal surface of the cover plate. Cut the second piece of access insulation into a 24 x 24-inch square. Square it to and install it over the insulation pins. Cover the first piece of access insulation so that a 3-1/2-inch overlap exists. Secure blanket to pins with 1-1/2-inch square or round, galvanized or stainless steel speed clips. Turn down or cut off insulation pins that extend beyond the second piece of access insulation.

This material was extracted and drawn by 3M Fire Protection Products from the 2013 Product Directory, © Intertek

Design No. 3MU/FRD 120-11

April 05, 2013

OPL Design Number: CFD 501 F

CHEMICAL FUME EXHAUST DUCT PROTECTION

3M Company

3M Fire Barrier™ Duct Wrap 15A or 3M Fire Barrier™ Duct Wrap 615+

UL 1978 (June 25, 2002) Section 12 Temperature Test – Pass

Section 13 Abnormal Temperature Test – Pass

ICC-ES Acceptance Criteria for Grease Duct Enclosure Systems (AC101)

Section 4.5 Fire-Engulfment Test (ASTM E 119 Exposure) – 2 hr

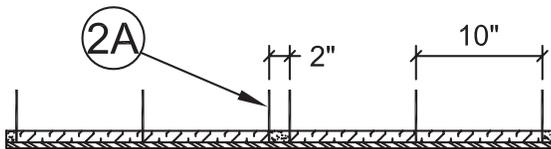
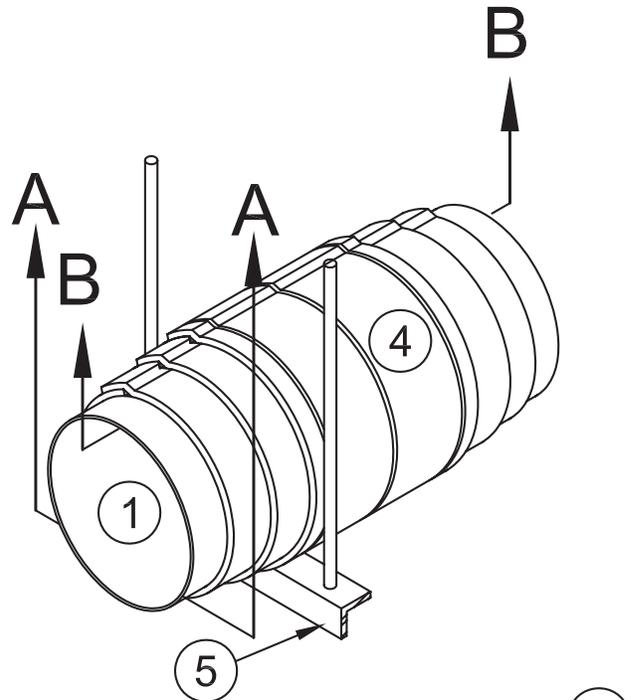
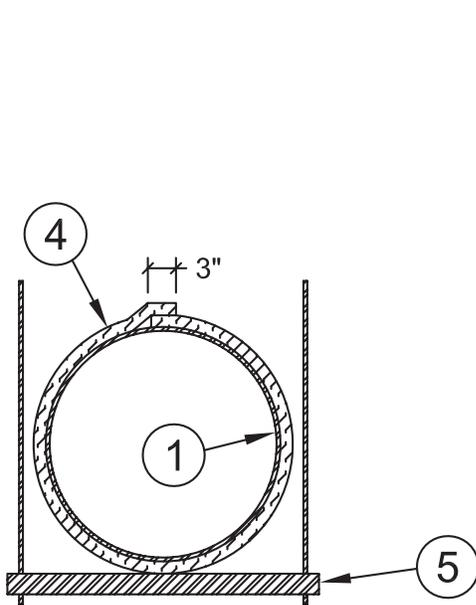

4A Section B-B: Compression Butt Joint

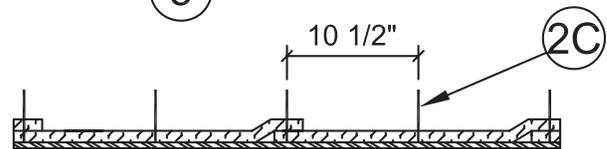

4C Section B-B: Single End Overlap (Telescope)

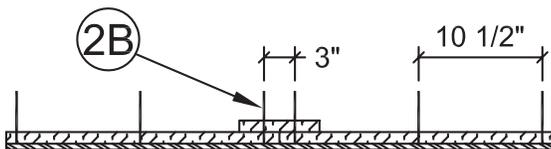

4B Section B-B: Butt Joint with Collar

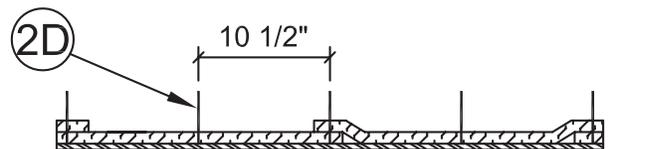

4D Section B-B: Dual End Overlap (Checkerboard)

1. CHEMICAL FUME EXHAUST DUCT: Continuously welded, liquid-tight L-shaped round duct system with horizontal and vertical shafts constructed of 16 GA sheet steel or 18 GA stainless steel with a maximum 1320 inch² area and a maximum 41 inch diameter. When required, equip the duct with a prefabricated access door (Item 6) or field fabricated access door (Item 7).
 - A. Construct the duct using sections affixed to each other with welded seams.
 - B. Reinforce the duct to IMC or NFPA 96 requirements designed to carry the weight of the chemical fume exhaust duct assembly covered with insulation under a fire load equivalent to UL 1978 exposure and the ASTM E 119 time-temperature curve.
 - C. Rigidly support the duct in accordance with IMC or NFPA 96 requirements or as specified in Item 5.
 - D. Protect the annular space around the duct passing through a fire-rated wall assembly with an Intertek-certified, compatible, 3M penetration firestop system having the same fire rating as the wall or floor assembly.
2. FASTENERS: Weld minimum 12 GA, 4-1/2-inch-long, copper-coated steel insulation pins or 12 GA insulated cup head pins to the chemical fume exhaust duct (Item 1). Match fastener method with corresponding insulation (Item 4) method.
 - A. Compression Butt Joint: Locate pins at all blanket overlaps, on all sides of the chemical fume exhaust duct (Item 1), and meet the following requirements.
 - I. Space pins maximum 12 inches apart in rows across the width of the chemical fume exhaust duct (Item 1). Locate pins maximum 6-3/4 inches from the edges of the chemical fume exhaust duct (Item 1). Refer to Section view A-A.

Design No. 3MU/FRD 120-11 *continued*

Flexible Wraps

- II. Space the rows of pins maximum 10 inches apart along the length of the chemical fume exhaust duct (Item 1). Where pieces of insulation (Item 4A) are butted together, space edge pins of the insulation (Item 4A) a maximum 2 inches apart. Refer to Section view B-B.
 - III. After insulation (Item 4A) is installed, place minimum 2.5-inch x 2.5-inch-square, galvanized steel, self-locking washer clips onto all insulation pins.
 - IV. After clips are installed, cut off or bend flush with insulation (Item 3) pins that are too long.
- B. Butt Joint with Collar: Locate pins at all blanket overlaps, on all sides of the chemical fume exhaust duct (Item 1), and meet the following requirements.

- I. Space pins maximum 12 inches apart in rows across the width of the chemical fume exhaust duct (Item 1). Locate pins maximum 6-3/4 inches from the edges of the chemical fume exhaust duct (Item 1). Refer to Section view A-A.
- II. Space the rows of pins maximum 10-1/2 inches apart along the length of the chemical fume exhaust duct (Item 1). Where pieces of insulation (Item 4B) are overlapped, space pins a maximum 1-1/2 inches from the edge of the insulation. Refer to Section view B-B.
- III. After insulation (Item 4B) is installed, place minimum 2.5-inch x 2.5-inch-square, galvanized steel, self-locking washer clips onto all insulation pins.
- IV. After clips are installed, cut off or bend flush with insulation (Item 4B) pins that are too long.

- C. Single End Overlap (Telescope): Locate pins at all blanket overlaps, on all sides of the chemical fume exhaust duct (Item 1), and meet the following requirements.

- I. Space pins maximum 12 inches apart in rows across the width of the chemical fume exhaust duct (Item 1). Locate pins maximum 6-3/4 inches from the edges of the chemical fume exhaust duct (Item 1). Refer to Section view A-A.
- II. Space the rows of pins maximum 10-1/2 inches apart along the length of the chemical fume exhaust duct (Item 1). Where pieces of insulation (Item 4C) are butted together, space pins a maximum 1-1/2 inches from the edge of the insulation. Refer to Section view B-B.
- III. After insulation (Item 4C) is installed, place minimum 2.5-inch x 2.5-inch-square, galvanized steel, self-locking washer clips onto all insulation pins.
- IV. After clips are installed, cut off or bend flush with insulation (Item 4C) pins that are too long.

- D. Dual End Overlap (Checkerboard): Locate pins at all blanket overlaps, on all sides of the chemical fume exhaust duct (Item 1), and meet the following requirements.

- I. Space pins maximum 12 inches apart in rows across the width of the chemical fume exhaust duct (Item 1). Locate pins maximum 6-3/4 inches from the edges of the chemical fume exhaust duct (Item 1). Refer to Section view A-A.
- II. Space the rows of pins maximum 10-1/2 inches apart along the length of the chemical fume exhaust duct (Item 1). Where pieces of insulation (Item 4D) are butted together, space pins a maximum 1-1/2 inches from the edge of the insulation. Refer to Section view B-B.
- III. After insulation (Item 4D) is installed, place minimum 2.5-inch x 2.5-inch-square, galvanized steel, self-locking washer clips onto all insulation pins.
- IV. After clips are installed, cut off or bend flush with insulation (Item 4D) pins that are too long.

3. BANDING: (Not Shown) Not applicable to Item 2A. Option to fasteners Items 2B, 2C and 2D. After insulation (Item 4) is installed, apply minimum 1/2-inch-wide, 0.015-inch-thick stainless steel bands and secured with minimum 1-inch-long stainless steel crimp clamps. When needed to ease installation, use filament tape as a temporary hold for the insulation (Item 4) prior to banding. Place banding a maximum 1-1/2 inches from all insulation (Item 4) edges and a maximum of 10-1/2 inches on center (O.C.). Tension the banding to hold the insulation (Item 4) in place without cutting or damaging the insulation (Item 4) or chemical fume exhaust duct (Item 1).

4. CERTIFIED COMPANY: 3M Company

CERTIFIED PRODUCT: Duct Insulation

MODEL: 3M Fire Barrier™ Duct Wrap 15A- Nominal 1-1/2-inch thick, 8-pcf blanket, made of mineral fibers and encapsulated with aluminum foil scrim.

Or

CERTIFIED COMPANY: 3M Company

CERTIFIED PRODUCT: Duct Insulation

MODEL: 3M Fire Barrier™ Duct Wrap 615+- Nominal 1-1/2-inch thick, 6-pcf density blanket, made of calcium-, silica-, and magnesium-oxide (CSM) fibers, encapsulated with polypropylene-foil or aluminized polyester scrim.

INSULATION: Apply one layer of duct insulation over the entire surface of the chemical fume exhaust duct (Item 1). Use blanket, available in various widths, that is fully-encapsulated or single-faced scrim. Expose the foil-faced side of insulation to view. Wrap one layer of insulation around the chemical fume exhaust duct (Item 1) circumference so that each terminating end of insulation overlaps onto the starting end of insulation a minimum of 3 inches at all transverse joints. Alternate the transverse overlap location so that no two consecutive adjacent overlaps align. Refer to Section view A-A for transverse overlap section view. Cover all visually exposed ends and edges of insulation with nominal 4-inch-wide pressure-sensitive aluminum foil tape.

- A. Compression Butt Joint: Refer to 4A section view B-B. Wrap the chemical fume exhaust duct (Item 1) with one layer of insulation installed with compression butt joints at all longitudinal joints. Compress each end of each piece of insulation together and butt to preceding edge of insulation. Each piece of installed insulation width is 2 inches less than insulation nominal width. (Example: each piece of nominal 24-inch-wide insulation when installed is 22 inches wide.) Install insulation with zero clearance at the surface and mating edges, or in the field between overlaps. Verify all insulation butt joints are a minimum 1-1/2 inches in overall thickness at compression butt joints.

Duct Wrap

Chemical Fume Exhaust Ducts

FRD

Design No. 3MU/FRD 120-11 *continued*

- B. **Butt Joint with Collar:** Refer to 4B section view B-B. Wrap the chemical fume exhaust duct (Item 1) with one layer of insulation installed with butt joints at all longitudinal joints. Butt each end of each piece of insulation together with preceding edge of insulation. Each piece of installed insulation width is its nominal width. (Example: each piece of nominal 24 inch-wide insulation when installed is 24 inches wide.) Install insulation with zero clearance at the overlaps, or in the field between overlaps. Place and center 6-inch-wide collar of insulation over the butt joint. Overlap 6-inch-wide collar onto each adjacent insulation 3 inches. Verify all insulation butt joints with collars are a minimum 3 inches in overall thickness.
- C. **Single End Overlap (Telescope):** Refer to 4C section view B-B. Wrap the chemical fume exhaust duct (Item 1) with one layer of insulation installed with 3-inch-minimum overlaps at all longitudinal joints. Overlap each adjacent insulation edge with the edge of the next piece of insulation. Install insulation with zero clearance at the overlaps, or in the field between overlaps. Verify all insulation overlaps are nominally 3 inches in overall thickness.
- I. Starting at one end of the chemical fume exhaust duct (Item 1), apply the first piece of insulation around the chemical fume exhaust duct (Item 1) to overlap fasteners (Item 2C). Refer section view A-A.
 - II. Position and overlap the leading edge of the second piece of insulation nominally 3 inches over the flush edge of the first piece of insulation. Place the opposite edge of the second piece of insulation flush against the surface of the chemical fume exhaust duct (Item 1). An “S-shaped” cross section of the insulation is created. Refer to 4C section view B-B.
 - III. Apply all additional pieces of insulation as “S-shaped” cross section of the insulation in compliance with Item 4CII.
- D. **Dual End Overlap (Checkerboard):** Refer to 4D section view B-B. Wrap the chemical fume exhaust duct (Item 1) with one layer of insulation installed with 3-inch-minimum overlaps at all longitudinal joints. Overlap each full-width insulation edge with the edge of the “gull wing” (-v-) shaped piece of insulation. Install insulation with zero clearance at the overlaps, or in the field between overlaps. Verify all insulation overlaps are a minimum 3 inches in overall thickness. Do not align two consecutive insulation end overlaps.
- I. Wrap the first piece of insulation around the chemical fume exhaust duct (Item 1) so that the insulation is flush against the surface of the chemical fume exhaust duct (Item 1). Position the starting end of the insulation to overlap pins (Item 2A) a minimum of 1-1/2 inches while the edges of the insulation overlap the rows of pins (Item 2B) a minimum of 1-1/2 inches.
 - II. Position the second piece of insulation nominally 18 inches from the edge of the first piece of insulation. Install the second piece in the same manner as the first.
 - III. Cover the chemical fume exhaust duct (Item 1) that is exposed between the edges of the first two pieces of insulation with another piece of insulation. Position the starting end of the insulation to overlap pins (Item 2A) a minimum of 1-1/2 inches while the edges of the insulation overlap the adjacent edges of the two pieces installed insulation a minimum of 1-1/2 inches.
5. **SUPPORTS:** Support the chemical fume exhaust duct (Item 1) with insulation (Item 4) using a “trapeze” system composed of a minimum 2 x 2 x 1/4-inch steel angle as the trapeze cross-member and minimum 3/8-inch diameter rods. Connect all-thread steel rods (insulation (Item 4) not required) to the trapeze cross-member using nuts and washers. Connect the all-thread steel rods to the bottom of the floor assembly using an attachment method designed to carry the weight of the chemical fume exhaust duct (Item 1) with insulation (Item 4) under a fire load equivalent to ASTM E 119 time-temperature curve. Place one all-thread steel rod 2 inches from each end of trapeze cross-member. Center chemical fume exhaust duct (Item 1) with insulation (Item 4) on trapeze cross-member. Space all-thread steel rods a maximum 6 inches from surface of the insulated chemical fume exhaust duct. Extend trapeze cross-member at least 2 inches past each all-thread steel rod. Space trapeze supports a maximum 60 inches O.C.
6. **CERTIFIED MANUFACTURER:** 3M Company
CERTIFIED PRODUCT: 3M Fire Barrier™ Grease Duct Access Door
MODELS: 000-51115-16584-9 (20 x 20), 000-51115-16583-2 (12 x 8), and 000-51115-16582-5 (10 x 6)
ACCESS DOOR ASSEMBLY: (Not shown) When required, apply an access door and insulated cover plate as described:
- A. **OPTIONAL PRE-FABRICATED ACCESS DOOR:** Mark a clean-out access opening location on the chemical fume exhaust duct (Item 1) with insulation (Item 4) at its mid-height along the horizontal section. Cut an opening (maximum 22 x 22 inches) in the insulation (Item 4) 2 inches larger than the outside dimension of the pre-fabricated access door (maximum 20 x 20 inches). Remove and discard the cut insulation (Item 4). Cut an opening (maximum 20 x 20 inches) into the side of the chemical fume exhaust duct (Item 1) according to the manufacturer’s instructions for the size of the pre-fabricated access door to be installed. Install and tightly secure the pre-fabricated access door in accordance with the manufacturer’s instructions to the chemical fume exhaust duct (Item 1). Pre-fabricated access door fitted with four 3/8-inch diameter corner thumb bolts through the exterior face.
- B. **CERTIFIED COMPANY:** 3M Company
CERTIFIED PRODUCT: Duct Insulation
MODEL: 3M Fire Barrier™ Duct Wrap 15A
CERTIFIED COMPANY: 3M Company
CERTIFIED PRODUCT: Duct Insulation
MODEL: 3M Fire Barrier™ Duct Wrap 615+
ACCESS INSULATION: (Not Shown) Remove the four corner 3/8-inch diameter thumb bolts and replace them with four 3/8-inch-diameter all-thread steel rods extending from prefabricated access door (Item 6A). Apply 2 layers of access insulation over the pre-fabricated access door (Item 6A) as follows. Cut the first piece of access insulation a minimum 1/4 inch larger than the clean-out access opening. Position, square and impale the first piece of the access insulation over the four 3/8-inch diameter all-thread steel rods extending from pre-fabricated access door (Item 6A). Press the first piece of access insulation flush over the prefabricated access door (Item 6A). Compress and abut the cut edges of the first piece of the access insulation against the cut edges of opening in the insulation (Item 4). Cut a second piece of access insulation a minimum of 2 inches larger than first piece of access insulation on all sides. Seal cut edges of the second piece of access insulation with nominal 4-inch wide aluminum foil tape. Position, square and impale the second piece of the access insulation over the four 3/8-inch-diameter all-thread steel rods extending from pre-fabricated access door (Item 6A). Press the second piece of access insulation flush over first piece of access insulation.

Design No. 3MU/FRD 120-11 *continued*

Flexible Wraps

Duct Wrap

Chemical Fume Exhaust Ducts

FRD

- C. COVER PLATE: Cut a cover plate to the same dimensions as the second piece of access insulation (Item 6B) using a minimum 16 GA steel sheet. Drill holes in the cover plate that match the location of the four 3/8-inch diameter all-thread steel rods and locate the holes so that the cover plate is squared to the second piece of access insulation (Item 6B). After both layers of access insulation (Item 6B) are impaled over the four 3/8-inch diameter all-thread steel rods install the cover plate. Pass the four 3/8-inch diameter all-thread steel rods through the cover plate. Place washers and wing nuts onto each of the four 3/8 inch-diameter all-thread steel rods. Secure the cover plate by tightening wing nuts.
7. OPTIONAL FIELD FABRICATED ACCESS DOORS: (Not shown) Mark a clean-out access opening location on the chemical fume exhaust duct (Item 1) with insulation (Item 4) at its mid-height along the horizontal section. Use either option A or B.
- A. (OPTION A) Cut a 13 x 13-inch opening in the insulation (Item 4). Remove and discard the cut insulation (Item 4). Cut a 10 x 10-inch opening into the side of the chemical fume exhaust duct (Item 1) maintaining a 1-inch clearance around the perimeter of the opening and the cut insulation (Item 4). Remove and discard the cut steel. Weld four 4 x 1/4-inch all-thread rods to the chemical fume exhaust duct (Item 1). Locate one at each corner of the chemical fume exhaust duct (Item 1) so that they are 11 inches O.C. and squared within the insulation (Item 4) opening.
- I. ACCESS DOOR: Cut a 13 x 13 inch 16 GA steel plate to be used as an access door. Drill clearance holes in the access door to match the all-thread steel rod pattern. Place the access door over the all-thread steel rods. Seal the opening in the chemical fume exhaust duct (Item 1) by overlapping the access door over the opening cut in the insulation (Item 4) by 1-1/2-inches on all sides. Weld four 6-1/2-inch-long, 12 GA copper-coated steel insulation pins to the access door corners so that the pins are 9 inches O.C.
- II. CERTIFIED COMPANY: 3M Company
CERTIFIED PRODUCT: Duct Insulation
MODEL: 3M Fire Barrier™ Duct Wrap 15A
CERTIFIED COMPANY: 3M Company
CERTIFIED PRODUCT: Duct Insulation
MODEL: 3M Fire Barrier™ Duct Wrap 615+
ACCESS INSULATION: Apply two layers of access insulation over the access door. Cut the first piece of access insulation into a 13 x 13-inch square and install it over the insulation pins and covering the access door (Item 7AI). Cut the second piece of access insulation into a 15 x 15 inch square. Square it to and install it over the insulation pins. Cover the first piece of access insulation so that a 1-inch overlap exists. Secure blanket to pins with 1-1/2-inch square or round, galvanized or stainless steel speed clips. Turn down or cut off insulation pins that extend beyond the second piece of access insulation. Place steel tubing over each all-thread steel rods. Apply washers and wing nuts over the all-thread steel rods. Secure the access door by tightening the wing nuts.
- B. (OPTION B) Cut a maximum 16 x 16-inch opening into the insulation (Item 4) and the chemical fume exhaust duct (Item 1). Remove and discard the cut insulation (Item 4) and steel. Weld together 4 pieces of 1-1/2 x 1-1/4 x 1/8 inch steel angle to form a flanged frame. The narrow frame edge is welded to the visual surface of the chemical fume exhaust duct (Item 1) at the perimeter of the opening that positions the 1-1/2-inch flange 1-1/4 inches off the chemical fume exhaust duct (Item 1). The flange extends away from the opening. Weld four minimum 4-inch-long 1/4-inch-diameter all-thread steel rods to the flange. Locate one each in the center of each corner.
- I. ACCESS DOOR: Cut an 18-1/2 x 18-1/2-inch 16 GA steel plate to be used as an access door. Drill clearance holes in the access door to match the all-thread steel rod pattern on the flange. Place the access door over the all-thread steel rods.
- II. COVER PLATE: Cut a 20-1/2 x 20-1/2-inch external cover plate out of 16 GA steel and drill clearance holes matching the locations of the all-thread steel rods on the flange. Weld minimum four 12 GA copper-coated steel impaling pins onto the internal surface of the cover plate, spaced minimum 14 inches O.C. Install access insulation (Item 7BIII). Position the cover plate with access insulation over the all-thread steel rods flush to access door. Apply washers and wing nuts over the all-thread steel rods. Secure the access door by tightening the wing nuts.
- III. CERTIFIED COMPANY: 3M Company
CERTIFIED PRODUCT: Duct Insulation
MODEL: 3M Fire Barrier™ Duct Wrap 15A
CERTIFIED COMPANY: 3M Company
CERTIFIED PRODUCT: Duct Insulation
MODEL: 3M Fire Barrier™ Duct Wrap 615+
ACCESS INSULATION: Apply two layers of access insulation over the interior of the cover plate. Cut the first piece of access insulation into a 20-1/2 x 20-1/2-inch square and install it over the insulation pins on the internal surface of the cover plate. Cut the second piece of access insulation into a 24 x 24-inch square. Square it to and install it over the insulation pins. Cover the first piece of access insulation so that a 3-1/2-inch overlap exists. Secure blanket to pins with 1-1/2-inch square or round, galvanized or stainless steel speed clips. Turn down or cut off insulation pins that extend beyond the second piece of access insulation.

This material was extracted and drawn by 3M Fire Protection Products from the 2013 Product Directory, © Intertek

3M Firestop Systems
Flexible Wraps

Penetration Systems

Duct Wraps

PV

Through Wall Assembly

PH

Through Floor Assembly

Penetration Systems - Duct Wrap

| 3M Systems | "F" Rating | 3M Product | Application Details |
|-------------------------------|------------|---|--|
| Through Floor Assembly | | | |
| 3MU/PH 60-01 | | 3M™ Fire Barrier Duct Wrap 615 3M™ Fire Barrier Water Tight Sealant 1000 NS 3M™ Fire Barrier Silicone Sealant 2000+ | Max 24" x 30" rectangular or max 30" round minimum 24 gauge steel duct. Gypsum wallboard assemble. Max opening 1118 sq. in. with max dimension 35.5". Concentric/eccentric installation. Min 5/8" to max 3-1/2" annular space. 3M Fire Barrier Duct Wrap runs through wall. Packing wool required. 1 hour F and T rating. |
| 3MU/PH 60-03 | | 3M™ Fire Barrier Duct Wrap 615 3M™ Fire Barrier Water Tight Sealant 1000 NS | Max 85" x 24" min 24 ga. steel duct. Gypsum wall assembly. Max opening 2492 sq. in. with max dimension of 89". Duct protected with Fire Barrier Duct Wrap 615 which abuts the opening. Eccentric installation. Min 1" to max 3" annular. 1 hour F and T rating. Packing material, retaining angles, and 24" wide collar abutting the firestop system required. |
| 3MU/PH 60-04 | | 3M™ Fire Barrier Duct Wrap 615 3M™ Fire Barrier Water Tight Sealant 1000 NS | Max 85" x 24" min 24 ga. steel duct. Gypsum wall assemble. Max opening 2492 sq. in. with max dimension of 89". Duct protected with Fire Barrier Duct Wrap 615 which abuts the opening. Min 1" to max 3" annular. 1 hour F and T rating. Packing material, retaining angles, and 24 wide collar abutting the firestop system required. Tested to ISO 6944. |
| 3MU/PH 120-14 | 2 | 3M™ Fire Barrier Water Tight Sealant 1000 NS 3M™ Fire Barrier Silicone Sealant 2000+ 3M™ Fire Barrier Duct Wrap 615 | Max 24" x 30" rectangular or max 30" round minimum 24 gauge steel duct. Gypsum wallboard assembly. Max opening 1118 sq. in. with max dimension 35.5". Concentric/eccentric installation. Min 5/8" to max 3-1/2" annular space. 3M Fire Barrier Duct Wrap runs through wall. Packing wool required. 2 hour F and T rating. |
| 3MU/PH 120-16 | 2 | 3M™ Fire Barrier Water Tight Sealant 1000 NS 3M™ Fire Barrier Silicone Sealant 2000+ 3M™ Fire Barrier Duct Wrap 615 | Max 24" x 30" rectangular or max 30" round minimum 24 gauge steel duct, Concrete wall. Max opening 891 sq. in. with max dimension 33". Concentric/eccentric installation. Min 1" to max 2" annular space. 3M Fire Barrier Duct Wrap abuts the opening. Packing material required. 2 hour F & T rating. |
| 3MU/PH 120-21 | 2 | 3M™ Fire Barrier Duct Wrap 615 3M™ Fire Barrier Water Tight Sealant 1000 NS | Max 85" x 24" min 24 ga. steel duct. Concrete wall. Max opening 2492 sq. in. with max dimension of 89". Duct protected with Fire Barrier Duct Wrap 615 which abuts the opening. Min 1" to max 3" annular. 2 hour F and T rating. Packing material, retaining angles, and 24" wide collar abutting the firestop system required. Tested to ISO 6944. |
| 3MU/PH 120-22 | 2 | 3M™ Fire Barrier Duct Wrap 615 3M™ Fire Barrier Water Tight Sealant 1000 NS | Max 85" x 24" min 24 ga. steel duct. Gypsum shaft wall assembly. Max opening 2492 sq. in. with max dimension of 89". Duct protected with Fire Barrier Duct Wrap 615 which abuts the opening. Eccentric installation. Min 1 in. to max 3" annular. 2 hour F and T rating. Packing material, retaining angles, and 24" wide collar abutting the firestop system required. Tested to ISO 6944 |
| 3MU/PH 120-23 | 2 | 3M™ Fire Barrier Duct Wrap 615 3M™ Fire Barrier Water Tight Sealant 1000 NS | Max 85" x 24" min 24 ga. steel duct. Concrete block wall. Max opening 2492 sq. in. with max dimension of 89". Duct protected with Fire Barrier Duct Wrap 615 which abuts the opening. Min 1" to max 3" annular. 2 hour F and T rating. Packing material, retaining angles, and 24" wide collar abutting the firestop system required. Tested to ASTM E 814-06. |
| 3MU/PH 120-24 | 2 | 3M™ Fire Barrier Duct Wrap 615 3M™ Fire Barrier Water Tight Sealant 1000 NS | Max 85" x 24" min 24 ga. steel duct. Concrete wall. Max opening 2492 sq. in. with max dimension of 89 in. Duct protected with Fire Barrier Duct Wrap 615 which abuts the opening. Min 1" to max 3" annular. 2 hour F and T rating. Packing material, retaining angles, and 24" wide collar abutting the firestop system required. Tested to ASTM E 814-06. |
| 3MU/PH 120-25 | 2 | 3M™ Fire Barrier Duct Wrap 615 3M™ Fire Barrier Water Tight Sealant 1000 NS | Max 85" x 24" min 22 ga. steel duct. Gypsum wallboard assembly. Max opening 2492 sq. in. with max dimension of 89". Duct protected with Fire Barrier Duct Wrap 615 which abuts the opening. Min 1" to max 3" annular. 2 hour F and T rating. Packing material, retaining angles, and 24" wide collar abutting the firestop system required. Tested to ASTM E 814-06. |
| 3MU/PH 120-26 | 2 | 3M™ Fire Barrier Duct Wrap 615 3M™ Fire Barrier Water Tight Sealant 1000 NS | Max 85" x 24" min 24 ga. steel duct. Gypsum shaft wall assembly. Max opening 2492 sq. in. with max dimension of 89". Duct protected with Fire Barrier Duct Wrap 615 which abuts the opening. Eccentric installation. Min 1" to max 3" annular. 2 hour F and T rating. Packing material, retaining angles, and 24" wide collar abutting the firestop system required. |

Penetration Systems - Duct Wrap

| 3M Systems | "F" Rating | 3M Product | Application Details |
|------------------------------|------------|---|---|
| 3MU/PH 120-27 | 2 | 3M™ Fire Barrier Duct Wrap 615 3M™ Fire Barrier Water Tight Sealant 1000 NS | Max 85" x 24" min 24 ga. steel duct. Concrete wall. Max opening 2492 sq. in. with max dimension of 89". Duct protected with Fire Barrier Duct Wrap 615 which abuts the opening. Eccentric installation. Min 1" to max 3" annular. 2 hour F and T rating. Packing material, retaining angles, and 24" wide collar abutting the firestop system required. |
| 3MU/PH 120-28 | 2 | 3M™ Fire Barrier Duct Wrap 615 3M™ Fire Barrier Water Tight Sealant 1000 NS | Max 85" x 24" min 22 ga. steel duct. Gypsum wallboard assembly. Max opening 2492 sq. in. with max dimension of 89". Duct protected with Fire Barrier Duct Wrap 615 which abuts the opening. Min 1" to max 3" annular. 2 hour F and T rating. Packing material, retaining angles, and 24" wide collar abutting the firestop system required. Tested to ISO 6944. |
| Through Wall Assembly | | | |
| 3MU/PV 60-01 | 1 | 3M™ Fire Barrier Duct Wrap 615 3M™ Fire Barrier Water Tight Sealant 1000 NS 3M™ Fire Barrier Water Tight Sealant 1003 SL 3M™ Fire Barrier Silicone Sealant 2000+ | 24 Gauge steel duct max 720 sq. in. withmax 30 in. dimension wrapped with Fire Barrier Duct Wrap 615 through a wood framed floor assembly. |
| 3MU/PV 60-03 | 1 | 3M™ Fire Barrier Duct Wrap 615 3M™ Fire Barrier Water Tight Sealant 1000 NS | 22 Gauge steel duct max 2040 sq. in. withmax 85 in. dimension through a wood framed floor assembly. Duct wrapped with Fire Barrier Duct Wrap 615. Wrap Terminates top and bototm side. through a wood framed floor assembly. Additional collar. |
| 3MU/PV 60-04 | 1 | 3M™ Fire Barrier Duct Wrap 615 3M™ Fire Barrier Water Tight Sealant 1000 NS 3M™ Fire Barrier Water Tight Sealant 1003 SL 3M™ Fire Barrier Silicone Sealant 2000+ | 22 Gauge steel duct max 2040 sq. in. withmax 85 in. dimension through a wood framed floor assembly. Duct wrapped with Fire Barrier Duct Wrap 615. Wrap Terminates top and bototm side. through a wood framed floor assembly. Additional collar. |
| 3MU/PV 120-03 | | 3M™ Fire Barrier Duct Wrap 615 3M™ Fire Barrier Water Tight Sealant 1000 NS 3M™ Fire Barrier Water Tight Sealant 1003 SL 3M™ Fire Barrier Silicone Sealant 2000+ | 24 Gauge steel duct max 720 sq. in. withmax 30 in. dimension wrapped with Fire Barrier Duct Wrap 615 through a concrete floor assembly. |
| 3MU/PV 120-04 | 3 | 3M™ Fire Barrier Duct Wrap 615 3M™ Fire Barrier Water Tight Sealant 1000 NS 3M™ Fire Barrier Water Tight Sealant 1003 SL 3M™ Fire Barrier Silicone Sealant 2000+ | 24 Gauge steel duct max 720 sq. in. withmax 30 in. dimension penatating a concrete floor. Duct wrapped with Fire Barrier Duct Wrap 615 which terminated top and bottom side of the assembly. |

Design No. 3MU/PV 60-01

OPL Design Number FS 558 F

November 14, 2008

PENETRATION FIRESTOP THROUGH FLOOR/CEILING ASSEMBLY

3M Company

3M Fire Barrier™ Duct Wrap 15A or 20A

3M Fire Barrier™ Duct Wrap 615

3M Fire Barrier™ 2000+ Silicone Joint Sealant

3M Fire Barrier™ Water Tight 1000-NS Silicone Joint Sealant

3M Fire Barrier™ Water Tight 1003-SL Silicone Joint Sealant

ASTM E 814-06

T Rating – 1 hr

F Rating – 1 hr

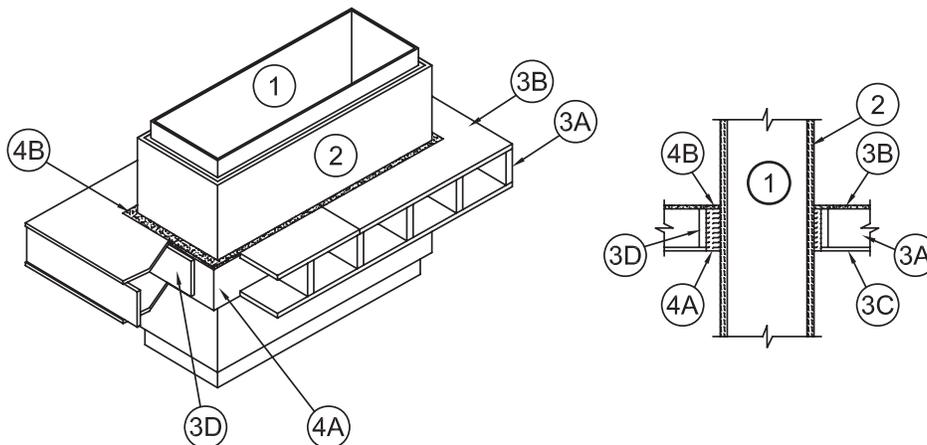

1. PENETRATING ITEM: Rectangular or round steel duct constructed of minimum 24 GA sheet steel with maximum 720 inch² area with a maximum 30 inch dimension or 30 inch diameter.
2. CERTIFIED MANUFACTURER: 3M Company
CERTIFIED PRODUCT: 3M Fire Barrier™ Duct Wrap
MODEL: 15A, 20A
MODEL: 615: Option for FRD Ventilation Ducts (Old Designation VAD)
INSULATION: Before the packing material (Item 4A) and fill material (Item 4B) of the penetration firestop (Item 4) is installed, protect the penetrating item (Item 1) with at least one layer of minimum 24-inch-wide certified insulation. Minimum 8 pcf density required for grease duct applications. Wrap penetrating item (Item 1) with a one layer of certified insulation, overlap the ends of certified insulation and secure certified insulation to penetrating item (Item 1) in accord with any 1-hour-rated 3M FRD design listing.
3. FLOOR ASSEMBLY – Install penetrating item (Item 1) through a framed hole created in an ASTM E 119 (UL 263 or NFPA 251) one-hour fire-rated floor assembly having the following components as part of its construction:
 - A. Joists – Minimum 2 x 10 wood joists spaced a maximum 18-1/2 inches on center (OC).
 - B. Flooring – Minimum 3/4-inch-thick plywood attached to the top of wood joists.
 - C. Gypsum Board – Minimum one layer of 5/8-inch-thick, Type X, gypsum wallboard attached to the bottom of wood joists.
 - D. Reinforcement – When the hole penetrates the joists, additional 2 x 10 wood perimeter framing is required to maintain the floor assembly's strength at that location.
 - E. Opening – Create an opening in the wall assembly having a cross-sectional area of maximum 1083 inch² and a maximum dimension of 35.5 inches. Frame opening with joists (Item 3A) and reinforcement (Item 3D). Position the penetrating item (Item 1) concentrically or eccentrically in the opening so that the annular space ranges from minimum 1 inch to maximum 2-1/2 inches.
4. PENETRATION FIRESTOP: Asymmetrical penetration firestop constructed of the following components:
 - A. CERTIFIED MANUFACTURER: 3M Company
CERTIFIED PRODUCT: 3M Fire Barrier™ Duct Wrap
MODEL: 15A, 20A, 615
PACKING MATERIAL: Fill the annular space with minimum 4 pcf mineral wool or certified insulation without the encapsulation (foil scrim). Cut the packing material into strips. Compress packing material nominally 25% and insert packing material into the annual space. Fill the entire annular space. Recess the surface of packing material nominally 3/4 inches from both surfaces of the face layers of the gypsum board of the wall assembly (Item 3).
 - B. CERTIFIED MANUFACTURER: 3M Company
CERTIFIED PRODUCT: 3M Fire Barrier™ Joint Sealant
MODEL: Water Tight 1000-NS Silicone or 2000+ Silicone Joint Sealant or 1003 SL Silicone Joint Sealant
FILL, VOID OR CAVITY MATERIAL: Install minimum 3/4-inch depth of certified fill material into the recess over the packing material (Item 4A) on top sides of the floor assembly (Item 3). Screed certified fill material flush with the surface of the floor assembly (Item 3).

This material was extracted and drawn by 3M Fire Protection Products from the 2010 Product Directory, © Intertek

Design No. 3MU/PV 60-03

January 25, 2008

PENETRATION FIRESTOP THROUGH FLOOR/CEILING ASSEMBLY

3M Company

3M Fire Barrier Duct Wrap

3M Fire Barrier Water Tight 1000-NS Silicone Joint Sealant

ASTM E 814-06

T Rating – 1 hr

F Rating – 1 hr

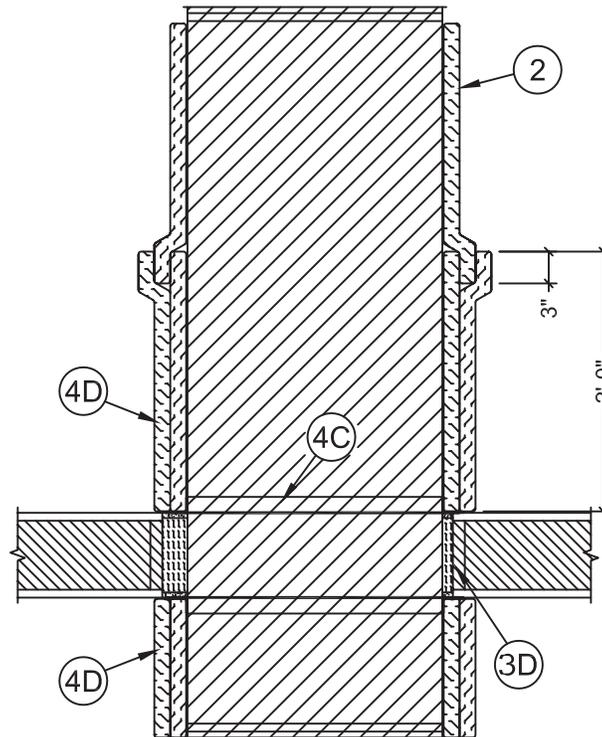

1. PENETRATING ITEM: Rectangular steel duct constructed of minimum 22 GA sheet steel with maximum 2040 inch² area with a maximum 85 inch dimension.
2. CERTIFIED MANUFACTURER: 3M Company
 CERTIFIED PRODUCT: 3M Fire Barrier™ Duct Wrap
 MODEL: 615
 INSULATION: After the packing material (Item 4A) and fill material (Item 4B) of the penetration firestop (Item 4) is installed and the steel angle (Item 4C) attached, protect the penetrating item (Item 1) with at least one layer of minimum 24 inch wide, minimum 6 pcf insulation. Weld mild steel copper plated 12 GA by minimum 7 inch long pins to the bottom of the penetrating item (Item 1) .spaced in 12 inch wide rows with pins spaced 10-1/2 inches apart. Wrap penetrating item (Item 1) with a one layer of certified insulation. Overlap the ends of certified insulation a minimum of 3 inches. Place speed clips over the pins to secure certified insulation on bottom. Use nominal 1/2 inch wide, 0.015 inch thick, stainless steel banding and banding clips placed around the circumference of the penetrating item (Item 1) spaced nominally 10-1/2-inches on center to secure certified insulation.
3. FLOOR ASSEMBLY: Install penetrating item (Item 1) through a framed hole created in an ASTM E 119 (UL 263 or NFPA 251) one-hour fire-rated floor assembly having the following components as part of its construction:
 - A. Joists – Minimum 2 x 10 wood joists spaced a maximum 18-1/2 inches on center (OC).
 - B. Flooring – Minimum 3/4-inch thick plywood attached to the top of wood joists.
 - C. Gypsum Board – Minimum one layer of 5/8-inch thick, Type X, gypsum wallboard attached to the bottom of wood joists.
 - D. Reinforcement – When the hole penetrates the joists additional 2 x 10 wood perimeter framing is required to maintain the floor assembly's strength at that location.
 - E. Opening – Create an opening through the floor assembly to accommodate the protected penetrating item (Item 1) and the conditions of Item 2e. Position the penetrating item (Item 1) concentrically or eccentrically in the opening so that the annular space ranges from minimum 1 inch to maximum 3 inches.

Design No. 3MU/PV 60-03 *continued*

4. PENETRATION FIRESTOP: Symmetrical penetration firestop constructed of the following components:

A. CERTIFIED MANUFACTURER: 3M Company

CERTIFIED PRODUCT: 3M Fire Barrier™ Duct Wrap

MODEL: 615

PACKING MATERIAL: Fill the annular space with minimum 6 pcf insulation without the encapsulation (foil scrim). Cut the certified packing material into strips. Layer certified packing material to 50% greater thickness than width of annular space being filled. Compress certified packing material nominally 33%. Insert compressed certified packing material into the annular space. Fill the entire annular space. Recess the surface of certified packing material nominally 5/8 inches from both surfaces of the face layers of the gypsum board of the wall assembly (Item 3).

B. CERTIFIED MANUFACTURER: 3M Company

CERTIFIED PRODUCT: 3M Fire Barrier™ Joint Sealant

MODEL: Water Tight 1000-NS Silicone

FILL, VOID OR CAVITY MATERIAL: Install minimum 5/8-inch depth of fill material into the recess over the packing material (Item 4A) on both sides of the wall assembly (Item 3). Screed certified fill material flush with the surface of the wall assembly (Item 3) on both sides.

C. STEEL ANGLE: Install nominal 16 GA 2 x 1-1/2 inch steel angle around perimeter of penetrating item (Item 1) with notched ends to create a continuous frame. Place vertical 1-1/2 inch leg of angle flush with exposed face of plywood (Item 3B) and exposed face of gypsum board (Item 3C) of floor/ceiling assembly (Item 3). Attach horizontal 2 inch leg of angle to the penetrating item (Item 1) using self drilling screws, 12-24x2 Hex washer Head with #5 Point, spaced a maximum of 6 inches O.C.

D. CERTIFIED MANUFACTURER: 3M Company

CERTIFIED PRODUCT: 3M Fire Barrier™ Duct Wrap

MODEL: 615

COLLAR: After the penetrating item (Item 1) is insulated with certified insulation (Item 2), install a layer of minimum 24 inch wide, minimum 6 pcf insulation over the penetrating item (Item 1). Position the certified collar abutting the exposed layers on both sides of the floor/ceiling assembly (Item 3). Overlap the ends of the certified collar a minimum of 3 inches. Certified collar covers the steel angle (Item 4C) of the penetration firestop (Item 4).

This material was extracted and drawn by 3M Fire Protection Products from the 2010 Product Directory, © Intertek

Flexible Wraps

Duct Wrap

Through Floor/Ceiling Assembly

PV

Design No. 3MU/PV 60-04

January 25, 2008

PENETRATION FIRESTOP THROUGH FLOOR/CEILING ASSEMBLY

3M Company

3M Fire Barrier Duct Wrap

3M Fire Barrier Water Tight 1000-NS Silicone Joint Sealant

ISO 6944 (1985)

Stability – 1 hr

Insulation – 1 hr

Integrity – 1 hr

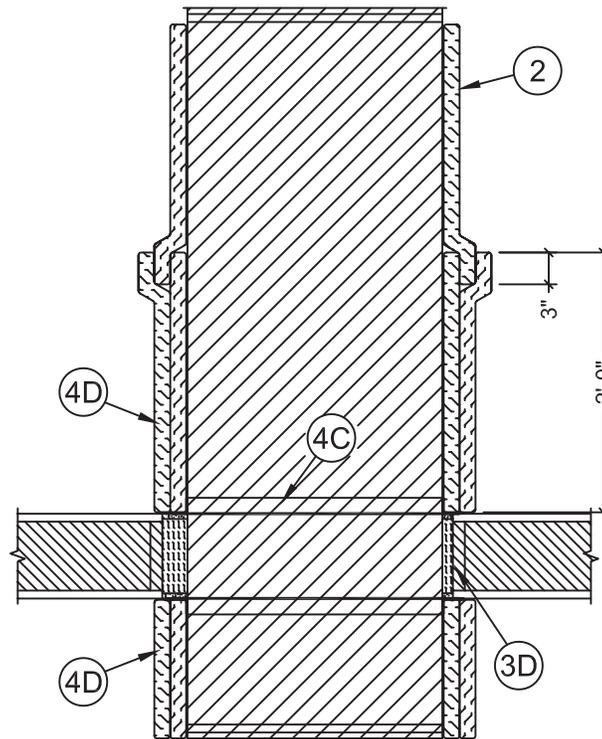

1. PENETRATING ITEM: Rectangular steel duct constructed of minimum 22 GA sheet steel with maximum 2040 inch² area with a maximum 85 inch dimension.
2. CERTIFIED MANUFACTURER: 3M Company
CERTIFIED PRODUCT: 3M Fire Barrier™ Duct Wrap
MODEL: 615
INSULATION: After the packing material (Item 4A) and fill material (Item 4B) of the penetration firestop (Item 4) is installed and the steel angle (Item 4C) attached, protect the penetrating item (Item 1) with insulation applied in accordance with an Intertek ISO 6944 3M Design Listing for a Type A Duct using at least one layer of minimum 24-inch wide, minimum 6 pcf insulation.
3. FLOOR ASSEMBLY: Install penetrating item (Item 1) through a framed hole created in an ASTM E 119 (UL 263 or NFPA 251) one-hour fire-rated floor assembly having the following components as part of its construction:
 - A. Joists – Minimum 2 x 10 wood joists spaced a maximum 18-1/2 inches on center (OC).
 - B. Flooring – Minimum 3/4-inch thick plywood attached to the top of wood joists.
 - C. Gypsum Board – Minimum one layer of 5/8-inch thick, Type X, gypsum wallboard attached to the bottom of wood joists.
 - D. Reinforcement – When the hole penetrates the joists additional 2 x 10 wood perimeter framing is required to maintain the floor assembly's strength at that location.
 - E. Opening – Create an opening through the floor assembly to accommodate the protected penetrating item (Item 1) and the conditions of Item 2e. Position the penetrating item (Item 1) concentrically or eccentrically in the opening so that the annular space ranges from minimum 1 inch to maximum 3 inches.
4. PENETRATION FIRESTOP: Symmetrical penetration firestop constructed of the following components:
 - A. CERTIFIED MANUFACTURER: 3M Company
CERTIFIED PRODUCT: 3M Fire Barrier™ Duct Wrap
MODEL: 615

Design No. 3MU/PV 60-04 *continued*

PACKING MATERIAL: Fill the annular space with minimum 6 pcf insulation without the encapsulation (foil scrim). Cut the certified packing material into strips. Layer certified packing material to 50% greater thickness than width of annular space being filled. Compress certified packing material nominally 33%. Insert compressed certified packing material into the annular space. Fill the entire annular space. Recess the surface of certified packing material nominally 5/8 inches from both surfaces of the face layers of the gypsum board of the wall assembly (Item 3).

- B. **CERTIFIED MANUFACTURER:** 3M Company
CERTIFIED PRODUCT: 3M Fire Barrier™ Joint Sealant
MODEL: Water Tight 1000-NS Silicone

FILL, VOID OR CAVITY MATERIAL: Install minimum 5/8-inch depth of fill material into the recess over the packing material (Item 4A) on both sides of the wall assembly (Item 3). Screenshot certified fill material flush with the surface of the wall assembly (Item 3) on both sides.

- C. **STEEL ANGLE:** Install nominal 16 GA 2 x 1-1/2 inch steel angle around perimeter of penetrating item (Item 1) with notched ends to create a continuous frame. Place vertical 1-1/2 inch leg of angle flush with exposed face of plywood (Item 3B) and exposed face of gypsum board (Item 3C) of floor/ceiling assembly (Item 3). Attach horizontal 2 inch leg of angle to the penetrating item (Item 1) using self drilling screws, 12-24x2 Hex washer Head with #5 Point, spaced a maximum of 6 inches O.C.

- D. **CERTIFIED MANUFACTURER:** 3M Company
CERTIFIED PRODUCT: 3M Fire Barrier™ Duct Wrap
MODEL: 615

COLLAR: After the penetrating item (Item 1) is insulated with certified insulation (Item 2), install a layer of minimum 24 inch wide, minimum 6 pcf insulation over the penetrating item (Item 1). Position the certified collar abutting the exposed layers on both sides of the floor/ceiling assembly (Item 3). Overlap the ends of the certified collar a minimum of 3 inches. Certified collar covers the steel angle (Item 4C) of the penetration firestop (Item 4).

This material was extracted and drawn by 3M Fire Protection Products from the 2010 Product Directory, © Intertek

Flexible Wraps

Duct Wrap

Through Floor/Ceiling Assembly

PV

Design No. 3MU/PV 120-03

OPL Design Number FS 560 F

November 14, 2008

PENETRATION FIRESTOP THROUGH FLOOR ASSEMBLY

3M Company

3M Fire Barrier™ Duct Wrap 15A or 20A

3M Fire Barrier™ Duct Wrap 615

3M Fire Barrier™ 2000+ Silicone Joint Sealant

3M Fire Barrier™ Water Tight 1000-NS Silicone Joint Sealant

3M Fire Barrier™ Water Tight 1003-SL Silicone Joint Sealant

ASTM E 814-06

T Rating – 2 hr

F Rating – 2 hr

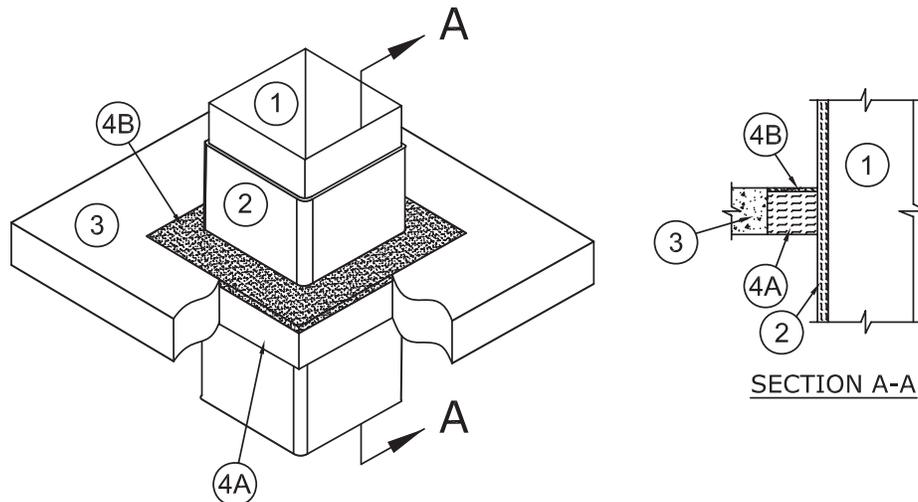

1. PENETRATING ITEM: Rectangular or round minimum 24 GA steel duct constructed of sheet steel with a maximum 720 inch² area with a maximum 30 inch dimension or 30 inch diameter.
2. CERTIFIED MANUFACTURER: 3M Company
CERTIFIED PRODUCT: 3M Fire Barrier™ Duct Wrap
MODEL: 15A, 20A, 615

INSULATION: Before the packing material (Item 4A) and fill material (Item 4B) of the penetration firestop (Item 4) are installed, wrap the penetrating item (Item 1) with at least one layer of minimum 24-inch wide certified insulation. Minimum 8 pcf density required for grease duct applications. Overlap the ends of certified insulation and secure certified insulation to penetrating item (Item 1) in accord with any 2-hour rated 3M FRD design listing.

3. FLOOR ASSEMBLY: Symmetrical two-hour rated solid concrete floor assembly made from reinforced lightweight or normal weight (100-150 pcf or 1600-2400 kg/m³) concrete. Constructed of one of the following:
 - A. Solid Concrete – Minimum concrete thickness measured from exposed face to exposed face using one of the following:
 1. lightweight concrete is 3.6 inches;
 2. sand-lightweight concrete is 3.8 inches;
 3. carbonate aggregate concrete is 4.6 inches; and
 4. siliceous aggregate concrete is 5.0 inches.
 - B. Opening – Create an opening in the floor assembly. Frame opening with steel studs (Item 3A) and tracks (Item 3B). Position the penetrating item (Item 1) concentrically or eccentrically in the opening so that the annular space ranges from minimum 1-1/4 inch to maximum 2-1/2 inches. The opening shall have a cross-sectional area of maximum 1093 inch² and a maximum dimension of 36.75 inches for penetrating item (Item 1).
4. PENETRATION FIRESTOP: Symmetrical penetration firestop constructed of the following components:
 - A. CERTIFIED MANUFACTURER: 3M Company
CERTIFIED PRODUCT: 3M Fire Barrier™ Duct Wrap
MODEL: 15A, 20A, 615
PACKING MATERIAL: Fill the annular space with minimum 4-pcf mineral wool or certified insulation without the encapsulation (foil scrim). Cut the packing material into strips. Compress packing material nominally 25% and insert packing material into the annual space. Fill the entire annular space. Recess the surface of packing material nominally 7/16 inches from top surface of the floor assembly (Item 3).
 - B. CERTIFIED MANUFACTURER: 3M Company
CERTIFIED PRODUCT: 3M Fire Barrier™ Joint Sealant
MODEL: Water Tight 1000-NS Silicone or 2000+ Silicone Joint Sealant or 1003 SL Silicone Joint Sealant
FILL, VOID OR CAVITY MATERIAL: Install minimum 7/16-inch depth of certified fill material into the recess over the packing material (Item 4A) on top side of the floor assembly

This material was extracted and drawn by 3M Fire Protection Products from the 2010 Product Directory, © Intertek

Design No. 3MU/PV 120-04

OPL Design Number FS 561 F

November 14, 2008

PENETRATION FIRESTOP THROUGH FLOOR ASSEMBLY

3M Company

3M Fire Barrier™ Duct Wrap 15A or 20A

3M Fire Barrier™ Duct Wrap 615

3M Fire Barrier™ 2000+ Silicone Joint Sealant

3M Fire Barrier™ Water Tight 1000-NS Silicone Joint Sealant

3M Fire Barrier™ Water Tight 1003-SL Silicone Joint Sealant

ASTM E 814-06

T Rating – 2 hr

F Rating – 2 hr

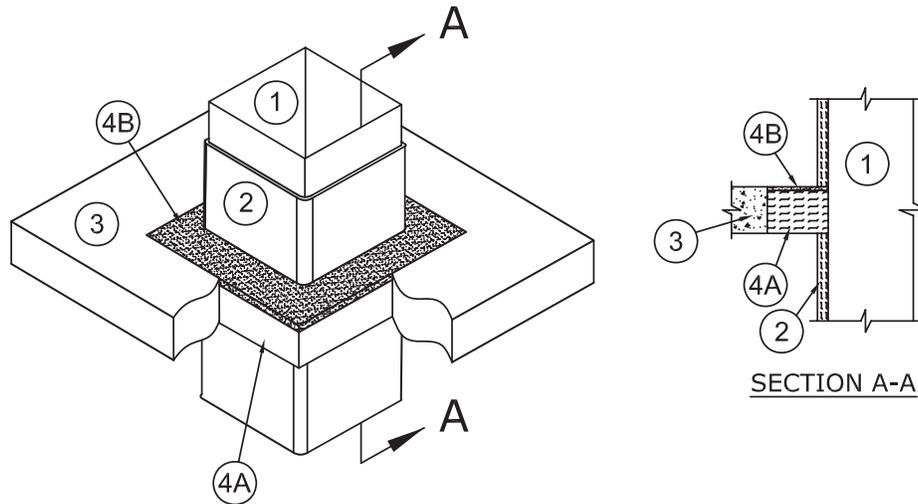

1. PENETRATING ITEM: Rectangular or round minimum 24 GA steel duct constructed of sheet steel with a maximum 720 inch² area with a maximum 30 inch dimension or 30 inch diameter.
2. CERTIFIED MANUFACTURER: 3M Company
CERTIFIED PRODUCT: 3M Fire Barrier™ Duct Wrap
MODEL: 15A, 20A, 615

INSULATION: After the packing material (Item 4A) and fill material (Item 4B) of the penetration firestop (Item 4) are installed, wrap the penetrating item (Item 1) with at least one layer of minimum 24-inch-wide certified insulation. Minimum 8 pcf density required for grease duct applications. Overlap the ends of certified insulation and secure certified insulation to penetrating item (Item 1) in accord with any 2-hour rated 3M FRD design listing. Abut certified insulation to penetration firestop (Item 4) on each side of floor assembly (Item 3).

3. FLOOR ASSEMBLY: Symmetrical two-hour-rated solid concrete floor assembly made from reinforced lightweight or normal weight (100-150 pcf or 1600-2400 kg/m³) concrete. Constructed of one of the following:
 - A. Solid Concrete – Minimum concrete thickness measured from exposed face to exposed face using one of the following:
 1. lightweight concrete is 3.6 inches;
 2. sand-lightweight concrete is 3.8 inches;
 3. carbonate aggregate concrete is 4.6 inches; and
 4. siliceous aggregate concrete is 5.0 inches.
 - B. Opening – Create an opening in the floor assembly. Position the penetrating item (Item 1) concentrically or eccentrically in the opening so that the annular space ranges from minimum 1 inch to maximum 2 inches. The opening shall have a cross-sectional area of maximum 891 inch² and a maximum dimension of 33 inches for penetrating item (Item 1).
4. PENETRATION FIRESTOP: Asymmetrical penetration firestop constructed of the following components:
 - A. CERTIFIED MANUFACTURER: 3M Company
CERTIFIED PRODUCT: 3M Fire Barrier™ Duct Wrap
MODEL: 15A, 20A, 615
PACKING MATERIAL: Fill the annular space with minimum 4-pcf mineral wool or certified insulation without the encapsulation (foil scrim). Cut the packing material into strips. Compress packing material nominally 25% and insert packing material into the annular space. Fill the entire annular space. Recess the surface of packing material nominally 3/8 inches from top surface of the floor assembly (Item 3).
 - B. CERTIFIED MANUFACTURER: 3M Company
CERTIFIED PRODUCT: 3M Fire Barrier™ Joint Sealant
MODEL: Water Tight 1000-NS Silicone or 2000+ Silicone Joint Sealant or 1003 SL Silicone Joint Sealant
FILL, VOID OR CAVITY MATERIAL: Install minimum 3/8-inch depth of certified fill material into the recess over the packing material (Item 4A) on top side of the floor assembly (Item 3). Screed certified fill material flush with the surface of the floor assembly (Item 3). Overlap the fill material onto face of floor assembly (Item 3) a minimum of 1/4 inches.

This material was extracted and drawn by 3M Fire Protection Products from the 2010 Product Directory, © Intertek

Design No. 3MU/PH 60-01

OPL Design Number FS 557 W

November 14, 2008

PENETRATION FIRESTOP THROUGH WALL ASSEMBLY

3M Company

3M Fire Barrier™ Duct Wrap 15A or 20A

3M Fire Barrier™ Duct Wrap 615

3M Fire Barrier™ 2000+ Silicone Joint Sealant

3M Fire Barrier™ Water Tight 1000-NS Silicone Joint Sealant

ASTM E 814-06

T Rating – 1 hr

F Rating – 1 hr

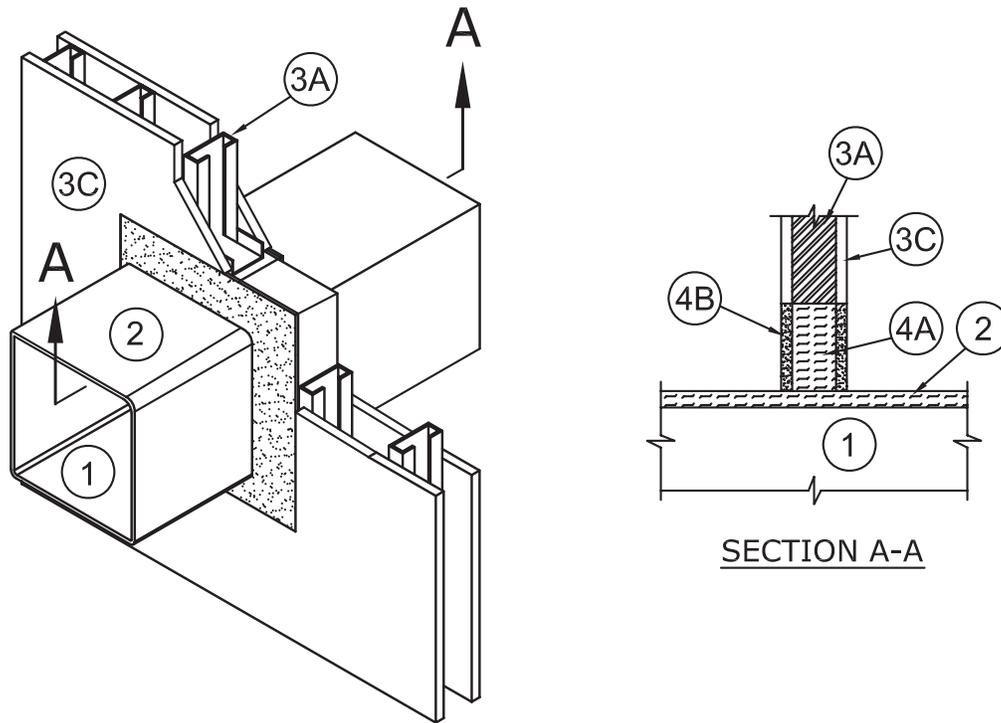

1. PENETRATING ITEM: Rectangular or round steel duct constructed of minimum 24 GA sheet steel with maximum 720 inch² area with a maximum 30 inch dimension or 30 inch diameter.
2. CERTIFIED MANUFACTURER: 3M Company
CERTIFIED PRODUCT: 3M Fire Barrier™ Duct Wrap
MODEL: 15A, 20A
MODEL: 615: Option for FRD Ventilation Ducts (Old Designation VAD)
INSULATION: Before the packing material (Item 4A) and fill material (Item 4B) of the penetration firestop (Item 4) is installed, protect the penetrating item (Item 1) with at least one layer of minimum 24-inch-wide certified insulation. Minimum 8 pcf density required for grease duct applications. Wrap penetrating item (Item 1) with a one layer of certified insulation, overlap the ends of certified insulation and secure certified insulation to penetrating item (Item 1) in accord with any 1-hour-rated 3M FRD design listing.
3. WALL ASSEMBLY: Symmetrical one-hour-rated gypsum wall assembly constructed of the following:
 - A. Steel Studs – Minimum 25 GA galvanized steel studs measuring 3-5/8 inches wide with 1-1/4-inch legs spaced maximum 24 inches on center (O.C.). Attach studs with minimum #6 x 3/8-inch steel stud framing screws to floor and ceiling tracks.
 - B. Tracks – Channel U-shaped floor and ceiling runners measuring 1/2 inch deep by 3-5/8-inches wide, which are secured to floor and ceiling with 1-inch-long fasteners suitable for the mounting to substrate and spaced maximum 18 inches O.C.
 - C. Gypsum Board – Cover studs and runners with one layer of 5/8-inch-thick, Type X gypsum board on each face. Fasten gypsum board to steel studs with #6 1-1/8-inch-long bugle head phillips drywall screws spaced maximum 8 inches O.C. Apply vinyl or casein, dry or premixed joint compound to face layers of gypsum board in two coats to all exposed screw heads and gypsum board joints. Embed minimum 2-inch-wide paper, plastic or fiberglass tape in first layer of joint compound over joints in gypsum board. Minimum wall assembly thickness of 4-3/4 inches measured from face layer of gypsum board to opposite face layer of gypsum board.
 - D. Opening – Create an opening in the wall assembly having a cross-sectional area of maximum 1118 inch² and a maximum dimension of 35.5 inches. Frame opening with steel studs (Item 3A) and tracks (Item 3B). Position the penetrating item (Item 1) concentrically or eccentrically in the opening so that the annular space ranges from minimum 5/8 inches to maximum 3-1/2 inches.

Flexible Wraps

Duct Wrap

Through Wall Assembly

PH

Design No. 3MU/PH 60-01 *continued*

4. PENETRATION FIRESTOP: Symmetrical penetration firestop constructed of the following components:
- A. CERTIFIED MANUFACTURER: 3M Company
CERTIFIED PRODUCT: 3M Fire Barrier™ Duct Wrap
MODEL: 15A, 20A, 615
PACKING MATERIAL: Fill the annular space with minimum 4-pcf mineral wool or certified insulation without the encapsulation (foil scrim). Cut the packing material into strips. Compress packing material nominally 25% and insert packing material into the annular space. Fill the entire annular space. Recess the surface of packing material nominally 5/8 inches from both surfaces of the face layers of the gypsum board of the wall assembly (Item 3).
 - B. CERTIFIED MANUFACTURER: 3M Company
CERTIFIED PRODUCT: 3M Fire Barrier™ Joint Sealant
MODEL: Water Tight 1000-NS Silicone or 2000+ Silicone Joint Sealant
FILL, VOID OR CAVITY MATERIAL: Install minimum 5/8-inch depth of certified fill material into the recess over the packing material (Item 4A) on both sides of the wall assembly (Item 3). Screenshot certified fill material flush with the surface of the wall assembly (Item 3) on both sides.

This material was extracted and drawn by 3M Fire Protection Products from the 2010 Product Directory, © Intertek

Flexible Wraps

Duct Wrap

Through Wall Assembly

PH

Design No. 3MU/PH 60-03

January 08, 2008

PENETRATION FIRESTOP THROUGH WALL ASSEMBLY

3M Company

3M Fire Barrier Duct Wrap

3M Fire Barrier Water Tight 1000-NS Silicone Joint Sealant

ASTM E 814-06

T Rating – 1 hr

F Rating – 1 hr

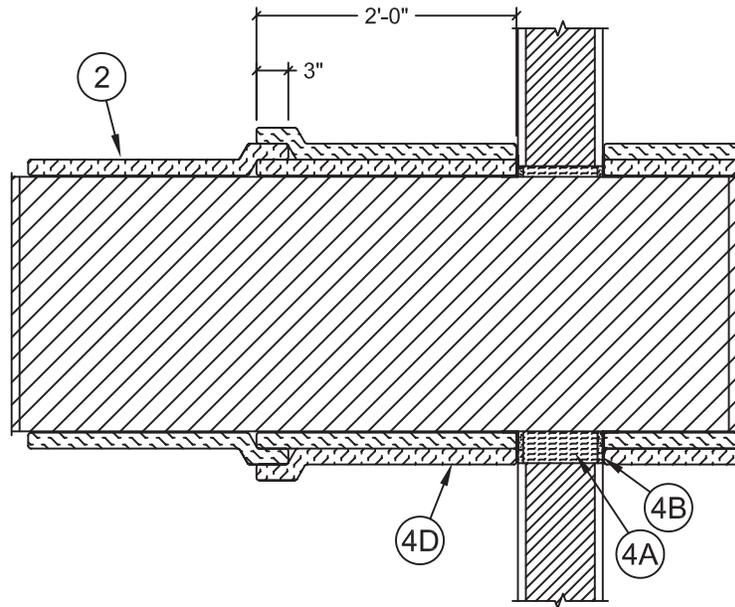

1. PENETRATING ITEM: Rectangular steel duct constructed of minimum 24 GA sheet steel with maximum 2040 inch² area with a maximum 85 inch dimension.
2. CERTIFIED MANUFACTURER: 3M Company
CERTIFIED PRODUCT: 3M Fire Barrier™ Duct Wrap
MODEL: 615
INSULATION: After the packing material (Item 4A) and fill material (Item 4B) of the penetration firestop (Item 4) is installed and the steel angle (Item 4C) attached, protect the penetrating item (Item 1) with at least one layer of minimum 24-inch wide, minimum 6 pcf insulation. Weld mild steel copper plated 12 GA by minimum 7 inch long pins to the bottom of the penetrating item (Item 1) spaced in 12 inch wide rows with pins spaced 10-1/2 inches apart. Wrap penetrating item (Item 1) with a one layer of certified insulation. Overlap the ends of certified insulation a minimum of 3 inches. Place speed clips over the pins to secure certified insulation on bottom. Use nominal 1/2 inch wide, 0.015 inch thick, stainless steel banding and banding clips placed around the circumference of the penetrating item (Item 1) spaced nominally 10-1/2-inches on center to secure certified insulation.
3. WALL ASSEMBLY: Symmetrical one-hour rated gypsum wall assembly constructed of the following:
 - A. Steel Studs – Minimum 25 GA galvanized steel studs measuring 3-5/8 inch wide with 1-1/4-inch legs spaced maximum 24 inch on center (O.C.). Attach studs with minimum #6 x 3/8-inch steel stud framing screws to floor and ceiling tracks.
 - B. Tracks – Channel U-shaped floor and ceiling runners measuring 1/2-inch deep by 3-5/8-inch wide, which are secured to floor and ceiling with 1-inch long fasteners, suitable for the mounting to substrate, spaced maximum 18-inch O.C.
 - C. Gypsum Board – Cover studs and runners with one layer of 5/8 inch thick, Type X gypsum board on each face. Fasten gypsum board to steel studs with #6 1-1/8 inch bugle head phillips drywall screws spaced maximum 8 inches O.C. Apply vinyl or casein, dry or premixed joint compound to face layers of gypsum board in two coats to all exposed screw heads and gypsum board joints. Embed minimum 2 inch wide paper, plastic or fiberglass tape in first layer of joint compound over joints in gypsum board. Minimum wall assembly thickness of 4-3/4 inches measured from face layer of gypsum board to opposite face layer of gypsum board.
 - D. Opening – Create an opening in the wall assembly having a cross-sectional area of maximum 2492 inch² and a maximum dimension of 89 inches. Position the penetrating item (Item 1) concentrically or eccentrically in the opening so that the annular space ranges from minimum 1 inch to maximum 3 inches.

Flexible Wraps

Duct Wrap

Through Wall Assembly

PH

Design No. 3MU/PH 60-03 *continued*

4. PENETRATION FIRESTOP: Symmetrical penetration firestop constructed of the following components:
- A. CERTIFIED MANUFACTURER: 3M Company
CERTIFIED PRODUCT: 3M Fire Barrier™ Duct Wrap
MODEL: 615
PACKING MATERIAL: Fill the annular space with minimum 6 pcf insulation without the encapsulation (foil scrim). Cut the certified packing material into strips. Layer certified packing material to 50% greater thickness than width of annular space being filled. Compress certified packing material nominally 33%. Insert compressed certified packing material into the annular space. Fill the entire annular space. Recess the surface of certified packing material nominally 5/8 inches from both surfaces of the face layers of the gypsum board of the wall assembly (Item 3).
 - B. CERTIFIED MANUFACTURER: 3M Company
CERTIFIED PRODUCT: 3M Fire Barrier™ Joint Sealant
MODEL: Water Tight 1000-NS Silicone
FILL, VOID OR CAVITY MATERIAL: Install minimum 5/8-inch depth of fill material into the recess over the packing material (Item 4A) on both sides of the wall assembly (Item 3). Screed certified fill material flush with the surface of the wall assembly (Item 3) on both sides.
 - C. STEEL ANGLE: Install nominal 16 GA 2 x 1-1/2 inch steel angle around perimeter of penetrating item (Item 1) with notched ends to create a continuous frame. Place vertical 1-1/2 inch leg of angle flush with face layers of gypsum board of wall assembly (Item 3). Attach horizontal 2 inch leg of angle to the penetrating item (Item 1) using self drilling screws, 12-24x2 Hex washer Head with #5 Point, spaced a maximum of 6 inches O.C.
 - D. CERTIFIED MANUFACTURER: 3M Company
CERTIFIED PRODUCT: 3M Fire Barrier™ Duct Wrap
MODEL: 615
COLLAR: After the penetrating item (Item 1) is insulated with certified insulation (Item 2), install a layer of minimum 24 inch wide, minimum 6 pcf insulation over the penetrating item (Item 1). Position the certified collar abutting the face layers of the gypsum board of the wall assembly (Item 2) on both sides of the wall assembly (Item 2). Overlap the ends of the certified collar a minimum of 3 inches. Certified collar covers the steel angle (Item 4C) of the penetration firestop (Item 4)

This material was extracted and drawn by 3M Fire Protection Products from the 2010 Product Directory, © Intertek

Flexible Wraps

Duct Wrap

Through Wall Assembly

PH

Design No. 3MU/PH 60-04

January 08, 2008

PENETRATION FIRESTOP THROUGH WALL ASSEMBLY

3M Company

3M Fire Barrier Duct Wrap

3M Fire Barrier Water Tight 1000-NS Silicone Joint Sealant

ISO 6944 (1985)

Stability – 1 hr

Insulation – 1 hr

Integrity – 1 hr

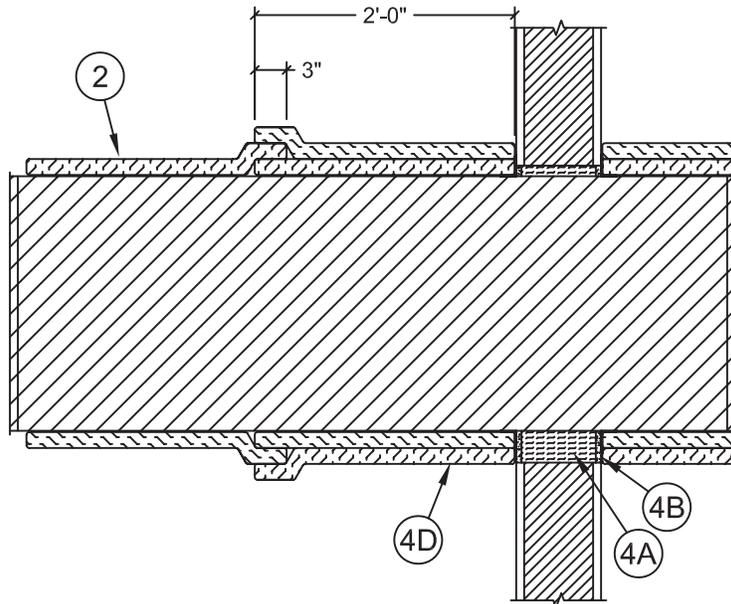

1. PENETRATING ITEM: Rectangular steel duct constructed of minimum 24 GA sheet steel with maximum 2040 inch² area with a maximum 85 inch dimension.
2. CERTIFIED MANUFACTURER: 3M Company
CERTIFIED PRODUCT: 3M Fire Barrier™ Duct Wrap
MODEL: 615
INSULATION: After the packing material (Item 4A) and fill material (Item 4B) of the penetration firestop (Item 4) is installed and the steel angle (Item 4C) attached, protect the penetrating item (Item 1) with insulation applied in accordance with an Intertek ISO 6944 3M Design Listing for a Type A Duct using at least one layer of minimum 24-inch wide, minimum 6 pcf insulation.
3. WALL ASSEMBLY: Symmetrical one-hour rated gypsum wall assembly constructed of the following:
 - A. Steel Studs – Minimum 25 GA galvanized steel studs measuring 3-5/8 inch wide with 1-1/4-inch legs spaced maximum 24 inch on center (O.C.). Attach studs with minimum #6 x 3/8-inch steel stud framing screws to floor and ceiling tracks.
 - B. Tracks – Channel U-shaped floor and ceiling runners measuring 1/2-inch deep by 3-5/8-inch wide, which are secured to floor and ceiling with 1-inch long fasteners, suitable for the mounting to substrate, spaced maximum 18-inch O.C.
 - C. Gypsum Board – Cover studs and runners with one layer of 5/8 inch thick, Type X gypsum board on each face. Fasten gypsum board to steel studs with #6 1-1/8 inch bugle head phillips drywall screws spaced maximum 8 inches O.C. Apply vinyl or casein, dry or premixed joint compound to face layers of gypsum board in two coats to all exposed screw heads and gypsum board joints. Embed minimum 2 inch wide paper, plastic or fiberglass tape in first layer of joint compound over joints in gypsum board. Minimum wall assembly thickness of 4-3/4 inches measured from face layer of gypsum board to opposite face layer of gypsum board.
 - D. Opening – Create an opening in the wall assembly having a cross-sectional area of maximum 2492 inch² and a maximum dimension of 89 inches. Position the penetrating item (Item 1) concentrically or eccentrically in the opening so that the annular space ranges from minimum 1 inch to maximum 3 inches.
4. PENETRATION FIRESTOP: Symmetrical penetration firestop constructed of the following components:
 - A. CERTIFIED MANUFACTURER: 3M Company
CERTIFIED PRODUCT: 3M Fire Barrier™ Duct Wrap
MODEL: 615
PACKING MATERIAL: Fill the annular space with minimum 6 pcf insulation without the encapsulation (foil scrim). Cut the certified packing material into strips. Layer certified packing material to 50% greater thickness than width of annual space being filled. Compress certified packing material nominally 33%. Insert compressed certified packing material into the annual space. Fill the entire annular space. Recess the surface of certified packing material nominally 5/8 inches from both surfaces of the face layers of the gypsum board of the wall assembly (Item 3).

Flexible Wraps

Duct Wrap

Through Wall Assembly

PH

Design No. 3MU/PH 60-04 *continued*

- B. CERTIFIED MANUFACTURER: 3M Company
CERTIFIED PRODUCT: 3M Fire Barrier™ Joint Sealant
MODEL: Water Tight 1000-NS Silicone
FILL, VOID OR CAVITY MATERIAL: Install minimum 5/8-inch depth of fill material into the recess over the packing material (Item 4A) on both sides of the wall assembly (Item 3). Screed certified fill material flush with the surface of the wall assembly (Item 3) on both sides.
- C. STEEL ANGLE: Install nominal 16 GA 2 x 1-1/2 inch steel angle around perimeter of penetrating item (Item 1) with notched ends to create a continuous frame. Place vertical 1-1/2 inch leg of angle flush with face layers of gypsum board of wall assembly (Item 3). Attach horizontal 2 inch leg of angle to the penetrating item (Item 1) using self drilling screws, 12-24x2 Hex washer Head with #5 Point, spaced a maximum of 6 inches O.C.
- D. CERTIFIED MANUFACTURER: 3M Company
CERTIFIED PRODUCT: 3M Fire Barrier™ Duct Wrap
MODEL: 615
COLLAR: After the penetrating item (Item 1) is insulated with certified insulation (Item 2), install a layer of minimum 24 inch wide, minimum 6 pcf insulation over the penetrating item (Item 1). Position the certified collar abutting the face layers of the gypsum board of the wall assembly (Item 2) on both sides of the wall assembly (Item 2). Overlap the ends of the certified collar a minimum of 3 inches. Certified collar covers the steel angle (Item 4C) of the penetration firestop (Item 4).

This material was extracted and drawn by 3M Fire Protection Products from the 2010 Product Directory, © Intertek

Flexible Wraps

Duct Wrap

Through Wall Assembly

PH

Design No. 3MU/PH 120-14

OPL Design Number FS 559 W

November 14, 2008

PENETRATION FIRESTOP THROUGH WALL ASSEMBLY

3M Company

3M Fire Barrier™ Duct Wrap 15A or 20A

3M Fire Barrier™ Duct Wrap 615

3M Fire Barrier™ 2000+ Silicone Joint Sealant

3M Fire Barrier™ Water Tight 1000-NS Silicone Joint Sealant

ASTM E 814-06

T Rating – 2 hr

F Rating – 2 hr

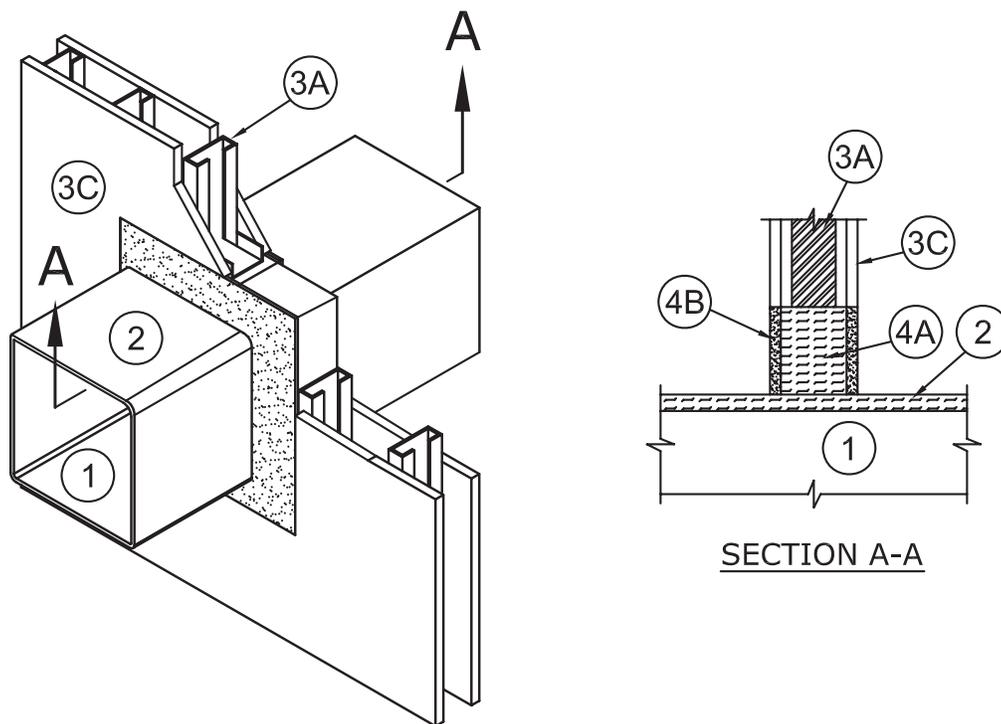

1. PENETRATING ITEM: Rectangular or round steel duct constructed of minimum 24 GA sheet steel with maximum 720 inch² area with a maximum 30 inch dimension or 30 inch diameter.
2. CERTIFIED MANUFACTURER: 3M Company
CERTIFIED PRODUCT: 3M Fire Barrier™ Duct Wrap
MODEL: 15A, 20A
MODEL: 615: Option for FRD Ventilation Ducts (Old Designation VAD)
INSULATION: Before the packing material (Item 4A) and fill material (Item 4B) of the penetration firestop (Item 4) is installed, protect the penetrating item (Item 1) with at least one layer of minimum 24-inch-wide certified insulation. Minimum 8 pcf density required for grease duct applications. Wrap penetrating item (Item 1) with a one layer of certified insulation, overlap the ends of certified insulation and secure certified insulation to penetrating item (Item 1) in accord with any 2-hour-rated 3M FRD design listing.
3. WALL ASSEMBLY: Symmetrical two-hour-rated gypsum wall assembly constructed of the following:
 - A. Steel Studs – Minimum 25 GA galvanized steel studs measuring 3-5/8 inches wide with 1-1/4-inch legs spaced maximum 24 inches on center (O.C.). Attach studs with minimum #6 x 3/8-inch steel stud framing screws to floor and ceiling tracks.
 - B. Tracks – Channel U-shaped floor and ceiling runners measuring 1/2 inch deep by 3-5/8-inches wide, which are secured to floor and ceiling with 1-inch-long fasteners suitable for the mounting to substrate and spaced maximum 18 inches O.C.
 - C. Gypsum Board – Cover studs and runners with two layers of 5/8-inch-thick, Type X gypsum board on each face. Fasten base layer to gypsum board to steel studs with #6 1-1/8-inch-long bugle head phillips drywall screws spaced maximum 12 inches O.C. Fasten face layer of gypsum board with #6 1-5/8-inch-long bugle head phillips drywall screws spaced maximum 8 inches O.C. Apply vinyl or casein, dry or premixed joint compound to face layers of gypsum board in two coats to all exposed screw heads and gypsum board joints. Embed minimum 2-inch-wide paper, plastic or fiberglass tape in first layer of joint compound over joints in gypsum board. Minimum wall assembly thickness of 6 inches measured from face layer of gypsum board to opposite face layer of gypsum board.
 - D. Opening – Create an opening in the wall assembly having a cross-sectional area of maximum 1118 inch² and a maximum dimension of 35.5 inches. Frame opening with steel studs (Item 3A) and tracks (Item 3B). Position the penetrating item (Item 1) concentrically or eccentrically in the opening so that the annular space ranges from minimum 1 inch to maximum 3-1/2 inches.

Flexible Wraps

Duct Wrap

Through Wall Assembly

PH

Design No. 3MU/PH 120-14 *continued*

4. PENETRATION FIRESTOP: Symmetrical penetration firestop constructed of the following components:
- A. CERTIFIED MANUFACTURER: 3M Company
CERTIFIED PRODUCT: 3M Fire Barrier™ Duct Wrap
MODEL: 15A, 20A, 615
PACKING MATERIAL: Fill the annular space with minimum 4-pcf mineral wool or certified insulation without the encapsulation (foil scrim). Cut the packing material into strips. Compress packing material nominally 25% and insert packing material into the annular space. Fill the entire annular space. Recess the surface of packing material nominally 5/8 inches from both surfaces of the face layers of the gypsum board of the wall assembly (Item 3).
 - B. CERTIFIED MANUFACTURER: 3M Company
CERTIFIED PRODUCT: 3M Fire Barrier™ Joint Sealant
MODEL: Water Tight 1000-NS Silicone or 2000+ Silicone Joint Sealant
FILL, VOID OR CAVITY MATERIAL: Install minimum 5/8-inch depth of certified fill material into the recess over the packing material (Item 4A) on both sides of the wall assembly (Item 3). Screed certified fill material flush with the surface of the wall assembly (Item 3) on both sides.

This material was extracted and drawn by 3M Fire Protection Products from the 2010 Product Directory, © Intertek

Flexible Wraps

Duct Wrap

Through Wall Assembly

PH

Design No. 3MU/PH 120-16 *continued*

4. PENETRATION FIRESTOP: Symmetrical penetration firestop constructed of the following components:

A. CERTIFIED MANUFACTURER: 3M Company

CERTIFIED PRODUCT: 3M Fire Barrier™ Duct Wrap

MODEL: 15A, 20A, 615

PACKING MATERIAL: Fill the annular space with minimum 4 pcf mineral wool or certified insulation without the encapsulation (foil scrim). Cut the packing material into strips. Compress packing material nominally 25% and insert packing material into the annular space. Fill the entire annular space. Recess the surface of packing material nominally 3/8 inches from both surfaces of the face layers of the gypsum board of the wall assembly (Item 3).

B. CERTIFIED MANUFACTURER: 3M Company

CERTIFIED PRODUCT: 3M Fire Barrier™ Joint Sealant

MODEL: Water Tight 1000-NS Silicone or 2000+ Silicone Joint Sealant

FILL, VOID OR CAVITY MATERIAL: Install minimum 3/8-inch depth of certified fill material into the recess over the packing material (Item 4A) on both sides of the wall assembly (Item 3). Screenshot certified fill material flush with the surface of the wall assembly (Item 3) on both sides. Overlap the fill material onto face of wall assembly (Item 3) a minimum of 1/4 inch.

This material was extracted and drawn by 3M Fire Protection Products from the 2010 Product Directory, © Intertek

Flexible Wraps

Duct Wrap

Through Wall Assembly

PH

Design No. 3MU/PH 120-21

January 15, 2008

PENETRATION FIRESTOP THROUGH WALL ASSEMBLY

3M Company

3M Fire Barrier Duct Wrap

3M Fire Barrier Water Tight 1000-NS Silicone Joint Sealant

ISO 6944 (1985)

Stability – 2 hr

Insulation – 2 hr

Integrity – 2 hr

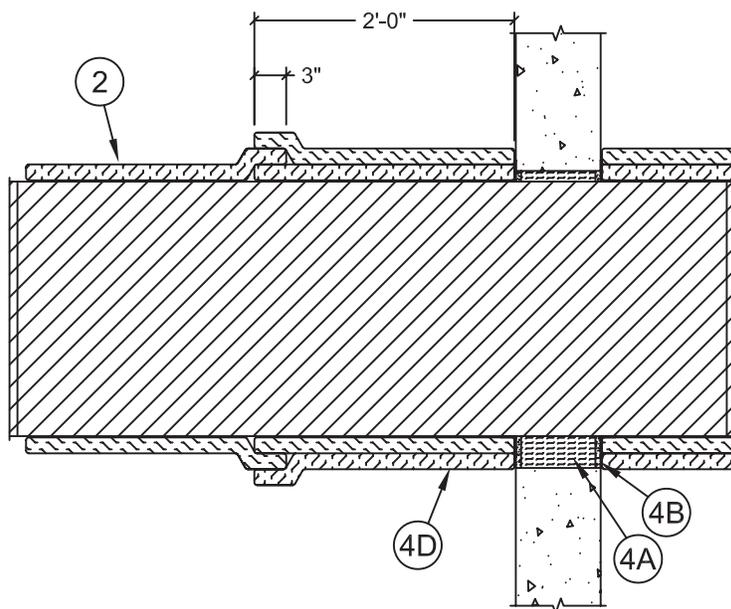

1. PENETRATING ITEM: Rectangular steel duct constructed of minimum 24 GA sheet steel with maximum 2040 inch² area with a maximum 85 inch dimension.
2. CERTIFIED MANUFACTURER: 3M Company
CERTIFIED PRODUCT: 3M Fire Barrier™ Duct Wrap
MODEL: 615
INSULATION: After the packing material (Item 4A) and fill material (Item 4B) of the penetration firestop (Item 4) is installed and the steel angle (Item 4C) attached, protect the penetrating item (Item 1) with insulation applied in accordance with an Intertek ISO 6944 3M Design Listing for a Type A Duct using at least one layer of minimum 24-inch wide, minimum 6 pcf insulation.
3. WALL ASSEMBLY: Symmetrical two-hour rated solid concrete wall assembly made from reinforced lightweight or normal weight (100-150 pcf or 1600-2400 kg/m³) concrete. Constructed of one of the following:
 - A. Solid Concrete – Minimum concrete thickness measured from exposed face to exposed face using one of the following:
 1. lightweight concrete is 3.6 inches;
 2. sand-lightweight concrete is 3.8 inches;
 3. carbonate aggregate concrete is 4.6 inches; and
 4. siliceous aggregate concrete is 5.0 inches.
 - B. Opening – Create an opening in the wall assembly having a cross-sectional area of maximum 2492 inch² and a maximum dimension of 89 inches. Position the penetrating item (Item 1) concentrically or eccentrically in the opening so that the annular space ranges from minimum 1 inch to maximum 3 inches.
4. PENETRATION FIRESTOP: Symmetrical penetration firestop constructed of the following components:
 - A. CERTIFIED MANUFACTURER: 3M Company
CERTIFIED PRODUCT: 3M Fire Barrier™ Duct Wrap
MODEL: 615
PACKING MATERIAL: Fill the annular space with minimum 6 pcf insulation without the encapsulation (foil scrim). Cut the certified packing material into strips. Layer certified packing material to 50% greater thickness than width of annual space being filled. Compress certified packing material nominally 33%. Insert compressed certified packing material into the annual space. Fill the entire annular space. Recess the surface of certified packing material nominally 5/8 inches from both surfaces of the face layers of the gypsum board of the wall assembly (Item 3).

Flexible Wraps

Duct Wrap

Through Wall Assembly

PH

Design No. 3MU/PH 120-21 *continued*

- B. CERTIFIED MANUFACTURER: 3M Company
CERTIFIED PRODUCT: 3M Fire Barrier™ Joint Sealant
MODEL: Water Tight 1000-NS Silicone
FILL, VOID OR CAVITY MATERIAL: Install minimum 5/8-inch depth of fill material into the recess over the packing material (Item 4A) on both sides of the wall assembly (Item 3). Screed certified fill material flush with the surface of the wall assembly (Item 3) on both sides.
- C. STEEL ANGLE: Install nominal 16 GA 2 x 1-1/2 inch steel angle around perimeter of penetrating item (Item 1) with notched ends to create a continuous frame. Place vertical 1-1/2 inch leg of angle flush with exposed faces layers of the concrete wall assembly (Item 3). Attach horizontal 2 inch leg of angle to the penetrating item (Item 1) using self drilling screws, 12-24x2 Hex washer Head with #5 Point, spaced a maximum of 6 inches O.C.
- D. CERTIFIED MANUFACTURER: 3M Company
CERTIFIED PRODUCT: 3M Fire Barrier™ Duct Wrap
MODEL: 615
COLLAR: After the penetrating item (Item 1) is insulated with certified insulation (Item 2), install a layer of minimum 24 inch wide, minimum 6 pcf insulation over the penetrating item (Item 1). Position the certified collar abutting the exposed faces on both sides of the concrete wall assembly (Item 3). Overlap the ends of the certified collar a minimum of 3 inches. Certified collar covers the steel angle (Item 4C) of the penetration firestop (Item 4).

This material was extracted and drawn by 3M Fire Protection Products from the 2010 Product Directory, © Intertek

Flexible Wraps

Duct Wrap

Through Wall Assembly

PH

Design No. 3MU/PH 120-22

January 08, 2008

PENETRATION FIRESTOP THROUGH SHAFT WALL ASSEMBLY

3M Company

3M Fire Barrier Duct Wrap

3M Fire Barrier Water Tight 1000-NS Silicone Joint Sealant

ISO 6944 (1985)

Stability – 2 hr

Insulation – 2 hr

Integrity – 2 hr

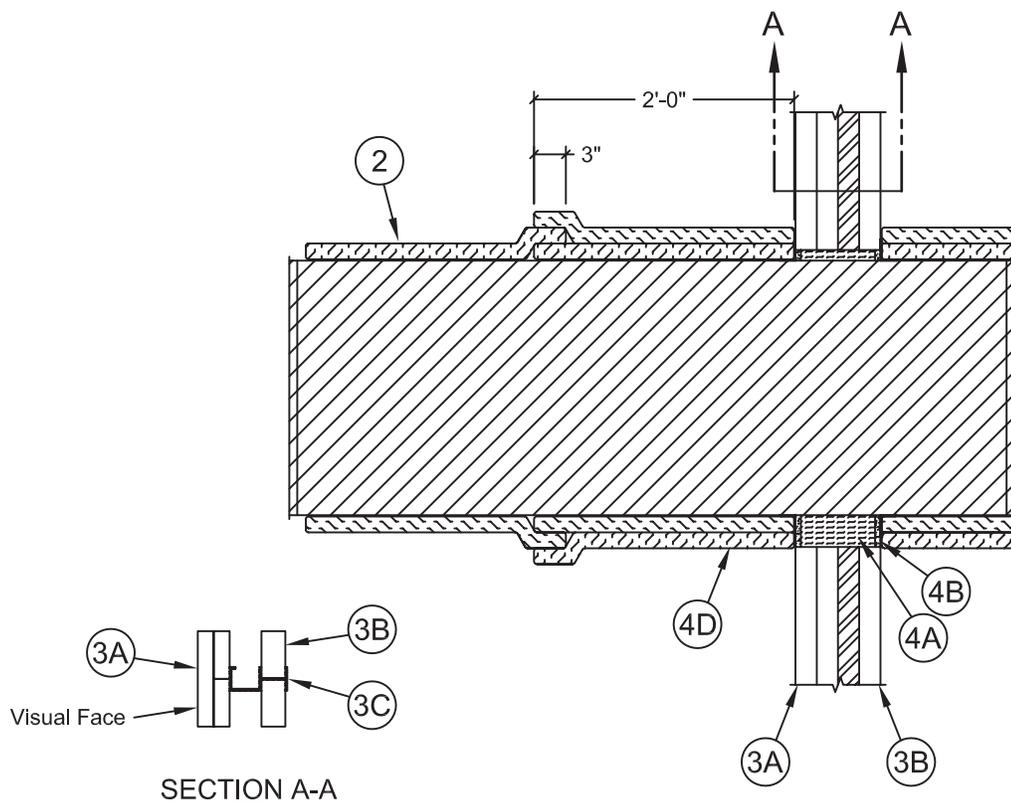

1. PENETRATING ITEM: Rectangular steel duct constructed of minimum 24 GA sheet steel with maximum 2040 inch² area with a maximum 85 inch dimension.
2. CERTIFIED MANUFACTURER: 3M Company
CERTIFIED PRODUCT: 3M Fire Barrier™ Duct Wrap
MODEL: 615
INSULATION: After the packing material (Item 4A) and fill material (Item 4B) of the penetration firestop (Item 4) is installed and the steel angle (Item 4C) attached, protect the penetrating item (Item 1) with insulation applied in accordance with an Intertek ISO 6944 3M Design Listing for a Type A Duct using at least one layer of minimum 24-inch wide, minimum 6 pcf insulation.
3. WALL ASSEMBLY: Asymmetrical two-hour rated gypsum shaft wall assembly constructed of the following:
 - A. Visual Gypsum Board – Cover studs and runners with two layers of minimum 1/2 inch thick, Type X gypsum board on each face. Fasten base layer of gypsum board to steel studs with #6 1-1/8 inch bugle head phillips drywall screws spaced maximum 12 inch O.C. Fasten face layer of gypsum board with #6 1-5/8 inch long bugle phillips drywall screws spaced maximum 8 inches O.C. Apply vinyl or casein, dry or premixed joint compound to face layers of gypsum board in two coats to all exposed screw heads and gypsum board joints. Embed minimum 2 inch wide paper, plastic or fiberglass tape in first layer of joint compound over joints in gypsum board. Minimum wall assembly thickness of 6 inches measured from face layer of gypsum board to opposite face layer of gypsum board.
 - B. Interior Gypsum Board – Cut 1-inch thick Type X gypsum board 1-inch less than floor to ceiling height. Insert the longitudinal edges of the 1-inch thick Type X gypsum board into the C-T or C-H studs. Secure the transverse edge of the 1 inch thick Type X gypsum board to the long leg of J-runner using its tabs or minimum 1-5/8-inch long Type S self-tapping bugle head steel screws spaced maximum 12 inches on center.
 - C. Steel Studs – Cut minimum 25 GA galvanized steel C-T or C-H studs measuring minimum 2-1/2 inches wide with minimum 1-1/2-inch flanges 3/4-inches less than floor to ceiling height and spaced maximum 24 inch on center (O.C.) in runners with T or H section abutting long leg of runner.
 - D. Runners – Use minimum 2-1/2-inch wide J-runner compatible with studs and having unequal vertical legs: minimum 1-inch short leg and minimum 2-inch long leg. Position J-runners with short leg towards visual face of shaft wall. Attach to floor and ceiling using steel fasteners located a maximum of 2-inches from each end and a maximum of 24 inch O.C.

Design No. 3MU/PH 120-22 *continued*

- E. Opening – Create an opening in the shaft wall assembly having a cross-sectional area of maximum 2492 inch² and a maximum dimension of 89 inches. Position the duct assembly eccentrically in the opening so that the annular space ranges from minimum 1 inch on one side to maximum 3 inches on the other.
4. PENETRATION FIRESTOP: Symmetrical penetration firestop constructed of the following components:
- A. CERTIFIED MANUFACTURER: 3M Company
CERTIFIED PRODUCT: 3M Fire Barrier™ Duct Wrap
MODEL: 615
PACKING MATERIAL: Fill the annular space with minimum 6 pcf insulation without the encapsulation (foil scrim). Cut the certified packing material into strips. Layer certified packing material to 50% greater thickness than width of annular space being filled. Compress certified packing material nominally 33%. Insert compressed certified packing material into the annular space. Fill the entire annular space. Recess the surface of certified packing material nominally 5/8 inches from both surfaces of the face layers of the gypsum board of the wall assembly (Item 3).
- B. CERTIFIED MANUFACTURER: 3M Company
CERTIFIED PRODUCT: 3M Fire Barrier™ Joint Sealant
MODEL: Water Tight 1000-NS Silicone
FILL, VOID OR CAVITY MATERIAL: Install minimum 5/8-inch depth of fill material into the recess over the packing material (Item 4A) on both sides of the wall assembly (Item 3). Screed certified fill material flush with the surface of the wall assembly (Item 3) on both sides.
- C. STEEL ANGLE: Install nominal 16 GA 2 x 1-1/2 inch steel angle around perimeter of penetrating item (Item 1) with notched ends to create a continuous frame. Place vertical 1-1/2 inch leg of angle flush with face layers of gypsum board of wall assembly (Item 3). Attach horizontal 2 inch leg of angle to the penetrating item (Item 1) using self drilling screws, 12-24x2 Hex washer Head with #5 Point, spaced a maximum of 6 inches O.C.
- D. CERTIFIED MANUFACTURER: 3M Company
CERTIFIED PRODUCT: 3M Fire Barrier™ Duct Wrap
MODEL: 615
COLLAR: After the penetrating item (Item 1) is insulated with certified insulation (Item 2), install a layer of minimum 24 inch wide, minimum 6 pcf insulation over the penetrating item (Item 1). Position the certified collar abutting the face layers of the gypsum board of the wall assembly (Item 2) on both sides of the wall assembly (Item 2). Overlap the ends of the certified collar a minimum of 3 inches. Certified collar covers the steel angle (Item 4C) of the penetration firestop (Item 4).

This material was extracted and drawn by 3M Fire Protection Products from the 2010 Product Directory, © Intertek

Flexible Wraps

Duct Wrap

Through Shaft Wall Assembly

PH

Design No. 3MU/PH 120-23

January 17, 2008

PENETRATION FIRESTOP THROUGH WALL ASSEMBLY

3M Company

3M Fire Barrier Duct Wrap

3M Fire Barrier Water Tight 1000-NS Silicone Joint Sealant

ASTM E 814-06

T Rating – 2 hr

F Rating – 2 hr

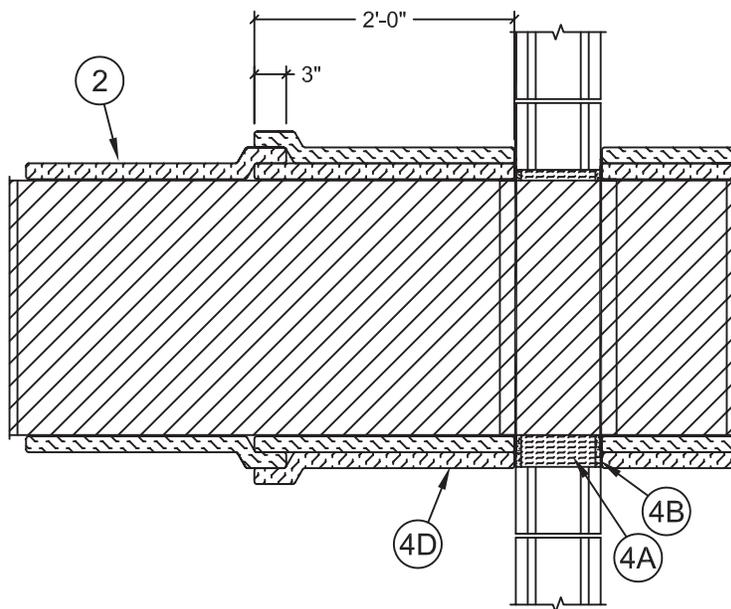

1. PENETRATING ITEM: Rectangular steel duct constructed of minimum 24 GA sheet steel with maximum 2040 inch² area with a maximum 85 inch dimension.
2. CERTIFIED MANUFACTURER: 3M Company
CERTIFIED PRODUCT: 3M Fire Barrier™ Duct Wrap
MODEL: 615
INSULATION: After the packing material (Item 4A) and fill material (Item 4B) of the penetration firestop (Item 4) is installed and the steel angle (Item 4C) attached, protect the penetrating item (Item 1) with at least one layer of minimum 24-inch wide, minimum 6 pcf insulation. Weld mild steel copper plated 12 GA by minimum 7 inch long pins to the bottom of the penetrating item (Item 1) spaced in 12 inch wide rows with pins spaced 10-1/2 inches apart. Wrap penetrating item (Item 1) with one layer of certified insulation. Overlap the ends of certified insulation a minimum of 3 inches. Place speed clips over the pins to secure certified insulation on bottom. Use nominal 1/2 inch wide, 0.015 inch thick, stainless steel banding and banding clips placed around the circumference of the penetrating item (Item 1) spaced nominally 10-1/2-inches on center to secure certified insulation.
3. WALL ASSEMBLY: Symmetrical two-hour rated concrete masonry unit (CMU) wall assembly constructed of the following:
 - A. Block – Solid, 2 cavity, or 3 cavity, CMU block with minimum dimensions 7-5/8 x 7-5/8 x 15-3/8 inches, which is commonly called standard 8 x 8 x 16 block. Place CMU using standard 3/8-inch joints filled with Type S masonry cement mortar. Use a staggered block pattern where each course (row) laid is offset 50% from the row below. Minimum wall assembly thickness of 7-5/8 inches measured from face to opposite face of CMU.
 - B. Opening – Create an opening in the wall assembly having a cross-sectional area of maximum 2492 inch² and a maximum dimension of 89 inches. Position the penetrating item (Item 1) concentrically or eccentrically in the opening so that the annular space ranges from minimum 1 inch to maximum 3 inches.
4. PENETRATION FIRESTOP: Symmetrical penetration firestop constructed of the following components:
 - A. CERTIFIED MANUFACTURER: 3M Company
CERTIFIED PRODUCT: 3M Fire Barrier™ Duct Wrap
MODEL: 615
PACKING MATERIAL: Fill the annular space with minimum 6 pcf insulation without the encapsulation (foil scrim). Cut the certified packing material into strips. Layer certified packing material to 50% greater thickness than width of annual space being filled. Compress certified packing material nominally 33%. Insert compressed certified packing material into the annular space. Fill the entire annular space. Recess the surface of certified packing material nominally 5/8 inches from both surfaces of the wall assembly (Item 3).

Flexible Wraps

Duct Wrap

Through Wall Assembly

PH

Design No. 3MU/PH 120-23 *continued*

- B. CERTIFIED MANUFACTURER: 3M Company
CERTIFIED PRODUCT: 3M Fire Barrier™ Joint Sealant
MODEL: Water Tight 1000-NS Silicone
FILL, VOID OR CAVITY MATERIAL: Install minimum 5/8-inch depth of fill material into the recess over the packing material (Item 4A) on both sides of the wall assembly (Item 3). Screed certified fill material flush with the surface of the wall assembly (Item 3) on both sides.
- C. STEEL ANGLE: Install nominal 16 GA 2 x 1-1/2 inch steel angle around perimeter of penetrating item (Item 1) with notched ends to create a continuous frame. Place vertical 1-1/2 inch leg of angle flush with exposed faces of wall assembly (Item 3). Attach horizontal 2 inch leg of angle to the penetrating item (Item 1) using self drilling screws, 12-24x2 Hex washer Head with #5 Point, spaced a maximum of 6 inches O.C.
- D. CERTIFIED MANUFACTURER: 3M Company
CERTIFIED PRODUCT: 3M Fire Barrier™ Duct Wrap
MODEL: 615
COLLAR: After the penetrating item (Item 1) is insulated with certified insulation (Item 2), install a layer of minimum 24 inch wide, minimum 6 pcf insulation over the penetrating item (Item 1). Position the certified collar abutting the exposed faces both sides of the wall assembly (Item 3). Overlap the ends of the certified collar a minimum of 3 inches. Certified collar covers the steel angle (Item 4C) of the penetration firestop (Item 4).

This material was extracted and drawn by 3M Fire Protection Products from the 2010 Product Directory, © Intertek

Flexible Wraps

Duct Wrap

Through Wall Assembly

PH

Design No. 3MU/PH 120-24

January 15, 2008

PENETRATION FIRESTOP THROUGH WALL ASSEMBLY

3M Company

3M Fire Barrier Duct Wrap

3M Fire Barrier Water Tight 1000-NS Silicone Joint Sealant

ASTM E 814-06

T Rating – 2 hr

F Rating – 2 hr

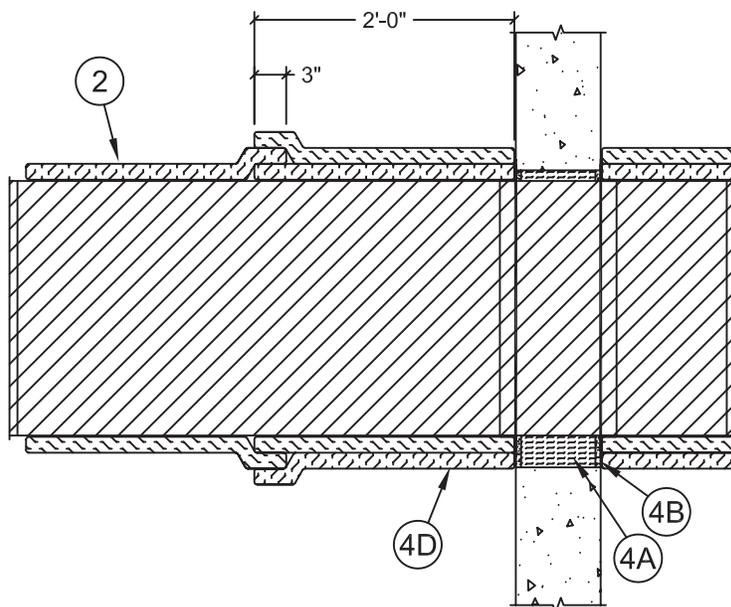

1. PENETRATING ITEM: Rectangular steel duct constructed of minimum 24 GA sheet steel with maximum 2040 inch² area with a maximum 85 inch dimension.
2. CERTIFIED MANUFACTURER: 3M Company
CERTIFIED PRODUCT: 3M Fire Barrier™ Duct Wrap
MODEL: 615
INSULATION: After the packing material (Item 4A) and fill material (Item 4B) of the penetration firestop (Item 4) is installed and the steel angle (Item 4C) attached, protect the penetrating item (Item 1) with at least one layer of minimum 24-inch wide, minimum 6 pcf insulation. Weld mild steel copper plated 12 GA by minimum 7 inch long pins to the bottom of the penetrating item (Item 1) spaced in 12 inch wide rows with pins spaced 10-1/2 inches apart. Wrap penetrating item (Item 1) with a one layer of certified insulation. Overlap the ends of certified insulation a minimum of 3 inches. Place speed clips over the pins to secure certified insulation on bottom. Use nominal 1/2 inch wide, 0.015 inch thick, stainless steel banding and banding clips placed around the circumference of the penetrating item (Item 1) spaced nominally 10-1/2-inches on center to secure certified insulation.
3. WALL ASSEMBLY: Symmetrical two-hour rated solid concrete wall assembly made from reinforced lightweight or normal weight (100-150 pcf or 1600-2400 kg/m³) concrete. Constructed of one of the following:
 - A. Solid Concrete – Minimum concrete thickness measured from exposed face to exposed face using one of the following:
 1. lightweight concrete is 3.6 inches;
 2. sand-lightweight concrete is 3.8 inches;
 3. carbonate aggregate concrete is 4.6 inches; and
 - B. Opening – Create an opening in the wall assembly having a cross-sectional area of maximum 2492 inch² and a maximum dimension of 89 inches. Position the penetrating item (Item 1) concentrically or eccentrically in the opening so that the annular space ranges from minimum 1 inch to maximum 3 inches.
4. PENETRATION FIRESTOP: Symmetrical penetration hrestop constructed of the following components:
 - A. CERTIFIED MANUFACTURER: 3M Company
CERTIFIED PRODUCT: 3M Fire Barrier™ Duct Wrap
MODEL: 615
PACKING MATERIAL: Fill the annular space with minimum 6 pcf insulation without the encapsulation (foil scrim). Cut the certified packing material into strips. Layer certified packing material to 50% greater thickness than width of annual space being filled. Compress certified packing material nominally 33%. Insert compressed certified packing material into the annual space. Fill the entire annular space. Recess the surface of certified packing material nominally 5/8 inches from both surfaces of the face layers of the gypsum board of the wall assembly (Item 3)

Flexible Wraps

Duct Wrap

Through Wall Assembly

PH

Design No. 3MU/PH 120-24 *continued*

- B. CERTIFIED MANUFACTURER: 3M Company
CERTIFIED PRODUCT: 3M Fire Barrier™ Joint Sealant
MODEL: Water Tight 1000-NS Silicone
FILL, VOID OR CAVITY MATERIAL: Install minimum 5/8-inch depth of fill material into the recess over the packing material (Item 4A) on both sides of the wall assembly (Item 3). Screed certified fill material flush with the surface of the wall assembly (Item 3) on both sides.
- C. STEEL ANGLE: Install nominal 16 GA 2 x 1-1/2 inch steel angle around perimeter of penetrating item (Item 1) with notched ends to create a continuous frame. Place vertical 1-1/2 inch leg of angle flush with exposed faces layers of the concrete wall assembly (Item 3). Attach horizontal 2 inch leg of angle to the penetrating item (Item 1) using self drilling screws, 12-24x2 Hex washer Head with #5 Point, spaced a maximum of 6 inches O.C.
- D. CERTIFIED MANUFACTURER: 3M Company
CERTIFIED PRODUCT: 3M Fire Barrier™ Duct Wrap
MODEL: 615
COLLAR: After the penetrating item (Item 1) is insulated with certified insulation (Item 2), install a layer of minimum 24 inch wide, minimum 6 pcf insulation over the penetrating item (Item 1). Position the certified collar abutting the exposed faces on both sides of the concrete wall assembly (Item 3). Overlap the ends of the certified collar a minimum of 3 inches. Certified collar covers the steel angle (Item 4C) of the penetration firestop (Item 4).

This material was extracted and drawn by 3M Fire Protection Products from the 2010 Product Directory, © Intertek

Flexible Wraps

Duct Wrap

Through Wall Assembly

PH

Design No. 3MU/PH 120-25

January 11, 2008

PENETRATION FIRESTOP THROUGH WALL ASSEMBLY

3M Company

3M Fire Barrier Duct Wrap

3M Fire Barrier Water Tight 1000-NS Silicone Joint Sealant

ASTM E 814-06

T Rating – 2 hr

F Rating – 2 hr

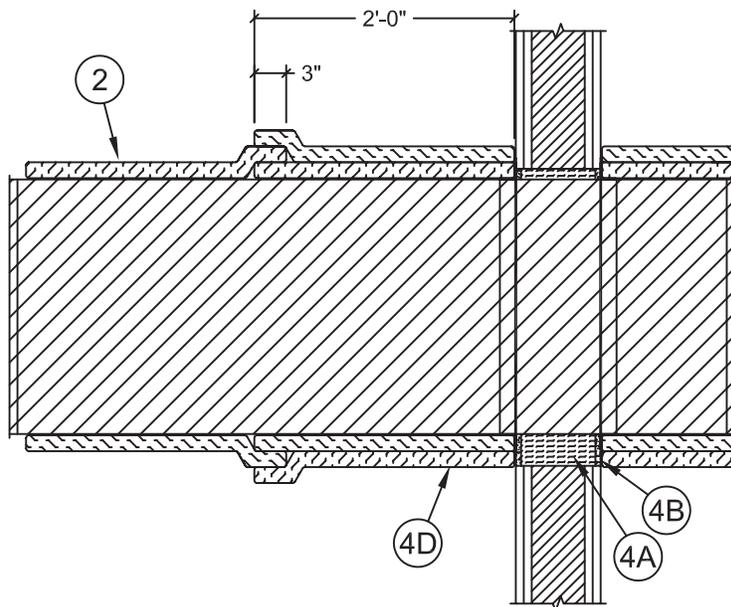

1. PENETRATING ITEM: Rectangular steel duct constructed of minimum 22 GA sheet steel with maximum 2040 inch² area with a maximum 85 inch dimension.
2. CERTIFIED MANUFACTURER: 3M Company
CERTIFIED PRODUCT: 3M Fire Barrier™ Duct Wrap
MODEL: 615
INSULATION: After the packing material (Item 4A) and fill material (Item 4B) of the penetration firestop (Item 4) is installed and the steel angle (Item 4C) attached, protect the penetrating item (Item 1) with at least one layer of minimum 24-inch wide, minimum 6 pcf insulation. Weld mild steel copper plated 12 GA by minimum 7 inch long pins to the bottom of the penetrating item (Item 1) spaced in 12 inch wide rows with pins spaced 10-1/2 inches apart. Wrap penetrating item (Item 1) with a one layer of certified insulation. Overlap the ends of certified insulation a minimum of 3 inches. Place speed clips over the pins to secure certified insulation on bottom. Use nominal 1/2 inch wide, 0.015 inch thick, stainless steel banding and banding clips placed around the circumference of the penetrating item (Item 1) spaced nominally 10-1/2-inches on center to secure certified insulation.
3. WALL ASSEMBLY: Symmetrical two-hour rated gypsum wall assembly constructed of the following:
 - A. Steel Studs – Minimum 25 GA galvanized steel studs measuring 3-5/8 inch wide with 1-1/4-inch legs spaced maximum 24 inch on center (O.C.). Attach studs with minimum #6 x 3/8-inch steel stud framing screws to floor and ceiling tracks.
 - B. Tracks – Channel U-shaped floor and ceiling runners measuring 1/2-inch deep by 3-5/8-inch wide, which are secured to floor and ceiling with 1-inch long fasteners, suitable for the mounting to substrate, spaced maximum 18-inch O.C.
 - C. Gypsum Board – Cover studs and runners with two layers of 5/8 inch thick, Type X gypsum board on each face. Fasten base layer of gypsum board to steel studs with #6 1-1/8 inch bugle head phillips drywall screws spaced maximum 12 inch O.C. Fasten face layer of gypsum board with #6 1-5/8 inch long bugle phillips drywall screws spaced maximum 8 inches O.C. Apply vinyl or casein, dry or premixed joint compound to face layers of gypsum board in two coats to all exposed screw heads and gypsum board joints. Embed minimum 2 inch wide paper, plastic or fiberglass tape in first layer of joint compound over joints in gypsum board. Minimum wall assembly thickness of 6 inches measured from face layer of gypsum board to opposite face layer of gypsum board.
 - D. Opening – Create an opening in the wall assembly having a cross-sectional area of maximum 2492 inch² and a maximum dimension of 89 inches. Position the penetrating item (Item 1) concentrically or eccentrically in the opening so that the annular space ranges from minimum 1 inch to maximum 3 inches.
4. PENETRATION FIRESTOP: Symmetrical penetration firestop constructed of the following components:
 - A. CERTIFIED MANUFACTURER: 3M Company
CERTIFIED PRODUCT: 3M Fire Barrier™ Duct Wrap
MODEL: 615

Flexible Wraps

Duct Wrap

Through Wall Assembly

PH

Design No. 3MU/PH 120-25 *continued*

PACKING MATERIAL: Fill the annular space with minimum 6 pcf insulation without the encapsulation (foil scrim). Cut the certified packing material into strips. Layer certified packing material to 50% greater thickness than width of annular space being filled. Compress certified packing material nominally 33%. Insert compressed certified packing material into the annular space. Fill the entire annular space. Recess the surface of certified packing material nominally 5/8 inches from both surfaces of the face layers of the gypsum board of the wall assembly (Item 3).

B. **CERTIFIED MANUFACTURER:** 3M Company

CERTIFIED PRODUCT: 3M Fire Barrier™ Joint Sealant

MODEL: Water Tight 1000 NS Silicone

FILL, VOID OR CAVITY MATERIAL: Install minimum 5/8-inch depth of fill material into the recess over the packing material (Item 4A) on both sides of the wall assembly (Item 3). Screed certified fill material flush with the surface of the wall assembly (Item 3) on both sides.

C. **STEEL ANGLE:** Install nominal 16 GA 2 x 1-1/2 inch steel angle around perimeter of penetrating item (Item 1) with notched ends to create a continuous frame. Place vertical 1-1/2 inch leg of angle flush with face layers of gypsum board of wall assembly (Item 3). Attach horizontal 2 inch leg of angle to the penetrating item (Item 1) using self drilling screws, 12-24x2 Hex washer Head with #5 Point, spaced a maximum of 6 inches O.C.

D. **CERTIFIED MANUFACTURER:** 3M Company

CERTIFIED PRODUCT: 3M Fire Barrier™ Duct Wrap

MODEL: 615

COLLAR: After the penetrating item (Item 1) is insulated with certified insulation (Item 2), install a layer of minimum 24 inch wide, minimum 6 pcf insulation over the penetrating item (Item 1). Position the certified collar abutting the face layers of the gypsum board of the wall assembly (Item 2) on both sides of the wall assembly (Item 2). Overlap the ends of the certified collar a minimum of 3 inches. Certified collar covers the steel angle (Item 4C) of the penetration firestop (Item 4).

This material was extracted and drawn by 3M Fire Protection Products from the 2010 Product Directory, © Intertek

Flexible Wraps

Duct Wrap

Through Wall Assembly

PH

Design No. 3MU/PH 120-26

January 08, 2008

PENETRATION FIRESTOP THROUGH SHAFT WALL ASSEMBLY

3M Company

3M Fire Barrier Duct Wrap

3M Fire Barrier Water Tight 1000-NS Silicone Joint Sealant

ASTM E 814-06

TRating – 2 hr

F Rating – 2 hr

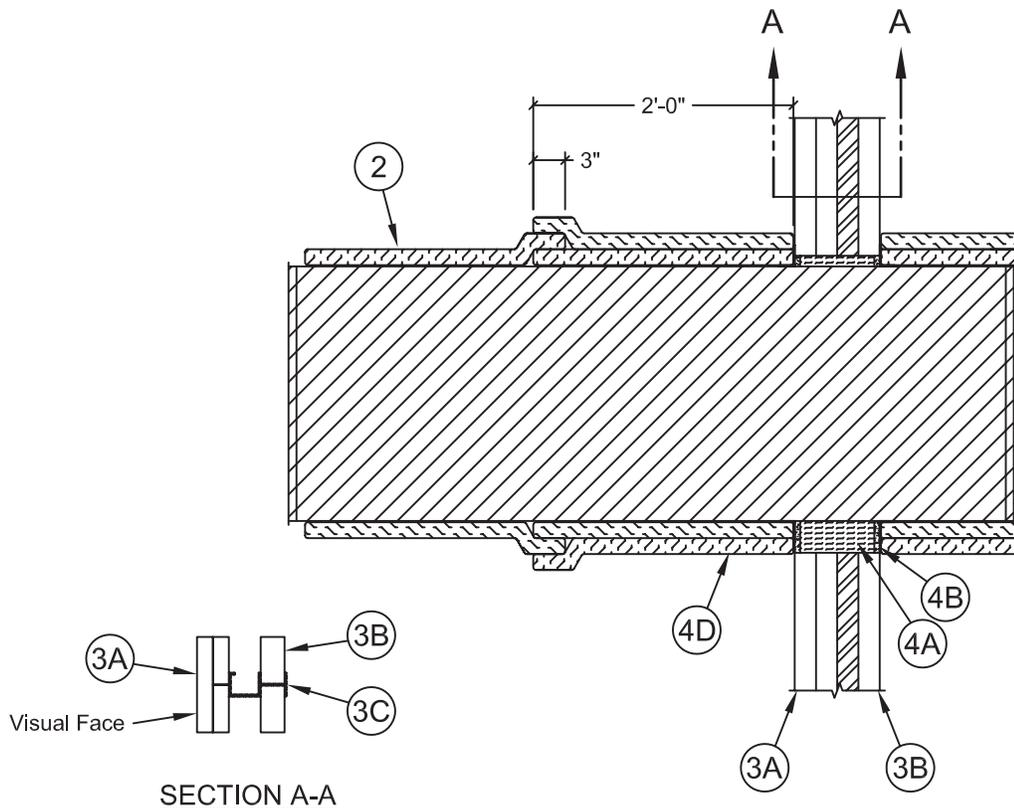

1. PENETRATING ITEM: Rectangular steel duct constructed of minimum 24 GA sheet steel with maximum 2040 inch² area with a maximum 85 inch dimension.
2. CERTIFIED MANUFACTURER: 3M Company
CERTIFIED PRODUCT: 3M Fire Barrier™ Duct Wrap
MODEL: 615
INSULATION: After the packing material (Item 4A) and fill material (Item 4B) of the penetration firestop (Item 4) is installed and the steel angle (Item 4C) attached, protect the penetrating item (Item 1) with at least one layer of minimum 24-inch wide, minimum 6 pcf insulation. Weld mild steel copper plated 12 GA by minimum 7 inch long pins to the bottom of the penetrating item (Item 1) spaced in 12 inch wide rows with pins spaced 10-1/2 inches apart. Wrap penetrating item (Item 1) with a one layer of certified insulation. Overlap the ends of certified insulation a minimum of 3 inches. Place speed clips over the pins to secure certified insulation on bottom. Use nominal 1/2 inch wide, 0.015 inch thick, stainless steel banding and banding clips placed around the circumference of the penetrating item (Item 1) spaced nominally 10-1/2-inches on center to secure certified insulation.
3. WALL ASSEMBLY: Asymmetrical two-hour rated gypsum shaft wall assembly constructed of the following:
 - A. Visual Gypsum Board – Cover studs and runners with two layers of minimum 1/2 inch thick, Type X gypsum board on each face. Fasten base layer of gypsum board to steel studs with #6 1-1/8 inch bugle head phillips drywall screws spaced maximum 12 inch O.C. Fasten face layer of gypsum board with #6, 1-5/8 inch long bugle phillips drywall screws spaced maximum 8 inches O.C. Apply vinyl or casein, dry or premixed joint compound to face layers of gypsum board in two coats to all exposed screw heads and gypsum board joints. Embed minimum 2 inch wide paper, plastic or fiberglass tape in first layer of joint compound over joints in gypsum board. Minimum wall assembly thickness of 6 inches measured from face layer of gypsum board to opposite face layer of gypsum board.
 - B. Interior Gypsum Board – Cut 1-inch thick Type X gypsum board 1-inch less than floor to ceiling height. Insert the longitudinal edges of the 1-inch thick Type X gypsum board into the C-T or C-H studs. Secure the transverse edge of the 1-inch thick Type X gypsum board to the long leg of J-runner using its tabs or minimum 1-5/8-inch long Type S self-tapping bugle head steel screws spaced maximum 12 inches on center.
 - C. Steel Studs – Cut minimum 25 GA galvanized steel C-T or C-H studs measuring minimum 2-1/2 inches wide with minimum 1-1/2-inch flanges 3/4-inches less than floor to ceiling height and spaced maximum 24 inch on center (O.C.) in runners with T or H section abutting long leg of runner.

Flexible Wraps

Duct Wrap

Through Wall Assembly

PH

Design No. 3MU/PH 120-26 *continued*

- D. Runners – Use minimum 2-1/2-inch wide J-runner compatible with studs and having unequal vertical legs: minimum 1-inch short leg and minimum 2-inch long leg. Position J-runners with short leg towards visual face of shaft wall. Attach to floor and ceiling using steel fasteners located a maximum of 2-inches from each end and a maximum of 24 inch O.C.
 - E. Opening – Create an opening in the shaft wall assembly having a cross-sectional area of maximum 2492 inch² and a maximum dimension of 89 inches. Position the duct assembly eccentrically in the opening so that the annular space ranges from minimum 1 inch on one side to maximum 3 inches on the other.
4. PENETRATION FIRESTOP: Symmetrical penetration firestop constructed of the following components:

A. CERTIFIED MANUFACTURER: 3M Company

CERTIFIED PRODUCT: 3M Fire Barrier™ Duct Wrap

MODEL: 615

PACKING MATERIAL: Fill the annular space with minimum 6 pcf insulation without the encapsulation (foil scrim). Cut the certified packing material into strips. Layer certified packing material to 50% greater thickness than width of annular space being filled. Compress certified packing material nominally 33%. Insert compressed certified packing material into the annular space. Fill the entire annular space. Recess the surface of certified packing material nominally 5/8 inches from both surfaces of the face layers of the gypsum board of the wall assembly (Item 3).

B. CERTIFIED MANUFACTURER: 3M Company

CERTIFIED PRODUCT: 3M Fire Barrier™ Joint Sealant

MODEL: Water Tight 1000-NS Silicone

FILL, VOID OR CAVITY MATERIAL: Install minimum 5/8-inch depth of fill material into the recess over the packing material (Item 4A) on both sides of the wall assembly (Item 3). Screed certified fill material flush with the surface of the wall assembly (Item 3) on both sides.

C. STEEL ANGLE: Install nominal 16 GA 2 x 1-1/2 inch steel angle around perimeter of penetrating item (Item 1) with notched ends to create a continuous frame. Place vertical 1-1/2 inch leg of angle flush with face layers of gypsum board of wall assembly (Item 3). Attach horizontal 2 inch leg of angle to the penetrating item (Item 1) using self drilling screws, 12-24x2 Hex washer Head with #5 Point, spaced a maximum of 6 inches O.C.

D. CERTIFIED MANUFACTURER: 3M Company

CERTIFIED PRODUCT: 3M Fire Barrier™ Duct Wrap

MODEL: 615

COLLAR: After the penetrating item (Item 1) is insulated with certified insulation (Item 2), install a layer of minimum 24 inch wide, minimum 6 pcf insulation over the penetrating item (Item 1). Position the certified collar abutting the face layers of the gypsum board of the wall assembly (Item 2) on both sides of the wall assembly (Item 2). Overlap the ends of the certified collar a minimum of 3 inches. Certified collar covers the steel angle (Item 4C) of the penetration firestop (Item 4).

This material was extracted and drawn by 3M Fire Protection Products from the 2010 Product Directory, © Intertek

Flexible Wraps

Duct Wrap

Through Wall Assembly

PH

Design No. 3MU/PH 120-27 *continued*

- C. STEEL ANGLE: Install nominal 16 GA 2 x 1-1/2 inch steel angle around perimeter of penetrating item (Item 1) with notched ends to create a continuous frame. Place vertical 1-1/2 inch leg of angle flush with exposed faces of wall assembly (Item 3). Attach horizontal 2 inch leg of angle to the penetrating item (Item 1) using self drilling screws, 12-24x2 Hex washer Head with #5 Point, spaced a maximum of 6 inches O.C.
- D. CERTIFIED MANUFACTURER: 3M Company
CERTIFIED PRODUCT: 3M Fire Barrier™ Duct Wrap
MODEL: 615
COLLAR: After the penetrating item (Item 1) is insulated with certified insulation (Item 2), install a layer of minimum 24 inch wide, minimum 6 pcf insulation over the penetrating item (Item 1). Position the certified collar abutting the exposed faces both sides of the wall assembly (Item 3). Overlap the ends of the certified collar a minimum of 3 inches. Certified collar covers the steel angle (Item 4C) of the penetration firestop (Item 4).

This material was extracted and drawn by 3M Fire Protection Products from the 2010 Product Directory, © Intertek

Flexible Wraps

Duct Wrap

Through Wall Assembly

PH

Design No. 3MU/PH 120-28

January 11, 2008

PENETRATION FIRESTOP THROUGH WALL ASSEMBLY

3M Company

3M Fire Barrier Duct Wrap

3M Fire Barrier Water Tight 1000-NS Silicone Joint Sealant

ISO 6944 (1985)

Stability – 2 hr

Insulation – 2 hr

Integrity – 2 hr

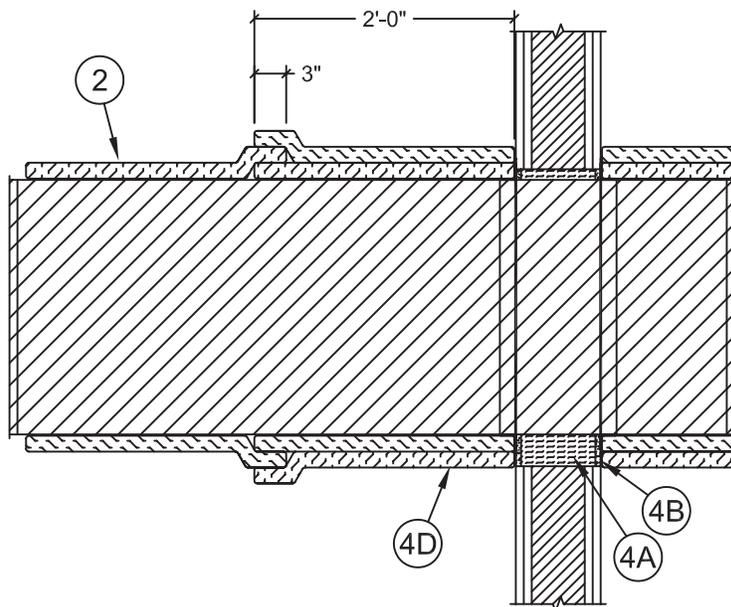

1. PENETRATING ITEM: Rectangular steel duct constructed of minimum 22 GA sheet steel with maximum 2040 inch² area with a maximum 85 inch dimension.
2. CERTIFIED MANUFACTURER: 3M Company
CERTIFIED PRODUCT: 3M Fire Barrier™ Duct Wrap
MODEL: 615
INSULATION: After the packing material (Item 4A) and fill material (Item 4B) of the penetration firestop (Item 4) is installed and the steel angle (Item 4C) attached, protect the penetrating item (Item 1) with insulation applied in accordance with an Intertek ISO 6944 3M Design Listing for a Type A Duct using at least one layer of minimum 24-inch wide, minimum 6 pcf insulation.
3. WALL ASSEMBLY: Symmetrical two-hour rated gypsum wall assembly constructed of the following:
 - A. Steel Studs – Minimum 25 GA galvanized steel studs measuring 3-5/8 inch wide with 1-1/4-inch legs spaced maximum 24 inch on center (O.C.). Attach studs with minimum #6 x 3/8-inch steel stud framing screws to floor and ceiling tracks.
 - B. Tracks – Channel U-shaped floor and ceiling runners measuring 1/2-inch deep by 3-5/8-inch wide, which are secured to floor and ceiling with 1-inch long fasteners, suitable for the mounting to substrate, spaced maximum 18-inch O.C.
 - C. Gypsum Board – Cover studs and runners with two layers of 5/8 inch thick, Type X gypsum board on each face. Fasten base layer of gypsum board to steel studs with #6 1-1/8 inch bugle head phillips drywall screws spaced maximum 12 inch O.C. Fasten face layer of gypsum board with #6 1-5/8 inch long bugle phillips drywall screws spaced maximum 8 inches O.C. Apply vinyl or casein, dry or premixed joint compound to face layers of gypsum board in two coats to all exposed screw heads and gypsum board joints. Embed minimum 2 inch wide paper, plastic or fiberglass tape in first layer of joint compound over joints in gypsum board. Minimum wall assembly thickness of 6 inches measured from face layer of gypsum board to opposite face layer of gypsum board.
 - D. Opening – Create an opening in the wall assembly having a cross-sectional area of maximum 2492 inch² and a maximum dimension of 89 inches. Position the penetrating item (Item 1) concentrically or eccentrically in the opening so that the annular space ranges from minimum 1 inch to maximum 3 inches.
4. PENETRATION FIRESTOP: Symmetrical penetration firestop constructed of the following components:
 - A. CERTIFIED MANUFACTURER: 3M Company
CERTIFIED PRODUCT: 3M Fire Barrier™ Duct Wrap
MODEL: 615
PACKING MATERIAL: Fill the annular space with minimum 6 pcf insulation without the encapsulation (foil scrim). Cut the certified packing material into strips. Layer certified packing material to 50% greater thickness than width of annular space being filled. Compress certified packing material nominally 33%. Insert compressed certified packing material into the annular space. Fill the entire annular space. Recess the surface of certified packing material nominally 5/8 inches from both surfaces of the face layers of the gypsum board of the wall assembly (Item 3).

Flexible Wraps

Duct Wrap

Through Wall Assembly

PH

Design No. 3MU/PH 120-28 *continued*

- B. CERTIFIED MANUFACTURER: 3M Company
CERTIFIED PRODUCT: 3M Fire Barrier™ Joint Sealant
MODEL: Water Tight 1000 NS Silicone
FILL, VOID OR CAVITY MATERIAL: Install minimum 5/8-inch depth of fill material into the recess over the packing material (Item 4A) on both sides of the wall assembly (Item 3). Screed certified fill material flush with the surface of the wall assembly (Item 3) on both sides.
- C. STEEL ANGLE: Install nominal 16 GA 2 x 1-1/2 inch steel angle around perimeter of penetrating item (Item 1) with notched ends to create a continuous frame. Place vertical 1-1/2 inch leg of angle flush with face layers of gypsum board of wall assembly (Item 3). Attach horizontal 2 inch leg of angle to the penetrating item (Item 1) using self drilling screws, 12-24x2 Hex washer Head with #5 Point, spaced a maximum of 6 inches O.C.
- D. CERTIFIED MANUFACTURER: 3M Company
CERTIFIED PRODUCT: 3M Fire Barrier™ Duct Wrap
MODEL: 615
COLLAR: After the penetrating item (Item 1) is insulated with certified insulation (Item 2), install a layer of minimum 24 inch wide, minimum 6 pcf insulation over the penetrating item (Item 1). Position the certified collar abutting the face layers of the gypsum board of the wall assembly (Item 2) on both sides of the wall assembly (Item 2). Overlap the ends of the certified collar a minimum of 3 inches. Certified collar covers the steel angle (Item 4C) of the penetration firestop (Item 4).

This material was extracted and drawn by 3M Fire Protection Products from the 2010 Product Directory, © Intertek

Flexible Wraps

Duct Wrap

Through Wall Assembly

PH

3M Firestop Systems
Flexible Wraps

Plenum Wraps

FRD • BI

Plenum Protection Systems

Plenum Protection System

| 3M Systems | "F" Rating | 3M Product | Application Details |
|----------------|------------|----------------------------------|---|
| 3MU/BI 120-01 | | 3M™ Fire Barrier Plenum Wrap 5A+ | Plenum protection for polyethylene based pipes: PVC, CPVC, PB, PE, PP, or PVDF. (Flame Spread Index: 0, Smoke Developed Index: 5) |
| 3MU/FRD 120-16 | | 3M™ Fire Barrier Plenum Wrap 5A+ | Plenum protection for polyethylene based pipes: PVC, CPVC, PB, PE, PP, or PVDF. (Flame Spread Index: 0, Smoke Developed Index: 5) |
| 3MU/FRD 120-17 | | 3M™ Fire Barrier Plenum Wrap 5A+ | Plenum protection for cable or cable bundles. (Flame Spread Index: 0, Smoke Developed Index: 5) |

Design Number 3MU/BI 120-01

June 28, 2013

PLENUM PROTECTION SYSTEM

3M Company

3M Fire Barrier™ Plenum Wrap 5A+

ASTM E 84

Flame Spread Index = 0

Smoke Developed Index = 5

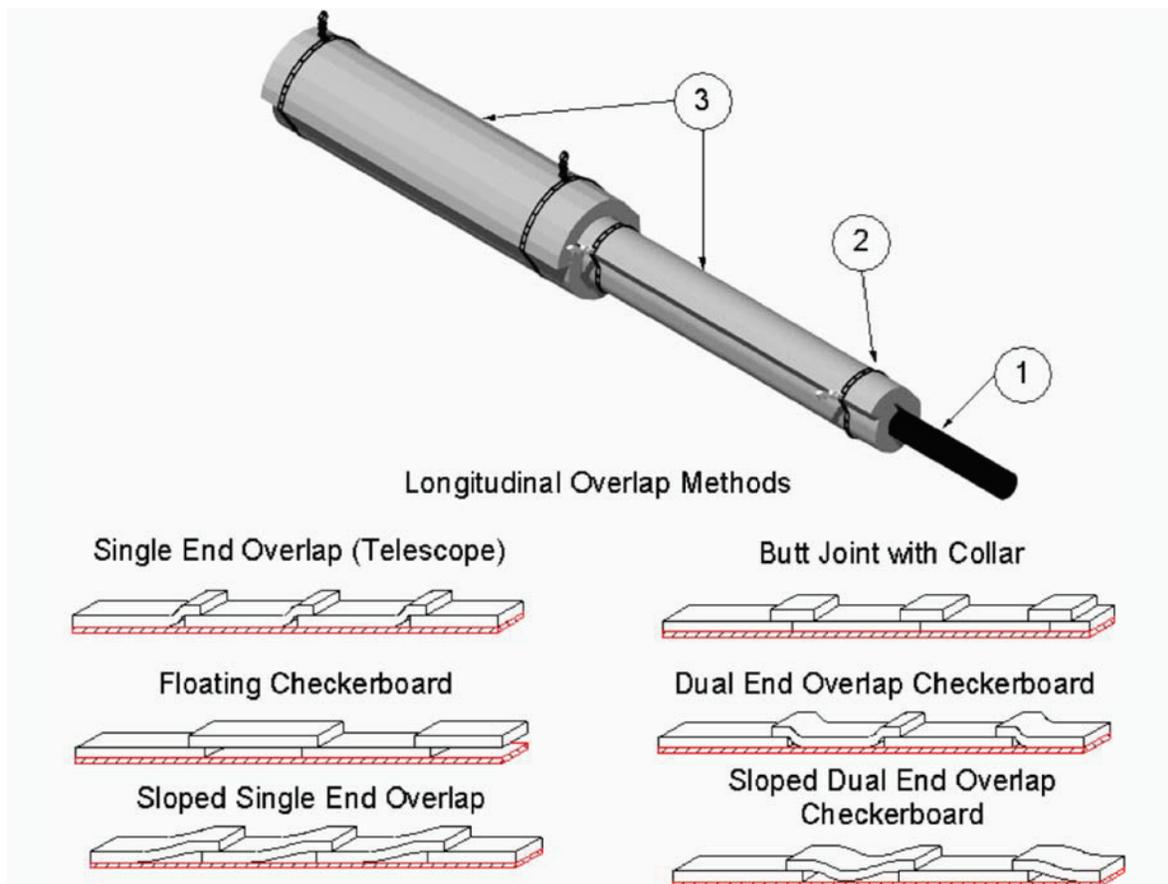

Figure 1

1. PIPE ASSEMBLY: Pipe or conduit with a mass equal to, or less than, of two 4-inch diameter schedule 40 polyethylene pipes. The acceptable pipe materials are one of the following compounds: polyvinyl chloride (PVC), chlorinated polyvinyl chloride (CPVC), polybutylene (PB), polyethylene (PE), polypropylene (PP) or polyvinylidene fluoride (PVDF).
2. FASTENER: Use either wire ties or steel banding to secure each piece of insulation (Item 3) applied around the pipe assembly (Item 1). When banding is selected, use minimum 1/2-inch wide stainless steel bands, which are nominally 0.015-inches thick or 1/2-inch wide carbon steel banding equivalent, which are nominally 0.020-inches thick. When desired, use of filament tape as a temporary hold for the insulation prior to fastening to ease installation is permitted. Place the bands a maximum 1 inch from each blanket edge. Tension the banding material to hold the insulation in place without causing any cutting or damage to the insulation (Item 3). When wire ties are selected, use minimum 24 GA steel wire ties. Place the wire ties a maximum 1 inch from each insulation (Item 3) edge. Tension the wire ties by twisting them together to hold the insulation (Item 3) in place without causing any cutting or damage to the insulation (Item 3).
3. CERTIFIED MANUFACTURER: 3M Company
CERTIFIED PRODUCT: 3M Fire Barrier™ Duct Wrap
MODEL: 5A+
INSULATION: Cover the pipe assembly (Item 1) with a single layer of min. 1/2-in. thick by minimum 24-inch wide refractory ceramic fiber blanket or calcium magnesium silicate blanket with a nominal density of 6-pcf. Use insulation fully encapsulated with foil scrim facing. Place one end of the insulation on the pipe assembly (Item 1) and wrap the insulation completely around the pipe assembly (Item 1). Overlap the other end of the insulation a minimum of 1 inch around the perimeter. Overlap the next piece of insulation onto the first piece of insulation a minimum of 1 inch. Overlap adjacent insulation using one of the following methods: (1) telescoping method where each adjacent insulation has one edge exposed and one edge covered by the next piece of insulation, (2) various checkerboard patterns detailed where both edges of each alternating insulation are covered by each adjacent insulation whose edges are exposed, or (3) a butt splice with collar method where the insulation are butted together and a 2-inch wide collar of insulation is centered over the butt splice overlapping each adjacent insulation 1 inch.
4. TAPE: (Not Shown) Apply pressure sensitive tape with aluminum foil facing to all exposed edges of the insulation (Item 3). Overlap tape onto insulation a minimum of 1-inch.

This material was extracted and drawn by 3M Fire Protection Products from the 2013 Product Directory, © Intertek



Design Number 3MU/FRD 120-16

June 28, 2010
 (Formerly OPL PP 100 P)
 Plenum Protection System
 3M Company
 3M Fire Barrier™ Plenum Wrap 5A+
 UL 1887
 (Former Test UL 910)
 Maximum Flame Spread = 0.0 ft
 Maximum Smoke (optical density) = 0.0
 Average Smoke (optical density) = 0.002

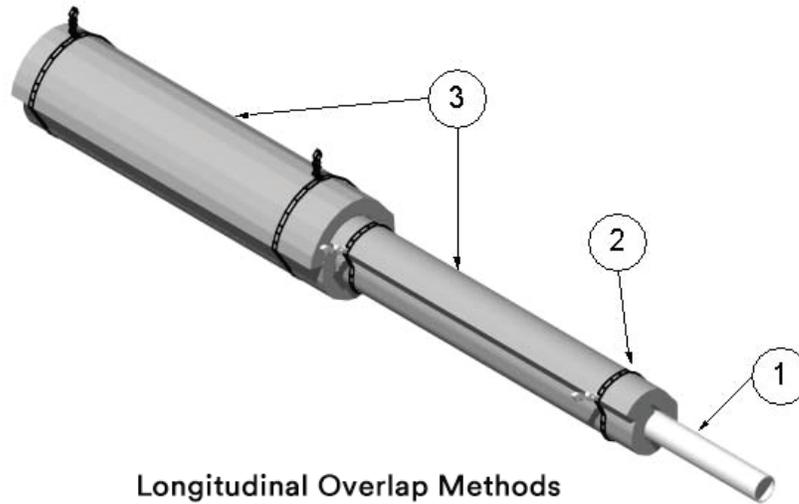

Longitudinal Overlap Methods

Single End Overlap (Telescope)

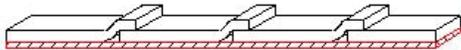

Floating Checkerboard



Sloped Single End Overlap



Butt Joint with Collar

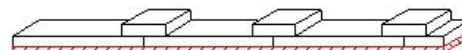

Dual End Overlap Checkerboard



Sloped Single End Overlap Checkerboard

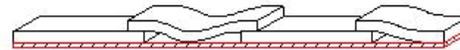

- PIPE ASSEMBLY:** One or more min. 1-inch diameter pipe or conduits composed of various compositions including polyvinyl chloride (PVC), chlorinated polyvinyl chloride (CPVC), acrylonitrile butadiene styrene (ABS), polybutylene (PB), polyethylene (PE), polypropylene (PP) and polyvinylidene fluoride (PVDF).
- FASTENER:** Use either wire ties or steel banding to secure each piece of insulation (Item 3) applied around the pipe assembly (Item 1). When banding is selected, use minimum 1/2-inch wide stainless steel bands, which are nominally 0.015-inches thick or 1/2-inch wide carbon steel banding equivalent, which are nominally 0.020-inches thick. When desired, use of filament tape as a temporary hold for the insulation prior to fastening to ease installation is permitted. Place the bands a maximum 1 inch from each blanket edge. Tension the banding material to hold the insulation in place without causing any cutting or damage to the insulation (Item 3). When wire ties are selected, use minimum 24 GA steel wire ties. Place the wire ties a maximum 1 inch from each insulation (Item 3) edge. Tension the wire ties by twisting them together to hold the insulation (Item 3) in place without causing any cutting or damage to the insulation (Item 3).

This material was extracted and drawn by 3M Fire Protection Products from the 2018 Product Directory, © Intertek

3. CERTIFIED MANUFACTURER: 3M Company CERTIFIED PRODUCT: 3M Fire Barrier™ Duct Wrap MODEL: 5A+

INSULATION: Cover the pipe assembly (Item 1) with a single layer of min. 1/2-in. thick by minimum 24-inch wide refractory ceramic fiber blanket or calcium magnesium silicate blanket with a nominal density of 6-pcf. Use insulation fully encapsulated with foil scrim facing. Place one end of the insulation on the pipe assembly (Item 1) and wrap the insulation completely around the pipe assembly (Item 1). Overlap the other end of the insulation a minimum of 1 inch around the perimeter. Overlap the next piece of insulation onto the first piece of insulation a minimum of 1 inch. Overlap adjacent insulation using one of the following methods: (1) telescoping method where each adjacent insulation has one edge exposed and one edge covered by the next piece of insulation, (2) various checkerboard patterns detailed where both edges of each alternating insulation are covered by each adjacent insulation whose edges are exposed, or (3) a butt splice with collar method where the insulation are butted together and a 2-inch wide collar of insulation is centered over the butt splice overlapping each adjacent insulation 1 inch.

4. TAPE: (Not Shown) Apply pressure sensitive tape with aluminum foil facing to all exposed edges of the insulation (Item 3). Overlap tape onto insulation a minimum of 1-inch.

Flexible Wraps

Plenum

FRD



Design Number 3MU/FRD 120-17

June 28, 2010

(Formerly OPL PP 101 P)

PLENUM PROTECTION SYSTEM

3M Company

3M Fire Barrier™ Plenum Wrap 5A+

NFPA 262

(Former Test UL 910)

Maximum Flame Spread = 1.4 ft

Maximum Smoke (optical density) = 0.056

Average Smoke (optical density) = 0.010

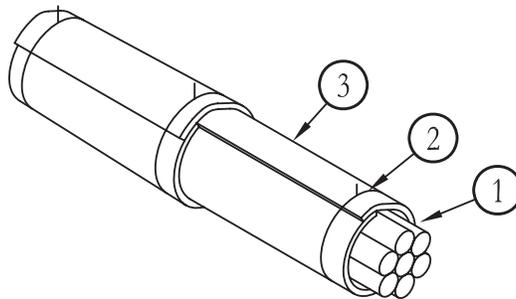

SINGLE END OVERLAP (TELESCOPE)



BUTT JOINT WITH COLLAR

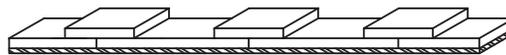

FLOATING CHECKERBOARD



DUAL END OVERLAP CHECKERBOARD

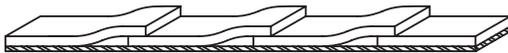
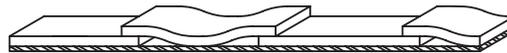

SLOPED SINGLE END OVERLAP

SLOPED DUAL END OVERLAP
CHECKERBOARD

1. CABLE ASSEMBLY: One or more minimum 1/4-inch diameter copper cables sheathed with various compositions including polyvinyl chloride (PVC), chlorinated polyvinyl chloride (CPVC), acrylonitrile butadiene styrene (ABS), polybutylene (PB), polyethylene (PE) polypropylene (PP) and polyvinylidene fluoride (PVDF).
2. FASTENER: Use either wire ties or steel banding to secure each piece of insulation (Item 3) applied around the cable assembly (Item 1). When banding is selected, use minimum 1/2-inch wide stainless steel bands, which are nominally 0.015-inches thick or 1/2-inch wide carbon steel banding equivalent, which are nominally 0.020-inches thick. When desired, use of filament tape as a temporary hold for the insulation prior to fastening to ease installation is permitted. Place the bands a maximum 1 inch from each blanket edge. Tension the banding material to hold the insulation in place without causing any cutting or damage to the insulation (Item 3). When wire ties are selected, use minimum 24 GA steel wire ties. Place the wire ties a maximum 1 inch from each insulation (Item 3) edge. Tension the wire ties by twisting them together to hold the insulation (Item 3) in place without causing any cutting or damage to the insulation (Item 3).
3. CERTIFIED MANUFACTURER: 3M Company
CERTIFIED PRODUCT: 3M Fire Barrier™ Duct Wrap
MODEL: 5A+

INSULATION: Cover the cable assembly (Item 1) with a single layer of min. 1/2-in. thick by minimum 24-inch wide refractory ceramic fiber blanket or calcium magnesium silicate blanket with a nominal density of 6-pcf. Use insulation fully encapsulated with foil scrim facing. Place one end of the insulation on the cable assembly (Item 1) and wrap the insulation completely around the cable assembly (Item 1). Overlap the other end of the insulation a minimum of 1 inch around the perimeter. Overlap the next piece of insulation onto the first piece of insulation a minimum of 1 inch. Overlap adjacent insulation using one of the following methods: (1) telescoping method where each adjacent insulation has one edge exposed and one edge covered by the next piece of insulation, (2) various checkerboard patterns detailed where both edges of each alternating insulation are covered by each adjacent insulation whose edges are exposed, or (3) a butt splice with collar method where the insulation are butted together and a 2-inch wide collar of insulation is centered over the butt splice overlapping each adjacent insulation 1 inch.

4. TAPE: (Not Shown) Apply pressure sensitive tape with aluminum foil facing to all exposed edges of the insulation (Item 3). Overlap tape onto insulation a minimum of 1-inch

This material was extracted and drawn by 3M Fire Protection Products from the 2010 Product Directory, © Intertek

Mats

X • AF • XR

Structural Steel Protection

AF • FHIT

Electrical Circuit Protection

FP

Fuel Oil Pipe Protection

Structural Steel Protection

| 3M Systems | "F" Rating | 3M Product | Application Details |
|----------------------|--------------------|--|---|
| Cellulosic | | | |
| X203 | 1, 2, 3 | 3M™ Interam™ Endothermic Mat E-5A-4 3M™ Fire Barrier Sealant CP 25WB+ 3M™ Aluminum Foil Tape 425 | Min column W10×49 with outside dimension of 10 in. x 10 in., 9/16 in. flange thickness, 5/16 in. web thickness, 14.4 sq. ft. cross-sectional area. Enclosure consists of Interam E-5A 4 mat, stainless steel banding, T-49 tape, and CP25WB+. Stainless steel jacket required. 1, 2, and 3 hour F rating. Also known as X203. |
| X204 | 2, 3 | 3M™ Interam™ Endothermic Mat E-5A-4 3M™ Fire Barrier Sealant CP 25WB+ 3M™ Aluminum Foil Tape 425 | Min column W10×49 with outside dimension of 10 in. x 10 in., 9/16 in. flange thickness, 5/16 in. web thickness, 14.4 sq. in. cross-sectional area. Enclosure consists of Interam E-5A 4 mat, stainless steel banding, T-49 tape, and CP25WB+. Stainless steel jacket required. 2 and 3 hour F rating. Also known as X204. |
| X206 | 1, 2, 3, 4 | 3M™ Interam™ Endothermic Mat E-5A-4 3M™ Fire Barrier Sealant CP 25WB+ 3M™ Aluminum Foil Tape 425 | Min W10×49 steel column. Number of layers of Interam E-5A-4 Mat dependent on hourly rating. 1/2, 3/4, 1, 1-1/2, , 3, & 4 hour F. Tested per ANSI/UL 263 (ASTM E 119). Foil tape all joints & seams. Steel banding required over final layer. |
| 3MU/AF 240-02 | 4 | 3M™ Interam™ Endothermic Mat E-5A-4 3M™ Fire Barrier Sealant CP 25WB+ 3M™ Aluminum Foil Tape 425 | 4 hour floor assembly rating for minimum W8×28 steel beams holding up a 12 inch thick concrete floor. |
| Hydrocarbon | | | |
| XR201 | 1, 2 | 3M™ Interam™ Endothermic Mat E-5A-4 3M™ Fire Barrier Sealant CP 25WB+ 3M™ Aluminum Foil Tape 425 | Min column W10×49 with outside dimension of 10 in. x 10 in., 9/16 in. flange thickness, 5/16 in. web thickness, 14.4 sq. in. cross-sectional area. Enclosure consists of Interam E-5A 4 mat, stainless steel banding, T-49 tape, and CP25WB+. Stainless steel jacket required. 1 and 2 hour F rating. Also known as XR201. |
| XR202 | 1, 2, 3, 4 | 3M™ Interam™ Endothermic Mat E-5A-4 3M™ Fire Barrier Sealant CP 25WB+ 3M™ Aluminum Foil Tape 425 3M™ Fire Barrier Water Tight Sealant 3000 WT | Min W10×49 steel column. Number of layers of Interam E-5A-4 Mat dependent on hourly rating. 1/2, 3/4, 1, 1-1/2, , 3, & 4 hour F. Tested per ANSI/UL 1709 (ASTM E 1529). Foil tape all vertical overlaps & butt joint seams. Steel banding required over final layer. Aluminum or steel cladding jacket required. Also known as XR202. |
| XR203 | 1, 2, 3, 4 | 3M™ Interam™ Endothermic Mat ES-5A-12 3M™ Fire Barrier Sealant CP 25WB+ 3M™ Fire Barrier Water Tight Sealant 3000 WT 3M™ Aluminum Foil Tape 425 | Min W10×49 steel columns for hydrocarbon pool protection. |
| 3MU/AF 240-01 | 4 | 3M™ Interam™ Endothermic Mat E-5A-4 3M™ Fire Barrier Sealant CP 25WB+ 3M™ Aluminum Foil Tape 425 | 4 hour structural protection for minimum W8×28 steel beams holding up a 12 inch thick concrete floor. |
| Torch Fire | | | |
| 3MU/AF 50-01 | | 3M™ Interam™ Endothermic Mat E-5A-4 3M™ Aluminum Foil Tape 425 | Applied fireproofing (per NFPA 290 and NFPA 58) for an approved container used for storage of liquid propane gas (LPG). |
| Jet Fire | | | |
| 3MU/AF 120-02 | 15 Min, 120 Min | 3M™ Interam™ Endothermic Mat E-5 3M™ Interam™ Endothermic Mat E-5A-4 3M™ Aluminum Foil Tape 425 | Min 20 mm thick structural steel with 10 mm steel panels. 2 layers of E-5A-4 Endothermic Mat with stainless steel sheathing |
| 3MU/AF 120-04 | 15 Min, 132 Min | 3M™ Interam™ Endothermic Mat ES-5A-12 3M™ Fire Barrier Sealant CP 25WB+ | Structural steel having a min. thickness of 20 +/- 0.25mm (0.79 +/- 0.01 in.). Jet fire Exposure for 15 minutes to 132 minutes. |
| 3MU/AF 180-04 | 15 Min, 180 Min | 3M™ Interam™ Endothermic Mat E-5 3M™ Interam™ Endothermic Mat E-5A-4 3M™ Aluminum Foil Tape 425 | Min 10 mm steel panel. Two layers of E-5A-4 Endothermic Mat with stainless steel sheathing |
| 3MU/AF 240-03 | 1, 2, 3, 4 | 3M™ Interam™ Endothermic Mat E-5 3M™ Interam™ Endothermic Mat E-5A-4 3M™ Aluminum Foil Tape 425 | 4 hour jet fire protection for a steel panel. |
| 3MU/AF 240-04 | 1, 2, 3, 4 | 3M™ Interam™ Endothermic Mat E-5 3M™ Interam™ Endothermic Mat E-5A-4 3M™ Fire Barrier Sealant CP 25WB+ 3M™ Aluminum Foil Tape 425 | 4 hour jet fire protection for a steel panel. Additional steel panel reinforcements acceptable. |



UL System No. X203
BXUV - Fire Resistance Ratings - ANSI/UL 263
BXUV7 - Fire Resistance Ratings - CAN/ULC-S101 Certified for Canada

October 24, 2017

Ratings – 1, 2 and 3 Hr.

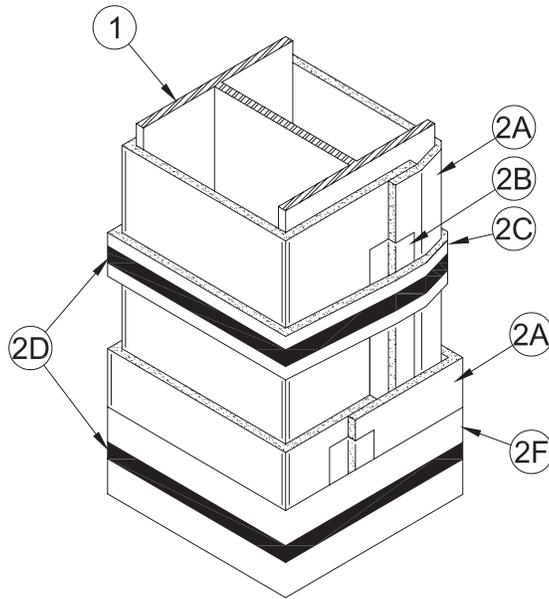

1. **Steel Column** – Min size of column W10×49, with outside dimensions 10 by 10 in., a flange thickness of 9/16 in., a web thickness of 5/16 in. and a cross-sectional area of 14.4 in. sq ft.
2. **Mat Materials*** – The column protection assembly consists of endothermic mat, aluminum foil tape, intumescent jacket. The assembly shall be installed in accordance with detailed installation instructions manual supplied by the manufacturer of the **Mat Materials***. The details of the column assembly are summarized below:

A. Mat Materials* – Endothermic Mat – Flexible sheet supplied in rolls. Each layer of mat installed by cutting to size and tightly wrapping around the column and itself such that a min 2 in. overlap is present along the vertical seam. With the exception of the final layer of mat, adjacent lengths of mat in each layer to be installed with tightly butted end seams. Successive layers of mat installed in same manner with butted end seams offset a min 2 in. from butted end seams of preceding layer. For final layer of mat, adjacent lengths of mat to overlap the preceding length a min of 2 in. All seams in each layer of mat to be sealed with foil tape (Item 2B). The hourly rating of the column assembly is dependent upon the number of endothermic mat layers as shown in the following table:

| Minimum Layers of Endothermic | Hourly Fire Rating |
|-------------------------------|--------------------|
| 1 | 1 |
| 2 | 2 |
| 3 | 3 |

3M COMPANY – Type E-5A-3, E-5A-4, E-53A, E-53C, E-54A or E-54C.

- B. Mat Material* – Aluminum Foil Tape** – Nom 4 in. wide pressure-sensitive aluminum foil tape supplied in rolls. Used to secure the vertical and circumferential butt joints of the endothermic mat (Item 2A).
 - C. Mat Materials* – Intumescent Mat** – Flexible sheet material supplied in rolls. After completion of the first layer of endothermic mat (Item 2A) nom 2 in. wide intumescent mat installed by cutting to size and wrapping around the endothermic mat. The intumescent mat spaced 8 in. OC and max 2 in. from and on both sides of the circumferential butt joints with steel banding straps and clips (Item 2D).
- 3M COMPANY** – Type I-10A or M-20A.
- D. Steel Banding Straps** – Min 5/8 in. wide by 0.020 in. thick stainless steel banding straps used in conjunction with No. 26 gauge galv steel wing-type crimp clips. Steel banding straps spaced 8 in. OC and 2 in. from and on both sides of the circumferential butt joints to secure intumescent mat (Item 2C). Steel banding straps and crimp clips required to be installed over the second layer of endothermic mat (Item 2A) and the third layer of the mat for a 1 h rating and 2 h rating, respectively.

Flexible Wraps

Endothermic Mat

Structural Protection



UL System No. X203 (cont.)

E. Fill, Void or Cavity Material – Caulk* – (Not Shown) Thick bead of caulk to be applied as a gasket between the endothermic mat (Item 2A) and the floor or ceiling surface. The bead of caulk applied around entire perimeter of endothermic mat at the interface of floor or ceiling surface.

3M COMPANY – Type CP 25WB+.

F. Stainless Steel Jacket – After completion of the mats and steel banding straps, nom 36 in. wide by min No. 32 gauge (0.012 in.) thick stainless steel jacket wrapped around the outer layer of the mat. Adjacent lengths of steel jacket to overlap the preceding length a min of 5 in. All horizontal. Steel jacket secured in place with steel banding straps and clips (Item 2D) spaced max 8 in. OC and max 1 in. from all horizontal seams.

Flexible Wraps

Endothermic Mat

Structural Protection

X



*Indicates such products shall bear the UL or cUL Certification Mark for jurisdictions employing the UL or cUL Certification (such as Canada), respectively.

Reprinted from the Online Certifications Directory with permission from UL©

3M Industrial Adhesive and Tapes
Fire Protection Products
3M Center, Building 230-B-S-37
St. Paul, MN 55144-1000

X203 • 2 of 2

3M Fire Protection Products
Applicator and Specifier Guide
<http://3M.com/firestop> 1-800-328-1687



UL System No. X204
BXUV - Fire Resistance Ratings - ANSI/UL 263
BXUV7 - Fire Resistance Ratings - CAN/ULC-S101 Certified for Canada

October 24, 2017

Rating – 2 and 3 Hr.

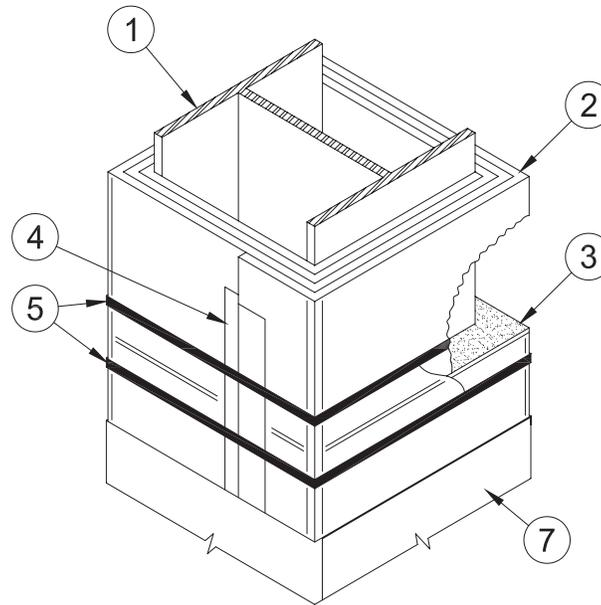

1. **Steel Column** – Min size of column W10×49 with outside dimensions of 10 by 10 in., a flange thickness of 9/16 in., a web thickness of 5/16 in. and a cross-sectional area of 14.4 sq in.
2. **Mat Materials*** – Flexible endothermic mat supplied in rolls. Starting at the column flange edge at the base of the column, a continuous length of mat is circumferentially wrapped around the column, with the foil side facing outward, to attain the required number of mat layers. For the 2 h fire rating, the mat wrap length shall result in a min two layer cover over three sides of the column and a three layer cover over one flange face. For the 3 h fire rating, the mat wrap length shall result in a min three layer cover over three sides of the column and a four layer cover over one flange face. Butted circumferential joint between adjoining lengths of mat wrap to be sealed with endothermic caulk (Item 3) and covered with aluminum foil tape (Item 4). Vertical seam of adjoining lengths to align with one another and to be sealed with aluminum foil tape.
3M COMPANY – Type E-5A-3, E-5A-4, E-53A, E-53C, E-54A or E-54C.
3. **Endothermic Caulk*** – Applied to completely fill butted circumferential joint between adjoining lengths of mat material. Additional endothermic caulk to be applied to butted joints after installation of banding straps, as necessary, to fill all gaps.
3M COMPANY – Type FD-150.
4. **Aluminum Foil Tape** – Nom 4 in. wide min 2 mil thick pressure-sensitive aluminum foil tape supplied in rolls. Used to cover vertical seam of mat wrap and to cover butted circumferential joint between adjoining lengths of mat wrap after installation of the endothermic caulk.
5. **Steel Banding Straps** – Min 1/2 in. wide by 0.020 in. thick stainless steel banding straps used in conjunction with stainless steel crimp clips. Steel banding straps spaced max 12 in. OC and max 2 in. from and on both sides of the butted circumferential joints to secure mat. Additional steel banding straps required to secure stainless steel jacket (Item 7.)
6. **Caulk*** – (Not shown) – Thick bead of caulk to be applied around entire perimeter of endothermic mat (Item 2) at its interface with the floor and ceiling surfaces.
3M COMPANY – Type CP 25WB+.
7. **Stainless Steel Jacket** – After completion of the mat wrap installation, nominal 36 in. wide by minimum 0.009 in. thick stainless steel jacket wrapped around the endothermic mat and lapping itself approximately 6 in. Adjoining lengths of stainless steel jacket to overlap a minimum of 4 in. Steel jacket secured in place with stainless steel banding straps (Item 5) spaced maximum 12 in. OC and maximum 1 in. from all seams.

Flexible Wraps

Endothermic Mat

Structural Protection

X

*Indicates such products shall bear the UL or cUL Certification Mark for jurisdictions employing the UL or cUL Certification (such as Canada), respectively.

Reprinted from the Online Certifications Directory with permission from UL©



Design No. X206

July 13, 2012

Ratings – 1/2, 3/4, 1, 1-1/2, 2, 3 and 4 Hr.

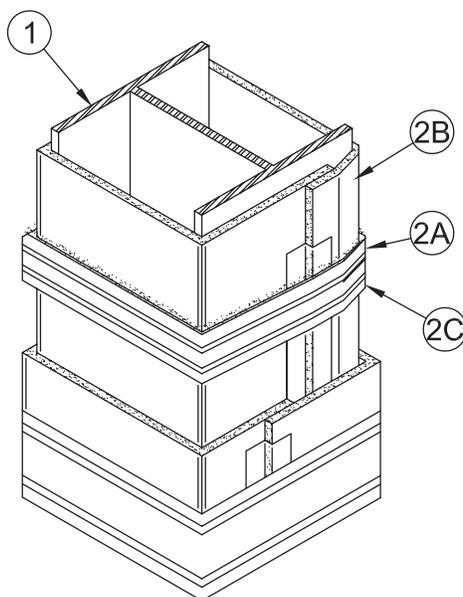

1. **Steel Column** – Min size of column W10x49.
2. **Mat Materials*** – The column protection assembly consists of endothermic mat, aluminum foil tape, and aluminum cladding. The details of the column assembly are summarized below:
 - A. **Mat Materials* – Endothermic Mat** – Flexible mat supplied in rolls. Each layer of foil-faced mat installed by cutting to size and tightly wrapping around the column and itself such that a min 2 in. overlap is present along the vertical seam. Seam are located on the column flange. Sections are temporarily held in place with several strips of 3M Type 898 filament tape (approx. 24 in. long). Adjacent sections of material on the same layer abut one another forming the circumferential edge seam. Successive layers of mat installed in same manner with butted end seams offset a min 2 in. from butted end seams of preceding layer. For single layer construction only, a 4 in. wide endothermic mat collar is wrapped around each taped circumferential butt joint with a 2 in. overlap on itself. Circumferential edges of collar are sealed with foil tape. Stainless steel bands are applied as described under Item 2C. All seams in each layer of mat to be sealed with foil tape (Item 2B) prior to installation of subsequent layer of mat or collars. The hourly rating of the column assembly is dependent upon the number of endothermic mat layers as shown in the following table:

| Minimum Layers of Endothermic Mat Material | Hr Fire Rating |
|--|----------------|
| 1 | 1/2 |
| 1 | 3/4 |
| 1 | 1 |
| 2 | 1-1/2 |
| 2 | 2 |
| 3 | 3 |
| 4 | 4 |

3M COMPANY

3M FIRE PROTECTION PRODUCTS – Interam™ Types E-54A, E-5A-4 or E-54C.

- B. **Aluminum Foil Tape*** – (Shown at vertical seam but not shown at butt joints, collars or cladding for clarity) Nom 4 in. wide pressure-sensitive aluminum foil tape supplied in rolls. Used to secure the vertical overlap and circumferential butt joint seams of the endothermic mat (Item 2A).
- 3M COMPANY**
3M FIRE PROTECTION PRODUCTS – Type 425
- C. **Steel Banding Straps** – Min 1/2 in. wide by 0.020 in. thick stainless steel banding straps used in conjunction with No. 26 gauge galv steel wing-type crimp clips. Steel banding straps installed at the center and 2 in. from end of mat sections. Steel banding straps applied approx. 1 in. from edges of collars. Steel banding straps installed at the center and 1 in. from top and 1-1/2 in. from bottom of each section.
 - D. **Fill, Void or Cavity Material – Caulk*** – (Not Shown) Thick bead of caulk to be applied as a gasket between the endothermic mat (Item 2A) and the floor or ceiling surface. The bead of caulk applied around entire perimeter of endothermic mat at interface of floor or ceiling surface prior to and after each layer of mat material and after installation of the cladding.

3M COMPANY

3M FIRE PROTECTION PRODUCTS – Type CP 25WB+ or FB 3000 WT.

*Bearing the UL Classification Mark

Reprinted from the Online Certifications Directory with permission from UL

© 2012 UL LLC



Design Number 3MU/AF 240-02

(Formerly Design B 302)

30-Aug-12

APPLIED FIREPROOFING

3M Company

3M™ Interam™ E-5, E-54-A and E-5A-4 Series Endothermic Mat

3M™ Fire Barrier CP 25WB+ Caulk

ASTM E 119

Restrained or Unrestrained Beam Rating: 4 Hours

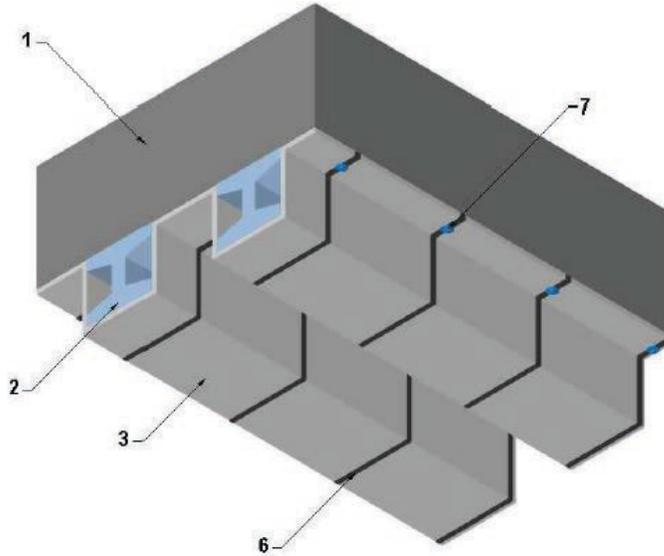

- 1. Concrete Floor:** Use normal or lightweight concrete floor with minimum compressive strength of 109 pcf having a minimum depth of 12 in.
- 2. Steel Beam:** Use minimum W8×48 W-Shaped steel beam.
- 3. Certified Manufacturer:** 3M Company
Certified Product: Applied Fireproofing
Model: 3M™ Interam™ E-5, E-54-A and E-54A-4 Series Endothermic Mat
Endothermic Mat: Install 1 layer of foil faced flexible mat around steel beam (Item 2). Cut length of endothermic mat to ensure minimum 4 in. overlap onto concrete floor (Item 1) adjacent to steel beam (Item 2). Tightly butt joints of endothermic mat and seal joints with foil tape (Item 5).
- 4. Certified Manufacturer:** 3M Company
Certified Product: Caulk or Sealant
Model: 3M Fire Barrier CP 25WB+ Caulk
Caulk (Not Shown): Fill any gaps between concrete floor and endothermic mat (Item 3) with caulk.
- 5. Tape:** (Not Shown) Apply 4 in. wide pressure sensitive tape with aluminum foil facing to all butt joints of the endothermic mat (Item 3).
- 6. Steel Banding:** Install 1/2 in. wide x 0.020 in. thick stainless steel banding around endothermic mat (Item 3) and secure into concrete using fasteners (Item 7). Space banding max. 12 in. oc.
- 7. Fastener:** Secure endothermic mat (Item 3) and steel banding (Item 6) to concrete floor (Item 1) using min. 1/4 in. concrete anchors inserted through 1 in. diameter fender washer.

This material was extracted and drawn by 3M Fire Protection Products from the 2018 Product Directory, © Intertek



UL System No. XR201
BYBU - Fire-resistance Ratings - ANSI/UL 1709

June 25, 2018

Rating — 1, 1-1/2 and 2 Hr.

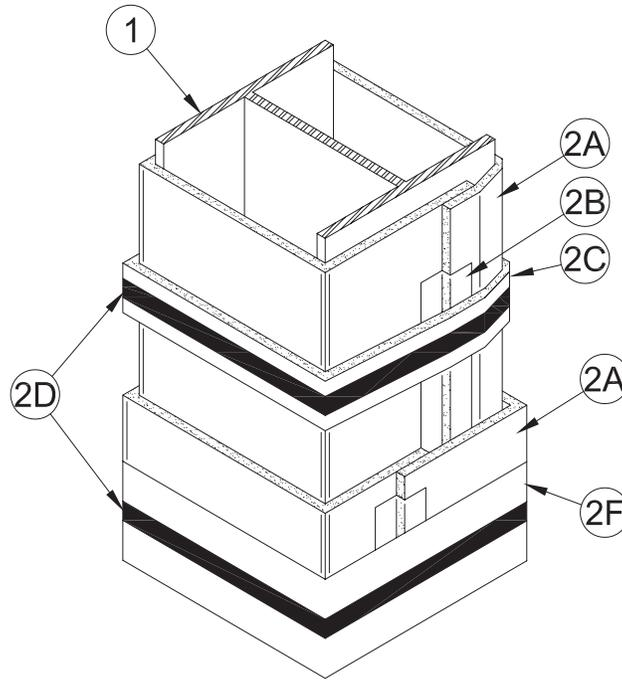

1. **Steel Column** – Min size of column W10×49, with outside dimensions 10 by 10 in., a flange thickness of 9/16 in., a web thickness of 5/16 in. and a cross-sectional area of 14.4 in. sq ft.
2. **Mat Materials*** – The column protection assembly consists of endothermic mat, aluminum foil tape, intumescent jacket. The assembly shall be installed in accordance with detailed installation instructions manual supplied by the manufacturer of the **Mat Materials***. The details of the column assembly are summarized below:
 - A. **Mat Materials* – Endothermic Mat** – Flexible sheet supplied in rolls. Each layer of mat installed by cutting to size and tightly wrapping around the column and itself such that a min 2 in. overlap is present along the vertical seam. With the exception of the final layer of mat, adjacent lengths of mat in each layer to be installed with tightly butted end seams. Successive layers of mat installed in same manner with butted end seams offset a min 2 in. from butted end seams of preceding layer. For final layer of mat, adjacent lengths of mat to overlap the preceding length a min of 2 in. All seams in each layer of mat to be sealed with foil tape (Item 2B). The hourly rating of the column assembly is dependent upon the number of endothermic mat layers as shown in the following table:

| Min Layers of Endothermic Mat Mtl | Hr Fire Rating |
|-----------------------------------|----------------|
| 2 | 1 |
| 2 | 1-1/2 |
| 3 | 2 |

3M COMPANY – Type E-5A-3, E-5A-4, E-53A, E-53C, E-54A or E-54C.

- B. **Mat Materials* – Aluminum Foil Tape** – Nom 4 in. wide pressure-sensitive aluminum foil tape supplied in rolls. Used to secure the vertical and circumferential butt joints of the endothermic mat (Item 2A).
- C. **Mat Materials* – Intumescent Mat** – Flexible sheet material supplied in rolls. After completion of the first layer of endothermic mat (Item 2A) nom 2 in. wide intumescent mat installed by cutting to size and wrapping around the endothermic mat. The intumescent mat spaced 8 in. OC and max 2 in. from and on both sides of the circumferential butt joints with steel banding straps and clips (Item 2D).

3M COMPANY – Type I-10A or M-20A.
- D. **Steel Banding Straps** – Min 5/8 in. wide by 0.020 in. thick stainless steel banding straps used in conjunction with No. 26 gauge galv steel wing-type crimp clips. Steel banding straps spaced 8 in. OC and 2 in. from and on both sides of the circumferential butt joints to secure intumescent mat (Item 2C). Steel banding straps and crimp clips required to be installed over the second layer of endothermic mat (Item 2A) and the third layer of the mat for a 1 h rating and 2 h rating, respectively.

UL System No. XR201 (cont.)

E. Fill, Void or Cavity Material – Caulk* – (Not Shown) Thick bead of caulk to be applied as a gasket between the endothermic mat (Item 2A) and the floor or ceiling surface. The bead of caulk applied around entire perimeter of endothermic mat at interface of floor or ceiling surface.

3M COMPANY – Type CP 25WB+.

F. Stainless Steel Jacket – After completion of the mats and steel banding straps, nom 36 in. wide by min No. 32 gauge (0.012 in.) thick stainless steel jacket wrapped around the outer layer of the mat. Adjacent lengths of steel jacket to overlap the preceding length a min of 5 in. All horizontal. Steel jacket secured in place with steel banding straps and clips (Item 2D) spaced max 8 in. OC and max 1 in. from all horizontal seams.

Flexible Wraps

Endothermic Mat

Structural Protection

XR



* Indicates such products shall bear the UL or cUL Certification Mark for jurisdictions employing the UL or cUL Certification (such as Canada), respectively.

Reprinted from the Online Certifications Directory with permission from UL©

3M Industrial Adhesive and Tapes
Fire Protection Products
3M Center, Building 230-B-S-37
St. Paul, MN 55144-1000

System No. XR202

October 15, 2014

Ratings — 1/2, 3/4, 1, 1-1/2, 2, 3 and 4 Hr.

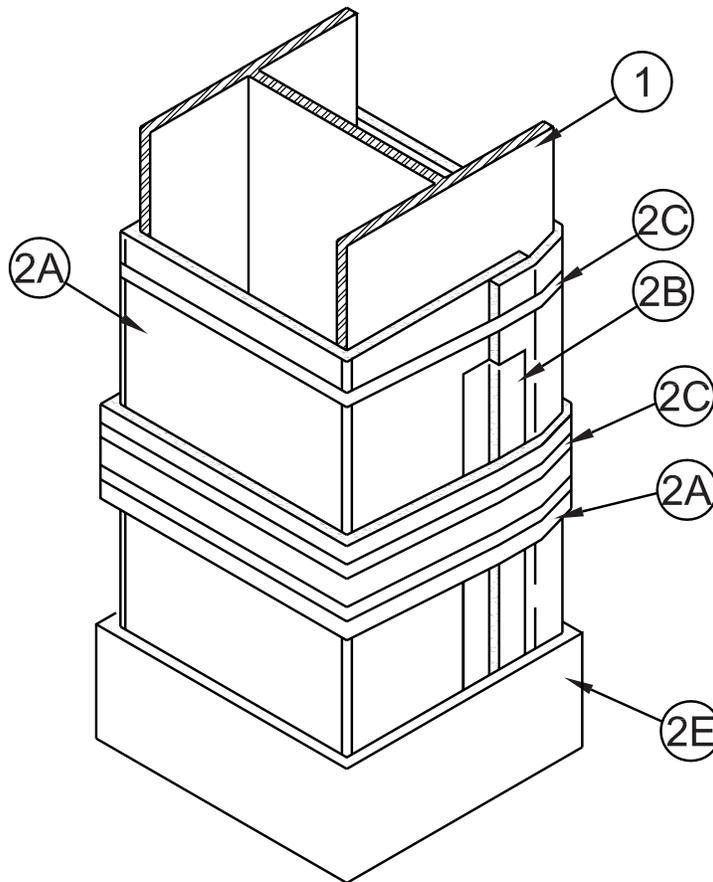

1. **Steel Column** — Min size of column W10x49.
2. **Mat Materials*** — The column protection assembly consists of endothermic mat, aluminum foil tape, and aluminum cladding. The details of the column assembly are summarized below:
 - A. **Mat Materials* — Endothermic Mat** — Flexible mat supplied in rolls. Each layer of foil-faced mat installed by cutting to size and tightly wrapping around the column and itself such that a min 2 in. overlap is present along the vertical seam. Seams to be located on the column flange. Sections are temporarily held in place with several strips of 3M Type 898 filament tape (approx. 24 in. long). Adjacent sections of material on the same layer abut one another forming the circumferential edge seam. Successive layers of mat installed in same manner with butted end seams offset a min 2 in. from butted end seams of preceding layer. For single layer construction only, a 4 in. wide endothermic mat collar is wrapped around each taped circumferential butt joint with a 2 in. overlap on itself. Circumferential edges of collar are sealed with foil tape. Stainless steel bands are applied as described under Item 2C. All seams in each layer of mat to be sealed with foil tape (Item 2B) prior to installation of subsequent layer of mat or collars. The hourly rating of the column assembly is dependent upon the number of endothermic mat layers as shown in the following table:

| Min Layers of Endothermic Mat Material | Hr Fire Rating |
|--|----------------|
| 1 | 1/2 |
| 1 | 3/4 |
| 2 | 1 |
| 2 | 1-1/2 |
| 3 | 2 |
| 3 | 3 |
| 4 | 4 |

3M COMPANY — Type E-5A-3, E-5A-4, E-53A, E-53C, E-54A or E-54C.

3M COMPANY 3M FIRE PROTECTION PRODUCTS — Interam™ Types E-54A, E-5A-4 or E-54C. Additionally evaluated for acid and solvent spray exposure.

- B. **Aluminum Foil Tape*** — (Shown at vertical seam but not shown at butt joints, collars or cladding for clarity) Nom 4 in. wide pressure-sensitive aluminum foil tape supplied in rolls. Used to secure the vertical overlap and circumferential butt joint seams of the endothermic mat (Item 2A) and joints in the aluminum cladding (Item 2E).

3M COMPANY 3M FIRE PROTECTION PRODUCTS — Type 425.

Design No. XR202 *continued*

- C. **Steel Banding Straps** — Min 1/2 in. wide by 0.020 in. thick stainless steel banding straps used in conjunction with No. 26 gauge galv steel wing-type crimp clips. Steel banding straps installed at the center and 2 in. from end of mat sections. Steel banding straps applied approx. 1 in. from edges of collars. Steel banding straps installed at the center and 1 in. from top and 1-1/2 in. from bottom of cladding sections.
- D. **Fill, Void or Cavity Material — Caulk*** — (Not Shown) Thick bead of caulk to be applied as a gasket between the endothermic mat (Item 2A) and the floor or ceiling surface. The bead of caulk applied around entire perimeter of endothermic mat at interface of floor or ceiling surface prior to and after each layer of mat material and after installation of the cladding.
3M COMPANY 3M FIRE PROTECTION PRODUCTS — Type CP 25WB+, or FB 3000 WT.
- E. **Aluminum Cladding Jacket** — Optional. After installation of the mats, collars, foil tape and steel banding straps, aluminum corner cladding pieces with nominal 12 in. wide legs, 36 in. long and min No. 27 gauge (0.014 in.) thick installed and overlapped on each other to cover column and form outer jacket. Adjacent lengths of cladding to overlap the preceding length a min of 2 in. Cladding jacket secured in place with steel banding straps as noted under Item 2C. All seams of cladding material to be sealed with foil tape after banding has been installed.
- F. **Stainless Steel Cladding Jacket** — Optional. (Alternate to Aluminum Cladding Jacket, Item E) - After installation of the mats, nominal 36 in. wide by minimum 0.009 in. thick stainless steel jacket wrapped around endothermic mat and lapping itself approximately 6 in. Adjoining lengths of stainless steel jacket to overlap a minimum of 4 in. Stainless steel jacket secured in place with steel banding straps (item 2C) spaced max. 12 in. OC and max. 1 in. from all seams.
- G. **Insulation Jacketing Tape*** — Optional. (Alternate to Aluminum Cladding Jacket, Item E) - After installation of the mats, nominal 23 in. wide by minimum 0.007 in. thick multilayered laminate coated with an aggressive cold weather acrylic pressure sensitive adhesive wrapped around endothermic mat and lapping itself approximately 3 in. Adjoining lengths of insulation jacketing tape to overlap approximately 3 in. Insulation jacketing tape secured in place by self-adhesive bond to the endothermic mat. See Tape, General Use (BVYS).

3M COMPANY 3M FIRE PROTECTION PRODUCTS — VentureClad(R) 1577CW, 1577CW-E, or 1579CW

* Indicates such products shall bear the UL or cUL Certification Mark for jurisdictions employing the UL or cUL Certification (such as Canada), respectively.

Reprinted from the Online Certifications Directory with permission from UL
© 2014 UL LLC



Flexible Wraps

Endothermic Mat

Structural Protection

XR

System No. XR203

January 07, 2015

Ratings-1, 1-1/2, 2, 2-1/2, 3 and 4 Hr.

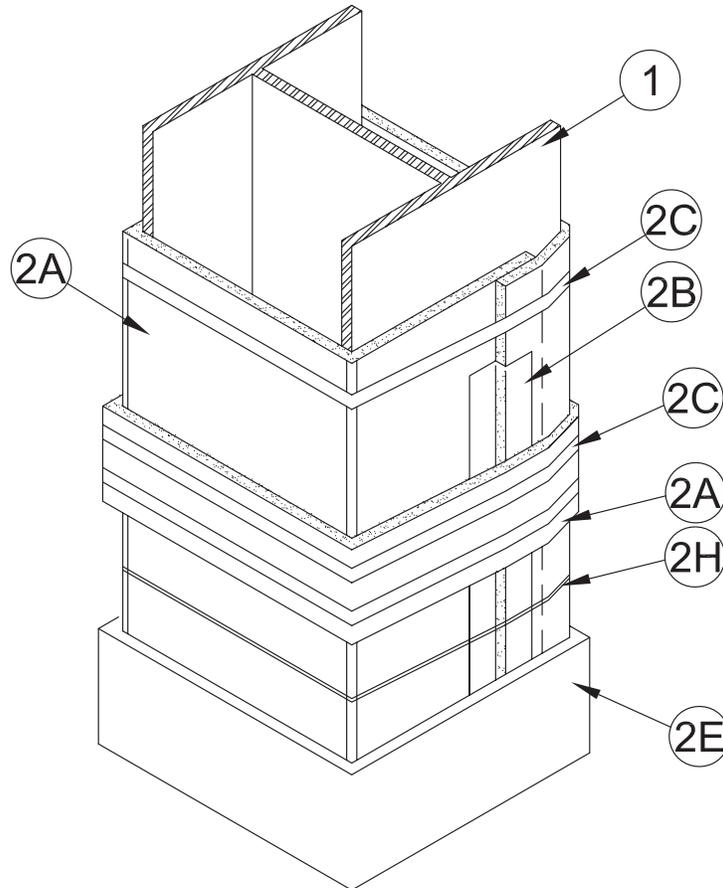

1. **Steel Column** — Min size of column W10x49.
2. **Mat Materials*** — The column protection assembly consists of endothermic mat, aluminum foil tape, steel bands, wire ties, and optional metal cladding material. The details of the column assembly are summarized below:
 - A. **Mat Materials*** — **Endothermic Mat** — Flexible mat supplied in rolls. Each layer of foil-faced mat installed by cutting to size and tightly wrapping around the column and itself such that a min 2 in. overlap present along the vertical seam. Seams located on the column flange. Sections are temporarily held in place with several strips of 3M Type 898 filament tape (approx. 24 in. long). Adjacent sections of material on the same layer abut one another forming the circumferential butt joint. Successive layers of mat installed in same manner with circumferential butt joints offset a min 2 in. from butted end seams of preceding layer. Circumferential edges of collar are sealed with aluminum foil tape (Item 2B). Stainless steel bands and wire ties are applied as described under Items 2C and 2H, respectively. All seams in each layer of mat to be sealed with aluminum foil tape (Item 2B) prior to installation of subsequent layer of mat or collars. The hourly rating of the column assembly is dependent upon the number of endothermic mat layers as shown in the following table:

| Min Layers of Endothermic Mat Material | Hr Fire Rating |
|--|----------------|
| 2 | 1 |
| 2 | 1-1/2 |
| 3 | 2 |
| 3 | 2-1/2 |
| 4 | 3 |
| 4 | 4 |

3M COMPANY 3M FIRE PROTECTION PRODUCTS — Type ES-5A-12. Additionally evaluated for solvent spray exposure.

- B. **Aluminum Foil Tape*** — (Shown at vertical seam but not shown at butt joints, collars or cladding for clarity) Nom 4 in. wide pressure-sensitive aluminum foil tape supplied in rolls. Used to secure the vertical overlap and circumferential butt joint seams of the endothermic mat (Item 2A) and joints in the aluminum cladding (Item 2E).

3M COMPANY 3M FIRE PROTECTION PRODUCTS — Type 425.

- C. **Steel Banding Straps** — Min 1/2 in. wide by 0.020 in. thick stainless steel banding straps used in conjunction with No. 26 gauge galv steel wing-type crimp clips. Steel banding straps installed at the center and 2 in. from end of mat sections. Steel banding straps applied approx. 1 in. from edges of collars. Steel banding straps installed at the center and 1 in. from top and 1-1/2 in. from bottom of cladding sections.

Design No. XR202 *continued*

- D. **Fill, Void or Cavity Material — Caulk*** — (Not Shown) Thick bead of caulk to be applied as a gasket between the endothermic mat (Item 2A) and the floor or ceiling surface. The bead of caulk applied around entire perimeter of endothermic mat at interface of floor or ceiling surface prior to and after each layer of mat material and after installation of the cladding.

3M COMPANY 3M FIRE PROTECTION PRODUCTS — Type CP 25WB+, or FB 3000 WT.

- E. **Aluminum Cladding Jacket** — Optional. After installation of the mats, collars, foil tape and steel banding straps, aluminum corner cladding pieces with nominal 12 in. wide legs, 36 in. long and min No. 27 gauge (0.014 in.) thick installed and overlapped on each other to cover column and form outer jacket. Adjacent lengths of cladding to overlap the preceding length a min of 2 in. Cladding jacket secured in place with steel banding straps as noted under Item 4. All seams of cladding material to be sealed with foil tape after banding has been installed.
- F. **Stainless Steel Cladding Jacket** — Optional. (Alternate to Aluminum Cladding Jacket, Item 2E) - After installation of the mats, nominal 36 in. wide by minimum 0.009 in. thick stainless steel jacket wrapped around endothermic mat and lapping itself approximately 6 in. Adjoining lengths of stainless steel jacket to overlap a minimum of 4 in. Stainless steel jacket secured in place with steel banding straps (item 2C) spaced max. 12 in. OC and max. 1 in. from all seams.
- G. **Insulation Jacketing Tape*** — Optional. (Alternate to Aluminum Cladding Jacket, Item 2E) - After installation of the mats, nominal 23 in. wide by minimum 0.007 in. thick multilayered laminate coated with an aggressive cold weather acrylic pressure sensitive adhesive wrapped around endothermic mat and lapping itself approximately 3 in. Adjoining lengths of insulation jacketing tape to overlap approximately 3 in. Insulation jacketing tape secured in place by self-adhesive bond to the endothermic mat. See Tape, General Use (BVYS).

3M COMPANY 3M FIRE PROTECTION PRODUCTS — VentureClad(R) 1577CW, 1577CW-E, or 1579CW

- H. **Wire Ties** — Steel, No. 18 gauge (0.046 in. thick). Wire ties installed approximately every 12 in. with one tie installed approx. 1 in. away from the circumferential butt joints and one installed approximately mid-height of each section of mat material. All layers except the outermost layer receives wire ties.

* Indicates such products shall bear the UL or cUL Certification Mark for jurisdictions employing the UL or cUL Certification (such as Canada), respectively.

Reprinted from the Online Certifications Directory with permission from UL

© 2015 UL LLC



Flexible Wraps

Endothermic Mat

Structural Protection

XR

Design Number 3MU/AF 240-01

August 30, 2012

APPLIED FIREPROOFING

3M Company

3M™ Interam™ E-5, E-54-A and E-5A-4 Series Endothermic Mat

3M Fire Barrier CP 25WB+ Caulk

ASTM E 1529 (Hydrocarbon Exposure)

ASTM E 119 (2012)

Restrained or Unrestrained Beam Rating: 4 Hours

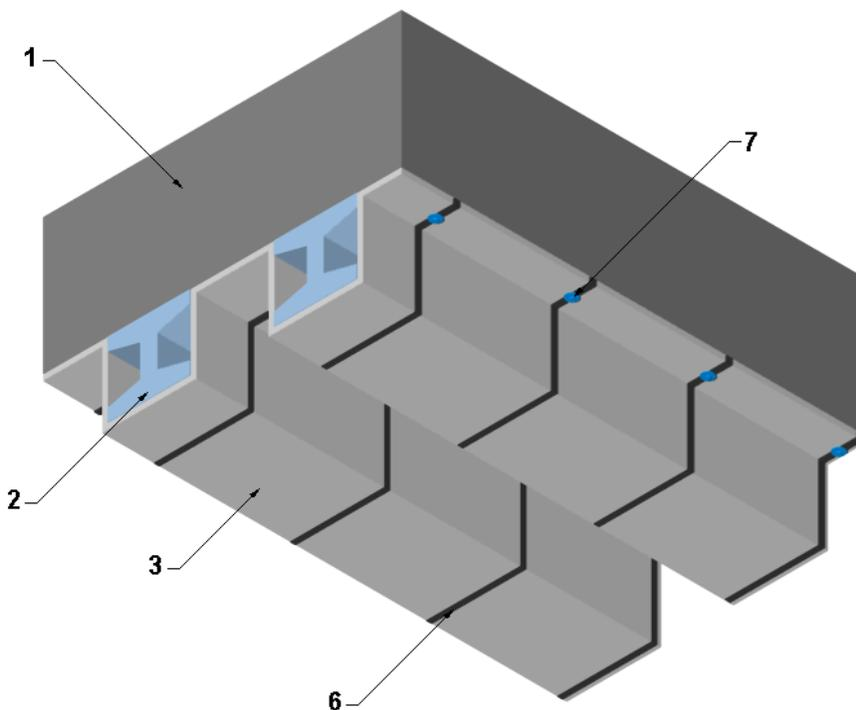

1. CONCRETE FLOOR: Use normal or lightweight concrete floor with minimum compressive strength of 109 pcf having a minimum depth of 12 in.
2. STEEL BEAM: Use minimum W8x48 W-Shaped steel beam.
3. CERTIFIED MANUFACTURER: 3M Company
CERTIFIED PRODUCT: Applied Fireproofing
MODEL: 3M™ Interam™ E-5, E-54-A and E-5A-4 Series Endothermic Mat
ENDOTHERMIC MAT: Install 1 layer of foil faced flexible mat around steel beam (Item 2). Cut length of endothermic mat to ensure minimum 4 in. overlap onto concrete floor (Item 1) adjacent to steel beam (Item 2). Tightly butt joints of endothermic mat and seal joints with foil tape (Item 5).
4. CERTIFIED MANUFACTURER: 3M Company
CERTIFIED PRODUCT: Caulk or Sealant
MODEL: 3M Fire Barrier CP 25WB+ Caulk
CAULK (Not shown): Fill any gaps between concrete floor and endothermic mat (Item 3) with caulk.
5. TAPE: (Not Shown) Apply 4 in. wide pressure sensitive tape with aluminum foil facing to all butt joints of the endothermic mat (Item 3).
6. STEEL BANDING: Install 1/2 in. wide x 0.020 in. thick stainless steel banding around endothermic mat (Item 3) and secure into concrete using fasteners (Item 7). Space banding max. 12 in. oc.
7. FASTENER: Secure endothermic mat (Item 3) and steel banding (Item 6) to concrete floor (Item 1) using min. 1/4 in. concrete anchors inserted through 1 in. diameter fender washer.

This material was extracted and drawn by 3M Fire Protection Products from the 2012 Product Directory, © Intertek

Flexible Wraps

Endothermic Mat

Applied Fireproofing

AF

Design Number 3MU/AF 50-01

September 07, 2012

APPLIED FIREPROOFING

3M Company

3M™ Interam™ E-5, E-54-A and E-5A-4 Series Endothermic Mat

NFPA 58 Appendix H

NFPA 290

Rating: Pass

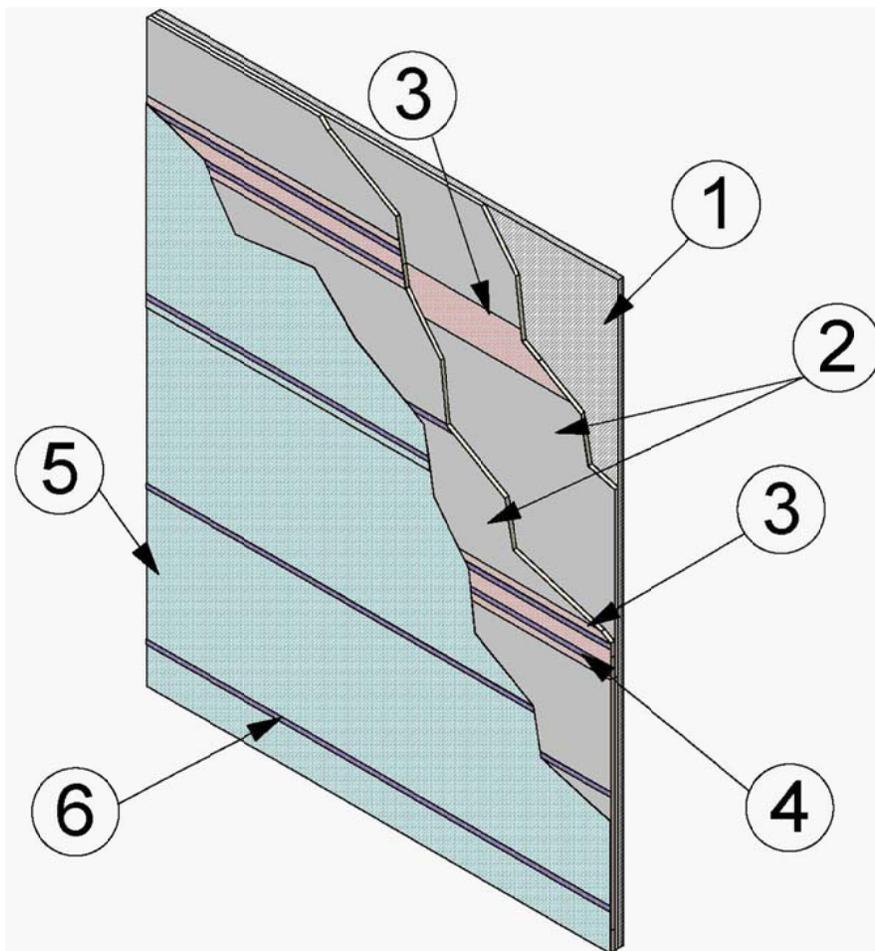

1. VESSEL: Use a code approved container for storage of liquid propane gas (LPG).
2. CERTIFIED MANUFACTURER: 3M Company
CERTIFIED PRODUCT: Applied Fireproofing
MODEL: 3M™ Interam™ E-5, E-54-A and E-5A-4 Series Endothermic Mat
ENDOTHERMIC MAT: Install 2 layers of foil faced flexible mat tightly around the vessel (Item 1). Install first layer with circumferential and longitudinal butt joint fit tightly together. Tape all joints of first layer with Aluminum Tape (Item 3). Install second layer with circumferential and longitudinal butt joint fit tightly together. Install second layer with joints offset minimum 2 in. from joints of first layer. Tape all joints of second layer with Aluminum Tape (Item 3).
Note: If required filament tape may be used to hold the endothermic mat in place. Filament tape should be spaced minimum 6 in. on center (oc)
3. ALUMINUM TAPE: (Not Shown) Apply 4 in. wide pressure sensitive tape with aluminum foil facing to all joints of the inner and outer layer of the Endothermic Mat (Item 2).
4. STEEL BANDING: Install 1/2 in. wide x 0.020 in. thick stainless steel banding around the outer layer of the endothermic mat (Item 2). Install banding within 1 in. of the edges of each piece of endothermic mat (Item 2) circumferential butt joints and maximum 12 in. oc along the width of the endothermic mat (Item 2) with a minimum of three bands (total) per mat installed.
5. STEEL SHEATHING: Install 1 layer of 0.016 in. thick T-304 stainless steel sheathing over the endothermic mat (Item 2). Install steel sheathing with minimum 2 in. overlap at circumferential joints to create a stepped surface installation. One continuous piece of steel sheathing shall wrap around the container (item 1) and the endothermic mat (Item 2) with a minimum 2 in. overlap at the longitudinal joint.
6. STEEL BANDING: Install 1/2 in. wide x 0.020 in. thick stainless steel banding around the steel sheathing (Item 5). Install banding within centered over the overlap of each joint in the steel sheathing (Item 5) and maximum 12 in. oc along the width of the steel sheathing (Item 2) with a minimum of three bands per sheet installed.

This material was extracted and drawn by 3M Fire Protection Products from the 2013 Product Directory, © Intertek



Design Number 3MU/AF 120-02

January 3, 2017
3M Company
Applied Fireproofing
Jet Fire Plate

3M™ Interam™ E-5 and E-5A-4 Series Endothermic Mat – 2 Layers
ISO 22899-1:2007(E), Determination of the Resistance to
Jet Fires of Passive Fire Protection Materials
Temperature Rise 11°C – Time 15 minutes
Temperature Rise 62°C – Time 30 minutes
Temperature Rise 105°C – Time 45 minutes
Temperature Rise 167°C – Time 60 minutes
Temperature Rise 306°C – Time 90 minutes
Temperature Rise 423°C – Time 120 minutes

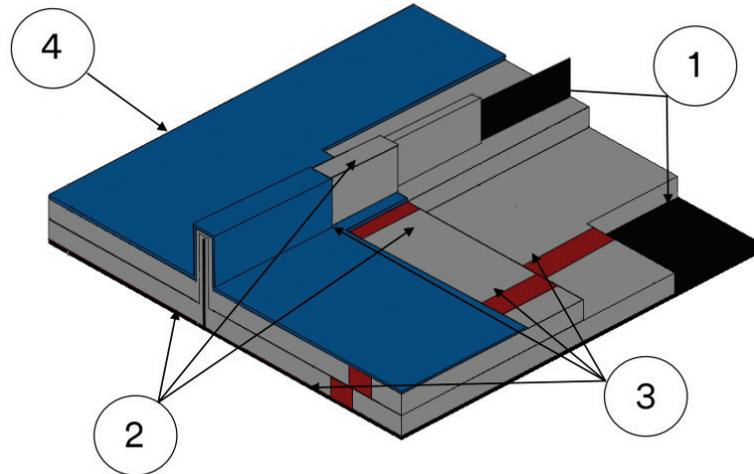

- 1. STRUCTURAL STEELWORK:** Use structural steel having a min. thickness of 20 mm +/- 0.25 mm (0.79 +/- 0.01 in.).

STEEL PANEL: A steel panel constructed of 10 mm (0.39) thick steel complying with ISO 630:1995, Grade Fe 430 representing steelwork with no corners or edge features.

- 2. CERTIFIED MANUFACTURER:** 3M Company

CERTIFIED PRODUCT: Applied Fireproofing

MODEL: 3M™ Interam™ E-5 and E-5A-4 Series Endothermic Mat

ENDOTHERMIC MAT: Install two layers of foil-faced flexible mat tightly over the steel panel (Item 1). Install first layer with continuous vertical sections of Endothermic Mat with vertical joints fit tightly together and foil facing away from the steel panel. Adhere first layer to the steel panel (Item 1) using 3M Hi-Strength 90 Adhesive applied to the steel and the back of the first layer being applied. Use rollers over the entire layer to ensure complete adhesion is achieved. Tape all joints of first layer with Aluminum Tape (Item 6) and use rollers over tape to ensure complete adhesion. Install the additional layer with joints offset min. 51mm (2 in.) from joints of the previous layer. Adhere the additional layer to the previous layer of Endothermic Mat using 3M Hi-Strength 90 Adhesive applied to the face of the previous layer. Use rollers over the entire layer to ensure complete adhesion is achieved. Tape all joints of the additional layer with Aluminum Tape (Item 6).

- 3. ALUMINUM TAPE:** Apply 102 mm (4 in.) wide pressure sensitive tape with aluminum foil-facing to all joints of each layer of the Endothermic Mat (Item 2).
- 4. STEEL SHEATHING:** Install one layer of 26 A T-304 stainless steel sheathing over the Endothermic Mat (Item 2) in continuous vertical sheets. Install steel sheathing with min. 76 mm (3 in.) overlap at joints to create a stepped surface installation. Adhere each piece of Steel Sheathing to the final layer of Endothermic Mat (Item 2) using 3M Hi-Strength 90 Adhesive applied to the edges of the back of the Steel Sheathing face of the corresponding locations on the final layer of Endothermic Mat (Item 2).
- 5. PINS (Not Shown):** Install nominal 35 mm (1-3/8 in.) long, 12 GA (2.7 mm (0.106 in.) thick) stainless steel cup-head pins with a min. 38 mm (1-1/2 in.) washer. Install pins by pre-drilling holes through the Steel Sheathing (Item 4) and the Endothermic Mat (Item 2) with an 11 mm (7/16 in.) drill bit and welding the pins to the Structural Steelwork (Item 1). Pins shall be spaced both vertically and horizontally 305 mm (12 in.) on center and centered over the overlap of each joint in the Steel Sheathing (Item 7).

This material was extracted and drawn by 3M Fire Protection Products from the 2018 Product Directory, © Intertek





Design Number 3MU/AF 120-04

March 6, 2018
3M Company
Applied Fireproofing
Jet Fire

3M™ Interam™ ES-5A-12 Series Endothermic Mat – 2 Layers
ISO 22899-1

Temperature Rise 13°C – Time 15 minutes
Temperature Rise 48°C – Time 30 minutes
Temperature Rise 80°C – Time 45 minutes
Temperature Rise 116°C – Time 60 minutes
Temperature Rise 239°C – Time 90 minutes
Temperature Rise 363°C – Time 120 minutes
Temperature Rise 400°C – Time 132 minutes

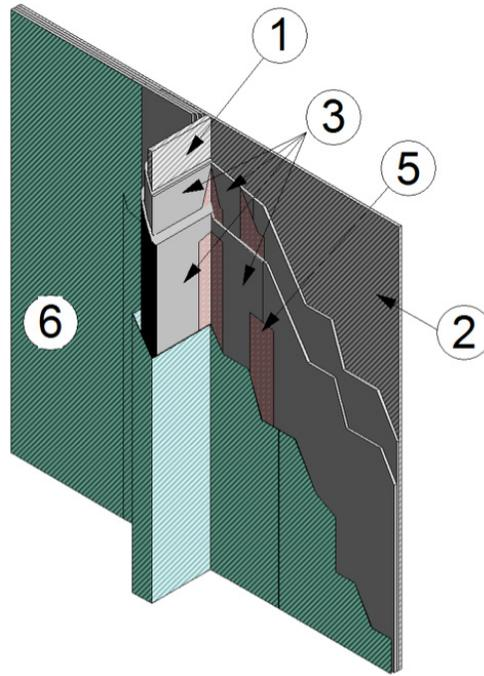

Figure 1. Structural Steel Work Protection

- 1. STRUCTURAL STEELWORK:** Use structural steel having a min. thickness of 20 +/- 0.25mm (0.79 +/- 0.01 in.).
- 2. STEEL PANEL:** Use a steel panel constructed of 10mm (0.39 in.) thick steel, complying with ISO 630:1995, Grade Fe 430 representing steelwork with no corners or edge features.
- 3. CERTIFIED MANUFACTURER:** 3M Company
CERTIFIED PRODUCT: Applied Fireproofing
CERTIFIED MODEL: 3M™ Interam™ ES-5A-12 Series Endothermic Mat
ENDOTHERMIC MAT: Install two layers of foil-faced flexible Endothermic Mat, tightly over the Structural Steelwork (Item 1) and Steel Plate (Item 2). Each layer shall have one single piece of Endothermic Mat over the Structural Steelwork (Item 1) with the foil facing away from the Structural Steelwork. Install first layer with continuous vertical sections of Endothermic Mat with vertical joints fit tightly together and foil facing away from the steel panel. Adhere the first layer to the steel panel (Item 2) using 3M Hi-Strength 90 Adhesive (not shown) applied to the steel and the back of the first layer being applied. Use rollers over the entire layer to ensure complete adhesion is achieved. Tape all joints of first layer with Aluminum Tape (Item 5) and use rollers over tape to ensure complete adhesion. Install the second layer with joints offset min. 51mm (2 in.) from joints of the previous layer. Adhere the second layer of Endothermic Mat to the first layer of Endothermic Mat using 3M Hi-Strength 90 Adhesive (not shown) applied to the face of the first layer. Use rollers over the entire layer to ensure complete adhesion is achieved. Tape all joints of the second layer with Aluminum Tape (Item 5), with min. 50mm (2 in.) overlap onto itself, with the foil facing away from the cable tray. Temporarily affix sections of Endothermic Mat with filament tape if needed. Install each additional layer in the same manner ensuring the seams between layers are offset a min. of 50mm (2 in.).
- 4. CERTIFIED MANUFACTURER:** 3M Company
CERTIFIED PRODUCT: Caulk
CERTIFIED MODEL: 3M™ Fire Barrier CP 25WB+
CAULK (Not Shown): Install caulk in any joints between Endothermic Mat (Item 3) or between the Endothermic Mat (Item 3) and any steel member (Item 1 and/or 2) that exceed 3mm (1/8 in.).

Design Number 3MU/AF 120-04

5. **ALUMINUM TAPE:** Apply 102mm (4 in.) wide pressure sensitive tape with aluminum foil-facing to all joints of each layer of the Endothermic Mat (Item 3).
6. **STEEL SHEATHING:** Install one layer of min. 0.48mm (26 GA, 0.0156 in.) T-304 stainless steel sheathing over the Endothermic Mat (Item 3) in continuous vertical sheets. Install Steel Sheathing with min. 76mm (3 in.) overlap at joints to create a stepped surface installation. Adhere each piece of Steel Sheathing to the final layer of Endothermic Mat (Item 3) using 3M Hi-Strength 90 Adhesive (not shown) applied to the edges of the back of the Steel Sheathing face of the corresponding locations on the final layer of Endothermic Mat (Item 3).
7. **PINS (Not Shown):** Install nominal 35mm (1 3/8 in.) long, 12 GA (2.70mm (0.106 in.) thick) stainless steel cup-head pins with a min. 38mm (1-1/2 in.) washer. Install pins by pre-drilling holes through the Steel Sheathing (Item 6) and the Endothermic Mat (Item 3) with an 11mm (7/16 in.) drill bit, and welding the pins to the Structural Steelwork (Item 1). Pins shall be spaced both vertically and horizontally 305mm (12 in.) on center and centered over the overlap of each joint in the Steel Sheathing (Item 6).

Applied Fireproofing

Endothermic Mat

Flexible Wraps

AF

This material was extracted and drawn by 3M Fire Protection Products from the 2018 Product Directory, © Intertek





Design Number 3MU/AF 180-04

January 3, 2017
3M Company
Applied Fireproofing
Jet Fire Plate

3M™ Interam™ E-5 and E-5A-4 Series Endothermic Mat – 2 Layers
ISO 22899-1:2007(E), Determination of the Resistance to
Jet Fires of Passive Fire Protection Materials
Temperature Rise 26°C – Time 15 minutes
Temperature Rise 66°C – Time 30 minutes
Temperature Rise 98°C – Time 45 minutes
Temperature Rise 121°C – Time 60 minutes
Temperature Rise 163°C – Time 90 minutes
Temperature Rise 215°C – Time 120 minutes
Temperature Rise 235°C – Time 150 minutes
Temperature Rise 236°C – Time 180 minutes

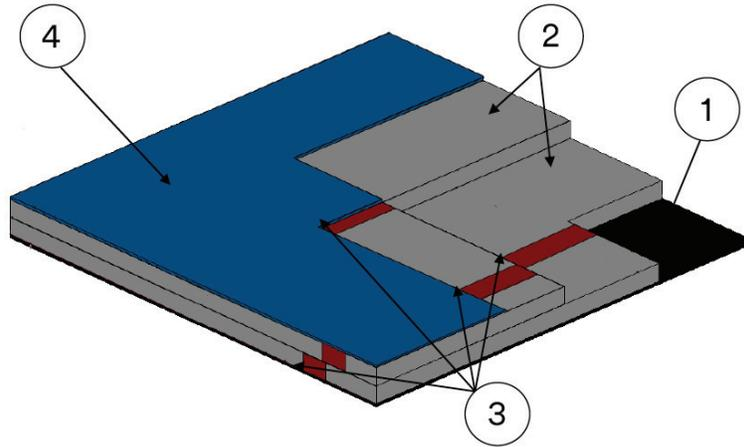

1. STEEL PANEL: A steel panel constructed of 10 mm (0.39 in.) thick steel complying with ISO 630:1995, Grade Fe 430 representing steelwork with no corners or edge features or cylindrical vessels, pipes and tubular sections of outside diameter greater than 500 mm (19.7 in.).

2. CERTIFIED MANUFACTURER: 3M Company

CERTIFIED PRODUCT: Applied Fireproofing

MODEL: 3M™ Interam™ E-5 and E-5A-4 Series Endothermic Mat

ENDOTHERMIC MAT: Install two layers of foil-faced flexible mat tightly over the steel panel (Item 1). Install first layer with continuous vertical sections of Endothermic Mat with vertical joints fit tightly together and foil facing away from the steel panel.

Adhere first layer to the steel panel (Item 1) using 3M Hi-Strength 90 Adhesive applied to the steel and the back of the first layer being applied. Use rollers over the entire layer to ensure complete adhesion is achieved. Tape all joints of first layer with Aluminum Tape (Item 3) and use rollers over tape to ensure complete adhesion. Install the additional layer with joints offset min. 51 mm (2 in.) from joints of the previous layer. Adhere the additional layer to the previous layer of Endothermic Mat using 3M Hi- Strength 90 Adhesive. Use rollers over the entire layer to ensure complete adhesion is achieved. Tape all joints of each additional layer with Aluminum Tape (Item 3).

3. ALUMINUM TAPE: Apply 102 mm (4 in.) wide pressure sensitive tape with aluminum foil-facing to all joints of each layer of the Endothermic Mat (Item 2).

4. STEEL SHEATHING: Install one layer of 26 GA (0.455 mm (0.0179 in.) thick) T-304 stainless steel sheathing over the Endothermic Mat (Item 2) in continuous vertical sheets. Install steel sheathing with min. 76mm (3 in.) overlap at joints to create a stepped surface installation. Adhere each piece of Steel Sheathing to the final layer of Endothermic Mat (Item 2) using 3M Hi- Strength 90 Adhesive applied to the edges of the back of the Steel Sheathing face of the corresponding locations on the final layer of Endothermic Mat (Item 2).

5. PINS (Not Shown): Install nominal 35 mm (1-3/8 in.) long, 12 GA (2.70 mm (0.106 in.) thick) stainless steel cup-head pins with a min. 38 mm (1-1/2 in.) washer. Install pins by pre-drilling holes through the Steel Sheathing (Item 4) and the Endothermic Mat (Item 2) with an 11 mm (7/16 in.) drill bit and welding the pins to the Steel Panel (Item 1). Pins shall be spaced both vertically and horizontally 305 mm (12 in.) on center.

This material was extracted and drawn by 3M Fire Protection Products from the 2018 Product Directory, © Intertek



Design Number 3MU/AF 240-03

May 02, 2013

APPLIED FIREPROOFING

Jet Fire Plate

3M Company

3M™ Interam™ E-5 and E-5A-4 Series Endothermic Mat

ISO 22899-1:2007(E), Determination of the Resistance to

Jet Fires of Passive Fire Protection Materials

Temperature Rise 13°C – Time 15 minutes

Temperature Rise 35°C – Time 30 minutes

Temperature Rise 99°C – Time 60 minutes

Temperature Rise 208°C – Time 120 minutes

Temperature Rise 242°C – Time 180 minutes

Temperature Rise 251°C – Time 240 minutes

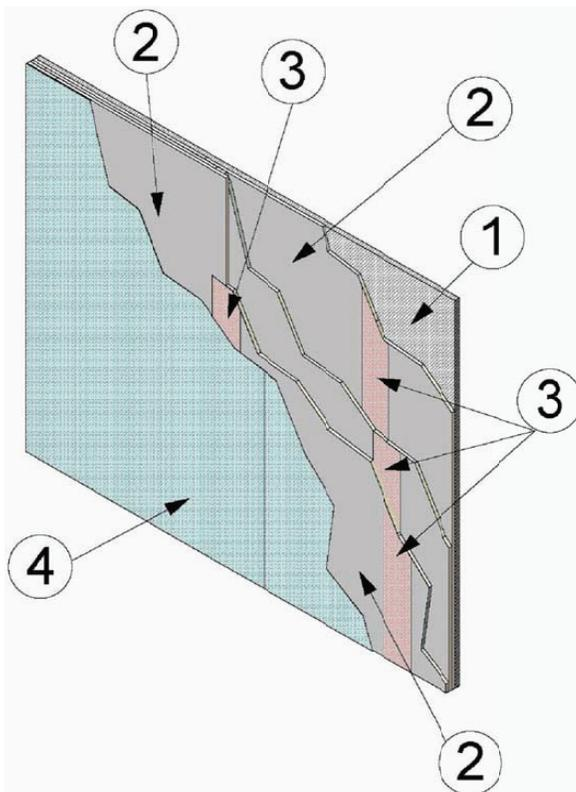

1. **STEEL PANEL:** A steel panel constructed of 10mm (0.39 in.) thick steel complying with ISO 630:1995, Grade Fe 430 representing steelwork with no corners or edge features or cylindrical vessels, pipes and tubular sections of outside diameter greater than 500mm (19.7 in.).
2. **CERTIFIED MANUFACTURER:** 3M Company
CERTIFIED PRODUCT: Applied Fireproofing
MODEL: 3M™ Interam™ E-5 and E-5A-4 Series Endothermic Mat
- ENDOTHERMIC MAT:** Install 3 layers of foil faced flexible mat tightly over the steel panel (Item 1). Install first layer with continuous vertical sections of Endothermic Mat with vertical joints fit tightly together and foil facing away from the steel panel. Adhere first layer to the steel panel (Item 1) using 3M Hi-Strength 90 Adhesive applied to the steel and the back of the first layer being applied. Use rollers over the entire layer to ensure complete adhesion is achieved. Tape all joints of first layer with Aluminum Tape (Item 3) and use rollers over tape to ensure complete adhesion. Install each additional layer with continuous vertical sections of Endothermic Mat with vertical joints fit tightly together and foil facing away from the previous layer. Install each additional layer with joints offset minimum 51mm (2 in.) from joints of the previous layer. Adhere each additional layer to the previous layer of Endothermic Mat using 3M Hi-Strength 90 Adhesive applied to the face of the previous layer and to the back of the current layer being applied. Use rollers over the entire layer to ensure complete adhesion is achieved. Tape all joints of each additional layer with Aluminum Tape (Item 3).
3. **ALUMINUM TAPE:** Apply 102mm (4 in.) wide pressure sensitive tape with aluminum foil facing to all joints of each layer of the Endothermic Mat (Item 2).
4. **STEEL SHEATHING:** Install 1 layer of 26GA (0.455mm (0.0179 in.) thick) T-304 stainless steel sheeting over the Endothermic Mat (Item 2) in continuous vertical sheets. Install steel sheathing with minimum 76mm (3 in.) overlap at joints to create a stepped surface installation. Adhere each piece of Steel Sheathing to the final layer of Endothermic Mat (Item 2) using 3M Hi-Strength 90 Adhesive applied to the edges of the back of the Steel Sheathing face of the corresponding locations on the final layer of Endothermic Mat (Item 2).
5. **PINS (Not Shown):** Install nominal 35mm (1-3/8 in.) long, 12 GA (2.70mm (0.106 in.) thick) stainless steel cup head pins with a minimum 38mm (1-1/2 in.) washer. Install pins by pre-drilling holes through the Steel Sheathing (Item 4) and the Endothermic Mat (Item 2) with a 11mm (7/16 in.) drill bit and welding the pins to the Steel Panel (Item 1). Pins shall be spaced both vertically and horizontally 305mm (12 in.) on center.

This material was extracted and drawn by 3M Fire Protection Products from the 2013 Product Directory, © Intertek

Design Number 3MU/AF 240-04

May 02, 2013

APPLIED FIREPROOFING

Jet Fire

3M Company

3M™ Interam™ E-5 and E-5A-4 Series Endothermic Mat

ISO 22899-1:2007(E), Determination of the Resistance to

Jet Fires of Passive Fire Protection Materials

Temperature Rise 5°C – Time 15 minutes

Temperature Rise 26°C – Time 30 minutes

Temperature Rise 76°C – Time 60 minutes

Temperature Rise 182°C – Time 120 minutes

Temperature Rise 275°C – Time 180 minutes

Temperature Rise 356°C – Time 240 minutes

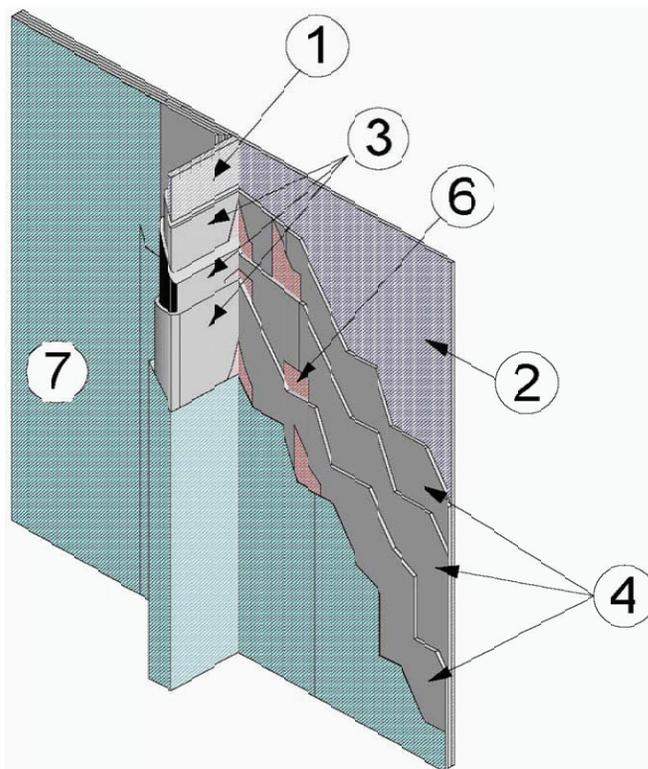

1. **STRUCTURAL STEELWORK:** Use structural steel having a minimum thickness of 20 +/- 0.25 mm (0.79 +/- 0.01 in.).
2. **STEEL PANEL:** A steel panel constructed of 10mm (0.39) thick steel complying with ISO 630:1995, Grade Fe 430 representing steelwork with no corners or edge features.
3. **CERTIFIED MANUFACTURER:** 3M Company
CERTIFIED PRODUCT: Applied Fireproofing
MODEL: 3M™ Interam™ E-5 and E-5A-4 Series Endothermic Mat
ENDOTHERMIC MAT: Install 3 layers of foil faced flexible mat tightly over the Structural Steelwork (Item 1) and Steel Panel (Item 2). Install first layer with continuous vertical sections of Endothermic Mat. Each layer shall have one single piece of Endothermic Mat over the Structural Steelwork (Item 2) with the foil facing away from the Structural Steelwork. Adhere first layer to the Structural Steelwork (Item 1) using 3M Hi-Strength 90 Adhesive applied to the steel and the back of the first layer being applied. Use rollers over the entire layer to ensure complete adhesion is achieved. Install each additional layer with a single piece of continuous vertical sections of Endothermic Mat and foil facing away from the previous layer. Adhere each additional layer to the previous layer of Endothermic Mat using 3M Hi-Strength 90 Adhesive applied to the face of the previous layer and to the back of the current layer being applied. Use rollers over the entire layer to ensure complete adhesion is achieved.
4. **CERTIFIED MANUFACTURER:** 3M Company
CERTIFIED PRODUCT: Applied Fireproofing
MODEL: 3M™ Interam™ E-5 and E-5A-4 Series Endothermic Mat
ENDOTHERMIC MAT: Install 3 layers of foil faced flexible mat tightly over the steel panel (Item 1). Install first layer with continuous vertical sections of Endothermic Mat with vertical joints fit tightly together and foil facing away from the steel panel. Adhere first layer to the steel panel (Item 1) using 3M Hi-Strength 90 Adhesive applied to the steel and the back of the first layer being applied. Use rollers over the entire layer to ensure complete adhesion is achieved. Tape all joints of first layer with Aluminum Tape (Item 6) and use rollers over tape to ensure complete adhesion. Install each additional layer with continuous vertical sections of Endothermic Mat with vertical joints fit tightly together and foil facing away from the previous layer. Install each additional layer with joints offset minimum 51mm (2 in.) from joints of the previous layer. Adhere each additional layer to the previous layer of Endothermic Mat using 3M Hi-Strength 90 Adhesive applied to the face of the previous layer and to the back of the current layer being applied. Use rollers over the entire layer to ensure complete adhesion is achieved. Tape all joints of each additional layer with Aluminum Tape (Item 6).

Flexible Wraps

Endothermic Mat

Applied Fireproofing

AF

System No. 3MU/AF 240-04 *continued*

Flexible Wraps

Endothermic Mat

Applied Fireproofing

AF

5. **CERTIFIED MANUFACTURER:** 3M Company
CERTIFIED PRODUCT: Caulk
MODEL: 3M™ Fire Barrier CP 25WB+
CAULK (Not Shown): Install caulk in any joints between Endothermic Mat or between the Endothermic Mat and any steel member that exceed 3mm (1/8 in).
6. **ALUMINUM TAPE:** Apply 102mm (4 in.) wide pressure sensitive tape with aluminum foil facing to all joints of each layer of the Endothermic Mat (Item 2).
7. **STEEL SHEATHING:** Install 1 layer of 28 GA (0.39mm (0.0156 in.) thick) T-304 stainless steel sheeting over the Endothermic Mat (Item 2) in continuous vertical sheets. Install steel sheathing with minimum 76mm (3 in.) overlap at joints to create a stepped surface installation. Adhere each piece of Steel Sheathing to the final layer of Endothermic Mat (Item 2) using 3M Hi-Strength 90 Adhesive applied to the edges of the back of the Steel Sheathing face of the corresponding locations on the final layer of Endothermic Mat (Item 2).
8. **PINS (Not Shown):** Install nominal 35mm (1-3/8 in.) long, 12 GA (2.70mm (0.106 in.) thick) stainless steel cup head pins with a minimum 38mm (1-1/2 in.) washer. Install pins by pre-drilling holes through the Steel Sheathing (Item 4) and the Endothermic Mat (Item 2) with a 11mm (7/16 in.) drill bit and welding the pins to the Structural Steelwork (Item 1). Pins shall be spaced both vertically and horizontally 305mm (12 in.) on center and centered over the overlap of each joint in the Steel Sheathing (Item 7).

This material was extracted and drawn by 3M Fire Protection Products from the 2013 Product Directory, © Intertek

Electrical Circuit Protection

| 3M Systems | "F" Rating | 3M Product | Application Details |
|--|------------|--|---|
| Cellulosic | | | |
| 3MU/AF 60-01 (Formerly ECP 523) | 1 | 3M™ Interam™ Endothermic Mat E-5A-4 3M™ Fire Barrier Sealant CP 25WB+ 3M™ Aluminum Foil Tape 425 | 1 hour circuit protection for a 24 inch wide by 4 in. deep steel ladder-back cable tray. Any cable fill is allowed within the tray. For ampacity derating, reference 3MU/AF 60-06 |
| 3MU/AF 60-02 (Formerly ECP 524) | 1 | 3M™ Interam™ Endothermic Mat E-5A-4 3M™ Fire Barrier Sealant CP 25WB+ 3M™ Aluminum Foil Tape 425 | 1 hour circuit protection for a 6 inch wide by 4 in. deep steel ladder-back cable tray. Any cable fill is allowed within the tray. |
| 3MU/AF 60-03 (Formerly ECP 525) | 1 | 3M™ Interam™ Endothermic Mat E-5A-4 3M™ Fire Barrier Sealant CP 25WB+ 3M™ Aluminum Foil Tape 425 | 1 hour circuit protection for a minimum 1 in. diameter EMT or RMC. For ampacity derating, see 3MU/AF 60-07. |
| 3MU/AF 60-04 (Formerly ECP 526) | 1 | 3M™ Interam™ Endothermic Mat E-5A-4 3M™ Fire Barrier Sealant CP 25WB+ 3M™ Aluminum Foil Tape 425 | 1 hour circuit protection for a cable or cable bundle of any size. |
| 3MU/AF 60-05 (Formerly ECP 527) | 1 | 3M™ Interam™ Endothermic Mat E-5A-4 3M™ Fire Barrier Sealant CP 25WB+ 3M™ Aluminum Foil Tape 425 | 1 hour circuit protection for a minimum 12 × 12 × 8 inch steel junction box or pull box. |
| 3MU/AF 60-06 | 1 | 3M™ Interam™ Endothermic Mat E-5 3M™ Interam™ Endothermic Mat E-5A-4 3M™ Fire Barrier Sealant CP 25WB+ | |
| 3MU/AF 60-07 | 1 | 3M™ Interam™ Endothermic Mat E-5 3M™ Interam™ Endothermic Mat E-5A-4 3M™ Fire Barrier Sealant CP 25WB+ | |
| 3MU/AF 120-01 | 2 | 3M™ Interam™ Endothermic Mat E-5A-4 3M™ Fire Barrier Sealant CP 25WB+ 3M™ Aluminum Foil Tape 425 | 2 hour circuit protection for a single minimum 1 inch diameter steel conduit with any amount of cable fill. |
| 3MU/AF 180-01 (Formerly ECP 528) | 3 | 3M™ Interam™ Endothermic Mat E-5A-4 3M™ Fire Barrier Sealant CP 25WB+ 3M™ Aluminum Foil Tape 425 | 3 hour circuit protection for a single minimum 1 inch diameter steel conduit with any amount of cable fill. |
| 3MU/AF 180-02 (Formerly ECP 529) | 3 | 3M™ Interam™ Endothermic Mat E-5A-4 3M™ Fire Barrier Sealant CP 25WB+ 3M™ Aluminum Foil Tape 425 | 3 hour circuit protection for a cable or cable bundle of any size. |
| 3MU/AF 180-03 (Formerly ECP 530) | 3 | 3M™ Interam™ Endothermic Mat E-5A-4 3M™ Fire Barrier Sealant CP 25WB+ 3M™ Aluminum Foil Tape 425 | 3 hour circuit protection for a minimum 12 × 12 × 8 inch steel junction box or pull box. |
| System No. 2 | 1 | 3M™ Interam™ Endothermic Mat E-5A-4 3M™ Fire Barrier Composite Sheet CS-195+ 3M™ Fire Barrier Sealant CP 25WB+ 3M™ Aluminum Foil Tape 425 | 24 in. wide, min 4 in. deep solid bottom/open ladder cable tray. Bare cable "air drops" extend from cable tray. Min no. 16 AWG jacketed multiconductor cables/min 250 MCM jacketed single conductor cables. Conduit supports. Openings: concrete, masonry wall or concrete floor. System composition: protective wrap, foil tape, hardware cloth, banding, composite sheet, sealant. 1 hour F rating. Also known as No 2. |
| System No. 3 | 1 | 3M™ Interam™ Endothermic Mat E-5A-4 3M™ Fire Barrier Composite Sheet CS-195+ 3M™ Fire Barrier Sealant CP 25WB+ 3M™ Aluminum Foil Tape 425 | Nominal 2 in. steel conduit or larger. Min no. 16 AWG jacketed multiconductor cables or min 250 MCM jacketed single conductor cables. Conduit supports. Opening in concrete or masonry wall or concrete floor. System consists of: protective intumescent wrap, foil tape, hardware cloth, stainless steel banding, composite sheet, and sealant. 1 hour F rating. Precursor to System 7. Also known as No 3. |
| System No. 4 | 1 | 3M™ Interam™ Endothermic Mat E-5A-4 3M™ Fire Barrier Composite Sheet CS-195+ 3M™ Fire Barrier Sealant CP 25WB+ 3M™ Aluminum Foil Tape 425 | Nominal 2 in. steel conduit or larger. Min no. 16 AWG jacketed multiconductor cables or min 250 MCM jacketed single conductor cables. Conduit supports. Opening in concrete or masonry wall or concrete floor. System consists of: protective intumescent wrap, foil tape, hardware cloth, stainless steel banding, composite sheet, and sealant. 1 hour F rating. Precursor to System 7. Also known as No. 4. |
| System No. 6 | 1 | 3M™ Interam™ Endothermic Mat E-5A-4 3M™ Fire Barrier Composite Sheet CS-195+ 3M™ Fire Barrier Sealant CP 25WB+ 3M™ Aluminum Foil Tape 425 | Min 12 in. x 12 in. x 6 in. deep junction box. Optional min 2 in. steel conduit. Min no. 16 AWG jacketed multiconductor cables/ min 250 MCM jacketed single conductor cables. Conduit supports. Opening in concrete or masonry wall or concrete floor. System of: protective wrap, foil tape, stainless steel banding, composite sheet, and sealant. 1 hour F rating. Precursor to System 9. Also known as No. 6. |

Electrical Circuit Protection

| 3M Systems | "F" Rating | 3M Product | Application Details |
|---|--------------------|--|--|
| System No. 7 | 1, 2, 3 | 3M™ Interam™ Endothermic Mat E-5A-4 3M™ Fire Barrier Composite Sheet CS-195+ 3M™ Fire Barrier Sealant CP 25WB+ 3M™ Aluminum Foil Tape 425 | Nominal 2 in. steel conduit or larger. Min no. 16AWG jacketed multiconductor cables or min 250 MCM jacketed single conductor cables. Conduit supports. Opening in concrete or masonry wall or concrete floor. System consists of: protective wrap, foil tape, stainless steel banding, CS-195+, and caulk. 1 and 3 hour F rating. |
| System No. 8 | 1, 2, 3 | 3M™ Interam™ Endothermic Mat E-5A-4 3M™ Fire Barrier Composite Sheet CS-195+ 3M™ Fire Barrier Sealant CP 25WB+ 3M™ Aluminum Foil Tape 425 | 24 in. wide, min 4 in. deep solid bottom or open ladder cable tray. Min no. 16 AWG jacketed multiconductor cables or min 250 MCM jacketed single conductor cables. Conduit supports. Strapping required around cable tray. Opening in concrete or masonry wall or concrete floor. System consists of: protective wrap, foil tape, stainless steel banding, CS-195+, and caulk. 1 and 3 hour F rating. |
| System No. 9 | 1, 2, 3 | 3M™ Interam™ Endothermic Mat E-5A-4 3M™ Fire Barrier Composite Sheet CS-195+ 3M™ Fire Barrier Sealant CP 25WB+ 3M™ Aluminum Foil Tape 425 | Min 12 in. x 12 in. x 6 in. deep junction box. Optional nom 2 in. steel conduit or larger. Min no. 16 AWG jacketed multiconductor cables or min 250 MCM jacketed single conductor cables. Conduit supports. Opening in concrete or masonry wall or concrete floor. System consists of: protective wrap, foil tape, stainless steel banding, CS-195+, and caulk. 1 and 3 hour F rating. |
| System No. 34 | 2 | 3M™ Interam™ Endothermic Mat E-5A-4 3M™ Fire Barrier Composite Sheet CS-195+ 3M™ Fire Barrier Sealant CP 25WB+ 3M™ Aluminum Foil Tape 425 | Through penetration & electrical circuit protection in one system. 2 hour concrete floor or wall. Nominal 4 in. to 6 in. rigid steel conduit with cables. Opening max 1-1/2 in. larger than OD of conduit. Point contact to max 3/4 in. annular. Eccentric/concentric installation. 4 layers of mat. Min 3/8 in. steel support hangers must be installed & not required to be wrapped. 2 hour. Also known as 34. |
| Ampacity Derating | | | |
| 3MU/AF 60-06 (Formerly ECP 531) | | 3M™ Interam™ Endothermic Mat E-5 3M™ Interam™ Endothermic Mat E-54-A 3M™ Interam™ Endothermic Mat E-5A-4 3M™ Fire Barrier Sealant CP 25WB+ | 1 hour circuit protection for a 24 inch wide by 4 in. deep steel ladder-back cable tray. Any cable fill is allowed within the tray |
| 3MU/AF 60-07 (Formerly ECP 532) | | 3M™ Interam™ Endothermic Mat E-5 3M™ Interam™ Endothermic Mat E-54-A 3M™ Interam™ Endothermic Mat E-5A-4 3M™ Fire Barrier Sealant CP 25WB+ | 1 hour circuit protection for a minimum 1 in. diameter EMT or RMC |
| Hydrocarbon | | | |
| TB-7 | 1 | 3M™ Interam™ Endothermic Mat E-5A-4 3M™ Fire Barrier Sealant CP 25WB+ 3M™ Aluminum Foil Tape 425 | Nominal 12 in. x 4 in. open ladder steel cable tray. Cables per NEC(NFPA 70). Four layers of Interam E5A-4 Mat required. Seams foil taped. Steel banding over final layer. 1 hour. Tested to ASTM E 1529-10 Rapid- Temp-Rise (Hydrocarbon Pool). |
| TB-10 | 1 | 3M™ Interam™ Endothermic Mat ES-5A-12 3M™ Fire Barrier Sealant CP 25WB+ 3M™ Fire Barrier Water Tight Sealant 3000 WT 3M™ Aluminum Foil Tape 425 | Nominal 12 in. x 4 in. open ladder steel cable tray. Cables per NEC (NFPA 70). Four layers of Interam ES-5A-12 Mat required. Seams foil taped. Steel banding over final layer. 1 hour. Tested to ASTM E 1529-10 Rapid- Temp-Rise (Hydrocarbon Pool). |
| Jet Fire | | | |
| 3MU/AF 120-03 | 15 Min, 120 Min | 3M™ Interam™ Endothermic Mat ES-5A-12 | Galvanized steel ladder-back cable tray with min. dimensions of 102mm (4 in.) high x 305mm wide (12 in.) Jet fire exposures from 15 minutes to 120 minutes. |
| 3MU/AF 120-05 | 10 Min, 167 Min | 3M™ Interam™ Endothermic Mat E-5A-4 3M™ Fire Barrier Sealant CP 25WB+ | Aluminum or other metallic cable tray with min. nominal dimensions of 44.5mm (1-3/4 in.) high x 152mm wide (6 in.), with ventilated or solid bottom. Jet fire exposures from 10 minutes to 167 minutes. |



Design Number 3MU/AF 60-01

(Formerly Design ECP 523)

30-Aug-12

APPLIED FIREPROOFING

3M Company

3M™ Interam™ E-5, E-54-A and E-5A-4 Series Endothermic Mat

3M™ Fire Barrier CP 25WB+ Caulk

AS™ E 1725 (2008)

AS™ E 119 (2012)

Rating: 1 Hour

Approved for any cable fill

Reference Intertek Design Listing 3MU/AF 60-06 for Ampacity Derating

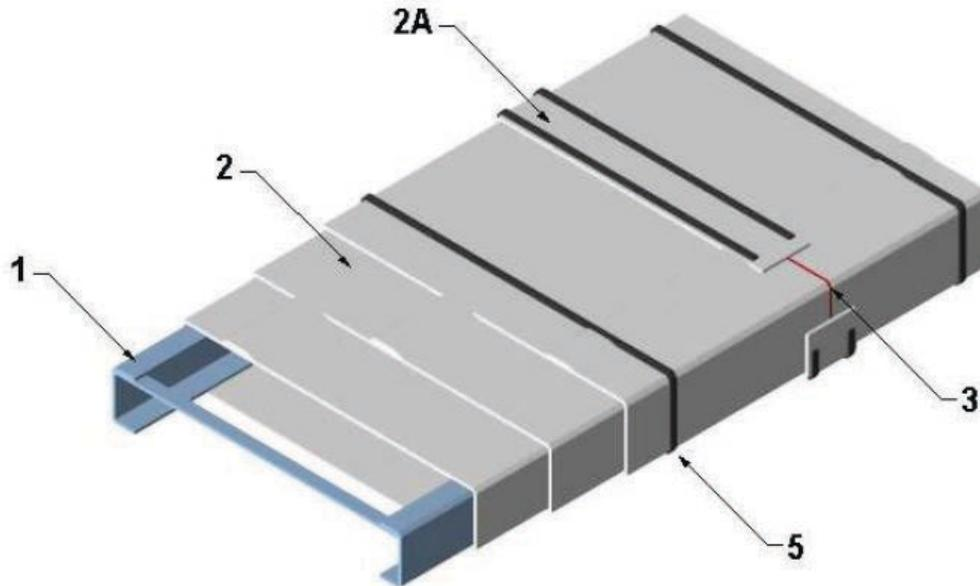

- 1. Cable Tray** – Use nominal 24 in. wide x 4 in. deep galvanized steel ladder-back cable tray. Friction fit nominal 13/16 in. wide x 13/32 in. deep, 18 GA galvanized steel struts between side rails spaced 12 in. on center (oc) along the length of the cable tray. Use filament tape for additional support if needed.
- 2. Certified Manufacturer:** 3M Company
Certified Product : Fireproofing Applied
Model: 3M™ Interam™ E-5, E-54-A and E-5A-4 Series Endothermic Mat
Endothermic Mat: Install 3 layers of foil faced flexible mat tightly around the cable tray (Item 1). Install each piece of mat with a minimum 2 in. overlap onto itself and temporarily hold in place using filament tape if needed.
A. Collar: Install nominal 4 in. wide strip of endothermic mat (Item 2) around outer layer of the wrapped cable tray (Item 1). Center collar over butt joints over outer layer and secure using steel banding (Item 5).
- 3. Certified Manufacturer:** 3M Company
Certified Product: Caulk or Sealant
Model: 3M™ Fire Barrier CP 25WB+ Caulk
Caulk: Install caulk between butt joints of endothermic mat (Item 2) on all layers. Alternative use is to fill gaps and voids along seams greater than 1/8 in. wide.
- 4. Tape:** (Not Shown) Apply 4 in. wide pressure sensitive tape with aluminum foil facing to all exposed edges of the collar (Item 2A) as well as the longitudinal (overlap) joints of the endothermic mat (Item 2) on the outer layer.
- 5. Steel Banding:** Install 1/2 in. wide x 0.020 in. thick stainless steel banding on the outer layer of the endothermic mat (Item 2). Install banding within 1 in. of the edge of collars (Item 2A) and butt joints and maximum 12 in. oc at all other locations.

This material was extracted and drawn by 3M Fire Protection Products from the 2018 Product Directory, © Intertek





Design Number 3MU/AF 60-02

(Formerly Design ECP 524)

03-May-13

APPLIED FIREPROOFING

3M Company

3M™ Interam™ E-5, E-54-A and E-5A-4 Series Endothermic Mat 3M™ Fire Barrier CP 25WB+ Caulk

AS™ E 1725 (2008)

AS™ E 119 (2012)

Rating: 1 Hour

Approved for any cable fill

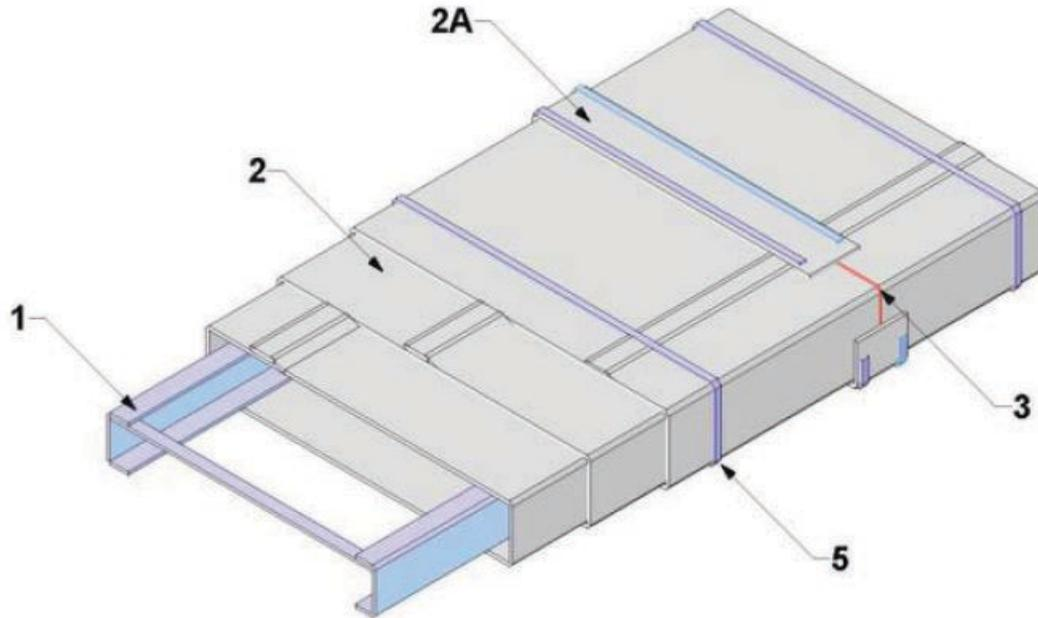

- 1. Cable Tray** – Use nominal 6 in. wide x 4 in. deep galvanized steel ladder-back cable tray. Friction fit nominal 13/16 in. wide x 13/32 in. deep, 18 GA galvanized steel struts between side rails spaced 12 in. on center (oc) along the length of the cable tray. Use filament tape for additional support if needed.
- 2. Certified Manufacturer:** 3M Company
Certified Product : Applied Fireproofing
Model: 3M™ Interam™ E-5, E-54-A and E-5A-4 Series Endothermic Mat
Endothermic Mat: Install 3 layers of foil faced flexible mat tightly around the cable tray (Item 1). Install each piece of mat with a minimum 2 in. overlap onto itself and temporarily hold in place using filament tape if needed.
A. Collar: Install nominal 4 in. wide strip of endothermic mat (Item 2) around outer layer of the wrapped cable tray (Item 1). Center collar over butt joints over outer layer and secure using steel banding (Item 5).
- 3. Certified Manufacturer:** 3M Company
Certified Product: Caulk or Sealant
Model: 3M™ Fire Barrier CP 25WB+ Caulk
Caulk: Install caulk between butt joints of endothermic mat (Item 2) on all layers. Alternative use is to fill gaps and voids along seams greater than 1/8 in. wide.
- 4. Tape:** (Not Shown) Apply 4 in. wide pressure sensitive tape with aluminum foil facing to all exposed edges of the collar (Item 2A) as well as the longitudinal (overlap) joints of the endothermic mat (Item 2) on the outer layer.
- 5. Steel Banding:** Install 1/2 in. wide x 0.020 in. thick stainless steel banding on the outer layer of the endothermic mat (Item 2). Install banding within 1 in. of the edge of collars (Item 2A) and butt joints and maximum 12 in. oc at all other locations.

This material was extracted and drawn by 3M Fire Protection Products from the 2018 Product Directory, © Intertek





Design Number 3MU/AF 60-03

(Formerly Design ECP 525)

26-April-13

APPLIED FIREPROOFING

3M Company

3M™ Interam™ E-5, E-54-A and E-5A-4 Series Endothermic Mat 3M™ Fire Barrier CP 25WB+ Caulk

AS™ E 1725 (2008)

AS™ E 119 (2012)

Rating: 1 Hour

Approved for any cable fill

Reference Intertek Design Listing 3MU/AF 60-07 for Ampacity Derating

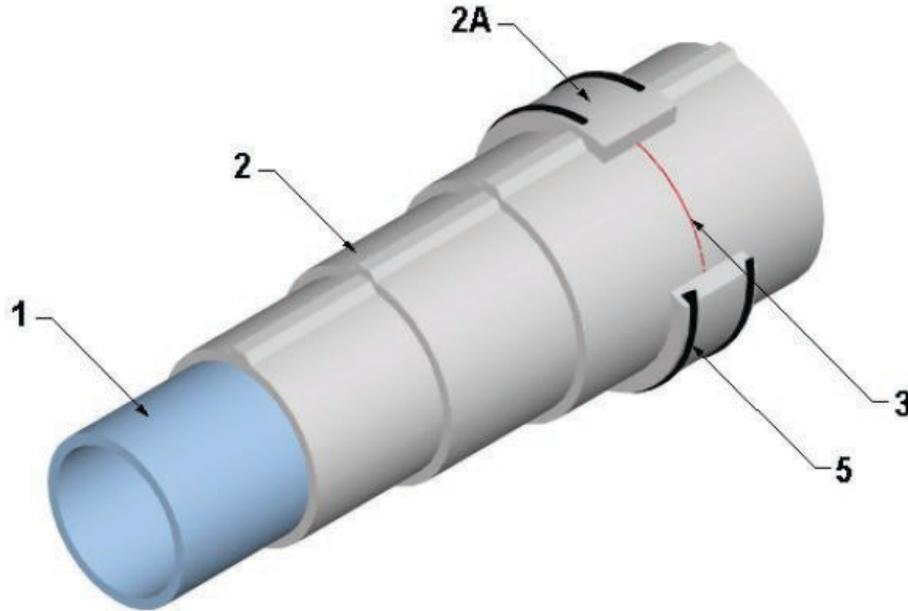

- 1. Conduit** – Use minimum 1 in. (or larger) rigid galvanized steel conduit (RMC) or galvanized steel electrical metallic tubing (EMT) with a minimum linear weight per foot of 0.64 lbs/ft.
- 2. Certified Manufacturer:** 3M Company
Certified Product : Applied Fireproofing
Model: 3M™ Interam™ E-5, E-54-A and E-5A-4 Series Endothermic Mat
Endothermic Mat: Install 3 layers of foil faced flexible mat tightly around the conduit (Item 1). Install each piece of mat with a minimum 2 in. overlap onto itself and temporarily hold in place using filament tape if needed.
A. Collar: Install nominal 4 in. wide strip of endothermic mat (Item 2) around outer layer of the wrapped conduit (Item 1). Center collar over butt joints over outer layer and secure using steel banding (Item 5).
- 3. Certified Manufacturer:** 3M Company
Certified Product: Caulk or Sealant
Model: 3M™ Fire Barrier CP 25WB+ Caulk
Caulk: Install caulk between butt joints of endothermic mat (Item 2) on all layers. Alternative use is to fill gaps and voids along seams greater than 1/8 in. wide.
- 4. Tape:** (Not Shown) Apply 4 in. wide pressure sensitive tape with aluminum foil facing to all exposed edges of the collar (Item 2A) as well as the longitudinal (overlap) joints of the endothermic mat (Item 2) on the outer layer.
- 5. Steel Banding:** Install 1/2 in. wide x 0.020 in. thick stainless steel banding on the outer layer of the endothermic mat (Item 2). Install banding within 1 in. of the edge of collars (Item 2A) and butt joints and maximum 12 in. on center at all other locations.

This material was extracted and drawn by 3M Fire Protection Products from the 2018 Product Directory, © Intertek





Design Number 3MU/AF 60-04

(Formerly Design ECP 526)

30-Aug-12

APPLIED FIREPROOFING

3M Company

3M™ Interam™ E-5, E-54-A and E-5A-4 Series Endothermic Mat

3M™ Fire Barrier CP 25WB+ Caulk

ASTM E 1725 (2008)

ASTM E 119 (2012)

Rating: 1 Hour

Approved for any cable fill

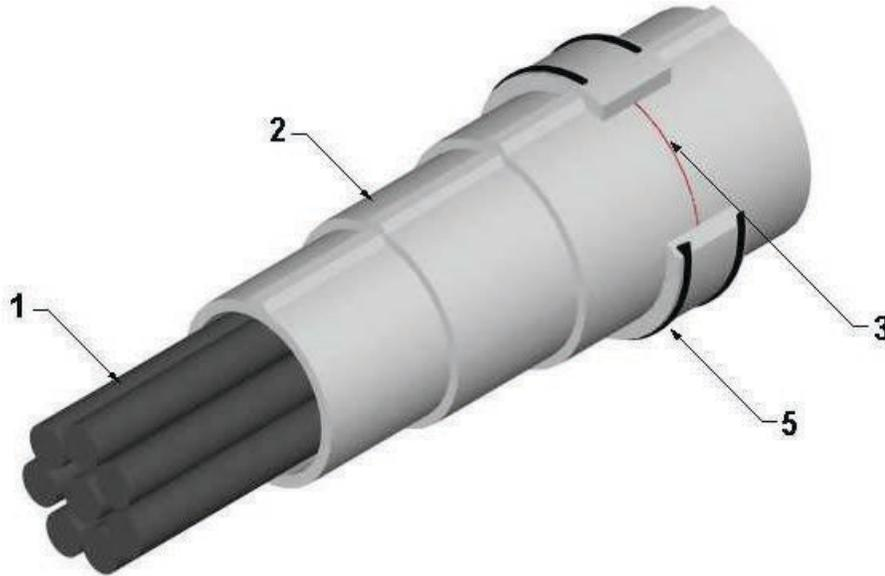

1. Cable Bundle: Use any number or type of cables.

2. Certified Manufacturer: 3M Company

Certified Product: Applied Fireproofing

Model: 3M™ Interam™ E-5, E-54-A and E-5A-4 Series Endothermic Mat

Endothermic Mat: Install 3 layers of foil faced flexible mat tightly around the cable bundle (Item 1). Install each piece of mat with a minimum 2 in. overlap onto itself and temporarily hold in place using filament tape if needed.

A. Collar: Install nominal 4 in. wide strip of endothermic mat (Item 2) around outer layer of the wrapped cable bundle (Item 1). Center collar over butt joints over outer layer and secure using steel banding (Item 5).

3. Certified Manufacturer: 3M Company

Certified Product: Caulk or Sealant

Model: 3M™ Fire Barrier CP 25WB+ Caulk

Caulk: Install caulk between butt joints of endothermic mat (Item 2) on all layers. Alternative use is to fill gaps and voids along seams greater than 1/8 in. wide.

4. Tape: (Not Shown) Apply 4 in. wide pressure sensitive tape with aluminum foil facing to all exposed edges of the collar (Item 2A) as well as the longitudinal (overlap) joints of the endothermic mat (Item 2) on the outer layer.

5. Steel Banding: Install 1/2 in. wide x 0.020 in. thick stainless steel banding on the outer layer of the endothermic mat (Item 2). Install banding within 1 in. of the edge of collars (Item 2A) and butt joints and maximum 12 in. oc at all other locations.

This material was extracted and drawn by 3M Fire Protection Products from the 2018 Product Directory, © Intertek



Design Number 3MU/AF 60-05

(Formerly Design ECP 527)

30-Aug-12

APPLIED FIREPROOFING

3M Company

3M™ Interam™ E-5, E-54-A and E-5A-4 Series Endothermic Mat

3M™ Fire Barrier CP 25WB+ Caulk

ASTM E 1725 (2008)

ASTM E 119 (2012)

Rating: 1 Hour

Approved for any cable fill

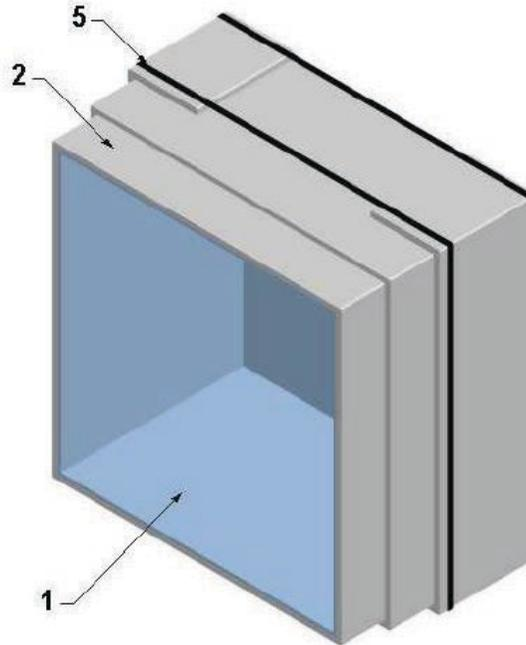

- 1. Junction Box:** Use nominal 12 in. wide x 12 in. high x min. 8 in. deep, 16 GA galvanized steel junction box.
- 2. Certified Manufacturer:** 3M Company
Certified Product: Applied Fireproofing
Model: 3M™ Interam™ E-5, E-54-A and E-5A-4 Series Endothermic Mat
Endothermic Mat: Install 3 layers of foil faced flexible mat tightly around the junction box (Item 1). Install the first two innermost layers to form an overlapped, square edge joint. Install the outermost layer creating a 2 in. min. overlap is created on the resulting seam and a 3 in. overlap is created on all four adjacent junction box faces. Temporarily hold in place using filament tape if needed.
- 3. Certified Manufacturer:** 3M Company
Certified Product: Caulk or Sealant
Model: 3M™ Fire Barrier CP 25WB+ Caulk
Caulk (Not Shown): Install caulk between butt joints of endothermic mat (Item 2) on all layers. Alternative use is to fill gaps and voids along seams greater than 1/8 in. wide.
- 4. Tape:** (Not Shown) Apply 4 in. wide pressure sensitive tape with aluminum foil facing to all exposed edges of the collar (Item 2A) as well as the longitudinal (overlap) joints of the endothermic mat (Item 2) on the outer layer.
- 5. Steel Banding:** Install 1/2 in. wide x 0.020 in. thick stainless steel banding on the outer layer of the endothermic mat (Item 2). Install banding within 1 in. of the edge of the 3 in. overlap edges of the endothermic mat (Item 2) and butt joints and maximum 4 in. oc at all other locations.

This material was extracted and drawn by 3M Fire Protection Products from the 2018 Product Directory, © Intertek

Design Number 3MU/AF 120-01

July 27, 2016

APPLIED FIREPROOFING

3M Company

3M™ Interam™ E-5, E-54-A and E-5A-4 Series Endothermic Mat

3M™ Fire Barrier CP 25WB+ Sealant

ASTM E1725 (2014)

ASTM E119 (2014)

Rating: 2 Hours

Approved for any cable fill

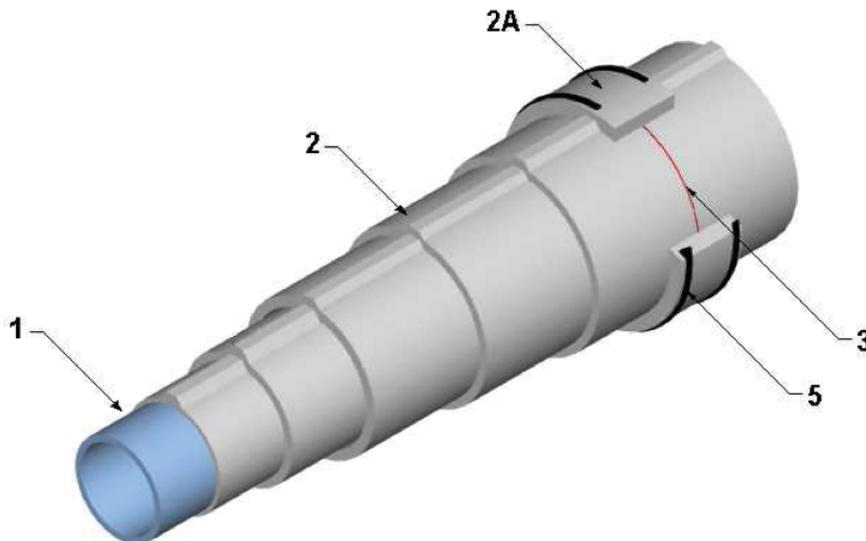

1. **CONDUIT:** Use 1 in. diameter (or larger) electrical metal tubing conduit (EMT), intermediate metal conduit (IMC) or rigid metal conduit (RMC)
2. **CERTIFIED MANUFACTURER:** 3M Company
CERTIFIED PRODUCT: Applied Fireproofing
CERTIFIED MODEL: 3M™ Interam™ E-5, E-54-A and E-5A-4 Series Endothermic Mat
ENDOTHERMIC MAT: Install 5 layers of foil faced flexible mat tightly around the conduit (Item 1). Install each piece of mat with a min 2 in. overlap onto itself and temporarily hold in place using filament tape if needed. The seaming arrangement of adjacent pieces on the same layer is butted joints with a max 3/8 in. gap. From one layer to the next, the butted seams are staggered a min of 2 in. away from the seam in the previous layer.
 - A. **COLLAR (Optional):** As an alternate to staggering the butted seams, and if there is a through-seam through all the layers, install nominal 4 in. wide strip of endothermic mat (Item 2) around outer layer of the wrapped EMT conduit (Item 1). Center collar over butt joints over the outer layer and secure using steel banding (Item 5).
3. **CERTIFIED MANUFACTURER:** 3M Company
CERTIFIED PRODUCT: Caulk or Sealant
CERTIFIED MODEL: 3M™ Fire Barrier CP 25WB+
CAULK: When the butt joint between adjacent pieces on the same layer exceeds 1/8 in., install caulk between butt joints of endothermic mat (Item 2) to the same depth of the mat.
4. **TAPE (Not Shown):** Apply 4 in. wide pressure sensitive tape with aluminum foil facing to longitudinal (overlap) joints and lateral (butted) joints of the endothermic mat (Item 2) on all layers. If applicable, also apply tape to exposed edges of the collar (Item 2A).
5. **STEEL BANDING:** Install 1/2 in. wide by 0.020 in. thick stainless steel banding on the outer layer of the endothermic mat (Item 2). Install banding within 1 in. of the edge of collars (Item 2A) and butt joints and max 12 in. oc at all other locations.

This material was extracted and drawn by 3M Fire Protection Products from the 2016 Product Directory, © Intertek

Flexible Wraps

Endothermic Mat

Applied Fireproofing

AF



Design Number 3MU/AF 180-01

(Formerly Design ECP 528)

30-Aug-12

APPLIED FIREPROOFING

3M Company

3M™ Interam™ E-5, E-54-A and E-5A-4 Series Endothermic Mat

3M™ Fire Barrier CP 25WB+ Caulk

ASTM E 1725 (2008)

ASTM E 119 (2012)

Rating: 3 Hours

Approved for any cable fill

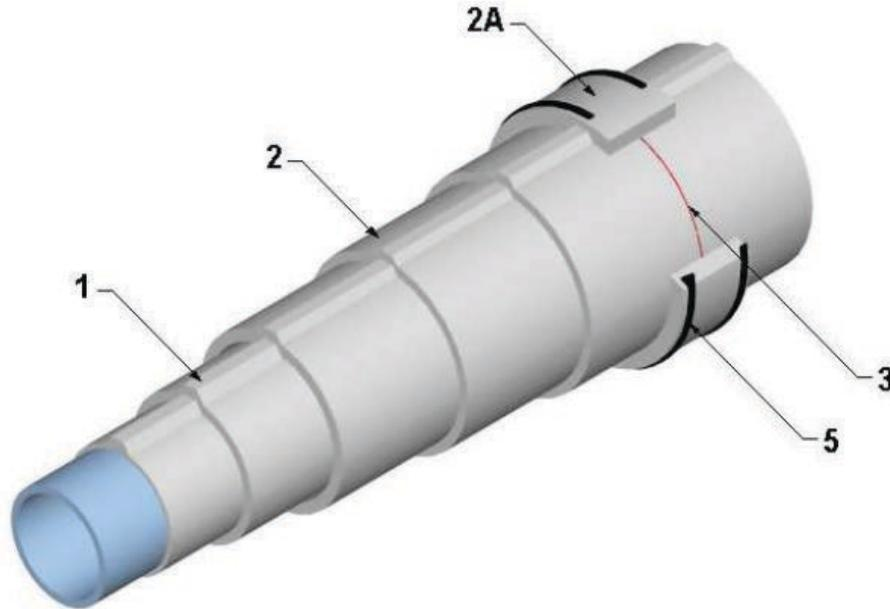

1. Conduit: Use 1 in. diameter (or larger) rigid steel conduit.

2. Certified Manufacturer: 3M Company

Certified Product: Applied Fireproofing

Model: 3M™ Interam™ E-5, E-54-A and E-5A-4 Series Endothermic Mat

Endothermic Mat: Install 5 layers of foil faced flexible mat tightly around the conduit (Item 1). Prior to installing innermost layer, cut 1-1/2 in. wide strips of endothermic mat and wrap around conduit (Item 1) spaced 15 in. on center (oc) and hold in place with filament tape. This is done in order to create an air gap between the conduit (Item 1) and the first (innermost) layer of the endothermic mat. After this is done, install the first two innermost layers creating a min. 4 in. overlap onto itself. Temporarily hold in place using filament tape if needed. After this is done, install a second set of 1-1/2 in. wide strips of endothermic mat in the same manner as previously done. Then, install the remaining three layers of endothermic mat in the same manner as the first two.

A. Collar: Install nominal 4 in. wide strip of endothermic mat (Item 2) around outermost layer of the wrapped conduit (Item 1). Center collar over butt joints over outer layer and secure using steel banding (Item 5).

3. Certified Manufacturer: 3M Company

Certified Product: Caulk or Sealant

Model: 3M™ Fire Barrier CP 25WB+ Caulk

Caulk (Not Shown): Install caulk between butt joints of endothermic mat (Item 2) on all layers. Alternative use is to fill gaps and voids along seams greater than 1/8 in. wide.

4. Tape: (Not Shown) Apply 4 in. wide pressure sensitive tape with aluminum foil facing to all exposed edges of the collar (Item 2A) as well as the longitudinal (overlap) joints of the endothermic mat (Item 2) on the outer layer.

5. Steel Banding: Install 1/2 in. wide x 0.020 in. thick stainless steel banding on the outermost layer of the endothermic mat (Item 2). Install banding within 1 in. of the edge of collars (Item 2A) and butt joints and maximum 12 in. oc at all other locations.

This material was extracted and drawn by 3M Fire Protection Products from the 2018 Product Directory, © Intertek





Design Number 3MU/AF 180-02
(Formerly Design Number ECP 529)

March 14, 2018
3M Company
Applied Fireproofing
Cable Bundle

3M™ Interam™ E-5, E-54-A, and E-5A-4 Series Endothermic Mat
ASTM E1725 (2008), ASTM E119 (2012)
Rating: 3 Hour
(Approved for any cable fill)

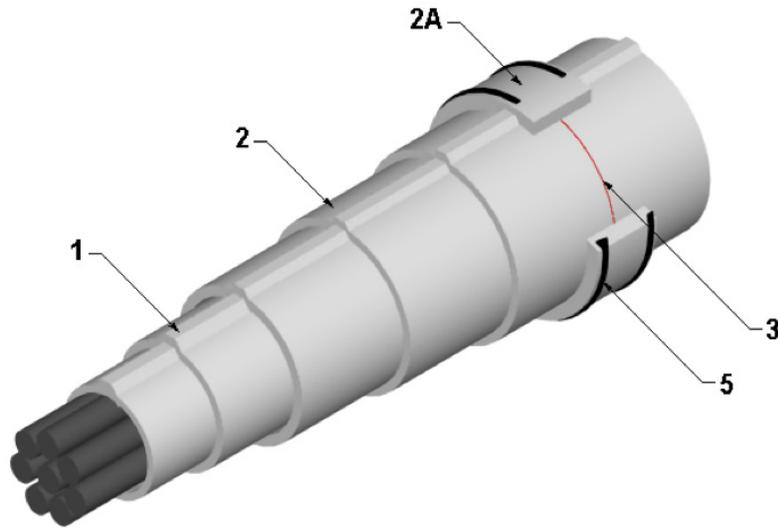

Figure 1. Cable Bundle Protection

- 1. CABLE BUNDLE:** Use any number or type of cables.
- 2. CERTIFIED MANUFACTURER:** 3M Company
CERTIFIED PRODUCT: Applied Fireproofing
CERTIFIED MODEL: 3M™ Interam™ E-5, E-54-A, and E-5A-4 Series Endothermic Mat
ENDOTHERMIC MAT: Install five layers of foil-faced flexible mat tightly around the cable bundle (Item 1). Install each piece of mat with a min. 2 in. overlap at the seam with the internal diameter of the air drop being min. 2 in. The endothermic mat is to continue past the innermost layer of protection of the adjacent cable tray (not shown).
A. COLLAR - Install min. 4 in. wide strips of endothermic mat (Item 2) around outermost layer at the base of the air drop at the cable entry point. The collar serves as support for the adjacent cable tray protection.
- 3. CERTIFIED MANUFACTURER:** 3M Company
CERTIFIED PRODUCT: Caulk or Sealant
CERTIFIED MODEL: 3M™ Fire Barrier CP 25WB+ Caulk
CAULK: Install caulk between butt joints of endothermic mat (Item 2) on all layers. Alternative use is to fill gaps and voids along seams greater than 1/8 in. wide.
- 4. ALUMINUM TAPE (Not Shown):** Apply 4 in. wide pressure-sensitive tape with aluminum foil-facing to all exposed edges of the collar (Item 2A) as well as the longitudinal (overlap) joints of the endothermic mat (Item 2) on the outer layer.
- 5. STEEL BANDING:** Install 1/2 in. wide x 0.020 in. thick stainless steel banding on the outer layer of the endothermic mat (Item 2). Install banding within 1 in. of the edge of collars (Item 2A) and butt joints and max. 12 in. on center (oc) at all other locations.

This material was extracted and drawn by 3M Fire Protection Products from the 2018 Product Directory, © Intertek





Design Number 3MU/AF 180-03

(Formerly Design ECP 530)

30-Aug-12

APPLIED FIREPROOFING

3M Company

3M™ Interam™ E-5, E-54-A and E-5A-4 Series Endothermic Mat

3M™ Fire Barrier CP 25WB+ Caulk

ASTM E 1725 (2008)

ASTM E 119 (2012)

Rating: 3 Hour

Approved for any cable fill

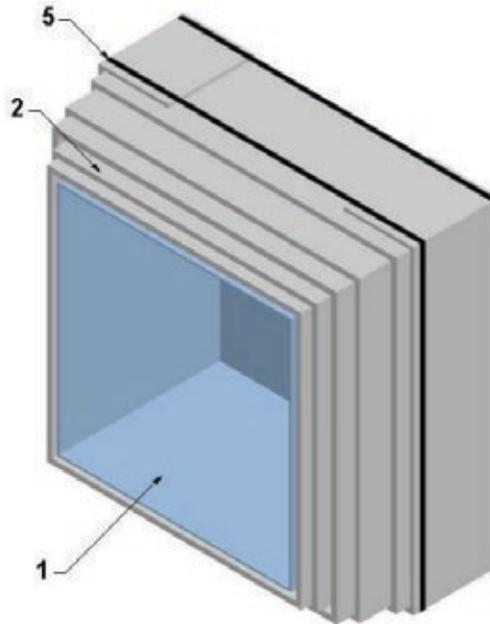

1. **Junction Box:** Use nominal 12 in. wide x 12 in. high x min. 8 in. deep, 16 GA galvanized steel junction box.

2. **Certified Manufacturer:** 3M Company

Certified Product: Applied Fireproofing

Model: 3M™ Interam™ E-5, E-54-A and E-5A-4 Series Endothermic Mat

Endothermic Mat: Install 6 layers of foil faced flexible mat tightly around the junction box (Item 1). Prior to installing innermost layer, cut 1-1/2 in. wide strips of endothermic mat and wrap around conduit (Item 1) spaced 15 in. on center (oc) and hold in place with filament tape. This is done in order to create an air gap between the junction box (Item 1) and the first (innermost) layer of the endothermic mat. After this is done, install the first two innermost layers to form an overlapped, square edge joint. After this is done, install a second set of 1-1/2 in. wide strips of endothermic mat in the same manner as previously done. Install the following three layers in the same manner as the first two. Install the outermost layer creating a 4 in. min. overlap is created on the resulting seam and a 4 in. overlap is created on all four adjacent junction box faces. Temporarily hold in place using filament tape if needed.

3. **Certified Manufacturer:** 3M Company

Certified Product: Caulk or Sealant

Model: 3M™ Fire Barrier CP 25WB+ Caulk

Caulk (Not Shown): Install caulk between butt joints of endothermic mat (Item 2) on all layers. Alternative use is to fill gaps and voids along seam greater than 1/8 in. wide.

4. **Tape:** (Not Shown) Apply 4 in. wide pressure sensitive tape with aluminum foil facing to all exposed edges of the collar (Item 2A) as well as the longitudinal (overlap) joints of the endothermic mat (Item 2) on the outer layer.

5. **Steel Banding:** Install 1/2 in. wide x 0.020 in. thick stainless steel banding on the outer layer of the endothermic mat (Item 2). Install banding within 1 in. of the edge of the 3 in. overlap edges of the endothermic mat (Item 2) and butt joints and maximum 4 in. oc at all other locations.

This material was extracted and drawn by 3M Fire Protection Products from the 2018 Product Directory, © Intertek

September 17, 2012

Fire Rating — 1 Hr.

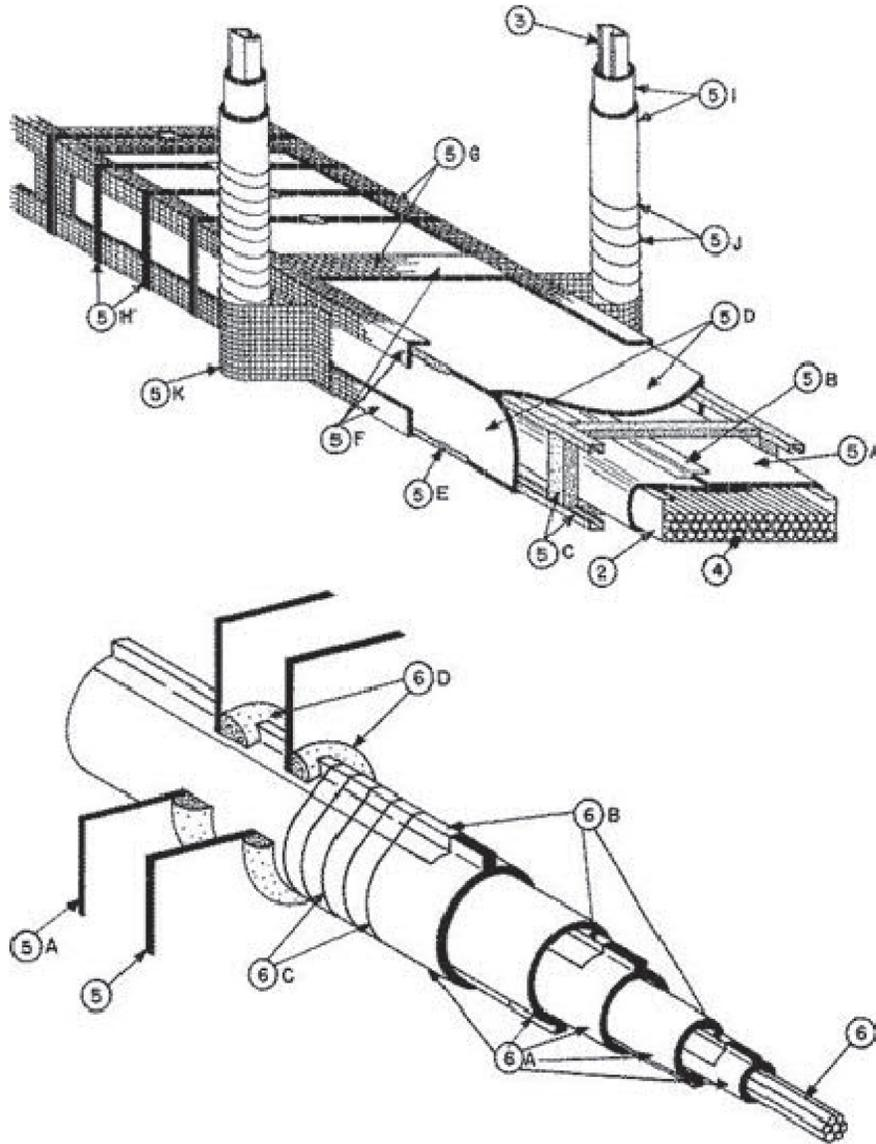

1. **Wall or Floor Assembly** — (Not shown) — Min 1 hr fire rated concrete or masonry wall or concrete floor. Opening in wall or floor through which cable tray passes is to be sized to closely follow the contour of the cable tray. Through opening in wall or floor to be firestopped prior to installation of the electrical circuit protective system using a compatible firestop system. The perimeter of the firestopped through opening shall be within the outer bounds of the electrical circuit protective system. See **Through Penetration Firestop Systems** (Guide XHEZ) for presently Classified firestop systems.
2. **Cable Tray** — 24 in. wide, min 4 in. deep, solid bottom or open ladder cable trays. Solid bottom cable trays to be formed of minimum 0.056 in. (16 gauge) galvanized steel. Open ladder cable trays to consist of channel-shaped side-rails formed of minimum 0.056 in. (16 gauge) galvanized steel with nominal 3/4 in. wide by 1 in. deep boxed channel rungs formed of minimum 0.029 in. (22 gauge) galvanized steel and spaced 6 in. O. C. Cable trays shall be installed as a complete system in accordance with all provisions of the current National Electrical Code.
3. **Cable Tray Supports** — The cable trays shall be supported by U-shaped welded hangers formed of minimum 0.093 in. thick (12 gauge) painted or galvanized steel channels, 1-5/8 in. wide by min 1-5/8 in. deep with the flange edges hemmed for stiffness.

System No. 2 (cont.)

- 4. Cables** — Min No. 16 AWG jacketed multi-conductor cables and/or min 250 MCM jacketed copper single-conductor power cables. Cable insulation to be cross-linked polyethylene. Cable jacket to be polyvinyl chloride or cross-linked polyethylene. When fillers are used in the cable construction, fillers to be hemp, polyvinyl chloride or cross-linked polyethylene. Cables to be installed in cable trays in accordance with all provisions of the current National Electrical Code.
- 5. Electrical Circuit Protective System** — The electrical circuit protective system may consist of either a multilayer mat wrap system or a composite system consisting of a mat wrap within an intumescent sheet enclosure on steel framing. The multilayer mat wrap system consists of a mat wrap, aluminum foil tape, stainless steel wire, intumescent sheet, steel hardware cloth, steel banding straps and caulk. The composite system consists of the same component materials plus steel framing members. The systems shall be installed in accordance with the detailed installation instruction manual supplied by the manufacturer of the **Electrical Circuit Protective Materials***. The details of the two electrical circuit protective system types are summarized below:

A Electrical Circuit Protective Materials* — Intumescent Mat — Flexible sheet material. Installed by cutting to size and wrapping around the cable tray system with each circumferential wrap lapping itself over the top of the cable tray. For the multilayer mat wrap system, overlap of each circumferential wrap to be min 2 in. For the composite system, overlap of the single circumferential lap to be min 6 in. Adjacent sheets of mat in each layer must overlap the preceding sheet 2 to 6 in. For the multilayer mat wrap system, successive layers of mat wrap installed with seams offset min 4 in. from seams of preceding layer. All seams in each layer of mat wrap to be sealed with aluminum foil tape (Item 5B). For the multilayer mat wrap system, a min of four layers of mat are required. For the composite system, only one layer of mat is required.

3M COMPANY — Types M-20A, I-10A.

- B Aluminum Foil Tape** — Nom 4 in. wide min 3 mil thick pressure-sensitive aluminum foil tape supplied in rolls. Used to secure seams of mat wrap (Item 5A).
- C. Steel Framing** — (Composite System Only) — Steel channels with nominal 1-1/4 in. wide web with either 1-1/4 in. or 3/4 in. high flanges with the flange edges hemmed for stiffness and to accommodate special mechanical fasteners. The channels shall be formed of minimum 0.067 in. thick (14 gauge) painted or galvanized steel. Steel channels assembled to form a four sided framework around the cable tray along the entire cable tray system. The longitudinal members along the four corners of the cable tray framing and the transverse members spanning across the top and bottom of the cable tray to be nominal 1-1/4 in. wide by 3/4 in. high channels. The framing members spanning between the longitudinal members along the cable tray side-rails to be nominal 1-1/4 in. wide by 1-1/4 in. high channels. The transverse members around the four sides of the cable tray shall be spaced not more than 36 in. O.C. along the entire cable tray system to occur at each butted end joint of the intumescent sheets (Item 5D). The steel framing members shall be assembled by welding or through the use of special fittings in conjunction with 3/8 in. diameter steel bolts with nuts. The steel framing must be installed such that the minimum clearance between the intumescent sheets (Item 5D) and the cable tray system is 2-1/4 in. When cable air drops (Item 6) are present, additional steel framing members shall be installed to provide screw-attachment means for the intumescent sheets (Item 5D) around the perimeter of the cable air drop opening. The steel framing is to be secured to the steel cable tray supports (Item 3) and to the floor or wall and is to be installed without direct contact with the cable tray system.
- D. Electrical Circuit Protective Material* — Intumescent Sheet** — Rigid aluminum foil-faced sheets with galvanized steel sheet backer. Installed on steel framing of composite system, with aluminum foil facing on exterior, to completely enclose cable tray system. Sheets installed with tightly butted joints at corners of steel framing and with adjacent sheets tightly butted with joints centered over transverse framing members. Each sheet to be affixed to steel framing at corners with No. 10-16 by 3/4 in. long self-drilling, self-tapping hex-washer head steel screws.

For the multilayer mat wrap system, a nom 4 in. wide piece of intumescent sheet to be formed into collar around mat wrapped cable tray with seam butted and with steel backer exposed (foil facing against mat wrap). Collar butted against wall or floor surface and secured to mat wrapped cable tray with stainless steel banding strap (Item 5H). A two-piece plate cut from intumescent sheet to be installed on wall or floor surface around intumescent sheet collar. Plate pieces cut to tightly-follow the contours of the intumescent sheet collar with seams between pieces tightly butted. Plate to lap min 2 in. on the wall or floor surface with the steel backer exposed (foil face against wall or floor surface). Plate secured to wall or floor surface with steel anchor bolts, or equivalent, in conjunction with min 1-1/4 in. diameter steel fender washers. Anchor bolts located max 2 in. from both sides of butted seams and max 4 in. O.C. around perimeter of plate, 1 in. from plate edges. When butted seams of two-piece plate are not completely backed by concrete, seams to be covered with min 2 in. wide strips of min 0.016 in. thick galv steel secured with steel screws or rivets spaced max 2 in. O.C. on both sides of seam.

3M COMPANY — Type CS-195.

- E. Electrical Circuit Protective Material* — Caulk.** — Thick bead of caulk to be applied along the edges of the intumescent mat (Item 5A) at its interface with the cable tray supports (Item 3), over butted joints of intumescent sheet (Item 5D) and around perimeter of cable tray support (Item 3) and cable air drop protective system (Item 6) at their egress from the membranes of the composite protective system. For multilayer mat wrap system, thick bead of caulk to be applied around the base of the intumescent sheet collar (Item 5D) at its interface with the intumescent sheet plate. Thick bead of caulk applied around perimeter of mat wrap at interface with intumescent sheet collar.

3M COMPANY — CP 25WB+

- F. Electrical Circuit Protective Material* — Intumescent Mat** — Flexible sheet material. Installed in conjunction with steel hardware cloth (Item 5G) to cover all seams in intumescent sheet enclosure of composite system. Mat strips cut to length to completely cover each butted seam, centered over seam and temporarily held in position with aluminum foil tape (Item 5B).

3M COMPANY — Types I-10A, M-20A.

Flexible Wraps

Endothermic Mat

Applied Fireproofing

AF

System No. 2 (cont.)

- G. Steel Hardware Cloth** — Max 1/2 by 1/2 in. welded mesh of min 0.041 in. diameter (19 SWG) galvanized steel wire. Nominal 4 in. wide strips of hardware cloth cut to length and installed over each intumescent mat seam cover (Item 5F). Hardware cloth secured to intumescent sheet (Item 5D), through intumescent mat (Item 5F), with No. 10-16 by 3/4 in. long self-drilling, self-tapping, hex-washer head steel screws in conjunction with 5/8 in. diameter steel washers.

For multilayer mat wrap system, nominal 8 in. wide strip of hardware cloth formed to contour of cable tray wrap beneath cable tray support and secured with steel banding straps (Item 5H) on each side of cable tray support member.

- H. Steel Banding Strap** — Nominal 5/8 in. wide by 0.020 in. thick steel straps used in conjunction with nominal 1 in. long channel-shaped crimp clips formed of 0.021 in. thick electrogalvanized or painted steel. In composite system, steel banding straps spaced max 12 in. O.C. to secure the joint covers and intumescent sheets in position.

In multilayer mat wrap protective system, steel banding straps spaced max 8 in. OC and at each overlapping end seam to secure mat wrap layers in position. Banding straps also used to secure intumescent sheet collar on mat wrapped cable tray at interface with wall or floor.

- I. Electrical Circuit Protective Materials* — Intumescent Mat** — Flexible sheet material. Min of two layers wrapped around steel cable tray supports (Item 3) outside of intumescent sheet enclosure. Mat secured in place using aluminum foil tape (Item 5B) at all joints. Mat additionally secured with stainless steel wire (Item 5J) and/or steel hardware cloth (Item 5K).

3M COMPANY — Types I-10A, M-20A.

- J. Stainless Steel Wire** — Min 0.046 in. diameter (18 ga) stainless steel wire supplied in spools. Where accessible around entire circumference of cable tray support wrap, wire is tied-off at base of wrap at interface with intumescent sheet enclosure, spiraled upward at a spacing not to exceed 2 in. O.C., and tied-off at interface with wall or floor. Wire tie-off at top and base of cable tray support wrap covered with aluminum foil tape (Item 5B).

- K. Steel Hardware Cloth** — Max 1/2 by 1/2 in. welded mesh of min 0.041 in. diameter (19 SWG) galvanized steel wire. Strips of hardware cloth cut to size to cover intumescent mat wrap (Item 5I) on cable tray supports (Item 3) where 360 degrees access to the wrap is not present. Hardware cloth secured to intumescent sheet enclosure with No. 10-16 by 3/4 in. long self-drilling, self-tapping, hex-washer head steel screws in conjunction with 5/8 in. diameter steel washers,

- 6. Cable Air Drop** — Cables passing from one cable tray protective system to another cable tray protective system, through the air, to be protected with an electrical circuit protective system consisting of intumescent mat, aluminum foil tape, stainless steel wire, caulk and steel hardware cloth. Minimum aggregate area of cables in air drop (cross-sectional area of cables including cable insulation and jacket materials) is 1.88 sq in. The system shall be installed in accordance with the manufacturer's detailed instructions accompanying the **Electrical Circuit Protective Materials***. The details of the cable air drop protective system are summarized below:

- A. Electrical Circuit Protective Material* — Intumescent Mat** — Flexible sheet material. Installed by cutting to size and folding around tightly-bundled cables of cable air drop with the edges of the mat sheet secured together with steel staples and aluminum foil tape (Item 6B) along the longitudinal standing seam. Adjacent sheets of material must overlap the preceding sheet 3 to 6 in. Successive layers of intumescent mat installed in the same manner with the stapled and taped longitudinal seam of each layer diametrically opposed from that of the preceding layer and with overlap locations for each layer offset a minimum of 6 in. from the overlap of the preceding layer. A total of five layers of intumescent mat are required. Intumescent mat wrap on cable air drop to extend a minimum of 9 in. into intumescent mat wrap (Item 5A) of cable tray protective system at each end. Opening in cable tray protective systems to accommodate cable air drop shall conform to contours of mat wrapped cable air drop.

3M COMPANY — Type M20A.

- B. Aluminum Foil Tape** — Nom 4 in. wide min 3 mil thick pressure-sensitive aluminum foil tape supplied in rolls. Used to secure intumescent mat wrap (Item 6A).

- C. Stainless Steel Wire** — Min 0.046 in. diam (18 ga) stainless steel wire supplied in spools used for final securement of outer layer of intumescent mat wrap after aluminum foil tape application. Wire is tied-off at base of wrap at interfaces with cable tray protective systems, spiraled around intumescent mat wrap in both directions in a criss cross pattern and spaced 2 in. OC.

- D. Electrical Circuit Protective Materials* — Caulk** — Thick bead of caulk to be applied around the perimeter of the intumescent mat wrap on the cable air drop at each interface with the cable tray protective system.

3M COMPANY — CP 25WB+

*Bearing the UL Classification Mark

Flexible Wraps

Endothermic Mat

Applied Fireproofing

AF



September 17, 2012

Fire Rating — 1 Hr.

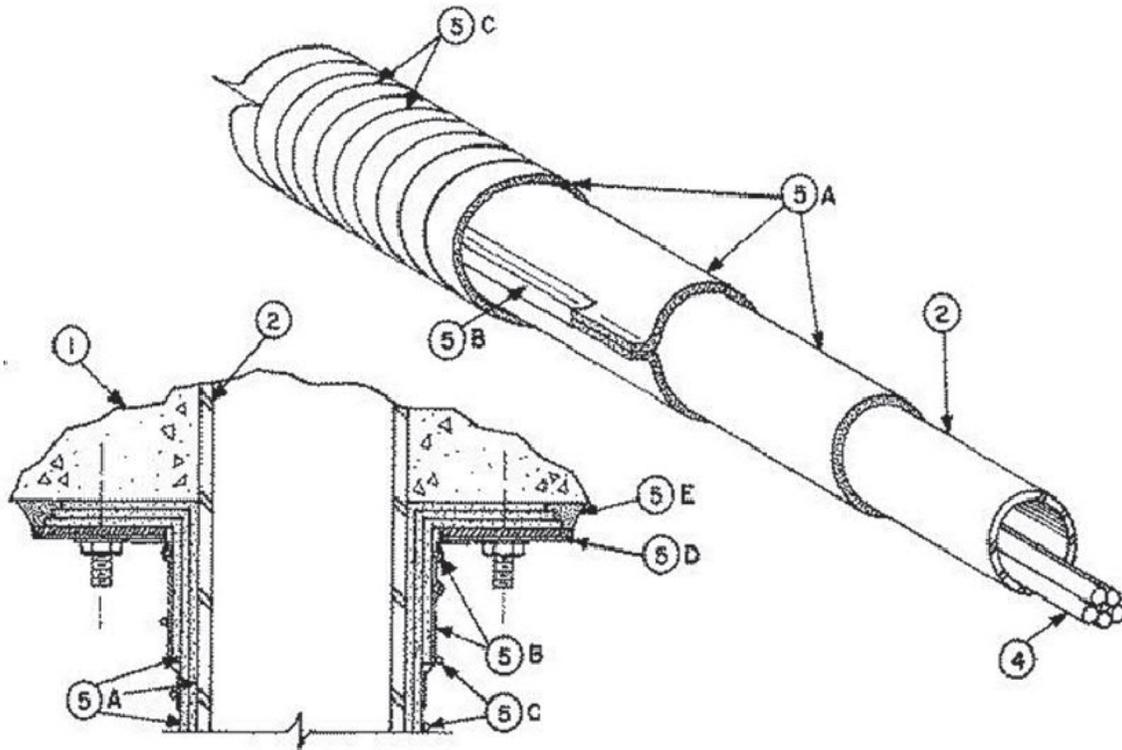

1. **Wall or Floor Assembly** — Min 1 hr fire rated concrete or masonry wall or concrete floor. Opening in wall or floor through which conduit passes is to be sized to closely follow the contour of the conduit. Through opening in wall or floor to be firestopped prior to installation of the electrical circuit protective system using a compatible firestop system. The perimeter of the firestopped through opening shall be within the outer bounds of the electrical circuit protective system. See Through Penetration Firestop Systems (Guide XHEZ) for presently Classified firestop systems.
2. **Steel Conduit** — Nominal 2 in. diameter (or larger) Trade Size rigid steel conduit. Conduits shall be installed as a complete system in accordance with all provisions of the current National Electrical Code.
3. **Conduit Support** — (Not Shown) — The conduits shall be supported by U-shaped welded hangers formed of minimum 0.093 in. thick (12 gauge) painted steel or minimum 0.097 in. thick (12 gauge) galvanized steel channels, 1-5/8 in. wide web with 1-5/8 in. high flanges with the flange edges hemmed for stiffness.
4. **Cables** — Minimum No. 16 AWG jacketed multi-conductor cable and/or minimum 250 MCM jacketed copper single-conductor power cables. Cable insulation to be cross-linked polyethylene. Cable jacket to be polyvinyl chloride. When fillers are used in the cable construction, fillers to be hemp, polyvinyl chloride or cross-linked polyethylene. Cables to be installed in conduits in accordance with all provisions of the current National Electrical Code.
5. **Electrical Circuit Protective System** — The electrical circuit protective system consists of intumescent mat, aluminum or stainless steel foil tape, stainless steel wire, intumescent sheet, caulk and steel hardware cloth. The system must be installed in accordance with the manufacturer's detailed instructions accompanying the Electrical Circuit Protective Materials*. The details of the electrical circuit protective system are summarized below:

System No. 3 (cont.)

- A. Electrical Circuit Protective Material* — Intumescent Mat** — Flexible sheet material. Installed by cutting to size and folding around conduit with the edges of the mat sheet secured together with foil tape (Item 5B) along the longitudinal standing seam. Adjacent sheets of material must overlap the preceding sheet 3 to 6 in. Successive layers of intumescent mat installed in the same manner with the taped longitudinal seam of each layer diametrically opposed from that of the preceding layer and with the overlap locations for each layer offset a minimum of 6 in. from the overlap of the preceding layer. A minimum of five layers of intumescent mat are required on nominal 2 in. to nominal 4-1/2 in. diameter Trade Size rigid steel conduit. A minimum of two layers of intumescent mat are required on nominal 5 and 6 in. diameter Trade Size rigid steel conduit. Minimum of two layers of intumescent mat wrapped around steel conduit supports (Item 3). Mat secured in place using aluminum foil tape (Item 5B) at all joints.

3M COMPANY — Types I-10A, -10C, M-20A, -20C.

- B. Foil Tape** — Nom 4 in. wide pressure-sensitive foil tape supplied in rolls. When Type I-10A or M-20A intumescent mat is used, min 3 mil thick foil tape shall be used to secure intumescent mat wrap. When Type I-10C or M-20C intumescent mat is used, min 3 mil thick stainless steel foil tape shall be used to secure intumescent mat wrap.

- C. Stainless Steel Wire** — Min. 0.046 in. diam (18 ga) stainless steel wire supplied on spools. Wire is tied-off at base of wrap at interface with wall and/or floor, spiraled around outer layer of mat at a spacing not to exceed 2 in. O.C. Wire tie-off at interface with wall and/or floor covered with foil tape (Item 5B).

- D. Electrical Circuit Protective Material* — Intumescent Sheet** — Rigid foil-faced sheets with galvanized steel sheet backer. Installed around intumescent mat wrapped conduit and conduit supports at the interface with the wall and/or floor. Secured to wall and/or floor with steel anchors.

3M COMPANY — Type CS-195.

- E. Electrical Circuit Protective Material* — Caulk** — Supplied in cartridges. Thick bead of caulk to be applied as a gasket between intumescent sheet (Item 5D) and the wall and/or floor.

3M COMPANY — CP 25WB+

*Bearing the UL Classification Mark

Flexible Wraps

Endothermic Mat

Applied Fireproofing

AF



September 17, 2012

Fire Rating — 1 Hr.

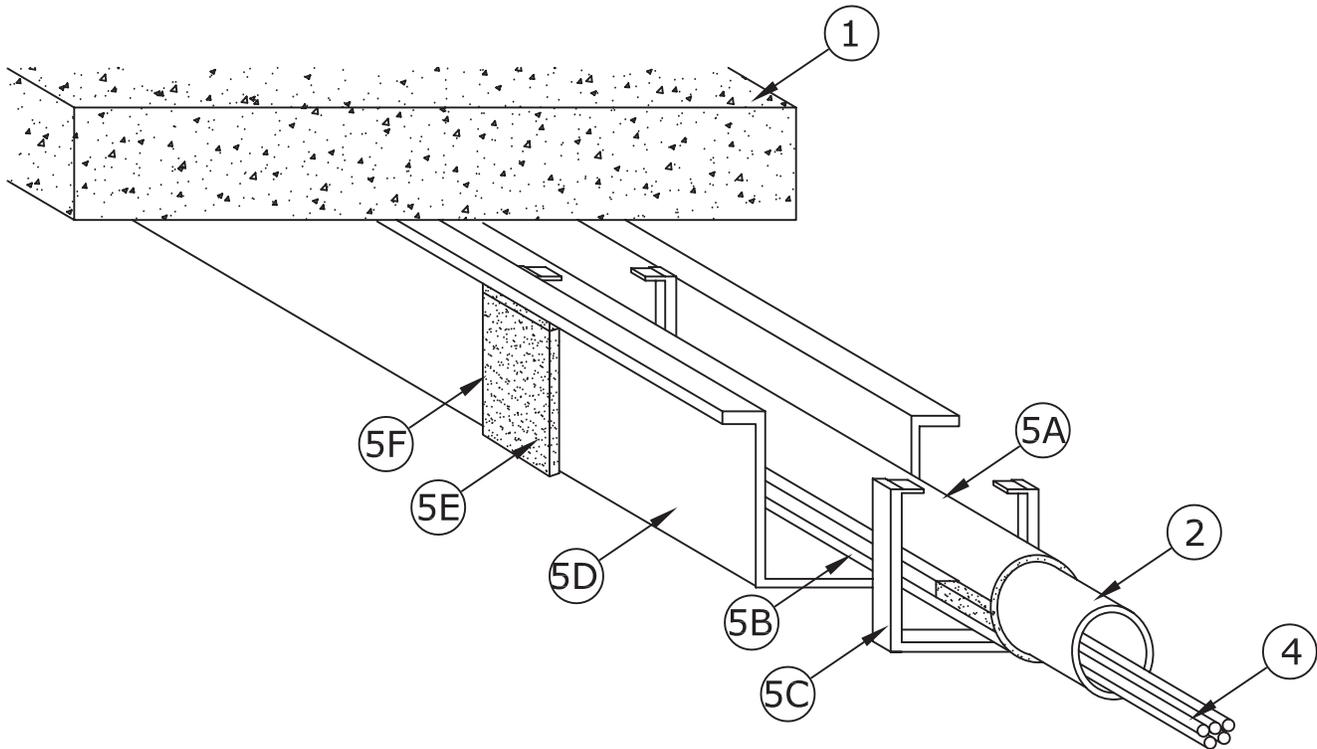

1. **Wall or Floor Assembly** — Min 1 hr fire rated concrete or masonry wall or concrete floor. Opening in wall or floor through which conduit passes is to be sized to closely follow the contour of the conduit. Through opening in wall or floor to be firestopped prior to installation of the electrical circuit protective system using a compatible firestop system. The perimeter of the firestopped through opening shall be within the outer bounds of the electrical circuit protective system. See **Through Penetration Firestop Systems** (Guide XHEZ) for presently Classified firestop systems.
2. **Steel Conduit** — Nominal 2 in. diameter (or larger) Trade Size rigid steel conduit. Conduits installed parallel with and maximum 2 in. from wall or floor. Conduits shall be installed as a complete system in accordance with all provisions of the current National Electrical Code.
3. **Conduit Supports** — (Not Shown) — Conduits shall be supported in accordance with all provisions of the current National Electrical Code. The supports used shall be completely within the three-sided intumescent sheet enclosure (Item 5D).
4. **Cables** — Minimum No. 16 AWG jacketed multi-conductor cables and/or minimum 250 MCM jacketed copper single-conductor power cables. Cable insulation to be cross-linked polyethylene. Cable jacket to be polyvinyl chloride. When fillers are used in the cable construction, fillers to be hemp, polyvinyl chloride or cross-linked polyethylene. Cables to be installed in conduit in accordance with all provisions of the current National Electrical Code.
5. **Electrical Circuit Protective System** — The electrical circuit protective system consists of intumescent mat, aluminum foil tape, steel framing, intumescent sheet, caulk and steel hardware cloth. The system must be installed in accordance with the manufacturer's detailed instructions accompanying the **Electrical Circuit Protective Materials***. The details of the electrical circuit protective system are summarized below:
 - A. **Electrical Circuit Protective Material* — Intumescent Mat** — Flexible sheet material. Installed by cutting to size and folding around steel conduit with the edges of the mat sheet secured together with steel staples and aluminum foil tape (Item 5B) along the longitudinal standing seam. Adjacent sheets of material must overlap the preceding sheet 3 to 6 in.
 - 3M COMPANY** — Types M-20A, I-10A.
 - B. **Aluminum Foil Tape** — Nominal 4 in. wide minimum 3 mil thick pressure-sensitive aluminum foil tape supplied in rolls. Used to secure intumescent mat wrap (Item 5A).
 - C. **Steel Framing** — Steel channels with nominal 1-1/4 in. wide web with 3/4 in. high flanges with the flange edges hemmed for stiffness and to accommodate special mechanical fasteners. The channels shall be formed of minimum 0.067 in. thick (14 gauge) painted steel or minimum 0.070 in. thick (14 gauge) galvanized steel. Steel channels assembled to form a U-shaped bracket around three sides of the conduit and secured to the wall or floor with steel anchors. The U-shaped brackets must be formed such that the minimum clearance between the intumescent sheets (Item 5D) and the conduit is 2 in. The U-shaped brackets shall be assembled by welding or through the use of special fittings in conjunction with 3/8 in. diameter steel bolts with nuts. Brackets installed at the interface with the wall or floor at each end of the conduit system and along the entire length of the conduit system with maximum spacing of 36 in. O. C. (bracket required at each butted joint of the intumescent sheet enclosure).

System No. 4 (cont.)

D. Electrical Circuit Protective Material* — Intumescent Sheet — Rigid aluminum foil-faced sheets with galvanized steel sheet backer. Intumescent sheet formed around U-shaped brackets with nominal 2 in. wide flanges along both side edges against wall or floor. Adjacent lengths of formed intumescent sheets to be tightly butted and to be centered over U-shaped brackets. Intumescent sheet secured to wall or floor with steel anchors spaced maximum 12 in. O. C. Sheets secured to U-shaped brackets with No. 10-16 by 3/4 in. long self-drilling, self-tapping hex-washer head steel screws.

3M COMPANY — Type CS-195.

E. Electrical Circuit Protective Material* — Intumescent Mat — Flexible sheet material. Installed in conjunction with steel hardware cloth (Item 5F) to cover all joints in intumescent sheet enclosure. Mat strips cut to length to completely cover each butted joint, centered over joint and temporarily held in position with aluminum foil tape (Item 5B).

3M COMPANY — Types I-10A, M-20A.

F. Steel Hardware Cloth — Maximum 1/2 by 1/2 in. welded mesh of minimum 0.041 in. diameter (19 SWG) galvanized steel wire. Nominal 4 in. wide strips of hardware cloth cut to length and installed over each intumescent mat joint cover (Item 5E). Hardware cloth secured to intumescent sheet (Item 5D), through intumescent mat (Item 5E), with No. 10-16 by 3/4 in. long self-drilling, self-tapping hex-washer head steel screws in conjunction with 5/8 in. diameter steel washers.

G. Electrical Circuit Protective Material* — Caulk — (Not shown) — Thick bead of caulk to be applied along the edges of the intumescent mat (Item 5A) at its interface with the conduit supports (Item 3), over butted joints of intumescent sheets (Item 5D) and around the perimeter of the intumescent mat (Item 5A) and intumescent sheet (Item 5D) at their interfaces with the floor or wall. Thick bead of caulk also to be applied as a gasket between the flanges of the intumescent sheet enclosure and the floor or wall surface.

3M COMPANY — CP 25WB+

*Bearing the UL Classification Mark

Flexible Wraps

Endothermic Mat

Applied Fireproofing

AF



September 17, 2012

Fire Rating — 1 Hr.

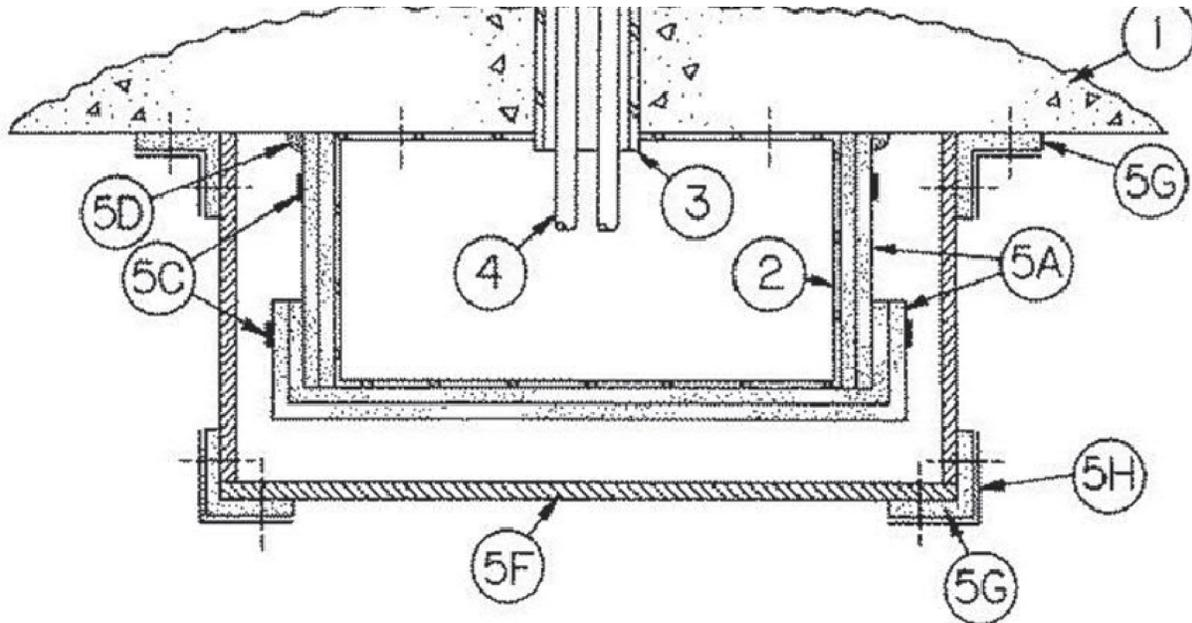

1. **Wall or Floor Assembly** — Min 1 hr fire rated concrete or masonry wall or concrete floor. Opening in wall or floor through which conduit passes is to be sized to closely follow the contour of the conduit. Through opening in wall or floor to be firestopped prior to installation of the electrical circuit protective system using a compatible firestop system. The perimeter of the firestopped through opening shall be within the outer bounds of the electrical circuit protective system. See **Through Penetration Firestop Systems** (Guide XHEZ) for presently Classified firestop systems.
2. **Steel Junction Box** — Min 12 in. by 12 in. by 6 in. deep surface-mounted junction box formed of min 0.052 in. thick (16 gauge) steel. Steel junction box to be installed in accordance with all provisions of the current National Electrical Code.
3. **Steel Conduit** — Optional — Nominal 2 in. diam (or larger) Trade Size rigid steel conduit. Conduits to be installed as a complete system in accordance with all provisions of the current National Electrical Code. Conduit to be provided with a min 1 hr fire rated electrical circuit protective system which is compatible with the electrical circuit protective system (Item 5) installed on the steel junction box. Details of electrical circuit protective system at conduit/junction box interface to be in accordance with the detailed installation instruction manual supplied by the manufacturer of the Electrical Circuit Protective Materials*.
4. **Cables** — Min No. 16 AWG jacketed multi-conductor cables and/or min 250 MCM jacketed single-conductor copper power cables. Cable insulation to be cross-linked polyethylene. Cable jacket to be cross-linked polyethylene or polyvinyl chloride. Cables to be installed in accordance with all provisions of the current National Electrical Code.
5. **Electrical Circuit Protective System** — The electrical circuit protective system consists of an intumescent mat wrap, aluminum foil tape, steel banding straps, caulk, steel framing, intumescent sheet and steel hardware cloth. The system shall be installed in accordance with the detailed installation instruction manual supplied by the manufacturer of the **Electrical Circuit Protective Materials***. The details of the electrical circuit protective system are summarized below:
 - A. **Electrical Circuit Protective Materials* — Mat Wrap** — Flexible sheet material. Installed by cutting to size and wrapping around four sides of junction box with a min 2 in. overlap at the seam and with the seam sealed with aluminum foil tape layers of mat wrap required on sides of junction box with seams of two layers offset. Cover of junction box covered with min of two layers of mat wrap with each layer lapping min 2 in. on sides of junction box and secured with aluminum foil tape. After installation of all mat layers, mat layers secured with steel banding straps (Item 5C).
3M COMPANY — Types I-10A, M-20A.
 - B. **Aluminum Foil Tape** — (Not Shown) — 4 in. wide, min 3 mil thick pressure-sensitive aluminum foil tape, supplied in rolls. Used to secure seams of mat wrap (Item 5A).
 - C. **Steel Banding Straps** — Min 5/8 in. wide by 0.020 in. thick stainless or carbon steel straps used in conjunction with steel crimp clips. Banding straps used to secure mat wrap layers (Item 5A).
 - D. **Electrical Circuit Protective Materials* — Caulk** — Thick bead of caulk to be applied to perimeter of mat wrap layers at interface with wall or floor. Thick bead of caulk also used to cover seams of intumescent sheets (Item 5F).
3M COMPANY — CP 25WB+

System No. 6 (cont.)

- E. Steel Framing** — (Not Shown) — Steel channels with nominal 1-1/4 in. wide web with 3/4 in. high flanges with the flange edges hemmed for stiffness and to accommodate special mechanical fasteners. The channels shall be formed of min 0.067 in. thick (14 ga) painted or galvanized steel. Steel channels assembled to form a five sided enclosure around the junction box. The steel framing shall be installed such that the minimum clearance between the intumescent sheets (Item 5F) and the junction box is 2 in. The steel framing members shall be assembled by welding or through the use of special fittings in conjunction with 3/8 in. diameter steel bolts with nuts.
- F. Electrical Circuit Protective Materials* — Intumescent Sheets** — Rigid aluminum foil-faced sheets with galvanized steel sheet backer. Installed on steel framing, with aluminum foil face on exterior, to completely enclose junction box. Sheets installed with tightly butted joints at corners of steel framing. Each sheet affixed to steel framing with No. 10-16 by 3/4 in. long self-drilling, self-tapping, hex-washer head steel screws. Butted joints at corners of steel framing sealed with caulk (Item 5D).
- 3M COMPANY** — Type CS-195.
- G. Electrical Circuit Protective Material* — Intumescent Mat** — Flexible sheet material. Installed in conjunction with steel hardware cloth (Item 5H) to cover all joints at corners of intumescent sheet enclosure. Mat strips cut to length to completely cover each butted joint, centered over joint and temporarily held in position with aluminum foil tape (Item 5B).
- 3M COMPANY** — Types I-10A, M-20A.
- H. Steel Hardware Cloth** — Maximum 1/2 in. by 1/2 in. welded mesh of min 0.041 in. diameter (19 SWG) galvanized steel wire. Nom 4 in. wide strip of steel hardware cloth cut to length and installed over each intumescent sheet joint cover (Item 5G). Hardware cloth secured to intumescent sheet (Item 5F), through intumescent mat (Item 5G), with No. 10-16 by 3/4 in. long self-drilling, self-tapping, hex-washer head steel screws in conjunction with min 5/8 in. diam steel washers.

*Bearing the UL Classification Mark

Flexible Wraps

Endothermic Mat

Applied Fireproofing

AF





System No. 7
FHIT - Electrical Circuit Integrity Systems

September 17, 2012

Fire Ratings — 1 and 3 Hr (See Item 5)

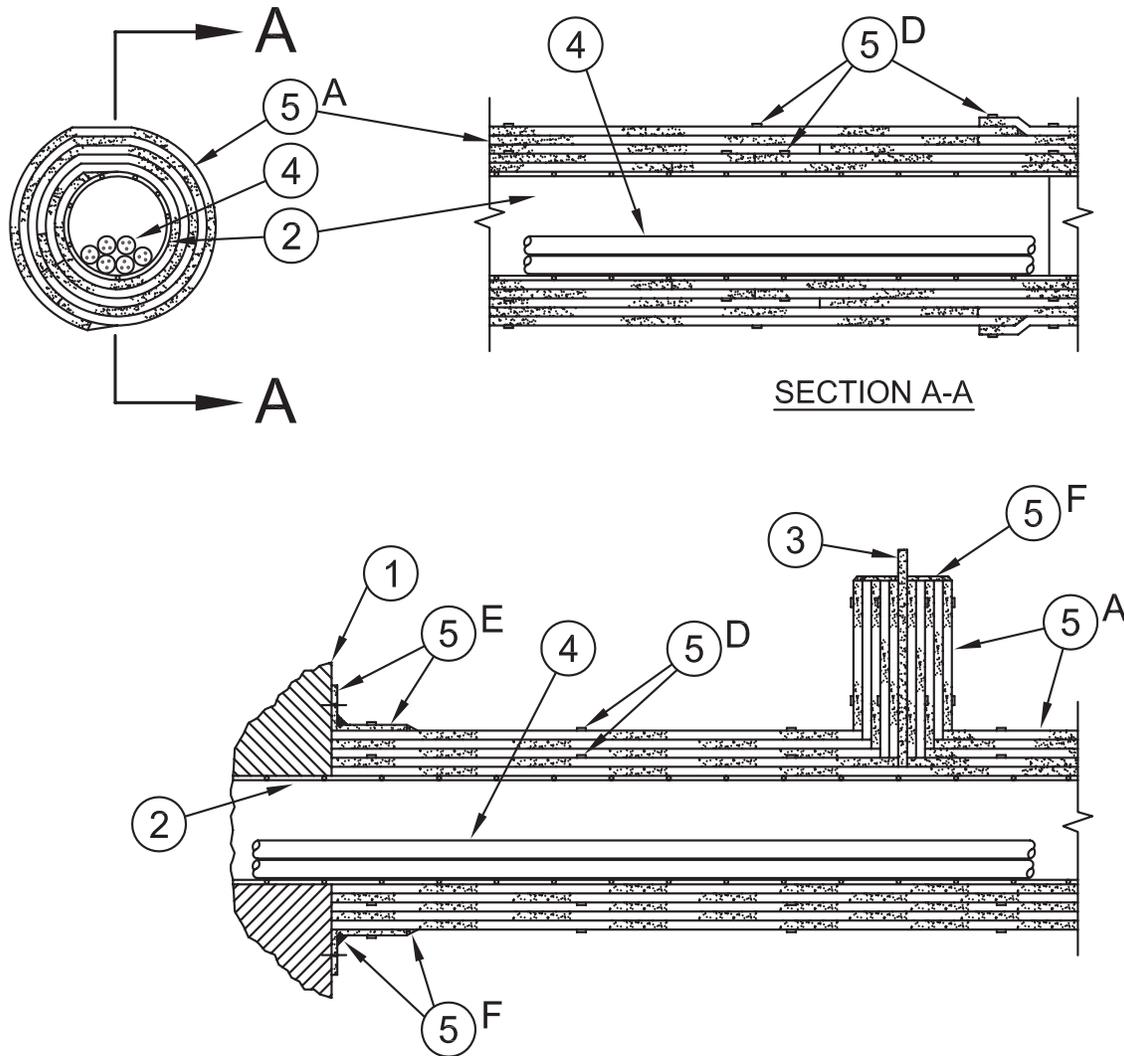

1. **Wall or Floor Assembly** — Concrete or masonry wall or concrete floor having a fire rating equal to or greater than the fire rating of the electrical circuit protective system. Opening in wall or floor through which conduit passes is to be sized to closely follow the contour of the conduit. Through opening in wall or floor to be firestopped prior to installation of the electrical circuit protective system using a compatible firestop system. The perimeter of the firestopped through opening shall be within the outer bounds of the electrical circuit protective system. See Through Penetration Firestop Systems (Guide XHEZ) for presently Classified firestop systems.
2. **Steel Conduit** — Nominal 2 in. (51 mm) diameter (or larger) Trade Size rigid steel conduit. Conduit shall be installed as a complete system in accordance with all provisions of the current National Electrical Code.
3. **Conduit Supports** — Conduit system shall be supported by welded hangers formed of min 0.093 in. (2.4 mm) thick (12 ga) painted or galvanized steel channels, 1-5/8 in. (41 mm) wide by min 1-5/8 in. (41 mm) deep with the flange edges hemmed for stiffness. As an alternate, conduits may be supported by steel pipe hangers in conjunction with min 3/8 in. (10 mm) diameter threaded steel rod.
4. **Cables** — Min No. 16 AWG jacketed multi-conductor cables and/or min 250 kcmil jacketed single-conductor copper power cables. Cable insulation to be cross-linked polyethylene. Cable jacket to be cross-linked polyethylene or polyvinyl chloride. When fillers are used in cable construction, fillers to be hemp, polyvinyl chloride or cross-linked polyethylene. Cables to be installed in accordance with all provisions of the current National Electrical Code.

System No. 7 (cont.)

5. Electrical Circuit Protective System — The electrical circuit protective system consists of a mat wrap, foil tape, stainless steel banding straps, intumescent sheet and caulk. The system shall be installed in accordance with the detailed installation instruction manual supplied by the manufacturer of the Electrical Circuit Protective Materials*. The details of the electrical circuit protective system are summarized below:

A. Electrical Circuit Protective Materials* — Mat Wrap — Nominal 0.4 in. (10 mm) thick flexible sheet material supplied in 24 in. (610 mm) wide rolls. Each layer of mat wrap installed by cutting to size and wrapping around the conduit and itself such that a minimum 2 in. (51 mm) overlap is present along the longitudinal seam. With the exception of the final layer of mat wrap, adjacent lengths of mat wrap in each layer to be installed with tightly-butted end seams. Successive layers of mat wrap installed in same manner with butted end seams offset minimum 2 in. (51 mm) from butted end seams of preceding layer. For final layer of mat wrap, adjacent lengths of mat wrap to overlap the preceding length a minimum of 2 in. (51 mm). All seams in each layer of mat wrap to be sealed with foil tape (Item 5B). Mat wrap layers secured in place with stainless steel banding straps (Item 5D). The hourly fire rating of the electrical circuit protective system is dependent upon the nom diameter of the conduit system and the number of mat wrap layers installed, as shown in the following table:

| Nom Conduit Diam, In. (mm) | Min Layers Required | Hr Fire Rating |
|----------------------------|---------------------|----------------|
| 2 - 4-1/2 (51-114) | 3 | 1 |
| 5- 6 (127-152) | 2 | 1 |
| 2 - 6 (51-152) | 5 | 1 |

3M COMPANY — Types E-5A-4, E-54A, E-54C

B. Foil Tape — (Not Shown) — 4 in. (102 mm) wide min 3 mil (0.08 mm) thick pressure-sensitive aluminum foil tape or min 3 mil (0.08 mm) thick stainless steel foil tape, supplied in rolls. Used to secure seams of mat wrap (Item 5A).

C. Stainless Steel Mesh — (Not Shown) — Woven stainless steel wire mesh, supplied in 42 in. (1.1 m) wide rolls. Stainless steel mesh tightly wrapped around outermost layer of mat wrap and secured in place with steel banding straps (Item 5D) spaced maximum 8 in. (203 mm) OC. Stainless steel mesh not required for 3 Hr rated system.

D. Steel Banding Straps — Min 5/8 in. (16 mm) wide by 0.020 in. (0.51 mm) thick stainless steel straps used in conjunction with stainless steel crimp clips. Banding straps spaced max 8 in. (203 mm) OC to secure stainless steel mesh and final mat wrap layers. For 3 Hr rated system, steel banding straps required to be installed after second mat wrap layer in addition to steel banding straps securing fifth mat wrap layer. Steel banding straps to be installed 1 in. (25 mm) from each side of final layer mat seams.

E. Electrical Circuit Protective Materials* — Intumescent Sheet — Rigid aluminum foil faced sheets with galvanized sheet steel backer. Nom 4 in. (102 mm) wide piece of sheet formed into collar around mat wrapped conduit with seam butted and with steel backer exposed (foil facing against mat wrap). Collar butted against wall or floor surface and secured to mat wrapped conduit with stainless steel banding strap (Item 5D). A two-piece plate cut from intumescent sheet to be installed on wall or floor surface around intumescent sheet collar. Plate pieces cut to tightly follow the contours of the intumescent sheet collar with seams between pieces tightly butted. Plate to lap min 2 in. (51 mm) on the wall or floor surface with the steel backer exposed (foil face against wall or floor surface). Plate secured to wall or floor surface with steel anchor bolts, or equivalent, in conjunction with min 1-1/4 in. (32 mm) diameter steel fender washers. Anchor bolts located max 2 in. (51 mm) from both sides of butted seams and spaced max 4 in. (102 mm) O.C. around perimeter of plate, 1 in. (25 mm) in from plate edges. When butted seams of two-piece plate are not completely backed by concrete, seams to be covered with minimum 2 in. (51 mm) wide strips of minimum 0.016 in. (0.41 mm) thick steel secured with steel screws or rivets spaced maximum 2 in. (51 mm) OC on both sides of seam.

3M COMPANY — Type CS-195+

F. Electrical Circuit Protective Materials* — Caulk — Thick bead of caulk to be applied around the base of the intumescent sheet collar (Item 5E) at its interface with the intumescent sheet plate. Thick bead of caulk applied around entire perimeter of mat wrap at interface with intumescent sheet collar. Top edges of mat wrap layers on conduit support covered with minimum 1/8 in. (3.2 mm) thickness of caulk.

3M COMPANY — CP 25WB+

*Bearing the UL Classification Mark

Flexible Wraps

Endothermic Mat

Applied Fireproofing

AF



September 17, 2012

Fire Ratings — 1 and 3 Hr (See Item 6)

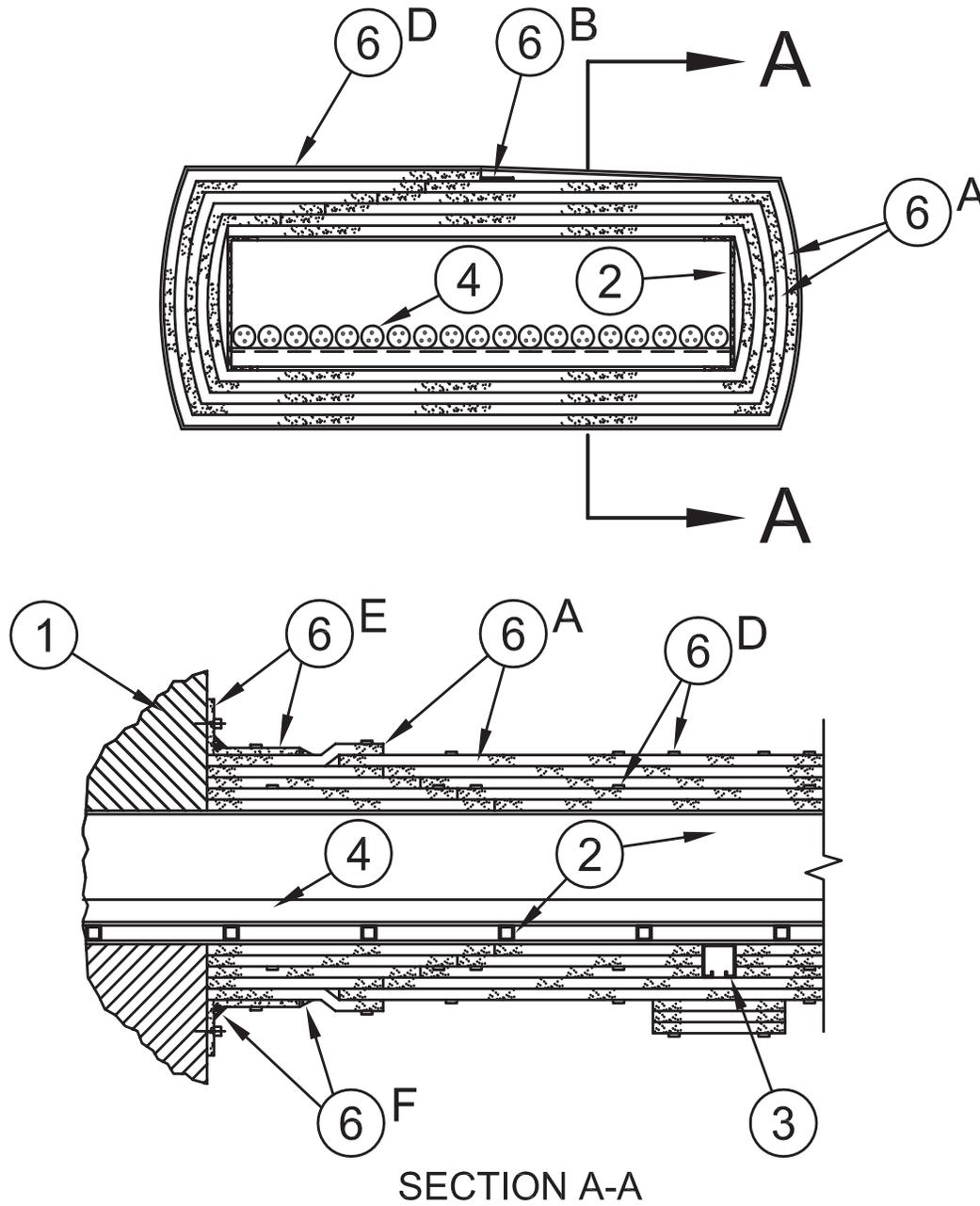

- 1. Wall or Floor Assembly** — Concrete or masonry wall or concrete floor having a fire rating equal to or greater than the fire rating of the electrical circuit protective system. Opening in wall or floor through which cable tray passes is to be sized to closely follow the contour of the cable tray. Through opening in wall or floor to be firestopped prior to installation of the electrical circuit protective system using a compatible firestop system. The perimeter of the firestopped through opening shall be within the outer bounds of the electrical circuit protective system. See **Through Penetration Firestop Systems** (Guide XHEZ) for presently Classified firestop systems.
- 2. Cable Tray** — 24 in. (610 mm) wide, min 4 in. (102 mm) deep, solid bottom or open ladder cable trays. Solid bottom cable trays to be formed of min 0.056 in. (1.4 mm) thick galvanized steel. Open ladder cable trays to consist of channel-shaped side-rails formed of min 0.056 in. (1.4 mm) thick galvanized steel with nom 3/4 in. (19 mm) wide by 1 in. (25 mm) deep boxed channel rungs formed of min 0.029 in. (0.74 mm) thick galvanized steel and spaced 6 in. (152 mm) OC. Cable trays shall be installed as a complete system in accordance with all provisions of the current National Electrical Code.

System No. 8 (cont.)

- 3. Cable Tray Supports** — The cable trays shall be supported by U-shaped welded hangers formed of min 0.093 in. (2.4 mm) thick painted or galvanized steel channels, 1-5/8 in. (41 mm) wide by min 1-5/8 in. (41 mm) deep with the flange edges hemmed for stiffness.
- 4. Cables** — Min No. 16 AWG jacketed multi-conductor cables and/or min 250 kcmil jacketed single-conductor copper power cables. Cable insulation to be cross-linked polyethylene. Cable jacket to be cross-linked polyethylene or polyvinyl chloride. When fillers are used in the cable construction, fillers to be hemp, polyvinyl chloride or cross-linked polyethylene. Cables to be installed in cable trays in accordance with all provisions of the current National Electrical Code.
- 5. Strapping** — (Not Shown) — Nom 1/2 to 1 in. (13 to 25 mm) wide plastic strapping or filament strapping tape. Strapping applied around circumference of cable tray on maximum 12 in. (305 mm) centers to prevent sag of mat wrap layers (Item 6A) into trough of cable tray.
- 6. Electrical Circuit Protective System** — The electrical circuit protective system consists of a mat wrap, foil tape, woven stainless steel wire mesh, stainless steel banding straps, intumescent sheet and caulk. The system shall be installed in accordance with the detailed installation instruction manual supplied by the manufacturer of the **Electrical Circuit Protective Materials***. The details of the electrical circuit protective system are summarized below:
- A. Electrical Circuit Protective Material* — Mat Wrap** — Nom 0.4 in. (10 mm) flexible sheet material supplied in 24 in. (610 mm) wide rolls. Installed by cutting to size and wrapping around the cable tray system with each circumferential wrap lapping itself 2 to 4 in. (51 to 102 mm) over the top of the cable tray. With the exception of the final layer of mat wrap, adjacent lengths of mat wrap in each layer to be installed with tightly-butted end seams. Successive layers of mat wrap installed in same manner with butted end seams offset min 2 in. (51 mm) from butted end seams of preceding layer. For final layer of mat wrap, adjacent lengths of mat wrap to overlap the preceding length a min of 2 in. (51 mm). All seams in each layer of mat wrap to be sealed with aluminum foil tape (Item 6B). Mat wrap layers secured in place with steel banding straps (Item 6D). A min of three layers of mat wrap are required for the 1 Hr fire rating. A min of five layers of mat wrap are required for the 3 hr fire rating.
- 3M COMPANY** — Types E-5A-4, E-54A, E-54C.
- B. Foil Tape** — Nom 4 in. (102 mm) wide min 3 mil (0.08 mm) thick pressure-sensitive aluminum foil tape or nom 4 in. (102 mm) wide min 3 mil (0.08 mm) thick pressure-sensitive stainless steel foil tape, supplied in rolls. Used to secure seams of mat wrap (Item 6A).
- C. Stainless Steel Mesh** — (Optional, Not Shown) — Woven stainless steel wire mesh, supplied in 42 in. (1.1 m) wide rolls. Stainless steel mesh tightly wrapped around outermost layer of mat material and secured in place with stainless steel banding straps (Item 6D) spaced maximum 8 in. (203 mm) O.C.
- D. Steel Banding Strap** — Min 5/8 in. (16 mm) wide by 0.020 in. (0.51 mm) thick stainless steel straps used in conjunction with stainless steel crimp clips. Banding straps spaced max 8 in. (203 mm) O.C. to secure stainless steel mesh and mat wrap layers. For 3 hr rated system, steel banding straps required to be installed after second mat wrap layer in addition to steel banding straps securing stainless steel mesh. Steel banding straps to be installed 1 in. (25 mm) from each side of final layer mat seams.
- E. Electrical Circuit Protective Materials* — Intumescent Sheet** — Rigid aluminum foil-faced sheets with galvanized sheet steel backer. Nom 4 in. (102 mm) wide piece of sheet formed into collar around mat wrapped cable tray and mat wrapped cable air drop (Item 7) with seam butted and with steel backer exposed (foil facing against mat wrap). Collar butted against wall or floor surface and secured to mat wrapped cable tray or cable air drop with stainless steel banding strap (Item 6D). A two-piece plate cut from intumescent sheet to be installed on wall or floor surface around intumescent sheet collar. Plate pieces cut to tightly follow the contours of the intumescent sheet collar with seams between pieces tightly butted. Plate to lap min 2 in. (51 mm) on the wall or floor surface with the steel backer exposed (foil face against wall or floor surface). Plate secured to wall or floor surface with steel anchor bolts, or equivalent, in conjunction with min 1-1/4 in. (32 mm) diameter steel fender washers. Anchor bolts located max 2 in. (51 mm) from both sides of butted seams and max 4 in. (102 mm) O.C. around perimeter of plate, 1 in. (25 mm) in from plate edges. When butted seams of two-piece plate are not completely backed by concrete, seams to be covered with min 2 in. (51 mm) wide strips of min 0.016 in. (0.41 mm) thick galvanized steel secured with steel screws or rivets spaced max 2 in. (51 mm) O.C. on both sides of seam.
- 3M COMPANY** — Type CS-195+
- F. Electrical Circuit Protective Materials* — Caulk** — Thick bead of caulk to be applied around the base of the intumescent sheet collar (Item 6E) at its interface with the intumescent sheet plate. Thick bead of caulk applied around perimeter of mat wrap at interface with intumescent sheet collar. Top edges of mat wrap layers on cable tray supports covered with min 1/8 in. (3.2 mm) thickness of caulk.
- 3M COMPANY** — CP 25WB+
- 7. Cable Air Drop** — (Not Shown) — Cable passing from one fire rated cable tray protective system to another fire rated cable tray protective system, through the air, to be protected with a fire rated electrical circuit protective system consisting of a mat wrap, foil tape, stainless steel banding straps or ceramic cord and caulk or putty. The system shall be installed in accordance with the detailed installation instruction manual supplied by the manufacturer of the Electrical Circuit Protective Materials*. The details of the electrical circuit protective system are summarized below:
- A. Electrical Circuit Protective Materials* — Mat Wrap** — Nom 0.4 in. (10 mm) flexible sheet material supplied in 24 in. (610 mm) wide rolls. Mat wrap installed by cutting to size and wrapping around cable bundle with each circumferential wrap lapping itself min 2 in. (51 mm). With the exception of the final layer of mat wrap, adjacent lengths of mat wrap in each layer to be installed with tightly-butted end seams. Successive layers of mat wrap installed in same manner with butted end seams offset min 2 in. (51 mm) from butted end seams of preceding layer. For final layer of mat wrap, adjacent lengths of mat wrap to overlap the preceding length a min of 2 in. (51 mm). All seams in each layer of mat wrap to be sealed with foil tape (Item 7B). Mat wrap layers secured in place with stainless steel banding straps (Item 7C). A min of three layers of mat material is required for a 1 hr fire rating. A min of five layers of mat material is required for a 3 hr fire rating.
- 3M COMPANY** — Types E-5A-4, E-54A, E-54C.

Flexible Wraps

Endothermic Mat

Applied Fireproofing

AF

System No. 8 (cont.)

- B. Foil Tape** — Nom 4 in. (102 mm) wide min 3 mil (0.08 mm) thick pressure-sensitive aluminum foil tape or min 3 mil (0.08 mm) thick stainless steel foil tape, supplied in rolls. Used to secure seams of mat wrap (Item 7A).
- C. Steel Banding Straps** — Min 5/8 in. (16 mm) wide by 0.020 in. (0.51 mm) thick stainless steel straps used in conjunction with stainless steel crimp clips. Banding straps spaced max 8 in. (203 mm) OC to secure mat wrap layers. For 1 hr fire rated system, steel banding straps required to be installed on outermost mat wrap layer. For 3 hr fire rated system, steel banding straps required to be installed after second mat wrap layer in addition to steel banding straps securing outermost mat wrap layer.
- D. Stainless Steel Wire** — As an alternate to the steel banding straps (Item 7C) for the 1 hr fire rated system only, min 0.046 in. (1.12 mm) diam (18 ga) stainless steel wire spiral-wrapped around outermost layer of mat wrap at a maximum spacing of 2 in. (51 mm) OC. Wire covered with aluminum foil tape (Item 7B).
- E. Electrical Circuit Protective Materials* — Caulk** — Thick bead of caulk to be applied around the perimeter of the mat wrap on the cable air drop at each interface with the cable tray protective system.
3M COMPANY — CP 25WB+

*Bearing the UL Classification Mark

Flexible Wraps

Endothermic Mat

Applied Fireproofing

AF



September 17, 2012

Fire Ratings — 1 and 3 Hr

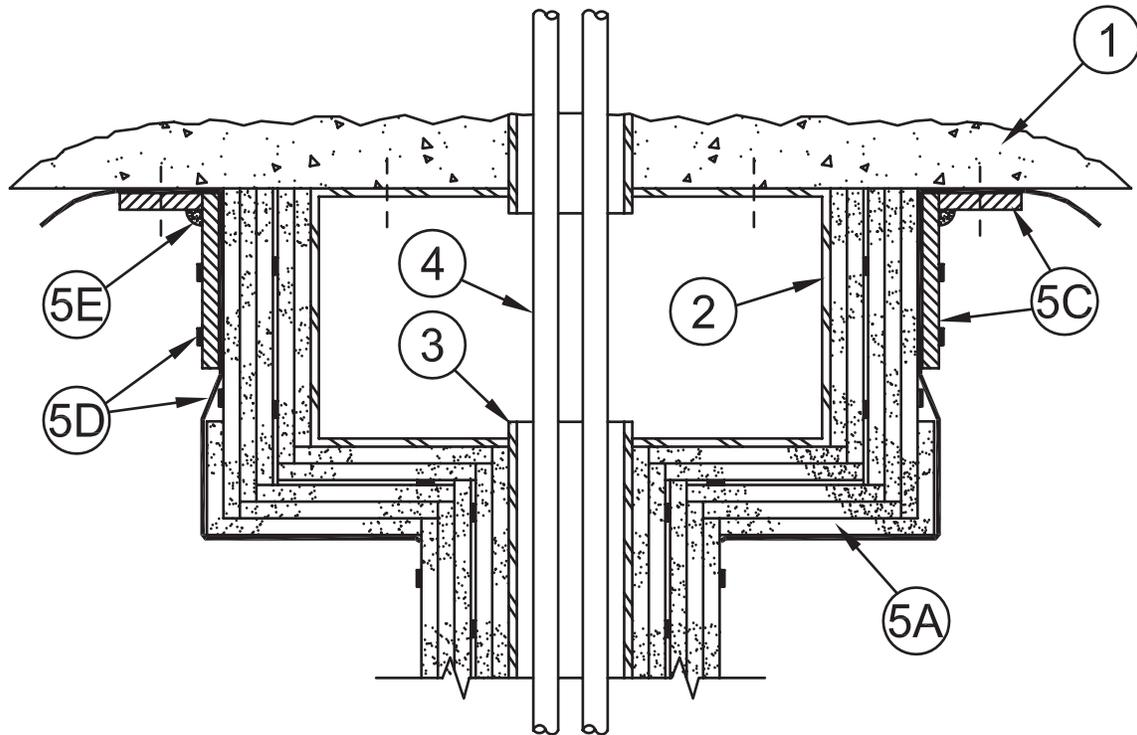

1. **Wall or Floor Assembly** — Concrete or masonry wall or concrete floor having a fire rating equal to or greater than the fire rating of the electrical circuit protective system. Opening in wall or floor through which conduit passes is to be sized to closely follow the contour of the conduit feeding into the steel junction box. Through opening in wall or floor to be firestopped prior to installation of the electrical circuit protective system using a compatible firestop system. The perimeter of the firestopped through opening shall be within the outer bounds of the electrical circuit protective system. See **Through Penetration Firestop Systems** (Guide XHEZ) for presently Classified firestop systems.
2. **Steel Junction Box** — Min 12 by 12 by 6 in. (305 by 305 by 152 mm) deep surface-mounted junction box formed of min 0.052 in. (1.3 mm) thick steel. Steel junction box to be installed in accordance with all provisions of the current National Electrical Code.
3. **Steel Conduit** — (Optional) — Nom 2 in. (51 mm) diameter (or larger) Trade Size rigid steel conduit. Conduits to be installed as a complete system in accordance with all provisions of the current National Electrical Code. Conduit to be provided with a fire rated electrical circuit protective system which is compatible with the electrical circuit protective system (Item 5) installed on the steel junction box. Details of electrical circuit protective system at conduit/junction box interface to be in accordance with the detailed installation instruction manual supplied by the manufacturer of the **Electrical Circuit Protective Materials***.
4. **Cables** — Min No. 16 AWG jacketed multi-conductor cables and/or min 250 kcmil jacketed single-conductor copper power cables. Cable insulation to be cross-linked polyethylene. Cable jacket to be cross-linked polyethylene or polyvinyl chloride. Cables to be installed in accordance with all provisions of the current National Electrical Code.
5. **Electrical Circuit Protective System** — The electrical circuit protective system consists of an endothermic mat wrap, foil tape, intumescent sheet, stainless steel banding straps and caulk. The system shall be installed in accordance with the detailed installation instruction manual supplied by the manufacturer of the **Electrical Circuit Protective Materials***. The details of the electrical circuit protective system are summarized below:
 - A. **Electrical Circuit Protective Materials* — Mat Wrap** — Nom 0.4 in. (10 mm) flexible sheet material supplied in 24 in. (610 mm) wide rolls. Pieces of mat cut to size to cover all exposed surfaces of junction box with min 2 in. (51 mm) overlap at all seams. As an alternate for the 3 hr fire rated system, the inner mat layers may be installed in a boxed manner such that the overlap at each seam is equal to the thickness of the mat. The final layer of mat must be installed with a min 2 in. (51 mm) overlap at all seams. Successive layers of mat installed in same manner with overlapping seams offset from preceding layer. Seams of each layer sealed with foil tape (Item 5B). Mat wrap layers secured in place with stainless steel banding straps (Item 5D). A min of three layers of mat is required for 1 hr rating. A min of five layers of mat is required for 3 hr rating.

3M COMPANY — Types E-5A-4, E-54A, E-54C.

System No. 9 (cont.)

- B. Foil Tape** — (Not Shown) — Nom 4 in. (102 mm) wide min 3 mil (0.08 mm) thick pressure sensitive aluminum foil tape or min 3 mil (0.08 mm) thick stainless steel foil tape, supplied in rolls. Used to secure seams of mat wrap (Item 5A).
- C. Electrical Circuit Protective Materials* — Intumescent Sheet** — Rigid aluminum foil faced sheets with galvanized steel sheet backer. Nom 4 in. (102 mm) wide piece of sheet formed into collar around mat wrapped junction box with seam butted and with steel backer exposed (foil facing against mat wrap). Collar butted against wall or floor surface and secured to mat wrapped junction box with steel banding strap (Item 5D). A two-piece plate cut from intumescent sheet to be installed on wall or floor surface around intumescent sheet collar. Plate pieces cut to tightly follow the contours of the intumescent sheet collar with seams between pieces tightly butted. Plate to lap min 2 in. (51 mm) on the wall or floor surface with the steel backer exposed (foil face against wall or floor surface). Plate secured to wall or floor surface with steel anchor bolts, or equivalent, in conjunction with min 1-1/4 in. (32 mm) diameter steel fender washers. Anchor bolts located max 2 in. (51 mm) from both sides of butted seams and max 4 in. (102 mm) O.C. around perimeter of plate, 1 in. (25 mm) in from plate edges. When butted seams of two-piece plate are not completely backed by concrete, seams to be covered with min 2 in. (51 mm) wide strips of min 0.016 in. (0.41 mm) thick galvanized steel secured with steel screws or rivets spaced max 2 in. (51 mm) O.C. on both sides of seam.

3M COMPANY — Type CS-195+

- D. Steel Banding Strap** — Min 5/8 in. (16 mm) wide by 0.020 in. (0.51 mm) thick stainless steel banding straps used in conjunction with stainless steel crimp clips. Banding straps used to secure intumescent sheet collar (Item 5C) and mat wrap (Item 5A) layers in position. For the 1 hr rated system, steel banding straps required to be installed on outermost mat wrap layer. For 3 hr rated system, steel banding straps required to be installed after second mat wrap layer in addition to steel banding straps securing outermost mat wrap layer.
- E. Electrical Circuit Protective Materials* — Caulk** — Thick bead of caulk to be applied as a gasket between the intumescent sheet plate (Item 5C) and the wall or floor surface. Thick bead of caulk to be applied around the base of the intumescent sheet collar (Item 5C) at its interface with the intumescent sheet plate.

3M COMPANY — Type CP 25WB+

*Bearing the UL Classification Mark

Flexible Wraps

Endothermic Mat

Applied Fireproofing

AF



September 17, 2012

Fire Rating - 2 Hr.

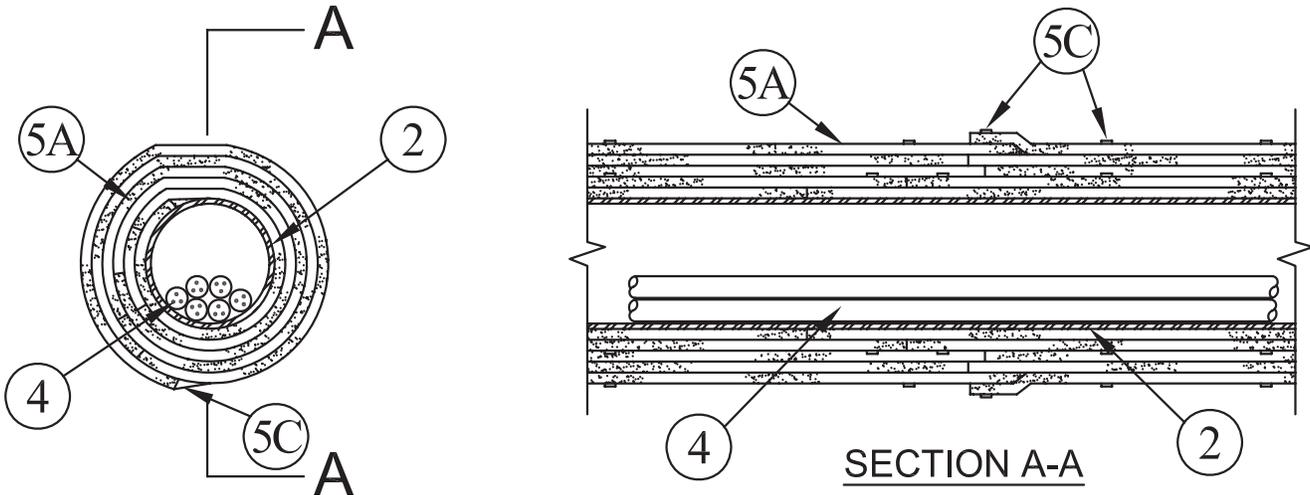

1. **Wall or Floor Assembly** — (Not Shown) - Concrete or masonry wall or concrete floor having a fire rating equal to or greater than the fire rating of the electrical circuit protective system. Diam of opening in wall or floor through which conduit passes is to be max 1-1/2 in. (38 mm) larger than the outside diam of the conduit. Conduit installed eccentrically or concentrically in the opening with a min 0 in. (point contact) to max 3/4 in. (19 mm) annular space. Through opening in wall or floor to be firestopped prior to installation of the electrical circuit protective system using min 4 pcf (64 kg/m³) mineral wool batt packing material throughout the thickness of the floor or wall except for a recess at each surface to accommodate the caulk fill material (Item 5D). A min 1/2 in. (13 mm) depth of caulk fill material (Item 5D) is required to be installed in the annular space flush with each surface of the floor or wall assembly. The perimeter of the firestopped through opening shall be within the outer bounds of the electrical circuit protective system.
2. **Steel Conduit** — Nominal 4 in. (102 mm) to 6 in. (152 mm) Trade Size rigid steel conduit. Conduit shall be installed as a complete system in accordance with all provisions of the current National Electrical Code.
3. **Conduit Supports** — (Not Shown) - Conduit system shall be supported by steel pipe hangers in conjunction with min 3/8 in. (10 mm) diameter threaded steel rod.
4. **Cables** — Min No. 16 AWG jacketed multi-conductor cables and/or min No. 12 AWG single-conductor copper power cables. Cables to be installed in conduit in accordance with all provisions of the current National Electrical Code.
5. **Electrical Circuit Protective System** — The electrical circuit protective system consists of a mat wrap, foil tape, stainless steel banding straps and caulk. The system shall be installed in accordance with the detailed installation instruction manual supplied by the manufacturer of the Electrical Circuit Protective Materials*. The details of the electrical circuit protective system are summarized below:
 - A. **Electrical Circuit Protective Materials* — Mat Wrap** — Nom 0.4 in. (10 mm) flexible sheet material supplied in 24 in. (610 mm) wide rolls. A min of four layers of mat wrap are required. Each layer of mat wrap installed by cutting to size and wrapping around the conduit and itself such that a min 2 in. (51 mm) overlap is present along the longitudinal seam. With the exception of the final layer of mat wrap, adjacent lengths of mat wrap in each layer to be installed with tightly-butted end seams. Successive layers of mat wrap installed in same manner with butted end seams offset min 2 in. (51 mm) from butted end seams of preceding layer. For final layer of mat wrap, adjacent lengths of mat wrap to overlap the preceding length by a min of 2 in. (51 mm). All seams in each layer of mat wrap to be sealed with foil tape (Item 5B). Mat wrap layers secured in place with stainless steel banding straps (Item 5C) on outermost layer.

3M COMPANY 3M FIRE PROTECTION PRODUCTS — Type E-5A-4, E-54A or E-54C
 - B. **Foil Tape** — (Not Shown) — 4 in. (102 mm) wide min 3 mil (0.08 mm) thick pressure-sensitive aluminum foil or stainless steel foil tape, supplied in rolls. Used to secure seams of mat wrap (Item 5A).
 - C. **Steel Banding Straps** — Min 1/2 in. (13 mm) wide by 0.020 in. (0.5 mm) thick stainless steel straps used in conjunction with stainless steel crimp clips. Banding straps spaced max 8 in. (203 mm) OC to secure mat wrap layers.
 - D. **Electrical Circuit Protective Materials* — Caulk** — (Not Shown) - Thick bead of caulk applied around entire perimeter of each layer of mat wrap at its interface with the firestop system and the floor or wall surface. Any joint between the adjacent layers of mat wrap that exceed 1/16 in. (1.6 mm) in width shall be filled with caulk. Each layer of E-Mat on the conduit supports abutting the mat wrap on the conduit shall also be sealed with caulk.

3M COMPANY 3M FIRE PROTECTION PRODUCTS — CP 25WB+

*Bearing the UL Classification Mark

**Bearing the UL Listing Mark





Design Number 3MU/AF 60-06

(Formerly Design ECP 531)

30-Aug-12

APPLIED FIREPROOFING

3M Company

3M™ Interam™ E-5, E-54-A and E-5A-4 Series Endothermic Mat

3M Fire Barrier CP 25WB+ Caulk

IEEE 848

Rating: Ampacity Derating – 49.9%

Reference Intertek Design Listing 3MU/AF 60-01 for Fire Resistance Ratings

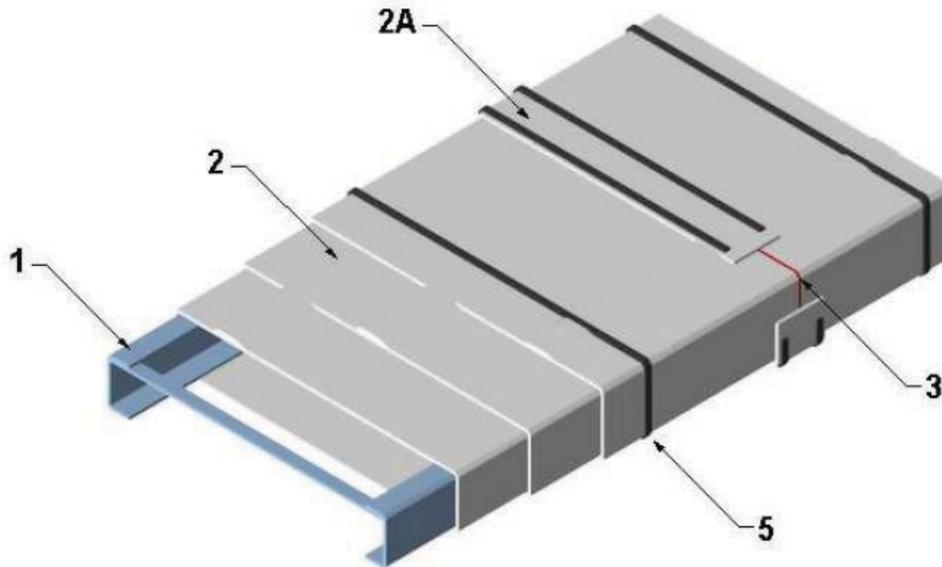

- 1. Cable Tray:** Use nominal 24 in. wide x 4 in. deep galvanized steel ladderback cable tray. Friction fit nominal 13/16 in. wide x 13/32 in. deep, 18 GA galvanized steel struts between side rails spaced 12 in. on center (oc) along the length of the cable tray. Use filament tape for additional support if needed.
- 2. Certified Manufacturer:** 3M Company
Certified Product: Applied Fireproofing
Model: 3M™ Interam™ E-5, E-54-A and E-5A-4 Series Endothermic Mat
Endothermic Mat: Install 3 layers of foil faced flexible mat tightly around the cable tray (Item 1). Install each piece of mat with a minimum 2 in. overlap onto itself and temporarily hold in place using filament tape if needed.
A. Collar: Install nominal 4 in. wide strip of endothermic mat (Item 2) around outer layer of the wrapped cable tray (Item 1). Center collar over butt joints over outer layer and secure using steel banding (Item 5).
- 3. Certified Manufacturer:** 3M Company
Certified Product: Caulk or Sealant
Model: 3M™ Fire Barrier CP 25WB+ Caulk
Caulk: Install caulk between butt joints of endothermic mat (Item 2) on all layers. Alternative use is to fill gaps and voids along seams greater than 1/8 in. wide.
- 4. Tape:** (Not Shown) Apply 4 in. wide pressure sensitive tape with aluminum foil facing to all exposed edges of the collar (Item 2A) as well as the longitudinal (overlap) joints of the endothermic mat (Item 2) on the outer layer.
- 5. Steel Banding:** Install 1/2 in. wide x 0.020 in. thick stainless steel banding on the outer layer of the endothermic mat (Item 2). Install banding within 1 in. of the edge of collars (Item 2A) and butt joints and maximum 12 in. oc at all other locations.

This material was extracted and drawn by 3M Fire Protection Products from the 2018 Product Directory, © Intertek





Design Number 3MU/AF 60-07

(Formerly Design ECP 532)

30-Aug-12

APPLIED FIREPROOFING

3M Company

3M™ Interam™ E-5, E-54-A and E-5A-4 Series Endothermic Mat

3M™ Fire Barrier CP 25WB+ Caulk

IEEE 848

Ampacity Derating:

1 in. conduit – 8%

4 in. conduit – 9%

Reference Intertek Design Listing 3MU/AF 60-03 for Fire Resistance Ratings

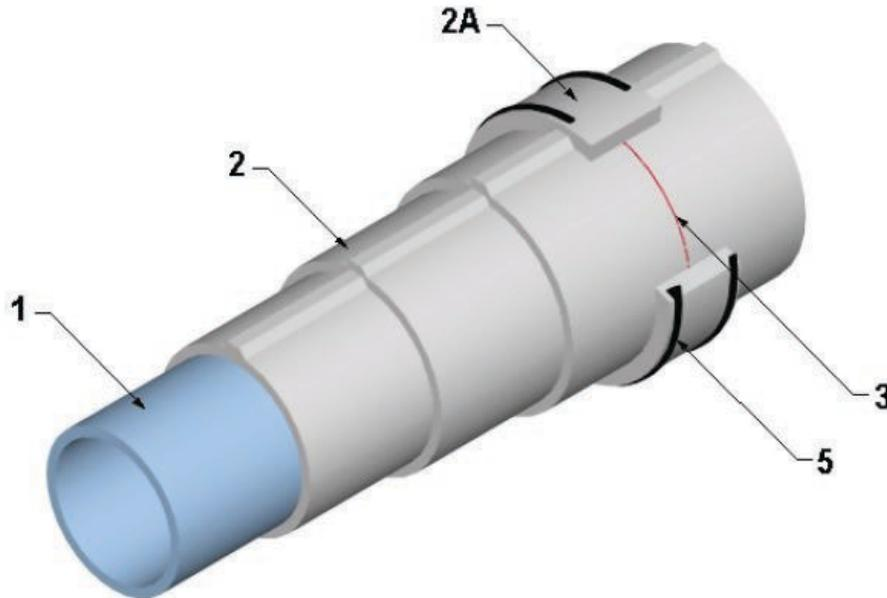

- 1. Conduit:** Use minimum 1 in. (or larger) rigid galvanized steel conduit.
- 2. Certified Manufacturer:** 3M Company
Certified Product: Applied Fireproofing
Model: 3M™ Interam™ E-5, E-54-A and E-5A-4 Series Endothermic Mat
Endothermic Mat: Install 4 layers of foil faced flexible mat tightly around the conduit (Item 1). Install each piece of mat with a minimum 2 in. overlap onto itself and temporarily hold in place using filament tape if needed.
A. Collar: Install nominal 4 in. wide strip of endothermic mat (Item 2) around outer layer of the wrapped conduit (Item 1). Center collar over butt joints over outer layer and secure using steel banding (Item 5).
- 3. Certified Manufacturer:** 3M Company
Certified Product: Caulk or Sealant
Model: 3M™ Fire Barrier CP 25WB+ Caulk
Caulk: Install caulk between butt joints of endothermic mat (Item 2) on all layers. Alternative use is to fill gaps and voids along seams greater than 1/8 in. wide.
- 4. Tape:** (Not Shown) Apply 4 in. wide pressure sensitive tape with aluminum foil facing to all exposed edges of the collar (Item 2A) as well as the longitudinal (overlap) joints of the endothermic mat (Item 2) on the outer layer.
- 5. Steel Banding:** Install 1/2 in. wide x 0.020 in. thick stainless steel banding on the outer layer of the endothermic mat (Item 2). Install banding within 1 in. of the edge of collars (Item 2A) and butt joints and maximum 12 in. oc at all other locations.

This material was extracted and drawn by 3M Fire Protection Products from the 2018 Product Directory, © Intertek



System No. TB-7

January 15, 2014

Rating – 1/4 Hr., 1/2 Hr., 1 Hr. (See Item 5A)

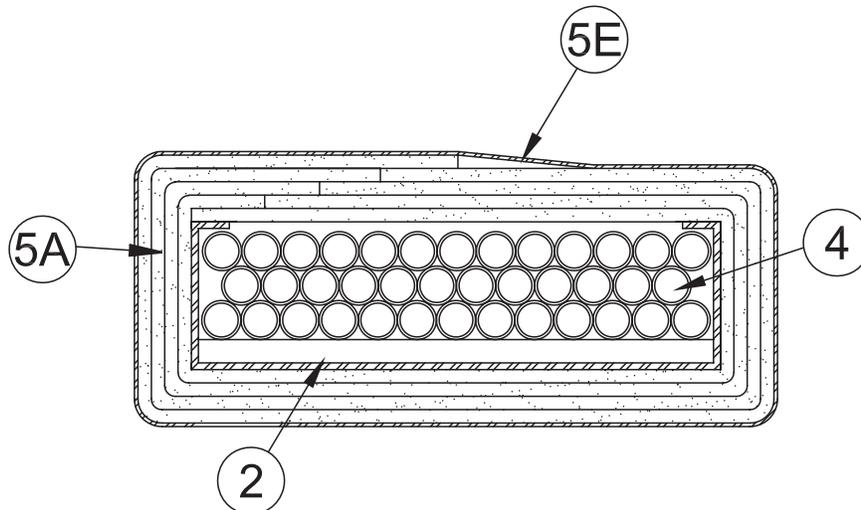

System tested using Rapid-Temperature Rise Test Methods in ASTM E 1529-10 and UL 1709-2007 (R2011).

- Wall or Floor Assembly** – (Not shown)–Concrete or masonry wall or floor. Through opening in wall or floor to be firestopped using a Classified firestop system. See Through-Penetration Firestop Systems (XHEZ) in Volume 2 of the Fire Resistance Directory for Classified firestop systems.
- Cable Tray** – Nom 12 in. (305 mm) wide by min 4 in. (102 mm) deep open-ladder galv steel cable tray with channel-shaped side rails flanged inward or outward and with nom 1 in. (25 mm) high boxed-channel rungs spaced max 9 in. (229 mm) OC. Cable trays shall be installed as a complete system in accordance with all provisions in the National Electrical Code (NFPA 70).
- Cable Tray Supports** – (Not Shown) – The cable trays shall be supported by U-shaped welded hangers formed of min 0.093 in. (2.4 mm) thick painted or galvanized steel channels, 1-5/8 in. (41 mm) wide by min 1-5/8 in. (41 mm) deep with the flange edges hemmed for stiffness.
- Cables** – Cables to be installed in accordance with all provisions in the National Electrical Code (NFPA 70).
- Thermal Barrier System** – The thermal barrier system consists of an aluminum faced blanket, caulk, filament tape, aluminum foil tape and stainless steel banding straps with wing clips. The thermal barrier system shall be installed on the cable tray and supports in accordance with the manufacturer’s detailed instructions accompanying the **Batts and Blankets*** and as summarized below:
 - Batts and Blankets*** – Nom 0.4 in. (10 mm) thick endothermic blanket supplied in nom 24-1/2 in. (622 mm) wide rolls. Blanket installed by cutting-to-length and tightly wrapping around the cable tray with a min 2 in. (50 mm) circumferential overlap and butt perimeter seams. Subsequent layers are to be offset min 2 in. (51 mm). A min of two, three or four layers is required for 1/4, 1/2 and 1 Hr. systems, respectively. Blanket installed on cable tray supports by cutting-to-length and tightly wrapping around each support member with a min 2 in. (51 mm) circumferential overlap. The blanket should extend past the end of the cable tray support and be capped with a piece of blanket cut-to-size. Subsequent layers are to be offset min 2 in. (51 mm).

3M COMPANY

3M FIRE PROTECTION PRODUCTS – Endothermic Mat/Blanket Type E-5A-4

- Fill, Void or Cavity Materials*** – (Not Shown) – Caulk used to seal any joint or seam gap greater than 1/4 in. (6 mm) on the outer blanket layer. Additionally used over the blanket caps wrapped around the cable tray supports.

3M COMPANY

3M FIRE PROTECTION PRODUCTS – CP-25WB+ Caulk or FB-3000 WT Sealant

- Filament Tape** – (Not Shown) - Nom 3/4 in. (19 mm) wide pressure-sensitive tape supplied in rolls. Used during installation to temporarily secure the blankets in place before final compression and permanent attachment with banding (Item 5E). Minimally to be wrapped around the entire circumference of each installed blanket within 2 in. (51 mm) of each joint edge.
- Aluminum Foil Tape** – (Not Shown) - Nom 4 in. (102 mm) wide pressure-sensitive aluminum foil tape supplied in rolls. Used over all joints, seams and any location filled with caulk or sealant (Item 5B).
- Banding** – Min 0.020 in. (0.5 mm) thick by 1/2 in. (13 mm) wide Type 304 stainless steel banding installed over the outer layer of blanket material and cable tray supports. The bands are to be minimally placed 1-2 in. (25-50 mm) above and below each joint and at the midpoint of any blanket with a length greater than 12 in. (305 mm). Banding to be ratchet-tightened and secured with stainless steel wing clips.

*Bearing the UL Classification Mark

Reprinted from the Online Certifications Directory with permission from UL
© 2014 UL LLC

Flexible Wraps

Endothermic Mat

Structural Protection

TB

System No. TB-10

December 31, 2014

Rating - 1/4 Hr., 1/2 Hr., 1 Hr. (See Item 5A)

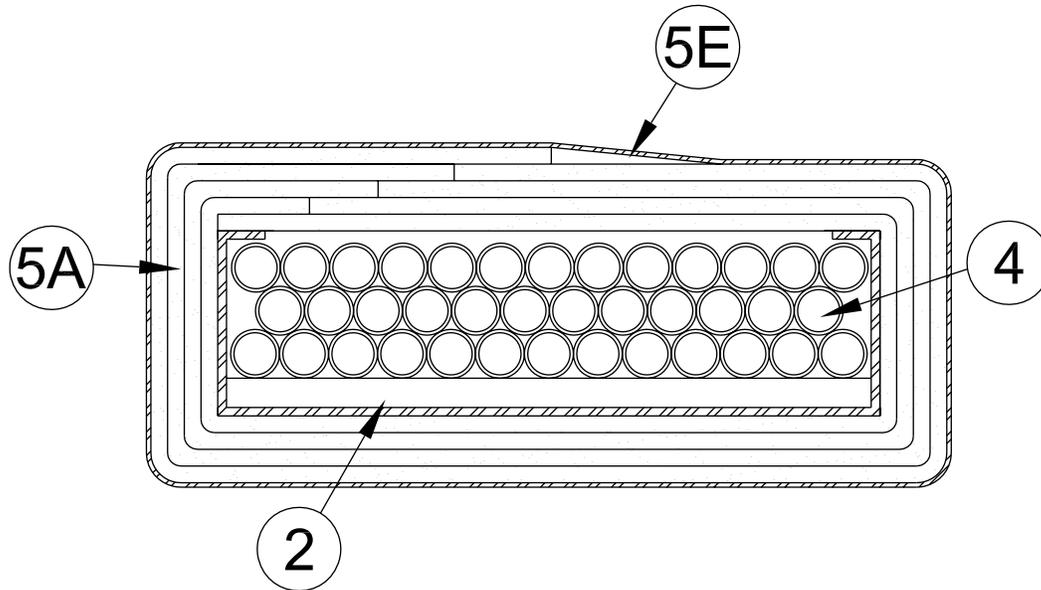

System tested using rapid-temperature-rise test methods in ASTM E1529 (2010) and/or UL 1709 (2007).

1. **Wall or Floor Assembly** — (Not shown) — Concrete or masonry wall or floor. Through opening in wall or floor to be firestopped using a Classified firestop system. See Through-Penetration Firestop Systems (XHEZ) in Volume 2 of the Fire Resistance Directory for Classified firestop systems.
2. **Cable Tray** — Nom 12 in. (305 mm) wide by min 4 in. (102 mm) deep open-ladder galv steel cable tray with channel-shaped side rails flanged inward or outward and with nom 1 in. (25 mm) high boxed-channel rungs spaced max 9 in. (229 mm) OC. Cable trays shall be installed as a complete system in accordance with all provisions in the National Electrical Code (NFPA 70).
3. **Cable Tray Supports** — (Not Shown) — The cable trays shall be supported by U-shaped welded hangers formed of min 0.093 in. (2.4 mm) thick painted or galvanized steel channels, 1-5/8 in. (41 mm) wide by min 1-5/8 in. (41 mm) deep with the flange edges hemmed for stiffness.
4. **Cables** — Cables to be installed in accordance with all provisions in the National Electrical Code (NFPA 70).
5. **Thermal Barrier System** — The thermal barrier system consists of an aluminum faced blanket, caulk, filament tape, aluminum foil tape and stainless steel banding straps with wing clips. The thermal barrier system shall be installed on the cable tray and supports in accordance with the manufacturer's detailed instructions accompanying the **Batts and Blankets*** and as summarized below:
 - A. **Batts and Blankets*** — Nom 0.4 in. (10 mm) thick endothermic blanket supplied in nom 24-1/2 in. (622 mm) wide rolls. Blanket installed by cutting-to-length and tightly wrapping around the cable tray with a min 2 in. (50 mm) circumferential overlap and butt perimeter seams. Subsequent layers are to be offset min 2 in. (51 mm). A min of two, three or four layers is required for 1/4, 1/2 and 1 Hr. systems, respectively. Blanket installed on cable tray supports by cutting-to-length and tightly wrapping around each support member with a min 2 in. (51 mm) circumferential overlap. The blanket should extend past the end of the cable tray support and be capped with a piece of blanket cut-to-size. Subsequent layers are to be offset min 2 in. (51 mm).

3M COMPANY 3M FIRE PROTECTION PRODUCTS — Endothermic Mat/Blanket Type ES-5A-12
 - B. **Fill, Void or Cavity Materials*** — (Not Shown) — Caulk used to seal any joint or seam gap greater than 1/4 in. (6 mm) on the outer blanket layer. Additionally used over the blanket caps wrapped around the cable tray supports.

3M COMPANY 3M FIRE PROTECTION PRODUCTS — CP-25WB+ Caulk or FB-3000 WT Sealant
 - C. **Filament Tape** — (Not Shown) — Nom 3/4 in. (19 mm) wide pressure-sensitive tape supplied in rolls. Used during installation to temporarily secure the blankets in place before final compression and permanent attachment with banding (Item 5E). Minimally to be wrapped around the entire circumference of each installed blanket within 2 in. (51 mm) of each joint edge.
 - D. **Aluminum Foil Tape** — (Not Shown) — Nom 4 in. (102 mm) wide pressure-sensitive aluminum foil tape supplied in rolls. Used over all joints, seams and any location filled with caulk or sealant (Item 5B).
 - E. **Banding** — Min 0.020 in. (0.5 mm) thick by 1/2 in. (13 mm) wide Type 304 stainless steel banding installed over the outer layer of blanket material and cable tray supports. The bands are to be minimally placed 1-2 in. (25-50 mm) above and below each joint and at the midpoint of any blanket with a length greater than 12 in. (305 mm). Banding to be ratchet-tightened and secured with stainless steel wing clips.

*Bearing the UL Classification Mark

Reprinted from the Online Certifications Directory with permission from UL
© 2014 UL LLC

Flexible Wraps

Endothermic Mat

Structural Protection

TB



Design Number 3MU/AF 120-03

March 6, 2018
3M Company
Applied Fireproofing
Galvanized Steel Cable Tray
3M™ Interam™ ES-5A-12 Series Endothermic Mat – 3 Layers
ISO 22899-1
Temperature Rise 16°C – Time 15 minutes
Temperature Rise 71°C – Time 30 minutes
Temperature Rise 77°C – Time 45 minutes
Temperature Rise 117°C – Time 60 minutes
Temperature Rise 215°C – Time 90 minutes
Temperature Rise 328°C – Time 120 minutes

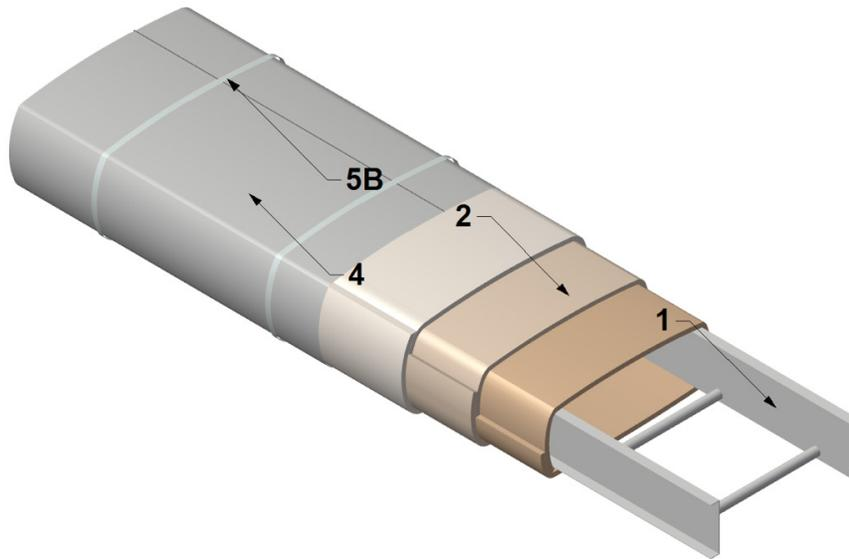

Figure 1. Cable Tray Protection

- CABLE TRAY:** Use galvanized steel ladder-back cable tray with min. dimensions of 102mm (4 in.) high × 305mm wide (12 in.).
- CERTIFIED MANUFACTURER:** 3M Company
CERTIFIED PRODUCT: Applied Fireproofing
CERTIFIED MODEL: 3M™ Interam™ ES-5A-12 Series Endothermic Mat
ENDOTHERMIC MAT: Install three layers of foil-faced flexible Endothermic Mat, wrapped tightly around the cable tray (Item 1) with the foil facing away from the cable tray. Ensure a min. 50mm (2 in.) overlap onto itself at end of wrap. Temporarily affix sections of Endothermic Mat with filament tape if needed. Install each additional layer in the same manner, ensuring the seams between layers are offset a min. of 50mm (2 in.).
- ALUMINUM TAPE (Not Shown):** Apply 102mm (4 in.) wide pressure sensitive tape with aluminum foil-facing to all joints of each layer of the Endothermic Mat (Item 2).
- STEEL SHEATHING:** Install a one layer of min. 0.48mm (26 GA, 0.0156 in.) T-304 stainless steel sheathing over the Endothermic Mat (Item 2) with min. 76mm (3 in.) overlap at joints to create a stepped surface installation.
- STEEL BANDING (Not Shown):** Apply 13mm (1/2 in.) wide by 0.5mm (0.02 in.) thick stainless steel banding as follows:
 - (Not Shown) Following the installation of the outer layer of the Endothermic Mat (item 2), install bands a max. of 400mm (16 in.), on center (oc) and 40mm (1-1/2 in.) from the ends of the Endothermic Mat.
 - Following the installation of the stainless steel sheathing (Item 4), install bands a max. of 400mm (16 in.) oc and 40mm (1-1/2 in.) from the ends of the sheathing.

This material was extracted and drawn by 3M Fire Protection Products from the 2018 Product Directory, © Intertek



Design Number 3MU/AF 120-05

August 15, 2018
 3M Company
 Applied Fireproofing
 Aluminum Cable Tray
 3M™ Interam™ E-5A-4 Series Endothermic Mat
 ISO 22899-1, Determination of the Resistance to
 Jet Fires of Passive Fire Protection Materials
 Ratings: See Table 1

| 2 Layers | 4 Layers | 6 Layers | Max. Temperature Rise |
|----------|----------|----------|-----------------------|
| 73.6 °C | 4.1 °C | 1.7 °C | Temp Rise @ 10 min |
| 91.0 °C | 14.1 °C | 5.2 °C | Temp Rise @ 15 min |
| 116.4 °C | 68.0 °C | 9.1 °C | Temp Rise @ 20 min |
| 200.6 °C | 83.0 °C | 18.1 °C | Temp Rise @ 30 min |
| N/A | 84.8 °C | 77.5 °C | Temp Rise @ 45 min |
| N/A | 103.2 °C | 83.8 °C | Temp Rise @ 60 min |
| N/A | 205.7 °C | 88.3 °C | Temp Rise @ 90 min |
| N/A | N/A | 95.2 °C | Temp Rise @ 120 min |
| N/A | N/A | 135.2 °C | Temp Rise @ 150 min |
| N/A | N/A | 173.7 °C | Temp Rise @ 167 min |

Table 1 - Ratings

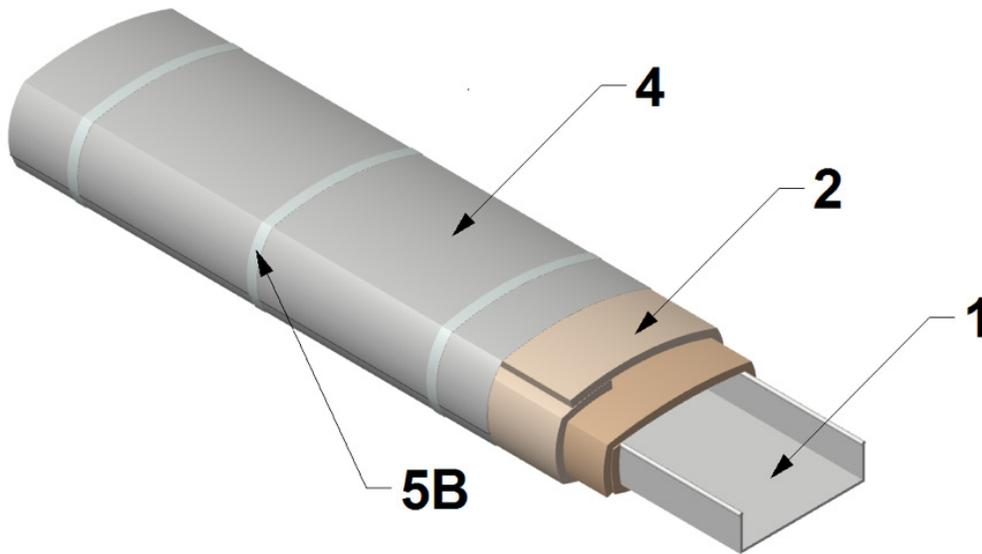

Figure 1. Cable Tray Protection (2 Layer System Shown)

1. **CABLE TRAY:** Use aluminum or other metallic cable tray with min. nominal dimensions of 44.5mm (1-3/4 in.) high × 152mm wide (6 in.), with ventilated or solid bottom.

2. **CERTIFIED MANUFACTURER:** 3M Company

CERTIFIED PRODUCT: Applied Fireproofing

CERTIFIED MODEL: 3M™ Interam™ E-5A-4 Series Endothermic Mat

ENDOTHERMIC MAT: Refer to Table 1. Install the prescribed number of layers of foil-faced flexible Endothermic Mat for the desired rating period.

Each layer of Endothermic Mat is wrapped tightly around the cable tray (Item 1) with the foil facing away from the cable tray. Ensure a min. 50mm (2 in.) overlap onto itself at end of wrap. Each section of Endothermic Mat is to be tightly butted to the adjacent section. Temporarily affix sections of Endothermic Mat with 3M™ Scotch 898 Filament Tape (1/2 in. wide), spaced nominally 3 in. on center (oc).

Any gaps larger than 3mm (1/8 in.) in width between adjacent Endothermic Mat wraps are to be filled with 3M™ Fire Barrier Sealant CP25+ WB (not shown).

Install each additional layer in the same manner, ensuring the seams between layers are offset a min. of 50mm (2 in.).

Design Number 3MU/AF 120-05

3. **ALUMINUM TAPE (Not Shown):** Apply 102mm (4 in.) wide pressure sensitive tape with aluminum foil-facing to all joints of each layer of the Endothermic Mat (Item 2).
4. **STEEL SHEATHING:** Install a one layer of min. 0.48mm (26 GA, 0.0156 in.) S-304 stainless steel sheathing over the Endothermic Mat (Item 2) with min. 76mm (3 in.) overlap at joints to create a stepped surface installation. Circumferential wraps will be overlapped by a min. of 3 in. at the end of the wrap.
5. **STEEL BANDING:** Apply 13mm (1/2 in.) wide × 0.5mm (0.02 in.) thick stainless steel banding as follows:
 - A. (Not Shown) Following the installation of the outer layer of the Endothermic Mat (Item 2), install bands a max. of 305mm (12 in.) oc and 0mm (1-1/2 in.) from the ends of the Endothermic Mat (Item 2). Bands shall be tightened such that they compress, but do not cut, into the foil-facing of the Endothermic Mat (Item 2).
 - B. Following the installation of the stainless steel sheathing (Item 4), install bands a max. of 400mm (16 in.) oc and 40mm (1-1/2 in.) from the ends of the sheathing.

Applied Fireproofing

Endothermic Mat

Flexible Wraps

AF

This material was extracted and drawn by 3M Fire Protection Products from the 2018 Product Directory, © Intertek



Fuel Oil Pipe Protection

| 3M UL Systems | "F" Rating | 3M Product | Through Application Details |
|---------------|------------|--|--|
| FP-1 | 2 | 3M™ Interam™ Endothermic Mat E-5A-4 3M™ Fire Barrier Sealant CP 25WB+ 3M™ Fire Barrier Water Tight Sealant 3000 WT 3M™ Aluminum Foil Tape 425 | Nominal 1 in. to 4 in. steel pipe protected with 3M™ Interam™ Endothermic Mat E-5A-4 for 2 hour F rating |
| FP-2 | 2, 3 | 3M™ Interam™ Endothermic Mat E-5A-4 3M™ Fire Barrier Sealant CP 25WB+ 3M™ Fire Barrier Water Tight Sealant 3000 WT 3M™ Aluminum Foil Tape 425 | 2" schedule 40 steel pipe inner pipe with 4" schedule 10 outer containment pipe protected with 3M™ Interam™ Endothermic Mat E-5A-4 for 2 or 3 hours. |



UL System No. FP-1
HNKJ - Fire-resistant Pipe-protection Systems

January 19, 2017

Fire-resistance Rating – 2 H

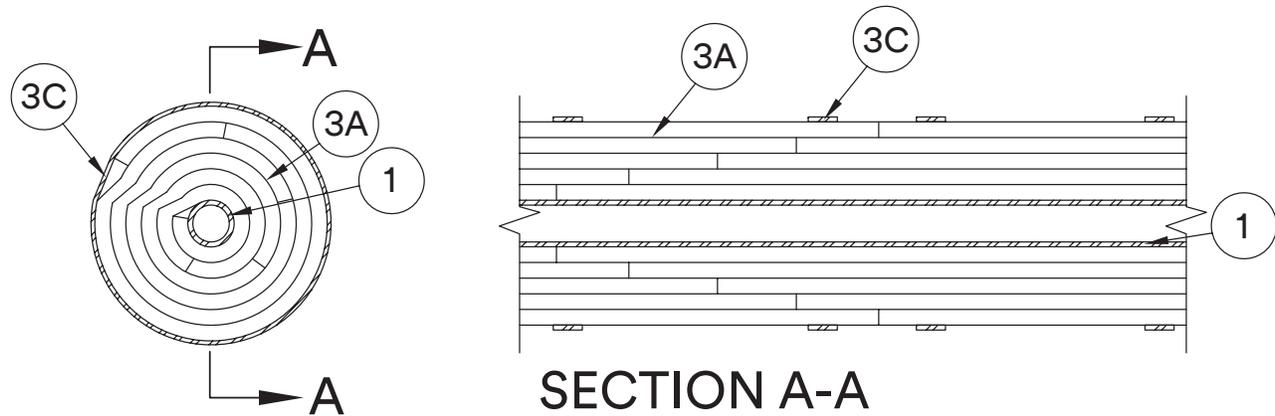

1. **Fuel Pipe Assembly** – Nom 1 in. (25 mm) to nom 4 in. (102 mm) diam Schedule 40 (or heavier) steel pipe with threaded or welded fittings. For all pipes greater than 1 in. (25 mm) diam, all fittings shall be welded.
2. **Pipe Supports** – (Not Shown) – Pipe shall be supported by steel pipe hangers in conjunction with min 3/8 in. (10 mm) diameter threaded steel rod. Refer to the manufacturer's installation instructions for additional details.
3. **Fire-resistant Pipe-protection System*** – The fire-resistant pipe-protection system consists of a mat wrap, foil tape, stainless steel banding straps and caulk. The system shall be installed in accordance with the detailed installation instruction manual supplied by the manufacturer of the Fire-resistant Pipe-protection Materials*. The details of the fire-resistant pipe-protection system are summarized below:
 - A. **Fire-resistant Pipe-protection Materials*** – Mat – Nom 0.4 in. (10 mm) flexible sheet material. A min of five layers of mat wrap are required. Each layer of mat wrap installed by cutting to size and wrapping around the fuel pipe and itself such that a min 2 in. (51 mm) overlap is present along the longitudinal seam. Adjacent lengths of mat wrap in each layer to be installed with tightly butted end seams. Successive layers of mat wrap installed in same manner with butted end seams offset min 2 in. (51 mm) from butted end seams of preceding layer. All seams in each layer of mat wrap to be sealed with foil tape (Item 3B). Mat wrap layers secured in place with stainless steel banding straps (Item 3C) on outermost layer.

3M COMPANY 3M FIRE PROTECTION PRODUCTS – Type E-5A-4
 - B. **Foil Tape** – (Not Shown) – Nom 4 in. (102 mm) wide min 3 mil (0.08 mm) thick pressure-sensitive aluminum foil or stainless steel foil tape, supplied in rolls. Used to secure seams of mat wrap (Item 3A).
 - C. **Steel Banding Straps** – Min 1/2 in. (13 mm) wide by min 0.019 in. (0.5 mm) thick stainless steel straps used in conjunction with stainless steel crimp clips. Banding straps spaced max 8 in. (203 mm) OC to secure mat wrap layers.
 - D. **Fill, Void or Cavity Materials* – Caulk** – (Not Shown) – Any joint between the adjacent layers of mat wrap that exceed 1/8 in. (3.2 mm) in width shall be filled with caulk to the full depth of the joint. Each layer of E-Mat (Item 3A) on the pipe supports abutting the mat wrap on the pipe shall also be sealed with caulk.

3M COMPANY 3M FIRE PROTECTION PRODUCTS – CP 25WB+, FB-3000 WT

Flexible Wraps

Endothermic Mat

Fire-Resistant Pipe-Protection Systems

FP



*Indicates such products shall bear the UL Certification Mark for jurisdictions employing the UL Certification.
Reprinted from the Online Certifications Directory with permission from UL©



UL System No. FP-2
HNKJ - Fire-resistant Pipe-protection Systems

February 28, 2017

Fire-resistance Rating – 2 and 3 H (See Item 2)

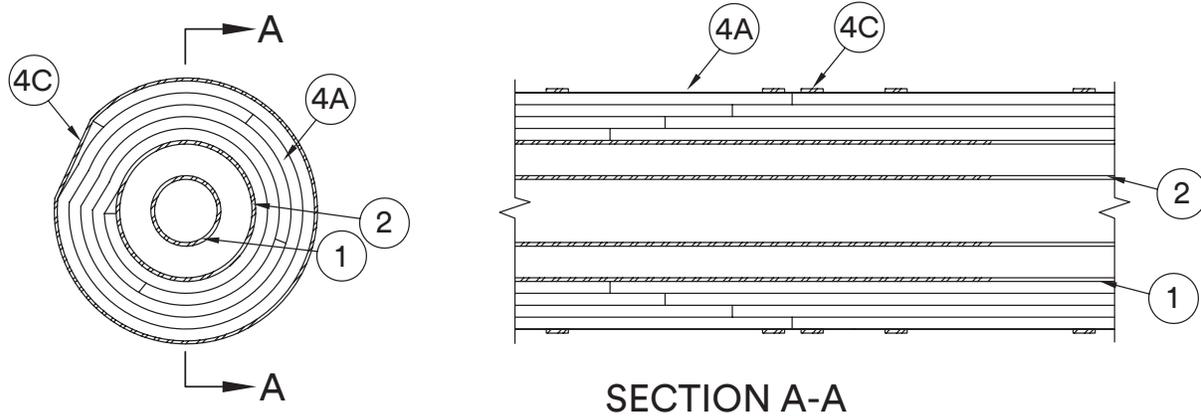

1. **Fuel Pipe Assembly** – One or more nom 1 in. (25 mm) to nom 4 in. (102 mm) diam Schedule 40 (or heavier) steel pipe with threaded or welded fittings for nom 1 in. (25 mm) diam or smaller pipes installed symmetrically within the outer containment pipe (Item 2) utilizing steel pipe spacers. For all pipes greater than 1 in. (25 mm) diam, all fittings shall be welded.
2. **Outer Containment Pipe** – Nom 4 in. (102 mm) to nom 12 in. (305 mm) diam Schedule 10 (or heavier) steel pipe with threaded or welded fittings. When outer containment pipe is greater than nom 4 in. (102 mm) diam, the fire resistance rating is 2 hr.
- 2A. **Outer Containment Pipe** – As an alternate to the Schedule 10 pipe, the outer containment pipe may be fabricated from 10 gauge (nom 0.134 in. or 3.5 mm) steel for nom 4 in. (102 mm) and 6 in. (152 mm) pipes only.
3. **Pipe Supports** – (Not Shown) – Outer containment pipe shall be supported by steel pipe hangers in conjunction with min 3/8 in. (10 mm) diameter threaded steel rod. Refer to the manufacturer's installation instructions for additional details.
4. **Fire-resistant Pipe-protection System*** – The fire-resistant pipe-protection system consists of a mat wrap, foil tape, stainless steel banding straps and caulk. The system shall be installed in accordance with the detailed installation instruction manual supplied by the manufacturer of the **Fire-resistant Pipe-protection Materials***. The details of the fire-resistant pipe-protection system are summarized below:
 - A. **Fire-resistant Pipe-protection Materials* – Mat** – Nom 0.4 in. (10 mm) flexible sheet material. A min of four layers of mat wrap are required. Each layer of mat wrap installed by cutting to size and wrapping around the outer containment pipe and itself such that a min 2 in. (51 mm) overlap is present along the longitudinal seam. Adjacent lengths of mat wrap in each layer to be installed with tightly butted end seams. Successive layers of mat wrap installed in same manner with butted end seams offset min 2 in. (51 mm) from butted end seams of preceding layer. All seams in each layer of mat wrap to be sealed with foil tape (Item 4B). Mat wrap layers secured in place with stainless steel banding straps (Item 4C) on outermost layer.

3M COMPANY 3M FIRE PROTECTION PRODUCTS – Type E-5A-4

- B. **Foil Tape** – (Not Shown) – Nom 4 in. (102 mm) wide min 3 mil (0.08 mm) thick pressure-sensitive aluminum foil or stainless steel foil tape, supplied in rolls. Used to secure seams of mat wrap (Item 4A).
- C. **Steel Banding Straps** – Min 1/2 in. (13 mm) wide by min 0.019 in. (0.5 mm) thick stainless steel straps used in conjunction with stainless steel crimp clips. Banding straps spaced max 8 in. (203 mm) OC to secure mat wrap layers.
- D. **Fill, Void or Cavity Materials* – Caulk** – (Not Shown) – Any joint between the adjacent layers of mat wrap that exceed 1/8 in. (3.2 mm) in width shall be filled with caulk to the full depth of the joint. Each layer of E-Mat (Item 4A) on the pipe supports abutting the mat wrap on the pipe shall also be sealed with caulk.

3M COMPANY 3M FIRE PROTECTION PRODUCTS – CP 25WB+, FB-3000 WT

*Indicates such products shall bear the UL Certification Mark for jurisdictions employing the UL Certification.

Reprinted from the Online Certifications Directory with permission from UL©



3M Industrial Adhesives and Tapes
Fire Protection Products
3M Center, Building 230-B-S-37
St. Paul, MN 55144-1000

Important Notice to Purchaser

Technical Information: The technical information, guidance, and other statements contained in this document or otherwise provided by 3M are based upon records, tests, or experience that 3M believes to be reliable, but the accuracy, completeness, and representative nature of such information is not guaranteed. Such information is intended for people with knowledge and technical skills sufficient to assess and apply their own informed judgment to the information. No license under any 3M or third party intellectual property rights is granted or implied with this information.

Product Selection and Use: Many factors beyond 3M's control and uniquely within user's knowledge and control can affect the use and performance of a 3M product in a particular application. As a result, customer is solely responsible for evaluating the product and determining whether it is appropriate and suitable for customer's application, including conducting a workplace hazard assessment and reviewing all applicable regulations and standards (e.g., OSHA, ANSI, etc.). Failure to properly evaluate, select, and use a 3M product and appropriate safety products, or to meet all applicable safety regulations, may result in injury, sickness, death, and/or harm to property.

Warranty, Limited Remedy, and Disclaimer: Unless a different warranty is specifically stated on the applicable 3M product packaging or product literature (in which case such warranty governs), 3M warrants that each 3M product meets the applicable 3M product specification at the time 3M ships the product. 3M MAKES NO OTHER WARRANTIES OR CONDITIONS, EXPRESS OR IMPLIED, INCLUDING, BUT NOT LIMITED TO, ANY IMPLIED WARRANTY OR CONDITION OF MERCHANTABILITY, FITNESS FOR A PARTICULAR PURPOSE, OR ARISING OUT OF A COURSE OF DEALING, CUSTOM, OR USAGE OF TRADE. If a 3M product does not conform to this warranty, then the sole and exclusive remedy is, at 3M's option, replacement of the 3M product or refund of the purchase price.

Limitation of Liability: Except for the limited remedy stated above, and except to the extent prohibited by law, 3M will not be liable for any loss or damage arising from or related to the 3M product, whether direct, indirect, special, incidental, or consequential (including, but not limited to, lost profits or business opportunity), regardless of the legal or equitable theory asserted, including, but not limited to, warranty, contract, negligence, or strict liability.



3M Industrial Adhesives and Tapes
Fire Protection Products
3M Center
Building 230-B-S-37
St. Paul, MN 55144-1000

1-800-328-1687
3M.com/firestop

Underwriters Laboratories, Inc. is a registered trademark of Underwriters Laboratories, Inc.

LEED is a registered trademark of USGBC.

3M, Expantrol, FireDam, Interam and VentureClad are trademarks of 3M.

All other trademarks are the property of their respective owners. Used under license in Canada.

Please Recycle. Printed in U.S.A. © 3M 2019. All rights reserved. 98-0213-4366-4 REV 2019