

Features

- Stable and reliable in performance
- Low profile, compact size
- SMT processes compatible
- RoHS Compliant

Applications

- Digital Enhanced Cordless Telecommunications, DECT (1880-1930 MHz)



RoHS Compliant

includes all homogeneous materials
(see part numbering system for details)

Specifications

PN: NAN-CD1B3216AF	
Electrical	
Frequency Range	1880 ~ 1930MHz
Center Frequency	1905 MHz
Polarization	Linear
Gain	1.5 dBi typ.
Efficiency	74% typ.
V.S.W.R	2.0 Max
Impedance	50Ω
Dimensions (mm):	
Body Length (A)	3.2 ± 0.15
Width (B)	1.6 ± 0.15
Thickness (C)	0.5 ± 0.15
Connection Type	SMT
Ground Plane	80 mm x 40 mm

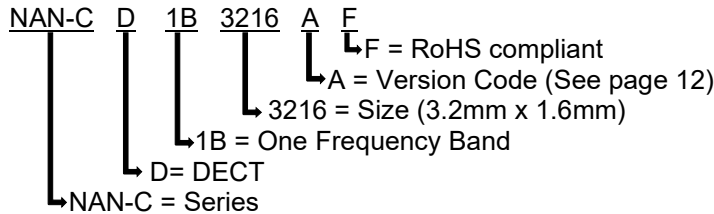

PIN Definition



PIN	1	2
Soldering PAD	Signal	Tuning / Ground

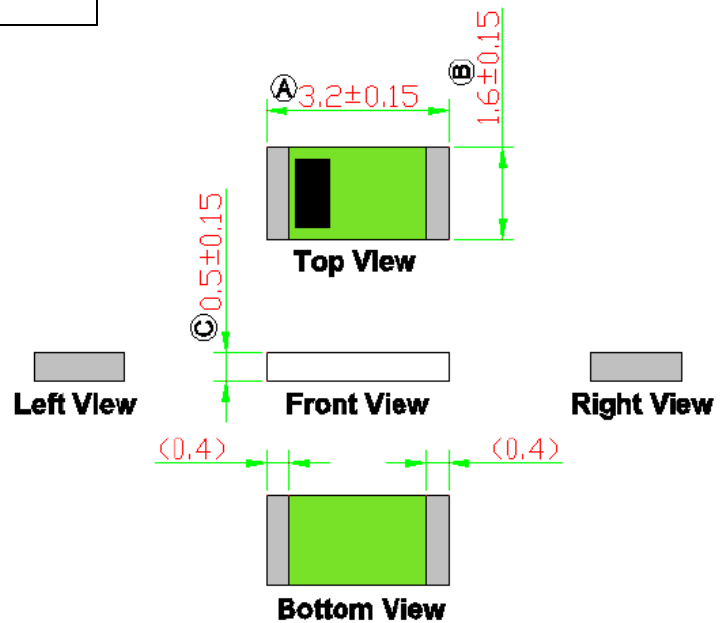

NOTE:
 1. All materials are RoHS compliant.
 2. "A~C" Critical Dimensions.
 3. "()" Reference Dimensions.

Operating & Storage Conditions

Operating	
Maximum Input Power	2W
Operating Temperature	-40°C to 85°C
Storage	
Storage Temperature	-5°C to 40°C
Relative Humidity	20% to 70%
Shelf Life	1 Year

Evaluation Board

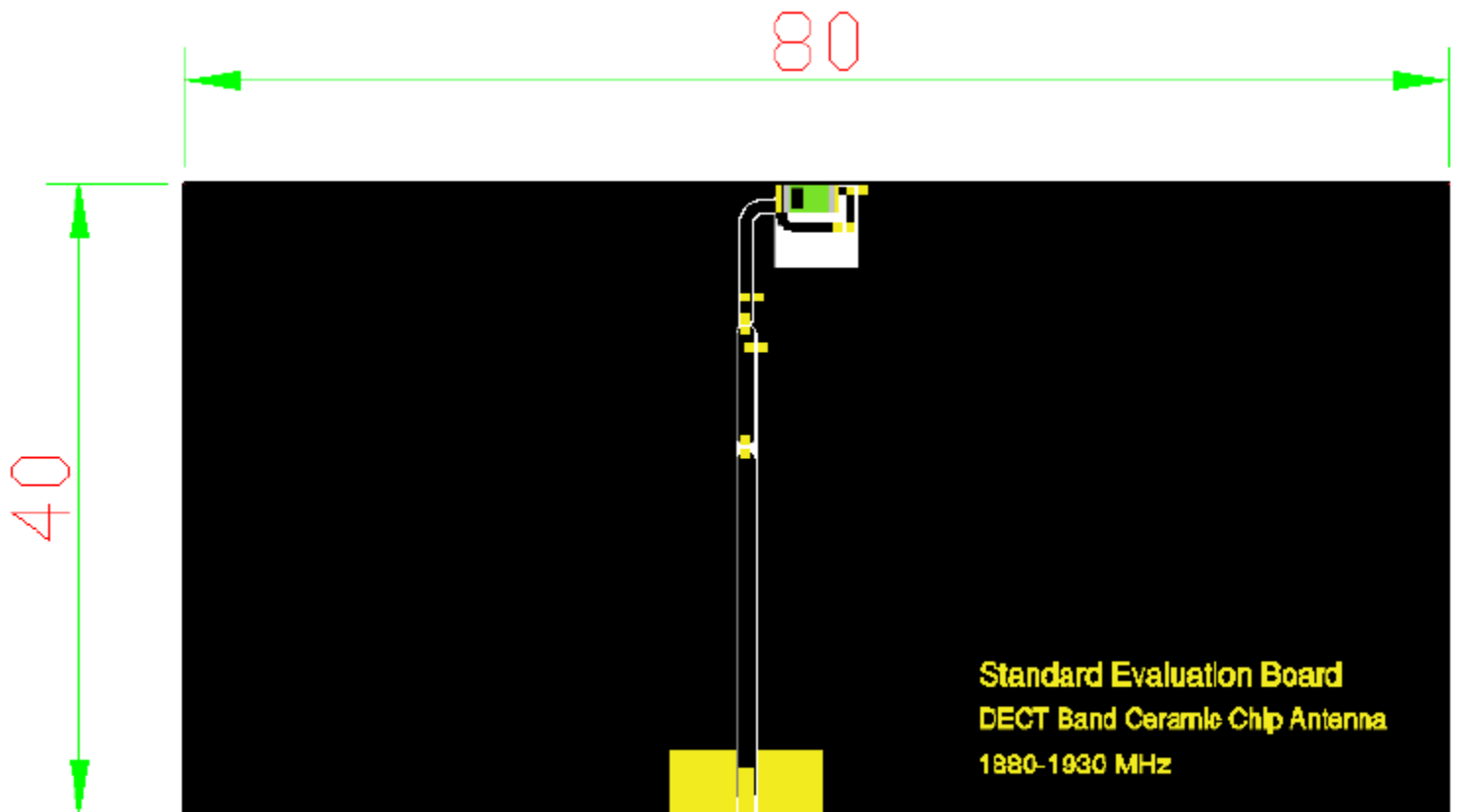

Solder Ground Pattern

The gold areas represent the solder land pattern. Any recommendations on the matching circuit will be provided according to the customer's installation conditions.

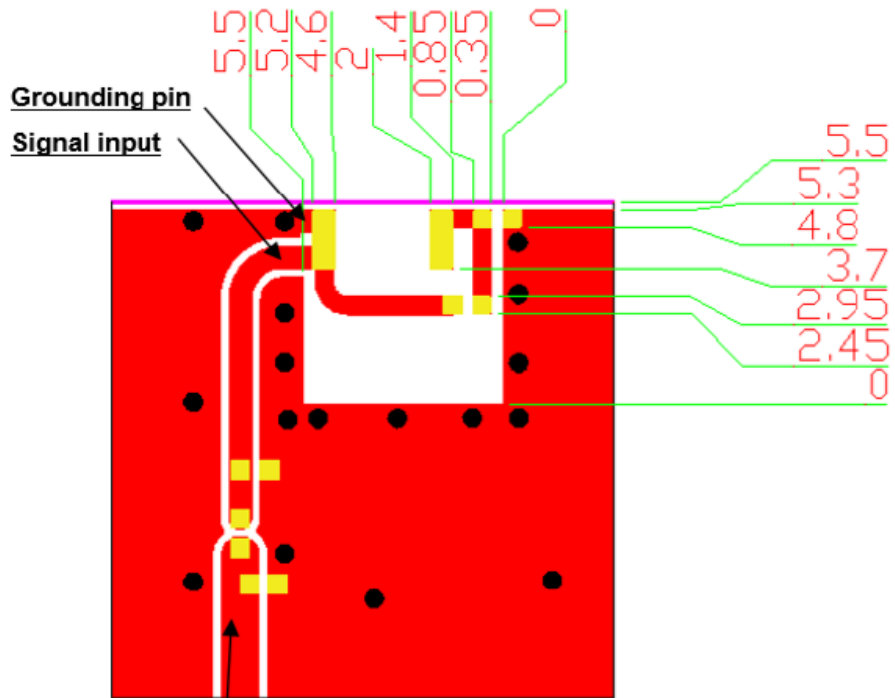

Transmission Line with 50Ω Impedance Characteristic

Top View

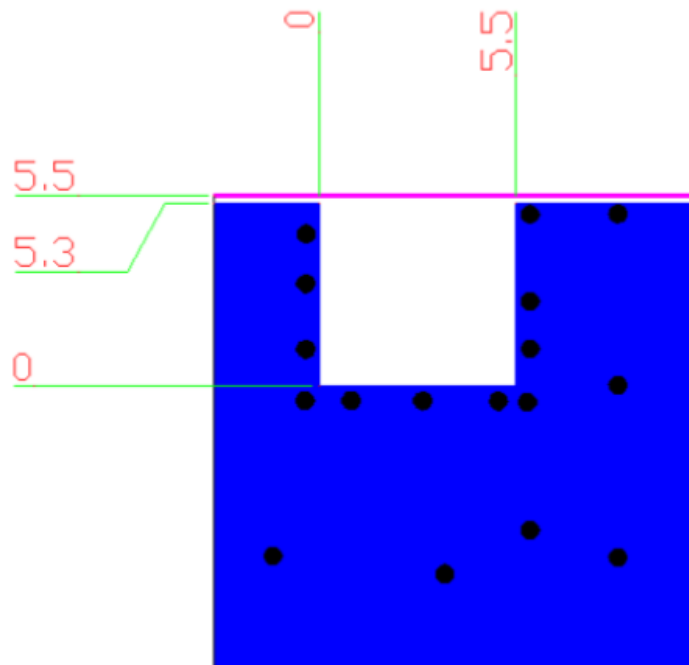

Bottom View

Return Loss & VSWR

Return Loss (S_{11})

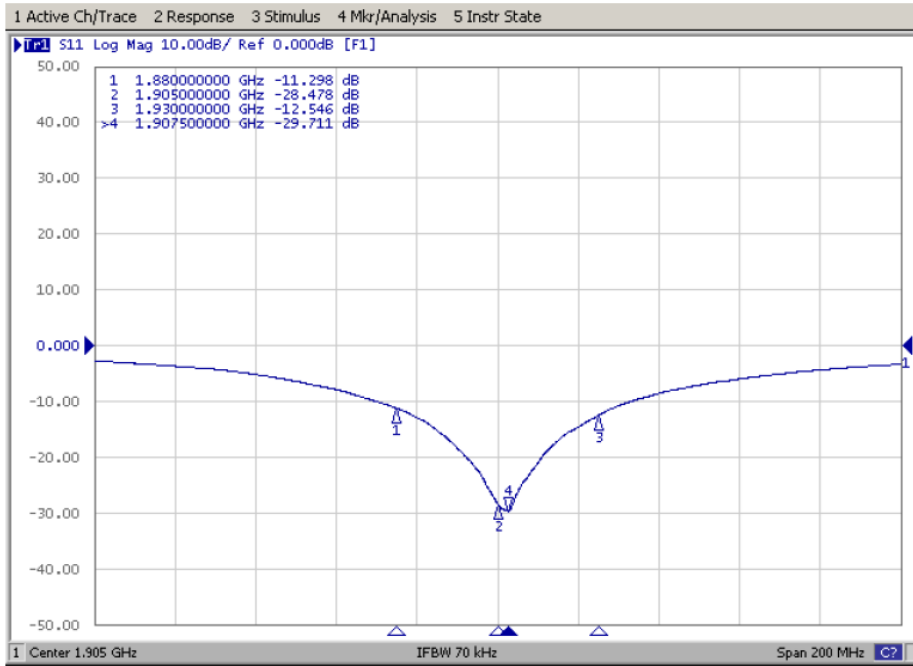

VSWR (S_{11})

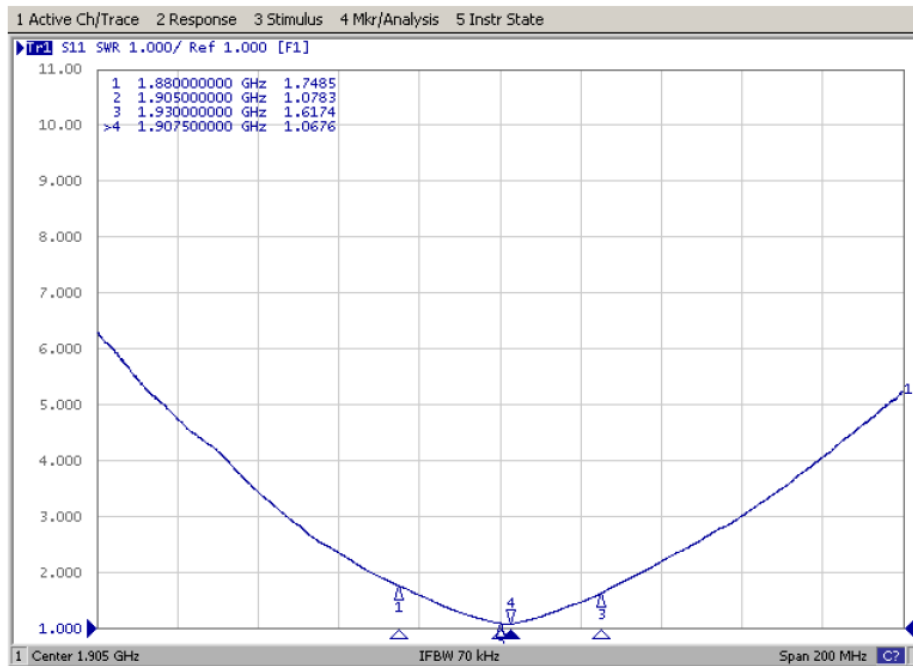

Radiation Patterns

3D Gain Patterns @ 1880 MHz (Unit: dBi)

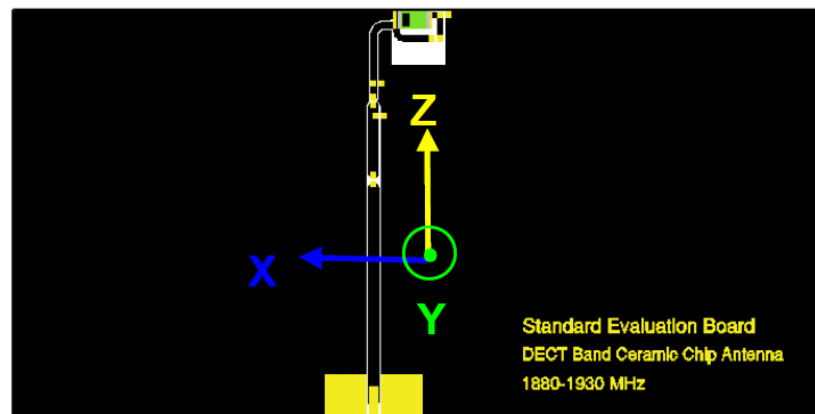
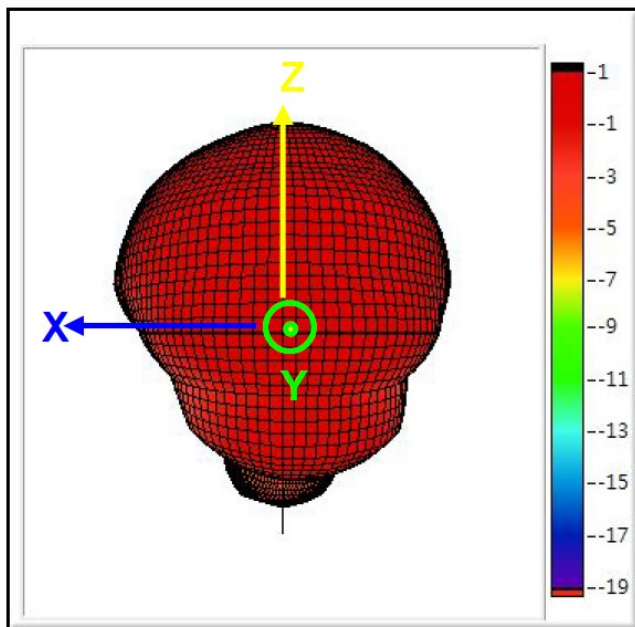
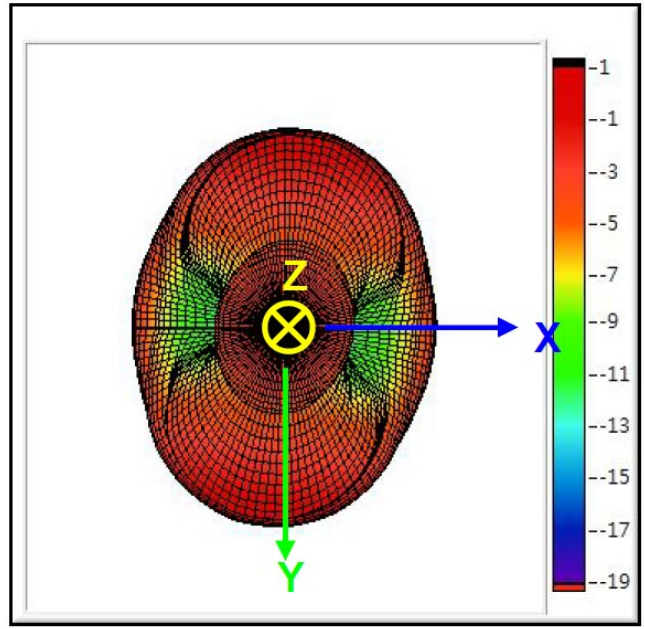
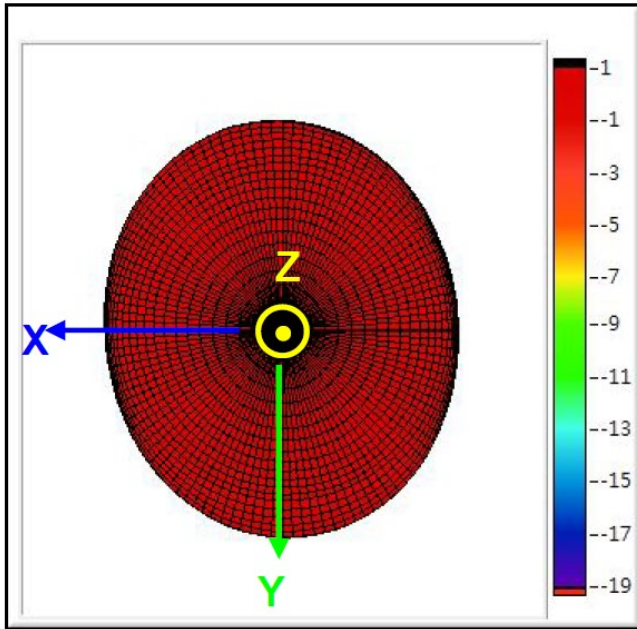

3D Gain Patterns @ 1905 MHz (Unit: dBi)

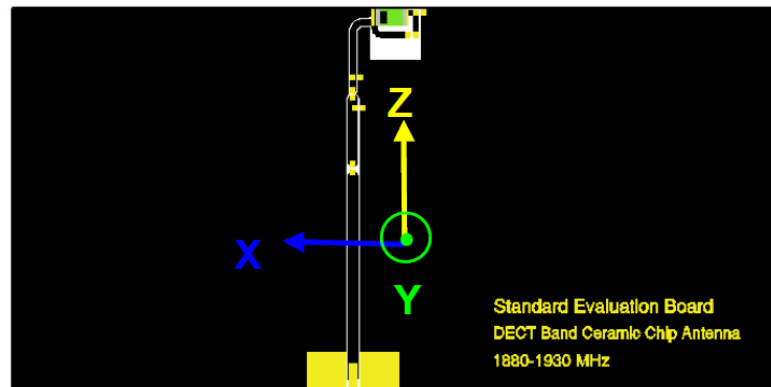
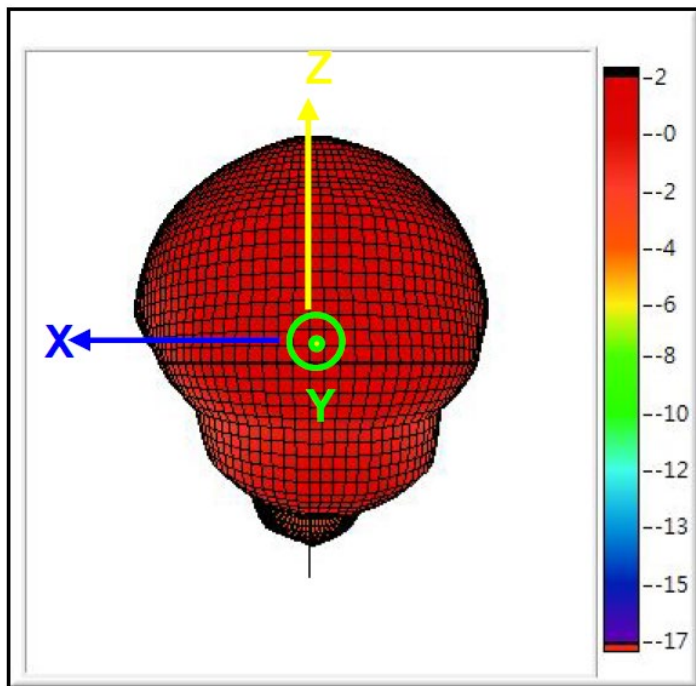
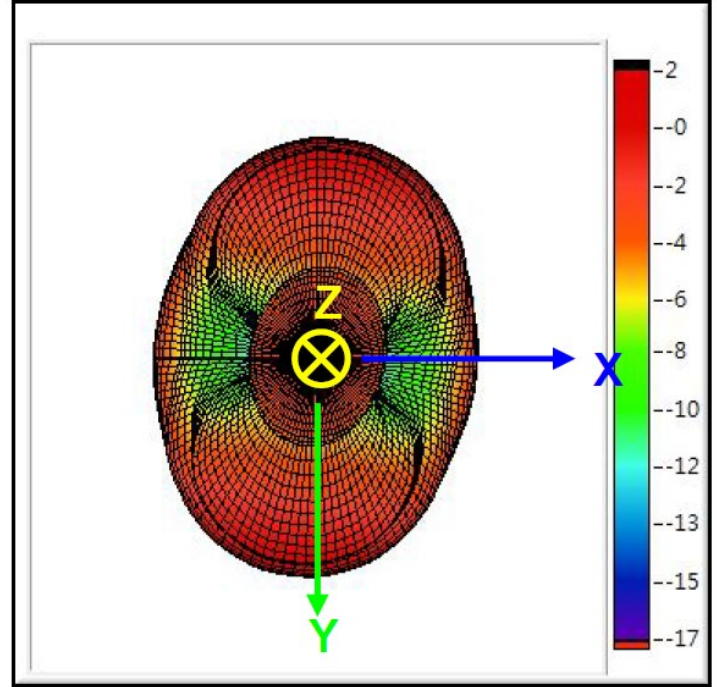
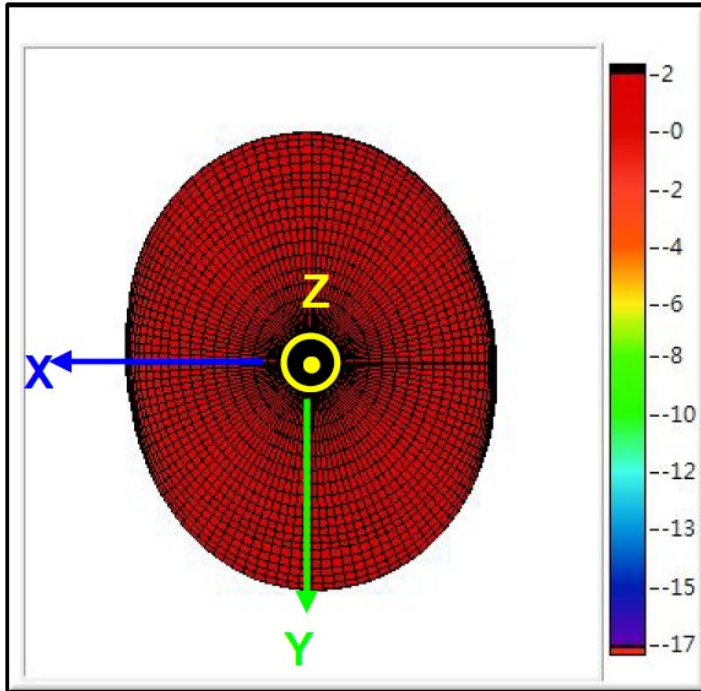

3D Gain Patterns @ 1930 MHz (Unit: dBi)

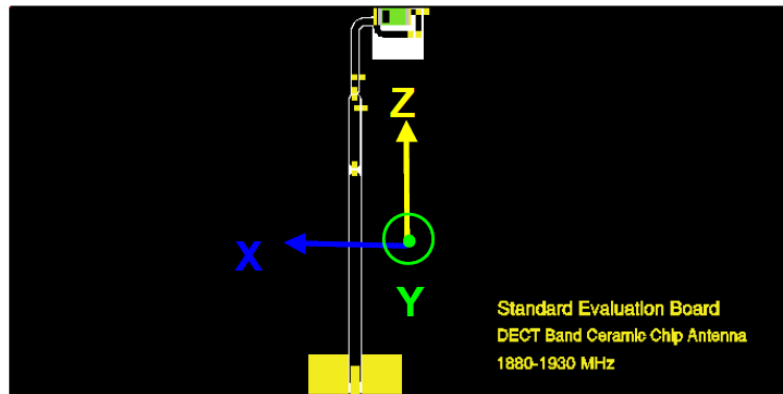
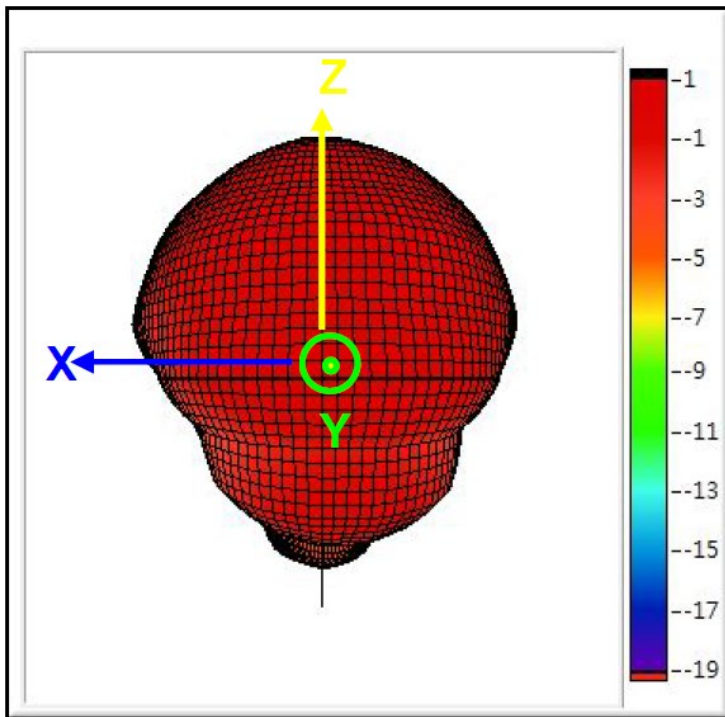
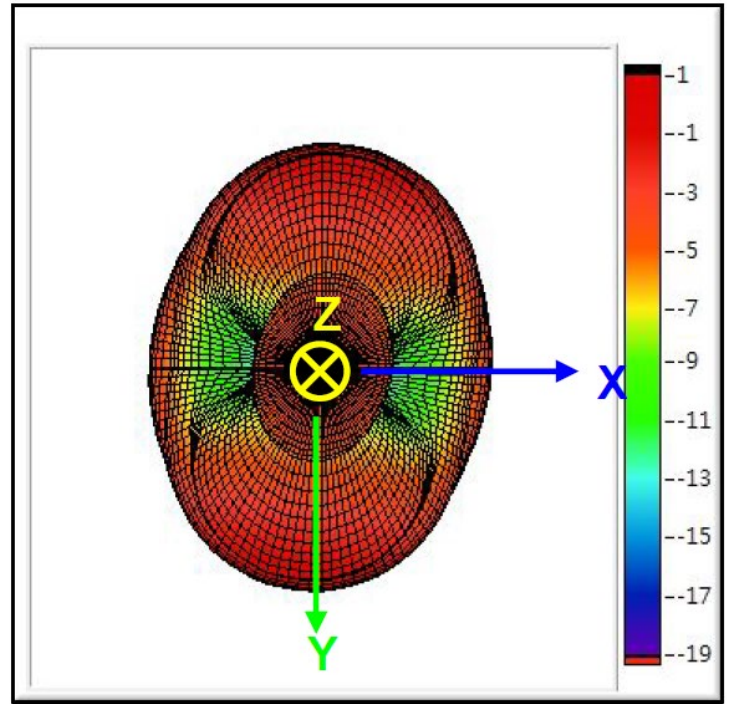
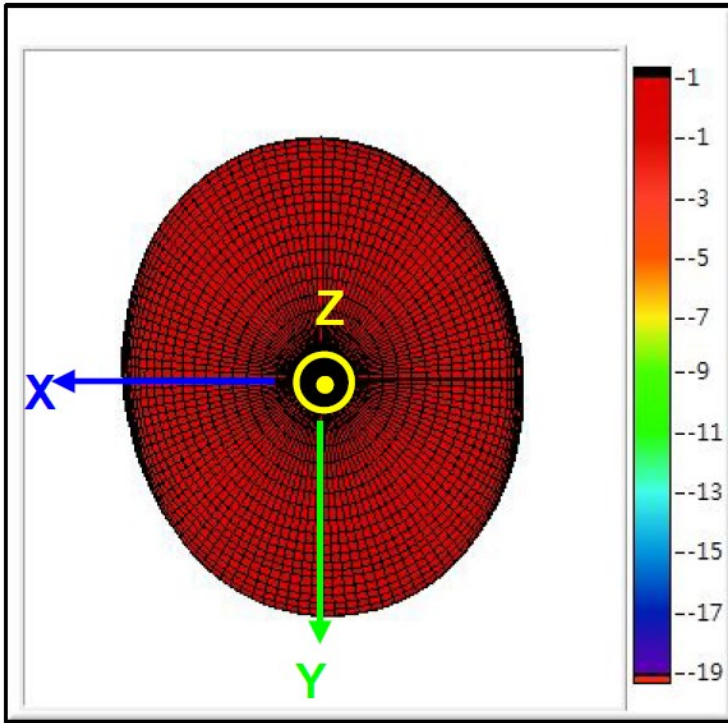

Efficiency Table

Frequency(MHz)	1880	1881	1883	1885	1887	1889	1891	1893	1895	1897	1899	1901	1903	1905
Efficiency(dB)	-1.6	-1.5	-1.5	-1.4	-1.3	-1.3	-1.3	-1.2	-1.2	-1.2	-1.2	-1.2	-1.3	-1.3
Efficiency(%)	70.0	70.2	71.1	72.6	73.9	73.7	75.0	75.8	76.3	75.5	76.1	75.6	74.3	74.5
Peak Gain(dBi)	1.0	1.0	1.0	1.1	1.3	1.3	1.4	1.4	1.5	1.5	1.6	1.6	1.5	1.5

Frequency(MHz)	1907	1909	1911	1913	1915	1917	1919	1921	1923	1925	1927	1929	1930
Efficiency(dB)	-1.4	-1.4	-1.4	-1.5	-1.5	-1.5	-1.5	-1.6	-1.6	-1.6	-1.7	-1.8	-1.8
Efficiency(%)	72.6	72.3	72.0	71.5	70.6	71.2	71.4	69.9	68.7	68.5	68.1	66.1	65.8
Peak Gain(dBi)	1.4	1.4	1.4	1.4	1.3	1.4	1.4	1.3	1.1	1.1	1.1	0.9	0.8

Efficiency Vs. Frequency

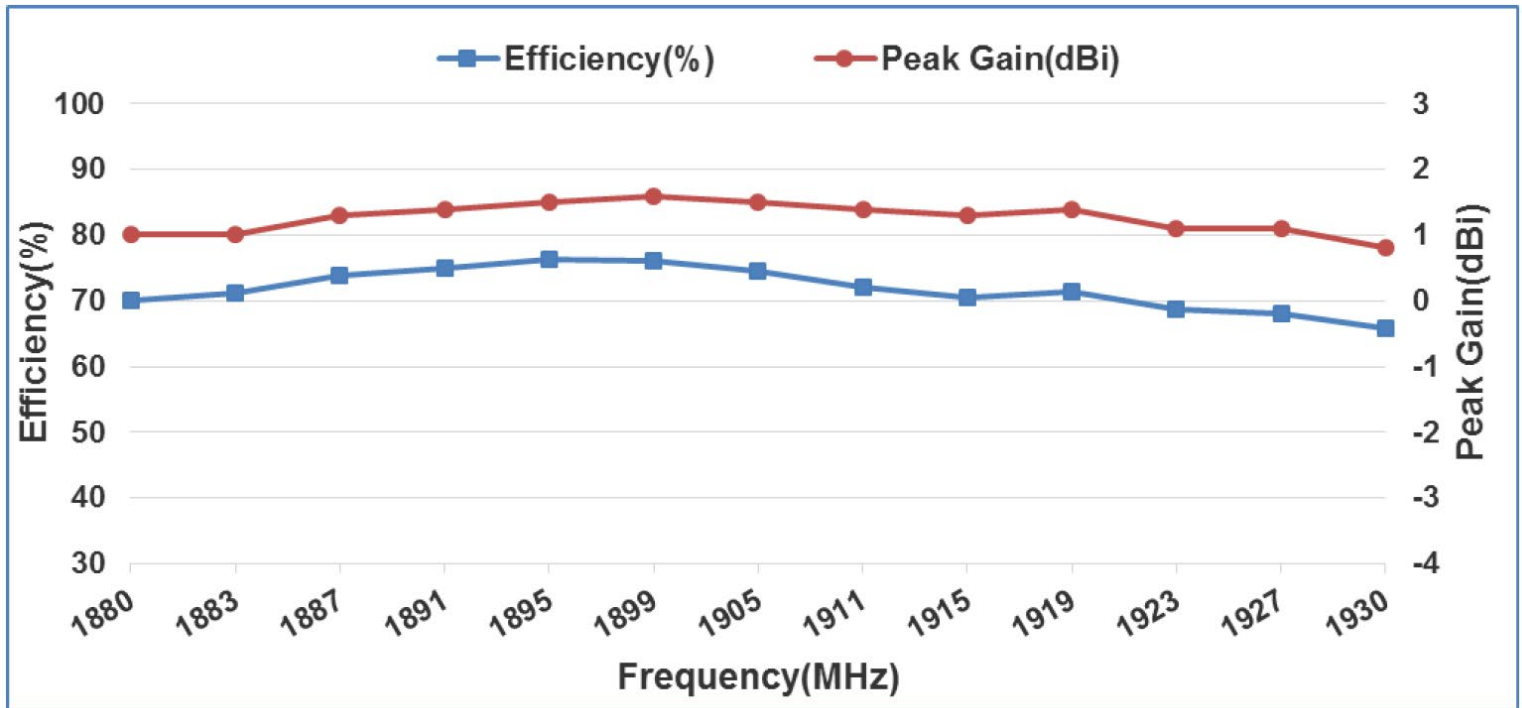

Frequency Tuning and Matching Circuit

Chip Antenna tuning scenario:

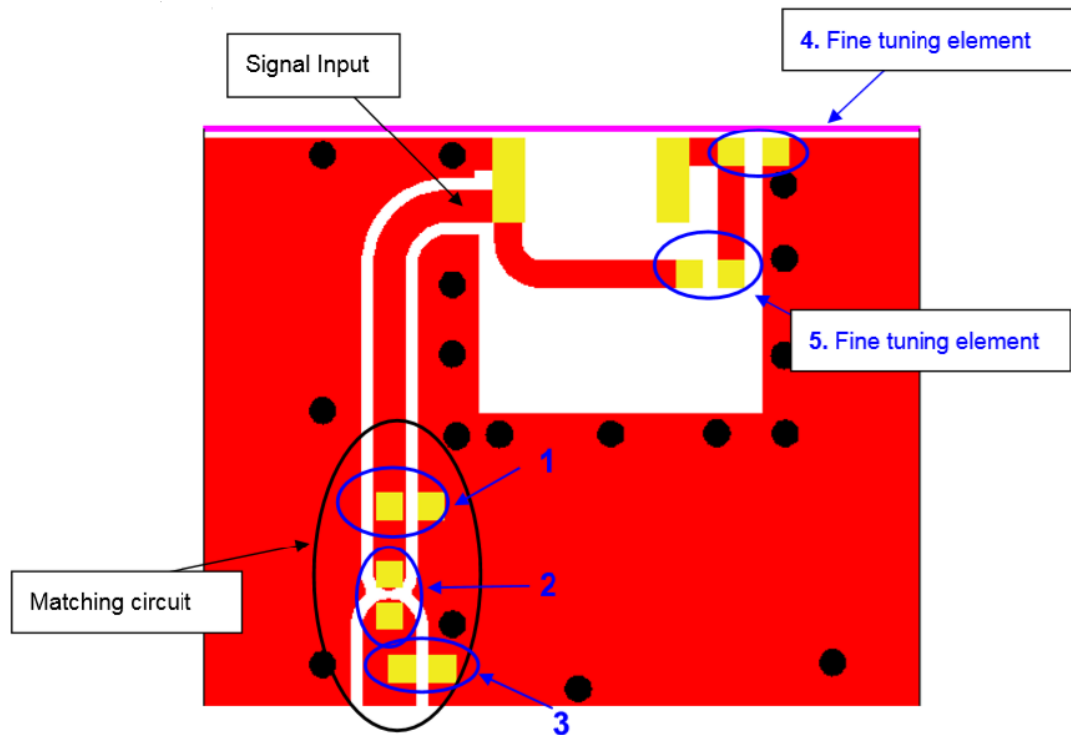

Matching circuit :

The center frequencies will be about 1905 MHz at our standard 80 x 40 mm evaluation board, with the following recommended values of matching and tuning components. *

* = These are typical reference values

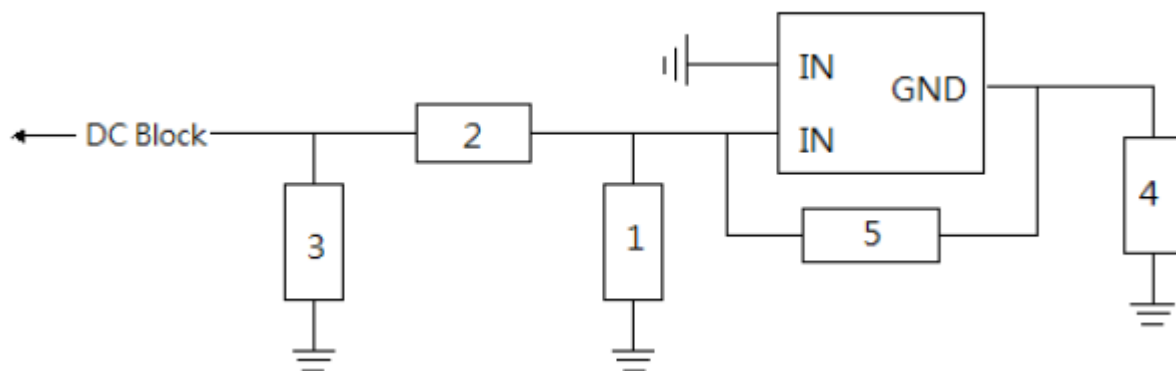

System Matching Circuit Component			
Location	Description	Tolerance	NIC Part Number
1	1.2pF, (0402)	±0.1pF	NMC-Q0402NPO1R2B50TRPF
2	0Ω, (0402)	-	NRC04ZOTRF
3	N/A	-	-
4 Fine Tuning Element	2.4pF, (0402)	±0.1pF	NMC-Q0402NPO2R4B50TRPF
5 Fine Tuning Element	0.5pF, (0402)	±0.05pF	NMC-Q0402NPO0R5A50TRPF

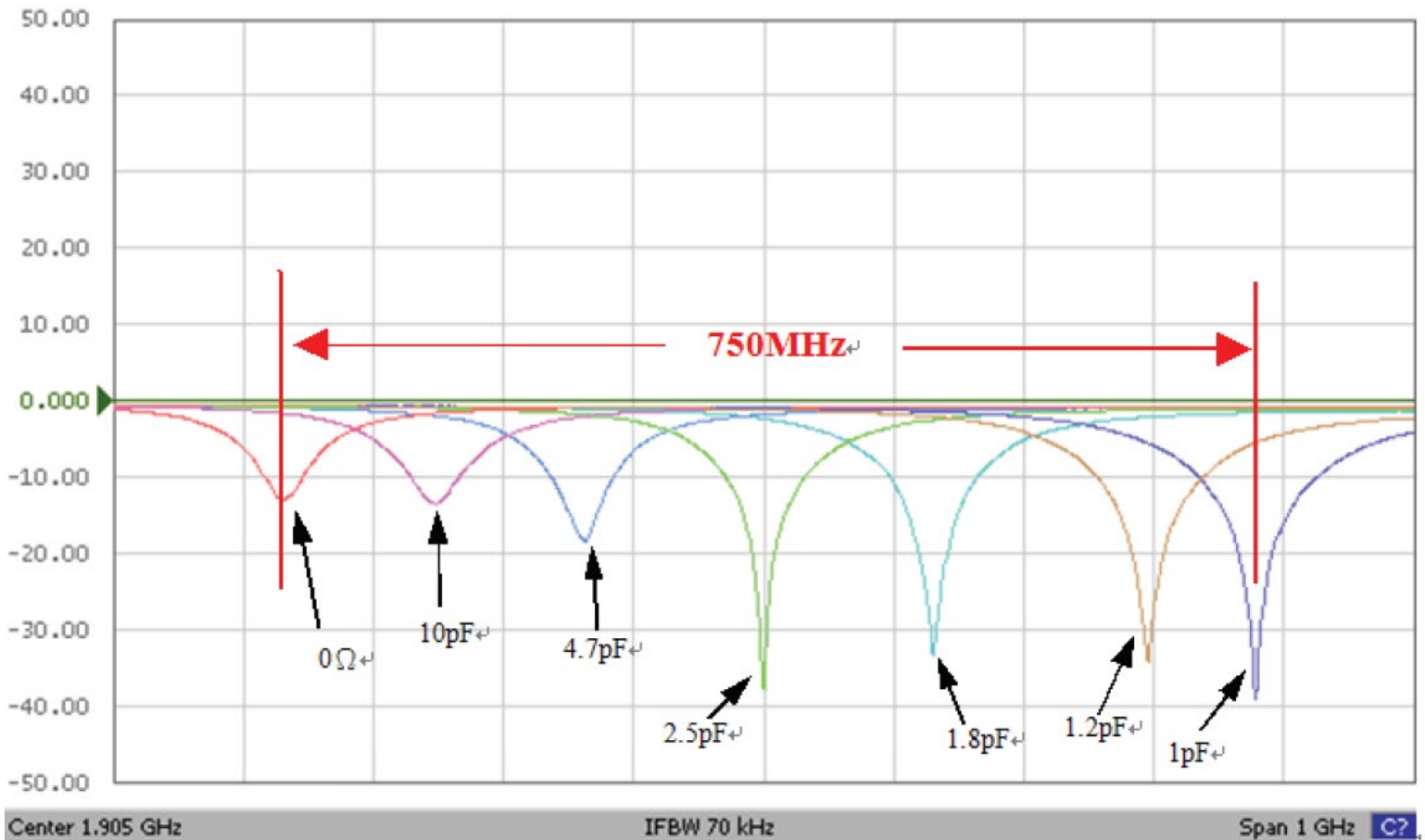

Packing

1. Quantity/Reel : 5000 pcs/Reel
2. Plastic Tape:

a. Tape Drawing

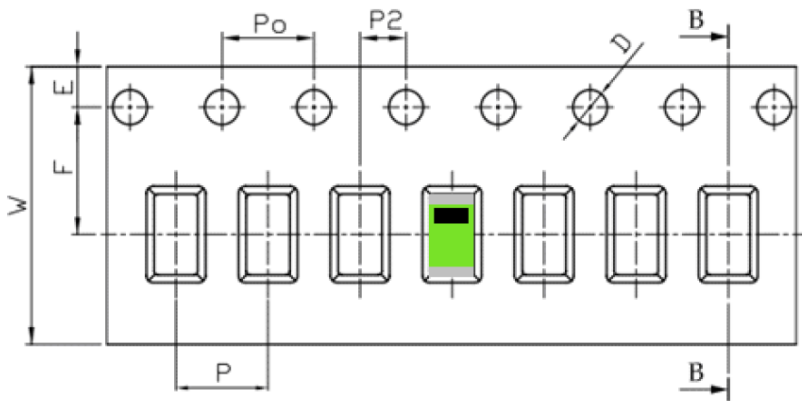

b. Tape Dimensions (unit: mm)

Feature	Specifications	Tolerances
W	12.00	±0.30
P	4.00	±0.10
E	1.75	±0.10
F	5.50	±0.10
P ₂	2.00	±0.10
D	1.50	+0.10 -0.00
P ₀	4.00	±0.10
10P ₀	40.00	±0.20

c. Reel Drawing

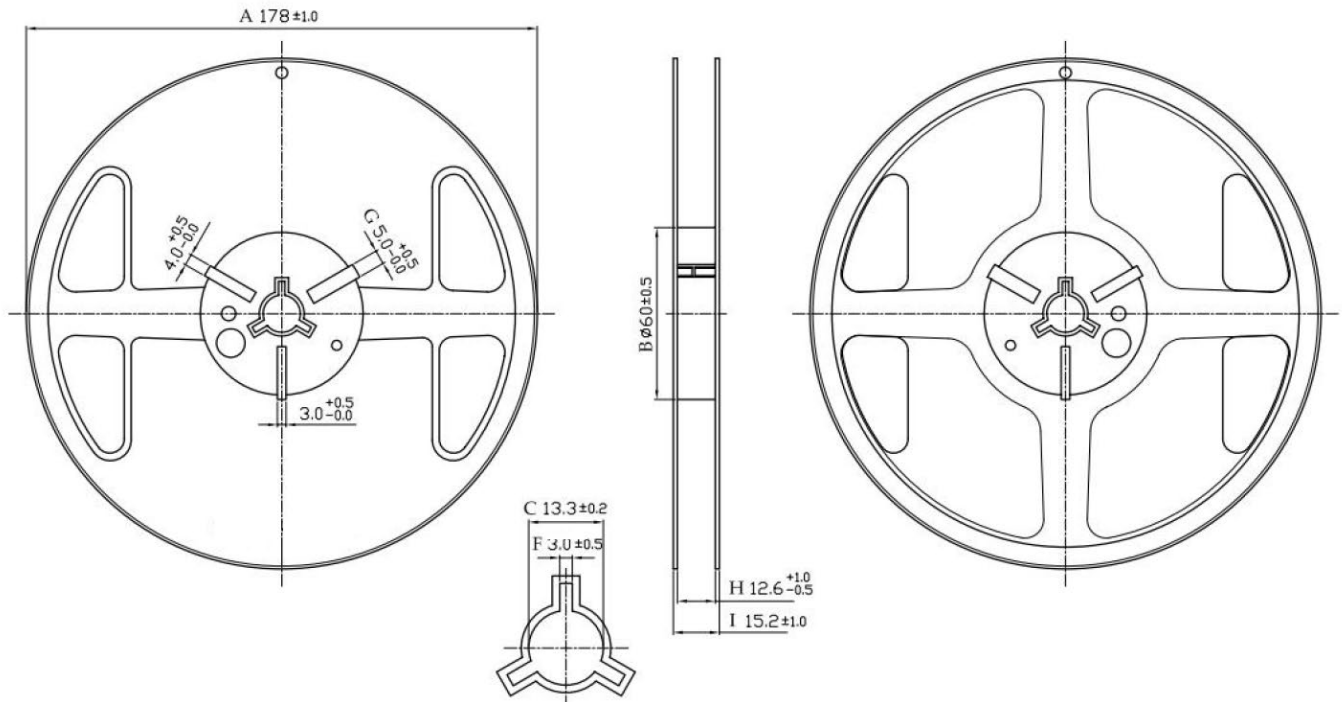

Version History and Status

Version	Date Issued	Details	Status
A	February 21, 2021	Initial Release	Supported

Please reach out to NIC for any customization requests and other inquiries:

- NIC Technical Support: tpmg@niccomp.com
- Compliance Support: rohs@niccomp.com