

Cable connector - CA-09S1N8AT0DN - 1619333

Please be informed that the data shown in this PDF Document is generated from our Online Catalog. Please find the complete data in the user's documentation. Our General Terms of Use for Downloads are valid (<http://phoenixcontact.com/download>)

Cable connector, CA, angled, shielded: yes, Screw locking, M23, No. of pos.: 8+1, type of contact: Socket, Crimp connection, cable diameter range: 3 mm ... 14.5 mm, coding:N

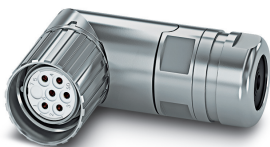

The figure shows the 6-pos. product version

Your advantages

- ✓ Angled cable outlet for confined spaces
- ✓ Can be adapted to various applications, thanks to adjustable cable outlet direction
- ✓ Safe use in the field, thanks to high degree of protection
- ✓ Connector for flexible on-site assembly
- ✓ Consistent EMC protection for reliable transmission of signals
- ✓ Crimping connection: vibration- and temperature-resistant assembly



Key Commercial Data

Packing unit	1 pc
GTIN	 4 046356 825115
GTIN	4046356825115

Technical data

Temperature range

Temperature range	-40 °C ... 125 °C
-------------------	-------------------

Data of the insulating body

Note	Order information: Order crimp contacts 8 x Ø 1 mm, 1 x Ø 2 mm separately
Coding	N
Insulator material	PA 6.6
Contact connection method	Crimp connection
Type of contacts	Socket
Application	Signal

Cable connector - CA-09S1N8AT0DN - 1619333

Technical data

Data of the insulating body

Number of positions	9
Direction of rotation	Standard
Contact diameter of power contacts	2 mm
Litz wire cross section of power contacts min.	1 mm ²
Litz wire cross section of power contacts max.	2.5 mm ²
Rated current for power contacts	20 A
Rated voltage	48 V AC 74 V DC
Rated surge voltage	1.5 kV
Overvoltage category	III
Degree of pollution	3
Contact diameter of signal contacts	1 mm
Litz wire cross section of signal contacts min.	0.08 mm ²
Litz wire cross section of signal contacts max.	1 mm ²
Nominal current per signal contact	8 A

Housing data

Housing material	Turned parts: copper zinc alloy (CuZn), die-cast parts: zinc (GD-Zn)
Type of locking	Screw locking
Degree of protection (when plugged in)	IP67
Thread type	M23

Cable seal data

Cable diameter	3 mm ... 14.5 mm
Sealing material	NBR

Environmental Product Compliance

REACH SVHC	Lead 7439-92-1
China RoHS	Environmentally Friendly Use Period = 50 years
	For details about hazardous substances go to tab "Downloads", Category "Manufacturer's declaration"

Drawings

Cable connector - CA-09S1N8AT0DN - 1619333

Schematic diagram

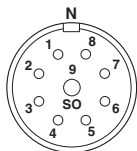

Dimensional drawing

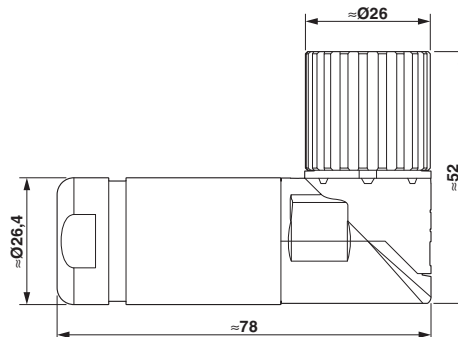

Classifications

eCl@ss

eCl@ss 10.0.1	27440102
eCl@ss 11.0	27440102
eCl@ss 4.0	27260700
eCl@ss 4.1	27260700
eCl@ss 5.0	27260700
eCl@ss 5.1	27260700
eCl@ss 6.0	27260700
eCl@ss 7.0	27440102
eCl@ss 9.0	27440102

ETIM

ETIM 3.0	EC001121
ETIM 4.0	EC002635
ETIM 6.0	EC002061

UNSPSC

UNSPSC 6.01	43172015
UNSPSC 7.0901	43201404
UNSPSC 11	43172015
UNSPSC 12.01	43201404
UNSPSC 13.2	43201404
UNSPSC 18.0	39121413
UNSPSC 19.0	39121413
UNSPSC 20.0	39121413
UNSPSC 21.0	39121413

Approvals

Approvals

Cable connector - CA-09S1N8AT0DN - 1619333

Approvals

Approvals

UL Recognized / cUL Recognized / EAC / UL Recognized / cUL Recognized

Ex Approvals

Approval details

UL Recognized		http://database.ul.com/cgi-bin/XYV/template/LISEXT/1FRAME/index.htm E335019-20141210
---------------	---	--

cUL Recognized		http://database.ul.com/cgi-bin/XYV/template/LISEXT/1FRAME/index.htm E335019-20141210
----------------	---	--

EAC		B.01687
-----	---	---------

UL Recognized		http://database.ul.com/cgi-bin/XYV/template/LISEXT/1FRAME/index.htm E335019-20141210
---------------	---	--

Nominal voltage UN	48 V
Nominal current IN	6 A
mm ² /AWG/kcmil	20

cUL Recognized		http://database.ul.com/cgi-bin/XYV/template/LISEXT/1FRAME/index.htm E335019-20141210
----------------	---	--

Nominal voltage UN	48 V
Nominal current IN	4 A
mm ² /AWG/kcmil	20

Accessories

Accessories

Circular connectors (device side)

Cable connector - CA-09S1N8AT0DN - 1619333

Accessories

Hook wrench - SF-Z0027 - 1607455



Hook wrench

Crimp contact

Crimp contact - RC-11S2000 - 1596772



Crimp contact, turned, Single contact, contact diameter: 1 mm, crimp range: 0.08 mm² ... 0.22 mm²

Crimp contact - RC-12S2000 - 1599600



Crimp contact, turned, Single contact, contact diameter: 1 mm, crimp range: 0.14 mm² ... 0.56 mm²

Crimp contact - RC-1KS2000 - 1602998



Crimp contact, turned, Single contact, contact diameter: 1 mm, crimp range: 0.5 mm² ... 1 mm²

Crimp contact - RC-5CS2000 - 1603517



Crimp contact, turned, contact diameter: 2 mm, crimp range: 1 mm² ... 1.5 mm²

Cable connector - CA-09S1N8AT0DN - 1619333

Accessories

Crimp contact - RC-5AS2000 - 1603509



Crimp contact, turned, contact diameter: 2 mm, crimp range: 1.5 mm² ... 2.5 mm²

Crimp contact - RC-5SS2000 - 1603530



Crimp contact, turned, contact diameter: 2 mm, crimp range: 0.5 mm² ... 0.75 mm²

Crimp contact - RC-59S2000 - 1603501



Crimp contact, turned, contact diameter: 2 mm, crimp range: 0.75 mm² ... 1 mm²

Mounting material

Torque screwdriver - SF-Z0028 - 1607456



Torque screwdriver

Color-coding - RF-Z0014 - 1620588



Color-coding, color: green

Cable connector - CA-09S1N8AT0DN - 1619333

Accessories

Color-coding - RF-Z0015 - 1620592



Color-coding, color: orange

Color-coding - RF-Z0016 - 1620593



Color-coding, color: black

Protective cover

Protective cap - RC-Z2058 - 1604223



Plastic protection cap for connectors with M23 knurled nut

Plastic anti-static dust protection cap - RC-Z2468 - 1611796



Plastic protection cap, antistatic, for connectors with M23 knurled nut

Phoenix Contact 2021 © - all rights reserved
<http://www.phoenixcontact.com>

PHOENIX CONTACT GmbH & Co. KG

Flachsmarktstr. 8

32825 Blomberg

Germany

Tel. +49 5235 300

Fax +49 5235 3 41200

<http://www.phoenixcontact.com>