



# FocusLCDs.com

LCDs MADE SIMPLE®

Ph. 480-503-4295 | [NOPP@FocusLCD.com](mailto:NOPP@FocusLCD.com)

TFT | CHARACTER | UWVD | FSC | SEGMENT | CUSTOM | REPLACEMENT

## Graphic Display Module

### Part Number

C162ALBFGS16WN55PABS

### Overview

Display area: 80mm x 36mm (16 x 2)  
SPI Interface, FSTN, Black background, RGB Edge  
lit, Bottom view, Wide temp, Transmissive  
(negative), 5V LCD, 5V LED,  
Controller=SPLC780D, RoHS Compliant

## 1. Features

2. 5x8 dots with cursor
3. Built-in controller (SPLC780D or equivalent)
4. +5V power supply
5. Serial Interface I<sup>2</sup>C, SPI or RS232/TTL
6. 16characters \*2lines display

<b>LCD type</b>	<input type="checkbox"/> TN			
	<input type="checkbox"/> FSTN	<input checked="" type="checkbox"/> FSTN Negative		
	<input type="checkbox"/> STN Yellow Green	<input type="checkbox"/> STN Gray	<input type="checkbox"/> STN Blue Negative	
<b>View direction</b>	<input checked="" type="checkbox"/> 6 O'clock		<input type="checkbox"/> 12 O'clock	
<b>Rear Polarizer</b>	<input type="checkbox"/> Reflective		<input type="checkbox"/> Transflective	<input checked="" type="checkbox"/> Transmissive
<b>Backlight Type</b>	<input type="checkbox"/> LED Array	<input type="checkbox"/> EL	<input type="checkbox"/> Internal Power	<input type="checkbox"/> 3.0V Input
	<input checked="" type="checkbox"/> LED Edge	<input type="checkbox"/> CCFL	<input checked="" type="checkbox"/> External Power	<input type="checkbox"/> 5.0V Input
<b>Backlight Color</b>	<input type="checkbox"/> White	<input type="checkbox"/> Blue	<input type="checkbox"/> Amber	<input checked="" type="checkbox"/> Red-Green-Blue
<b>Temperature Range</b>	<input type="checkbox"/> Normal		<input checked="" type="checkbox"/> Wide	<input type="checkbox"/> Super Wide
<b>DC to DC circuit</b>	<input type="checkbox"/> Build-in			<input checked="" type="checkbox"/> Not Build-in
<b>Touch screen</b>	<input type="checkbox"/> With			<input checked="" type="checkbox"/> Without
<b>Font type</b>	<input checked="" type="checkbox"/> English-Japanese	<input type="checkbox"/> English-European	<input type="checkbox"/> English-Russian	<input type="checkbox"/> Other

## MECHANICAL SPECIFICATIONS

Module size	80.0mm(L)*36.0mm(W)* Max13.5(H)mm
Viewing area	64.5mm(L)*16.4mm(W)
Character size	3.0mm(L)*5.23mm(W)
Character pitch	3.51mm(L)*5.75mm(W)
Weight	Approx.

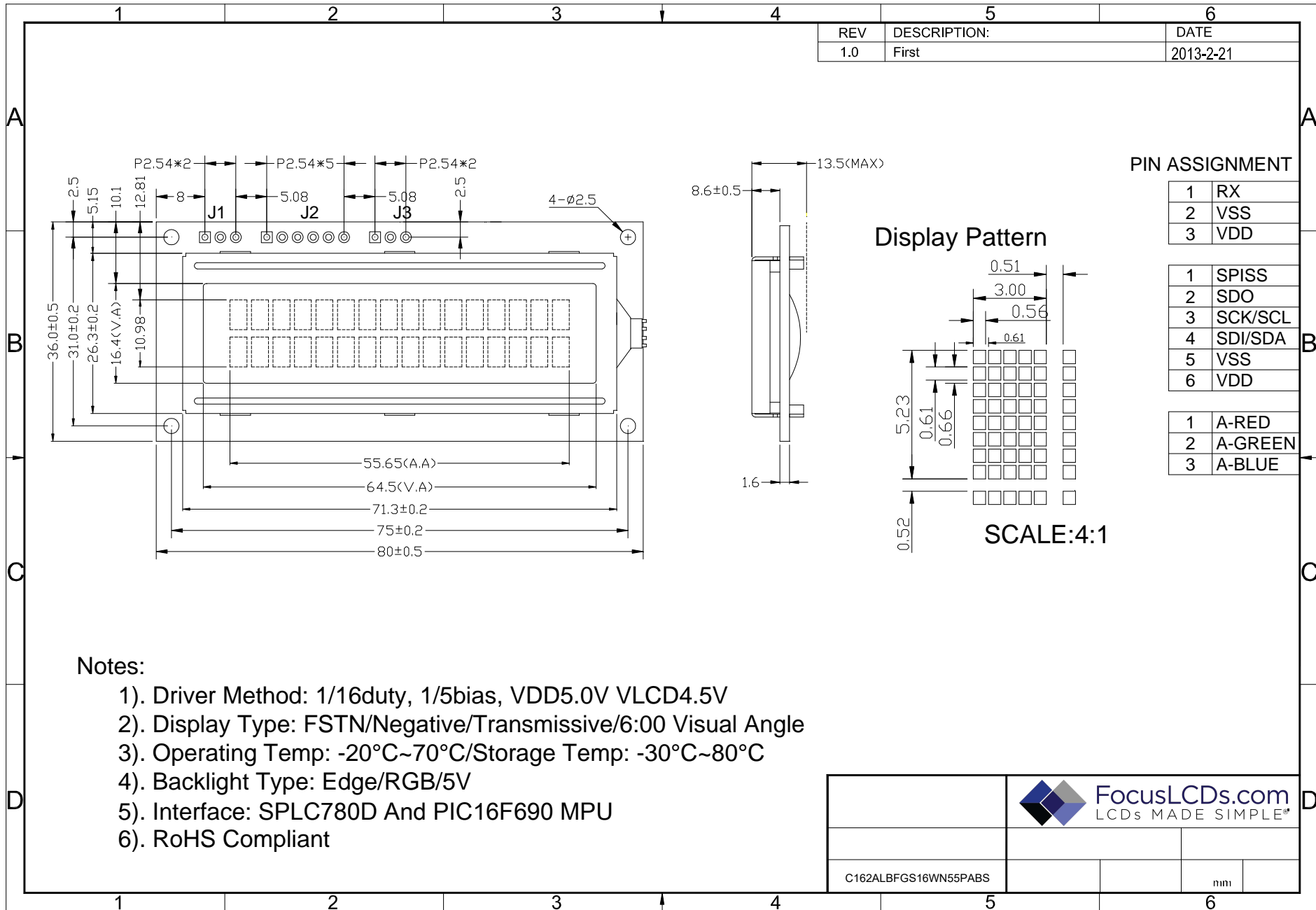

REV	DESCRIPTION:	DATE
1.0	First	2013-2-21

**PIN ASSIGNMENT**

1	RX
2	VSS
3	VDD
1	SPISS
2	SDO
3	SCK/SCL
4	SDI/SDA
5	VSS
6	VDD
1	A-RED
2	A-GREEN
3	A-BLUE

**Display Pattern**

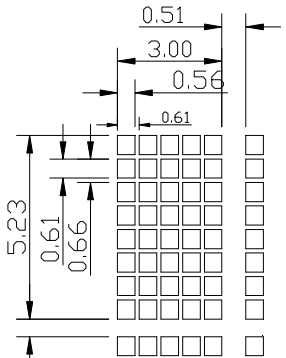

**SCALE:4:1**

**Notes:**

- 1). Driver Method: 1/16duty, 1/5bias, VDD5.0V VLCD4.5V
- 2). Display Type: FSTN/Negative/Transmissive/6:00 Visual Angle
- 3). Operating Temp: -20°C~70°C/Storage Temp: -30°C~80°C
- 4). Backlight Type: Edge/RGB/5V
- 5). Interface: SPLC780D And PIC16F690 MPU
- 6). RoHS Compliant

 <b>FocusLCDs.com</b> LCDs MADE SIMPLE®			
		C162ALBFGS16WN55PABS	
		mm	

## Absolute maximum ratings

Item	Symbol	Standard			Unit
Power voltage	$V_{DD}-V_{SS}$	0	-	7.0	V
Input voltage	$V_{IN}$	VSS	-	VDD	
Operating temperature range	$V_{OP}$	-20	-	+70	°C
Storage temperature range	$V_{ST}$	-30	-	+80	

## Interface pin description

Pin no.	Symbol	External connection	Function
1	RX	O	RS232 Serial input port
2	$V_{SS}$	Power supply	Signal ground for LCM (GND)
3	$V_{DD}$		Power supply for logic (+5V) for LCM
1	SPISS	O	SPI or I2C input port
2	SDO	O	SPI or I2C input port
3	SCK/SCL	O	SPI or I2C input port
4	SDI/SDA	O	SPI or I2C input port
5	$V_{SS}$	Power supply	Signal ground for LCM (GND)
6	$V_{DD}$		Power supply for logic (+5V) for LCM
1	A-RED	LED BKL power supply	Power supply for BKL
2	A-GREEN		Power supply for BKL
3	A-BLUE		Power supply for BKL

## Optical characteristics

FSTN type display module ( $T_a=25^{\circ}\text{C}$ ,  $V_{DD}=5.0\text{V}$ )

Item	Symbol	Condition	Min.	Typ.	Max.	Unit	
Viewing angle (6 O'clock)	Left--Right	$\theta$	Ta=25°C	-	60	-	deg
	Top--Bottom			-	70	-	
Contrast ratio	CR	Ta=25°C	3	5	-	-	
Response time	Rise		$t_r$	-	150	250	ms
	Tall	$t_f$	-	200	300		

## Electrical characteristics

DC characteristics

Parameter	Symbol	Conditions	Min.	Typ.	Max.	Unit
Input voltage	$V_{DD}$		4.7	5.0	5.5	
Supply current	$I_{DD}$	$T_a=25^{\circ}\text{C}$ , $V_{DD}=5.0\text{V}$	-	125	-	mA
Input leakage current	$I_{LKG}$		-	-	1.0	uA
"H" level input voltage	$V_{IH}$		2.2	-	$V_{DD}$	V
"L" level input voltage	$V_{IL}$	Twice initial value or less	0	-	0.6	
"H" level output voltage	$V_{OH}$	LOH=-0.25mA	2.4	-	-	
"L" level output voltage	$V_{OL}$	LOH=1.6mA	-	-	0.4	

### Backlight information (Ta =25°C)

Parameter	Symbol	Conditions	Min.	Typ.	Max.	Unit
Supply Current	I <sub>LED</sub>	V <sub>f</sub> =2.0V, Red	-	10	-	mA
		V <sub>f</sub> =3.0V, Green	-	15	-	
		V <sub>f</sub> =3.0V, Blue	-	15	-	
Supply voltage	V <sub>f</sub>	Red	1.8	-	2.2	V
		Green	2.8	-	3.3	
		Blue	2.8	-	3.3	
Reverse voltage	V <sub>R</sub>	Ta=25°C,	-	5.0	-	
Luminous Intensity	I <sub>V</sub>	Red	-	55	60	Cd/m <sup>2</sup>
		Green	-	190	200	
		Blue	-	25	30	
Peak wavelength	V <sub>IH</sub>	Red	630	-	645	nm
		Green	515	-	525	
		Blue	465	-	475	

## Communications

### I<sup>2</sup>C Communication

To enter the I<sup>2</sup>C mode, a jumper is placed on **R1** of the interface board and 2 pull-up resistors (nominal value of 1K to 10K Ohm), must be placed on SDA and SCK communication lines, R7 and R8.

The default I<sup>2</sup>C address is **50 (32 hex)**. The I<sup>2</sup>C address can be changed to any 8-bit value by command function, with the exception that the LSB (least significant bit) must always be '0'. Once the I<sup>2</sup>C address has been changed, it will be saved in the system memory, and it will revert back to the default address if either RS232 or SPI protocol is selected.

The I<sup>2</sup>C interface is capable of receiving data at up to 400KHz-clock rate.

### SPI Communication

To enter the SPI mode, a jumper is placed on **R2** of the interface board.

The SPI mode has a normally high level idle clock; data sampled on the rising edge of the clock and Slave Select is enabled.

### RS232 Communication

To enter the RS232 mode, both jumpers, R1 and R2 are removed.

The RS232 signal must be 5V, TTL compatible. The communication format is 8-bit data, one stop bit, no parity and no hand shaking. The default BAUD rate is 9600, and it is changeable with a command function, once the BAUD rate is changed, it will be saved in the system memory, and it can be reverted back to default BAUD rate if either I<sup>2</sup>C or SPI protocol is selected.

### Changing the I<sup>2</sup>C Slave Address

Syntax      hexadecimal 0xFE    0x62    [adr]

Parameter	Parameter	Length	Description
	[adr]	1 byte	New I <sup>2</sup> C address, 0x00 – 0xFE The LSB is always '0'.

Description    This command sets the I<sup>2</sup>C address, the address must be an even number, (LSB = 0). The address change requires 20 microsecond to take effect; therefore, the subsequent input must have an appropriate delay. The default I<sup>2</sup>C address can be

restored if SPI or RS232 is selected as the communication mode.  
 Default 0x50

## Changing BAUD Rate

Syntax      hexadecimal 0xFE    0x61    [baud]

Parameter	Parameter	Length	Description
	[baud]	1 byte	New RS232 BAUD Rate, 1 - 8

Description    This command sets the RS232 BAUD rate, the single byte parameter select the desired BAUD rate as in the table below. The new BAUD rate requires 20 microsecond to take effect, therefore, the subsequent input must have an appropriate delay. The default BAUD rate can be restored if I2C or SPI is selected as the communication mode. Illegal parameter input will be discarded.  
 Default 9600 BAUD

Parameter	BAUD
1	300
2	1200
3	2400
4	9600
5	14400
6	19.2K
7	57.6K
8	115.2K

## Build-In Functions

### Introduction

There several build-in functions in the serial interface to facilitate the LCD control, These functions eliminate the needs for end user to understand the HD44780 instruction set and timing requirements. It also provides control for features that are not accessible with a serial connection.

### Turn On Display

Syntax      hexadecimal 0xFE    0x41

Parameter	Parameter	Length	Description
	None	None	Turn on LCD screen

Description    This command turn on the LCD display screen, the display text is not altered.  
 Default        LCD screen is on

### Turn Off Display

Syntax      hexadecimal 0xFE    0x42

Parameter	Parameter	Length	Description
None	None		Turn off LCD screen

Description This command turn off the LCD display screen, the display text is not altered.  
 Default LCD screen is on

### Set Cursor Position

Syntax hexadecimal 0xFE 0x45 [pos]

Parameter	Parameter	Length	Description
[pos]	1 byte		Put cursor at location specified by [pos], 0x00 to 0x67

Description This command moves the cursor to a specified location where the next character will be displayed. A typical cursor position for a 4-line display is show below; a cursor position outside these ranges will not be viewable.

	Column1	Column20
Line1	0x00	0x13
Line 2	0x40	0x53
Line 3	0x14	0x27
Line 4	0x54	0x67

Default After a reset, the cursor is on position 0x00.

### Home Cursor

Syntax hexadecimal 0xFE 0x46

Parameter	Parameter	Length	Description
None	None		Position cursor at line 1 column 1

Description This command move the cursor to line 1, column 1 of the LCD screen, the display text is not altered.

Default None

### Turn On Underline Cursor

Syntax hexadecimal 0xFE 0x47

Parameter	Parameter	Length	Description
None	None		Turn on underline cursor

Description This command turn on the underline cursor, the cursor position is where the next character will appear.

Default The underline cursor is off.

### Turn Off Underline Cursor

Syntax hexadecimal 0xFE 0x48

---

Parameter	<u>Parameter</u>	<u>Length</u>	<u>Description</u>
	None	None	Turn off underline cursor
Description	This command turn off the underline cursor.		
Default	The underline cursor is off.		

### Move Cursor Left One Space

Syntax	hexadecimal 0xFE	0x49	
Parameter	<u>Parameter</u>	<u>Length</u>	<u>Description</u>
	None	None	Move cursor left 1 space
Description	This command move the cursor position left 1 space, regardless the cursor is displayed or not, and the displayed character is not altered		
Default	None		

### Move Cursor Right One Space

Syntax	hexadecimal 0xFE	0x4A	
Parameter	<u>Parameter</u>	<u>Length</u>	<u>Description</u>
	None	None	Move cursor right 1 space
Description	This command move the cursor position right 1 space, regardless the cursor is displayed or not, and the displayed character is not altered		
Default	None		

### Turn On Blinking Cursor

Syntax	hexadecimal 0xFE	0x4B	
Parameter	<u>Parameter</u>	<u>Length</u>	<u>Description</u>
	None	None	Turn on the blinking cursor
Description	This command turn on the blinking cursor, both the cursor and the character on the cursor will blink.		
Default	The blinking cursor is off.		

### Turn Off Blinking Cursor

Syntax	hexadecimal 0xFE	0x4C	
Parameter	<u>Parameter</u>	<u>Length</u>	<u>Description</u>
	None	None	Turn off the blinking cursor
Description	This command turn off the blinking cursor.		
Default	The blinking cursor is off.		

### Back Space



Syntax      hexadecimal 0xFE    0x4E

Parameter	Parameter	Length	Description
	None	None	Move cursor back one space and delete the character on the cursor.
Description	This command is destructive backspace, the cursor is moved back one space and the character on the cursor is deleted.		
Default	None.		

### Clear Screen

Syntax      hexadecimal 0xFE    0x51

Parameter	Parameter	Length	Description
	None	None	Clear LCD and move cursor to line 1 column 1.
Description	This command clears the entire display and place the cursor at line 1 column 1.		
Default	None.		

### Set Display Contrast

Syntax      hexadecimal 0xFE    0x52    [contrast]

Parameter	Parameter	Length	Description
	[contrast]	1 byte	Set the display contrast, value between 1 to 50
Description	This command set the LCD character display contrast, the contrast setting is between 1 to 50, where 50 is the highest contrast.		
Default	Default contrast value is 40.		

### Set Backlight Brightness

Syntax      hexadecimal 0xFE    0x53    [brightness]

Parameter	Parameter	Length	Description
	[brightness]	1 byte	Set the LCD backlight brightness level, value between 1 to 8
Description	This command set the LCD display backlight brightness level, the value is between 1 to 8. The backlight brightness level, of 1.		
Default	Default contrast value is 5.		

### Load Custom Characters

Syntax      hexadecimal 0xFE    0x54    [addr]    [d0 ...d7]

Parameter	Parameter	Length	Description
	[addr]	1 byte	Custom character address, 0 – 7
	[D0..D7]	8 bytes	Custom character pattern bit map
Description	There are space for eight user defined custom characters, this command load the custom character into one of the eight locations. The custom character pattern is bit mapped into 8 data bytes, the bit map for Spanish character '¿' is shown in table below, to display the custom		

character, user simply enter the address of the character (0 to 8).

Default        None.

Bit	7	6	5	4	3	2	1	0	Hex
Byte 1	0	0	0	0	0	1	0	0	0x04
Byte 2	0	0	0	0	0	0	0	0	0x00
Byte 3	0	0	0	0	0	1	0	0	0x04
Byte 4	0	0	0	0	1	0	0	0	0x08
Byte 5	0	0	0	1	0	0	0	0	0x10
Byte 6	0	0	0	1	0	0	0	1	0x11
Byte 7	0	0	0	0	1	1	1	0	0x0E
Byte 8	0	0	0	0	0	0	0	0	0x00

### Shift Display to the Left

Syntax        hexadecimal 0xFE    0x55

Parameter	Length	Description
None	None	Shift the LCD screen to the left one Place.

Description    This command shift the display one place to the left, the cursor position also moves with the display, and the display data is not altered.

Default        None

### Shift Display to the Right

Syntax        hexadecimal 0xFE    0x56

Parameter	Length	Description
None	None	Shift the LCD screen to the right one Place.

Description    This command shift the display one place to the right, the cursor position also moves with the display, and the display data is not altered.

Default        None

### Display Firmware Version Number

Syntax        hexadecimal 0xFE    0x70

Parameter	Length	Description
None	None	Display the firmware version number.

Description    This command display the micro-controller firmware version number.

Default        None.

### Display RS232 Baud Rate

Syntax        hexadecimal 0xFE    0x71

Parameter	Parameter	Length	Description
	None	None	Display Baud Rate

Description    This command display the current RS232 BAUD rate.  
 Default        None.

### Display I<sup>2</sup>C Address

Syntax        hexadecimal 0xFE    0x72

Parameter	Parameter	Length	Description
	None	None	Display I <sup>2</sup> C Address

Description    This command display the current I<sup>2</sup>C slave address.  
 Default        None.

### Direct HD44780 Command

Syntax        hexadecimal 0xFE    0xFE    [cmd]

Parameter	Parameter	Length	Description
	[cmd]	1 byte	Direct interface to the LCD controller, HD44780.

Description    This command is for advanced programmer, it allows LCD instruction to send directly to the SPLC780D controller.

Default        None.

### ASCII TEXT

To display normal text, just enter its ASCII number, a number from 0x00 to 0x07 displays the user defined custom character, 0x20 to 0x7F displays the stand set of characters. And numbers from 0xA0 to 0xFD display characters and symbols that are factory-masked on the SPLC780D controller and 0xFE is reserved for function command.

### Command Summary

Prefix	CMD	Param	Description
0xFE	0x41	None	Display on
0xFE	0x42	None	Display off
0xFE	0x45	1 Byte	Set cursor
0xFE	0x46	None	Cursor home
0xFE	0x47	None	Underline cursor on
0xFE	0x48	None	Underline cursor off
0xFE	0x49	None	Move cursor left one place
0xFE	0x4A	None	Move cursor right one place
0xFE	0x4B	None	Blinking cursor on
0xFE	0x4C	None	Blinking cursor off
0xFE	0x4E	None	Backspace

0xFE	0x51	None	Clear screen
0xFE	0x52	1 Byte	Set contrast
0xFE	0x53	1 Byte	Set backlight brightness
0xFE	0x54	9 Byte	Load custom character
0xFE	0x55	None	Move display one place to the left
0xFE	0x56	None	Move display one place to the right
0xFE	0x61	1 Byte	Change RS232 BAUD rate 232
0xFE	0x62	1 Byte	Change I2C address
0xFE	0x70	None	Display firmware version number
0xFE	0x71	None	Display RS232 BAUD rate
0xFE	0x72	None	Display I2C address
0xFE	0xFE	1 Byte	Send control byte to

## 11. Standard character pattern

Lower 4 Bits	Upper 4 Bits	0000	0001	0010	0011	0100	0101	0110	0111	1000	1001	1010	1011	1100	1101	1110	1111
xxxx0000	CG RAM (1)			0	1	P	`	P				-	夕	三	α	P	
xxxx0001	(2)		!	1	A	Q	a	q				。	ア	チ	△	ä	9
xxxx0010	(3)		"	2	B	R	b	r				「	イ	ツ	×	ß	θ
xxxx0011	(4)		#	3	C	S	c	s				」	ウ	テ	ε	ε	∞
xxxx0100	(5)		\$	4	D	T	d	t				、	エ	ト	†	μ	∞
xxxx0101	(6)		%	5	E	U	e	u				・	オ	ナ	1	ε	ü
xxxx0110	(7)		&	6	F	V	f	v				ヲ	カ	ニ	ヨ	ρ	Σ
xxxx0111	(8)		'	7	G	W	g	w				フ	キ	ヌ	ラ	9	π
xxxx1000	(1)		(	8	H	X	h	x				イ	ク	ネ	リ	、	×
xxxx1001	(2)		)	9	I	Y	i	y				ウ	ケ	ル	ル	、	γ
xxxx1010	(3)		*	:	J	Z	j	z				エ	コ	ン	レ	J	≠
xxxx1011	(4)		+	;	K	[	k	[				オ	サ	ヒ	ロ	*	≠
xxxx1100	(5)		,	<	L	¥	l	l				カ	シ	フ	ワ	φ	≠
xxxx1101	(6)		-	=	M	]	m	]				ユ	ス	△	△	≠	÷
xxxx1110	(7)		.	>	N	^	n	^				ヨ	セ	ホ	°	ñ	
xxxx1111	(8)		/	?	O	_	o	_				ッ	リ	マ	°	ö	■

## QUALITY SPECIFICATIONS

### Standard of the product appearance test

Manner of appearance test: The inspection should be performed in using 20W x 2 fluorescent lamps. Distance between LCM and fluorescent lamps should be 100 cm or more. Distance between LCM and inspector eyes should be 30 cm or more.

Viewing direction for inspection is 45° from vertical against LCM.

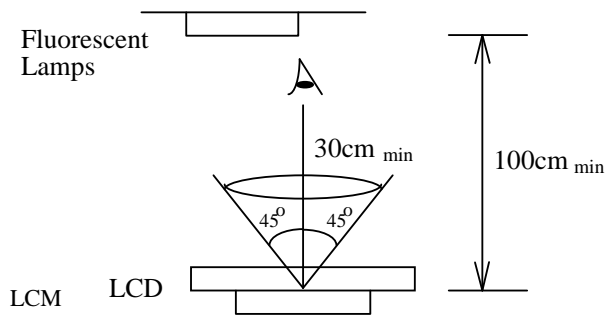

Definition of zone:

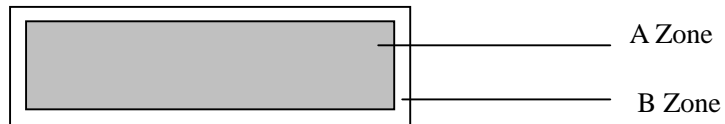

A Zone: Active display area (minimum viewing area).

B Zone: Non-active display area (outside viewing area).

## 12.2 Specification of quality assurance

AQL inspection standard

Sampling method: MIL-STD-105E, Level II, single sampling

Defect classification **(Note: \* is not including)**

Classify	Item		Note	AQL
Major	Display state	Short or open circuit	1	0.65
		LC leakage		
		Flickering		
		No display		
		Wrong viewing direction		
		Contrast defect (dim, ghost)	2	
	Back-light	1,8		
	Non-display	Flat cable or pin reverse	10	
Wrong or missing component		11		
Minor	Display state	Background color deviation	2	1.0
		Black spot and dust	3	
		Line defect, Scratch	4	
		Rainbow	5	
		Chip	6	
		Pin hole	7	
	Polarizer	Protruded	12	
		Bubble and foreign material	3	
	Soldering	Poor connection	9	
	Wire	Poor connection	10	
	TAB	Position, Bonding strength	13	

**Note on defect classification**

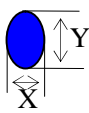
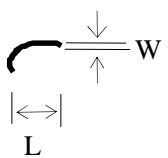
No.	Item	Criterion																				
1	Short or open circuit	Not allow																				
	LC leakage																					
	Flickering																					
	No display																					
	Wrong viewing direction																					
	Wrong Back-light																					
2	Contrast defect	Refer to approval sample																				
	Background color deviation																					
3	Point defect, Black spot, dust (including Polarizer)  $\phi = (X+Y)/2$	 <table border="1" data-bbox="861 929 1300 1220"> <thead> <tr> <th>Point Size</th> <th>Acceptable Qty.</th> </tr> </thead> <tbody> <tr> <td><math>\phi \leq 0.10</math></td> <td>Disregard</td> </tr> <tr> <td><math>0.10 &lt; \phi \leq 0.20</math></td> <td>3</td> </tr> <tr> <td><math>0.20 &lt; \phi \leq 0.25</math></td> <td>2</td> </tr> <tr> <td><math>0.25 &lt; \phi \leq 0.30</math></td> <td>1</td> </tr> <tr> <td><math>\phi &gt; 0.30</math></td> <td>0</td> </tr> </tbody> </table> <p style="text-align: right;">Unit: mm</p>	Point Size	Acceptable Qty.	$\phi \leq 0.10$	Disregard	$0.10 < \phi \leq 0.20$	3	$0.20 < \phi \leq 0.25$	2	$0.25 < \phi \leq 0.30$	1	$\phi > 0.30$	0								
Point Size	Acceptable Qty.																					
$\phi \leq 0.10$	Disregard																					
$0.10 < \phi \leq 0.20$	3																					
$0.20 < \phi \leq 0.25$	2																					
$0.25 < \phi \leq 0.30$	1																					
$\phi > 0.30$	0																					
4	Line defect, Scratch	 <table border="1" data-bbox="790 1355 1340 1624"> <thead> <tr> <th colspan="2">Line</th> <th>Acceptable Qty.</th> </tr> <tr> <th>L</th> <th>W</th> <th></th> </tr> </thead> <tbody> <tr> <td>---</td> <td><math>0.015 \geq W</math></td> <td>Disregard</td> </tr> <tr> <td><math>3.0 \geq L</math></td> <td><math>0.03 \geq W</math></td> <td rowspan="2">2</td> </tr> <tr> <td><math>2.0 \geq L</math></td> <td><math>0.05 \geq W</math></td> </tr> <tr> <td><math>1.0 \geq L</math></td> <td><math>0.1 &gt; W</math></td> <td>1</td> </tr> <tr> <td>---</td> <td><math>0.05 &lt; W</math></td> <td>Applied as point defect</td> </tr> </tbody> </table> <p style="text-align: right;">Unit: mm</p>	Line		Acceptable Qty.	L	W		---	$0.015 \geq W$	Disregard	$3.0 \geq L$	$0.03 \geq W$	2	$2.0 \geq L$	$0.05 \geq W$	$1.0 \geq L$	$0.1 > W$	1	---	$0.05 < W$	Applied as point defect
Line		Acceptable Qty.																				
L	W																					
---	$0.015 \geq W$	Disregard																				
$3.0 \geq L$	$0.03 \geq W$	2																				
$2.0 \geq L$	$0.05 \geq W$																					
$1.0 \geq L$	$0.1 > W$	1																				
---	$0.05 < W$	Applied as point defect																				
5	Rainbow	Not more than two color changes across the viewing area.																				

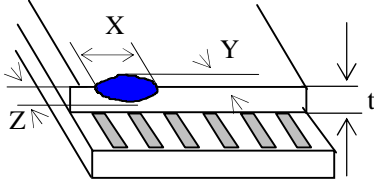
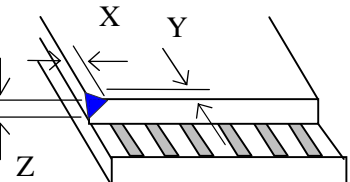
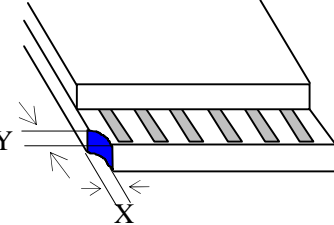
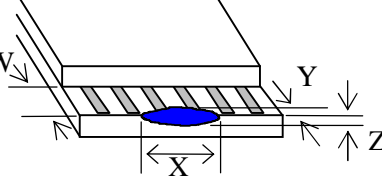
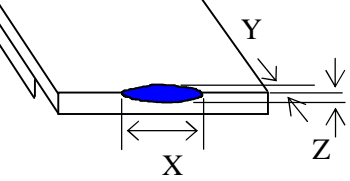

No	Item	Criterion																																	
6	<p>Chip</p> <p>Remark:</p> <p>X: Length direction</p> <p>Y: Short direction</p> <p>Z: Thickness direction</p> <p>t: Glass thickness</p> <p>W: Terminal Width</p>	 <p>Acceptable criterion</p> <table border="1" data-bbox="933 369 1324 448"> <thead> <tr> <th>X</th> <th>Y</th> <th>Z</th> </tr> </thead> <tbody> <tr> <td><math>\leq 2</math></td> <td>0.5mm</td> <td><math>\leq t/2</math></td> </tr> </tbody> </table>  <p>Acceptable criterion</p> <table border="1" data-bbox="925 683 1324 761"> <thead> <tr> <th>X</th> <th>Y</th> <th>Z</th> </tr> </thead> <tbody> <tr> <td><math>\leq 2</math></td> <td>0.5mm</td> <td><math>\leq t</math></td> </tr> </tbody> </table>  <p>Acceptable criterion</p> <table border="1" data-bbox="933 974 1324 1086"> <thead> <tr> <th>X</th> <th>Y</th> <th>Z</th> </tr> </thead> <tbody> <tr> <td><math>\leq 3</math></td> <td><math>\leq 2</math></td> <td><math>\leq t</math></td> </tr> <tr> <td colspan="2">shall not reach to ITO</td> <td></td> </tr> </tbody> </table>  <p>Acceptable criterion</p> <table border="1" data-bbox="925 1355 1324 1433"> <thead> <tr> <th>X</th> <th>Y</th> <th>Z</th> </tr> </thead> <tbody> <tr> <td>Disregard</td> <td><math>\leq 0.2</math></td> <td><math>\leq t</math></td> </tr> </tbody> </table>  <p>Acceptable criterion</p> <table border="1" data-bbox="925 1635 1292 1713"> <thead> <tr> <th>X</th> <th>Y</th> <th>Z</th> </tr> </thead> <tbody> <tr> <td><math>\leq 5</math></td> <td><math>\leq 2</math></td> <td><math>\leq t/3</math></td> </tr> </tbody> </table>	X	Y	Z	$\leq 2$	0.5mm	$\leq t/2$	X	Y	Z	$\leq 2$	0.5mm	$\leq t$	X	Y	Z	$\leq 3$	$\leq 2$	$\leq t$	shall not reach to ITO			X	Y	Z	Disregard	$\leq 0.2$	$\leq t$	X	Y	Z	$\leq 5$	$\leq 2$	$\leq t/3$
X	Y	Z																																	
$\leq 2$	0.5mm	$\leq t/2$																																	
X	Y	Z																																	
$\leq 2$	0.5mm	$\leq t$																																	
X	Y	Z																																	
$\leq 3$	$\leq 2$	$\leq t$																																	
shall not reach to ITO																																			
X	Y	Z																																	
Disregard	$\leq 0.2$	$\leq t$																																	
X	Y	Z																																	
$\leq 5$	$\leq 2$	$\leq t/3$																																	

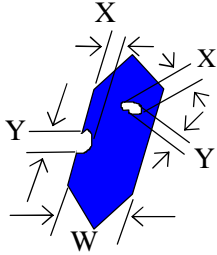
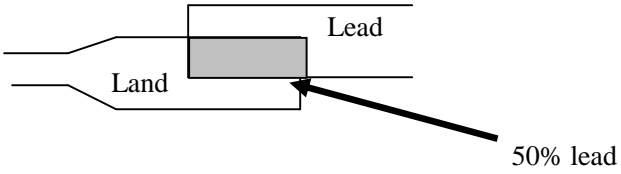
No.	Item	Criterion								
7	Segment pattern $W = \text{Segment width}$ $\phi = (X+Y)/2$	(1) Pin hole $\phi < 0.10\text{mm}$ is acceptable.  <table border="1" data-bbox="853 582 1316 757"> <thead> <tr> <th>Point Size</th> <th>Acceptable Qty</th> </tr> </thead> <tbody> <tr> <td><math>\phi \leq 1/4W</math></td> <td>Disregard</td> </tr> <tr> <td><math>1/4W &lt; \phi \leq 1/2W</math></td> <td>1</td> </tr> <tr> <td><math>\phi &gt; 1/2W</math></td> <td>0</td> </tr> </tbody> </table> <p style="text-align: right;">Unit: mm</p>	Point Size	Acceptable Qty	$\phi \leq 1/4W$	Disregard	$1/4W < \phi \leq 1/2W$	1	$\phi > 1/2W$	0
Point Size	Acceptable Qty									
$\phi \leq 1/4W$	Disregard									
$1/4W < \phi \leq 1/2W$	1									
$\phi > 1/2W$	0									
8	Back-light	(1) The color of backlight should correspond its specification. (2) Not allow flickering								
9	Soldering	(1) Not allow heavy dirty and solder ball on PCB. (The size of dirty refer to point and dust defect) (2) Over 50% of lead should be soldered on Land. 								
10	Wire	(1) Copper wire should not be rusted (2) Not allow crack on copper wire connection. (3) Not allow reversing the position of the flat cable. (4) Not allow exposed copper wire inside the flat cable.								
11*	PCB	(1) Not allow screw rust or damage. (2) Not allow missing or wrong putting of component.								

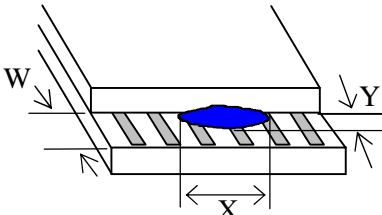
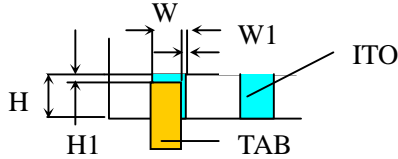
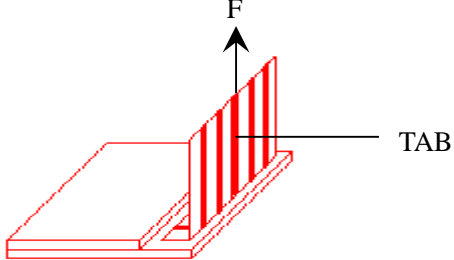
No	Item	Criterion
12	Protruded W: Terminal Width	 <p>Acceptable criteria:  <math>Y \leq 0.4</math></p>
13	TAB	<p>1. Position</p>  <div style="border: 1px solid black; padding: 5px; width: fit-content; margin-left: auto; margin-right: auto;"> <math>W1 \leq 1/3W</math>  <math>H1 \leq 1/3H</math> </div> <p>2. TAB bonding strength test</p>  <p> <math>P (=F/TAB \text{ bonding width}) \geq 650\text{gf/cm}</math> ,(speed rate: 1mm/min)            5pcs per SOA (shipment)         </p>
14	Total no. of acceptable Defect	<p>A. Zone</p> <p>Maximum 2 minor non-conformities per one unit.            Defect distance: each point to be separated over 10mm</p> <p>B. Zone</p> <p>It is acceptable when it is no trouble for quality and assembly in customer's end product.</p>

### 12.3 Reliability of LCM

Reliability test condition:

Item	Condition	Time (hrs)	Assessment
High temp. Storage	80°C	48	No abnormalities in functions and appearance
High temp. Operating	70°C	48	
Low temp. Storage	-30°C	48	
Low temp. Operating	-20°C	48	
Humidity	40°C/ 90%RH	48	
Temp. Cycle	0°C ← 25°C → 50°C (30 min ← 5 min → 30min)	10cycles	

Recovery time should be 24 hours minimum. Moreover, functions, performance and appearance shall be free from remarkable deterioration within 50,000 hours under ordinary operating and storage conditions room temperature (20±8°C), normal humidity (below 65% RH), and in the area not exposed to direct sun light.

### 12.4 Precaution for using LCD/LCM

LCD/LCM is assembled and adjusted with a high degree of precision. Do not attempt to make any alteration or modification. The followings should be noted.

#### General Precautions:

1. LCD panel is made of glass. Avoid excessive mechanical shock or applying strong pressure onto the surface of display area.
2. The polarizer used on the display surface is easily scratched and damaged. Extreme care should be taken when handling. To clean dust or dirt off the display surface, wipe gently with cotton, or other soft material soaked with isopropyl alcohol, ethyl alcohol or trichlorotrifluoroethane, do not use water, ketone or aromatics and never scrub hard.
3. Do not tamper in any way with the tabs on the metal frame.
4. Do not make any modification on the PCB
5. When mounting a LCM, make sure that the PCB is not under any stress such as bending or twisting. Elastomer contacts are very delicate and missing pixels could result from slight dislocation of any of the elements.
6. Avoid pressing on the metal bezel, otherwise the elastomer connector could be deformed and lose contact, resulting in missing pixels and also cause rainbow on the display.
7. Be careful not to touch or swallow liquid crystal that might leak from a damaged cell. Any liquid crystal adheres to skin or clothes, wash it off immediately with soap and water.

#### Static Electricity Precautions:

1. CMOS-LSI is used for the module circuit; therefore operators should be grounded whenever he/she comes into contact with the module.
2. Do not touch any of the conductive parts such as the LSI pads; the copper leads on the PCB and the interface terminals with any parts of the human body.
3. Do not touch the connection terminals of the display with bare hand; it will cause disconnection or

- defective insulation of terminals.
4. The modules should be kept in anti-static bags or other containers resistant to static for storage.
  5. Only properly grounded soldering irons should be used.
  6. If an electric screwdriver is used, it should be grounded and shielded to prevent sparks.
  7. The normal static prevention measures should be observed for work clothes and working benches.
  8. Since dry air is inductive to static, a relative humidity of 50-60% is recommended.

### **Soldering Precautions:**

1. Soldering should be performed only on the I/O terminals.
2. Use soldering irons with proper grounding and no leakage.
3. Soldering temperature:  $280^{\circ}\text{C}\pm 10^{\circ}\text{C}$
4. Soldering time: 3 to 4 second.
5. Use eutectic solder with resin flux filling.
6. If flux is used, the LCD surface should be protected to avoid spattering flux.
7. Flux residue should be removed.

### **Operation Precautions:**

1. The viewing angle can be adjusted by varying the LCD driving voltage  $V_o$ .
2. Since applied DC voltage causes electro-chemical reactions, which deteriorate the display, the applied pulse waveform should be a symmetric waveform such that no DC component remains. Be sure to use the specified operating voltage.
3. Driving voltage should be kept within specified range; excess voltage will shorten display life.
4. Response time increases with decrease in temperature.
5. Display color may be affected at temperatures above its operational range.
6. Keep the temperature within the specified range usage and storage. Excessive temperature and humidity could cause polarization degradation, polarizer peel-off or generate bubbles.
7. For long-term storage over  $40^{\circ}\text{C}$  is required, the relative humidity should be kept below 60%, and avoid direct sunlight.