

## SUMMARY



Image is for illustrative purpose only

### # Wires

Low voltage 4

Series	0B
Termination type	Male crimp
IP rating	50
AWG wire size	26.00 - 22.00
Cable Ø	4.30 - 5.20 mm
Status	active
Matching parts	<a href="#">EGC.0B.304.CLL</a>

### Download

[Request a quote](#)

[Eplan](#)

[Catalog](#)

## TECHNICAL DETAILS

### Mechanics

Shell Style/Model	FP*: Elbow (90°) plug with cable collet
Keying	2 keys (alpha=90, plug: male contacts, receptacle: female contacts)
Housing Material	Brass (chrome plated [SAE AMS 2460]) shell and collet nut, nickel plated [SAE AMS QQ N 290] brass latch sleeve and mid pieces
Weight	12.32 g

### Performance

Configuration	0B.304 : 4 Low Voltage
Insulator	Y: PEEK for crimp contacts
Rated Current	7 Amps

### Specifications

Contact Type: Crimp  
Contact Retention: 22 N  
Contact Dia.: 0.7 mm (0.028in)  
Bucket Dia.: 0.8 mm (0.031in)  
Min. Conductor: 0.14 mm<sup>2</sup> (AWG 26)  
Max. Conductor: 0.34 mm<sup>2</sup> (AWG 22)  
R (max): 6.1 mOhm  
Vtest (contact-contact): 1350 V (AC), 1910 V (DC)

LEMO products and services are provided "as is". LEMO makes no warranties or representations with regard to LEMO product & services or use of them, express, implied or statutory, including for accuracy, completeness, or security. The user is fully responsible for his products and applications using LEMO components.

Vtest (contact-shell): 1100 V (AC), 1560 V (DC)

## Others

Endurance (Shell): 5000  
Temp (min / max): -55°C / +250°C  
Humidity (max): ≤95% [at 60 deg C / 140 F]  
Vibration: 15 g [10 Hz - 2000 Hz]  
Shock Resistance: 100 g [ 6 ms]  
Climatical Category: 50/175/21  
Shielding (min): 75 dB (10 MHz)  
Shielding (min): 40 dB (1 GHz)  
Salt Spray Corrosion: >1000 hr

## DRAWINGS

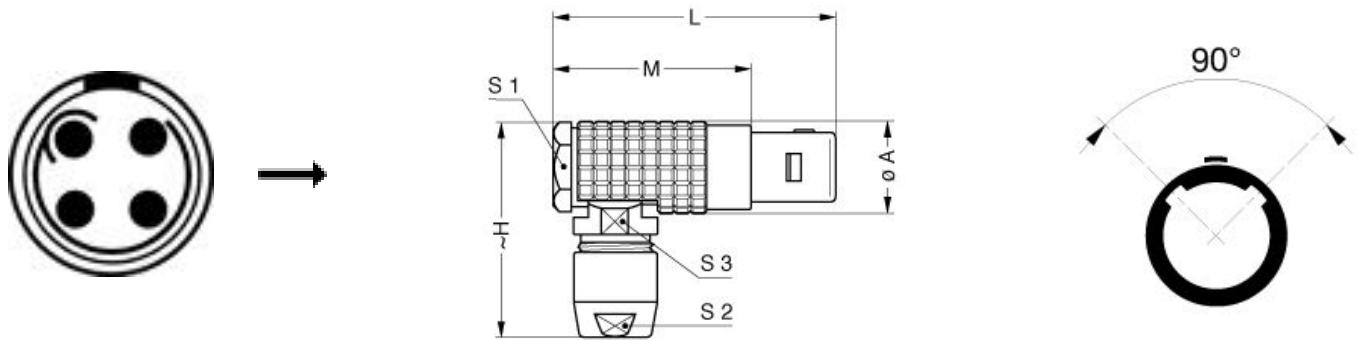

## Dimensions

	A	H	L	M	S1	S2	S3
mm.	9.5	23	30	20	8	7	8
in.	0,37	0,91	1,18	0,79	0,31	0,28	0,31







## RECOMMENDED BY LEMO

### Tools

LEMO products and services are provided "as is". LEMO makes no warranties or representations with regard to LEMO product & services or use of them, express, implied or statutory, including for accuracy, completeness, or security. The user is fully responsible for his products and applications using LEMO components.

Crimp Tool: [DPC.91.701.V](#)  
 Crimp settings: AWG/Selector = 22-24-26/6-5-5  
 Positionner: [DCE.91.070.BVC](#)  
 Extractor: [DCF.92.070.3LT](#)  
 Replacement contact: FGG.0B.555.ZZC  
 Spanner wrench: [DCD.0B.005.PA070](#)

## Cables

CMN.04.T22.047QGC	TPR	Grey	
CMN.04.T22.048QGZE	TPR (medical)	Grey	
140240	PVC	Black	
140250	PVC	Grey	
40260	PVC	Black	
4080	PVC	Grey	
4221	PVC	Black	
4280	PVC	Black	
80080	PVC	Grey	
80082	PVC	Red	
80084	PVC	Black	

*LEMO products and services are provided "as is". LEMO makes no warranties or representations with regard to LEMO product & services or use of them, express, implied or statutory, including for accuracy, completeness, or security. The user is fully responsible for his products and applications using LEMO components.*