

# MMBT6428LT1G, MMBT6429LT1G, NSVMMBT6429LT1G

## Amplifier Transistors

### NPN Silicon



ON Semiconductor®

[www.onsemi.com](http://www.onsemi.com)

#### Features

- NSV Prefix for Automotive and Other Applications Requiring Unique Site and Control Change Requirements; AEC-Q101 Qualified and PPAP Capable
- These Devices are Pb-Free, Halogen Free/BFR Free and are RoHS Compliant

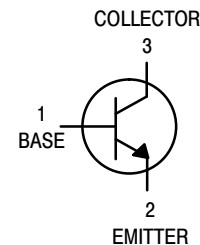

#### MAXIMUM RATINGS

Rating	Symbol	6428LT1	6429LT1	Unit
Collector–Emitter Voltage	$V_{CEO}$	50	45	Vdc
Collector–Base Voltage	$V_{CBO}$	60	55	Vdc
Emitter–Base Voltage	$V_{EBO}$	6.0		Vdc
Collector Current – Continuous	$I_C$	200		mAdc

Stresses exceeding those listed in the Maximum Ratings table may damage the device. If any of these limits are exceeded, device functionality should not be assumed, damage may occur and reliability may be affected.

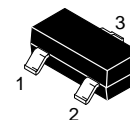

SOT-23 (TO-236)  
CASE 318  
STYLE 6

#### THERMAL CHARACTERISTICS

Rating	Symbol	Value	Unit
Total Device Dissipation FR-5 Board (Note 1) $T_A = 25^\circ\text{C}$ Derate above $25^\circ\text{C}$	$P_D$	225	mW
		1.8	mW/ $^\circ\text{C}$
Thermal Resistance, Junction–to–Ambient	$R_{\theta JA}$	556	$^\circ\text{C}/\text{W}$
Total Device Dissipation Alumina Substrate, (Note 2) $T_A = 25^\circ\text{C}$ Derate above $25^\circ\text{C}$	$P_D$	300	mW
		2.4	mW/ $^\circ\text{C}$
Thermal Resistance, Junction–to–Ambient	$R_{\theta JA}$	417	$^\circ\text{C}/\text{W}$
Junction and Storage Temperature	$T_J, T_{stg}$	-55 to +150	$^\circ\text{C}$

1. FR-5 =  $1.0 \times 0.75 \times 0.062$  in.
2. Alumina =  $0.4 \times 0.3 \times 0.024$  in. 99.5% alumina.

#### MARKING DIAGRAM

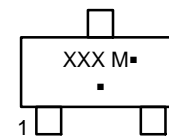

XXX = Specific Device Code  
MMBT6428LT1 – 1KM  
NSV/MMBT6429LT1 – M1L  
M = Date Code\*  
▪ = Pb-Free Package

(Note: Microdot may be in either location)

\*Date Code orientation and/or overbar may vary depending upon manufacturing location.

#### ORDERING INFORMATION

Device	Package	Shipping†
MMBT6428LT1G	SOT-23 (Pb-Free)	3000 Tape & Reel
MMBT6429LT1G	SOT-23 (Pb-Free)	3000 Tape & Reel
NSVMMBT6429LT1G	SOT-23 (Pb-Free)	3000 Tape & Reel

†For information on tape and reel specifications, including part orientation and tape sizes, please refer to our Tape and Reel Packaging Specifications Brochure, BRD8011/D.

# MMBT6428LT1G, MMBT6429LT1G, NSVMMBT6429LT1G

## ELECTRICAL CHARACTERISTICS (T<sub>A</sub> = 25°C unless otherwise noted)

Characteristic	Symbol	Min	Max	Unit
<b>OFF CHARACTERISTICS</b>				
Collector–Emitter Breakdown Voltage (I <sub>C</sub> = 1.0 mA <sub>dc</sub> , I <sub>B</sub> = 0) (I <sub>C</sub> = 1.0 mA <sub>dc</sub> , I <sub>B</sub> = 0)	V <sub>(BR)CEO</sub>	50 45	– –	V <sub>dc</sub>
Collector–Base Breakdown Voltage (I <sub>C</sub> = 0.1 mA <sub>dc</sub> , I <sub>E</sub> = 0) (I <sub>C</sub> = 0.1 mA <sub>dc</sub> , I <sub>E</sub> = 0)	V <sub>(BR)CBO</sub>	60 55	– –	V <sub>dc</sub>
Collector Cutoff Current (V <sub>CE</sub> = 30 V <sub>dc</sub> )	I <sub>CES</sub>	–	0.1	μA <sub>dc</sub>
Collector Cutoff Current (V <sub>CB</sub> = 30 V <sub>dc</sub> , I <sub>E</sub> = 0)	I <sub>CBO</sub>	–	0.01	μA <sub>dc</sub>
Emitter Cutoff Current (V <sub>EB</sub> = 5.0 V <sub>dc</sub> , I <sub>C</sub> = 0)	I <sub>EBO</sub>	–	0.01	μA <sub>dc</sub>

## ON CHARACTERISTICS

DC Current Gain (I <sub>C</sub> = 0.01 mA <sub>dc</sub> , V <sub>CE</sub> = 5.0 V <sub>dc</sub> )  (I <sub>C</sub> = 0.1 mA <sub>dc</sub> , V <sub>CE</sub> = 5.0 V <sub>dc</sub> )  (I <sub>C</sub> = 1.0 mA <sub>dc</sub> , V <sub>CE</sub> = 5.0 V <sub>dc</sub> )  (I <sub>C</sub> = 10 mA <sub>dc</sub> , V <sub>CE</sub> = 5.0 V <sub>dc</sub> )	h <sub>FE</sub>	250 500  250 500  250 500  250 500	– –  650 1250  – –  – –	–
Collector–Emitter Saturation Voltage (I <sub>C</sub> = 10 mA <sub>dc</sub> , I <sub>B</sub> = 0.5 mA <sub>dc</sub> ) (I <sub>C</sub> = 100 mA <sub>dc</sub> , I <sub>B</sub> = 5.0 mA <sub>dc</sub> )	V <sub>CE(sat)</sub>	– –	0.2 0.6	V <sub>dc</sub>
Base–Emitter On Voltage (I <sub>C</sub> = 1.0 mA <sub>dc</sub> , V <sub>CE</sub> = 5.0 V <sub>dc</sub> )	V <sub>BE(on)</sub>	0.56	0.66	V <sub>dc</sub>

## SMALL–SIGNAL CHARACTERISTICS

Current–Gain – Bandwidth Product (I <sub>C</sub> = 1.0 mA <sub>dc</sub> , V <sub>CE</sub> = 5.0 V <sub>dc</sub> , f = 100 MHz)	f <sub>T</sub>	100	700	MHz
Output Capacitance (V <sub>CB</sub> = 10 V <sub>dc</sub> , I <sub>E</sub> = 0, f = 1.0 MHz)	C <sub>obo</sub>	–	3.0	pF
Input Capacitance (V <sub>EB</sub> = 0.5 V <sub>dc</sub> , I <sub>C</sub> = 0, f = 1.0 MHz)	C <sub>ibo</sub>	–	8.0	pF

Product parametric performance is indicated in the Electrical Characteristics for the listed test conditions, unless otherwise noted. Product performance may not be indicated by the Electrical Characteristics if operated under different conditions.

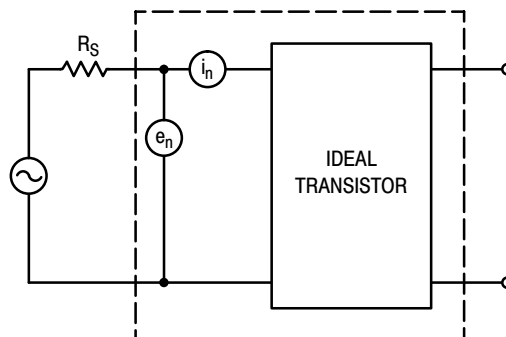

Figure 1. Transistor Noise Model

# MMBT6428LT1G, MMBT6429LT1G, NSVMMBT6429LT1G

## NOISE CHARACTERISTICS

( $V_{CE} = 5.0 \text{ Vdc}$ ,  $T_A = 25^\circ\text{C}$ )

### NOISE VOLTAGE

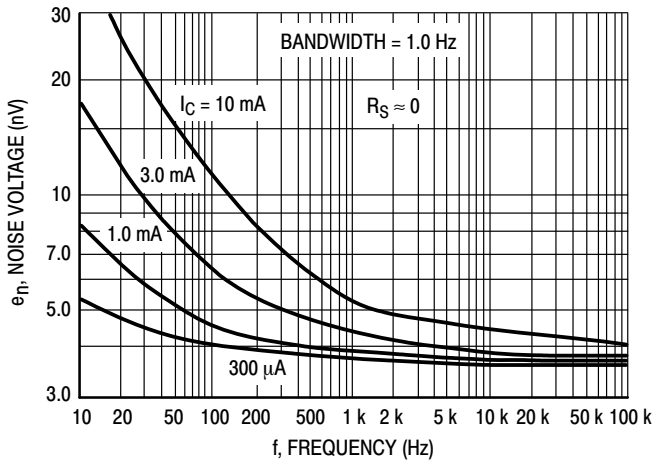

Figure 2. Effects of Frequency

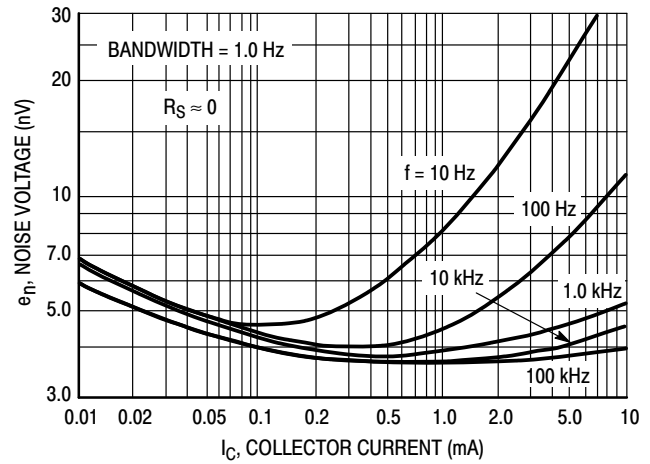

Figure 3. Effects of Collector Current

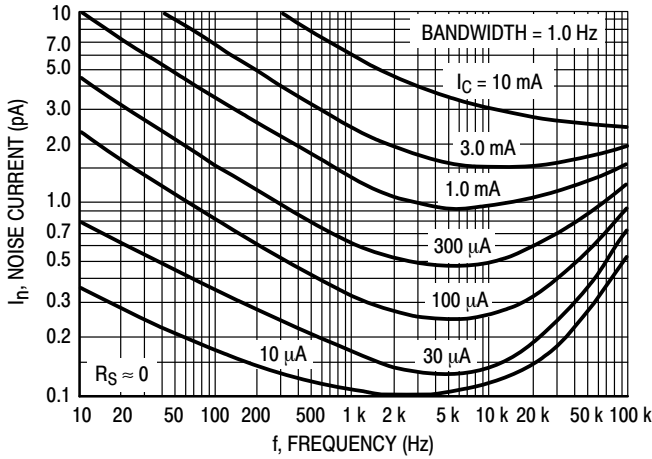

Figure 4. Noise Current

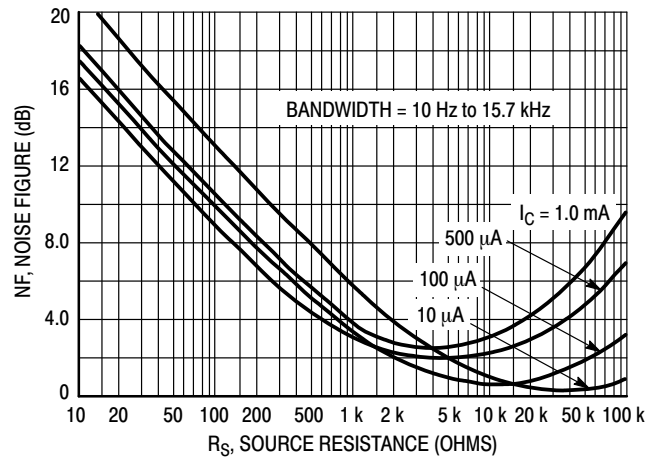

Figure 5. Wideband Noise Figure

### 100 Hz NOISE DATA

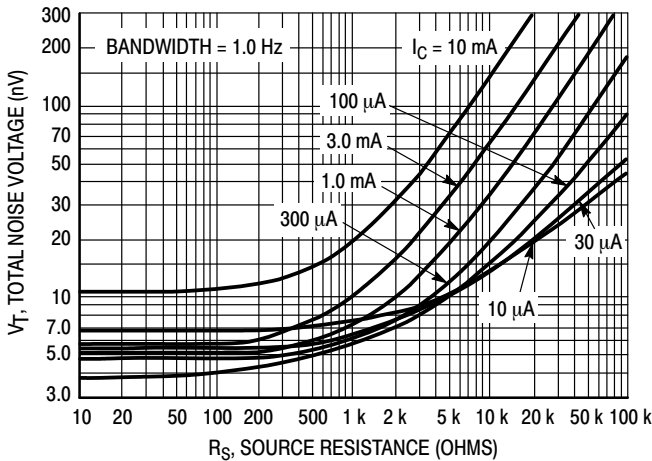

Figure 6. Total Noise Voltage

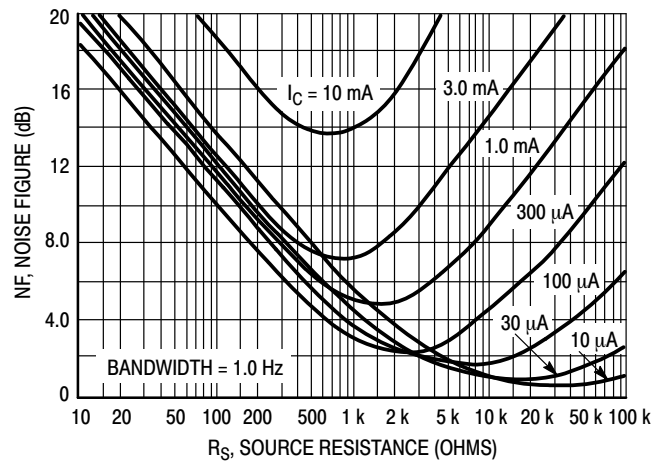

Figure 7. Noise Figure

MMBT6428LT1G, MMBT6429LT1G, NSVMMBT6429LT1G

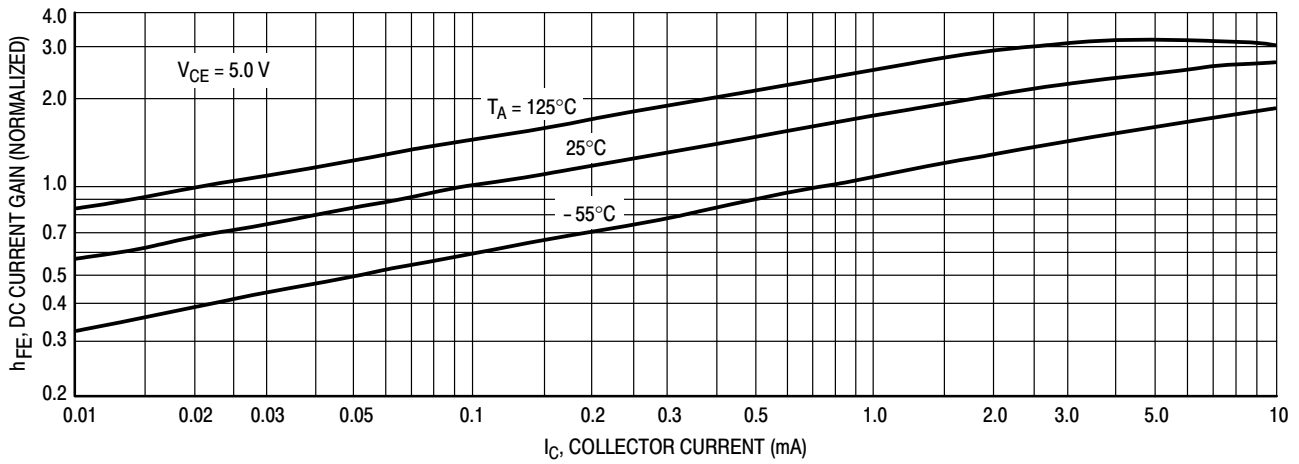

Figure 8. DC Current Gain

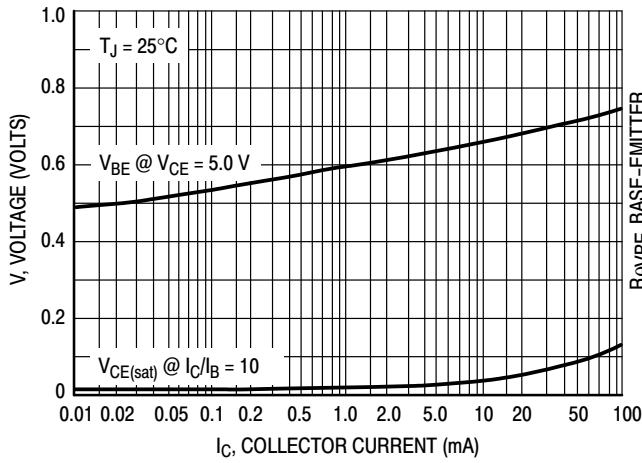

Figure 9. "On" Voltages

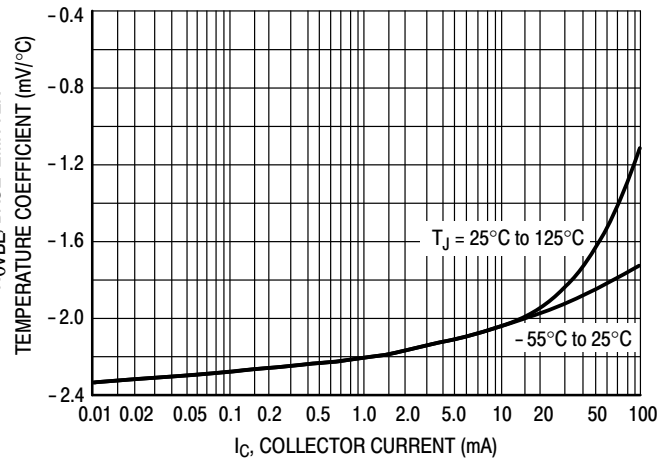

Figure 10. Temperature Coefficients

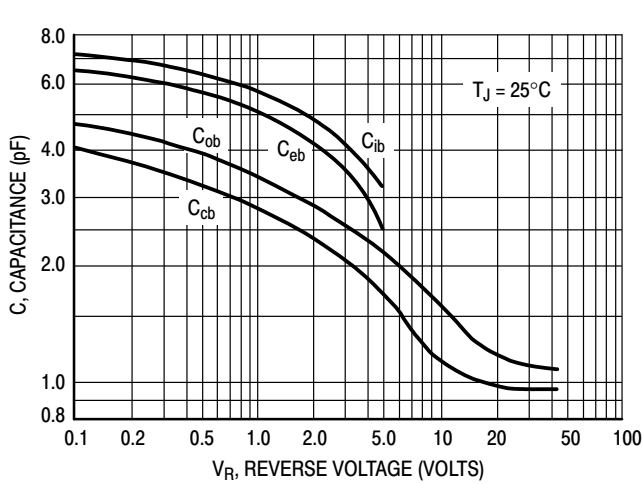

Figure 11. Capacitance

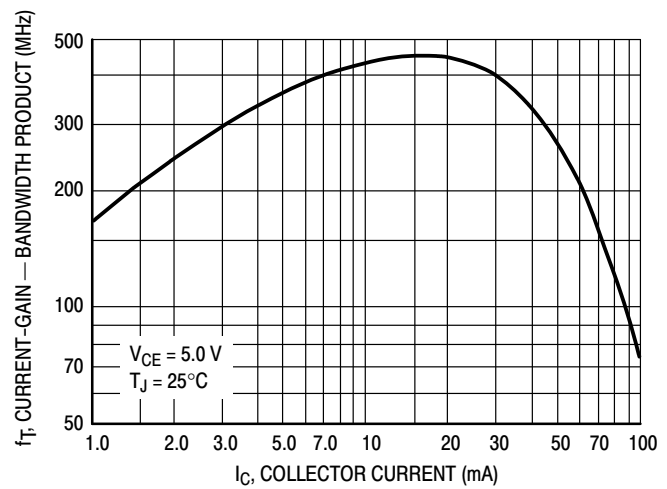

Figure 12. Current-Gain — Bandwidth Product

# MECHANICAL CASE OUTLINE PACKAGE DIMENSIONS



**SOT-23 (TO-236)**  
CASE 318  
ISSUE AT

DATE 01 MAR 2023

SCALE 4:1



**NOTES:**

1. DIMENSIONING AND TOLERANCING PER ASME Y14.5M,1994.
2. CONTROLLING DIMENSION: MILLIMETERS
3. MAXIMUM LEAD THICKNESS INCLUDES LEAD FINISH. MINIMUM LEAD THICKNESS IS THE MINIMUM THICKNESS OF THE BASE MATERIAL.
4. DIMENSIONS D AND E DO NOT INCLUDE MOLD FLASH, PROTRUSIONS, OR GATE BURRS.

DIM	MILLIMETERS			INCHES		
	MIN.	NOM.	MAX.	MIN.	NOM.	MAX.
A	0.89	1.00	1.11	0.035	0.039	0.044
A1	0.01	0.06	0.10	0.000	0.002	0.004
b	0.37	0.44	0.50	0.015	0.017	0.020
c	0.08	0.14	0.20	0.003	0.006	0.008
D	2.80	2.90	3.04	0.110	0.114	0.120
E	1.20	1.30	1.40	0.047	0.051	0.055
e	1.78	1.90	2.04	0.070	0.075	0.080
L	0.30	0.43	0.55	0.012	0.017	0.022
L1	0.35	0.54	0.69	0.014	0.021	0.027
H <sub>E</sub>	2.10	2.40	2.64	0.083	0.094	0.104
T	0°	---	10°	0°	---	10°

**GENERIC MARKING DIAGRAM\***



- XXX = Specific Device Code
- M = Date Code
- = Pb-Free Package

\*This information is generic. Please refer to device data sheet for actual part marking. Pb-Free indicator, "G" or microdot "▪", may or may not be present. Some products may not follow the Generic Marking.



**RECOMMENDED MOUNTING FOOTPRINT**

\* For additional information on our Pb-Free strategy and soldering details, please download the ON Semiconductor Soldering and Mounting Techniques Reference Manual, SOLDERRM/D.

**STYLES ON PAGE 2**

<b>DOCUMENT NUMBER:</b>	<b>98ASB42226B</b>	Electronic versions are uncontrolled except when accessed directly from the Document Repository. Printed versions are uncontrolled except when stamped "CONTROLLED COPY" in red.
<b>DESCRIPTION:</b>	<b>SOT-23 (TO-236)</b>	<b>PAGE 1 OF 2</b>

onsemi and ONSEMI are trademarks of Semiconductor Components Industries, LLC dba onsemi or its subsidiaries in the United States and/or other countries. onsemi reserves the right to make changes without further notice to any products herein. onsemi makes no warranty, representation or guarantee regarding the suitability of its products for any particular purpose, nor does onsemi assume any liability arising out of the application or use of any product or circuit, and specifically disclaims any and all liability, including without limitation special, consequential or incidental damages. onsemi does not convey any license under its patent rights nor the rights of others.

**MECHANICAL CASE OUTLINE**  
**PACKAGE DIMENSIONS**



**SOT-23 (TO-236)**  
**CASE 318**  
**ISSUE AT**

DATE 01 MAR 2023

- |   |   |   |   |   |   |
|---|---|---|---|---|---|
| STYLE 1 THRU 5:<br>CANCELLED                            | STYLE 6:<br>PIN 1. BASE<br>2. EMITTER<br>3. COLLECTOR | STYLE 7:<br>PIN 1. EMITTER<br>2. BASE<br>3. COLLECTOR       | STYLE 8:<br>PIN 1. ANODE<br>2. NO CONNECTION<br>3. CATHODE  |   |   |
| STYLE 9:<br>PIN 1. ANODE<br>2. ANODE<br>3. CATHODE      | STYLE 10:<br>PIN 1. DRAIN<br>2. SOURCE<br>3. GATE     | STYLE 11:<br>PIN 1. ANODE<br>2. CATHODE<br>3. CATHODE-ANODE | STYLE 12:<br>PIN 1. CATHODE<br>2. CATHODE<br>3. ANODE       | STYLE 13:<br>PIN 1. SOURCE<br>2. DRAIN<br>3. GATE           | STYLE 14:<br>PIN 1. CATHODE<br>2. GATE<br>3. ANODE          |
| STYLE 15:<br>PIN 1. GATE<br>2. CATHODE<br>3. ANODE      | STYLE 16:<br>PIN 1. ANODE<br>2. CATHODE<br>3. CATHODE | STYLE 17:<br>PIN 1. NO CONNECTION<br>2. ANODE<br>3. CATHODE | STYLE 18:<br>PIN 1. NO CONNECTION<br>2. CATHODE<br>3. ANODE | STYLE 19:<br>PIN 1. CATHODE<br>2. ANODE<br>3. CATHODE-ANODE | STYLE 20:<br>PIN 1. CATHODE<br>2. ANODE<br>3. GATE          |
| STYLE 21:<br>PIN 1. GATE<br>2. SOURCE<br>3. DRAIN       | STYLE 22:<br>PIN 1. RETURN<br>2. OUTPUT<br>3. INPUT   | STYLE 23:<br>PIN 1. ANODE<br>2. ANODE<br>3. CATHODE         | STYLE 24:<br>PIN 1. GATE<br>2. DRAIN<br>3. SOURCE           | STYLE 25:<br>PIN 1. ANODE<br>2. CATHODE<br>3. GATE          | STYLE 26:<br>PIN 1. CATHODE<br>2. ANODE<br>3. NO CONNECTION |
| STYLE 27:<br>PIN 1. CATHODE<br>2. CATHODE<br>3. CATHODE | STYLE 28:<br>PIN 1. ANODE<br>2. ANODE<br>3. ANODE     |   |   |   |   |

<b>DOCUMENT NUMBER:</b>	<b>98ASB42226B</b>	Electronic versions are uncontrolled except when accessed directly from the Document Repository. Printed versions are uncontrolled except when stamped "CONTROLLED COPY" in red.
<b>DESCRIPTION:</b>	<b>SOT-23 (TO-236)</b>	<b>PAGE 2 OF 2</b>

**onsemi** and **ONSEMI** are trademarks of Semiconductor Components Industries, LLC dba **onsemi** or its subsidiaries in the United States and/or other countries. **onsemi** reserves the right to make changes without further notice to any products herein. **onsemi** makes no warranty, representation or guarantee regarding the suitability of its products for any particular purpose, nor does **onsemi** assume any liability arising out of the application or use of any product or circuit, and specifically disclaims any and all liability, including without limitation special, consequential or incidental damages. **onsemi** does not convey any license under its patent rights nor the rights of others.

**onsemi**, **Onsemi**, and other names, marks, and brands are registered and/or common law trademarks of Semiconductor Components Industries, LLC dba "**onsemi**" or its affiliates and/or subsidiaries in the United States and/or other countries. **onsemi** owns the rights to a number of patents, trademarks, copyrights, trade secrets, and other intellectual property. A listing of **onsemi**'s product/patent coverage may be accessed at [www.onsemi.com/site/pdf/Patent-Marking.pdf](http://www.onsemi.com/site/pdf/Patent-Marking.pdf). **onsemi** reserves the right to make changes at any time to any products or information herein, without notice. The information herein is provided "as-is" and **onsemi** makes no warranty, representation or guarantee regarding the accuracy of the information, product features, availability, functionality, or suitability of its products for any particular purpose, nor does **onsemi** assume any liability arising out of the application or use of any product or circuit, and specifically disclaims any and all liability, including without limitation special, consequential or incidental damages. Buyer is responsible for its products and applications using **onsemi** products, including compliance with all laws, regulations and safety requirements or standards, regardless of any support or applications information provided by **onsemi**. "Typical" parameters which may be provided in **onsemi** data sheets and/or specifications can and do vary in different applications and actual performance may vary over time. All operating parameters, including "Typicals" must be validated for each customer application by customer's technical experts. **onsemi** does not convey any license under any of its intellectual property rights nor the rights of others. **onsemi** products are not designed, intended, or authorized for use as a critical component in life support systems or any FDA Class 3 medical devices or medical devices with a same or similar classification in a foreign jurisdiction or any devices intended for implantation in the human body. Should Buyer purchase or use **onsemi** products for any such unintended or unauthorized application, Buyer shall indemnify and hold **onsemi** and its officers, employees, subsidiaries, affiliates, and distributors harmless against all claims, costs, damages, and expenses, and reasonable attorney fees arising out of, directly or indirectly, any claim of personal injury or death associated with such unintended or unauthorized use, even if such claim alleges that **onsemi** was negligent regarding the design or manufacture of the part. **onsemi** is an Equal Opportunity/Affirmative Action Employer. This literature is subject to all applicable copyright laws and is not for resale in any manner.

## ADDITIONAL INFORMATION

### TECHNICAL PUBLICATIONS:

Technical Library: [www.onsemi.com/design/resources/technical-documentation](http://www.onsemi.com/design/resources/technical-documentation)  
onsemi Website: [www.onsemi.com](http://www.onsemi.com)

### ONLINE SUPPORT: [www.onsemi.com/support](http://www.onsemi.com/support)

For additional information, please contact your local Sales Representative at [www.onsemi.com/support/sales](http://www.onsemi.com/support/sales)