

TM7BDM16A

Discrete I/O expansion block, Modicon TM7, IP67, 16 DI/DO, 24 V DC, 0.5 A, M12 connector



Main

| | |
|--------------------------------|--------------------------------|
| Range of Product | Modicon TM7 |
| Product or Component Type | Discrete I/O expansion block |
| Range Compatibility | Modicon M258 Modicon LMC058 |
| Enclosure Material | Plastic |
| Bus type | TM7 bus |
| [Ue] rated operational voltage | 24 V DC |
| Input/output number | 16 |
| Input/output number of block | 16 I/O |

Complementary

| | |
|------------------------------|---|
| Discrete input number | 0...16 configurable by software |
| Discrete input voltage | 24 V |
| Discrete input voltage type | DC |
| Discrete input current | 4.4 mA |
| Discrete input logic | Positive |
| Discrete output number | 0...16 (≤ 0.5 A transistor configurable by software) |
| Discrete output voltage | 24 V |
| Discrete output voltage type | DC |
| Sensor power supply | 24 V, 500 mA for all channels overload, short-circuit and reverse polarity protection |
| Electrical connection | 1 male connector M12 - B coding - 4 ways bus IN 1 female connector M12 - B coding - 4 ways bus OUT 1 male connector M8 - 4 ways power IN 1 female connector M8 - 4 ways power OUT 8 female connectors M12 - 5 ways sensor or actuator |
| Local signalling | For bus diagnostic 2 LEDs For sensor power supply diagnostics 2 LEDs |
| Operating position | Any position |
| Fixing Mode | By 2 screws |
| Net Weight | 0.71 lb(US) (0.32 kg) |

Environment

| | |
|---------------------------------------|--|
| Standards | IEC 61131-2 |
| Product Certifications | ATEX II 3g EEx nA II T5 GOST-R CURus C-tick |
| Marking | CE |
| Ambient air temperature for operation | 14...140 °F (-10...60 °C) |
| Ambient Air Temperature for Storage | -13...185 °F (-25...85 °C) |
| Relative humidity | 5...95 % without condensation or dripping water |
| Pollution degree | 2 IEC 60664 |
| IP degree of protection | IP67 conforming to IEC 61131-2 |
| Operating altitude | 0...6561.68 ft (0...2000 m) |
| Storage altitude | 0.00...9842.52 ft (0...3000 m) |

| | |
|-------------------------------|---|
| Vibration resistance | 7.5 mm constant amplitude 2...8 Hz)IEC 60721-3-5 Class 5M3 2 gn constant acceleration 8...200 Hz)IEC 60721-3-5 Class 5M3 4 gn constant acceleration 200...500 Hz)IEC 60721-3-5 Class 5M3 |
| Shock resistance | 30 gn 11 ms IEC 60721-3-5 Class 5M3 |
| Electromagnetic compatibility | Electrostatic discharge immunity test, 4 kV on contact EN/IEC 61000-4-2 Electrostatic discharge immunity test, 8 kV in air EN/IEC 61000-4-2 Susceptibility to electromagnetic fields, 1 V/m 2...2.7 GHz EN/IEC 61000-4-3 Susceptibility to electromagnetic fields, 10 V/m 80...2000 MHz EN/IEC 61000-4-3 Electrical fast transient/burst immunity test, 2 kV power supply EN/IEC 61000-4-4 Electrical fast transient/burst immunity test, 1 kV input/output EN/IEC 61000-4-4 Electrical fast transient/burst immunity test, 1 kV shielded cable EN/IEC 61000-4-4 1.2/50 µs shock waves immunity test, 0.5 kV power supply (common mode) EN/IEC 61000-4-5 1.2/50 µs shock waves immunity test, 1 kV power supply (differential mode) EN/IEC 61000-4-5 1.2/50 µs shock waves immunity test, 0.5 kV unshielded links (common mode) EN/IEC 61000-4-5 1.2/50 µs shock waves immunity test, 1 kV unshielded links (differential mode) EN/IEC 61000-4-5 1.2/50 µs shock waves immunity test, 0.5 kV shielded links (common mode) EN/IEC 61000-4-5 1.2/50 µs shock waves immunity test, 1 kV shielded links (differential mode) EN/IEC 61000-4-5 Conducted RF disturbances EN/IEC 61000-4-6 Conducted and radiated emissions CISPR 11 |





Ordering and shipping details

| | |
|-----------------------|------------------|
| Category | 22532 - M258 PLC |
| Discount Schedule | PC12 |
| GTIN | 3595864093093 |
| Nbr. of units in pkg. | 1 |
| Package weight(Lbs) | 12.66 oz (359 g) |
| Returnability | No |
| Country of origin | AT |

Packing Units

| | |
|------------------------------|-------------------------|
| Unit Type of Package 1 | PCE |
| Package 1 Height | 2.17 in (5.5 cm) |
| Package 1 width | 1.81 in (4.6 cm) |
| Package 1 Length | 6.97 in (17.7 cm) |
| Unit Type of Package 2 | S03 |
| Number of Units in Package 2 | 30 |
| Package 2 Weight | 24.80 lb(US) (11.25 kg) |
| Package 2 Height | 11.81 in (30 cm) |
| Package 2 width | 11.81 in (30 cm) |
| Package 2 Length | 15.75 in (40 cm) |

Offer Sustainability

| | |
|----------------------------|---|
| Sustainable offer status | Green Premium product |
| California proposition 65 | WARNING: This product can expose you to chemicals including: Lead and lead compounds, which is known to the State of California to cause cancer and birth defects or other reproductive harm. For more information go to www.P65Warnings.ca.gov |
| REACH Regulation |  REACH Declaration |
| REACH free of SVHC | Yes |
| EU RoHS Directive | Pro-active compliance (Product out of EU RoHS legal scope)  EU RoHS Declaration |
| Toxic heavy metal free | Yes |
| Mercury free | Yes |
| RoHS exemption information |  Yes |
| China RoHS Regulation |  China RoHS Declaration |

| | |
|--------------------------|--|
| Environmental Disclosure | Product Environmental Profile |
| Circularity Profile | End Of Life Information |
| WEEE | The product must be disposed on European Union markets following specific waste collection and never end up in rubbish bins. |
| PVC free | Yes |

Contractual warranty

| | |
|----------|-----------|
| Warranty | 18 months |
|----------|-----------|

Digital Mixed Block

Description

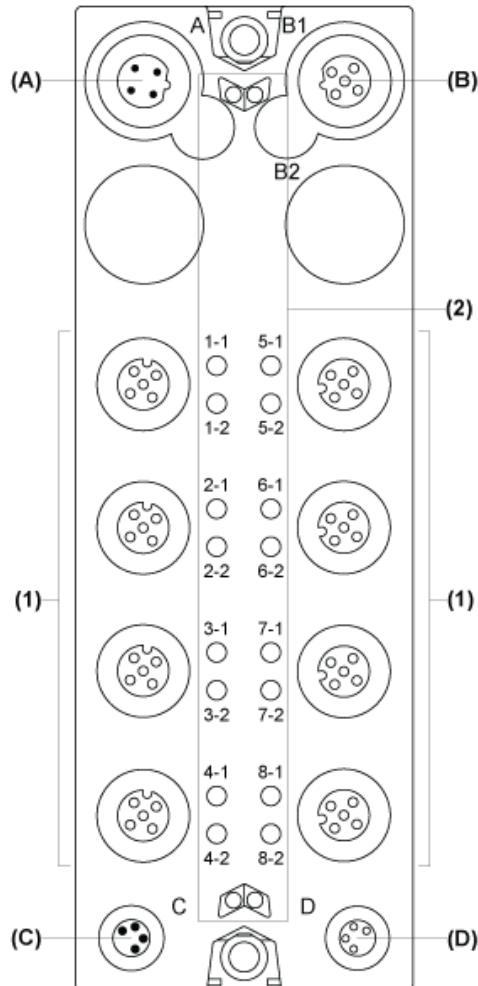

- (A) TM7 bus IN connector
- (B) TM7 bus OUT connector
- (C) 24 Vdc power IN connector
- (D) 24 Vdc power OUT connector
- (1) Input / Output connectors
- (2) Status LEDs

Connector and Channel Assignments

| I/O connectors | Channel types | Channels |
|----------------|---------------|----------|
| 1 | Input/Output | I0/Q0 |
| Input/Output | I1/Q1 | |
| 2 | Input/Output | I2/Q2 |
| Input/Output | I3/Q3 | |
| 3 | Input/Output | I4/Q4 |
| Input/Output | I5/Q5 | |
| 4 | Input/Output | I6/Q6 |
| Input/Output | I7/Q7 | |
| 5 | Input/Output | I8/Q8 |

| I/O connectors | Channel types | Channels |
|----------------|---------------|----------|
| Input/Output | I9/Q9 | |
| 6 | Input/Output | I10/Q10 |
| Input/Output | I11/Q11 | |
| 7 | Input/Output | I12/Q12 |
| Input/Output | I13/Q13 | |
| 8 | Input/Output | I14/Q14 |
| Input/Output | I15/Q15 | |

TM7 Block, Size 2

Dimensions

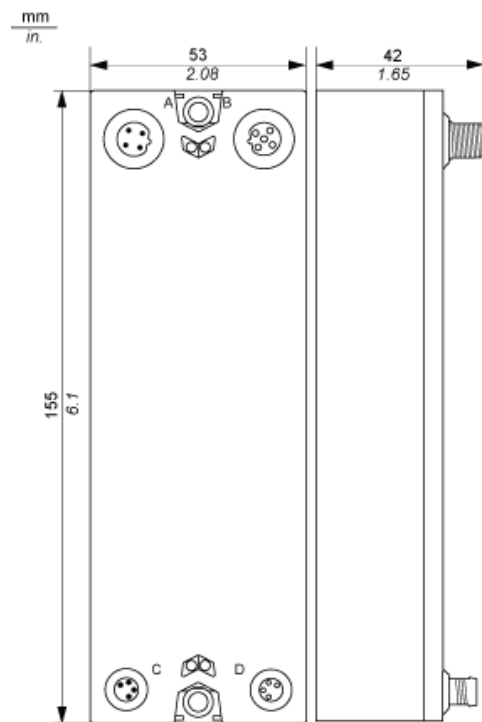

Spacing Requirements

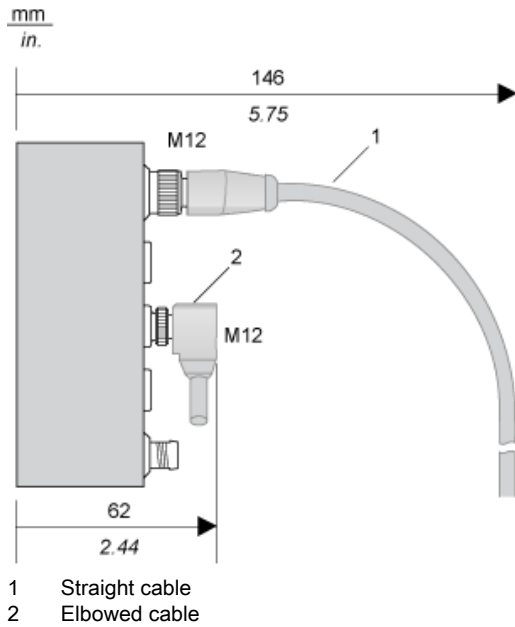

Installation Guidelines

TM7 Block on an Aluminium Frame

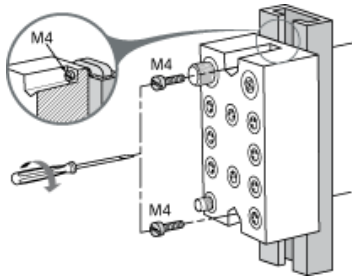

NOTE: Maximum torque to fasten the required M4 screws is 0.6 N.m (5.3 lbf-in).

TM7 Block on a DIN Rail

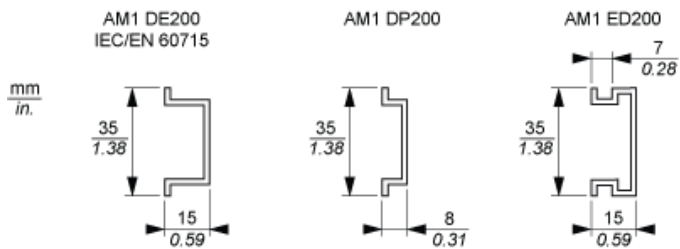

NOTE: Only size 1 (smallest) blocks can be installed on DIN rail with the TM7ACMP mounting plate.

TM7 Block Directly on the Machine

Drilling template of the block:

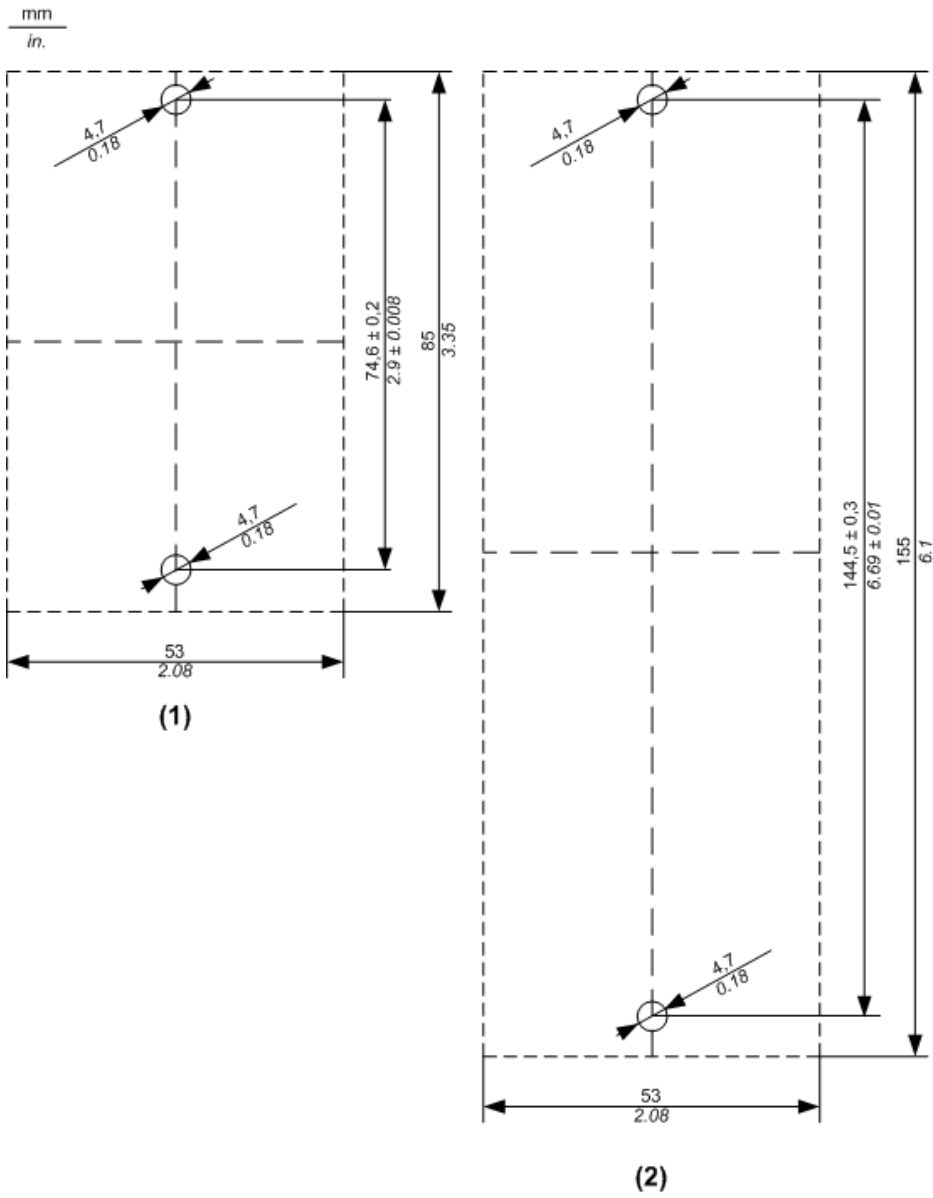

- (1) Size 1
- (2) Size 2

The thickness of the base plate should be taken into consideration when defining the screw length.

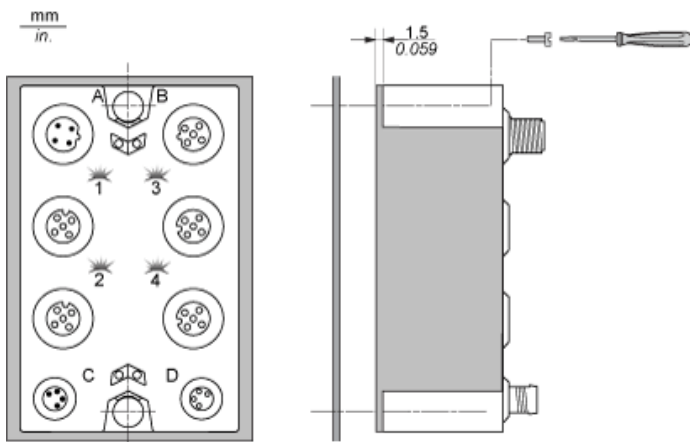

NOTE: Maximum torque to fasten the required M4 screws is 0.6 N.m (5.3 lbf-in).

Wiring Diagram

Pin Assignments for I/O Connectors

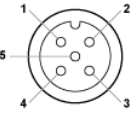
| Connection | Pin | M12 input / output |
|---|---|---------------------------------|
|  | 1 | 24 Vdc sensor / actuator supply |
| 2 | DI/DO: input/ output signal channel 1 | |
| 3 | 0 Vdc | |
| 4 | DI/DO: input/ output signal channel 2 | |
| 5 | N.C. | |

Wiring the Power Supply

When you provide power to a TM7 I/O block using the 24 VDC Power OUT connector of the preceding I/O block, both blocks occupy the same 24 Vdc I/O power segment. However, if you connect an external isolated power supply to the 24 Vdc Power IN connector of a TM7 I/O block, you establish a new 24 Vdc I/O power segment beginning with that I/O block.

I/O block wired with one external 24 Vdc power supply:

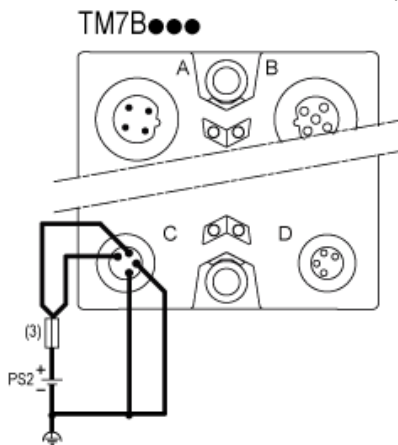

- (3) External fuse, Type T slow-blow, 8 A max., 250 V
- PS2 External isolated I/O power supply, 24 Vdc

Switching Inductive Load Characteristics

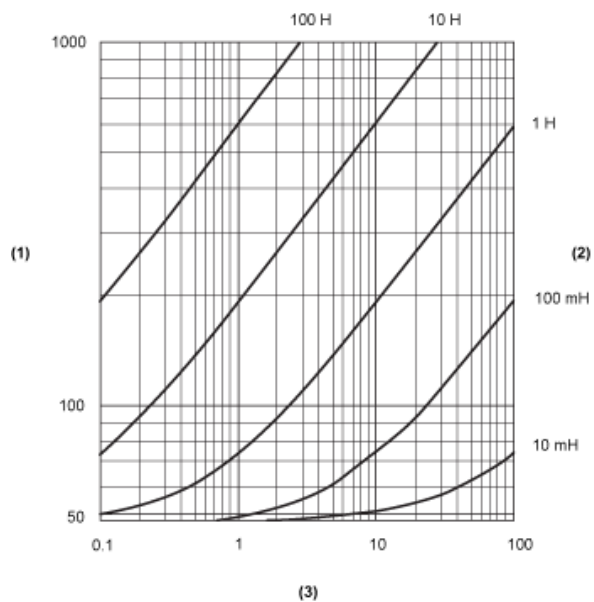

- (1) Load resistance in Ω
- (2) Load inductance in H
- (3) Max. operating cycles / second