



BUK7V4R2-40H

Dual N-channel 40 V, 4.2 mOhm standard level MOSFET in LFPAK56D (half-bridge configuration)

9 May 2023

Product data sheet

1. General description

Dual, standard level N-channel MOSFET in an LFPAK56D package (half-bridge configuration), using Trench 9 TrenchMOS technology. This product has been designed and qualified to AEC-Q101.

An internal connection is made between the source (S1) of the high-side FET to the drain (D2) of the low-side FET, making the device ideal to use as a half-bridge switch in high-performance automotive PWM applications.

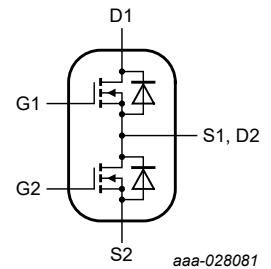

2. Features and benefits

- LFPAK56D package with half-bridge configuration enables:
 - Reduced PCB layout complexity
 - PCB shrinkage through reduced component footprint for 3-phase motor drive
 - Improved system level $R_{th(j-amb)}$ due to optimized package design
 - Lower parasitic inductance to support higher efficiency
 - Footprint compatibility with LFPAK56D Dual package
- Advanced AEC-Q101 grade Trench 9 silicon technology:
 - Low power losses, high power density
 - Superior avalanche performance
 - Repetitive avalanche rated
- LFPAK copper clip packaging provides high robustness and reliability
- Gull wing leads support high manufacturability and Automated Optical Inspection (AOI)

3. Applications

- 12 V automotive systems
- Powertrain, chassis, body and infotainment applications
- Brushless or brushed DC motor drive
- DC-to-DC systems
- LED lighting

4. Quick reference data

Table 1. Quick reference data

Symbol	Parameter	Conditions	Min	Typ	Max	Unit
Limiting values FET1 and FET2						
V_{DS}	drain-source voltage	$25\text{ °C} \leq T_j \leq 175\text{ °C}$	-	-	40	V
I_D	drain current	$V_{GS} = 10\text{ V}; T_{mb} = 25\text{ °C}; \text{Fig. 2}$	[1]	-	98	A
P_{tot}	total power dissipation	$T_{mb} = 25\text{ °C}; \text{Fig. 1}$	-	-	85	W

Dual N-channel 40 V, 4.2 mOhm standard level MOSFET in LFPAK56D (half-bridge configuration)

Symbol	Parameter	Conditions	Min	Typ	Max	Unit
Static characteristics FET1 and FET2						
R_{DSon}	drain-source on-state resistance	$V_{GS} = 10\text{ V}$; $I_D = 20\text{ A}$; $T_j = 25\text{ °C}$; Fig. 11	2.5	3.5	4.2	mΩ
Dynamic characteristics FET1 and FET2						
Q_{GD}	gate-drain charge	$I_D = 20\text{ A}$; $V_{DS} = 32\text{ V}$; $V_{GS} = 10\text{ V}$; $T_j = 25\text{ °C}$; Fig. 13 ; Fig. 14	-	4.7	9.4	nC

[1] 98A continuous current has been successfully demonstrated during application tests. Practically the current will be limited by PCB, thermal design and operating temperature.

5. Pinning information

Table 2. Pinning information

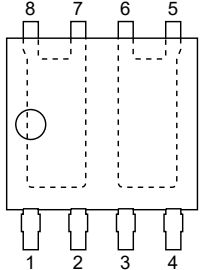
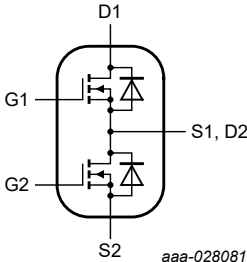
Pin	Symbol	Description	Simplified outline	Graphic symbol
1	S2	source2	 <p>LFPAK56D; Dual LFPAK (SOT1205)</p>	 <p>aaa-028081</p>
2	G2	gate2		
3	S1, D2	source1, drain2		
4	G1	gate1		
5	D1	drain1		
6	D1	drain1		
7	S1, D2	source1, drain2		
8	S1, D2	source1, drain2		

6. Ordering information

Table 3. Ordering information

Type number	Package		
	Name	Description	Version
BUK7V4R2-40H	LFPAK56D; Dual LFPAK	plastic, single ended surface mounted package (LFPAK56D); 8 leads	SOT1205

7. Marking

Table 4. Marking codes

Type number	Marking code
BUK7V4R2-40H	74V240H

8. Limiting values

Table 5. Limiting values

In accordance with the Absolute Maximum Rating System (IEC 60134).

Symbol	Parameter	Conditions	Min	Max	Unit
Limiting values FET1 and FET2					
V_{DS}	drain-source voltage	$25\text{ °C} \leq T_j \leq 175\text{ °C}$	-	40	V
V_{GS}	gate-source voltage	DC; $T_j = 25\text{ °C}$	-20	20	V
P_{tot}	total power dissipation	$T_{mb} = 25\text{ °C}$; Fig. 1	-	85	W

Dual N-channel 40 V, 4.2 mOhm standard level MOSFET in LPAK56D (half-bridge configuration)

Symbol	Parameter	Conditions		Min	Max	Unit
I _D	drain current	V _{GS} = 10 V; T _{mb} = 25 °C; Fig. 2	[1]	-	98	A
		V _{GS} = 10 V; T _{mb} = 100 °C; Fig. 2		-	69.5	A
I _{DM}	peak drain current	pulsed; t _p ≤ 10 μs; T _{mb} = 25 °C; Fig. 3		-	393	A
T _{stg}	storage temperature			-55	175	°C
T _j	junction temperature			-55	175	°C
Source-drain diode FET1 and FET2						
I _S	source current	T _{mb} = 25 °C		-	85	A
I _{SM}	peak source current	pulsed; t _p ≤ 10 μs; T _{mb} = 25 °C		-	393	A
Avalanche ruggedness FET1 and FET2						
E _{DS(AL)S}	non-repetitive drain-source avalanche energy	I _D = 82.6 A; V _{sup} ≤ 40 V; R _{GS} = 50 Ω; V _{GS} = 10 V; T _{j(init)} = 25 °C; unclamped; Fig. 4	[2] [3]	-	42.3	mJ
I _{AS}	non-repetitive avalanche current	V _{sup} = 40 V; V _{GS} = 10 V; T _{j(init)} = 25 °C; R _{GS} = 50 Ω	[4]	-	82.6	A

- [1] 98A continuous current has been successfully demonstrated during application tests. Practically the current will be limited by PCB, thermal design and operating temperature.
- [2] Single-pulse avalanche rating limited by maximum junction temperature of 175 °C.
- [3] Refer to application note AN10273 for further information.
- [4] Protected by 100% test

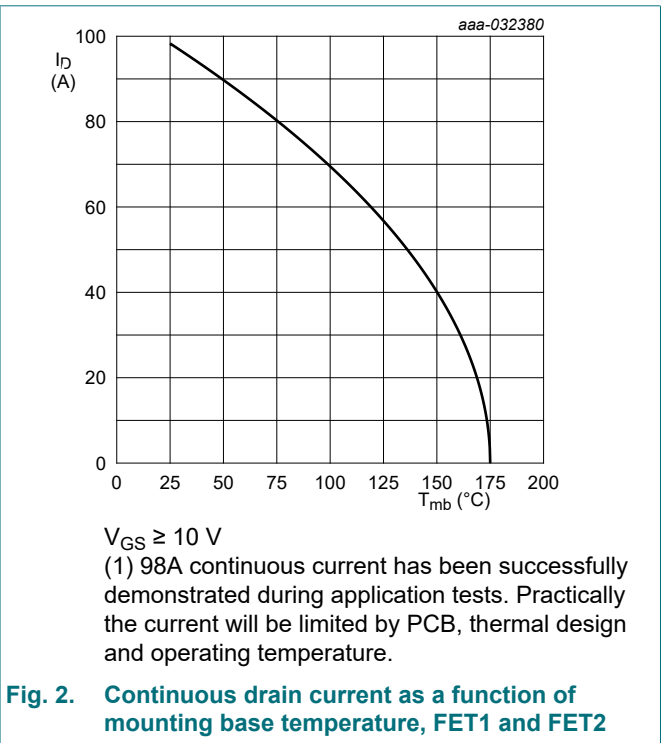
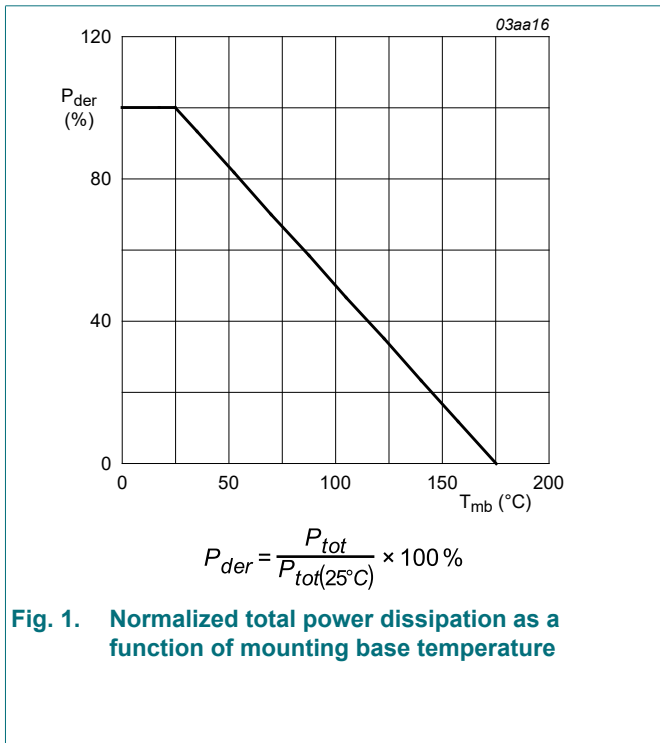

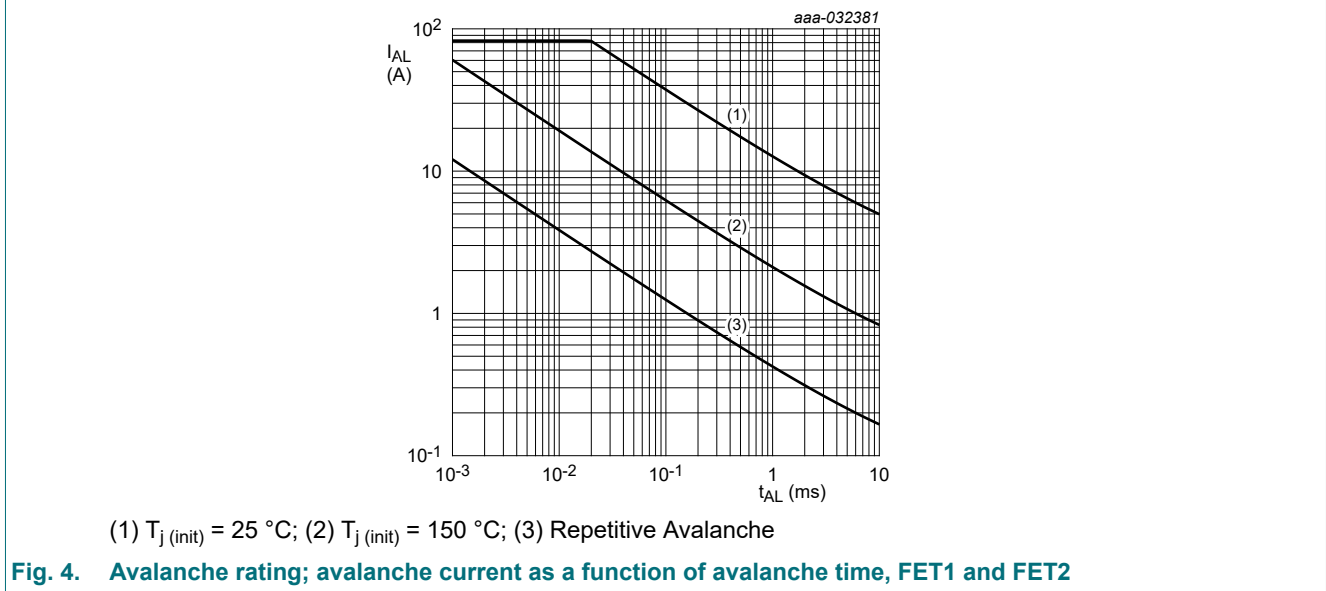
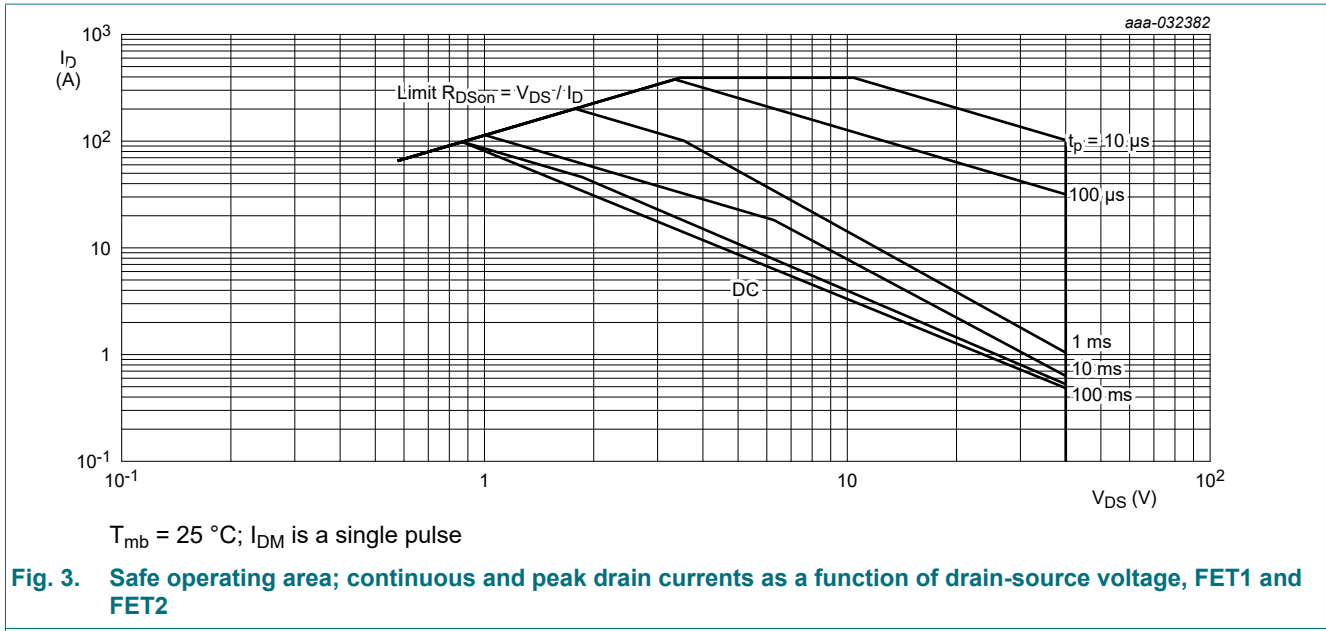

9. Thermal characteristics

Table 6. Thermal characteristics

Symbol	Parameter	Conditions	Min	Typ	Max	Unit
$R_{th(j-mb)}$	thermal resistance from junction to mounting base	Fig. 5	-	1.64	1.76	K/W

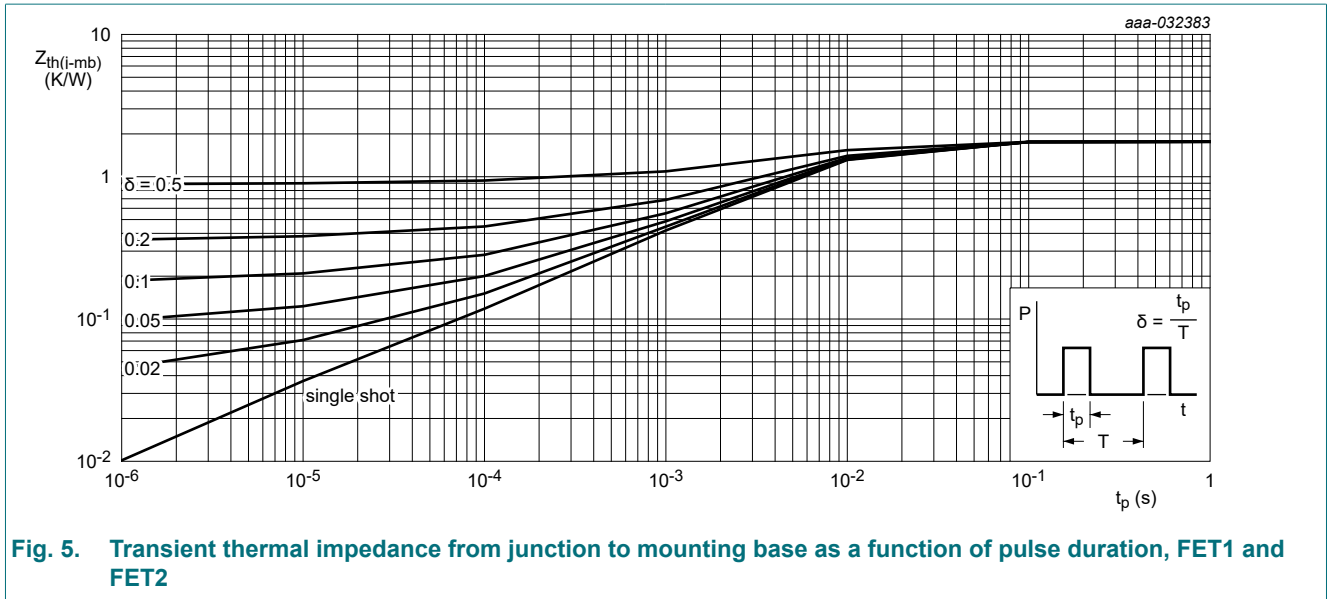

Fig. 5. Transient thermal impedance from junction to mounting base as a function of pulse duration, FET1 and FET2

10. Characteristics

Table 7. Characteristics

Symbol	Parameter	Conditions	Min	Typ	Max	Unit
Static characteristics FET1 and FET2						
$V_{(BR)DSS}$	drain-source breakdown voltage	$I_D = 250 \mu A; V_{GS} = 0 V; T_j = 25 \text{ }^\circ C$	40	43	-	V
		$I_D = 250 \mu A; V_{GS} = 0 V; T_j = -40 \text{ }^\circ C$	-	40.5	-	V
		$I_D = 250 \mu A; V_{GS} = 0 V; T_j = -55 \text{ }^\circ C$	36	40	-	V
$V_{GS(th)}$	gate-source threshold voltage	$I_D = 1 \text{ mA}; V_{DS}=V_{GS}; T_j = 25 \text{ }^\circ C$; Fig. 9 ; Fig. 10	2.4	3	3.6	V
		$I_D = 1 \text{ mA}; V_{DS}=V_{GS}; T_j = 175 \text{ }^\circ C$; Fig. 10	1	-	-	V
		$I_D = 1 \text{ mA}; V_{DS}=V_{GS}; T_j = -55 \text{ }^\circ C$; Fig. 10	-	-	4.3	V
I_{DSS}	drain leakage current	$V_{DS} = 40 \text{ V}; V_{GS} = 0 \text{ V}; T_j = 25 \text{ }^\circ C$	-	0.007	1	μA
		$V_{DS} = 16 \text{ V}; V_{GS} = 0 \text{ V}; T_j = 125 \text{ }^\circ C$	-	0.3	10	μA
		$V_{DS} = 40 \text{ V}; V_{GS} = 0 \text{ V}; T_j = 175 \text{ }^\circ C$	-	53	500	μA
I_{GSS}	gate leakage current	$V_{GS} = 20 \text{ V}; V_{DS} = 0 \text{ V}; T_j = 25 \text{ }^\circ C$	-	2	100	nA
		$V_{GS} = -10 \text{ V}; V_{DS} = 0 \text{ V}; T_j = 25 \text{ }^\circ C$	-	2	100	nA
R_{DSon}	drain-source on-state resistance	$V_{GS} = 10 \text{ V}; I_D = 20 \text{ A}; T_j = 25 \text{ }^\circ C$; Fig. 11	2.5	3.5	4.2	m Ω
		$V_{GS} = 10 \text{ V}; I_D = 20 \text{ A}; T_j = 105 \text{ }^\circ C$; Fig. 12	3.4	5.2	6.4	m Ω
		$V_{GS} = 10 \text{ V}; I_D = 20 \text{ A}; T_j = 125 \text{ }^\circ C$; Fig. 12	3.7	5.8	7.2	m Ω
		$V_{GS} = 10 \text{ V}; I_D = 20 \text{ A}; T_j = 175 \text{ }^\circ C$; Fig. 12	4.5	7.2	8.8	m Ω
R_G	gate resistance	$f = 1 \text{ MHz}; T_j = 25 \text{ }^\circ C$	0.72	1.8	4.5	Ω
Dynamic characteristics FET1 and FET2						
$Q_{G(tot)}$	total gate charge	$I_D = 20 \text{ A}; V_{DS} = 32 \text{ V}; V_{GS} = 10 \text{ V}; T_j = 25 \text{ }^\circ C$; Fig. 13 ; Fig. 14	-	26	37	nC
Q_{GS}	gate-source charge		-	7.8	12	nC
Q_{GD}	gate-drain charge		-	4.7	9.4	nC

Dual N-channel 40 V, 4.2 mOhm standard level MOSFET in LFPAK56D (half-bridge configuration)

Symbol	Parameter	Conditions	Min	Typ	Max	Unit
C_{iss}	input capacitance	$V_{DS} = 25\text{ V}; V_{GS} = 0\text{ V}; f = 1\text{ MHz}; T_j = 25\text{ }^\circ\text{C};$ Fig. 15	-	1850	2590	pF
C_{oss}	output capacitance		-	565	791	pF
C_{rss}	reverse transfer capacitance		-	91	200	pF
$t_{d(on)}$	turn-on delay time	$V_{DS} = 30\text{ V}; R_L = 1.5\text{ }\Omega; V_{GS} = 10\text{ V}; R_{G(ext)} = 5\text{ }\Omega; T_j = 25\text{ }^\circ\text{C}$	-	7	-	ns
t_r	rise time		-	9	-	ns
$t_{d(off)}$	turn-off delay time		-	19	-	ns
t_f	fall time		-	11.8	-	ns
Source-drain diode FET1 and FET2						
V_{SD}	source-drain voltage	$I_S = 20\text{ A}; V_{GS} = 0\text{ V}; T_j = 25\text{ }^\circ\text{C};$ Fig. 16	-	0.81	1	V
t_{rr}	reverse recovery time	$I_S = 20\text{ A}; di_S/dt = -100\text{ A}/\mu\text{s}; V_{GS} = 0\text{ V}; V_{DS} = 20\text{ V}; T_j = 25\text{ }^\circ\text{C}$	-	18.6	-	ns
Q_r	recovered charge		-	9.2	-	nC

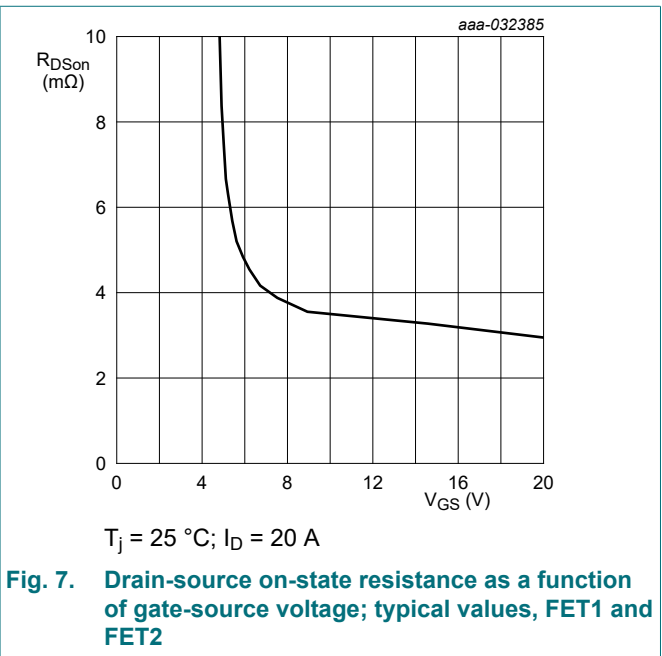
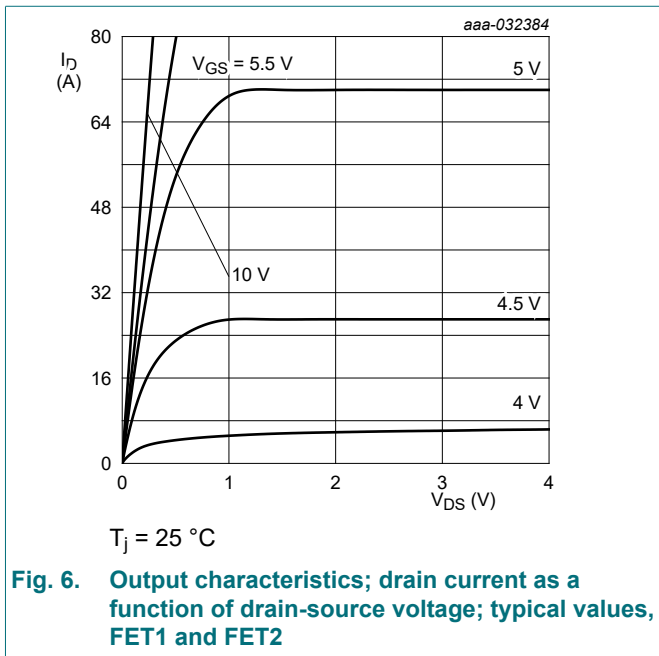

Dual N-channel 40 V, 4.2 mOhm standard level MOSFET in LPAK56D (half-bridge configuration)

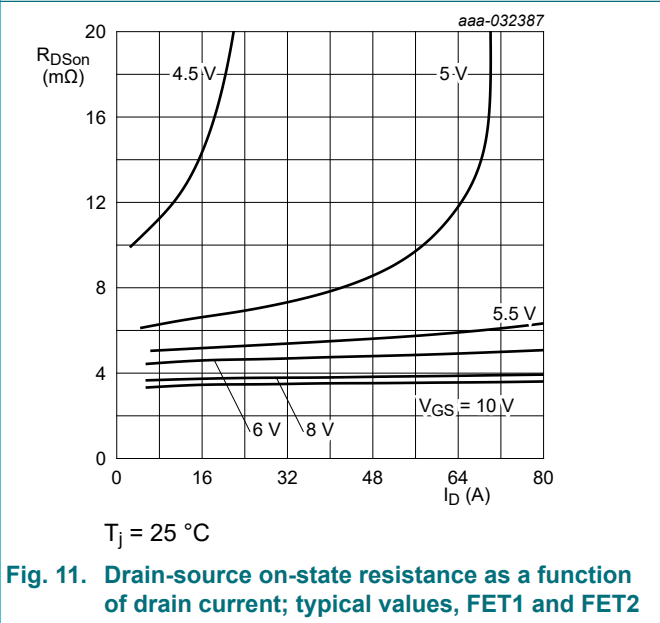
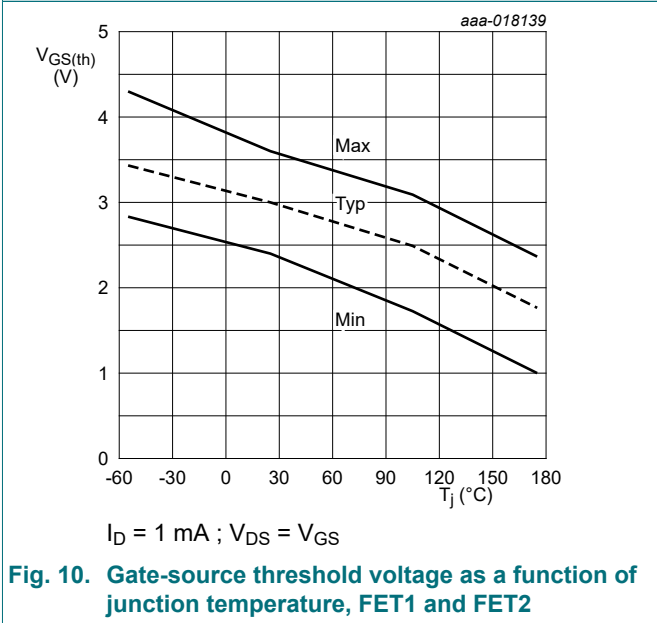
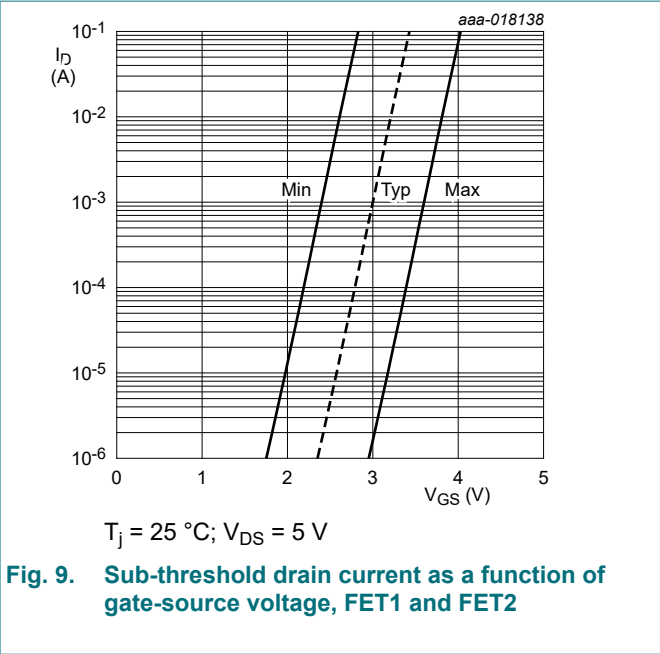
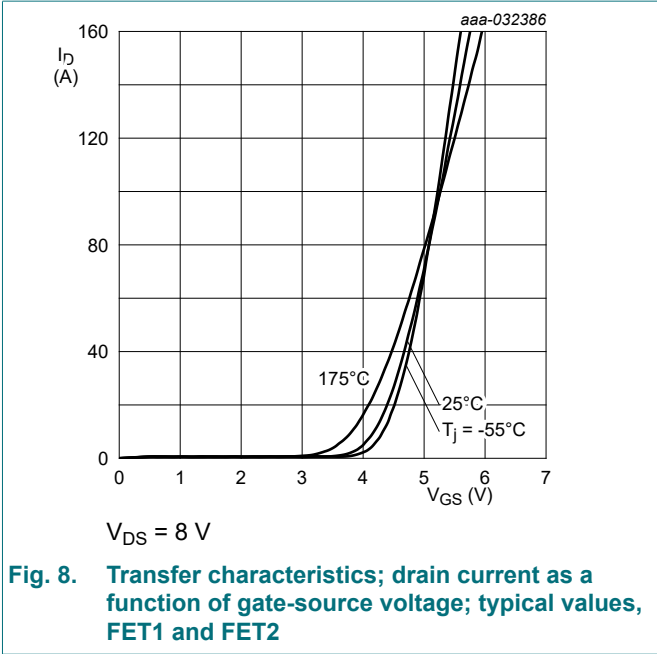

Dual N-channel 40 V, 4.2 mOhm standard level MOSFET in LPAK56D (half-bridge configuration)

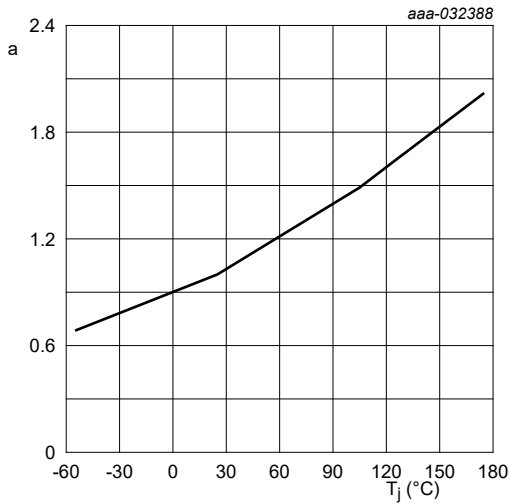

$$a = \frac{R_{DSon}}{R_{DSon}(25^\circ\text{C})}$$

Fig. 12. Normalized drain-source on-state resistance factor as a function of junction temperature, FET1 and FET2

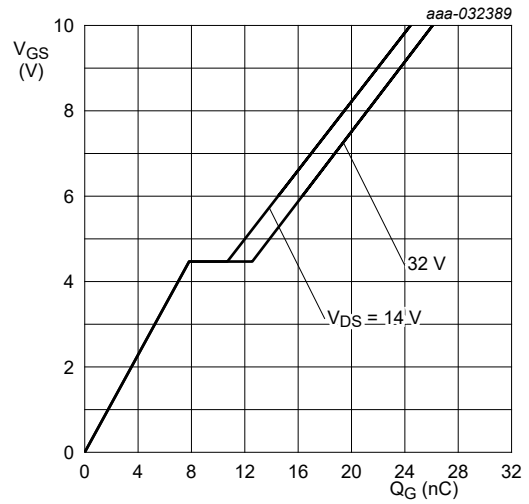

$T_j = 25^\circ\text{C}; I_D = 20\text{ A}$

Fig. 13. Gate-source voltage as a function of gate charge; typical values, FET1 and FET2

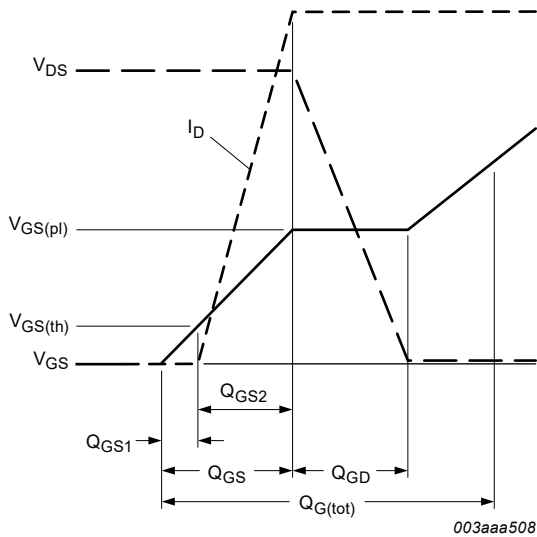
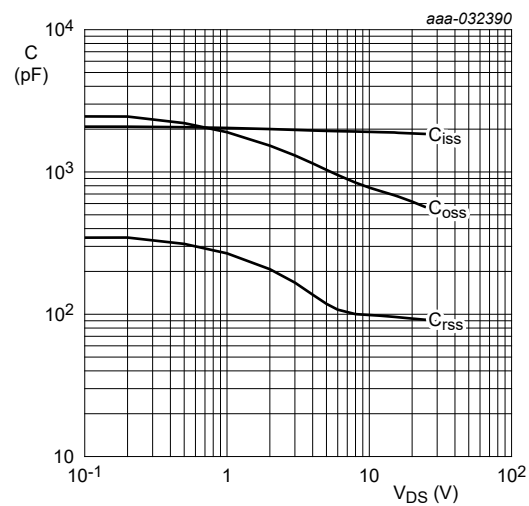
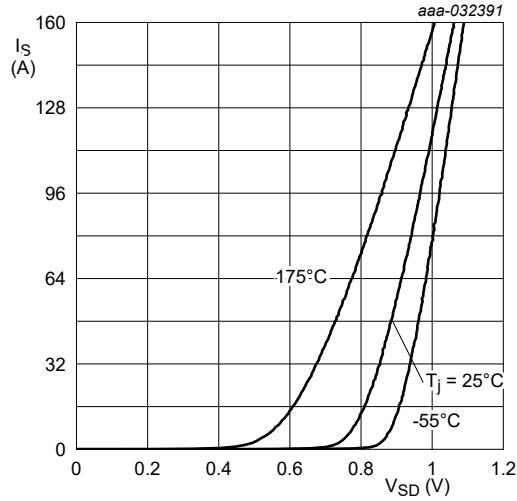

Fig. 14. Gate charge waveform definitions



$V_{GS} = 0\text{ V}; f = 1\text{ MHz}$

Fig. 15. Input, output and reverse transfer capacitances as a function of drain-source voltage; typical values, FET1 and FET2



V_{GS} = 0 V

Fig. 16. Source-drain (diode forward) current as a function of source-drain (diode forward) voltage; typical values, FET1 and FET2

11. Package outline

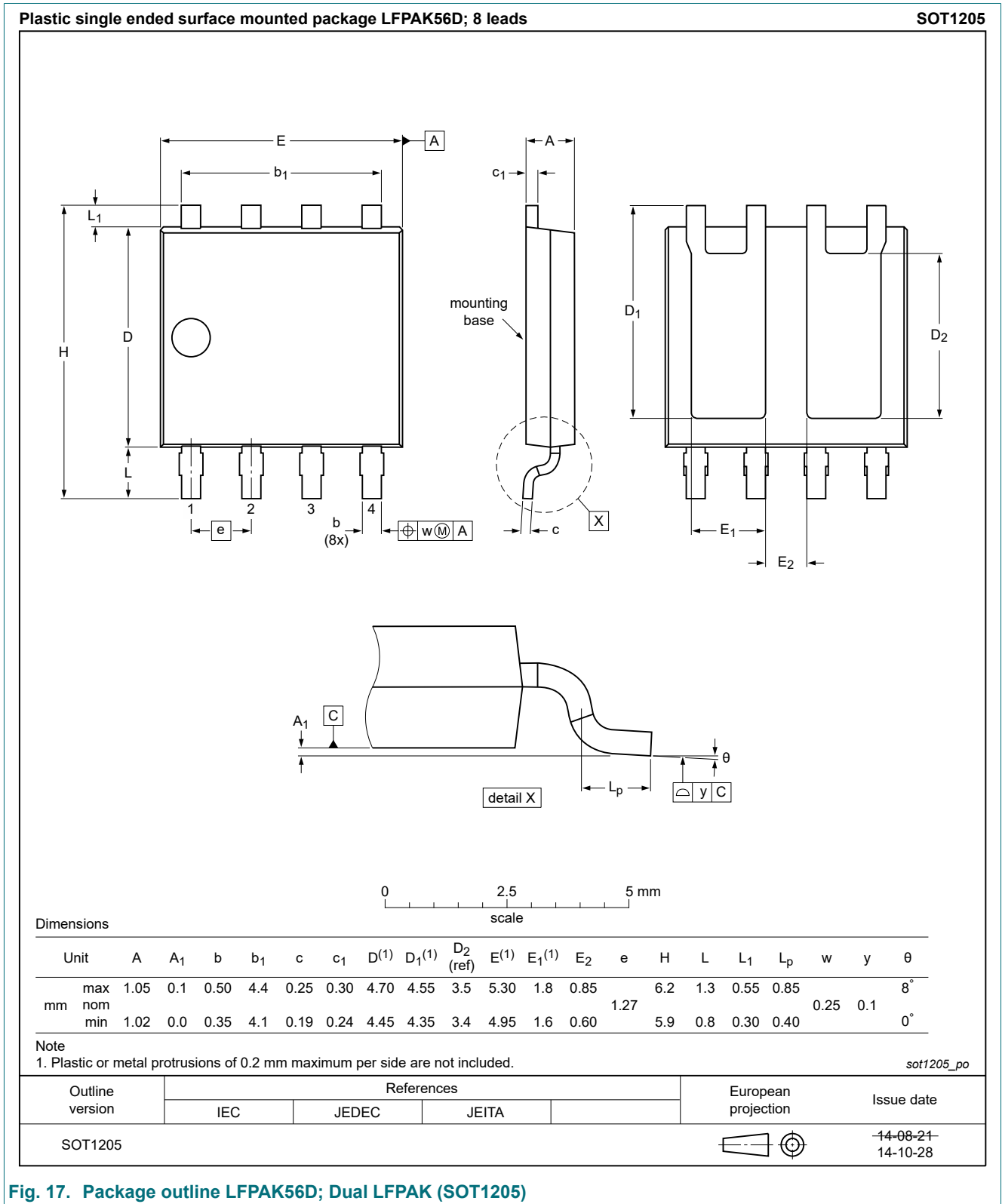

Fig. 17. Package outline LPAK56D; Dual LPAK (SOT1205)

12. Soldering

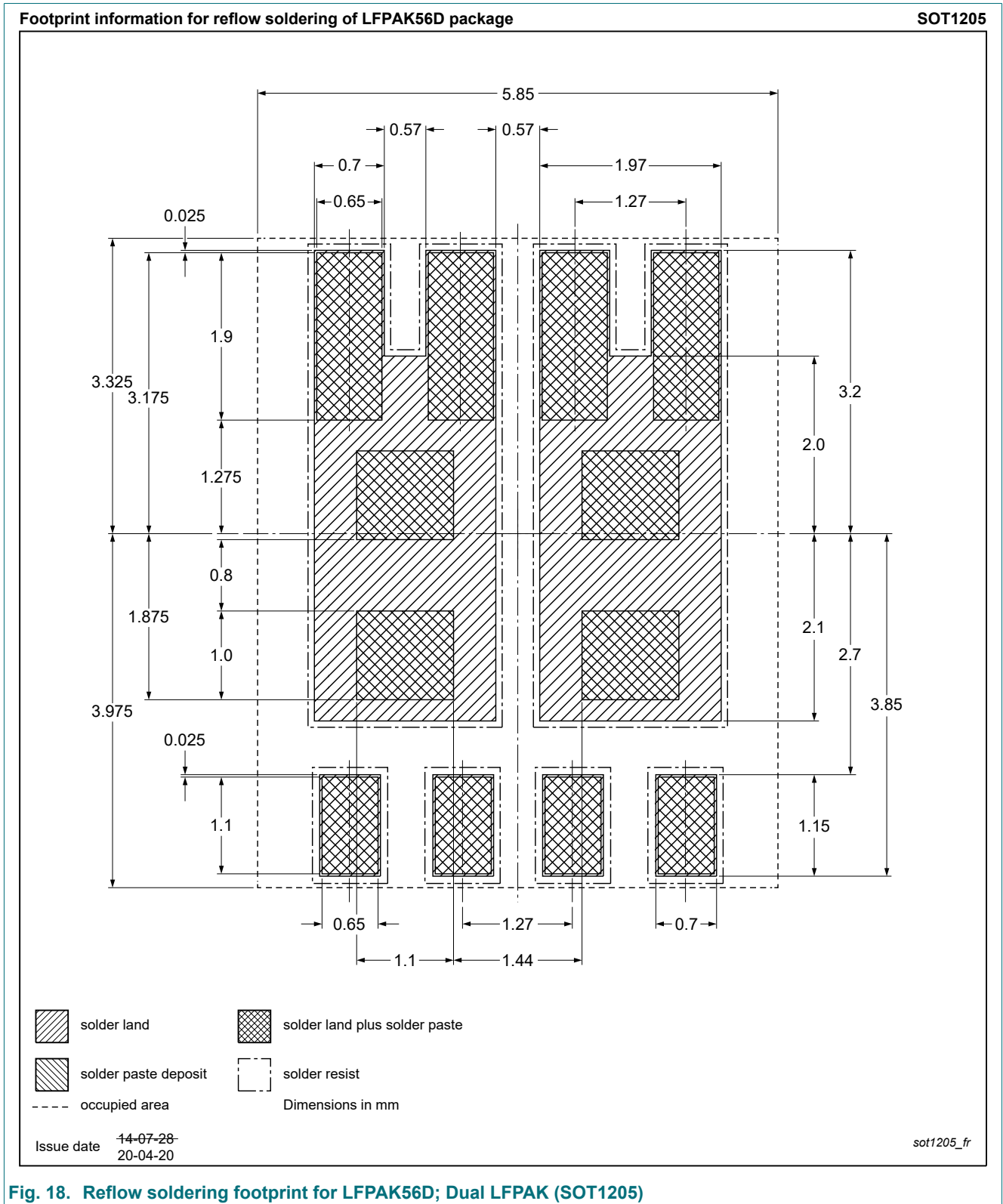

Fig. 18. Reflow soldering footprint for LPAK56D; Dual LPAK (SOT1205)

13. Legal information

Data sheet status

Document status [1][2]	Product status [3]	Definition
Objective [short] data sheet	Development	This document contains data from the objective specification for product development.
Preliminary [short] data sheet	Qualification	This document contains data from the preliminary specification.
Product [short] data sheet	Production	This document contains the product specification.

- [1] Please consult the most recently issued document before initiating or completing a design.
- [2] The term 'short data sheet' is explained in section "Definitions".
- [3] The product status of device(s) described in this document may have changed since this document was published and may differ in case of multiple devices. The latest product status information is available on the internet at <https://www.nexperia.com>.

Definitions

Draft — The document is a draft version only. The content is still under internal review and subject to formal approval, which may result in modifications or additions. Nexperia does not give any representations or warranties as to the accuracy or completeness of information included herein and shall have no liability for the consequences of use of such information.

Short data sheet — A short data sheet is an extract from a full data sheet with the same product type number(s) and title. A short data sheet is intended for quick reference only and should not be relied upon to contain detailed and full information. For detailed and full information see the relevant full data sheet, which is available on request via the local Nexperia sales office. In case of any inconsistency or conflict with the short data sheet, the full data sheet shall prevail.

Product specification — The information and data provided in a Product data sheet shall define the specification of the product as agreed between Nexperia and its customer, unless Nexperia and customer have explicitly agreed otherwise in writing. In no event however, shall an agreement be valid in which the Nexperia product is deemed to offer functions and qualities beyond those described in the Product data sheet.

Disclaimers

Limited warranty and liability — Information in this document is believed to be accurate and reliable. However, Nexperia does not give any representations or warranties, expressed or implied, as to the accuracy or completeness of such information and shall have no liability for the consequences of use of such information. Nexperia takes no responsibility for the content in this document if provided by an information source outside of Nexperia.

In no event shall Nexperia be liable for any indirect, incidental, punitive, special or consequential damages (including - without limitation - lost profits, lost savings, business interruption, costs related to the removal or replacement of any products or rework charges) whether or not such damages are based on tort (including negligence), warranty, breach of contract or any other legal theory.

Notwithstanding any damages that customer might incur for any reason whatsoever, Nexperia's aggregate and cumulative liability towards customer for the products described herein shall be limited in accordance with the Terms and conditions of commercial sale of Nexperia.

Right to make changes — Nexperia reserves the right to make changes to information published in this document, including without limitation specifications and product descriptions, at any time and without notice. This document supersedes and replaces all information supplied prior to the publication hereof.

Suitability for use in automotive applications — This Nexperia product has been qualified for use in automotive applications. Unless otherwise agreed in writing, the product is not designed, authorized or warranted to be suitable for use in life support, life-critical or safety-critical systems or

equipment, nor in applications where failure or malfunction of an Nexperia product can reasonably be expected to result in personal injury, death or severe property or environmental damage. Nexperia and its suppliers accept no liability for inclusion and/or use of Nexperia products in such equipment or applications and therefore such inclusion and/or use is at the customer's own risk.

Quick reference data — The Quick reference data is an extract of the product data given in the Limiting values and Characteristics sections of this document, and as such is not complete, exhaustive or legally binding.

Applications — Applications that are described herein for any of these products are for illustrative purposes only. Nexperia makes no representation or warranty that such applications will be suitable for the specified use without further testing or modification.

Customers are responsible for the design and operation of their applications and products using Nexperia products, and Nexperia accepts no liability for any assistance with applications or customer product design. It is customer's sole responsibility to determine whether the Nexperia product is suitable and fit for the customer's applications and products planned, as well as for the planned application and use of customer's third party customer(s). Customers should provide appropriate design and operating safeguards to minimize the risks associated with their applications and products.

Nexperia does not accept any liability related to any default, damage, costs or problem which is based on any weakness or default in the customer's applications or products, or the application or use by customer's third party customer(s). Customer is responsible for doing all necessary testing for the customer's applications and products using Nexperia products in order to avoid a default of the applications and the products or of the application or use by customer's third party customer(s). Nexperia does not accept any liability in this respect.

Limiting values — Stress above one or more limiting values (as defined in the Absolute Maximum Ratings System of IEC 60134) will cause permanent damage to the device. Limiting values are stress ratings only and (proper) operation of the device at these or any other conditions above those given in the Recommended operating conditions section (if present) or the Characteristics sections of this document is not warranted. Constant or repeated exposure to limiting values will permanently and irreversibly affect the quality and reliability of the device.

Terms and conditions of commercial sale — Nexperia products are sold subject to the general terms and conditions of commercial sale, as published at <http://www.nexperia.com/profile/terms>, unless otherwise agreed in a valid written individual agreement. In case an individual agreement is concluded only the terms and conditions of the respective agreement shall apply. Nexperia hereby expressly objects to applying the customer's general terms and conditions with regard to the purchase of Nexperia products by customer.

No offer to sell or license — Nothing in this document may be interpreted or construed as an offer to sell products that is open for acceptance or the grant, conveyance or implication of any license under any copyrights, patents or other industrial or intellectual property rights.

Export control — This document as well as the item(s) described herein may be subject to export control regulations. Export might require a prior authorization from competent authorities.

Translations — A non-English (translated) version of a document is for reference only. The English version shall prevail in case of any discrepancy between the translated and English versions.

Trademarks

Notice: All referenced brands, product names, service names and trademarks are the property of their respective owners.

Contents

1. General description.....	1
2. Features and benefits.....	1
3. Applications.....	1
4. Quick reference data.....	1
5. Pinning information.....	2
6. Ordering information.....	2
7. Marking.....	2
8. Limiting values.....	2
9. Thermal characteristics.....	4
10. Characteristics.....	5
11. Package outline.....	10
12. Soldering.....	11
13. Legal information.....	12

© Nexperia B.V. 2023. All rights reserved

For more information, please visit: <http://www.nexperia.com>

For sales office addresses, please send an email to: salesaddresses@nexperia.com

Date of release: 9 May 2023
