

MDT0700ESR-HDMI	1024 x 600	HDMI Interface	TFT Module
(MCT070HDMI-B-RTP) Specification			
Version: 1		Date: 28/06/2019	
Revision			
1	27/06/2019	First issue	

Display Features			
Display Size	7.0"		
Resolution	1024 x 600		
Orientation	Landscape		
Appearance	RGB		
Logic Voltage	5V		
Interface	HDMI		
Brightness	400 cd/m ²		
Touchscreen	RTP		
Module Size	165.00 x 99.80 x 26.30mm		
Operating Temperature	-20°C ~ +70°C		
Pinout	HDMI		Box Quantity
Pitch	---	---	Weight / Display

* - For full design functionality, please use this specification in conjunction with the TFP401 specification.(Provided Separately)

Display Accessories	
Part Number	Description
MCIB-HDMI/HDMI	Male To Male HDMI Connector
MCIC-USB	USB-to-Micro USB interconnect cable.

Optional Variants	
Appearances	Voltage



Summary

TFT 7.0" is a TN transmissive type color active matrix TFT liquid crystal display that use amorphous silicon TFT as switching devices. This module is composed of a TFT_LCD module, It is usually designed for industrial application and this module follows RoHs.

General Specifications

- Size: 7.0 inch
- Dot Matrix: 1024 x RGBx600(TFT) dots
- Module dimension: 165.0(W) x 99.8(H) x 26.3(D) mm
- Active area: 154.2144 x 85.92 mm
- Dot pitch: 0.1506 x 0.1432 mm
- LCD type: TFT, Normally White, Transmissive
- View Direction: 12 o'clock
- Gray Scale Inversion Direction: 6 o'clock
- Aspect Ratio: 16:9
- Backlight Type: LED, Normally White
- Controller IC: TFP401 or equivalent
- RTP Interface: USB
- With /Without TP: With RTP
- TFT Interface: HDMI
- Surface: Anti-Glare

*Color tone slight changed by temperature and driving voltage.



Interface

1. LCM PIN Definition(CON6)

Pin	Symbol	Function	Remark
1	NC	No connection	
2	5V	Raspberry Pi:Power 5V	
3	GPIO02	Raspberry Pi:GPIO02	
4	5V	Raspberry Pi:Power 5V	
5	GPIO03	Raspberry Pi:GPIO03	
6	GND	Raspberry Pi:GND	
7	GPIO04	Raspberry Pi:GPIO04	
8	GPIO14	Raspberry Pi:GPIO14	
9	GND	Raspberry Pi:GND	
10	GPIO15	Raspberry Pi:GPIO15	
11	GPIO17	Raspberry Pi:GPIO17	
12	GPIO18	Raspberry Pi:GPIO18 (Backlight Enable)	
13	GPIO27	Raspberry Pi:GPIO27	
14	GND	Raspberry Pi:GND	
15	GPIO22	Raspberry Pi:GPIO22	
16	GPIO23	Raspberry Pi:GPIO23	
17	NC	No connection	
18	GPIO24	Raspberry Pi:GPIO24	
19	GPIO10	Raspberry Pi:GPIO10	
20	GND	Raspberry Pi:GND	
21	GPIO09	Raspberry Pi:GPIO09	
22	GPIO25	Raspberry Pi:GPIO25	
23	GPIO11	Raspberry Pi:GPIO11	
24	GPIO08	Raspberry Pi:GPIO08	
25	GND	Raspberry Pi:GND	
26	GPIO07	Raspberry Pi:GPIO07	
27	ID_SD	Raspberry Pi:ID_SD	
28	ID_SC	Raspberry Pi:ID_SC	
29	GPIO05	Raspberry Pi:GPIO05	
30	GND	Raspberry Pi:GND	
31	GPIO06	Raspberry Pi:GPIO06	



32	GPIO12	Raspberry Pi:GPIO12	
33	GPIO13	Raspberry Pi:GPIO13	
34	GND	Raspberry Pi:GND	
35	GPIO19	Raspberry Pi:GPIO19	
36	GPIO16	Raspberry Pi:GPIO16	
37	GPIO26	Raspberry Pi:GPIO26	
38	GPIO20	Raspberry Pi:GPIO20	
39	GND	Raspberry Pi:GND	
40	GPIO21	Raspberry Pi:GPIO21	

2. LCM PIN Definition (CON5)

Pin	Symbol	Function	Remark
1	3.3V	TFT Module Power limit can only output 3.3V,100mA	Note1
2	5V	Raspberry Pi:Power 5V	
3	GPIO02	Raspberry Pi:GPIO02	
4	5V	Raspberry Pi:Power 5V	
5	GPIO03	Raspberry Pi:GPIO03	
6	GND	Raspberry Pi:GND	
7	GPIO04	Raspberry Pi:GPIO04	
8	GPIO14	Raspberry Pi:GPIO14	
9	GND	Raspberry Pi:GND	
10	GPIO15	Raspberry Pi:GPIO15	
11	GPIO17	Raspberry Pi:GPIO17	
12	GPIO18	Raspberry Pi:GPIO18 (Backlight Enable)	
13	GPIO27	Raspberry Pi:GPIO27	
14	GND	Raspberry Pi:GND	
15	GPIO22	Raspberry Pi:GPIO22	
16	GPIO23	Raspberry Pi:GPIO23	
17	3.3V	TFT Module Power limit can only output 3.3V,100mA	Note1
18	GPIO24	Raspberry Pi:GPIO24	
19	GPIO10	Raspberry Pi:GPIO10	
20	GND	Raspberry Pi:GND	
21	GPIO09	Raspberry Pi:GPIO09	
22	GPIO25	Raspberry Pi:GPIO25	



23	GPIO11	Raspberry Pi:GPIO11	
24	GPIO08	Raspberry Pi:GPIO08	
25	GND	Raspberry Pi:GND	
26	GPIO07	Raspberry Pi:GPIO07	
27	ID_SD	Raspberry Pi:ID_SD	
28	ID_SC	Raspberry Pi:ID_SC	
29	GPIO05	Raspberry Pi:GPIO05	
30	GND	Raspberry Pi:GND	
31	GPIO06	Raspberry Pi:GPIO06	
32	GPIO12	Raspberry Pi:GPIO12	
33	GPIO13	Raspberry Pi:GPIO13	
34	GND	Raspberry Pi:GND	
35	GPIO19	Raspberry Pi:GPIO19	
36	GPIO16	Raspberry Pi:GPIO16	
37	GPIO26	Raspberry Pi:GPIO26	
38	GPIO20	Raspberry Pi:GPIO20	
39	GND	Raspberry Pi:GND	
40	GPIO21	Raspberry Pi:GPIO21	

Note1: The 3.3V supply current is limited; please pay special attention to use

3. USB

Pin	Symbol	Function	Remark
1	5V	Power Supply (5V)	
2	D-	Data line -	
3	D+	Data line +	
4	NC	No connection	
5	GND	Power Ground	



4. POWER JACK

Pin No.	Symbol	I/O	Function	Remark
1	5V	P	Power Supply (5V)	
2	GND	P	Ground	
3	NC		No connection	

* Display need to use power jack to power on due to HDMI port not able to fulfill the supply current

5. HDMI

Pin No.	Symbol	I/O	Function	Remark
1	Rx2+	I	+LVDS Differential Data Input	
2	GND	P	Ground	
3	Rx2-	I	-LVDS Differential Data Input	
4	Rx1+	I	+LVDS Differential Data Input	
5	GND	P	Ground	
6	Rx1-	I	-LVDS Differential Data Input	
7	Rx0+	I	+LVDS Differential Data Input	
8	GND	P	Ground	
9	Rx0-	I	-LVDS Differential Data Input	
10	RxC+	I	+LVDS Differential Clock Input	
11	GND	P	Ground	
12	RxC-	I	-LVDS Differential Clock Input	
13-14	NC	-	No connection	
15	SCL	I/O	DDC(Data Display Channel) Clock	
16	SDA	I/O	DDC(Data Display Channel) Data	
17	GND	P	Ground	
18	5V	P	Power Supply	
19	Detect	I/O	Hot plug detect	

I: input, O: output, P: Power



Contour Drawing

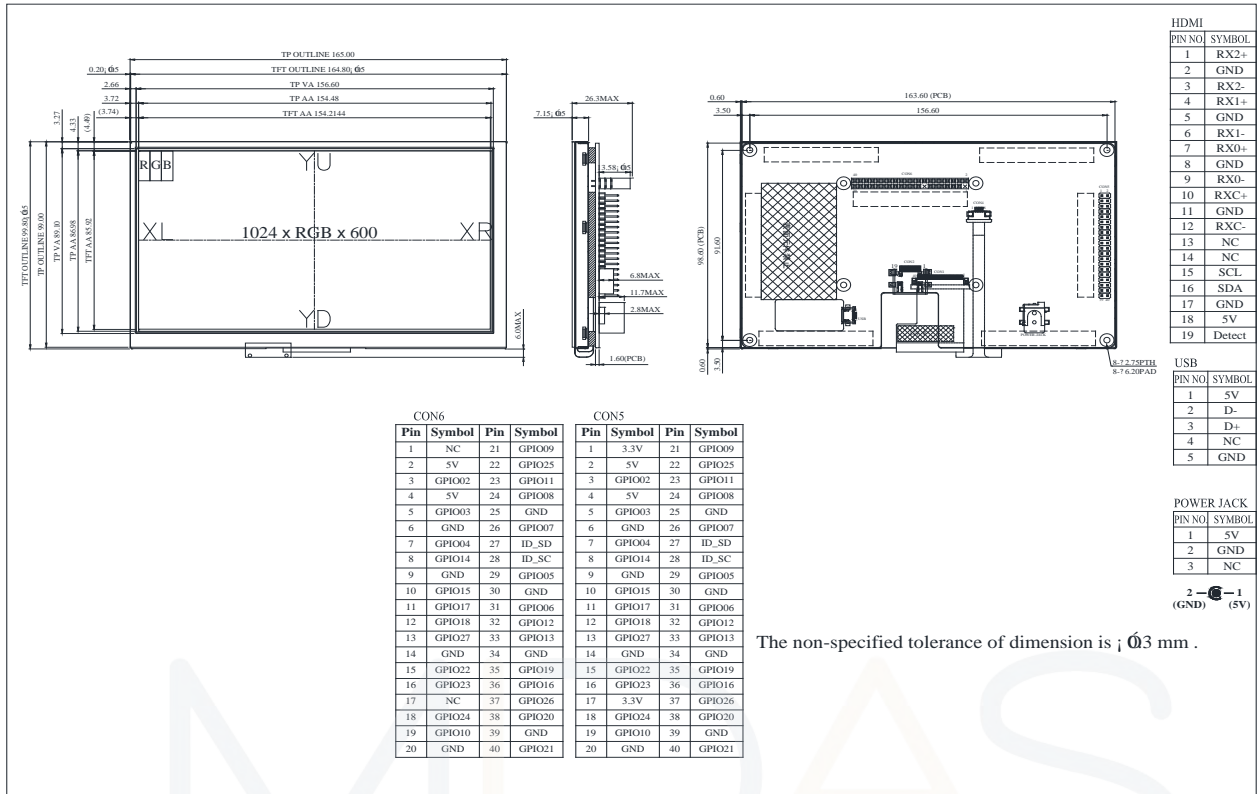

Absolute Maximum Ratings

Item	Symbol	Min	Typ	Max	Unit
Operating Temperature	TOP	-20	—	+70	°C
Storage Temperature	TST	-30	—	+80	°C

Note: Device is subject to be damaged permanently if stresses beyond those absolute maximum ratings listed above

- Temp. $\leq 60^\circ\text{C}$, 90% RH MAX. Temp. $> 60^\circ\text{C}$, Absolute humidity shall be less than 90% RH at 60°C

Electrical Characteristics

1. Operating conditions:

Item	Symbol	Condition	Min	Typ	Max	Unit	Remark
Supply Voltage For LCM	VDD	—	4.9	5	5.1	V	-
Supply Current For LCM	IDD	—	—	870	1200	mA	Note 1
LED life time	—	—	—	50,000	—	Hr	Note 4

Note 1 : This value is test for VDD =5.0V , Ta=25°C only

Note 2 : Display with Raspberry pi the driver power is over USB , first make sure you have a 2A power supply, with a good quality USB cable, a thin wire power cable is no good. Make sure its 24AWG or smaller, shorter USB cables are better too.

Note3 : Touch panel driver is base on the mouse driver program and through USB port connect to PC or embedded board.Can only support the single touch.

Note 4: The “LED life time” is defined as the module brightness decrease to 50% original brightness at Ta=25°C and IL =300mA. The LED lifetime could be decreased if operating IL is lager than 300mA.

design • manufacture • supply



Optical Characteristics

Item	Symbol	Condition.	Min	Typ.	Max.	Unit	Remark	
Response time	Tr	$\theta=0^\circ$ 、 $\Phi=0^\circ$	-	25	40	.ms	Note 3	
	Tf							
Contrast ratio	CR	At optimized viewing angle	600	800	-	-	Note 4	
Color Chromaticity	White	$\theta=0^\circ$ 、 $\Phi=0^\circ$	0.26	0.31	0.36	-	Note 2,5,6	
								Wy
Viewing angle (Gray Scale Inversion Direction)	Hor.	$CR \geq 10$	70	80	-	Deg.	Note 1	
								Θ_L
	Ver.							Φ_T
								Φ_B
Brightness	-	-	350	400	-	cd/m ²	Center of display	
Uniformity	(U)	-	70	-	-	%	Note 5	

Ta=25±2°C,

Note 1: Definition of viewing angle range

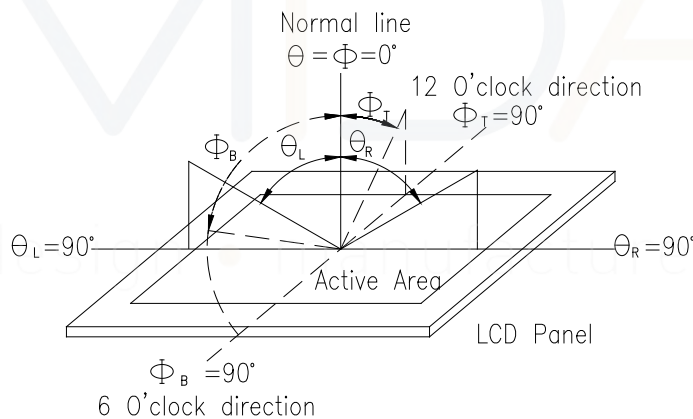

Fig. 8.1. Definition of viewing angle

Note 2: Test equipment setup:

After stabilizing and leaving the panel alone at a driven temperature for 10 minutes, the measurement should be executed. Measurement should be executed in a stable, windless, and dark room. Optical specifications are measured by Topcon BM-7 or BM-5 luminance meter 1.0° field of view at a distance of 50cm and normal direction.

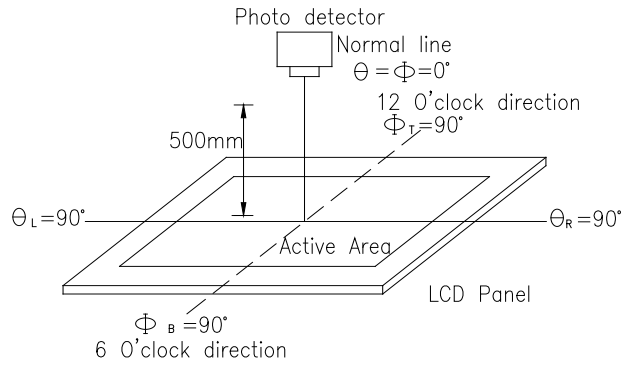
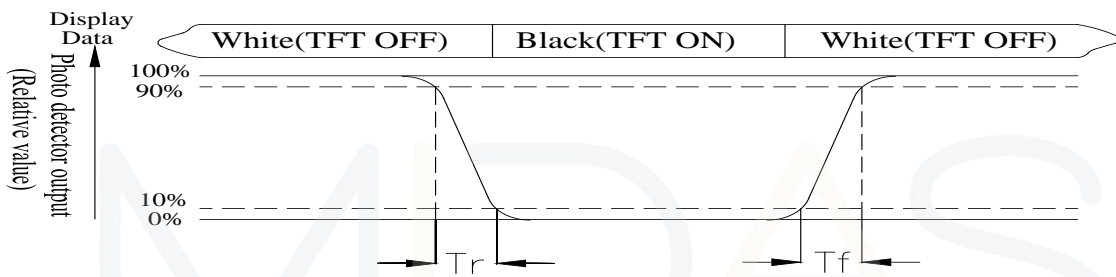

Fig. 8.2. Optical measurement system setup

Note 3: Definition of Response time:

The response time is defined as the LCD optical switching time interval between "White" state and "Black" state. Rise time, T_r , is the time between photo detector output intensity changed from 90% to 10%. And fall time, T_f , is the time between photo detector output intensity changed from 10% to 90%



Note 4: Definition of contrast ratio:

The contrast ratio is defined as the following expression.

$$\text{Contrast ratio (CR)} = \frac{\text{Luminance measured when LCD on the "White" state}}{\text{Luminance measured when LCD on the "Black" state}}$$

design • manufacture • supply



Note 5: Definition of Luminance Uniformity

Active area is divided into 9 measuring areas (reference the picture in below). Every measuring point is placed at the center of each measuring area.

Luminance Uniformity (U) = $L_{min}/L_{max} \times 100\%$

L = Active area length

W = Active area width

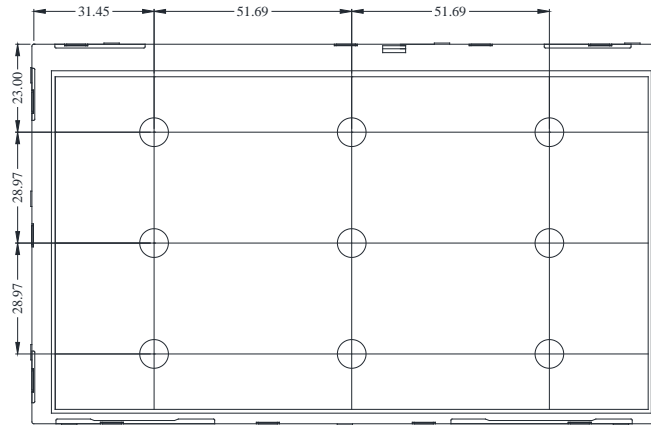

Fig8.3. Definition of uniformity

Note 6: Definition of color chromaticity (CIE 1931)

Color coordinates measured at the center point of LCD

Note 7: Measured at the center area of the panel when all the input terminals of LCD panel are electrically opened.

design • manufacture • supply



Reliability

Content of Reliability Test (Wide temperature, -20°C~70°C)

Environmental Test			
Test Item	Content of Test	Test Condition	Note
High Temperature storage	Endurance test applying the high storage temperature for a long time.	80°C 200hrs	2
Low Temperature storage	Endurance test applying the low storage temperature for a long time.	-30°C 200hrs	1,2
High Temperature Operation	Endurance test applying the electric stress (Voltage & Current) and the thermal stress to the element for a long time.	70°C 200hrs	—
Low Temperature Operation	Endurance test applying the electric stress under low temperature for a long time.	-20°C 200hrs	1
High Temperature/ Humidity Operation	The module should be allowed to stand at 60°C,90%RH max	60°C,90%RH 96hrs	1,2
Thermal shock resistance	The sample should be allowed stand the following 10 cycles of operation <div style="text-align: center;"> <p style="margin: 0;">-20°C 25°C 70°C</p> <p style="margin: 0;">30min 5min 30min</p> <p style="margin: 0;">1 cycle</p> </div>	-20°C/70°C 10 cycles	—
Vibration test	Endurance test applying the vibration during transportation and using.	Total fixed amplitude : 1.5mm Vibration Frequency : 10~55Hz One cycle 60 seconds to 3 directions of X,Y,Z for Each 15 minutes	3
Static electricity test	Endurance test applying the electric stress to the terminal.	VS=±600V(contact) ,±800v(air), RS=330Ω CS=150pF 10 times	—

Note1: No dew condensation to be observed.

Note2: The function test shall be conducted after 4 hours storage at the normal Temperature and humidity after remove from the test chamber.

Note3: The packing have to including into the vibration testing.



Touch Panel Information

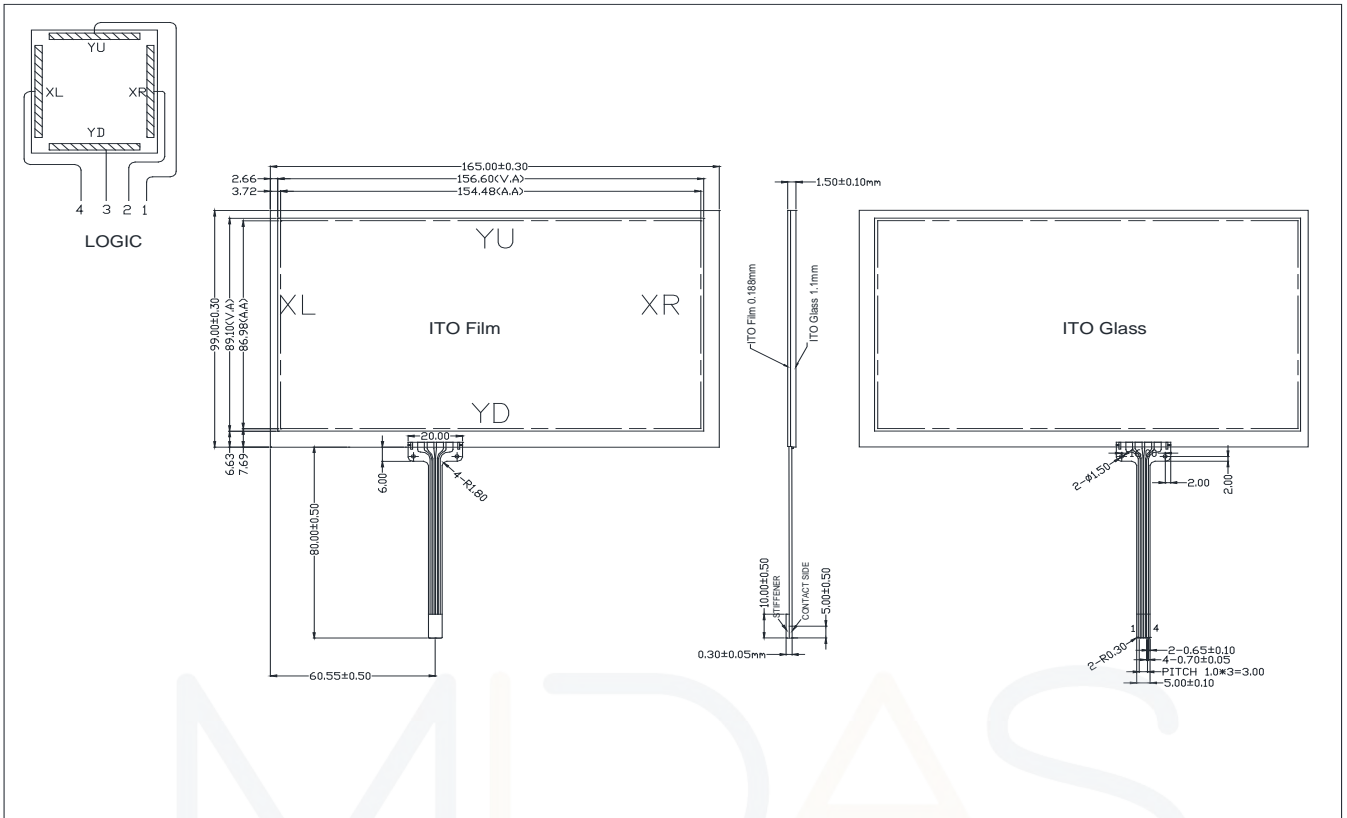

Resistance Touch Panel General Specifications

Item	Description
Driving condition	DC3~7V
Operating force	30~80g
Linearity max	≤±1.5%
Insulating resistance	> 10MΩ , 25V(DC)
Light transparency	70%
Structure type	ITO Film/ITO Glass(F/G)
Surface Hardness	3H typ
Pen Hitting Durability (with the silicon rubber)	> 1000,000 times
X Axis resistance	430~910Ω
Y Axis resistance	150~530Ω

