

# Specification

**Patent Pending**

- Part No. : **PCUWB01.01.0500G**
- Description : Ultra-Wide Band Omnidirectional Antenna  
For 3-5GHz & 6-10GHz
- Features : Omnidirectional Radiation Pattern  
For European and USA UWB Applications  
In Channels 1-15  
Frequency: 3-5GHz & 6-10GHz  
IP67 Rated Enclosure  
Adhesive Mount on Plastic  
Cable: Low Loss 0.5M CFD200  
Connector: SMA(M) ST  
Dims: 36\*10\*10mm  
**RoHS compliant**



## 1. Introduction

The PCUWB.01 is the only external adhesive-mount UWB antenna designed to cover all worldwide UWB frequencies. With excellent efficiency and an omnidirectional radiation pattern, it provides strong, homogeneous coverage in all directions from the sensor. PCUWB.01 also shows excellent fidelity factor numbers and low group delay variation to preserve maximum signal integrity.

Ultra-Wideband (also known as UWB) is a low power digital wireless technology for transmitting large amounts of digital data over a wide spectrum of frequency bands typically spanning more than 500MHz with very low power for short distances.

The low power requirements of UWB mean increased battery life of sensors and tags leading to reduction in overall operational costs. PCUWB.01 is one of several Taoglas-developed antennas designed for seamless integration with the recently launched Decawave ScenSor DW1000 module as well as compatibility with any other UWB sensor modules on the market.

### Applications and Uses

- Precision surveying
- Smart home and entertainment systems
- Indoor position location and tracking applications

The PCUWB.01 enclosure is made from IP67 rated PP making it ideal for both indoor and outdoor environments. Cable and connectors for the PCUWB.01 are customizable. Contact your regional Taoglas sales office for support.

## **1.1. Applications of Pulsed UWB antenna Technology**

**Radar**-These short-pulsed antennas provide very fine range resolution and precision distance and positioning measurement capabilities. UWB signals enable inexpensive high definition radar antennas which find use in automotive sensors, smart airbags, and precision surveying applications amongst many others.

**Home Network Connectivity**- Smart home and entertainment systems can take advantage of high data rates for streaming high quality audio and video contents in real time for consumer electronics and computing within a home environment.

**Position location & Tracking**- UWB antennas also find use in Position Location and Tracking applications such as locating patients in case of critical condition, hikers injured in remote areas, tracking cars, and managing a variety of goods in a big shopping mall. UWB offers better noise immunity and better accuracy to within a few cm compared to current localization technologies such as Assisted GPS for Indoors, Wi-Fi and cellular which are at best able to offer meter level precision. Tethered Indoor positioning UWB systems that measure the angles of arrival of ultra-wideband (UWB) radio signals perform triangulation by using multiple sensors to communicate with a tag device.

## 2. Specification

<b>ELECTRICAL</b>			
STANDARD	USA UWB channels 1-4	EU UWB/ USA UWB channels 5-8	USA UWB channels 9-15
Operation Frequency (GHz)	3.1–5.0	6.2–8.0	8.0–10.3
Efficiency (%)			
0.5 m	>65%	>55%	>39%
1 m	>55%	>45%	>30%
3 m	>35%	>25%	>19%
5 m	>27%	>16%	>11%
Peak Gain (dBi)			
0.5 m	<7.5	<4.1	<4.1
1 m	<6.3	<3.9	<3.9
3 m	<4.8	<1.2	<2
5 m	<3.5	<0	<-1.5
Average Gain (dB)			
0.5 m	>-1.8	>-2.8	>-4.2
1 m	>-2.6	>-3.5	>-4.8
3 m	>-4.2	>-6	>-7.6
5 m	>-5.8	>-8	>-9.7
Return Loss (dB)	<-8	<-4	<-6
Max VSWR	>2:1	>3:1	>3:1
Radiation Properties	Omnidirectional		
Polarization	Linear		
Impedance	50 Ω		
Max	5 W		
<b>MECHANICAL</b>			
Dimension	36*30*10 mm		
Casing	PP		
Connector	SMA(M) ST, fully customizable		
Cable	0.5M CFD200, fully customizable		
Waterproof	IP67		
Weight	50g		
<b>ENVIRONMENTAL</b>			
Operation Temperature	-40°C to 85°C		
Storage Temperature	-40°C to 85°C		
Humidity	Non-condensino 65°C 95% RH		

## 3. Antenna Characteristics

### 3.1. Return Loss

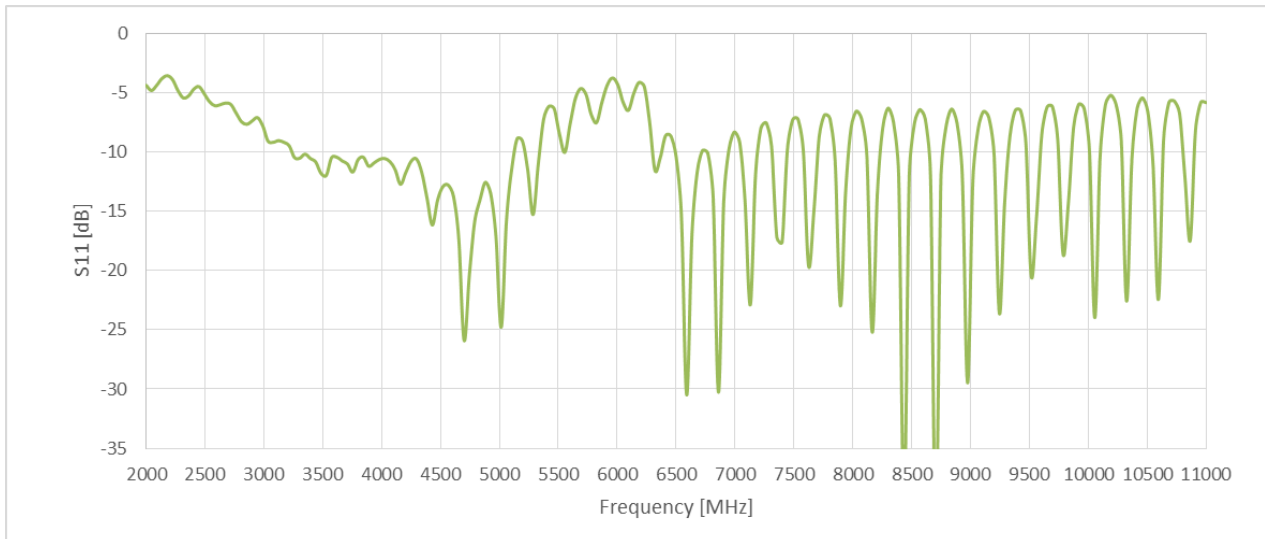

### 3.2. VSWR

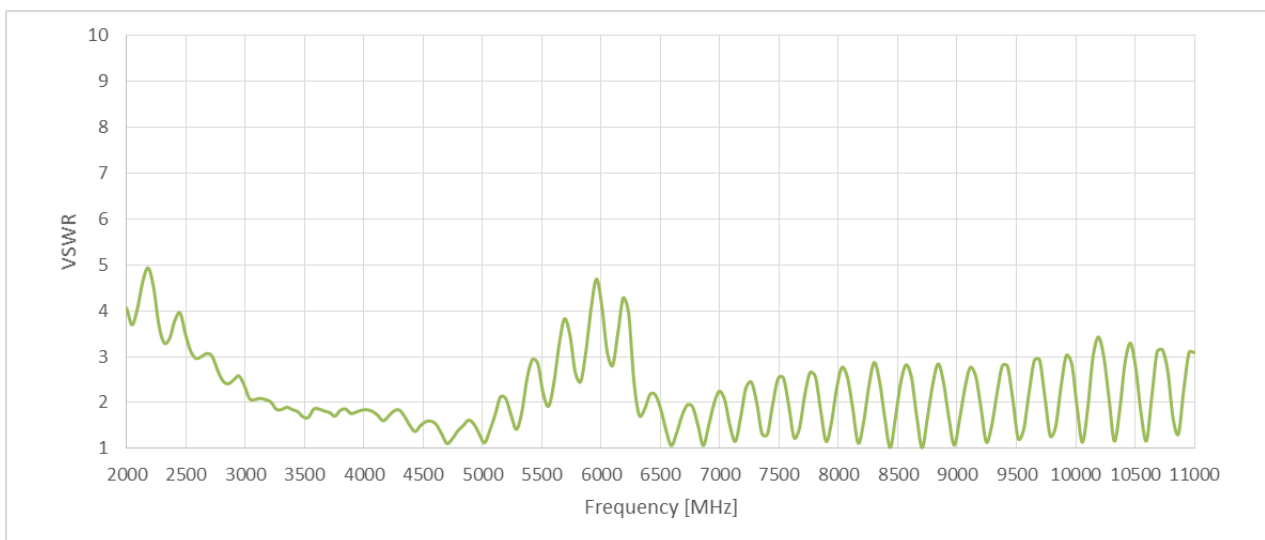

### 3.3. Efficiency

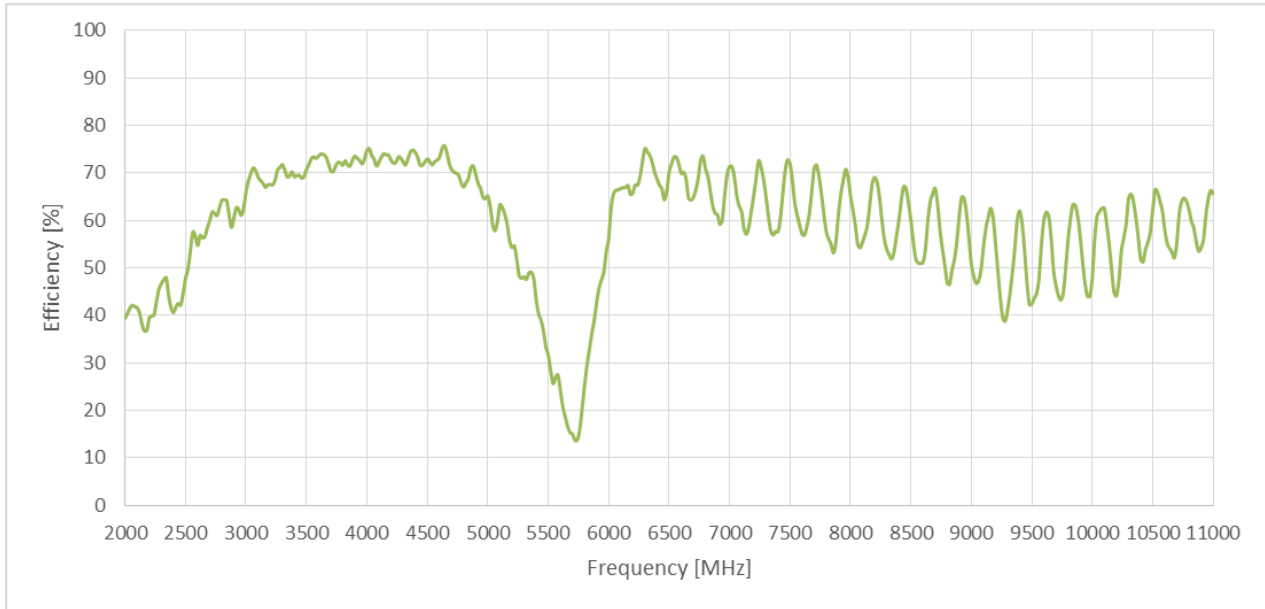

### 3.4. Peak Gain

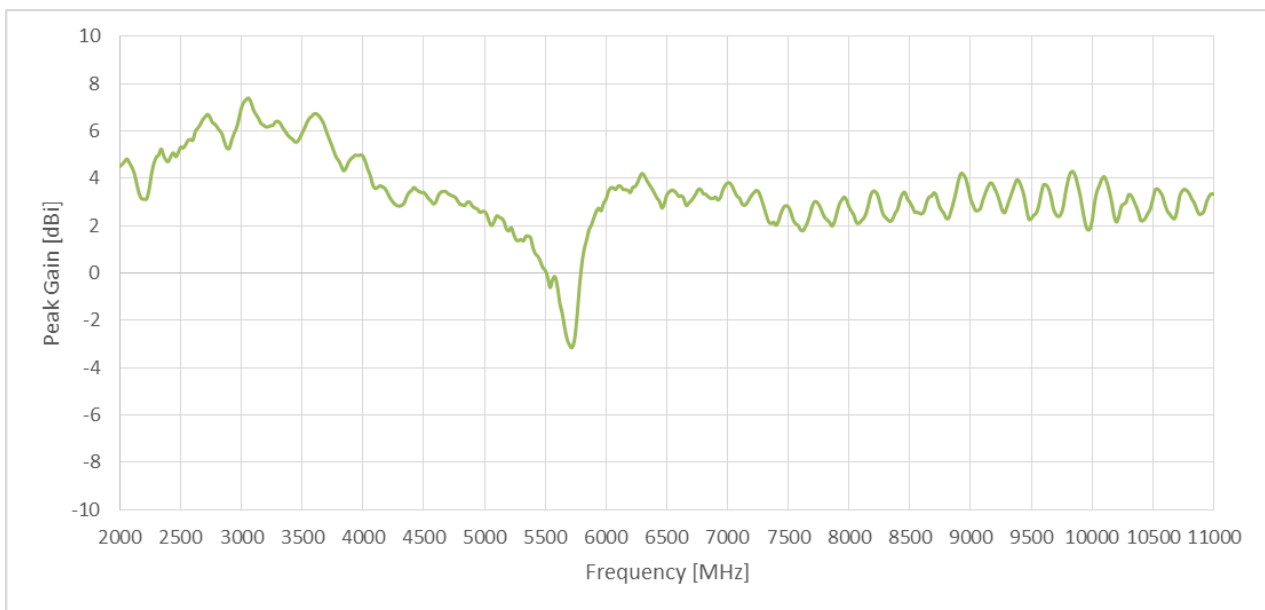

### 3.5. Average Gain

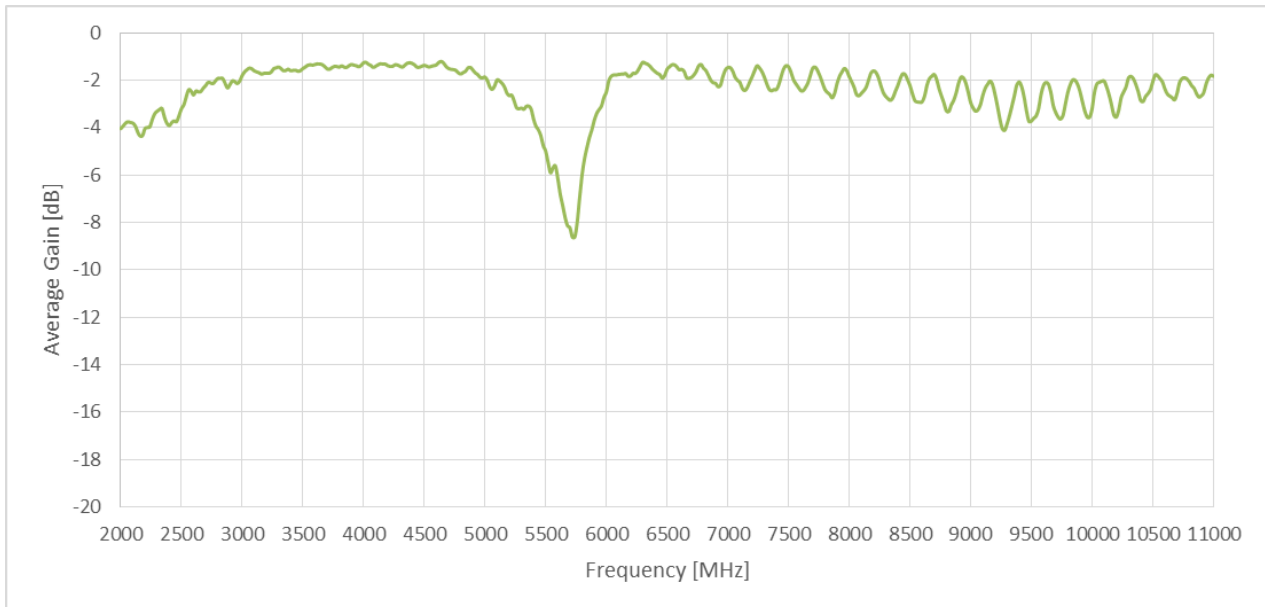

### 3.6. Antenna Radiation Pattern

#### 3.6.1. Measurement Setup

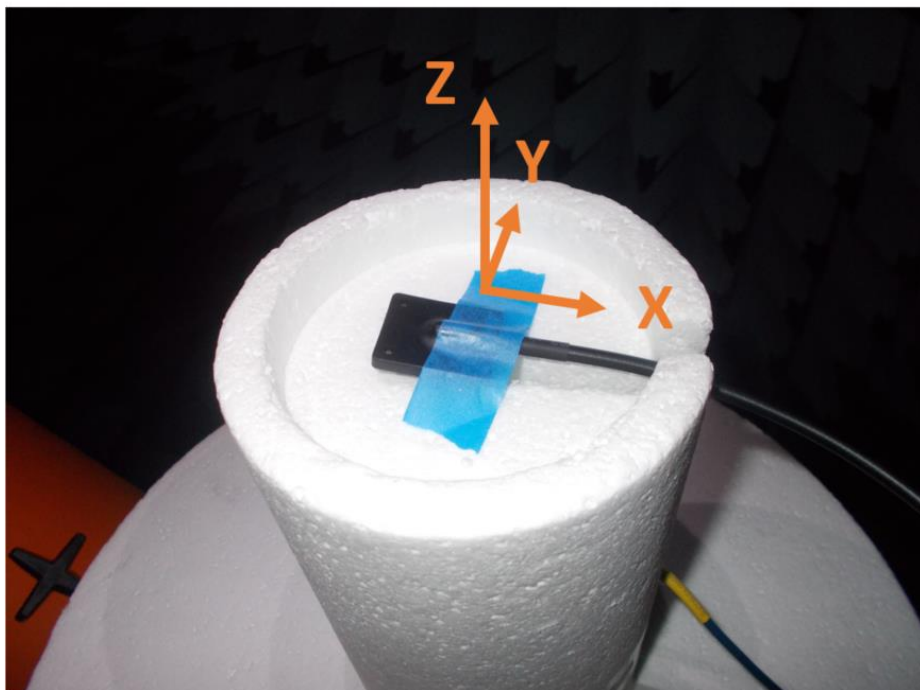

### 3.6.2. 2D Radiation Pattern (dBi)

#### XY Plane

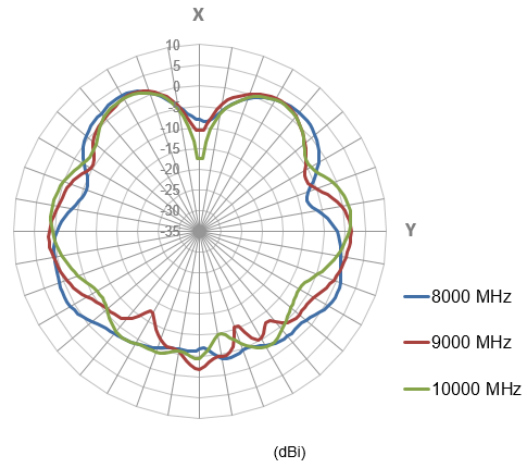
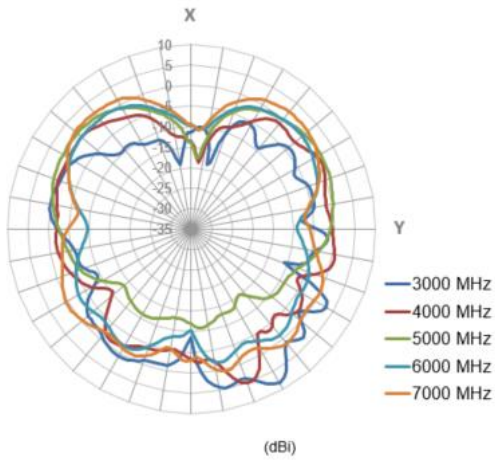

#### YZ Plane

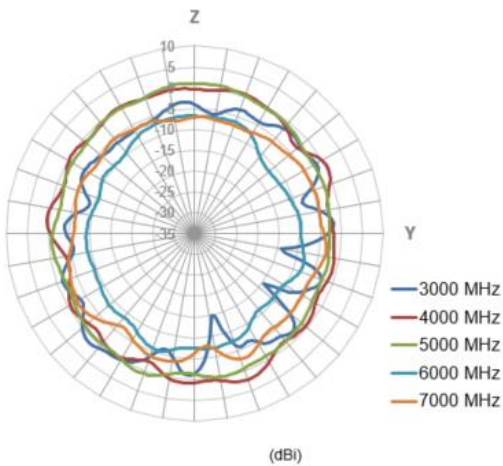

#### XZ Plane

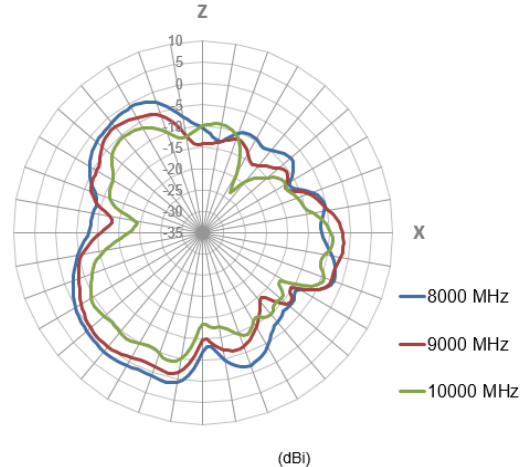
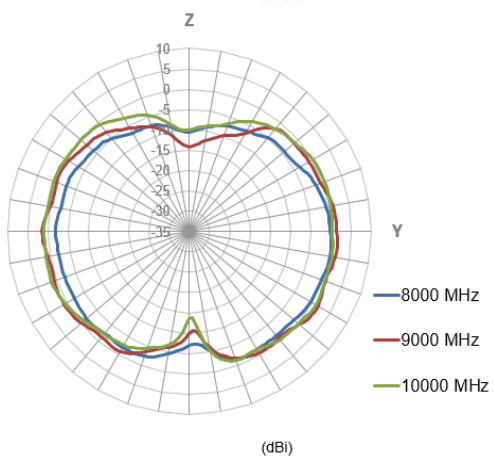
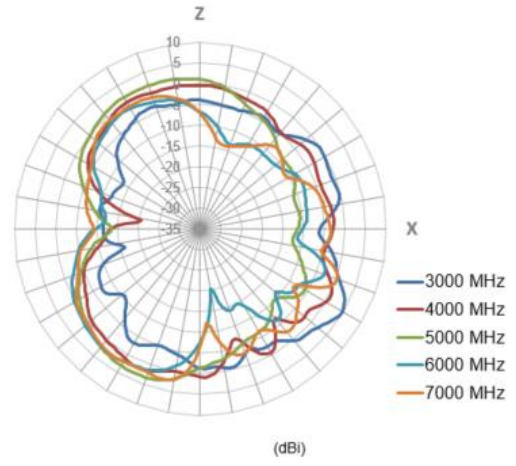



### 3.6.3. 3D Radiation Pattern (dBi)

**4GHz**

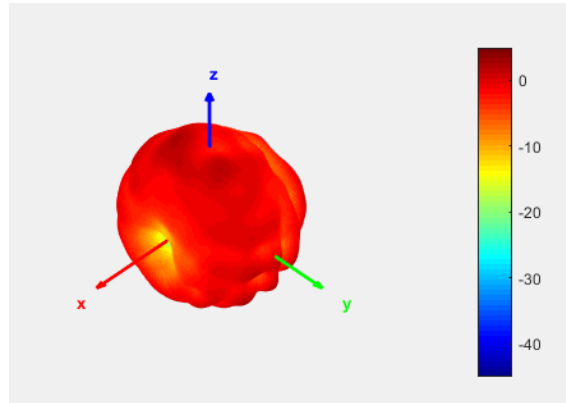

**6 GHz**

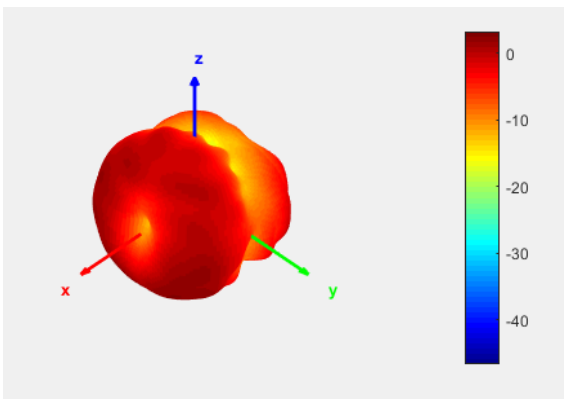

**7 GHz**

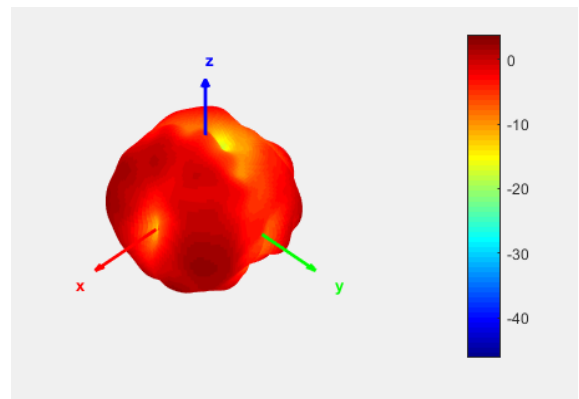

**9 GHz**

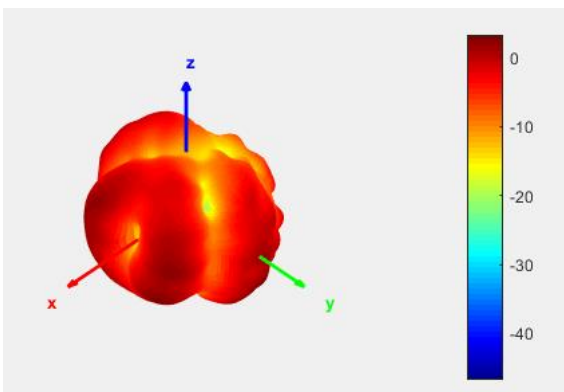

**10 GHz**

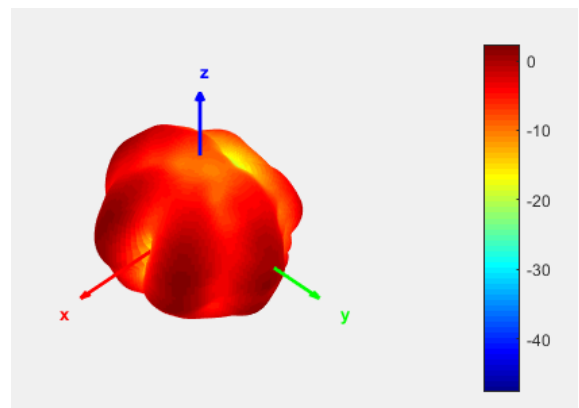

### 3.7. Group Delay

Total system group delay includes the propagation delay in the transmitting antenna (Tx), propagation channel (Ch), and receiving antenna (Rx). Group delay can vary across directions of propagation (theta or phi angles). This group delay variation over theta or phi represents output signal distortions and should be known and minimized if possible.

The measured and normalized group delay value for PCUWB.01 is presented below for 4 principal angles in the YZ plane, measured at 4 GHz and 6.5 GHz (UWB channels 2 and 5). A group delay variation of 100-150 ps is considered excellent for UWB system implementation. The observed group delay variation of 99 ps in channel 2 and 150 ps in channel 5 for PCUWB.01 will provide excellent performance.

The measurements were performed using the EVK1000 Decawave kit with the PCUWB.01 antenna as both the receiver and AUT device.

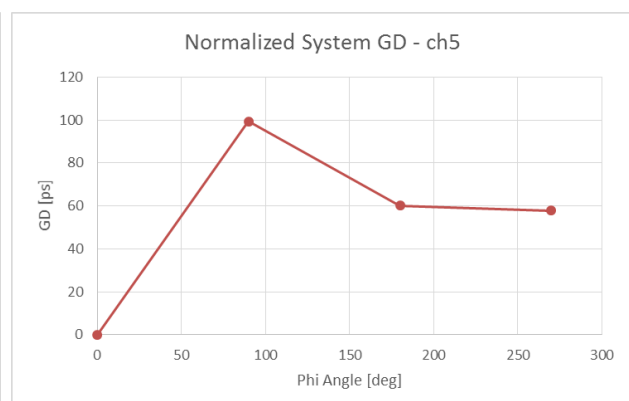
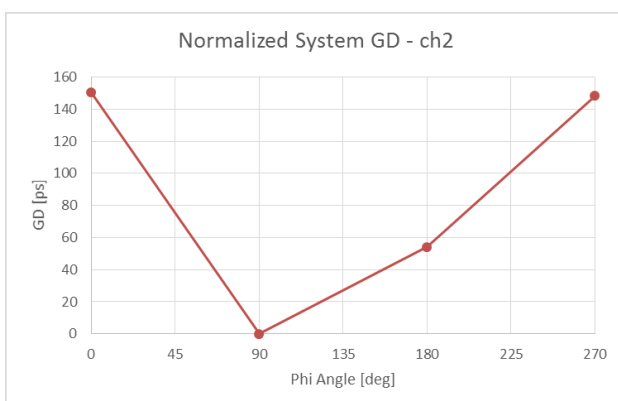

Additionally, simulation was performed over the whole frequency and the group delay variation (between the 4 principal angles in the yz-plane) is presented below. The data shows good agreement with measurements in channels 2 and 5 – the simulated values are lower than measured which is expected due to simplified and idealized propagation conditions in simulation. This confirms that good performance is expected for the rest of UWB channels as well.

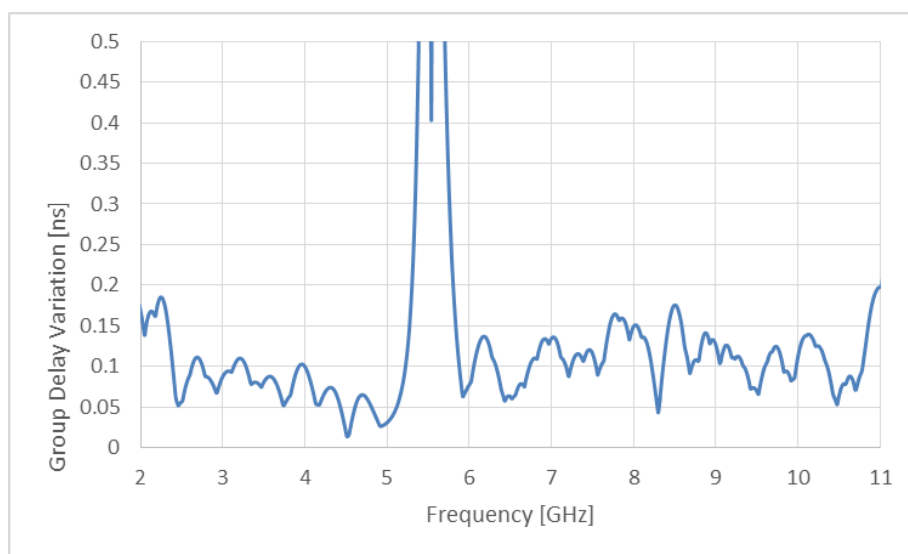

### 3.8. Fidelity Factor vs. Theta Angle

The fidelity is above 0.9 (benchmark value) for all Theta angles, therefore UWC.01 shows very good performance.

UWC.40 Fidelity Factor		
Angle	Ch 2	Ch 5
0°	0.99	0.99
45°	0.99	0.99
90°	0.99	0.98
135°	0.99	0.99
180°	0.99	0.99

## 4. Mechanical Drawing (Unit: mm)

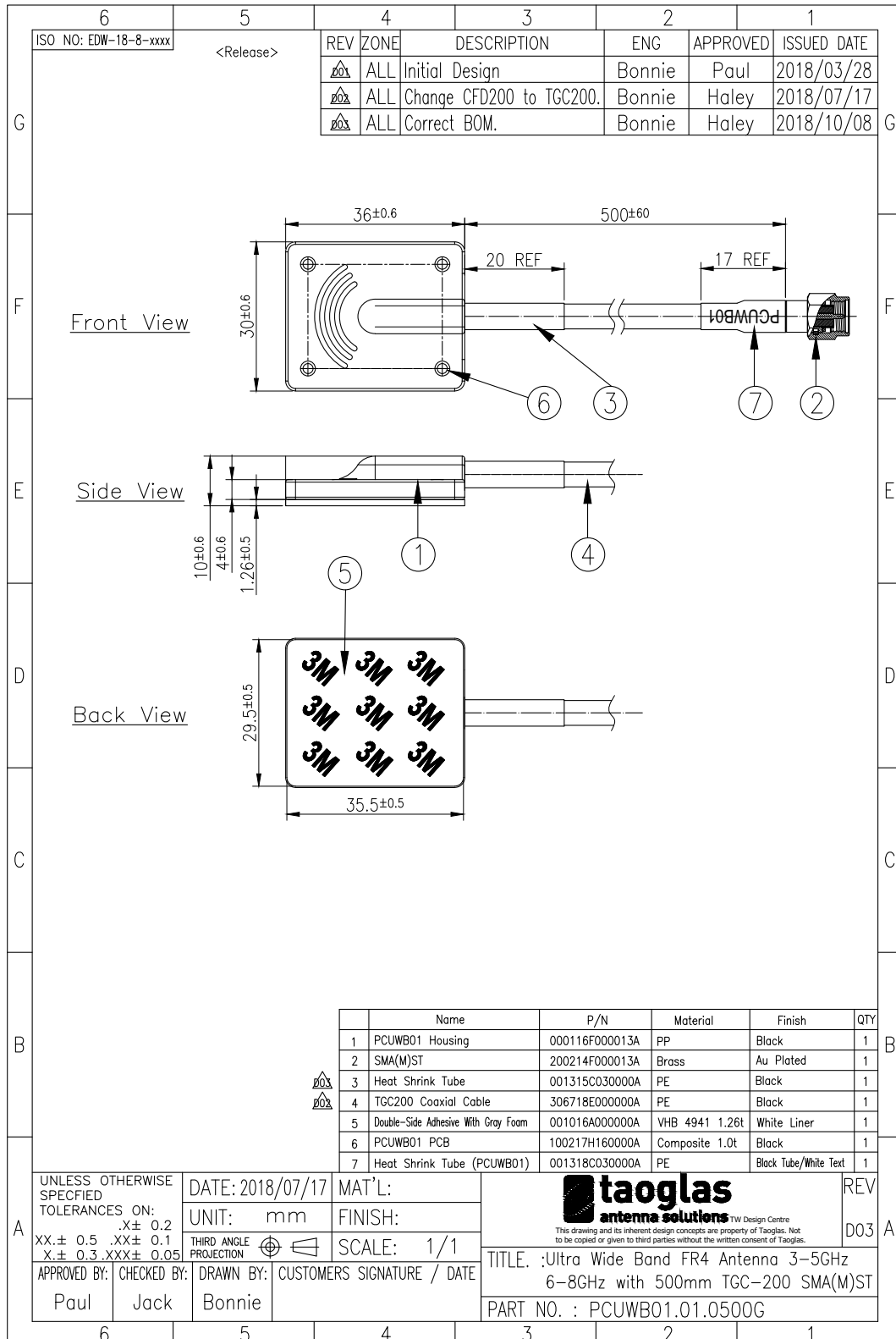

## 5. Packaging

1pc PCUWB01.01.0500G per Small PE Bag  
 Bag Dimensions - 160\*300mm  
 Weight - 50g

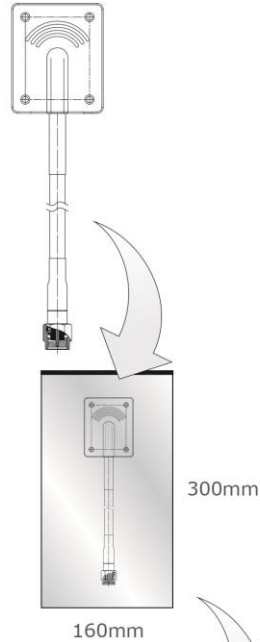

50pcs PCUWB01.01.0500G per Carton  
 Carton Dimensions - 320\*250\*290mm  
 Weight - 2.6Kg

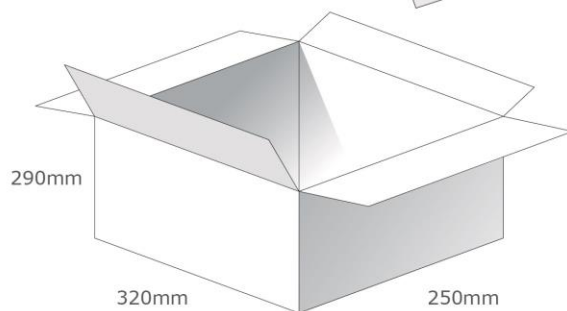

Pallet Dimensions:  
 1100mm\*1000mm\*1360mm  
 48 Cartons per Pallet  
 12 Cartons per Layer, 4 Layers

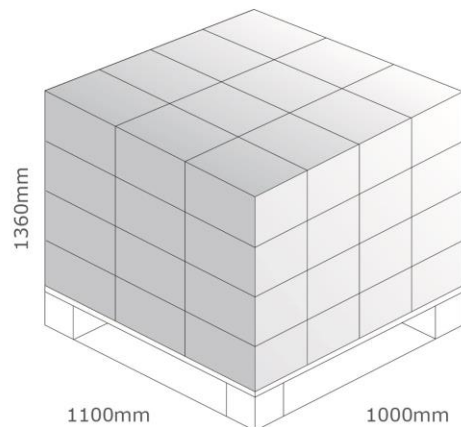

## 6. Application Note

The PCUWB.01 Antenna performance with different cable lengths is shown below. Cable lengths longer than 3m are not recommended as the antenna efficiency at higher frequencies falls below 30% (i.e. average gain below -5 dB) which can lead to poor range performance.

### 6.1.1. Return Loss

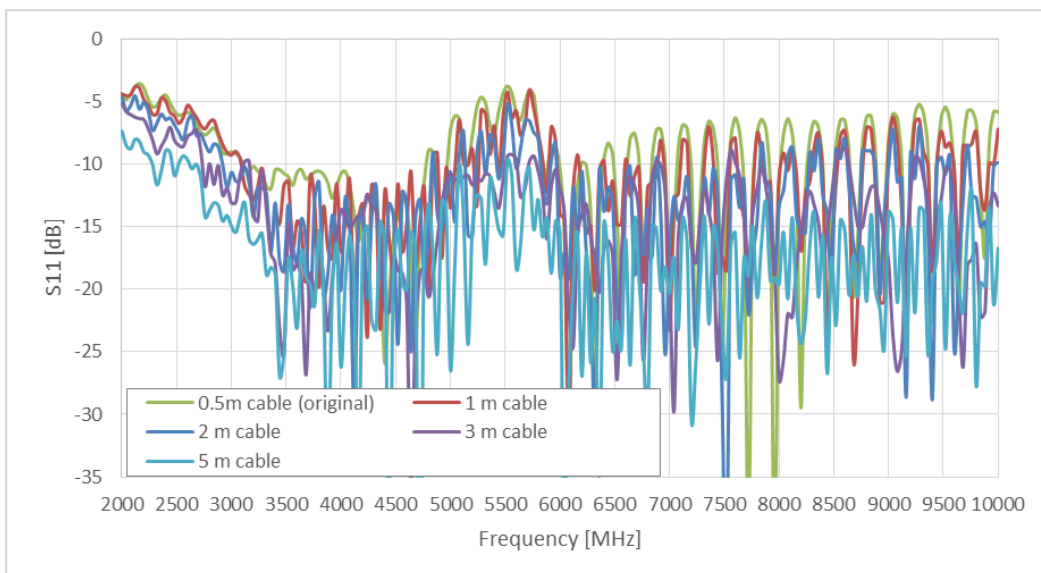

### 6.1.2. Efficiency

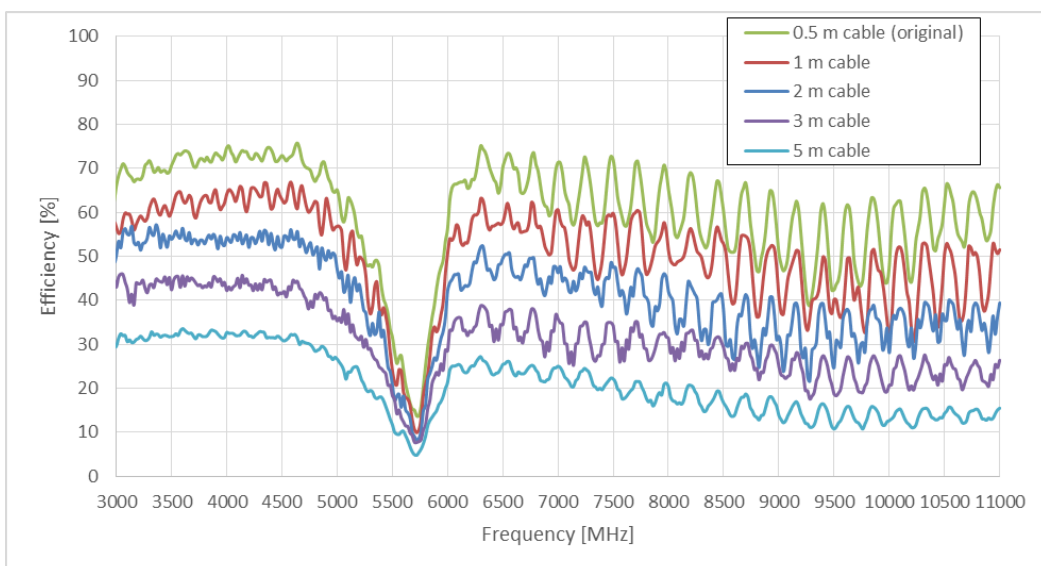

6.1.3. Peak Gain

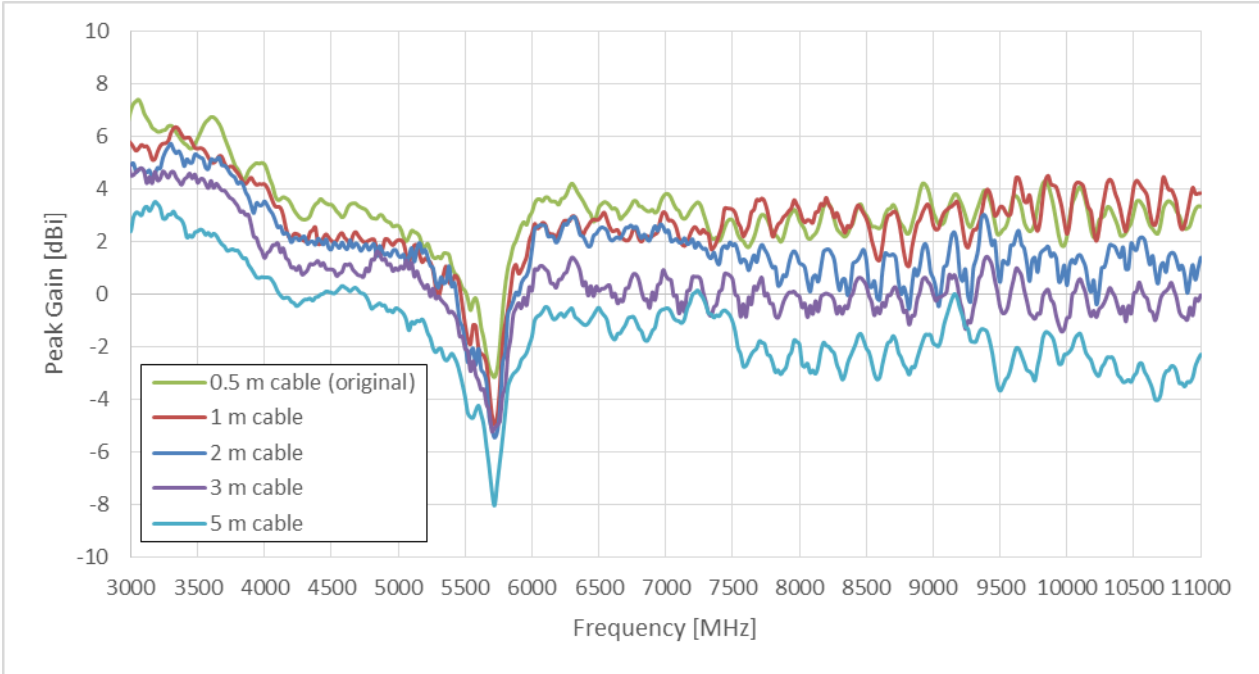

6.1.4. Average Gain

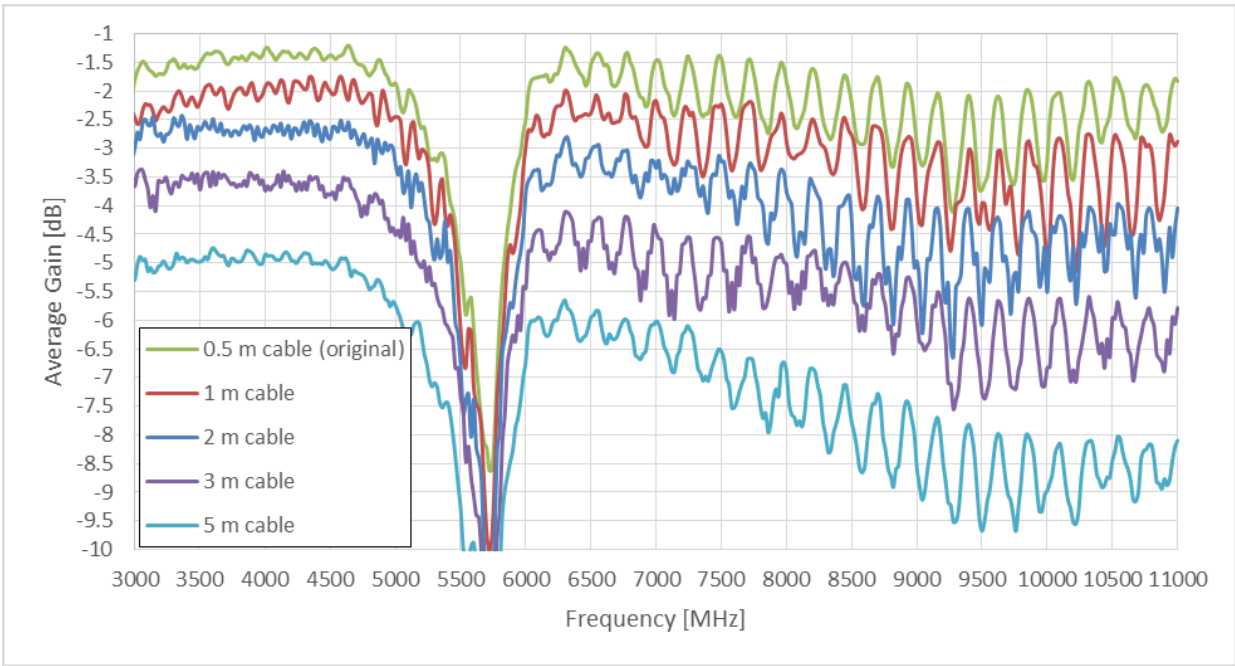

Taoglas makes no warranties based on the accuracy or completeness of the contents of this document and reserves the right to make changes to specifications and product descriptions at any time without notice.

Taoglas reserves the rights to this document and the information contained herein. Reproduction, use or disclosure to third parties without express permission is strictly prohibited.

Copyright © Taoglas Ltd.