

**Automotive Body
Power Management LSI Series**



LED Driver IC

rev. 0.34

BD8115F-M

●Description

The BD8115F is a serial parallel control LED driver with 35V input voltage rating. Responding to the 3-line serial data, it turns the 8ch open drain output on/off. Due to its compact size, it is optimal for small spaces.

●Features

- 1) Open Drain Output
- 2) 3-line Serial Control + Enable Signal
- 3) Internal Temperature Protection Circuit (TSD)
- 4) Cascade Connection Compatible
- 5) SOP16
- 6) Internal 8ch Power Transistor

●Applications

These ICs can be used with car and consumer electronic.

●Absolute Maximum Ratings (Ta=25°C)

Item	Symbol	Value	Unit
Power Supply Voltage	VCC	7	V
Output Voltage (Pin No : 3~6, 11~14)	VDmax	35	V
Input Voltage (Pin No : 2, 7, 8, 10, 15)	VIN	-0.3~VCC	V
Power Dissipation	Pd	560*	mW
Operating Temperature Range	Topr	-40~+105	°C
Storage Temperature Range	Tstg	-55~+150	°C
Drive Current (DC)	IomaxD	50	mA
Drive Current (Pulse)	IomaxP	150**	mA
Junction Temperature	Tjmax	150	°C

* Pd decreased at 4.48mW/°C for temperatures above Ta=25°C, mounted on 70×70×1.6mm Glass-epoxy PCB.

** Do not however exceed Pd. Time to impress ≤ 200msec

●Operational Conditions (Ta=-40~105°C)

Item	Symbol	Standard Value			Unit
		Min	Typ	Max	
Power Supply Voltage	Vcc	4.5	5	5.5	V
Drive Current	Io	-	20	40	mA

* This product is not designed for protection against radioactive rays.

●Electrical Characteristics (Unless specified, Ta=-40~105°C Vcc=4.5~5.5V)

Item	Symbol	Standard Value			Unit	Conditions
		Min	Typ	Max		
【Output D0~D7】 (Pin No : 3~6, 11~14)						
ON Resistor	RON	-	6	12	Ω	ID=20mA
Output leakage current	IDL	-	0	5	uA	Vb=34V
【Logic input】 (Pin No : 2, 7, 8, 10, 15)						
Upper limit threshold voltage	VTH	Vcc ×0.8	-	-	V	
Bottom limit threshold voltage	VTL	-	-	Vcc ×0.2	V	
Hysteresis width	VHYS	0.15	0.3	0.45	V	VCC=5V
Serial clock frequency	FCLK	-	-	1.25	MHz	
Input Current	IIN	20	50	100	uA	VIN=5V
Input leakage Current	IINL	-	0	5	uA	VIN=0V
【WHOLE】						
Circuit Current	ICC	-	0.3	5	mA	Serial Data Input, VCC=5V,CLK=500KHz, SEROUT=OPEN
Static Current	ISTN	-	0	50	uA	RST_B=OPEN, SEROUT=OPEN
【SER OUT】 (Pin No. : 9)						
Output Voltage high	VOH	4.6	4.8	-	V	VCC=5V, ISO=-4mA
Output voltage Low	VOL	-	0.2	0.4	V	VCC=5V, ISO=4mA

* This product is not designed for protection against radioactive rays.

●Electrical Characteristic Diagrams (Unless otherwise specified Ta=25°C)

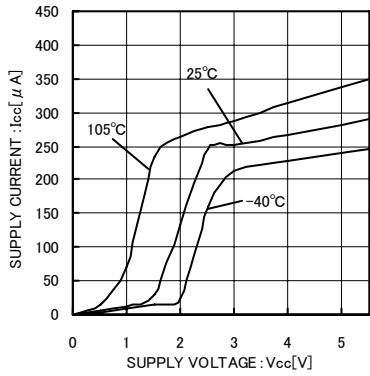

Fig.1 Circuit current (VCC characteristic)

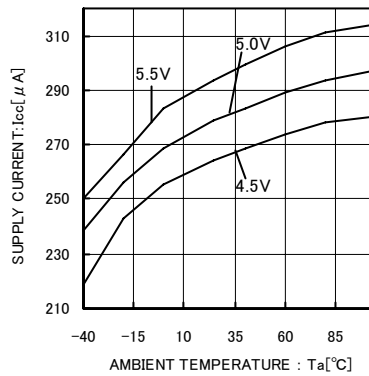

Fig.2 Circuit current (Temperature characteristic)

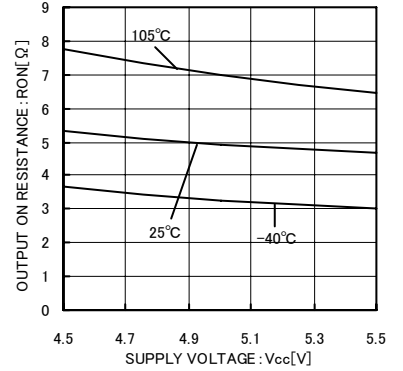

Fig.3 Output on resistance (VCC characteristic @ IDD=20mA)

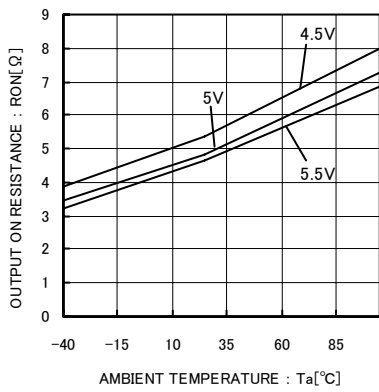

Fig.4 Output on resistance (Temperature characteristic @ IDD=20mA)

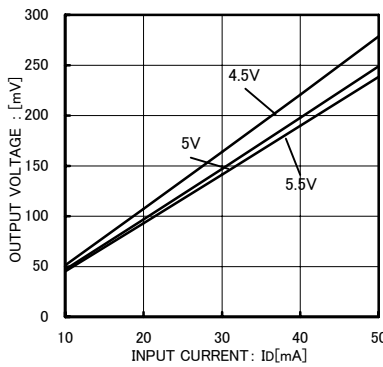

Fig.5 Output on resistance (IDD characteristic)

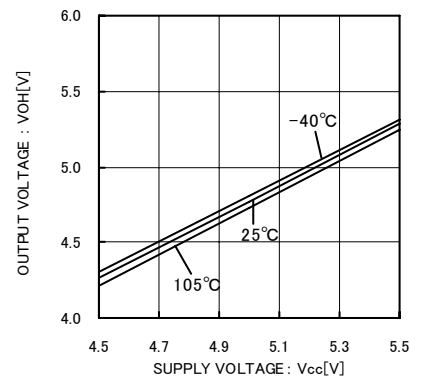

Fig.6 SEROUT high side voltage (VCC characteristic @ ISO=-5mA)

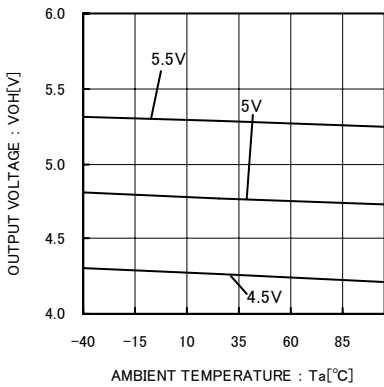

Fig.7 SEROUT high side voltage (Temperature characteristic @ ISO=-5mA)

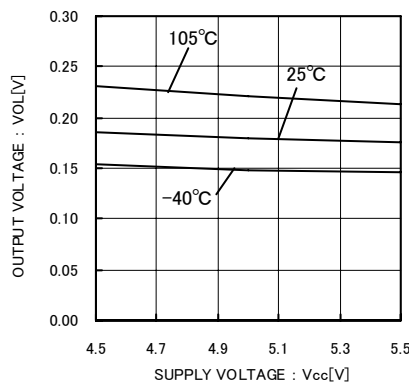

Fig.8 SEROUT low side voltage (VCC characteristic @ ISO=5mA)

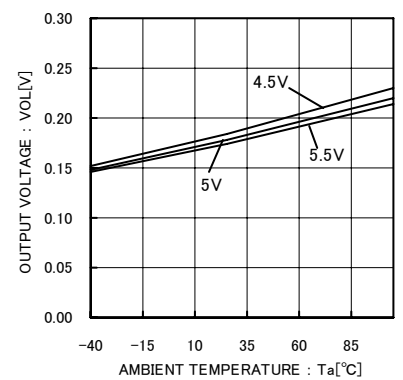

Fig.9 SEROUT low side voltage (Temperature characteristic @ ISO=4mA)

●Block Diagram

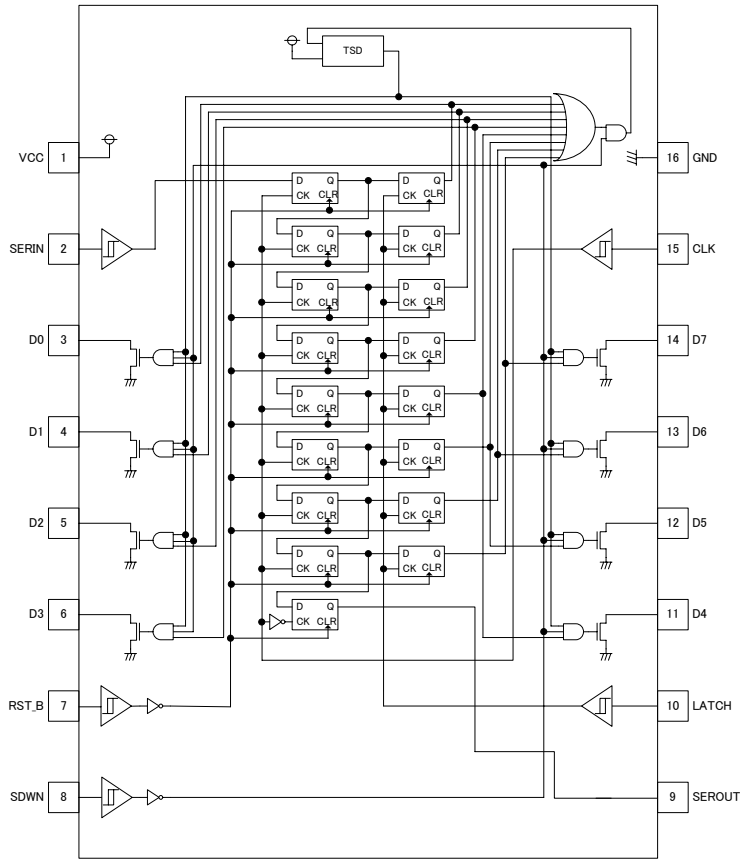

Fig.10

●Pin Setup Diagram
BD8115FV (SOP16)

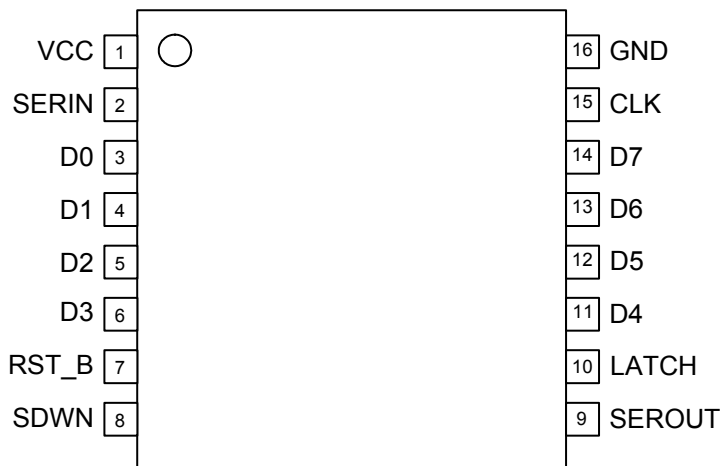

Fig.11

●Terminal Number - Terminal Name

Pin Number	Terminal Name	Function
1	VCC	Power supply voltage input terminal
2	SERIN	Serial data input terminal
3	D0	Drain output terminal 0
4	D1	Drain output terminal 1
5	D2	Drain output terminal 2
6	D3	Drain output terminal 3
7	RST_B	Reset return input terminal (L:FF data 0)
8	SDWN	Shut down input terminal (H: Output OFF)
9	SEROUT	Serial data output terminal
10	LATCH	Latch signal input terminal (H: Data latch)
11	D4	Drain output terminal 4
12	D5	Drain output terminal 5
13	D6	Drain output terminal 6
14	D7	Drain output terminal 7
15	CLK	Clock input terminal
16	GND	GND terminal

●Block Operation

1) Serial I/F

The I/F is a 3-line serial (LATCH, CLK, SERIN) style.

8-bit output ON/OFF can be set-up. This is composed of shift register. + 8-bit register.

2) Driver

It is a 8-bit open drain output.

3) TSD (Thermal Shut Down)

To prevent heat damage and overheating, when the chip temperature goes over approximately 175°C, the output turns off. When the temperature goes back down, normal operation resumes. However, the intended use of the temperature protection circuit is to protect the IC, so please construct thermal design with the junction temperature Tjmax under 150°C.

●Application Circuit

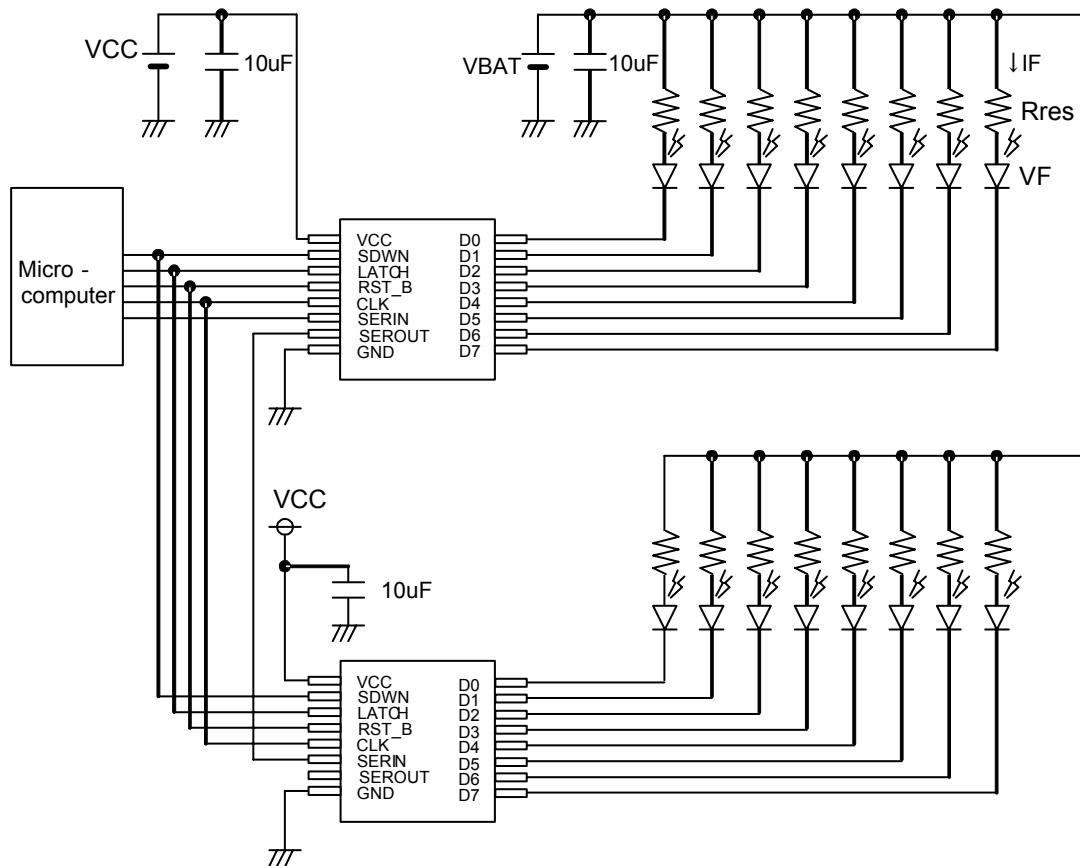

$$I_F = \frac{V_{BAT} - V_F}{R_{res} + R_{ON}}$$

Fig.12

●Serial Communication

The serial I/F is composed of a shift register which changes the CLK and SERIN serial signals to parallel signals, and a register to remember those signals with a LATCH signal. The registers are reset by applying a voltage under $VCC \times 0.2$ to the RST_B terminal or opening it, and D7~D0 become open. To prevent erroneous LED lighting, please apply voltage under $VCC \times 0.2$ to RST_B or make it open during start-up.

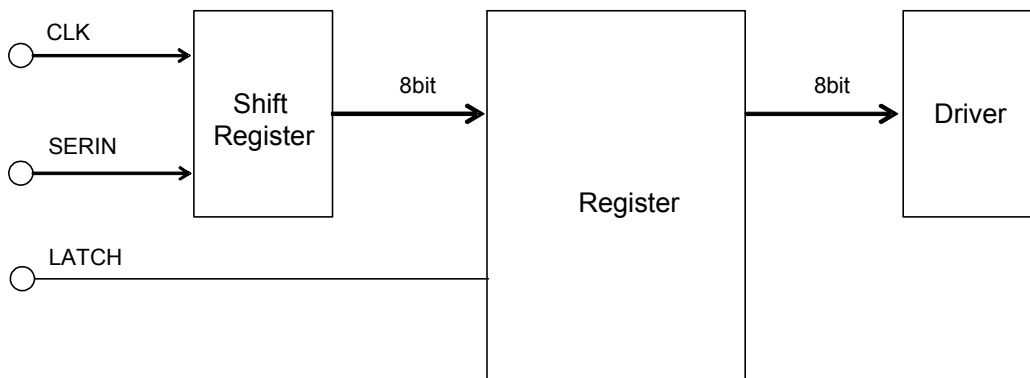

Fig.13

1) Serial Communication Timing

The 8-bit serial data input from SERIN is taken into the shift register by the rise edge of the CLK signal, and is recorded in the register by the rise edge of the LATCH signal. The recorded data is valid until the next rise edge of the LATCH signal.

2) Serial Communication Data

The serial data input configuration of SERIN terminal is shown below:

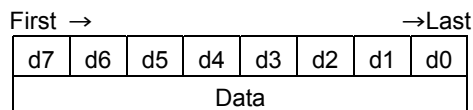

Terminal Name	Output Status	Data							
		d7	d6	d5	d4	d3	d2	d1	d0
D7	ON	1	*	*	*	*	*	*	*
	OFF	0	*	*	*	*	*	*	*
D6	ON	*	1	*	*	*	*	*	*
	OFF	*	0	*	*	*	*	*	*
D5	ON	*	*	1	*	*	*	*	*
	OFF	*	*	0	*	*	*	*	*
D4	ON	*	*	*	1	*	*	*	*
	OFF	*	*	*	0	*	*	*	*
D3	ON	*	*	*	*	1	*	*	*
	OFF	*	*	*	*	0	*	*	*
D2	ON	*	*	*	*	*	1	*	*
	OFF	*	*	*	*	*	0	*	*
D1	ON	*	*	*	*	*	*	1	*
	OFF	*	*	*	*	*	*	0	*
D0	ON	*	*	*	*	*	*	*	1
	OFF	*	*	*	*	*	*	*	0

* represents "Don't care".

3) Enable Signal

By applying voltage at least $VCC \times 0.8$ or more to the SDWN terminal, D0~D7 become open forcibly. At this time, the temperature protection circuit (TSD) stops. D7~D0 become PWM operation by inputting PWM to SDWN.

4) SEROUT

A cascade connection can be made (connecting at least 2 or more IC's in serial).

Serial signal input from SERIN is transferred into receiver IC by the fall edge of the CLK signal.

Since this functionality gives enough margins for the setup time prior to the rise edge of the CLK signal on the receiver IC (using the exact same CLK signal of sender IC), the application reliability can be improved as cascade connection functionality.

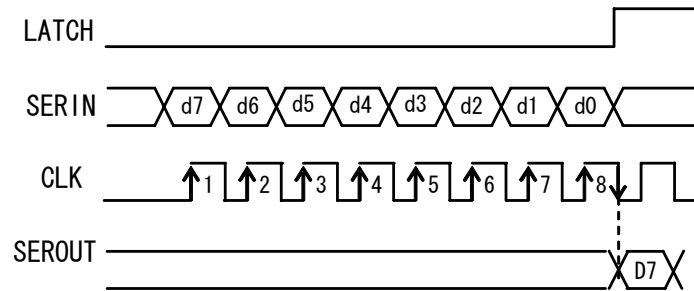

Fig.14

● Cascade Connection

By using (at least) 2 ICs, each IC's D7~D0, at (at least) 16ch, can be controlled by the 16-bit SERIN signal. The serial data input to the sender IC can be transferred to the receiver IC by inputting 8CLK to the CLK terminal.

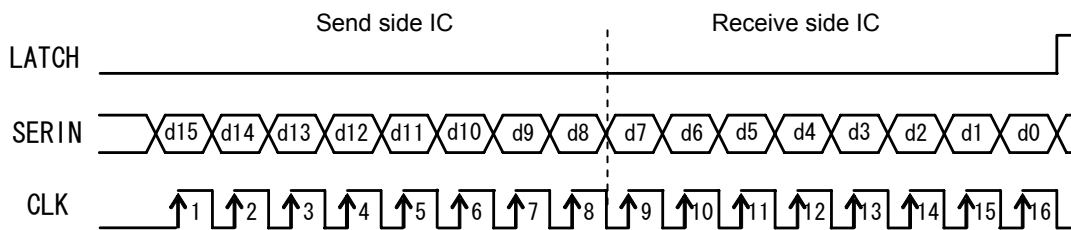

Fig.15

●INPUT SIGNAL'S TIMING CHART

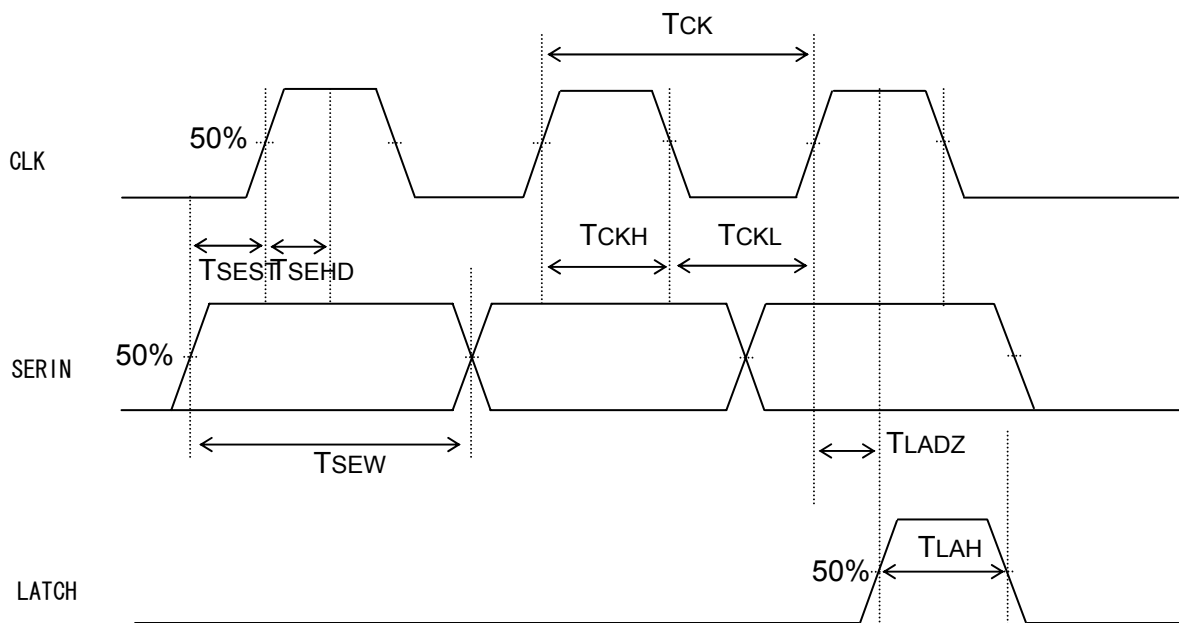

Fig.16

●INPUT SIGNAL'S TIMING RULE (Ta=-40~105°C Vcc=4.5~5.5V)

Parameter	Symbol	Min	Unit
CLK period	TCK	800	ns
CLK high pulse width	TCKH	380	ns
CLK low pulse width	TCKL	380	ns
SERIN high and low pulse width	TSEW	780	ns
SERIN setup time prior to CLK rise	TSEST	150	ns
SERIN hold time after CLK rise	TSEHD	150	ns
LATCH high pulse time	TLAH	380	ns
Last CLK rise to LATCH rise	TLADZ	200	ns

●OUTPUT SIGNAL'S DELAY CHART

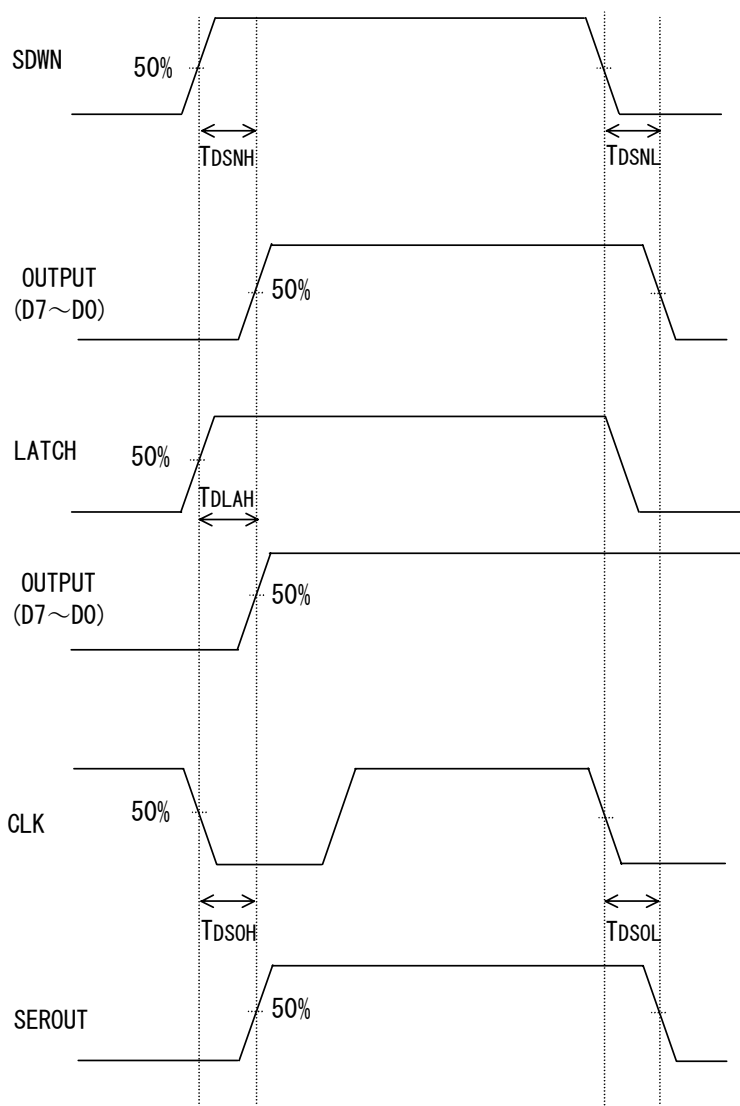

Fig.17

●OUTPUT SIGNAL'S DELAY TIME (Ta=-40~105°C Vcc=4.5~5.5V)

Parameter	Symbol	Max	Unit
SDWN Switching Time(L→H)	TDSNH	300	ns
SDWN Switching Time(H→L)	TDSNL	300	ns
LATCH Switching Delay Time	TDLAH	300	ns
SEROUT Propagation Delay Time(L→H)	TDSOH	350	ns
SEROUT Propagation Delay Time (H→L)	TDSOL	350	ns

● INPUT/OUTPUT EQUIVALENT CIRCUIT (PIN NAME)

<p>10PIN (LATCH) 7PIN (RST_B) 8PIN (SDWN) 2PIN (SERIN) 15PIN (CLK)</p>	<p>14PIN (D7), 13PIN (D6) 12PIN (D5), 11PIN (D4) 6PIN (D3), 5PIN (D2) 4PIN (D1), 3PIN (D0)</p>	<p>9PIN (SEROUT)</p>
		

Fig.18

● Operation Notes

(1) Absolute maximum ratings

Use of the IC in excess of absolute maximum ratings such as the applied voltage or operating temperature range may result in IC damage. Assumptions should not be made regarding the state of the IC (short mode or open mode) when such damage is suffered.

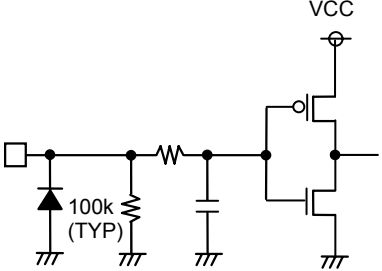
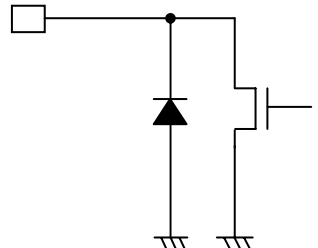
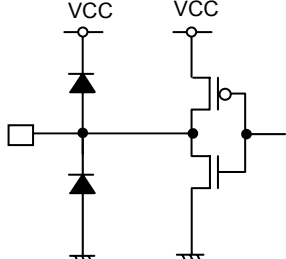
A physical safety measure such as a fuse should be implemented when use of the IC in a special mode where the absolute maximum ratings may be exceeded is anticipated.

(2) Reverse connection of a power supply connector

If the connector of power is wrong connected, it may result in IC breakage. In order to prevent the breakage from the wrong connection, the diode should be connected between external power and the power terminal of IC as protection solution.

(3) GND potential

Ensure a minimum GND pin potential in all operating conditions.

(4) Setting of heat

Use a setting of heat that allows for a sufficient margin in light of the power dissipation (Pd) in actual operating conditions.

(5) Pin short and mistake fitting

Use caution when orienting and positioning the IC for mounting on printed circuit boards. Improper mounting may result in damage to the IC. Use of the IC in excess of absolute maximum ratings such as the applied voltage or operating temperature range may result in IC damage.

(6) Actions in strong magnetic field

Use caution when using the IC in the presence of a strong electromagnetic field as doing so may cause the IC to malfunction.

(7) Thermal shutdown circuit(TSD)

This IC built-in a Thermal shutdown circuit (TSD circuit). If Chip temperature becomes 175°C (TYP.), make the output an Open state. Eventually, warmly clearing the circuit is decided by the condition of whether the heat excesses over the assigned limit, resulting the cutoff of the circuit of IC, and not by the purpose of preventing and ensuring the IC. Therefore, the warm switch-off should not be applied in the premise of continuous employing and operation after the circuit is switched on.

(8) Testing on application boards

When testing the IC on an application board, connecting a capacitor to a pin with low impedance subjects the IC to stress.

Always discharge capacitors after each process or step. Ground the IC during assembly steps as an antistatic measure, and use similar caution when transporting or storing the IC. Always turn the IC's power supply off before connecting it to or removing it from a jig or fixture during the inspection process

(9) IC terminal input

This monolithic IC contains P+ isolation and P substrate layers between adjacent elements in order to keep them isolated. P/N junctions are formed at the intersection of these P layers with the N layers of other elements to create a variety of parasitic elements.

For example, when a resistor and transistor are connected to pins. (See the chart below.)

○ the P/N junction functions as a parasitic diode when GND > (Pin A) for the resistor or GND > (Pin B) for the transistor (NPN).

○ Similarly, when GND > (Pin B) for the transistor (NPN), the parasitic diode described above combines with the N layer of other adjacent elements to operate as a parasitic NPN transistor.

The formation of parasitic elements as a result of the relationships of the potentials of different pins is an inevitable result of the IC's architecture. The operation of parasitic elements can cause interference with circuit operation as well as IC malfunction and damage. For these reasons, it is necessary to use caution so that the IC is not used in a way that will trigger the operation of parasitic elements, such as by the application of voltages lower than the GND (PCB) voltage to input pins.

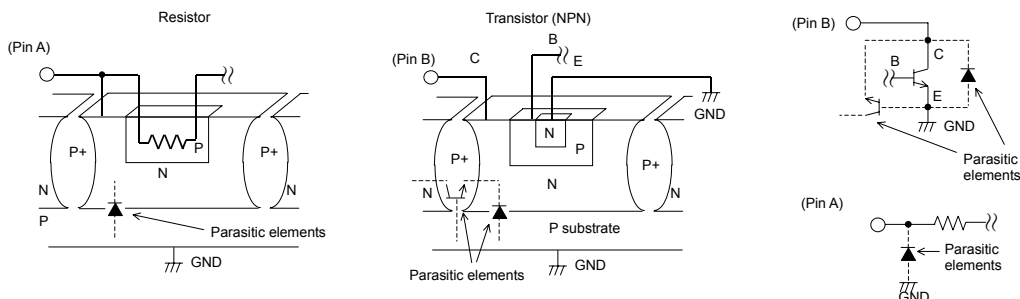

(10) Ground wiring patterns

When using both small signal and large current GND patterns, it is recommended to isolate the two ground patterns, placing a single ground point at the application's reference point so that the pattern wiring resistance and voltage variations caused by large currents do not cause variations in the small signal ground voltage. Be careful not to change the GND wiring patterns of any external components.

●Ordering part number

B	D
---	---

Part No.

8	1	1	5
---	---	---	---

Part No.

F	
---	--

Package
 F: SOP8
 FP: HSOP25
 HFP:HRP7

M	T	E	2
---	---	---	---

Packaging and forming specification
 E2: Embossed tape and reel
 (SOP8/HSOP25)
 TR: Embossed tape and reel
 (HRP7)
 None:Tray,Tube

SOP16

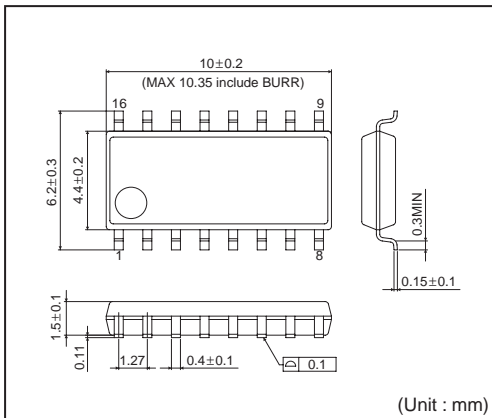

<Tape and Reel information>

Tape	Embossed carrier tape
Quantity	2500pcs
Direction of feed	E2 (The direction is the 1pin of product is at the upper left when you hold reel on the left hand and you pull out the tape on the right hand)

