

Main Product Characteristics

BV_{DSS}	-60V
$R_{DS(ON)}$	4.6m Ω
I_D	-140A

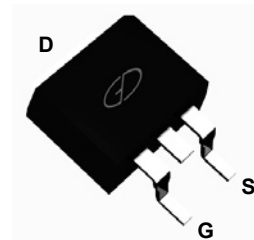

TO-263 (D²PAK)

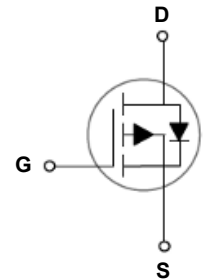

Schematic Diagram

Features and Benefits

- Advanced MOSFET process technology
- Ideal for high efficiency switched mode power supplies
- Low on-resistance with low gate charge
- Fast switching and reverse body recovery



Description

The GSFT06131 utilizes the latest techniques to achieve high cell density and low on-resistance. These features make this device extremely efficient and reliable for use in high efficiency switch mode power supply and a wide variety of other applications.

Absolute Maximum Ratings ($T_C=25^\circ\text{C}$ unless otherwise specified)

Parameter	Symbol	Max.	Unit
Drain-Source Voltage	V_{DS}	-60	V
Gate-Source Voltage	V_{GS}	± 20	V
Drain Current-Continuous ($T_C=25^\circ\text{C}$)	I_D	-140	A
Drain Current-Continuous ($T_C=100^\circ\text{C}$)		-88	
Drain Current-Pulsed ¹	I_{DM}	-560	A
Single Pulse Avalanche Energy ²	E_{AS}	720	mJ
Single Pulse Avalanche Current ²	I_{AS}	-120	A
Power Dissipation ($T_C=25^\circ\text{C}$)	P_D	183	W
Power Dissipation-Derate above 25 $^\circ\text{C}$		1.47	
Thermal Resistance, Junction-to-Ambient	$R_{\theta JA}$	62	$^\circ\text{C}/\text{W}$
Thermal Resistance, Junction-to-Case	$R_{\theta JC}$	0.68	$^\circ\text{C}/\text{W}$
Operating Junction Temperature Range	T_J	-55 To +150	$^\circ\text{C}$
Storage Temperature Range	T_{STG}	-55 To +150	$^\circ\text{C}$

Electrical Characteristics ($T_J=25^{\circ}\text{C}$ unless otherwise specified)

Parameter	Symbol	Conditions	Min.	Typ.	Max.	Unit
On / Off Characteristics						
Drain-Source Breakdown Voltage	BV_{DSS}	$V_{GS}=0V, I_D=-250\mu A$	-60	-	-	V
BV_{DSS} Temperature Coefficient	$\Delta BV_{DSS}/\Delta T_J$	Reference to 25°C , $I_D=1mA$	-	0.036	-	$V/^{\circ}\text{C}$
Drain-Source Leakage Current	I_{DSS}	$V_{DS}=-60V, V_{GS}=0V,$ $T_J=25^{\circ}\text{C}$	-	-	-1	μA
		$V_{DS}=-48V, V_{GS}=0V,$ $T_J=125^{\circ}\text{C}$	-	-	-10	μA
Gate-Source Leakage Current	I_{GSS}	$V_{GS}=\pm 20V, V_{DS}=0V$	-	-	± 100	nA
Static Drain-Source On-Resistance	$R_{DS(ON)}$	$V_{GS}=-10V, I_D=-50A$	-	3.8	4.6	m Ω
		$V_{GS}=-4.5V, I_D=-25A$	-	5	6	
Gate Threshold Voltage	$V_{GS(th)}$	$V_{GS}=V_{DS}, I_D=-250\mu A$	-1.2	-1.6	-2.5	V
$V_{GS(th)}$ Temperature Coefficient	$\Delta V_{GS(th)}$		-	-6.3	-	mV/ $^{\circ}\text{C}$
Forward Transconductance	g_{fs}	$V_{DS}=-10V, I_D=-3A$	-	18	-	S
Dynamic and Switching Characteristics						
Total Gate Charge ^{3,4}	Q_g	$V_{DS}=-48V, I_D=-5A$ $V_{GS}=-10V$	-	280	420	nC
Gate-Source Charge ^{3,4}	Q_{gs}		-	35	53	
Gate-Drain Charge ^{3,4}	Q_{gd}		-	60	90	
Turn-On Delay Time ^{3,4}	$t_{d(on)}$	$V_{DD}=-48V, R_G=6\Omega$ $V_{GS}=-10V, I_D=-1A$	-	87.5	131	nS
Rise Time ^{3,4}	t_r		-	256	380	
Turn-Off Delay Time ^{3,4}	$t_{d(off)}$		-	503	750	
Fall Time ^{3,4}	t_f		-	245	368	
Input Capacitance	C_{iss}	$V_{DS}=-25V, V_{GS}=0V,$ $F=1MHz$	-	16000	24000	pF
Output Capacitance	C_{oss}		-	920	1440	
Reverse Transfer Capacitance	C_{rss}		-	760	1150	
Drain-Source Diode Characteristics and Maximum Ratings						
Continuous Source Current	I_S	$V_G=V_D=0V,$ Force Current	-	-	-140	A
Pulsed Source Current	I_{SM}		-	-	-280	A
Diode Forward Voltage	V_{SD}	$V_{GS}=0V, I_S=-1A,$ $T_J=25^{\circ}\text{C}$	-	-	1	V
Reverse Recovery Time	t_{rr}	$V_R=-50V, I_S=-10A,$ $di/dt=100A/\mu s,$ $T_J=25^{\circ}\text{C}$	-	75	-	nS
Reverse Recovery Charge	Q_{rr}		-	110	-	nC

Note:

1. Repetitive rating: Pulsed width limited by maximum junction temperature.
2. $V_{DD}=-25V, V_{GS}=-10V, L=0.1mH, I_{AS}=-120A, R_G=25\Omega,$ starting $T_J=25^{\circ}\text{C}$.
3. Pulse test: pulse width $\leq 300\mu s,$ duty cycle $\leq 2\%$.
4. Essentially independent of operating temperature.

Typical Electrical and Thermal Characteristic Curves

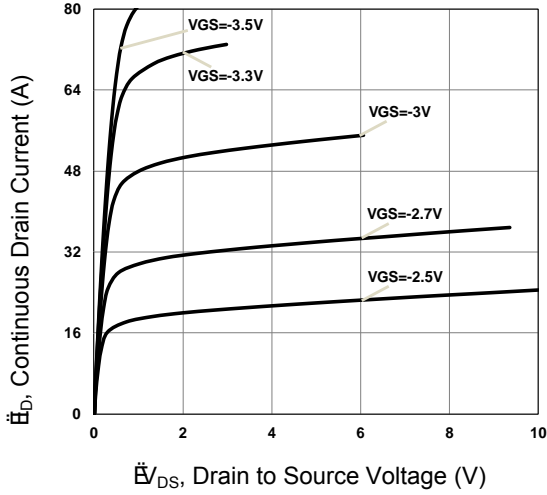

Figure 1. Typical Output Characteristics

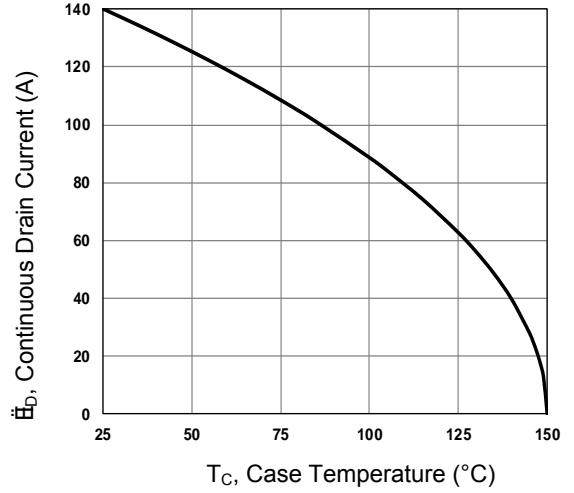

Figure 2. Continuous Drain Current vs. T_c

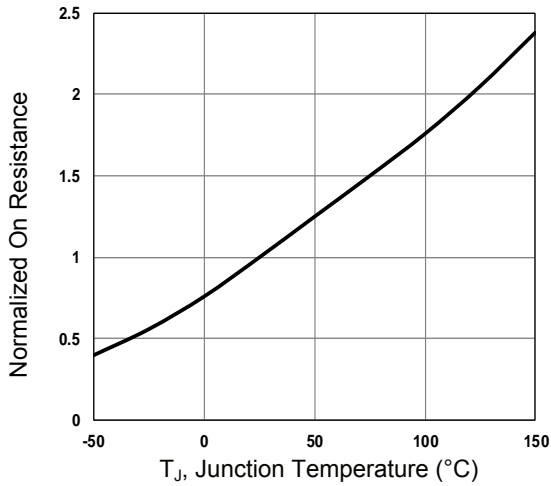

Figure 3. Normalized R_{DSON} vs. T_J

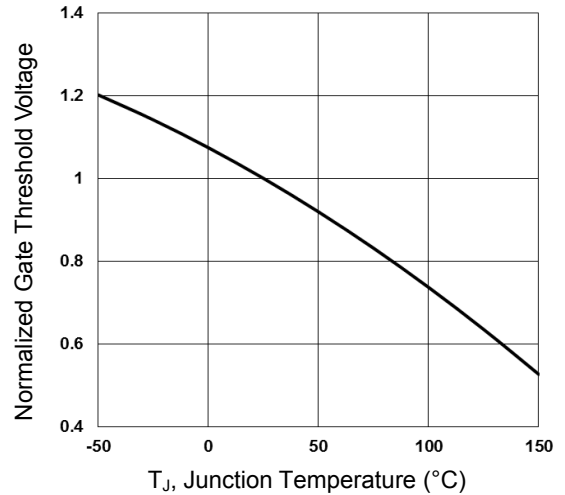

Figure 4. Normalized V_{th} vs. T_J

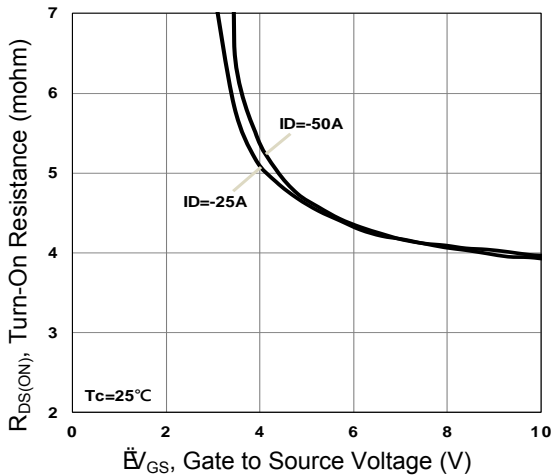

Figure 5. Turn-On Resistance vs. V_{GS}

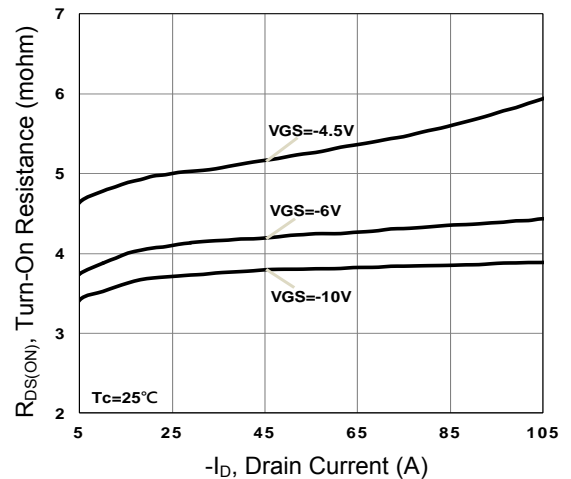

Figure 6. Turn-On Resistance vs. I_D

Typical Electrical and Thermal Characteristic Curves

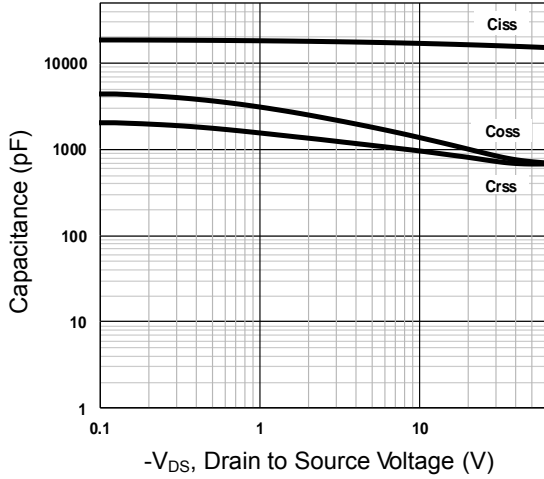

Figure 7. Capacitance Characteristics

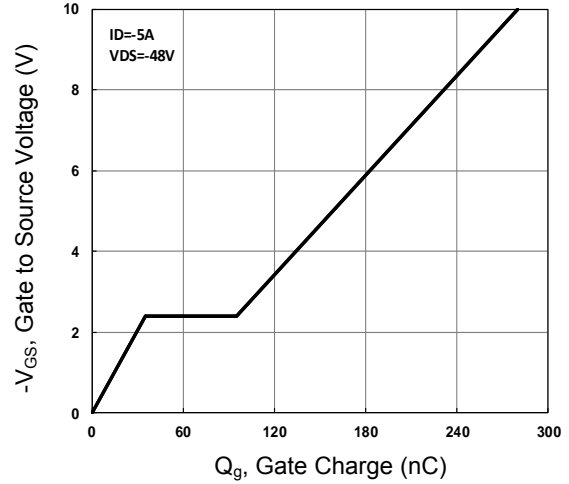

Figure 8. Gate Charge Characteristics

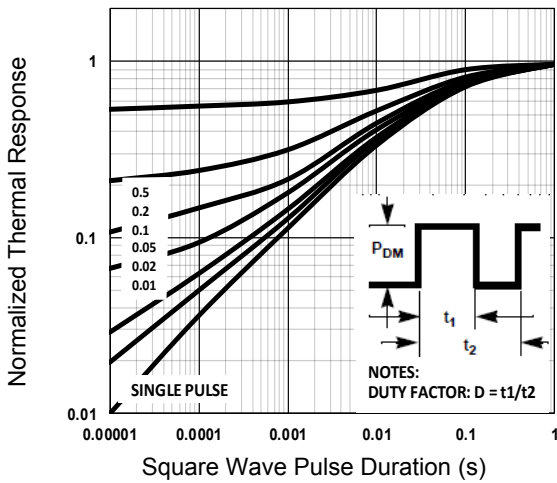

Figure 9. Normalized Transient Impedance

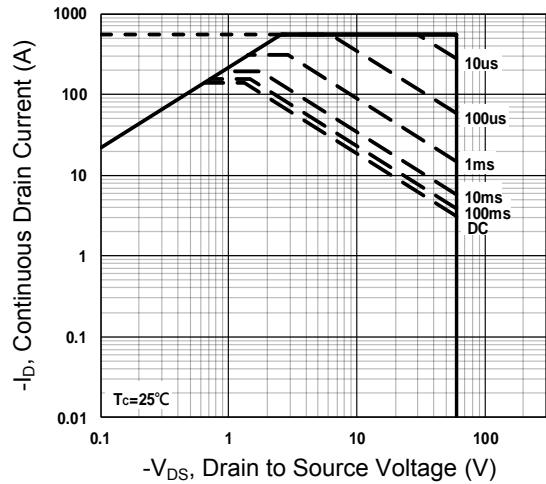

Figure 10. Maximum Safe Operation Area

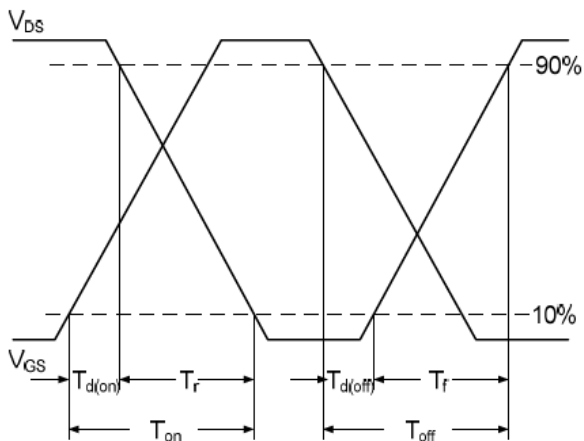

Figure 11. Switching Time Waveform

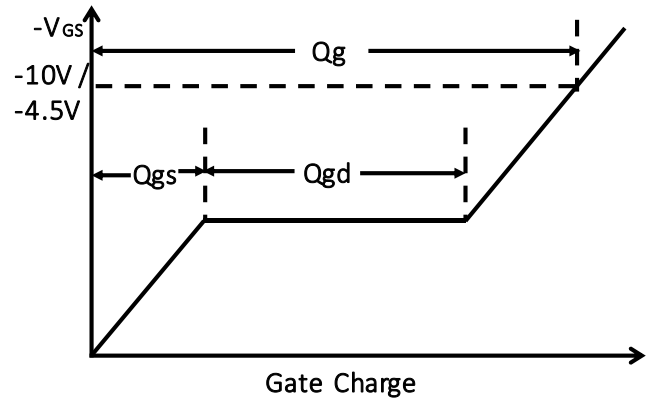
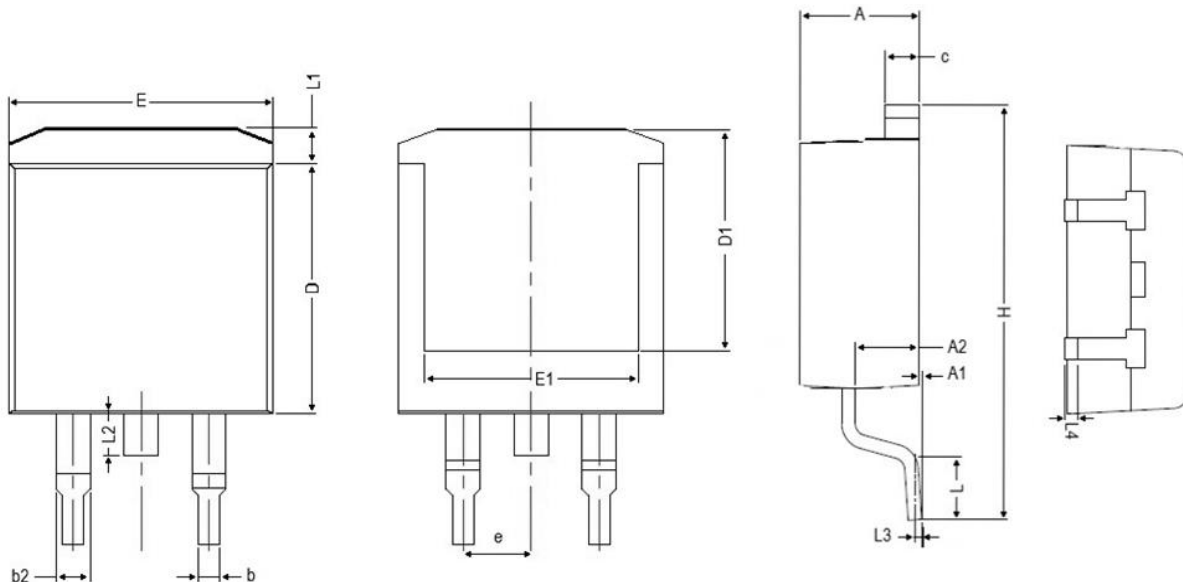

Figure 12. Gate Charge Waveform

Package Outline Dimensions TO-263 (D²PAK)



Symbol	Dimensions in Millimeters		Dimensions in Inches	
	Max	Min	Max	Min
A	4.850	4.200	0.191	0.165
A1	0.300	0.000	0.012	0.000
A2	2.900	2.200	0.114	0.087
b	0.950	0.700	0.037	0.028
b2	1.700	1.000	0.067	0.039
c	1.450	1.150	0.057	0.045
D	9.500	8.350	0.374	0.329
D1	9.150	6.400	0.360	0.252
E	10.500	9.600	0.413	0.378
E1	8.900	6.850	0.350	0.270
e	2.540 BSC		0.100 BSC	
H	15.900	14.600	0.626	0.575
L	2.800	1.700	0.110	0.067
L1	1.700	1.050	0.067	0.041
L2	2.100	1.300	0.083	0.051
L3	0.250 BSC		0.010 BSC	
L4	0.750	0.200	0.03	0.008