

## Features:

- 31 dB Gain
- 33 dBm P<sub>-1dB</sub>
- OIP3 45 dBm
- 25.0 dBm Linear Pout @ 2.5% EVM (802.11 64QAM)
- Fully Matched Input and Output for Easy Cascade
- Internal Bias Tee
- Surface Mount, RoHS Compliant QFN 5x5mm Package

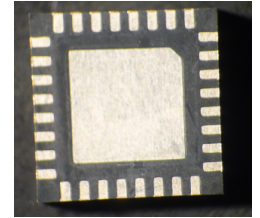
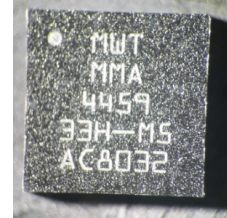

## Description:

The MMA-445933H-M5 is a power amplifier with the State-of-the-Art linear power between 4.4 GHz and 5.9 GHz frequency band. Based on advanced robust HFET device technology, the linearity of this power amplifier is 25 dBm linear power at 2.5% EVM and achieves an ACPR better than -36 dBc. The modulation test pattern is 802.16x 64QAM. This linear power amplifier also has high gain. Ideal applications include the driver and the output power stage of WiMax and WLAN infrastructures and access points. It also can be used for PTP (Point-To-Point) radio applications for this band.

**Typical RF Performance:**  $Vd1=7.5V$ ,  $Vd2=7.5V$ ,  $Vg1=-0.8V$ ,  $Vg2=-0.8V$ ,  $Idq1=410mA$   
 $Idq2=622mA$ ,  $Ta=25\text{ }^{\circ}C$ ,  $Z0=50\text{ ohm}$

Parameter	Units	Typical Data
Frequency Range	MHz	4400-5900
Gain (Typ)	dB	31
Gain Flatness (Typ)	+/-dB	2.5
Input Return Loss (Typ)	dB	10
Output Return Loss (Typ)	dB	10
Output P1dB (Typ)	dBm	33
OIP3 (Typ)	dBm	45
Pout @ 2.5% EVM (Typ)	dBm	25.0
Operating Current Range	mA	1050
Thermal Resistance (Driver Stage)	$^{\circ}C/W$	20
Thermal Resistance (Output Stage)	$^{\circ}C/W$	16

**Typical RF Performance:**  $Vd1=7.5V$ ,  $Vd2=7.5V$ ,  $Vg1=-0.8$ ,  $Vg2=-0.8V$ ,  $Idq1=410mA$ ,  
 $Idq2=620mA$ ,  $Z0=50\ ohm$ ,  $Ta=25\ ^\circ C$

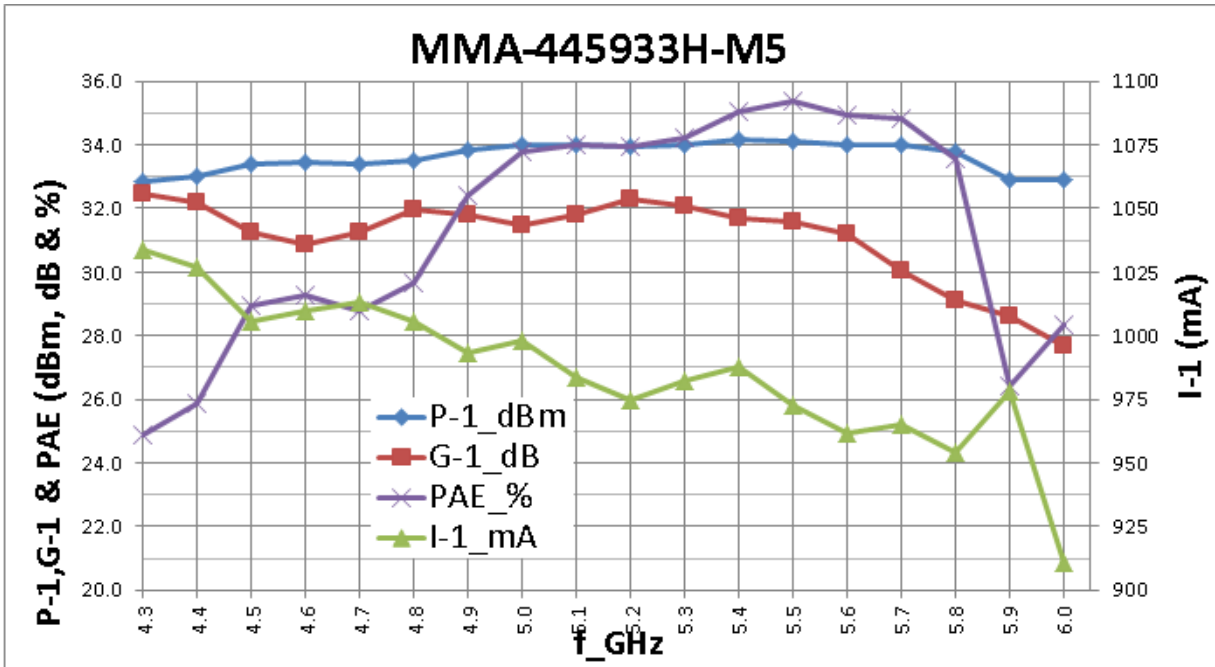

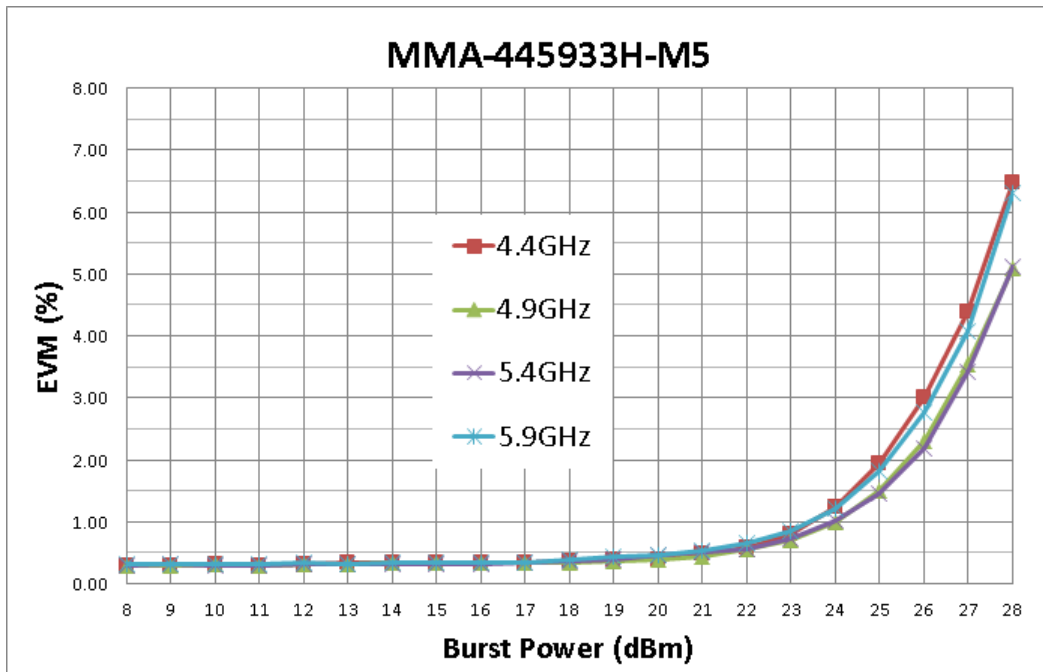

### Maximum Ratings: (Ta= 25 °C)\*

SYMBOL	PARAMETERS	UNITS	ABSOLUTE MAXIMUM
Vdd1	Drain-Source Voltage Driver Stage	V	10
Vdd2	Drain-Source Voltage Output Stage	V	10
Vgg1	Gate-Source Voltage Driver Stage	V	-5
Vgg2	Gate-Source Voltage Output Stage	V	-5
Idq1	Drain Current Driver Stage	mA	500
Idq2	Drain Current Output Stage	mA	750
Ig1 and Ig2	Gate Current	mA	10
Ip	Pinch-Off Current	mA	10
Pdiss	DC Power Dissipation	W	9.0
Pin max	RF Input Power	dBm	+10
Toper	Operating Temperature	°C	-40 to +85
Tch	Channel Temperature	°C	175
Tstg	Storage Temperature	°C	-55 to 150

\*Operation of this device above any one of these parameters may cause permanent damage.

## Small Signal Gain and S-Parameters

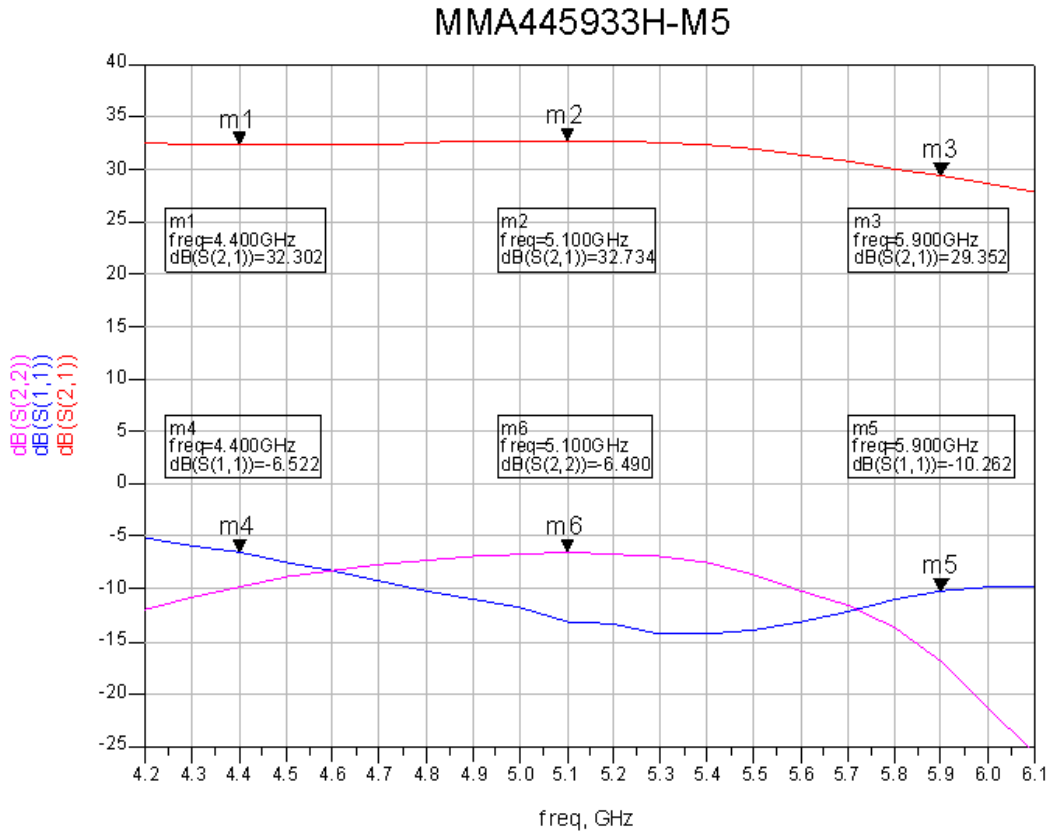

**S11, S22, S21**

## Mechanical Information:

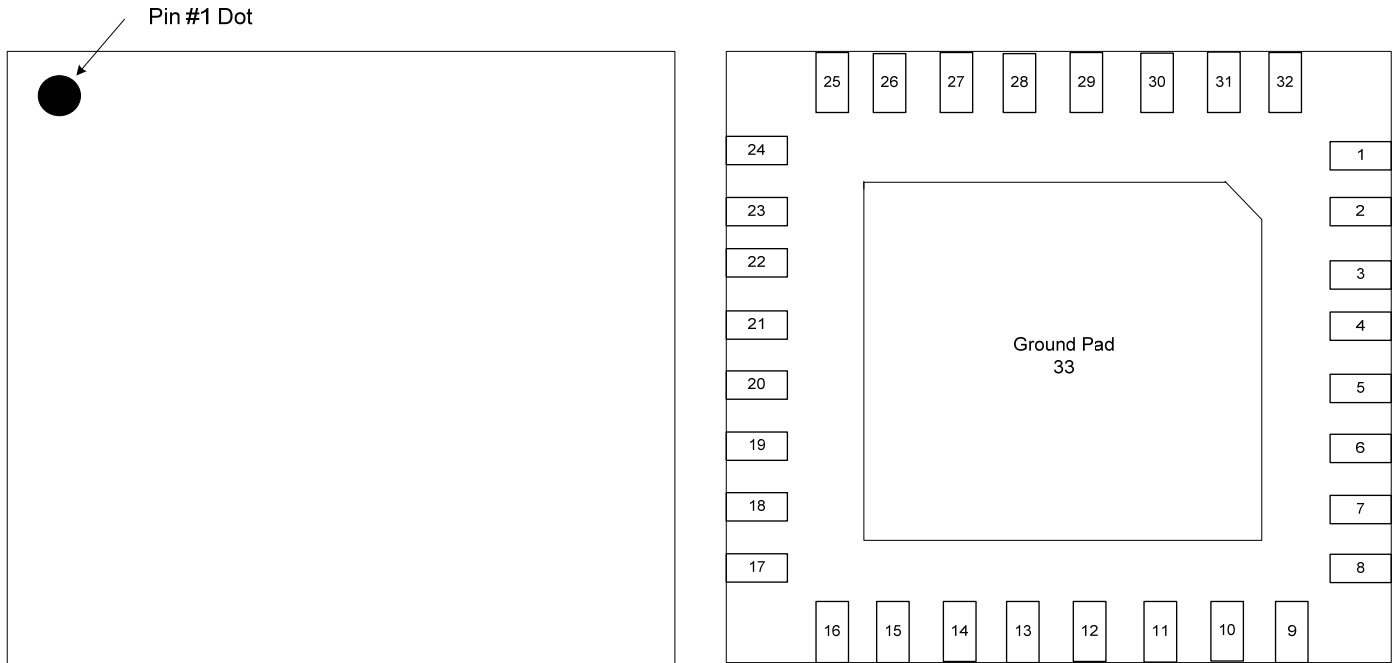

## Pin Configurations:

Pin	Descriptions
4,5	<u>RFin</u>
20,21	<u>RFout</u>
30,29	Vgs1a,Vgs1b
27	Vgs2
11,12	Vds1a,Vds1b
14	Vds2
1,2,32,7,8,9,16,17,18,23,24,25	GND
3,6,10,13,15,19,22,26,28,31	No connection

## Mechanical Information:

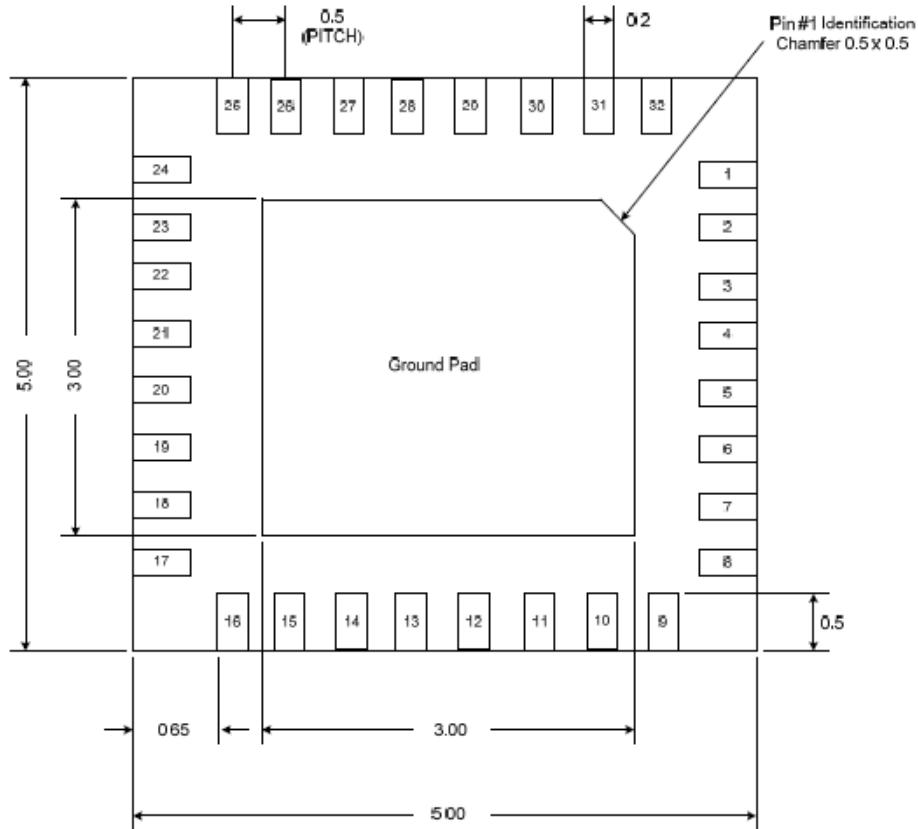

BOTTOM VIEW

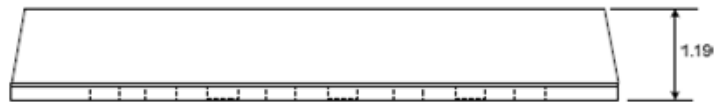

SIDE VIEW

The units are in [mm].

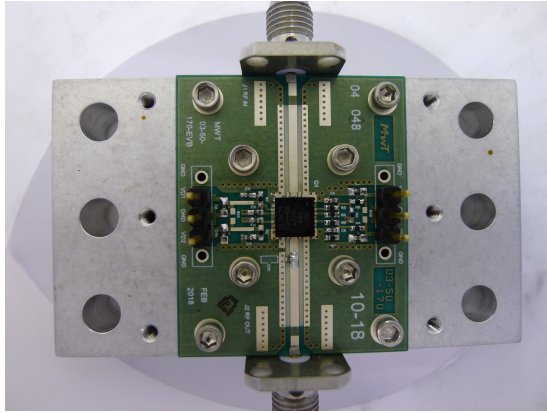

**Figure 1 Evaluation board**

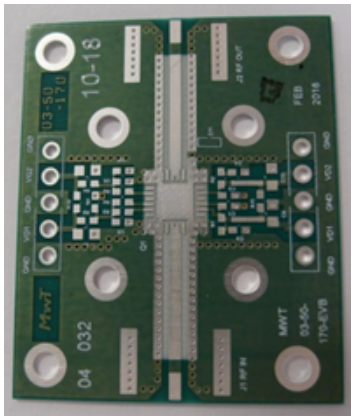

**Figure 2 Hole Layout**

## Application Note

The evaluation board, shown in Figure 1, is fabricated with Rogers's 4003 material, 20 mil thick, 2 oz copper weight and includes four DC input connections and two RF lines. The MMA-445933H-M5 shown in the center of board is a 2 watt high gain and high linearity amplifier. The MMA-445933H-M5 is a 3 stage amplifier assembly die attach to the modified '02' package which includes four bias entries and two RF connections. The bias tees are built-in to the package. Small value bypassing capacitors are included with assembly. Proper bypassing is still required on the DC lines. The amplifier operates over a temperature range of approximately 85°C.

The PCB requires via holes with a diameter of 20 mils placed uniformly over the center pad for thermal relief and RF ground as shown in Figure 2. The via holes can be back filled with conductive epoxy for best thermal performance.

## Diagram:

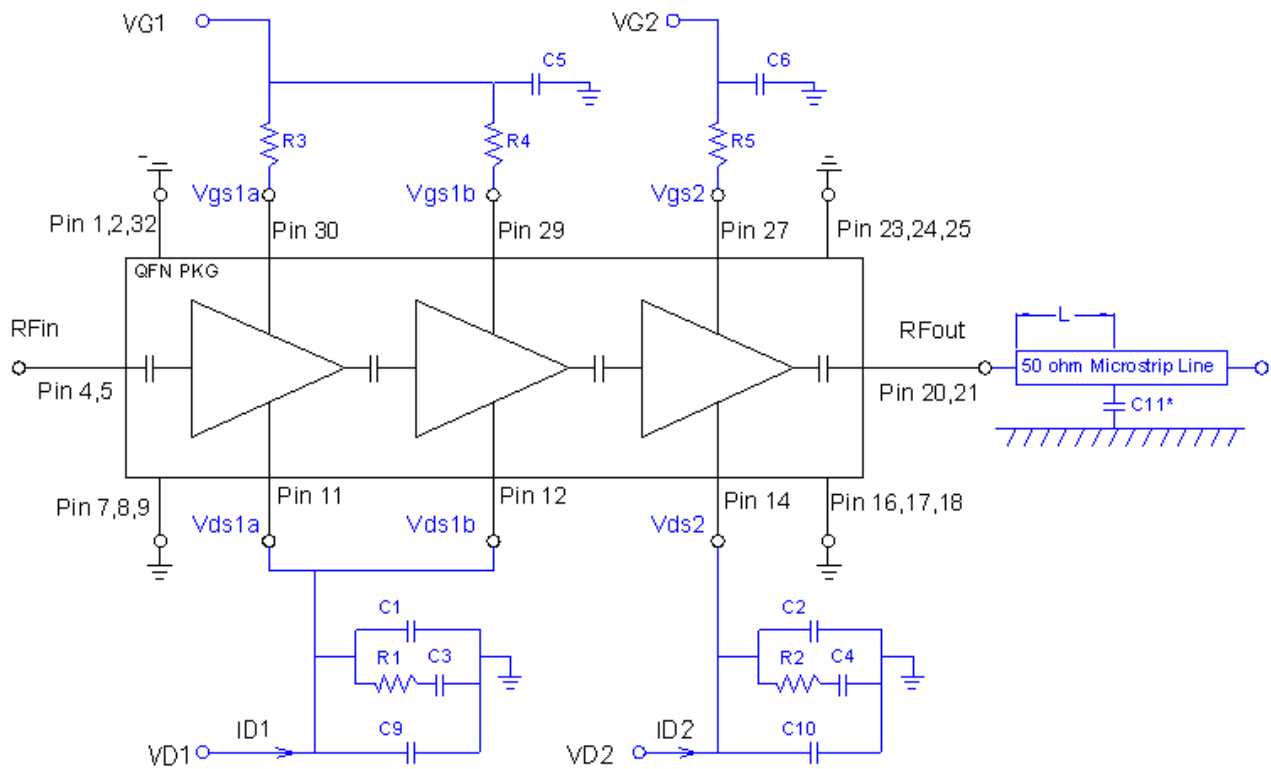

Components	Value
R1,R2	50 ohm
R3,R4	39 ohm
R5	22 ohm
C1,C2	100~1000 pF
C3,C4,C5,C6	0.1 uF
C9,C10	>0.1 uF
C11* (Option for better VSWR)	0.15 - 0.2 pF, Distance = L
	$L = \frac{0.203}{\sqrt{\epsilon_e}} \text{ (inch)}$

$\epsilon_e$  is the effective dielectric constant of the 50 ohm micro-strip transmission line of the PCB circuit. For example, this length will be 0.1215 inch from the package edge to the capacitor center for 50 ohm line with Rogers RO 4003C substrate (Line width will be 0.042 inch for