

VERONICA-SQ-MINI-M

~35° medium beam

TECHNICAL SPECIFICATIONS:

Dimensions	13.9 mm
Height	8.9 mm
Fastening	tape, pin
Colour	clear
Box size	480 x 280 x 300 mm
Box weight	9.4 kg
Quantity in Box	5544 pcs
ROHS compliant	yes 



MATERIAL SPECIFICATIONS:

Component	Type	Material	Colour
VERONICA-SQ-MINI-M	Single lens	PMMA	clear
VERONICA-SQ-MINI-TAPE	Tape	Acrylic foam	clear

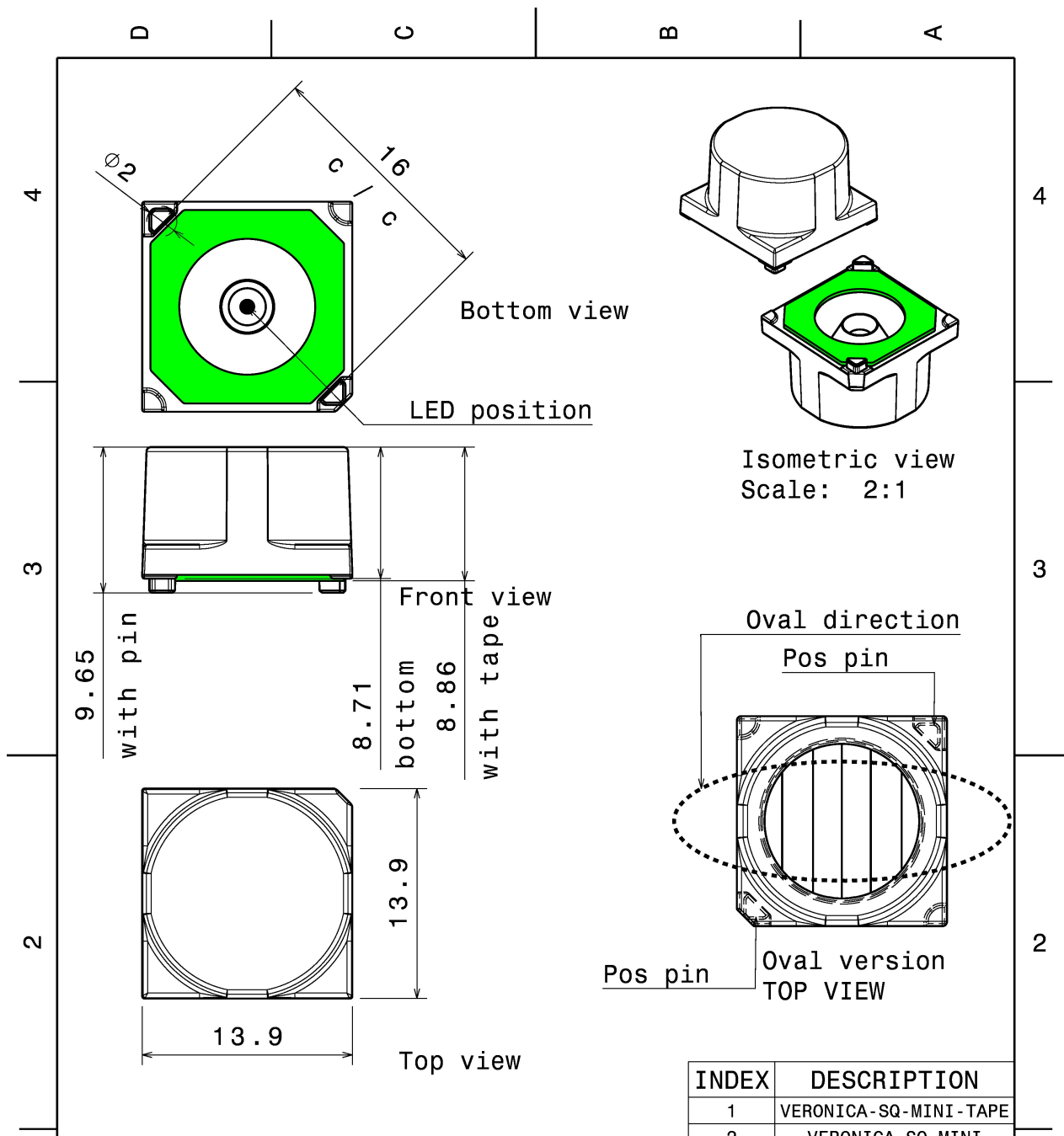

Tolerances if not otherwise shown
 According to DIN ISO 2768-1
 Linear measures:
 up to 30mm class M, otherwise class C
 According to DIN ISO 2768-2
 Form and position: class L

LEDiL Ledil Oy
 Joensuunkatu 13
 FIN 24100 SALO
 Finland

THIRD ANGLE PROJECTION:

DRAWING TITLE
VERONICA-SQ-MINI

This drawing is the property of LEDiL Oy. It may not be reproduced, copied or communicated without a written agreement with LEDiL Oy.

SIZE	PART NUMBER
A4	-

SCALE	3:1	WEIGHT		SHEET	1/1
-------	-----	--------	--	-------	-----

PHOTOMETRIC DATA (MEASURED):



LED XP-G2
 FWHM 34.0°
 Efficiency 89 %
 Peak intensity cd/lm
 LEDs/each optic 1
 Light colour White
 Required components:

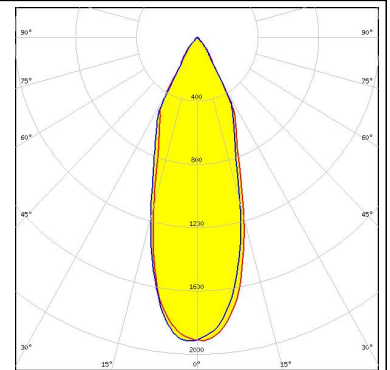
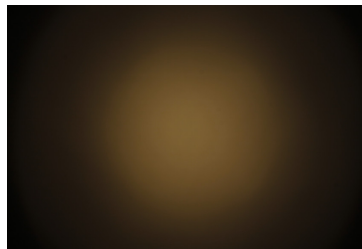

LED NCSxE17A
 FWHM 23.0°
 Efficiency 93 %
 Peak intensity 2.800 cd/lm
 LEDs/each optic 1
 Light colour White
 Required components:

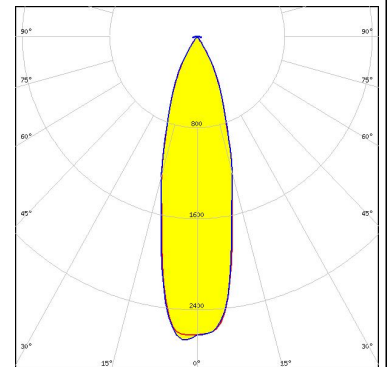
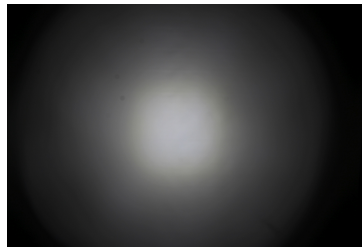

LED LH181A
 FWHM 27.0°
 Efficiency 88 %
 Peak intensity 2.000 cd/lm
 LEDs/each optic 1
 Light colour White
 Required components:

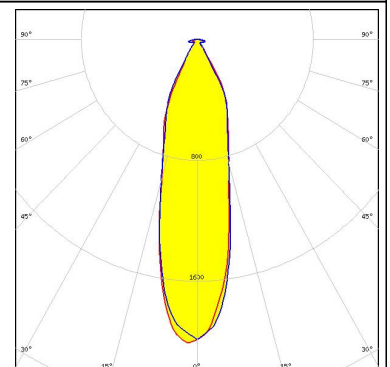
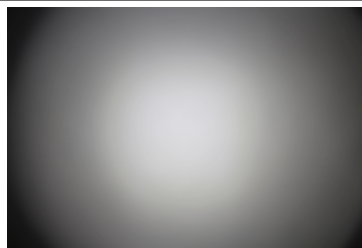

LED LH181B
 FWHM 29.0°
 Efficiency 93 %
 Peak intensity 2.200 cd/lm
 LEDs/each optic 1
 Light colour White
 Required components:

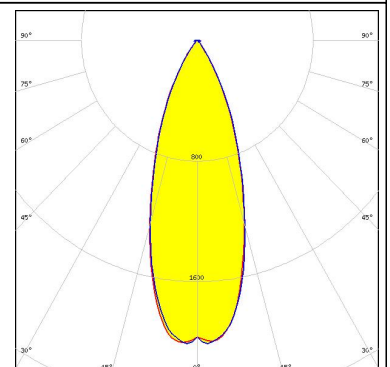
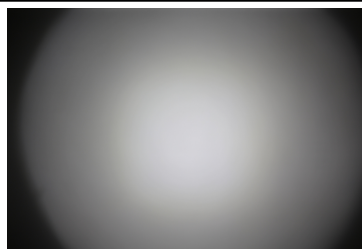

PHOTOMETRIC DATA (MEASURED):



PHOTOMETRIC DATA (SIMULATED):



LED LUXEON Z ES
FWHM 25.0°
Efficiency 94 %
Peak intensity 3.000 cd/lm
LEDs/each optic 1
Light colour White
Required components:

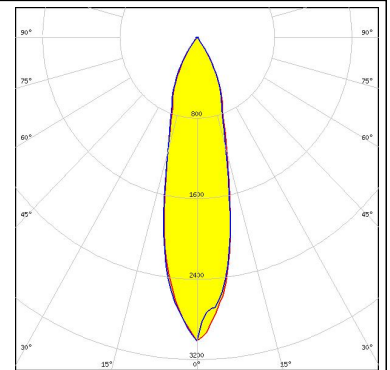

LED NVSxE21A
FWHM 32.0°
Efficiency 94 %
Peak intensity 2.300 cd/lm
LEDs/each optic 1
Light colour White
Required components:

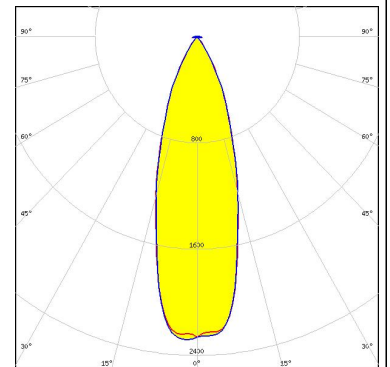

Opto Semiconductors

LED OSOLON Square CSSRM2/CSSRM3
FWHM 31.0°
Efficiency 97 %
Peak intensity 2.037 cd/lm
LEDs/each optic 1
Light colour White
Required components:

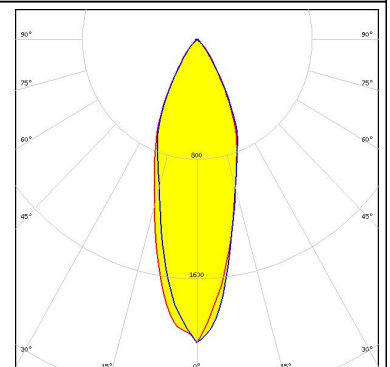

Opto Semiconductors

LED OSOLON SSL 80
FWHM 28.0°
Efficiency 94 %
Peak intensity 3.100 cd/lm
LEDs/each optic 1
Light colour White
Required components:

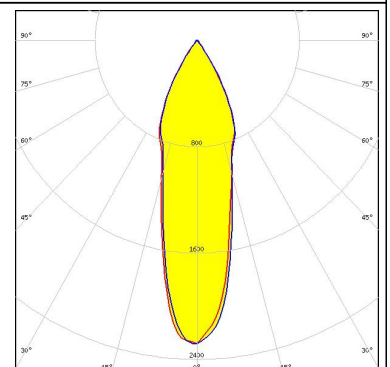

PHOTOMETRIC DATA (SIMULATED):

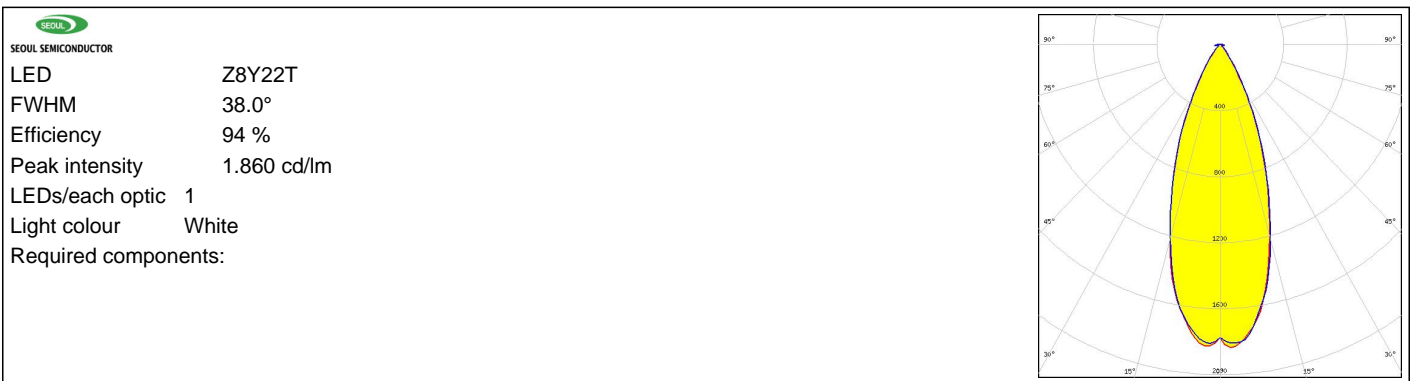

GENERAL INFORMATION:

NOTE: The typical beam angle will be changed by different color, chip size and chip position tolerance. The typical total beam angle is the full angle measured where the luminous intensity is half of the peak value.

MATERIALS:

As part of our continuous research and improvement processes, and to ensure the best possible quality and availability of our products, LEDiL reserves the right to change material grades without notice.

PRODUCT DATA USER AGREEMENT AND DISCLAIMER:

The measured data in the provided downloadable LEDiL Product Datasheets and Mechanical 2D-Drawings is rounded and provided as reference for planning. LEDiL Oy's optical specifications have been verified by conducting performance testing of the products in accordance with the company's quality system. The reported data are averaged results of multiple measurements with typical variation. LEDiL Oy reserves the right to without prior notification make changes and improvements to its products.

LEDiL Oy assumes neither warranty, nor guarantee nor any other liability of any kind for the contents and correctness of the provided data. The provided data has been generated with highest diligence but the provided data may in reality not represent the complete possible variation range of all intrinsic parameters. Therefore, in certain cases a deviation from the provided data could occur.

LEDiL Oy reserves the right to undertake technical changes of its products without further notification which could lead to changes in the provided data. LEDiL Oy assumes no liability of any kind for the possible deviation from any provided data or any other damage resulting from the usage of the provided data.

The user agrees to this disclaimer and user agreement with the download or usage of the provided files.

LEDiL Oy

Joensuunkatu 13
FI-24240 SALO
Finland

LEDiL Inc.

228 West Page Street
Suite D
Sycamore IL 60178
USA

Local sales and technical support

www.ledil.com/where_to_buy

Shipping locations

Salo, Finland
Hong Kong, China

Distribution Partners

www.ledil.com/where_to_buy