

ON Semiconductor

Is Now

onsemi™

To learn more about onsemi™, please visit our website at
www.onsemi.com

onsemi and **onsemi** and other names, marks, and brands are registered and/or common law trademarks of Semiconductor Components Industries, LLC dba "**onsemi**" or its affiliates and/or subsidiaries in the United States and/or other countries. **onsemi** owns the rights to a number of patents, trademarks, copyrights, trade secrets, and other intellectual property. A listing of **onsemi** product/patent coverage may be accessed at www.onsemi.com/site/pdf/Patent-Marking.pdf. **onsemi** reserves the right to make changes at any time to any products or information herein, without notice. The information herein is provided "as-is" and **onsemi** makes no warranty, representation or guarantee regarding the accuracy of the information, product features, availability, functionality, or suitability of its products for any particular purpose, nor does **onsemi** assume any liability arising out of the application or use of any product or circuit, and specifically disclaims any and all liability, including without limitation special, consequential or incidental damages. Buyer is responsible for its products and applications using **onsemi** products, including compliance with all laws, regulations and safety requirements or standards, regardless of any support or applications information provided by **onsemi**. "Typical" parameters which may be provided in **onsemi** data sheets and/or specifications can and do vary in different applications and actual performance may vary over time. All operating parameters, including "Typicals" must be validated for each customer application by customer's technical experts. **onsemi** does not convey any license under any of its intellectual property rights nor the rights of others. **onsemi** products are not designed, intended, or authorized for use as a critical component in life support systems or any FDA Class 3 medical devices or medical devices with a same or similar classification in a foreign jurisdiction or any devices intended for implantation in the human body. Should Buyer purchase or use **onsemi** products for any such unintended or unauthorized application, Buyer shall indemnify and hold **onsemi** and its officers, employees, subsidiaries, affiliates, and distributors harmless against all claims, costs, damages, and expenses, and reasonable attorney fees arising out of, directly or indirectly, any claim of personal injury or death associated with such unintended or unauthorized use, even if such claim alleges that **onsemi** was negligent regarding the design or manufacture of the part. **onsemi** is an Equal Opportunity/Affirmative Action Employer. This literature is subject to all applicable copyright laws and is not for resale in any manner. Other names and brands may be claimed as the property of others.



ON Semiconductor

Universal Input, 20 W, LED Ballast

Device	Application	Input Voltage	Output Power	Topology	I/O Isolation
NCP1351	Solid State Lighting	85 – 265 Vac	20 W	Flyback	Yes

Other Specifications

	Output 1			
Maximum Output Voltage	33 V			
Ripple	Not Given			
Nominal Current	700 mA			

PFC (Yes/No)	No
Target Efficiency	80% at nominal load
Max Size	125 x 37 x 35 mm
Operating Temp Range	0 to +70°C
Cooling Method/Supply Orientation	Convection
Signal Level Control	No

Other Requirements	
--------------------	--

Circuit Description

The NCP1351 controller provides for a low cost, variable frequency, flyback converter. It incorporates a very low quiescent current allowing for high value resistors to be used as a start-up circuit direct from the HV rail.

The design comprises an input filter, bridge rectifier (using low cost 1N4007 diodes), bulk capacitors and line inductor in π -filter arrangement, the power stage, rectifier diode and smoothing capacitors. Feedback is CVCC, constant current drive for the LED's with a constant voltage in the event of an open circuit output.

In order to stay below IEC6100-3-2 Class C, the design has been optimized at <25 W, so assuming 80% efficiency the maximum output power is ~20 W.

Key Features

- Wide input voltage range – 85 Vac to 265 Vac
- Small size, and low cost
- Good line regulation
- High efficiency
- Overload and short circuit protection.

Number of LED's in series	LED Current			
	350 mA	700 mA	1 A	1.5 A
LUXEON® I	11		Note 1	
LUXEON® III	10	6	4	Note 1
LUXEON® Rebel	10	6	4	Note 1
LUXEON® K2	11	6	4	2
Cree XR-E®	12	8	5	Note 1
Cree XP-E®	12	8	Note 1	Note 1
OSRAM Platinum Dragon®	12	7	5	Note 1
V _Z (D10)	45 V	33 V	22 V	12 V
R12 & R13	3R6	1R8	1R2	0R8

Note 1 Out of LED specification

DN06040/D Schematic

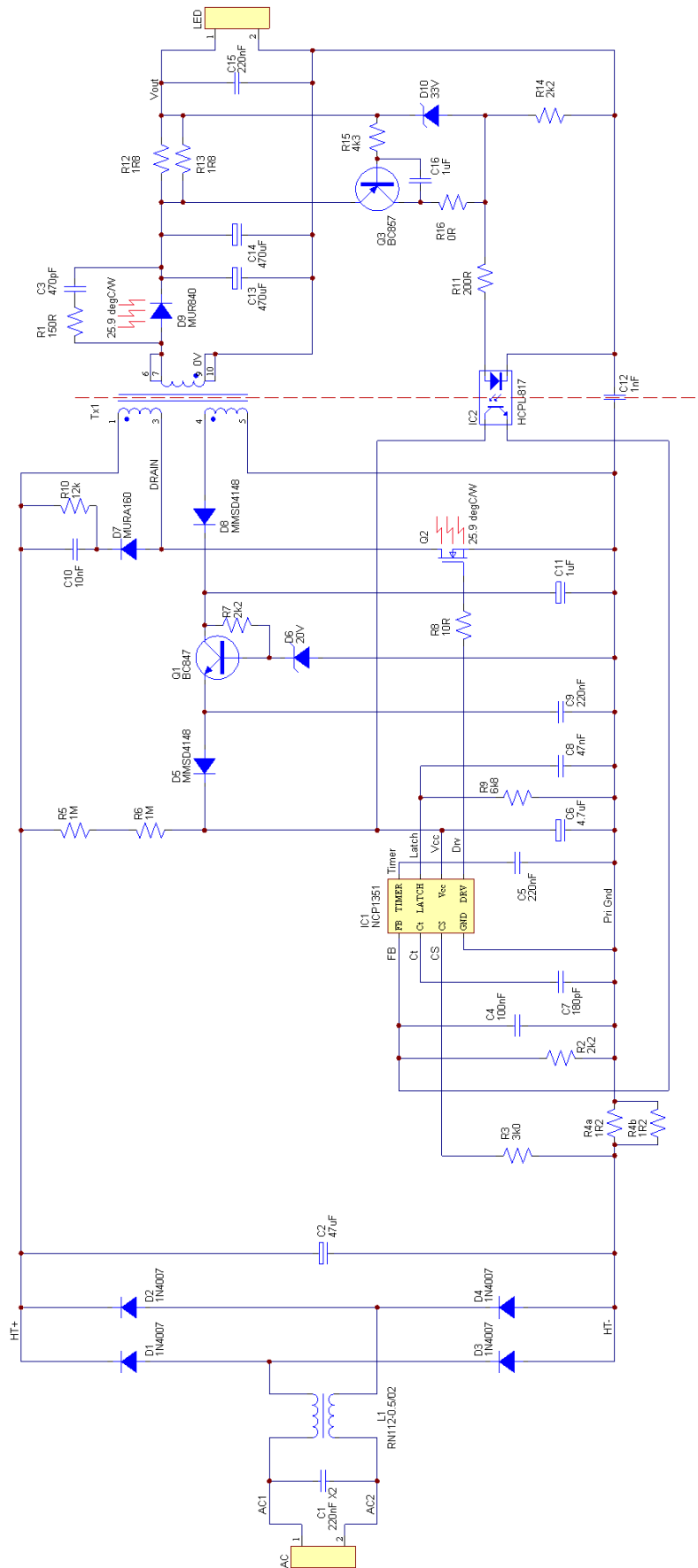

LED Current

The light output of an LED is determined by the forward current so the control loop will be constant current, with a simple Zener to limit the maximum output voltage.

Typical forward voltages vary by LED supplier, below are the nominal forward voltage characteristics of the LUXEON® K2 at different operating currents.

I _F	V _F
350 mA	3.42 V
700 mA	3.60 V
1000 mA	3.72 V
1500 mA	3.85 V

Driving eight LED's at 700mA thus gives an output power of 20.2 W at 28.8 V.

Inductor selection

In a flyback converter the inductance required in the transformer primary is dependant on the mode of operation and the output power. Discontinuous operation requires lower inductance but results in higher peak to average current waveforms, and thus higher losses. For low power designs, such as this ballast, the inductance is designed to be just continuous (or just discontinuous) under worst case conditions, that is minimum line and maximum load.

The specification for this ballast is as follows:

- Universal input – 85 Vac to 265 Vac
- 25 W maximum input power – PFC limit
- Assuming 80% efficiency – 20 W output power
- 700 mA output current
- 100 kHz operation at full load

This gives us a minimum DC input voltage of 120 V, there will be some sag on the DC bulk capacitors so an allowance will be made for this by using 80 V as the minimum input voltage, including MOSFET drop etc.

First we need to calculate the turn's ratio, this is set by the MOSFET drain rating, line voltage and reflected secondary voltage. Since this is a constant current circuit we are designing, with a varying output voltage, we need the maximum output voltage.

- V_{IN(max)} is the maximum rectified input = 375 V.
- V_{IN(min)} is the minimum rectified input = 80 V.
- V_{OUT} is 35 V (20 W @ 700 mA is 29 V plus a margin for safety).

With a 600 V MOSFET and derating of 80%, our maximum allowable drain voltage is:

$$V_{D(max)} = 600 \times 0.8 = 480 \text{ V} \dots\dots\dots(\text{Eq.3})$$

And thus headroom, V_{CLAMP} for the reflected secondary voltage and leakage spike of:

$$V_{CLAMP} = V_{D(max)} - V_{IN(max)} = 480 - 375 \dots\dots\dots(\text{Eq.4})$$

$$= 105 \text{ V}$$

The output current is sensed by a series resistance, once the voltage drop across this reaches the base-emitter threshold of the PNP transistor current flows in the opto-coupler diode and thus in the FB pin of the NCP1351.

The LED current is thus set by:

$$I_{LED} = \frac{0.6V}{R_{SENSE}} \dots\dots\dots(\text{Eq.1})$$

Total sense resistor power dissipation is:

$$P_D = I_{LED} \times 0.6V \dots\dots\dots(\text{Eq.2})$$

So for 700 mA we need a 0.9 Ω sense resistor capable of dissipating 420 mW, two 330 mW surface mount resistors, 1.8 Ω each in parallel, are used.

Good results are obtained if we set V_{CLAMP}, at ~150% of the reflected secondary:

$$k_C = \frac{V_{CLAMP} \times N}{(V_{OUT} + V_f)} = 1.5 \dots\dots\dots(\text{Eq.5})$$

- V_f = 0.7 V as we will need a high voltage diode.

Re-arranging for N:

$$N = \frac{N_s}{N_p} = \frac{1.5 \times (35 + 0.7)}{105} \dots\dots\dots(\text{Eq.6})$$

$$= 0.51$$

We will use a ratio of 0.5 or 2:1, this will give a good transformer construction.

We can now calculate the maximum duty cycle running in CCM:

$$\delta_{MAX} = \frac{V_{OUT}}{V_{OUT} + V_{IN(min)}N} = \frac{(35 + 0.7)}{(35 + 0.7) + 80 \times 0.5} \dots\dots\dots(\text{Eq.7})$$

$$= 0.47$$

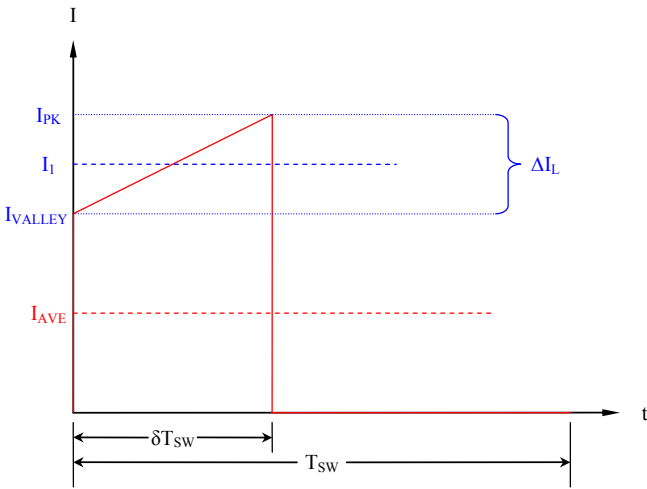

Looking at the waveform of the current flowing in the primary of the inductor (above) if we define a term k equal to;

$$k = \frac{\Delta I_L}{I_1} \dots\dots\dots(\text{Eq.8})$$

And use the equation:

$$L = \frac{(V_{IN(\min)} \delta_{MAX})^2}{f_{SW} k P_{IN}} \dots\dots\dots(\text{Eq.9})$$

Then we can determine the inductance we require.

If $k = 2$ then we are in boundary conduction mode as the ripple current equals twice the average pulse current, so setting k to 2:

$$L = \frac{(80 \times 0.47)^2}{100 \times 10^3 \times 2.0 \times 25} = 283 \mu H \dots\dots\dots(\text{Eq.10})$$

Thus we can now find the primary ripple current assuming operation in boundary conduction mode:

$$\begin{aligned} \Delta I_L &= \frac{V_{IN(\min)} T_{ON}}{L} = \frac{V_{IN(\min)} \delta_{\max}}{L f_{SW}} \dots\dots\dots(\text{Eq.11}) \\ &= \frac{80 \times 0.47}{283 \times 10^{-6} \times 100 \times 10^3} = 1.32 \text{ A} \end{aligned}$$

The average input current, I_{AVE} , is:

$$I_{AVE} = \frac{P_{IN}}{V_{IN(\min)}} = \frac{25}{80} = 313 \text{ mA} \dots\dots\dots(\text{Eq.12})$$

The average pulse current, I_1 , is:

$$I_1 = \frac{I_{AVE}}{\delta_{\max}} = \frac{0.313}{0.47} = 662 \text{ mA} \dots\dots\dots(\text{Eq.13})$$

Demonstrating that ΔI_L does equal twice I_1 and that the peak primary current is 1.32 A.

We can calculate the RMS current in the MOSFET and sense resistor for dissipation purposes. For a stepped-sawtooth waveform of this type the equation is:

$$I_{RMS} = I_1 \sqrt{\delta} \sqrt{1 + \frac{1}{3} \left(\frac{\Delta I_L}{2 I_1} \right)^2} \dots\dots\dots(\text{Eq.14})$$

Thus:

$$\begin{aligned} I_{RMS} &= 0.665 \times \sqrt{0.47} \times \sqrt{1 + \frac{1}{3} \left(\frac{1.32}{2 \times 0.665} \right)^2} \\ &= 526 \text{ mA} \dots\dots\dots(\text{Eq.15}) \end{aligned}$$

We can also determine the current sense resistor, allowing for a drop across the resistor of 0.8 V:

$$R_{SENSE} = \frac{V_{DROP}}{I_{PK}} = \frac{0.8}{1.32} = 0.61 \Omega \dots\dots\dots(\text{Eq.16})$$

The total power dissipation is:

$$\begin{aligned} P_{D(sense)} &= I_{RMS}^2 R_{SENSE} = 0.526^2 \times 0.61 \\ &\cong 170 \text{ mW} \dots\dots\dots(\text{Eq.17}) \end{aligned}$$

Two 1.2 Ω resistors in parallel will be used as sub 1 Ω resistors typically cost more.

The threshold voltage for the current sense is set by an offset resistor; this has a bias current of 270 μA in it so we can determine the resistor value:

$$R_{OFFSET} = \frac{V_{SENSE}}{I_{BIAS}} = \frac{0.8}{270 \times 10^{-6}} \cong 3.0 \text{ k}\Omega \dots\dots\dots(\text{Eq.18})$$

Rectifier snubber

Testing demonstrated the need for snubbing on the rectifier as there was a large amount of ringing present after the rectifier turns off.

The snubber consists of a resistor and capacitor in series, and knowing the junction capacitance and ringing frequency we can determine the necessary values:

$$R_s = \sqrt{\frac{L}{C_j}} \dots\dots\dots(\text{Eq.19})$$

$$C_s = \frac{2\pi\sqrt{LC_j}}{R_s} \dots\dots\dots(\text{Eq.20})$$

Knowing that:

$$f = \frac{1}{2\pi\sqrt{LC_j}} \dots\dots\dots(\text{Eq.21})$$

We can determine L , the stray inductance which then allows us to calculate the necessary snubber resistor.

- $f = 14.5$ MHz (measured on oscilloscope)
- $C_j = 80$ pF (datasheet figure for MUR840 at 62 V)

$$L = \frac{1}{4C_j(\pi f)^2} = \frac{1}{4 \times 80 \times 10^{-12} \times (\pi \times 14.5 \times 10^6)^2}$$

$$= 1.51 \mu\text{H}$$

\dots\dots\dots(\text{Eq.22})

$$R_s = \sqrt{\frac{1.51 \times 10^{-6}}{80 \times 10^{-12}}} = 137 \Omega \dots\dots\dots(\text{Eq.23})$$

$$C_s = \frac{2 \times \pi \times \sqrt{1.51 \times 10^{-6} \times 80 \times 10^{-12}}}{137} = 504 \text{ pF}$$

\dots\dots\dots(\text{Eq.24})

The nearest standard values are 470 pF and 140 Ω , inserting these into the circuit eliminated the ringing due to the rectifier.

Auxiliary winding

Normally in a flyback converter the auxiliary winding would be in the form of a flyback winding, i.e. in phase with the output winding, and thus provide a semi-regulated voltage to supply the controller. As this ballast is current controlled and the output voltage can vary over a considerable range depending on the number of LED's connected, a forward phased winding is used. The auxiliary will therefore vary with line rather than output voltage. Since neither option could supply sufficient volts at low input/output voltage whilst still staying below the maximum V_{CC} figure of 28 V, a voltage regulator is used formed by Q1 and D6. Below ~ 20 V the regulator does nothing other than act as a small volt drop, however as the voltage rises it clamps the voltage to around 20.7 V, since the current is very low into the V_{CC} pin there is very little loss.

DN06040/D MAGNETICS DESIGN DATA SHEET

Project / Customer: ON Semiconductor
 Part Description: 25 W Transformer
 Schematic ID: -
 Core Type: EE25
 Core Gap: Gap for 250 μ H
 Inductance: 250 μ H
 Bobbin Type: NIC 10-pin vertical

Windings (in order):

Winding # / type	Turns / Material / Gauge / Insulation Data
N1, Primary	Start on pin 1 and wind 20 turns, of 0.28 mm triple insulated wire (e.g. Tex-E), in one neat layer across the entire bobbin width. Finish on pin 2.
N2, Secondary	Start on pins 9&10 and wind 20 turns, of 0.8 mm Grade II ECW, distributed evenly across the entire bobbin width. Finish on pins 6&7.
N3, Primary	Start on pin 2 and wind 20 turns, of 0.28 mm triple insulated wire (e.g. Tex-E), in one neat layer across the entire bobbin width. Finish on pin 3.
N4, Primary (Aux)	Start on pin 4 and wind 5 turns, of 0.28 mm triple insulated wire, in one neat layer spread evenly across the entire bobbin width. Finish on pin 5.

Sleeving and insulation between primary and secondary as required to meet the requirements of double insulation.

Primary leakage inductance (pins 6&7 and 9&10 shorted together) to be < 6 μ H

NIC part number: NLT282224W3P4020S5P10F

Hipot: 3 kV between pins 1, 2, 3, 4 & 5 and pins 6, 7, 8, 9 & 10 for 60 seconds.

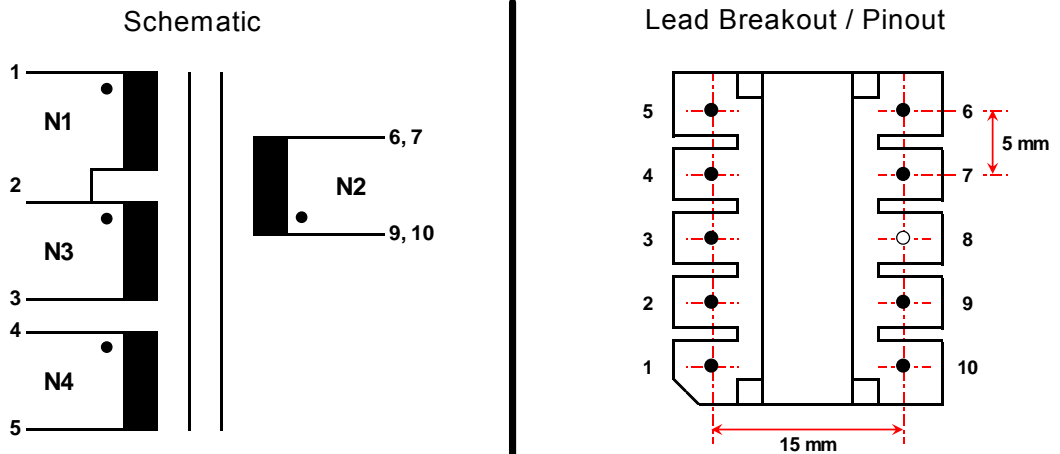

DN06040/D

Bill of Materials

Ref	Part Type / Value	Comment	Footprint	Description	Manufacturer	Part Number
C1	220nF X2	275VAC	18X10mm, 15mm pitch	X-class EMI suppression capacitor	NIC	NPX224M275VX2MF
C2	47uF	400V	Ø16mm, 7.5mm pitch	General purpose high voltage electrolytic	NIC	NRE-H470M400V16X31.5F
C3	470pF	100V X7R	1206	Ceramic chip capacitor	NIC	NMC1206X7R471K100F
C4	100nF	50V X7R	0603	Ceramic chip capacitor	NIC	NMC0603X7R104K50F
C5	220nF	50V X7R	0805	Ceramic chip capacitor	NIC	NMC0805X7R224K50F
C6	4.7uF	35V	Ø5mm, 2mm pitch	General purpose low voltage electrolytic	NIC	NRWA4R7M50V5X11F
C7	180pF	50V NP0	0603	Ceramic chip capacitor	NIC	NMC0603NPO181J50F
C8	47nF	50V X7R	0603	Ceramic chip capacitor	NIC	NMC0603X7R473K50F
C9	220nF	50V X7R	0805	Ceramic chip capacitor	NIC	NMC0805X7R224K50F
C10	10nF (0.01 uF)	1kV	1210	Ceramic chip capacitor	JOHANSON	102S41W103KV4E
C11	1uF	50V	Ø5mm, 2mm pitch	General purpose low voltage electrolytic	NIC	NRWA1R0M50V5X11F
C12	1nF	Y1	Radial, pitch 10mm	Ceramic Y-class capacitor	Murata	DE1E3KX102MN4AL01
C13	470uF	63V	Ø12.5mm, 5mm pitch	Miniature low impedance electrolytic	NIC	NRSZ471M63V12.5X25F
C14	Not Inserted					
C15	220nF	100V X7R	1206	Ceramic chip capacitor	NIC	NMC1206X7R224K100F
C16	1uF	50V	1206	Ceramic chip capacitor	NIC	NMC1206X7R105K50F
D1	1N4007	1A, 1000V	Axial	Axial Lead, Standard Recovery	ON Semiconductor	1N4007RLG
D2	1N4007	1A, 1000V	Axial	Axial Lead, Standard Recovery	ON Semiconductor	1N4007RLG
D3	1N4007	1A, 1000V	Axial	Axial Lead, Standard Recovery	ON Semiconductor	1N4007RLG
D4	1N4007	1A, 1000V	Axial	Axial Lead, Standard Recovery	ON Semiconductor	1N4007RLG
D5	MMSD4148	200mA, 100V	SOD-123	Switching diode	ON Semiconductor	MMSD4148T1G
D6	20V	1.5W	SMA	Zener Diode	ON Semiconductor	1SMA5932BT3G
D7	MURA160	1A, 600V	SMA	Ultrafast rectifier	ON Semiconductor	MURA160T3G
D8	MMSD4148	200mA, 100V	SOD-123	Switching diode	ON Semiconductor	MMSD4148T1G
D9	MUR840 (MUR860 - Alt)	8A, 400V	TO-220	Ultrafast Power Rectifier	ON Semiconductor	MUR840G
D10	33V	5%, 200mW	SOD323	Zener diode	ON Semiconductor	MM3Z33VT1G
IC1	NCP1351B	-	SOIC8	Variable Off-Time PWM Controller	ON Semiconductor	NCP1351BDR2G
IC2	HCPL-817	Wide pitch	HCPL-817-300E	Opto-coupler HCPL-817	Agilent	HCPL-817-WOAE
L1		-	WE-LF 662/SH	Common Mode Choke	Würth/Midcom	744 662 0027
AC	2-Way	5mm pitch	-	Screw Terminal	Keystone	8718
LED	2-Way	5mm pitch	-	Screw Terminal	Phoenix	1985881
M1	25.9°C/W	-	-	Heatsink	Aavid	577102B00000G
M2	25.9°C/W	-	-	Heatsink	Aavid	577102B00000G
Q1	BC847	45V	SOT-23	General purpose NPN	ON Semiconductor	BC847ALT1G
Q2	IRFBC40A	600V	TO-220	MOSFET	IR	IRFBC40A
Q3	BC857	-45V	SOT-23	General purpose PNP	ON Semiconductor	BC857ALT1G
R1	150R	0.33W, 5%	1210	Resistor thick film NRC	NIC	NRC25J151F
R2	2k2	0.1W, 5%	0603	Resistor thick film NRC	NIC	NRC06J222F
R3	3k0	0.1W, 5%	0603	Resistor thick film NRC	NIC	NRC06J302F
R4a	1R2	1W, 5%	2512	Resistor thick film NRC	NIC	NRC100J1R2F
R4b	1R2	1W, 5%	2512	Resistor thick film NRC	NIC	NRC100J1R2F
R5	1M	0.5W, 5%	Axial	Metal Film Resistor	Vishay	SFR2500001004J-R500
R6	1M	0.5W, 5%	Axial	Metal Film Resistor	Vishay	SFR2500001004J-R500
R7	2k2	0.125W, 5%	0805	Resistor thick film NRC	NIC	NRC10J222BF
R8	10R	0.25W, 5%	1206	Resistor thick film NRC	NIC	NRC12J100F
R9	6k8	0.1W, 5%	0603	Resistor thick film NRC	NIC	NRC06J682TRF
R10	12k	2W, 5%	Axial	Carbon film resistor	NIC	NCF200J123TRF
R11	200R	0.125W, 5%	0805	Resistor thick film NRC	NIC	NRC10J201F
R12	1R8	0.33W, 1%	1210	Resistor thick film NRC	NIC	NRC25J1R8F
R13	1R8	0.33W, 1%	1210	Resistor thick film NRC	NIC	NRC25J1R8F
R14	2K2	0.125W, 5%	0805	Resistor thick film NRC	NIC	NRC10J222BF
R15	4k3	0.125W, 5%	0805	Resistor thick film NRC	NIC	NRC10J432F
R16	0 ohm Short	0.125W	0805	Resistor Thick Film Chip	Vishay	CRCW08050000Z0EA
Tx1	25W LED TRANSFORMER	-	NIC 10 pin vertical	25W Flyback transformer	NIC	NLT282224W3P4020S5P10F

Component Placement and PCB Layout

Top view

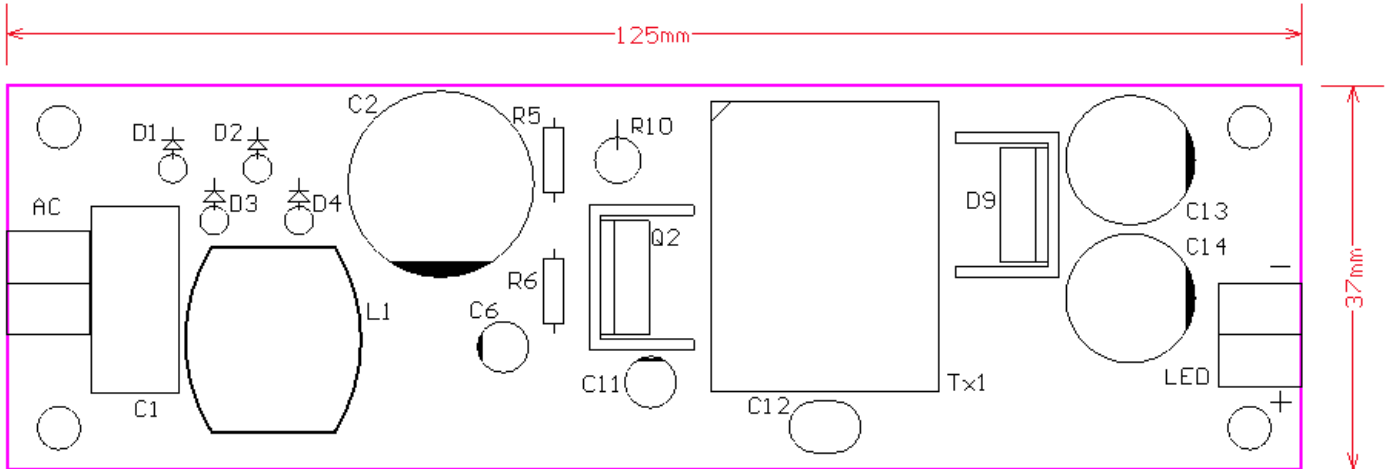

Bottom view

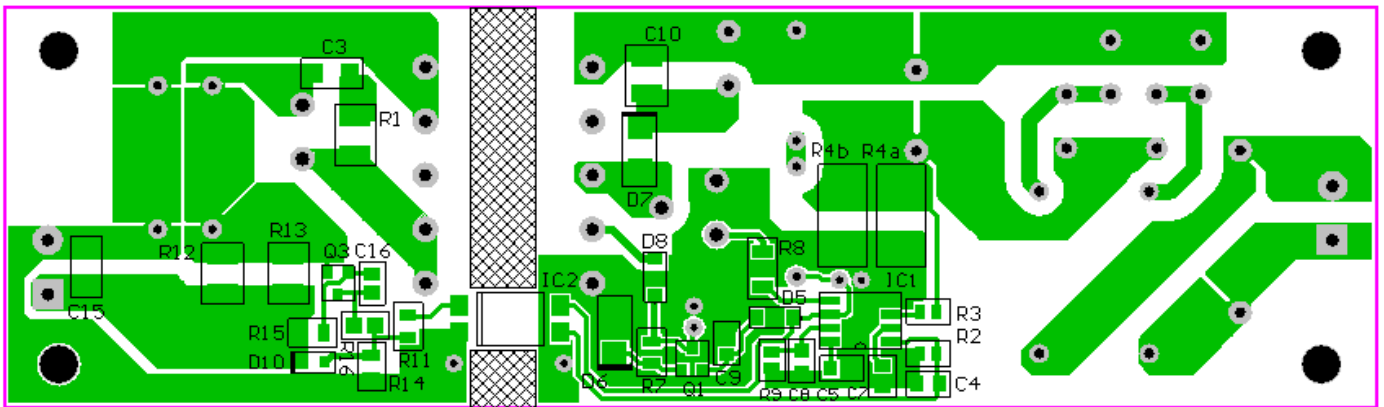

Completed Demo Board, Side View

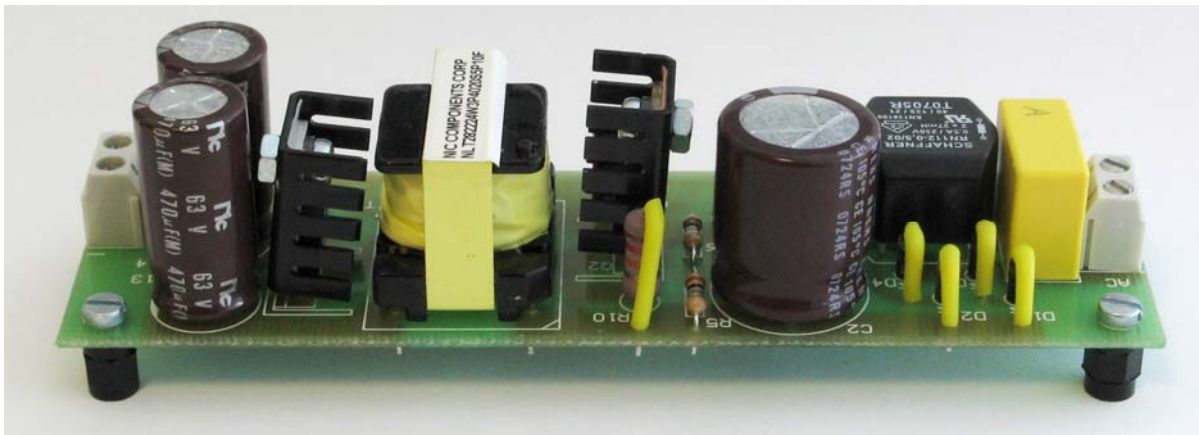

Typical Operational Results

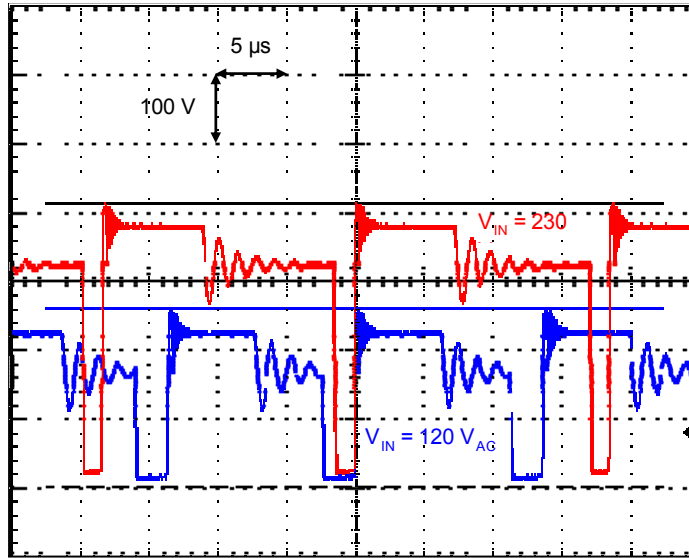

Drain waveform at 120 Vac and 230 Vac

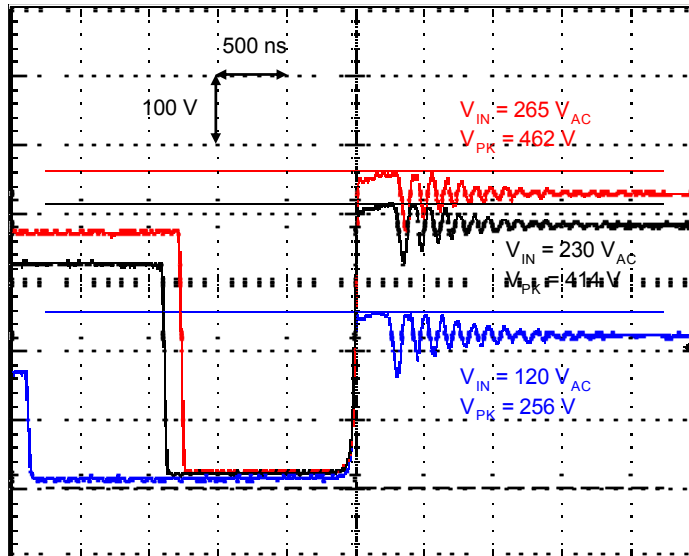

Turn-off in detail at 120 Vac, 230 Vac and 265 Vac

Typical Evaluation Results

Efficiency versus Line and Load @ 700mA
 $T_a = 21^{\circ}\text{C} / 70^{\circ}\text{F}$

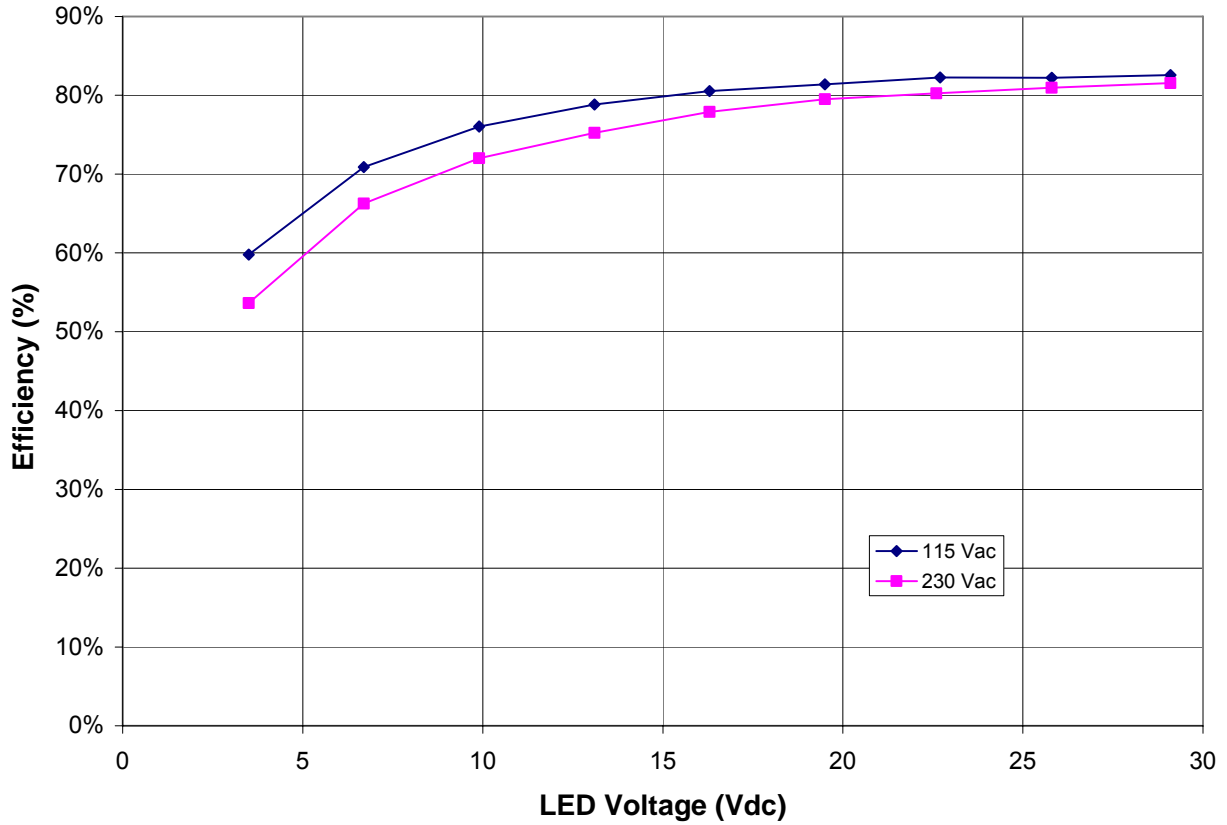

Current Regulation versus Forward Voltage @ 700mA
 $T_a = 21^{\circ}\text{C} / 70^{\circ}\text{F}$

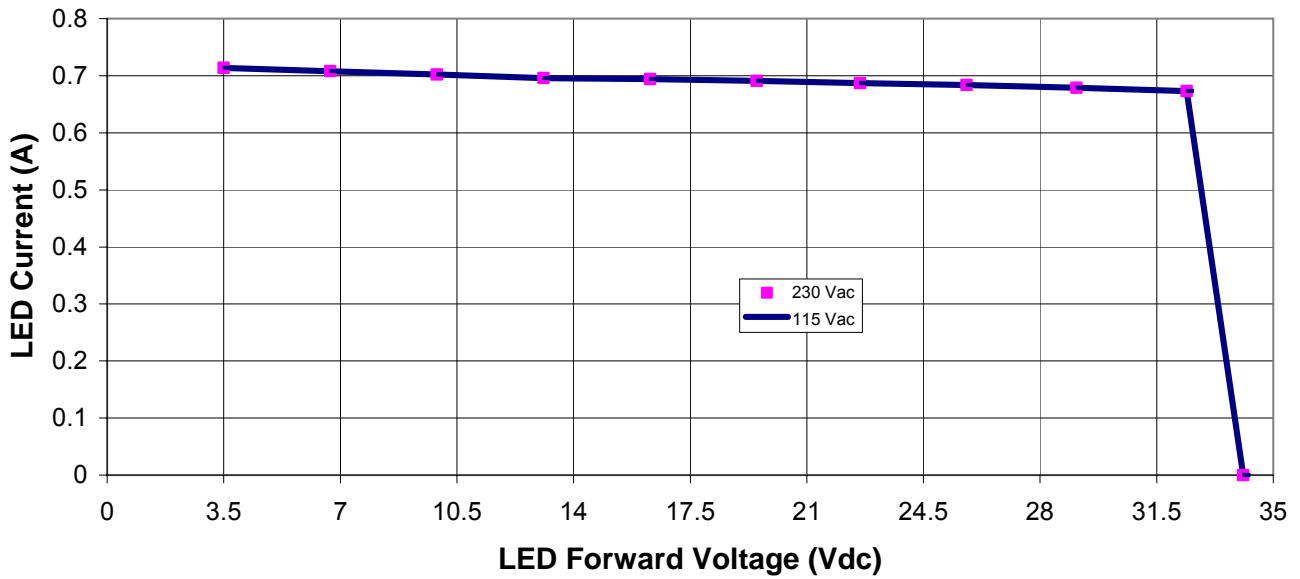

Modifying the Board for Other LED currents

The constant current constant voltage secondary control loop is very flexible and is implemented using a PNP (Q3) with a pair of current sense resistors (R12 & R13) to regulate the current and provide control of the optocoupler to the NCP1351. In addition, there is a maximum voltage control loop that is implemented using zener D10. To modify this circuit for alternate current / voltage configurations, these components should be modified. The table on the front page shows several other possible configuration options. Note because this design is ultimately power limited based on the transformer design and FET used, as the current decreases, the maximum voltage capability increases. For example, for 20W output, the maximum voltage at 350 mA could be as high as 57 Vdc. Under UL1310, Class 2 power supplies for use in dry/damp environments are allowed to have a maximum output voltage of 60 Vdc. On the demo board, Q3 is implemented using a BC857 transistor which has a maximum V_{CEO} of -45 Vdc. If a higher operating voltage is required, this transistor can be changed to a BC856 (maximum V_{CEO} of -65 Vdc). The figure below shows the current regulation performance for a nominal 350 mA output current with the component changes as noted.

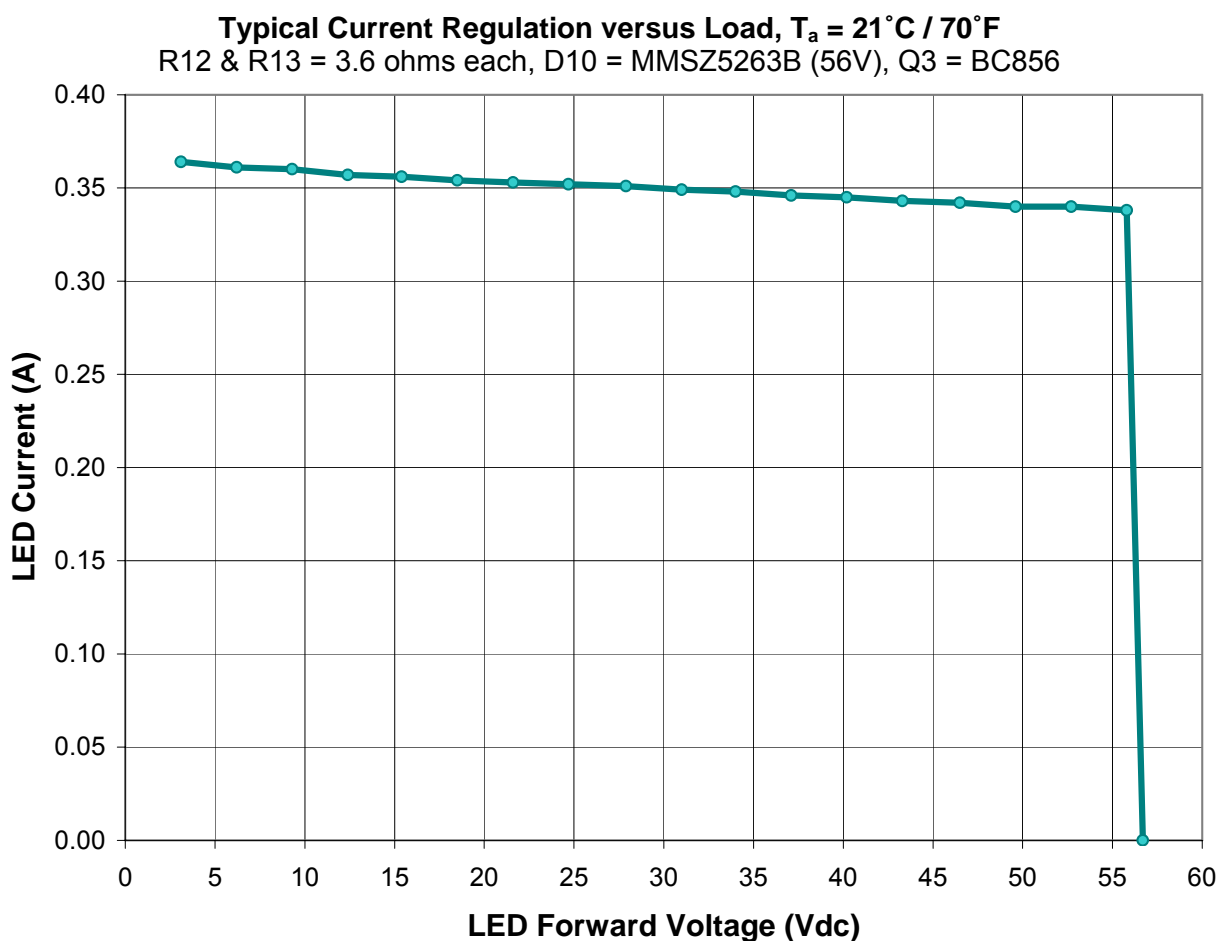

© 2008 ON Semiconductor.

Disclaimer: ON Semiconductor is providing this design note "AS IS" and does not assume any liability arising from its use; nor does ON Semiconductor convey any license to its or any third party's intellectual property rights. This document is provided only to assist customers in evaluation of the referenced circuit implementation and the recipient assumes all liability and risk associated with its use, including, but not limited to, compliance with all regulatory standards. ON Semiconductor may change any of its products at any time, without notice.

Design note created by Anthony Middleton, e-mail: Anthony.Middleton@onsemi.com