

SCHEMATIC

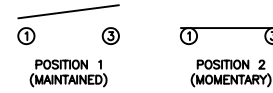

SPECIFICATIONS

FUNCTION:
1P1T OFF-(ON)

RATINGS:
ANSI/UL 1054 and CAN/CSA C22.2 No.55 (E194579):
16A 125VAC [UR, cUR]
1/2HP 125VAC [UR, cUR]
3/4HP 250VAC [UR, cUR]

EN 61058-1:2002:
16(6)A 250V~ 1E4 T125/55 [ENEC14]
10(4)A 250V~ 5E4 T125/55 [ENEC14]

CONTACT RESISTANCE:
Initial: 35mΩ Max. at 50VAC

INSULATION RESISTANCE:
100MΩ Min. at 500VDC

DIELECTRIC STRENGTH:
1,500VAC For 1 Minute

ELECTRICAL LIFE:
6,000 Cycles [UR, cUR]
10,000 Cycles [ENEC14]
50,000 Cycles [ENEC14]

TEMPERATURE:
Operating: -20°C to 105°C [UR, cUR]
Operating: -20°C to 125°C [ENEC14]

APPROVALS:

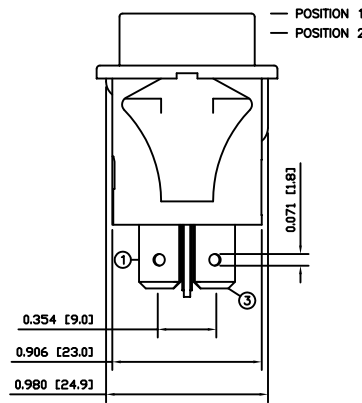
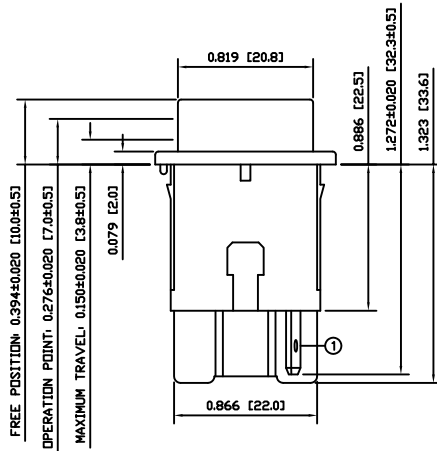
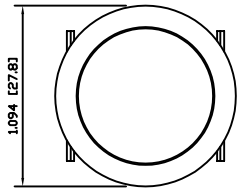

COLORS AND MARKINGS

BODY:
Black

ACTUATOR:
Red
Glossy Finish

MARKINGS:
None

MARKING COLOR:
None

MATERIALS

BODY:
Polyamide 6/6 (PA66), UL94 V-2

ACTUATOR:
Polyamide 6/6 (PA66), UL94 V-2

CONTACT CARRIER:
Polyamide 6/6 (PA66), UL94 V-2

SPRINGS:
Steel

MOBILE CONTACT:
Silver Plated Copper

CONTACTS:
Silver Plated Copper

TERMINALS:
Silver Plated Copper

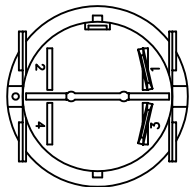

SUGGESTED PANEL CUTOUT

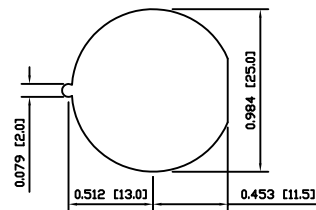

ALTERNATE PANEL CUTOUT

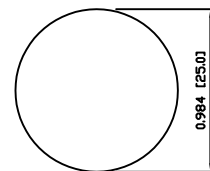

BODY	A	09/08/07	CAB
COLORS	A	09/08/07	CAB
MATERIALS	A	09/08/07	CAB
SPECIFICATIONS	B	10/05/25	CAB
REFERENCE	REV.	DATE	BY

THE INFORMATION CONTAINED IN THIS DOCUMENT IS PROPRIETARY TO E-SWITCH AND IS NOT TO BE COPIED OR TRANSFERRED

B	REMOVED SEMKO RATING	23315	04/16/18	MJR
A	INITIAL RELEASE	PCRD0051	09/08/07	CAB
REV.	DESCRIPTION	PCR	DATE	DRAWN BY

DIMENSIONS	
INCHES [MILLIMETERS]	
GENERAL TOLERANCES	
±0.008 [±0.2] / ±1'	
SCALE	PROJECTION
DRAWING NOT TO SCALE	1:1

PR144C1900			
DRAWING NUMBER	DATE	REVISION	
38-PR144C1900	AUGUST 7, 2009	B	