

- 注記 :  
NOTES:
- ① 材質 : TABLE 1参照  
MATERIAL : SEE TABLE 1
  - ② 梱包仕様書、製品仕様書、嵌合相手はSHEET 2をご参照ください。  
PLEASE REFER TO SHEET 2 FOR PACKAGING SPECIFICATION, PRODUCT SPECIFICATION AND MATE WITH.
  - 3. 本製品はコインなし品である。  
コインあり品は52670002-SD/PSD/000をご参照ください。  
THIS PRODUCT IS WITHOUT COIN.  
PLEASE REFER TO 52670002-SD/PSD/000 FOR WITH COIN PRODUCT.
  - ④ 発注番号 : ORDER NO.  
22035\*\*5

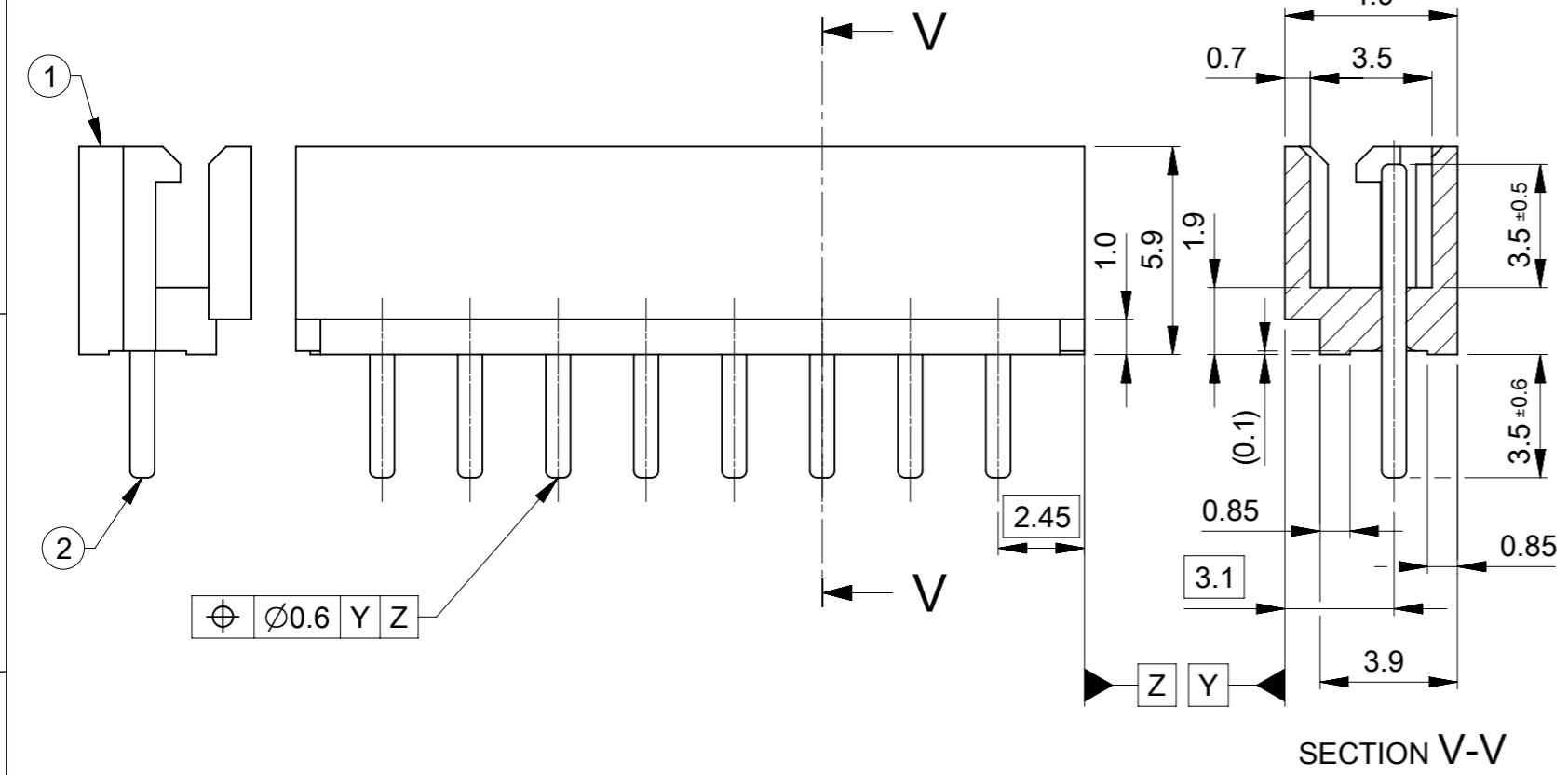

38.5±0.3	35	39.9±0.3	ポリ袋 POLY BAG	5267NA	526715A	22035155	15
36±0.3	32.5	37.4±0.3			526714A	22035145	14
33.5±0.3	30	34.9±0.3			526713A	22035135	13
31±0.3	27.5	32.4±0.3			526712A	22035125	12
28.5±0.25	25	29.9±0.25			526711A	22035115	11
26±0.25	22.5	27.4±0.25			526710A	22035105	10
23.5±0.25	20	24.9±0.25			526709A	22035095	9
21±0.25	17.5	22.4±0.25			526708A	22035085	8
18.5±0.25	15	19.9±0.25			526708A	22035075	7
16±0.25	12.5	17.4±0.25			526706A	22035065	6
13.5±0.25	10	14.9±0.25	526705A	22035055	5		
11±0.25	7.5	12.4±0.25	526704A	22035045	4		
8.5±0.2	5	9.9±0.2	526703A	22035035	3		
6±0.2	2.5	7.4±0.2	526702A	22035025	2		
C	B	A	梱包形態 PACKAGING	シリーズ番号 SERIES NO.	ENG. NO.	④ 発注番号 ORDER NO.	極数 CIRCUI T SIZE

① TABLE 1

番号 NO.	部品 PART	材質 MATERIAL
①	ハウジング HOUSING	ポリアミド(PA), UL94V-0, 色: ナチュラル(白) POLYAMIDE(PA), UL94V-0, COLOR: NATURAL (WHITE)
②	ピン PIN	母材 BASE METAL
		めっき PLATING
		下地めっき UNDERPLATING

黄銅 (Ø0.7) BRASS (Ø0.7)
錫めっき : 3 MICROMETER MIN. TIN
銅めっき : 1 MICROMETER MIN. COPPER (UNDERPLATING)

DOCUMENT STATUS	P1	RELEASE DATE	2023/03/09	08:59:58
-----------------	----	--------------	------------	----------

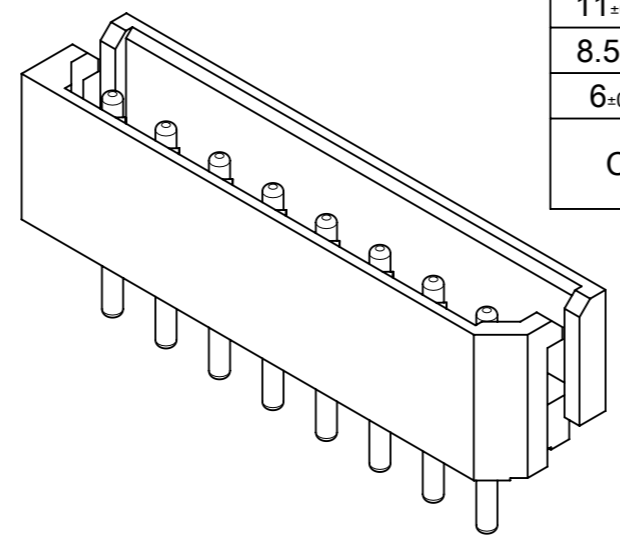

THIS DRAWING CONTAINS INFORMATION THAT IS PROPRIETARY TO MOLEX ELECTRONIC TECHNOLOGIES, LLC AND SHOULD NOT BE USED WITHOUT WRITTEN PERMISSION

DIMENSION UNITS	SCALE	CURRENT REV DESC:		
mm	NTS			
GENERAL TOLERANCES (UNLESS SPECIFIED)				
ANGULAR TOL	± 3.0°			
4 PLACES	±			
3 PLACES	±			
2 PLACES	± 0.2			
1 PLACE	± 0.2			
0 PLACES	±			
DRAFT WHERE APPLICABLE MUST REMAIN WITHIN DIMENSIONS		THIRD ANGLE PROJECTION	DRAWING	SERIES
			A3-SIZE	5267
		EC NO: 727270	DRWN: SOKUMURA01	2022/11/30
		CHK'D: SAKIYAMA	APPR: AIDA	2023/03/09
		INITIAL REVISION:	DRWN: SUDAYGUNAGI	2019/06/18
		APPR: KOMURAKAMI		2020/05/13
		DOCUMENT NUMBER		DOC TYPE
		52670001-SD		PSD 000
		CUSTOMER		REVISION
		GENERAL		B
		MATERIAL NUMBER		SHEET NUMBER
		SEE CHART		1 OF 2

△ 適用製品及び各種仕様書  
 APPLICABLE PRODUCTS AND VARIOUS SPECIFICATIONS

梱包仕様書 PACKAGING SPECIFICATION	ORDER NO. 22035**5	SPECIFICATION NO. SPK-5267-001 PS 001
嵌合相手 MATE WITH	RECEPTACLE HOUSING	
シリーズ番号 SERIES NO.	5264N	
製品仕様書 PRODUCT SPECIFICATION	PS-5264-001 PS 001	

2-8極  
2-8 CIRCUIT

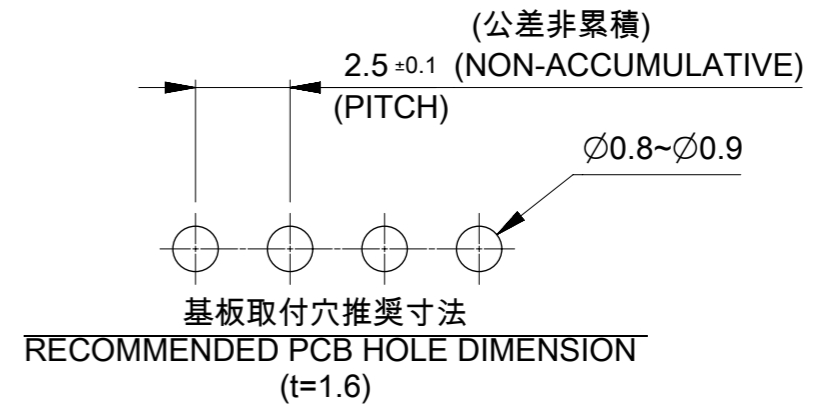
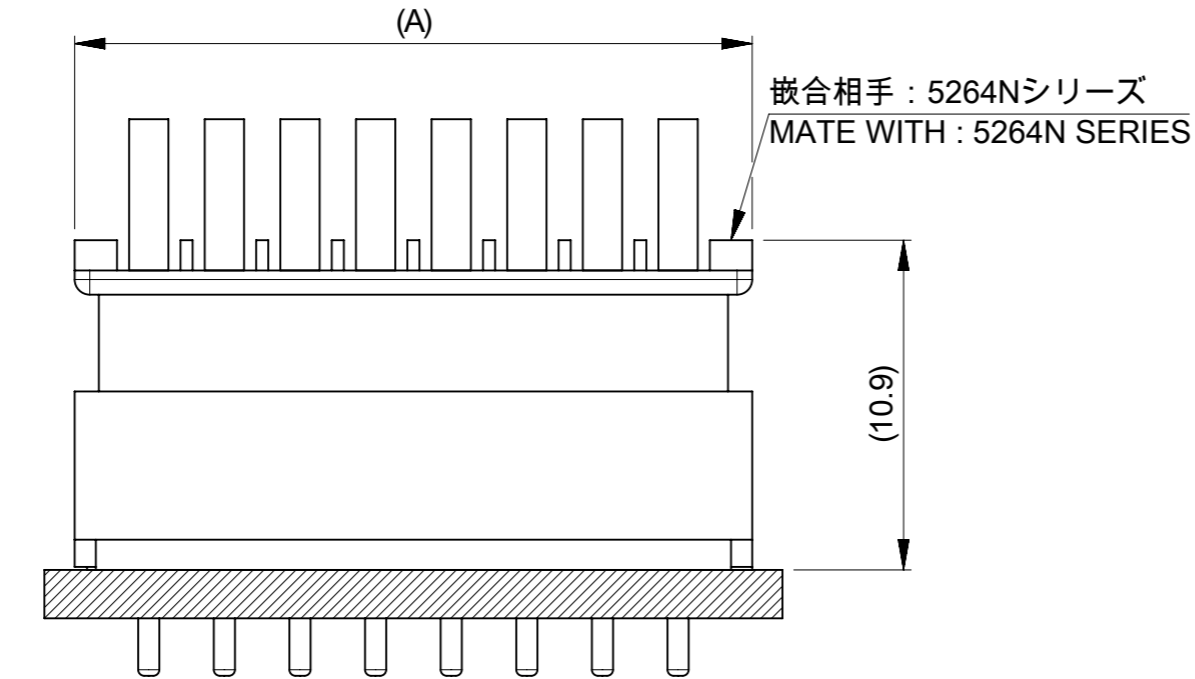
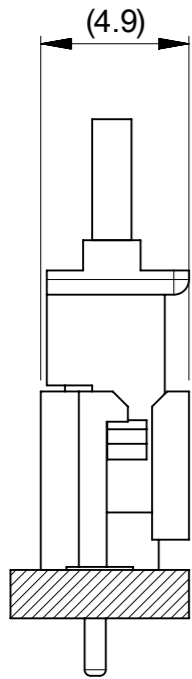

9-15極  
9-15 CIRCUIT

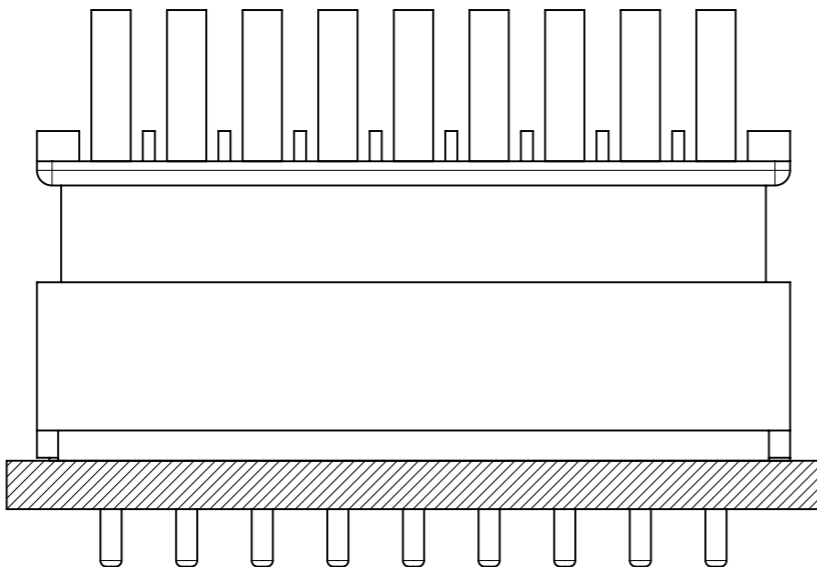
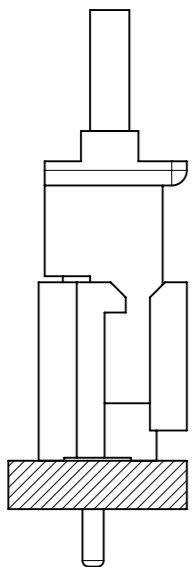

嵌合図  
 MATING CONNECTORS

THIS DRAWING CONTAINS INFORMATION THAT IS PROPRIETARY TO MOLEX ELECTRONIC TECHNOLOGIES, LLC AND SHOULD NOT BE USED WITHOUT WRITTEN PERMISSION									
DIMENSION UNITS	SCALE	CURRENT REV DESC:							
mm	NTS								
GENERAL TOLERANCES (UNLESS SPECIFIED)		EC NO: 727270			MINI-SPOX 2.5 W/B VERTICAL PLUG ASSEMBLY WITHOUT COIN COPPER UNDERPLATING				
ANGULAR TOL ± 3.0°		DRWN: SOKUMURA01 2022/11/30							
4 PLACES	±	CHK'D: SAKIYAMA 2023/03/09			PRODUCT CUSTOMER DRAWING				
3 PLACES	±	APPR: AIDA 2023/03/09							
2 PLACES	± 0.2	INITIAL REVISION:			DOCUMENT NUMBER: 52670001-SD DOC TYPE: PSD DOC PART: 000 REVISION: B				
1 PLACE	± 0.2	DRWN: SUDAYGUNAGI 2019/06/18							
0 PLACES	±	APPR: KOMURAKAMI 2020/05/13			MATERIAL NUMBER: SEE SHEET 1 CUSTOMER: GENERAL SHEET NUMBER: 2 OF 2				
DRAFT WHERE APPLICABLE MUST REMAIN WITHIN DIMENSIONS		THIRD ANGLE PROJECTION	DRAWING	SERIES					
			A3-SIZE	5267					