

STRAIGHT BULKHEAD JACK WITH FRONT NUT AND PANEL SEAL CABLE 2.6/75 S

R162.322.000

SERIES

N 75

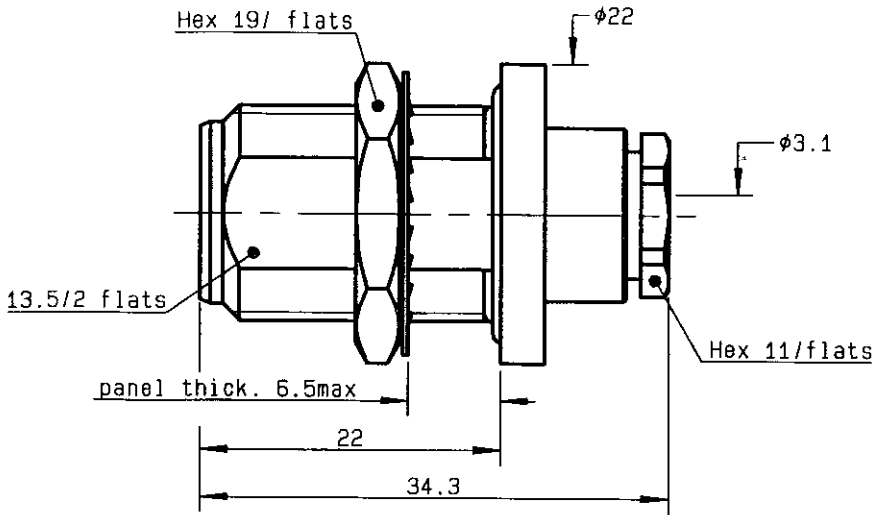

PERCEGE PANNEAU
MOUNTING HOLE

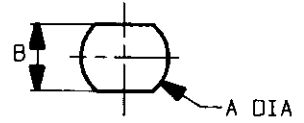

	MM		INCH	
	maxi	mini	maxi	mini
A	16.1	16	0.634	0.63
B	13.7	13.6	0.539	0.535

NOMINAL IMPEDANCE	75	Ω
FREQUENCY RANGE	0-1.5	GHz
TEMPERATURE RATING	-55/+155	$^{\circ}\text{C}$
V.S.W.R	1.05 +	x F(GHz)Maxi
RF INSERTION LOSS	TBD	\sqrt{F} (GHz) dB Maxi
VOLTAGE RATING	850	Veff Maxi
DIELECTRIC WITHSTANDING VOLTAGE	1500	Veff Mini
INSULATION RESISTANCE	5000	M Ω Mini
HERMETIC SEAL	NA	Atm.cm ³ /s
LEAKAGE (pressurized only)	NA	
MECHANICAL DURABILITY	500	Cycles
WEIGHT	37.4	gr

CABLES : **RS 179**
RS 187

OTHERS CHARACTERISTICS

CABLE RETENTION	40	N Mini
CENTER CONTACT RETENTION		
Axial force - mating end	27	N Mini
Axial force - opposite end	27	N Mini
Torque	NA	cm.N Mini
RECOMMENDED TORQUES		
Mating	NA	cm.N
Panel nut	500	cm.N
Clamp nut	150	cm.N

CONNECTOR PARTS	MATERIALS	FINISH	(all values are given in micrometers)
BODY	BRASS	BBR 2	
OUTER CONTACT	BRASS	BBR 2	
CENTER CONTACT	BERYLLIUM COPPER	GOLD 0.5 OVER NICKEL 2	
INSULATOR	PTFE	-	
GASKET	SILICONE RUBBER	-	
OTHERS PIECES	BRASS	BBR 2	

ISSUE	CREATION DATE	FILE PART-NUMBER
9847C02	16-SEP-96	96-0106-188



The information given here is subject to change without notice. Design changes may be in order to improve the product.

Connect to the future

GERALD



R162.322.000

ISSUE 9847C02 SERIES N 75

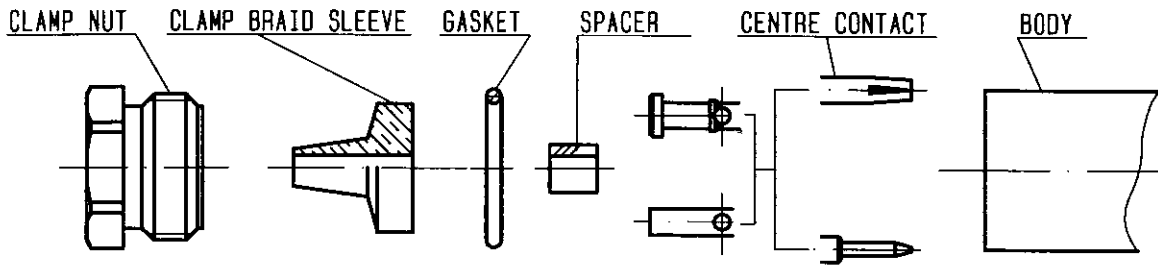

①

Slide clamp nut onto cable .
Strip the cable .
Cut the jacket (2 slots)
apart if necessary .

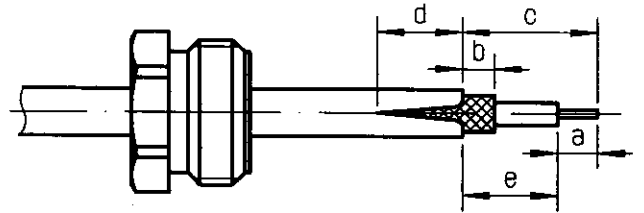

Stripping	a	b	c	d	e
inch	0.157	0.079	0.315	0.079	0.157
mm	4	2	8	2	4

②

Slide the clamp braid sleeve between
cable dielectric and braid .
Cut the braid flush with the clamp
braid sleeve .
Slide the spacer .

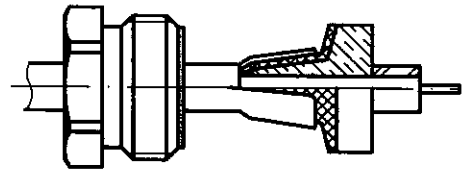

③

Solder the cable inner conductor into
centre contact .
Slide the back nut over the clamp
assembly .

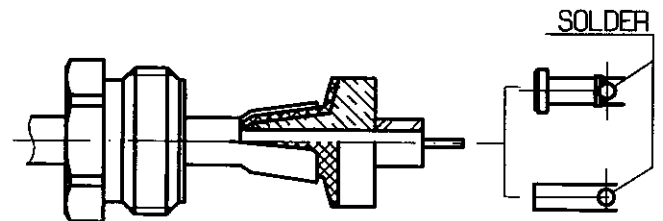

④

Mount the gasket into the connector .
Screw sub-assembly into the connector
body .
(recommended coupling torque 13.27 in.lb)

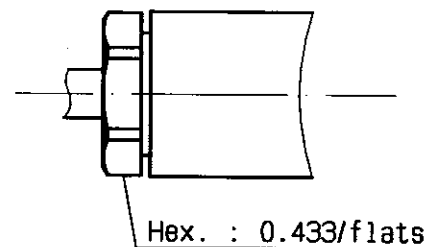

GERALL U