



CY8CKIT-148

PSoC<sup>®</sup> 4700S Inductive Sensing  
Evaluation Kit Guide

Doc. #: 002-23165 Rev. \*B

Cypress Semiconductor  
198 Champion Court  
San Jose, CA 95134-1709  
[www.cypress.com](http://www.cypress.com)

## Copyrights

© Cypress Semiconductor Corporation, 2018. This document is the property of Cypress Semiconductor Corporation and its subsidiaries, including Spansion LLC ("Cypress"). This document, including any software or firmware included or referenced in this document ("Software"), is owned by Cypress under the intellectual property laws and treaties of the United States and other countries worldwide. Cypress reserves all rights under such laws and treaties and does not, except as specifically stated in this paragraph, grant any license under its patents, copyrights, trademarks, or other intellectual property rights. If the Software is not accompanied by a license agreement and you do not otherwise have a written agreement with Cypress governing the use of the Software, then Cypress hereby grants you a personal, non-exclusive, nontransferable license (without the right to sublicense) (1) under its copyright rights in the Software (a) for Software provided in source code form, to modify and reproduce the Software solely for use with Cypress hardware products, only internally within your organization, and (b) to distribute the Software in binary code form externally to end users (either directly or indirectly through resellers and distributors), solely for use on Cypress hardware product units, and (2) under those claims of Cypress's patents that are infringed by the Software (as provided by Cypress, unmodified) to make, use, distribute, and import the Software solely for use with Cypress hardware products. Any other use, reproduction, modification, translation, or compilation of the Software is prohibited.

TO THE EXTENT PERMITTED BY APPLICABLE LAW, CYPRESS MAKES NO WARRANTY OF ANY KIND, EXPRESS OR IMPLIED, WITH REGARD TO THIS DOCUMENT OR ANY SOFTWARE OR ACCOMPANYING HARDWARE, INCLUDING, BUT NOT LIMITED TO, THE IMPLIED WARRANTIES OF MERCHANTABILITY AND FITNESS FOR A PARTICULAR PURPOSE. No computing device can be absolutely secure. Therefore, despite security measures implemented in Cypress hardware or software products, Cypress does not assume any liability arising out of any security breach, such as unauthorized access to or use of a Cypress product. In addition, the products described in these materials may contain design defects or errors known as errata which may cause the product to deviate from published specifications. To the extent permitted by applicable law, Cypress reserves the right to make changes to this document without further notice. Cypress does not assume any liability arising out of the application or use of any product or circuit described in this document. Any information provided in this document, including any sample design information or programming code, is provided only for reference purposes. It is the responsibility of the user of this document to properly design, program, and test the functionality and safety of any application made of this information and any resulting product. Cypress products are not designed, intended, or authorized for use as critical components in systems designed or intended for the operation of weapons, weapons systems, nuclear installations, life-support devices or systems, other medical devices or systems (including resuscitation equipment and surgical implants), pollution control or hazardous substances management, or other uses where the failure of the device or system could cause personal injury, death, or property damage ("Unintended Uses"). A critical component is any component of a device or system whose failure to perform can be reasonably expected to cause the failure of the device or system, or to affect its safety or effectiveness. Cypress is not liable, in whole or in part, and you shall and hereby do release Cypress from any claim, damage, or other liability arising from or related to all Unintended Uses of Cypress products. You shall indemnify and hold Cypress harmless from and against all claims, costs, damages, and other liabilities, including claims for personal injury or death, arising from or related to any Unintended Uses of Cypress products.

Cypress, the Cypress logo, Spansion, the Spansion logo, and combinations thereof, WICED, PSoC, CapSense, EZ-USB, F-RAM, and Traveo are trademarks or registered trademarks of Cypress in the United States and other countries. For a more complete list of Cypress trademarks, visit [cypress.com](http://cypress.com). Other names and brands may be claimed as property of their respective owners.

# Contents



<b>Safety Information</b>	<b>5</b>
<b>1. Introduction</b>	<b>7</b>
1.1 Kit Contents .....	8
1.2 PSoC Creator .....	9
1.2.1 PSoC Creator Code Examples .....	10
1.2.2 Kit Code Examples.....	11
1.2.3 PSoC Creator Help .....	11
1.2.4 Component Datasheets .....	12
1.3 Getting Started.....	12
1.4 Additional Learning Resources .....	13
1.5 Technical Support.....	13
1.6 Document Conventions .....	14
1.7 Acronyms .....	15
<b>2. Software Installation</b>	<b>16</b>
2.1 Before You Begin.....	16
2.2 Install Software .....	16
2.3 Installing PSoC 4700S Device in PSoC Creator.....	19
2.4 Installing the MagSense Component.....	20
2.5 Uninstall Software .....	21
<b>3. Kit Operation</b>	<b>22</b>
3.1 Theory of Operation.....	22
3.2 Programming and Debugging the Target PSoC 4700S Device.....	24
3.2.1 Programming Using PSoC Creator .....	24
3.2.2 Debugging Using PSoC Creator .....	26
3.2.3 Programming Using PSoC Programmer .....	26
3.2.4 Mass Storage Programming .....	26
3.3 USB-UART Bridge .....	26
3.4 USB-I2C Bridge .....	27
3.5 Updating the KitProg2 Firmware.....	27
<b>4. Code Examples</b>	<b>28</b>
4.1 Using the Kit Code Examples .....	28
4.2 Using Built-in PSoC Creator Code Examples with the Kit .....	32

<b>Appendix</b>	<b>35</b>
A.1 Board Details .....	35
A.2 Hardware Details .....	36
A.2.1 Target Board .....	36
A.2.2 KitProg2 Board .....	37
A.2.3 Power Supply System .....	38
A.2.4 Header Connections .....	39
A.2.5 User and Passive Inputs .....	40
A.3 PSoC 4700S Inductive Sensing Evaluation Kit Schematics .....	49
A.4 Bill of Materials .....	49
<b>Revision History</b>	<b>50</b>

# Safety Information



## Regulatory Compliance

The CY8CKIT-148 PSoC 4700S Inductive Sensing Evaluation Kit is intended for use as an evaluation platform for hardware or software in a laboratory environment. The board is an open system design, which does not include a shielded enclosure. This may cause interference to other electrical or electronic devices in close proximity. In a domestic environment, this product may cause radio interference. In such cases, you may be required to take adequate preventive measures. In addition, this board should not be used near any medical equipment or RF devices.

Attaching additional wiring to this product or modifying the product operation from the factory default settings may affect its performance and cause interference with other apparatus in the immediate vicinity. If such interference is detected, suitable mitigating measures should be taken.



The PSoC 4700S Inductive Sensing Evaluation Kit, as shipped from the factory, has been verified to meet with requirements of CE as a Class A product.



The CY8CKIT-148 PSoC 4700S Inductive Sensing Evaluation Kit contains electrostatic discharge (ESD) sensitive devices. Electrostatic charges readily accumulate on the human body and any equipment, and can discharge without detection. Permanent damage may occur on devices subjected to high-energy discharges. Proper ESD precautions are recommended to avoid performance degradation or loss of functionality. Store unused CY8CKIT-148 PSoC 4700S Inductive Sensing Evaluation Kit boards in the protective shipping package.



### End-of-Life/Product Recycling

This kit has an end-of life five years from the date of manufacture mentioned on the back of the box. Contact your nearest recycler for discarding the kit.

## General Safety Instructions

### ESD Protection

ESD can damage boards and associated components. Cypress recommends that you perform procedures only at an ESD workstation. If such a workstation is not available, use appropriate ESD protection by wearing an anti-static wrist strap attached to the chassis ground (any unpainted metal surface) on your board when handling parts.

### Handling Boards

The CY8CKIT-148 PSoC 4700S Inductive Sensing Evaluation Kit board is sensitive to ESD. Hold the board only by its edges. After removing the board from its box, place it on a grounded, static-free surface. Use a conductive foam pad if available. Do not slide board over any surface.

# 1. Introduction



The PSoC 4700S Inductive Sensing Evaluation Kit is designed as an easy-to-use and inexpensive evaluation platform. The PSoC 4700S Inductive Sensing Evaluation Kit supports the PSoC 4700S device, delivering a complete system solution for a wide range of embedded applications at a very low cost. The PSoC 4700S device is a true programmable embedded system-on chip, integrating custom digital peripheral functions, memory, and an ARM<sup>®</sup> Cortex<sup>®</sup>-M0+ MCU on a single chip with flexible automatic routing. The programmable digital peripheral functions allow higher flexibility, in-field tuning of the design, and faster time-to-market. It is a combination of MCU with standard communication and timing peripherals, and a inductive sensing system with best in class performance.

The PSoC 4700S Inductive Evaluation Kit offers a complete solution for Inductive Sensing Technology with PSoC 4700S device. This kit provides a low-cost alternative to device samples while providing a platform to easily develop and integrate the PSoC 4700S device into your end-system. In addition, the board includes the following features:

- Seven LEDs to provide feedback for 4700S device
- KitProg2 Status LED and Mode switch
- Three Inductive Sensing button coils and one Proximity coil for Inductive Sensing evaluation
- Reset switch
- USB Type-C Connector
- 3.3 V operation

The CY8CKIT-148 PSoC 4700S Inductive Sensing Evaluation Kit also integrates a Cypress KitProg2 that enables onboard programming, debugging, and bridging functionalities, such as USB-UART and USB-I2C.

## 1.1 Kit Contents

The PSoC 4700S Inductive Sensing Evaluation Kit contains a PSoC 4700S Evaluation board, Metal Target, USB Type-A to Type-C Cable and Quick Start Guide.

Figure 1-1. CY8CKIT-148 PSoC 4700S Inductive Sensing Evaluation Kit

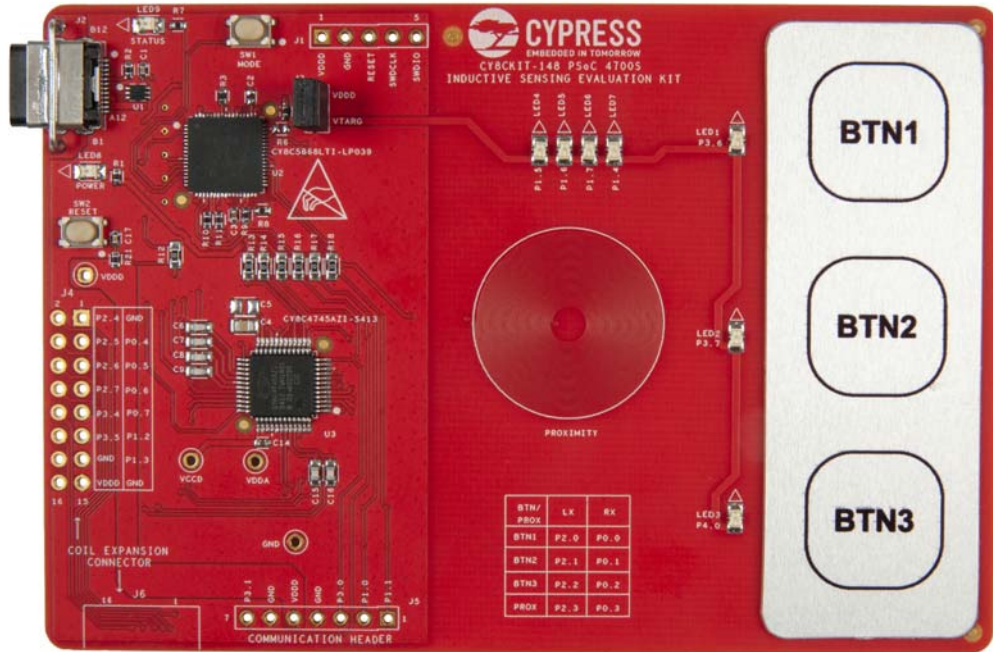
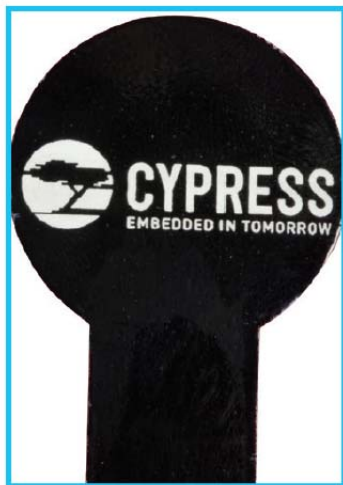

Figure 1-2. Metal Target





## 1.2 PSoC Creator

PSoC Creator™ is a state-of-the-art, easy-to-use integrated design environment (IDE). It introduces revolutionary hardware and software co-design, powered by a library of pre-verified and pre-characterized PSoC Components. With PSoC Creator, you can:

1. Drag and drop Components to build your hardware system design in the main design workspace.
2. Co-design your application firmware with the PSoC hardware.
3. Configure Components using configuration tools.
4. Explore the library of 100+ Components.
5. Review Component datasheets.

Figure 1-3. PSoC Creator Features

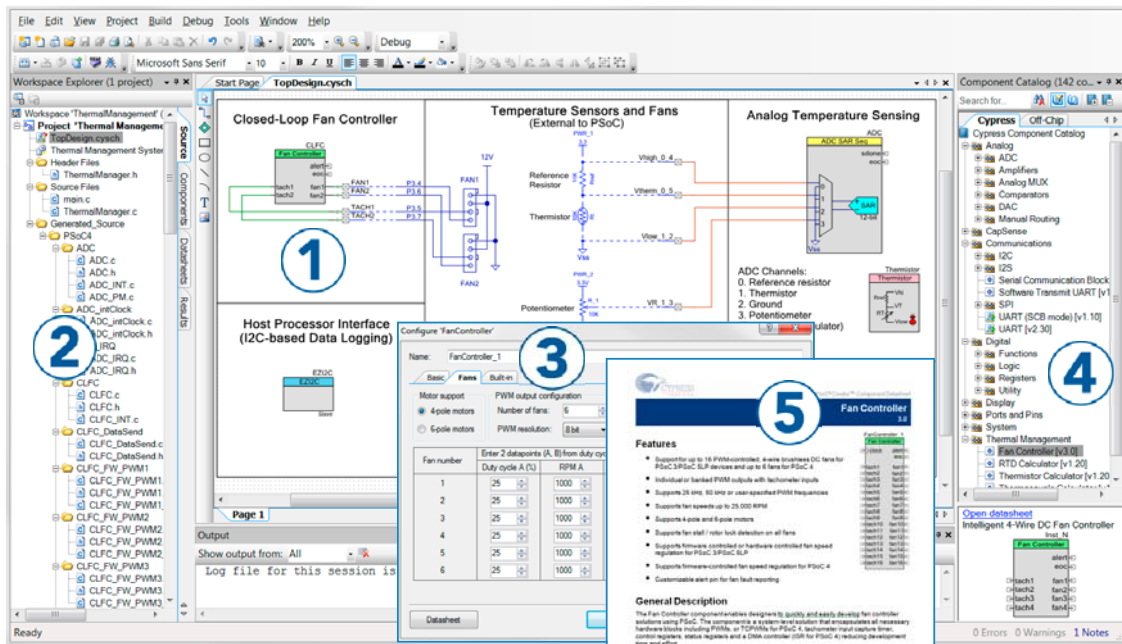

PSoC Creator also enables you to tap into an entire tool ecosystem with integrated compiler chains and programmers for PSoC devices.

For more information, visit [www.cypress.com/psoccreator](http://www.cypress.com/psoccreator). Visit the [PSoC Creator Video Training Page](#) for video tutorials on learning and using PSoC Creator.

## 1.2.1 PSoC Creator Code Examples

PSoC Creator includes a large number of code examples. These examples are available from the PSoC Creator Start Page, as shown in [Figure 1-4](#) or from the menu **File > Code Example...**

Code examples can speed up your design process by starting you off with a complete design, instead of a blank page. The code examples also show how PSoC Creator Components can be used for various applications. Code examples and documentation are included, as shown in [Figure 1-5 on page 11](#).

From the **Find Code Example** dialog shown in [Figure 1-5 on page 11](#), you can:

- Filter for examples based on architecture or device family, that is, PSoC 3, PSoC 4, or PSoC 5LP, project name, or keyword.
- Select from the list of examples offered based on the **Filter Options**.
- Review the code example's description (on the **Documentation** tab).
- Review the code from the **Sample Code** tab. You can copy the code from this window and paste to your project, which can help speed up code development.
- Create a new project (and a new workspace if needed) based on the selection. This can speed up your design process by starting you off with a complete, basic design. You can then adapt that design to your application.

Figure 1-4. Code Examples in PSoC Creator

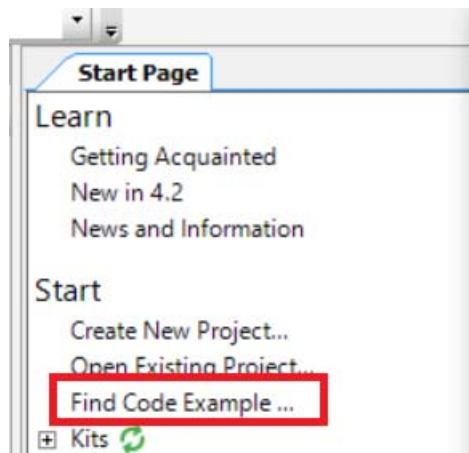
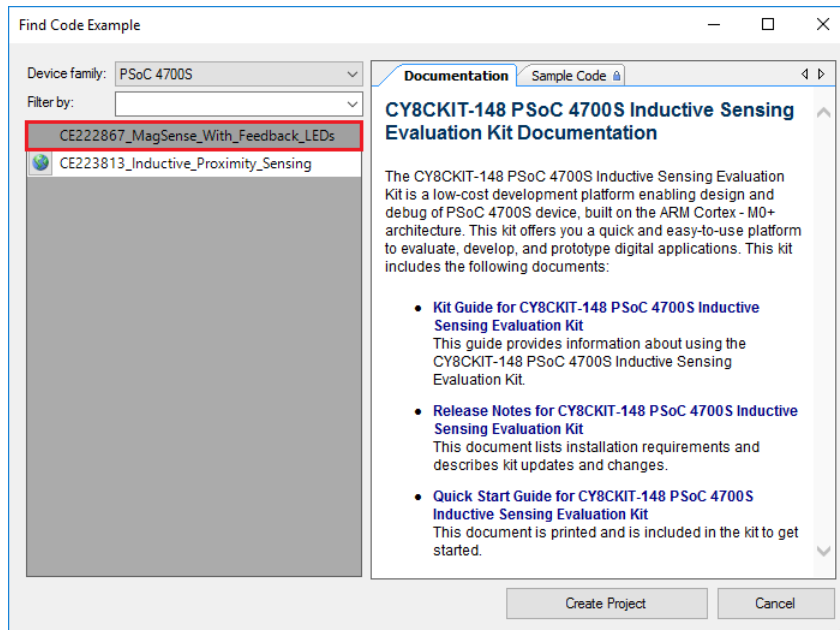

Figure 1-5. Code Example Projects with Sample Code



## 1.2.2 Kit Code Examples

You can access the installed kit code examples from the PSoC Creator Start Page. To access these examples, expand **Kits** under **Start**; then, expand the specific kit to see the code examples. For a list of code examples that you can use on this kit, see [Code Examples chapter on page 28](#).

## 1.2.3 PSoC Creator Help

Launch PSoC Creator and navigate to the following items:

- **Quick Start Guide:** Choose **Help > Documentation > Quick Start Guide**. This guide gives you the basics for developing PSoC Creator projects.
- **Simple Component Code Examples:** Choose **File > Code Example**. These examples demonstrate how to configure and use PSoC Creator Components. To access examples related to a specific Component, right-click the Component in the schematic or in the Component Catalog. Select **Find Code Example** in the context menu that appears.
- **System Reference Guide:** Choose **Help > System Reference Guides**. This guide lists and describes the system functions provided by PSoC Creator.

## 1.2.4 Component Datasheets

Right-click a Component and select **Open Datasheet** (see [Figure 1-6](#)).

Figure 1-6. Opening Component Datasheet

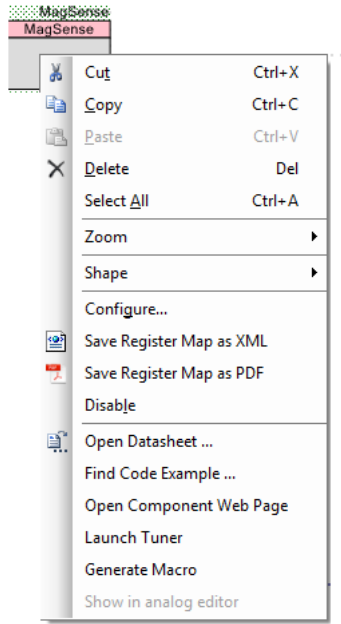

## 1.3 Getting Started

This guide will help you get acquainted with the PSoC 4700S Inductive Sensing Evaluation Kit:

- The [Software Installation chapter on page 16](#) describes the installation of the kit software. This includes installation of the PSoC Creator IDE for development and debugging the applications, and PSoC Programmer for programming hex files.
- The [Kit Operation chapter on page 22](#) describes the major features of the PSoC 4700S Inductive Sensing Evaluation Kit and functionalities such as programming, debugging, and the USB-UART and USB-I2C bridges.
- The [Code Examples chapter on page 28](#) describes multiple code examples that will help you understand how to create your own PSoC 4700S projects.
- The [Appendix chapter on page 35](#) describes the hardware content of the kit and the hardware operation, Kit Schematics, and the bill of materials (BOM).

## 1.4 Additional Learning Resources

Cypress provides a wealth of data at [www.cypress.com](http://www.cypress.com) to help you select the right PSoC device for your design, and to help you quickly and effectively integrate the device into your design. For a comprehensive list of resources, see [KBA86521](#), [How to Design with PSoC 3, PSoC 4, and PSoC 5LP](#). The following is an abbreviated list for PSoC 4:

- Overview: [PSoC Portfolio](#) and [PSoC Roadmap](#).
- Product Selectors: [PSoC 4 Product Selector](#). In addition, [PSoC Creator](#) includes a device selection tool.
- Datasheets: Describe and provide electrical specifications for the [PSoC 4000](#), [PSoC 4100](#), [PSoC 4200](#), [PSoC 4100M](#), [PSoC 4200M](#), [PSoC 4200L](#), [PSoC 4100S Plus](#) and [PSoC 4700S](#) devices.
- [CapSense Design Guide](#): Learn how to design capacitive touch-sensing applications with the PSoC 4 and PSoC Analog Coprocessor family of devices.
- [Inductive Sensing Design Guide](#): Learn how to design inductive sensing applications with the PSoC 4 family of devices.
- [Application Notes](#) and [Code Examples](#): Cover a broad range of topics, from basic to advanced. Many of the application notes include code examples. Visit the [PSoC 3/4/5 Code Examples](#) webpage for a list of all available PSoC Creator code examples. To access code examples from within PSoC Creator, see [PSoC Creator Code Examples on page 10](#).
- [Technical Reference Manuals \(TRM\)](#): Provide detailed descriptions of the architecture and registers in each PSoC 4 device family.
- [Development Kits](#):
  - [CY8CKIT-041](#), [CY8CKIT-046](#), [CY8CKIT-044](#), [CY8CKIT-042](#), and [CY8CKIT-040](#) are easy-to-use and inexpensive development platforms. These kits include connectors for Arduino™ compatible shields and Digilent Pmod Peripheral Modules.
  - [CY8CKIT-043](#), [CY8CKIT-049](#), [CY8CKIT-145](#), [CY8CKIT-146](#), and [CY8CKIT-149](#) are very low-cost prototyping platforms for sampling PSoC 4 devices.
  - [CY8CKIT-001](#) is a common development platform for all PSoC family devices.
  - The [MiniProg3](#) device provides an interface for flash programming and debug.
- [Knowledge Base Articles \(KBAs\)](#): Provide design and application tips from experts on using the device.
- PSoC Creator Training: Visit [www.cypress.com/go/creatorstart/creatortraining](http://www.cypress.com/go/creatorstart/creatortraining) for a comprehensive list of video training on PSoC Creator.
- Learning from Peers: Visit [community.cypress.com/welcome](http://community.cypress.com/welcome) to meet enthusiastic PSoC developers discussing the next-generation embedded systems on Cypress Developer Community Forums.

## 1.5 Technical Support

For assistance, visit [Cypress Support](#) or contact customer support at +1 (800) 541-4736 Ext. 3 (in the USA) or +1 (408) 943-2600 Ext. 3 (International).

You can also use the following support resources if you need quick assistance:

- [Self-help \(Technical Documents\)](#)
- [Local Sales Office Locations](#)

## 1.6 Document Conventions

Table 1-1. Document Conventions for Guides

Convention	Usage
Courier New	Displays file locations, user entered text, and source code: C:\...cd\icc\
<i>Italics</i>	Displays file names and reference documentation: Read about the <i>sourcefile.hex</i> file in the <i>PSoC Creator User Guide</i> .
[ <b>Bracketed, Bold</b> ]	Displays keyboard commands in procedures: <b>[Enter]</b> or <b>[Ctrl] [C]</b>
File > Open	Represents menu paths: File > Open > New Project
<b>Bold</b>	Displays commands, menu paths, and icon names in procedures: Click the <b>File</b> icon and then click <b>Open</b> .
Times New Roman	Displays an equation: $2 + 2 = 4$
Text in gray boxes	Describes Cautions or unique functionality of the product.

## 1.7 Acronyms

Table 1-2. Acronyms Used in this Document

Acronym	Description
ADC	Analog-to-Digital Converter
BCP	Bridge Control Panel
BLE	Bluetooth Low Energy
BOM	Bill of Materials
CE	Code Example
CMOD	Modulator Capacitor
CMP	Comparator
CTANK	Shield tank capacitor
DAC	Digital to Analog Converter
DPDT	Double-Pole, Double-Throw
ECO	External Crystal Oscillator
ESD	Electrostatic Discharge
GPIO	General Purpose Input/Output
I2C	Inter-Integrated Circuit
IDAC	Current DAC
IDE	Integrated Design Environment
KBA	Knowledge Based Article
LED	Light-Emitting Diode
PSoC	Programmable Systems-on-Chip
SAR	Successive Approximation Register
SCB	Serial Communication Block
SRAM	Static Random Access Memory
SWD	Serial Wire Debug
TCPWM	Timer, Counter, Pulse Width Modulator
UART	Universal Asynchronous Receiver Transmitter
USB	Universal Serial Bus
WCO	Watch Crystal Oscillator

## 2. Software Installation



This chapter describes the steps to install the software tools and packages on a PC for using the PSoC 4700S Inductive Sensing Evaluation Kit. This includes the IDE on which the projects will be built and used for programming.

**Note:** Latest MagSense™ component needs to be installed manually before starting any code example related to Inductive Sensing. Please refer [Installing the MagSense Component on page 20](#) for more details.

### 2.1 Before You Begin

To install Cypress software, you will require administrator privileges. However, they are not required to run the software that is already installed. Before you install the kit software, close any other Cypress software that is currently running.

### 2.2 Install Software

Follow these steps to install the PSoC 4700S Inductive Sensing Evaluation kit software:

1. Download the PSoC 4700S Inductive Sensing Evaluation kit software from [www.cypress.com/CY8CKIT-148](http://www.cypress.com/CY8CKIT-148). The kit software is available in three formats for download.
  - a. **CY8CKIT-148 Kit Only:** This executable file installs only the kit contents, which include kit code examples, hardware files, and user documents. This package can be used if all software prerequisites (listed in step 5) are installed on your PC.
  - b. **CY8CKIT-148 Kit Setup:** This installation package contains the files related to the kit including PSoC Creator and PSoC Programmer. However, it does not include the Windows Installer or Microsoft .NET framework packages. If these packages are not on your PC, the installer will direct you to download and install them from the Internet.
  - c. **CY8CKIT-148 DVD ISO:** This file is a complete package stored in a DVD-ROM image format that you can use to create a DVD or extract using an ISO extraction program such as WinZip or WinRAR. The file can also be mounted like a virtual CD/DVD using virtual drive programs such as Virtual CloneDrive and MagicISO. This package includes all required software, utilities, drivers, hardware files, and user documents.
2. If you have downloaded the ISO file, mount it on a virtual drive. Extract the ISO contents if you do not have a virtual drive to mount. Double-click *cyautorun.exe* in the root directory of the extracted content or mounted ISO if “Autorun from CD/DVD” is not enabled on the PC. The installation window will appear automatically.

**Note:** If you are using the Kit Setup or Kit Only file, then go to step 4 for installation.



3. Click **Install CY8CKIT-148 Kit** to start the kit installation as shown in [Figure 2-1](#).

Figure 2-1. Kit Installer Screen



4. Select the directory in which you want to install the PSoC 4700S Inductive Sensing Evaluation Kit-related files. Click **Next**.

When you click **Next**, the PSoC 4700S Inductive Sensing Evaluation kit installer automatically installs the required software, if it is not present on your PC. Following are the required software:

- a. PSoC Creator 4.2 or later: This software is available for download separately at [www.cypress.com/psoccreator](http://www.cypress.com/psoccreator).
- b. PSoC Programmer 3.27.1 or later: This is installed as part of PSoC Creator installation ([www.cypress.com/programmer](http://www.cypress.com/programmer)).

- Choose the **Typical**, **Custom**, or **Complete** installation type in the Product Installation Overview window, as shown in [Figure 2-2](#). Click **Next**.

**Note:** Typical installation is recommended, however you can choose according to your requirement.

Figure 2-2. Product Installation Overview

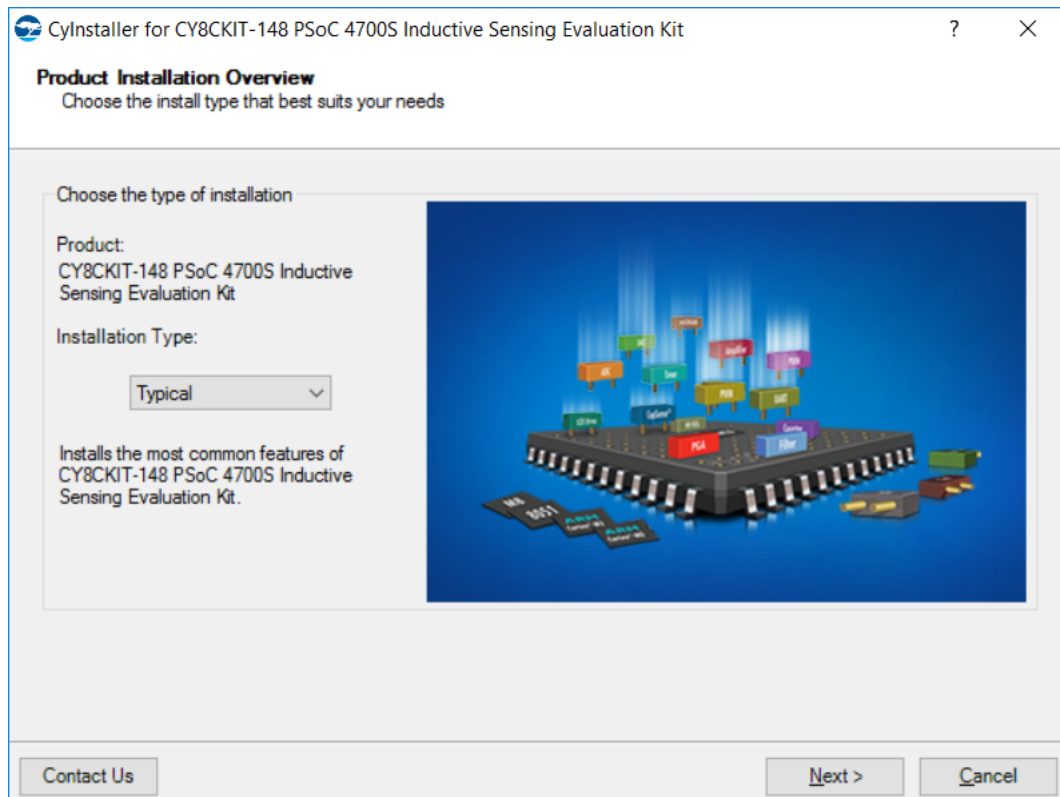

- Read the License agreement and select **I accept the terms in the license agreement** to continue with the installation. Click **Next**. When the installation begins, a list of packages appears on the installation page. A green check mark appears next to each package after successful installation.
- Enter your contact information or select the check box **Continue Without Contact Information**. Click **Finish** to complete the PSoC 4700S Inductive Sensing Evaluation kit installation.

After the installation is complete, the kit contents are available at the following location:

<Install\_Directory>\CY8CKIT-148 PSoC 4700S Inductive Sensing Evaluation Kit

Default location:

Windows OS (64-bit):

C:\Program Files (x86)\Cypress\CY8CKIT-148 PSoC 4700S Inductive Sensing Evaluation Kit

Windows OS (32-bit):

C:\Program Files\Cypress\CY8CKIT-148 PSoC 4700S Inductive Sensing Evaluation Kit

**Note:** For Windows 7/8/8.1 and later users, the installed files and the folder are read-only. To use the installer code examples, follow the steps outlined in the [Code Examples chapter on page 28](#).

## 2.3 Installing PSoC 4700S Device in PSoC Creator

Below steps need to be followed in order to install PSoC 4700S device into PSoC Creator.

1. Run PSoC Creator 4.2.
2. Go to **Tools > Find new devices** in PSoC Creator. The Device Update Installer window will pop-up.

Figure 2-3. Device Update Installer

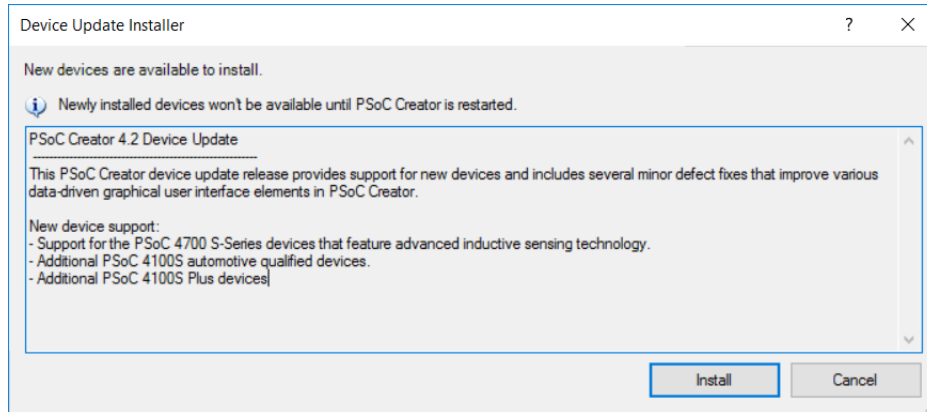

3. Click on the **Install** Button.
4. **Restart PSoC Creator.** Note that this is an important step. The devices will only be available after PSoC Creator is restarted.

The devices should now be available in the device selector when you create a new project.

From the dropdown list, select **PSoC 4700S**.

Figure 2-4. Device Selection

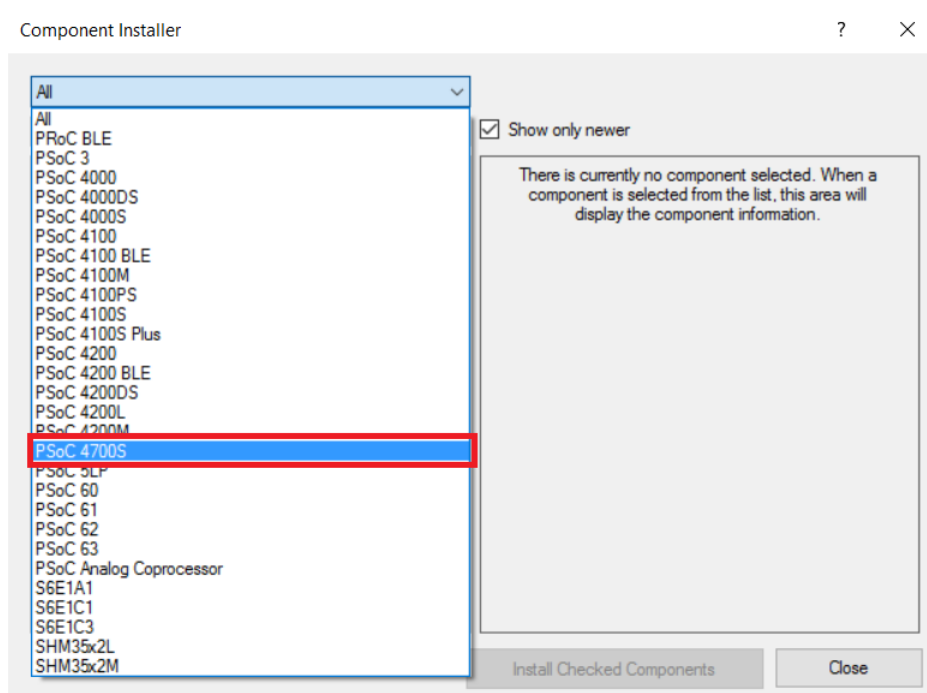

## 2.4 Installing the MagSense Component

To install the MagSense Component, Click **Tools > Find new components**. Figure 2-5 shows this step.

**Note:** This step is mandatory for kit examples to work.

Figure 2-5. Tools Tab for finding New Components

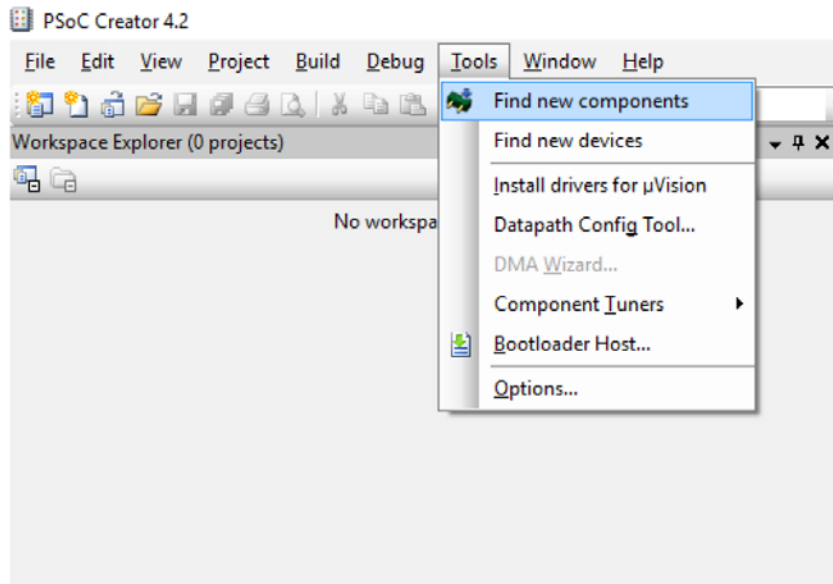

Select the MagSense Component and click **Install Checked Components**. This will install the MagSense Component in your software.

**Note:** You can skip this step if the MagSense Component is pre-installed in PSoC Creator.

Figure 2-6. Component Installation

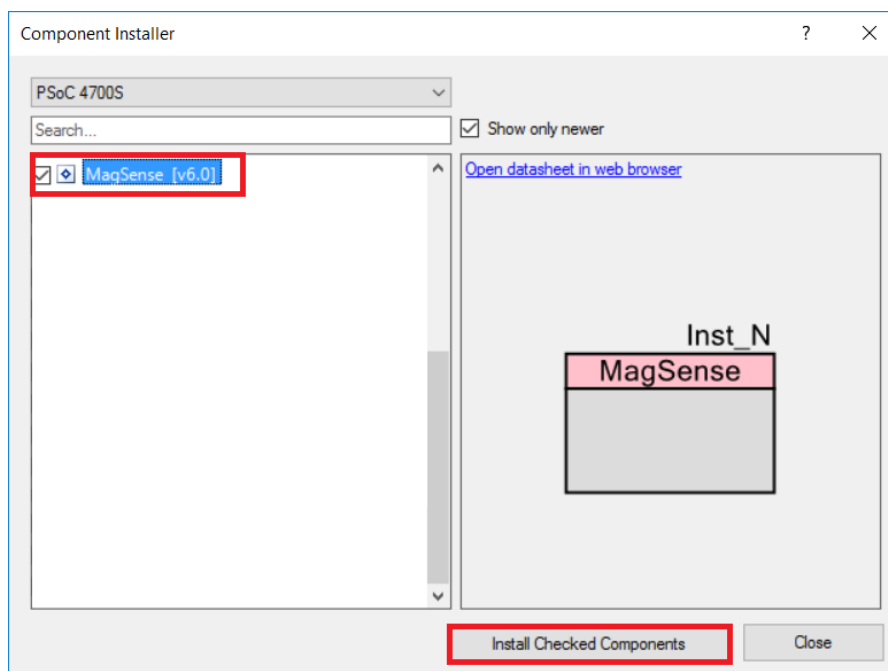

## 2.5 Uninstall Software

The software can be uninstalled using one of the following methods:

1. Go to **Start > All Programs > Cypress > Cypress Update Manager** and select **Uninstall**.
2. Go to **Start > Control Panel > Programs and Features for Windows 7** or **Add/Remove Programs for Windows XP** and select **Uninstall/Change**.

## 3. Kit Operation



This chapter introduces you to different features of the PSoC 4700S Inductive Sensing Evaluation Kit. This primarily includes the programming and debugging functionalities, KitProg2 USB-UART and USB-I2C bridges, and the procedure to update the KitProg2 firmware.

### 3.1 Theory of Operation

Figure 3-1 shows the block diagram for the PSoC 4700S Inductive Sensing Evaluation Kit.

Figure 3-1. Block Diagram of PSoC 4700S Inductive Sensing Evaluation Kit

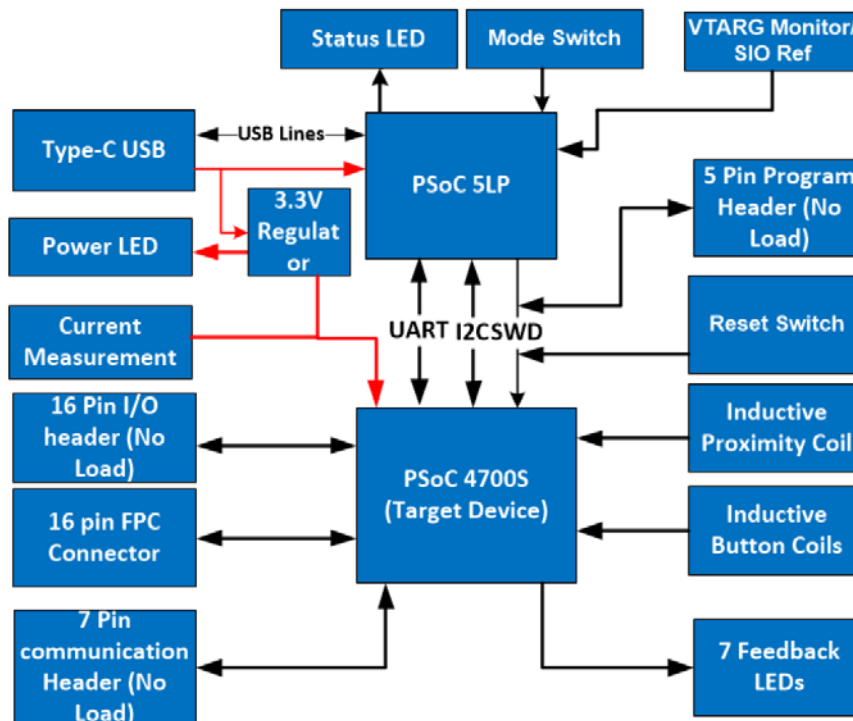

The PSoC 4700S Inductive Sensing Evaluation Kit is simplistic in design and focuses on providing you with complete access to develop applications using the PSoC 4700S device. This kit supports the following features:

- **PSoC 4700S I/O Headers:** The PSoC 4700S Inductive Sensing Evaluation board brings all important GPIOs of the target PSoC 4700S device to the expansion header/connector. This provides maximum access to the capabilities of the PSoC 4700S device.
- **Feedback LEDs:** The onboard LEDs, LED1 to LED7 can be used to display outputs from the PSoC 4700S device.

- **Three Inductive Sensing Button Coils:** Three Inductive Sensing button coils are provided on the kit. To evaluate the button coils, a metal overlay has been placed on top of them.
- **Reset Button:** This button is used to reset the PSoC 4700S device when pressed.
- **Power LED:** This LED indicates power is being supplied to the board.
- **PSoC 4700S Device:** This is the target device (CY8C4745AZI-S413) on the board.
- **5-pin Programming Header:** This is an external programming header that can be used to program the PSoC 4700S device using a MiniProg3. Typically this connection is not required since the kit contains an integrated KitProg2.
- **Current Measurement Jumper:** Using this jumper (J3), you can measure the current consumed by the PSoC 4700S device. This jumper is populated by default. You must remove the jumper and measure current using an ammeter.
- **USB Type-C Connector:** Using this USB Type-C connector (J2), you can connect the kit to a PC using USB Type-A to Type-C Cable.
- **PSoC 5LP:** This is an onboard programmer/debugger utilizing a PSoC 5LP (CY8C5868LTI-LP039), which enables you to program and debug the target PSoC 4700S device. It can also act as a USB-UART and UART-I2C bridge.
- **KitProg2 Mode Selection Switch:** This button is used to switch between the KitProg2 modes as shown in [Table 3-1](#). You can also use this button to provide an input to the PSoC 5LP in custom applications. Note that the switch connects the PSoC 5LP pin to ground when pressed. For more details, see the [KitProg2 User Guide](#).
- **KitProg2 Status LED:** This LED gives the programming/mode status of KitProg2.  
**Note:** Press mode switch SW1 to toggle between programming modes.

Table 3-1. KitProg2 Mode Switching

KitProg2 Programming Modes <sup>a</sup>	Status LED (LED9)
KitProg2 Program/Debug Mode (PPCOM mode) (default)	ON
CMSIS-DAP Programming Mode	OFF

a. Toggling between programming modes can be done by pressing mode switch SW1.



## 3.2 Programming and Debugging the Target PSoC 4700S Device

The target PSoC 4700S device can be programmed and debugged using the KitProg2. Before programming the device, make sure that PSoC Creator and PSoC Programmer software are installed on the PC. See [Install Software on page 16](#) for more information.

### 3.2.1 Programming Using PSoC Creator

1. Connect the Evaluation board to the PC through the USB Type-C Connector(J2) as shown in [Figure 3-2](#). The kit enumerates as a composite device. If you are plugging in the PSoC 4700S Evaluation Kit to your PC for the first time, the kit drivers will be installed automatically. The amber status LED (LED9) will turn ON to indicate successful enumeration. If the amber status LED (LED9) is OFF, press and release the Mode switch to change modes. If the amber LED still does not turn on, see the [KitProg2 User Guide](#) for details on the KitProg2 status and troubleshooting instructions.

Figure 3-2. Connecting the PSoC 4700S Evaluation Kit to a Computer

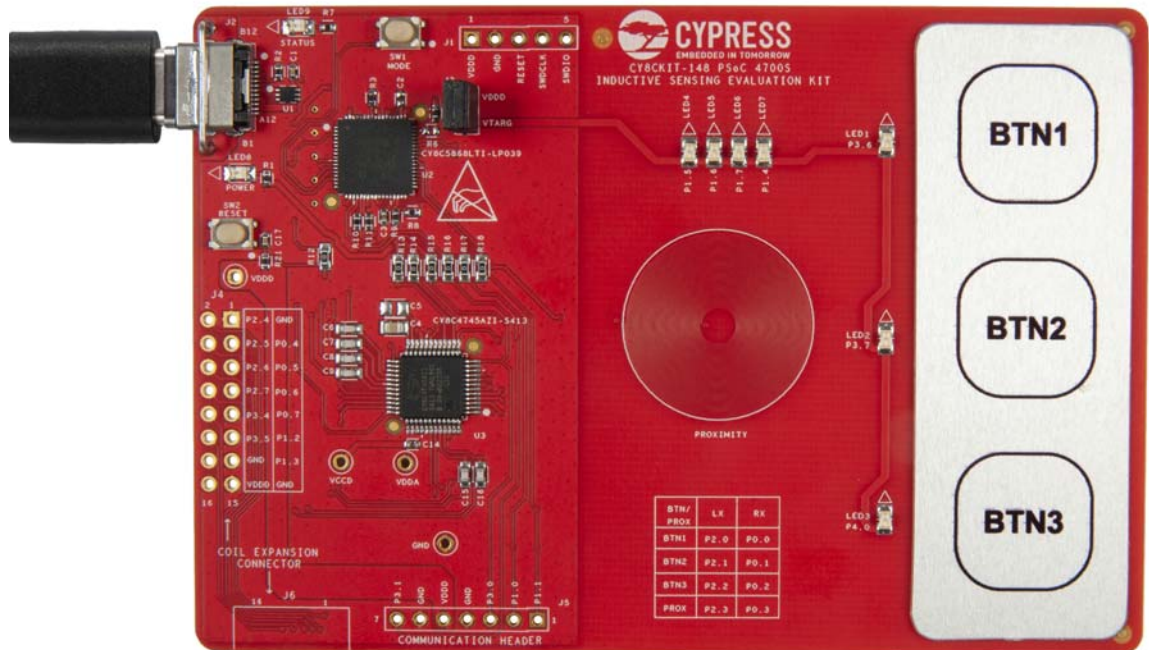

2. Open the desired project in PSoC Creator. From the PSoC Creator, go to **File > Open > Project/Workspace**. You can browse and open an existing project. If you want to open one of the code examples provided with the kit, follow the instructions in the [Code Examples chapter on page 28](#).



3. Select the option **Build > Build <Project\_Name>** or press **[Shift] [F6]** to build the project as shown in [Figure 3-3](#).

Figure 3-3. Build a Code Example

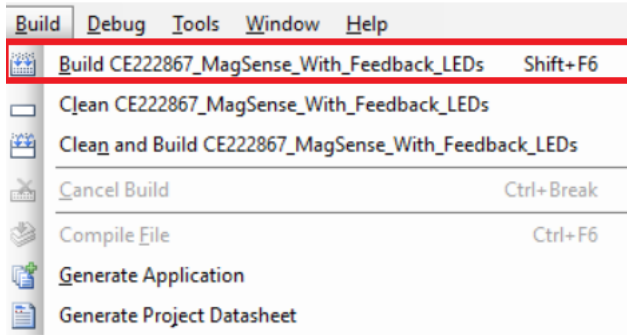

4. If there are no errors during build, program the firmware onto the kit by choosing **Debug > Program** or press **[Ctrl] [F5]**, as shown in [Figure 3-4](#). This programs the target PSoC 4700S device on the PSoC 4700S Evaluation Kit, and the kit is ready to use.

Figure 3-4. Program Device in PSoC Creator

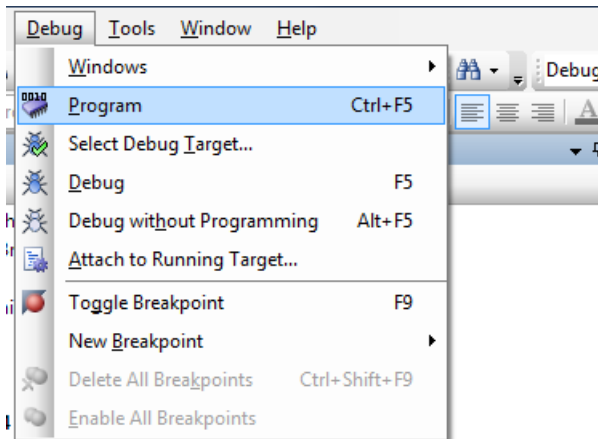

### 3.2.2 Debugging Using PSoC Creator

For debugging the project using PSoC Creator, follow steps 1–3 from [Programming Using PSoC Creator on page 24](#) followed by these steps:

1. Click the **Debug** icon  or press **[F5]**. Alternatively, you can use the option **Debug > Debug**.
2. Once the PSoC Creator opens in Debug mode, use the buttons on the toolbar to debug your application.

For more details on using the debug features, see section 3.3 of the [KitProg2 User Guide](#).

### 3.2.3 Programming Using PSoC Programmer

PSoC Programmer (3.27.1 or later) can be used to program existing *.hex* files into the PSoC 4700S Evaluation Kit. For a detailed explanation on how to program using PSoC Programmer, see the **Programming Using PSoC Programmer** section in the [KitProg2 User Guide](#).

### 3.2.4 Mass Storage Programming

**Note:** Mass Storage Programming is not supported in this kit. CMSIS-DAP programming mode is supported in this kit.

## 3.3 USB-UART Bridge

The KitProg2 on the PSoC 4700S Evaluation Kit can act as a USB-UART bridge. The UART lines between the KitProg2 and the target are hard-wired on the board, with UART\_RX assigned to **P3[0]** and UART\_TX assigned to **P3[1]** on target PSoC 4700S device. For more details on the KitProg2 USB-UART functionality, see the **USB-UART Bridge** section in the [KitProg2 User Guide](#).

Figure 3-5. UART Connection between KitProg2 and PSoC 4700S Device

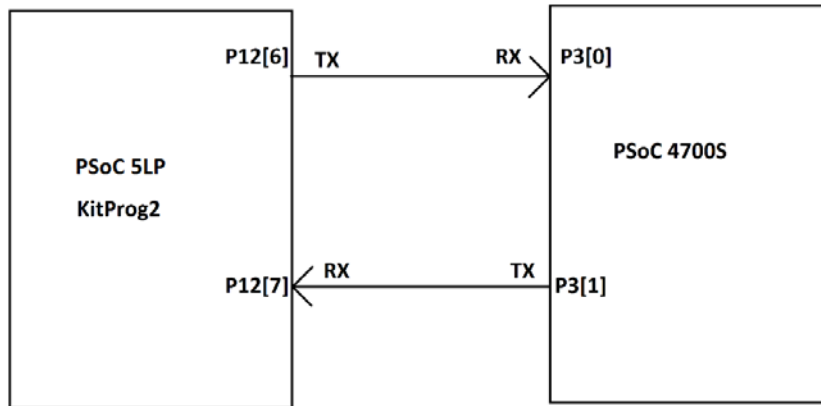

### 3.4 USB-I2C Bridge

The KitProg2 can function as a USB-I2C bridge and can communicate with the software utility Bridge Control Panel (BCP). The BCP is installed as part of the installation package for the kit. The I2C lines on the target PSoC 4700S device are **P1[1] (SDA)** and **P1[0] (SCL)**, which are hardwired on the board to the I2C lines of the KitProg2. The USB-I2C supports I2C speeds of 50 kHz, 100 kHz, 400 kHz, and 1 MHz. For more details on the KitProg2 USB-I2C functionality, see the **USB-I2C Bridge** section in the [KitProg2 User Guide](#).

Figure 3-6. I2C Connection between KitProg2 and PSoC 4700S Device

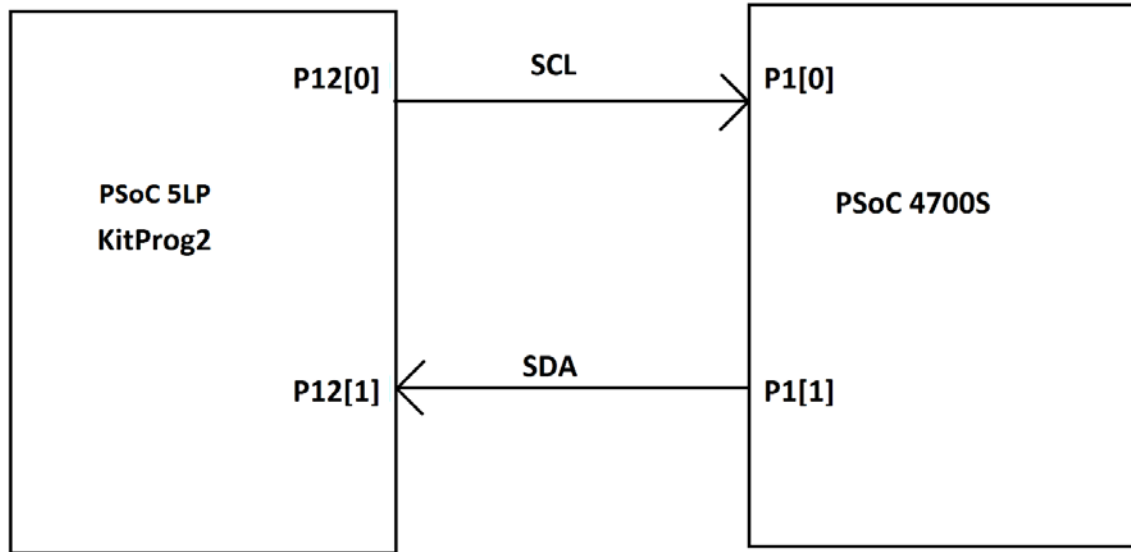

### 3.5 Updating the KitProg2 Firmware

The KitProg2 firmware normally does not require any update. You can use the PSoC Programmer software to update the KitProg2 firmware if necessary. For a detailed explanation on how to update the KitProg2 firmware, see **Updating the KitProg2 Firmware** in the [KitProg2 User Guide](#).

## 4. Code Examples



This chapter explains the code examples provided with the PSoC 4700S Inductive Sensing Evaluation Kit. To access these code examples, download and install the CY8CKIT-148 PSoC 4700S Inductive Sensing Evaluation Kit setup file from the kit web page: [www.cypress.com/CY8CKIT-148](http://www.cypress.com/CY8CKIT-148). After installation, you can access the code example from the **PSoC Creator Start Page** as shown in [Figure 4-1](#).

### 4.1 Using the Kit Code Examples

Follow these steps to open and use the code examples.

1. Launch PSoC Creator from the Windows Start menu (**Start > All Programs > Cypress > PSoC Creator <version> > PSoC Creator <version>**).
2. On the Start page, select **Start > Kits > CY8CKIT-148**. A list of code example appears as shown in [Figure 4-1](#).
3. Click the desired code example and save it at a desired location. For the remaining steps, *CE222867\_MagSense\_With\_Feedback\_LEDs.cywrk* is used as a reference.

Figure 4-1. Open Code Example from PSoC Creator

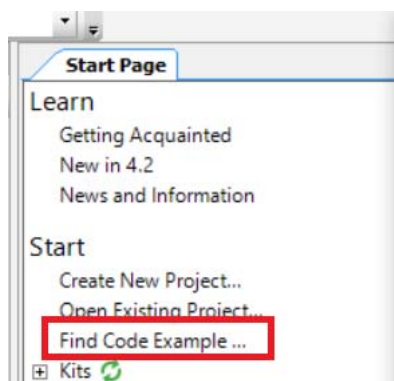

- Build the code example by choosing **Build > Build <Project Name>** as shown in [Figure 4-2](#). A `.hex` file is generated after a successful build process.

Figure 4-2. Build Code Example from PSoC Creator

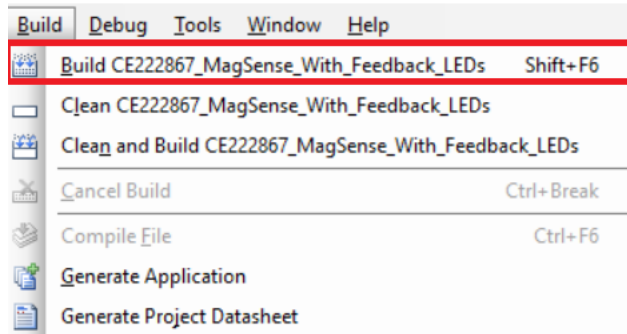

- Connect the PSoC 4700S Evaluation kit to the PC using the KitProg2 USB Type-C connector **J2** as described in [Programming Using PSoC Creator chapter on page 24](#) to program the kit with this code example. If you are connecting the kit to the PC for the first time, wait for driver installation to complete before proceeding to the next step.
- Choose **Debug > Program** in PSoC Creator as shown in [Figure 4-3](#).

Figure 4-3. Program Device in PSoC Creator

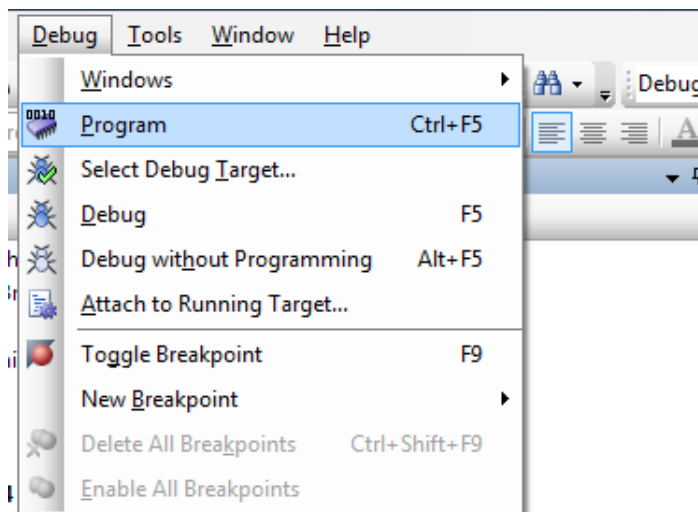

- If the device is already acquired, programming will complete automatically and the result will appear in the PSoC Creator status bar at the left bottom of the screen. If the device is yet to be acquired, the Select Debug Target window will appear. Select **KitProg2/<serial number>** and click **Port Acquire** as shown in [Figure 4-4](#).

Figure 4-4. Port Acquire

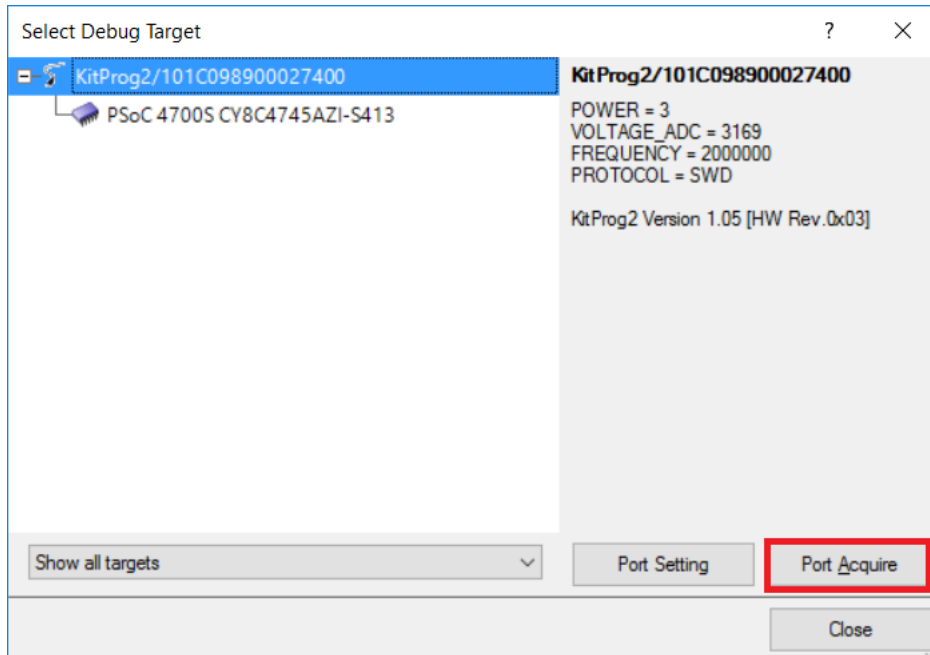

- After the device is acquired, it appears in the tree structure below the **KitProg2/<serial number>**. Select the device then click **OK / Connect** to exit the window and start programming as shown in [Figure 4-5](#).

Figure 4-5. Connect Device from PSoC Creator and Program

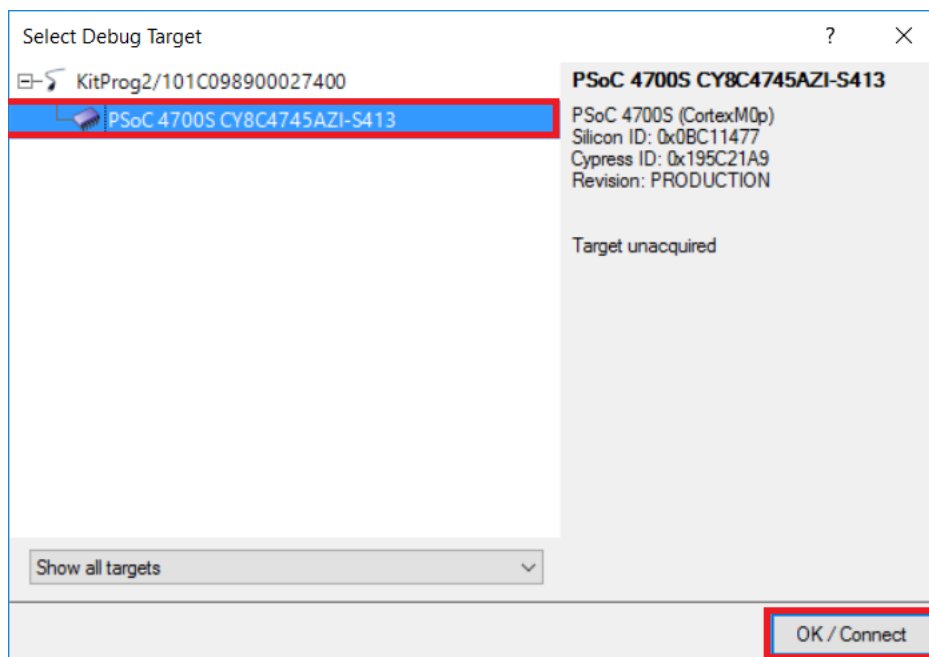

9. Code Example Operation:

This code example showcases the features of an Inductive Sensing button coils and Proximity coils in CY8CKIT-148 PSoC 4700S Inductive Sensing Evaluation Kit. This code example demonstrates the use of Inductive Sensing technology for button coils and Proximity using the PSoC 4700S device. As soon as you touch a button, the corresponding LED will glow. When you bring the metal target close to the proximity sensing coil of about 2 cm, the number of LEDs glowing on the board increases as you bring the target closer.

10. To understand detailed operation of the code example, open *CE222867\_MagSense\_With\_Feedback\_LEDs.pdf* as shown in [Figure 4-6](#).

**Note:** When you operate the button or proximity sensor for a longer duration of about two seconds, the auto-reset feature will automatically disable the button or proximity and its corresponding LED.

Figure 4-6. Project Datasheet - *CE222867\_MagSense\_With\_Feedback\_LEDs.pdf*

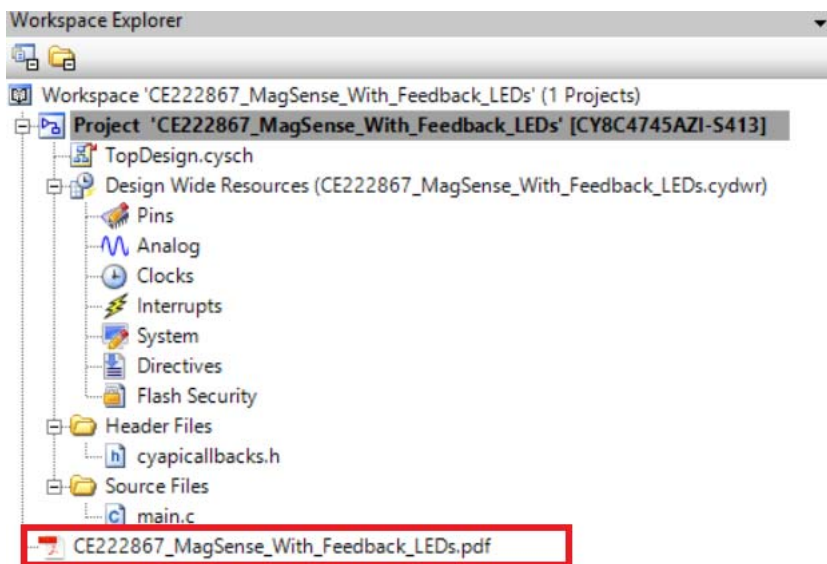

## 4.2 Using Built-in PSoC Creator Code Examples with the Kit

Follow these steps to open and use the built-in PSoC Creator examples:

1. Launch PSoC Creator from **Start > All Programs > Cypress > PSoC Creator<version> > PSoC Creator <version>**.
2. On the Start page, click **Find Code Example...** under **Start** or follow the menu **File > Code Example...** as shown in [Figure 4-7](#).

Figure 4-7. PSoC Creator Find Code Example

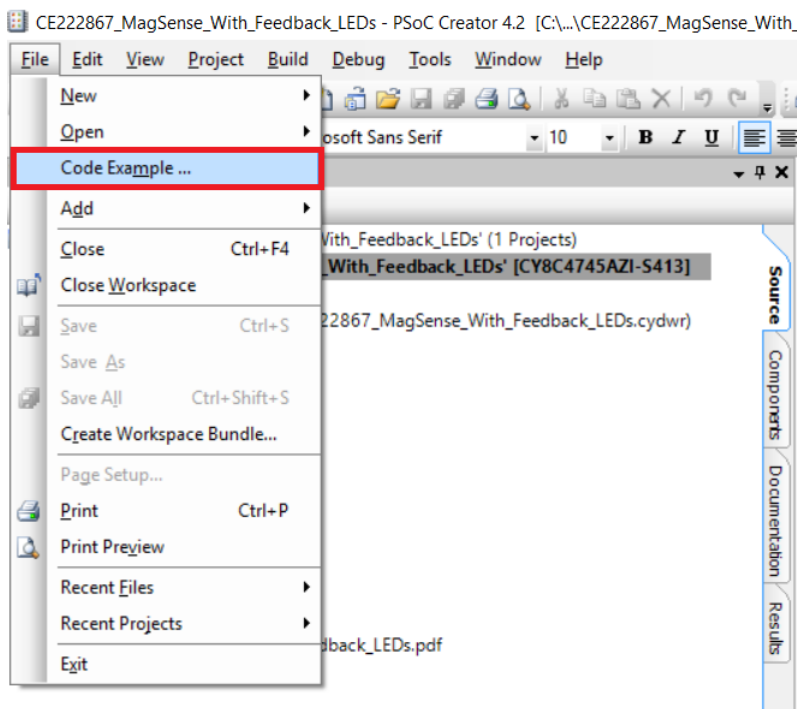



- In the Find Code Example window, set the **Device family** to **PSoC 4700S** as shown in [Figure 4-8](#).

Figure 4-8. Selecting PSoC 4700S Device in Find Code Example Window

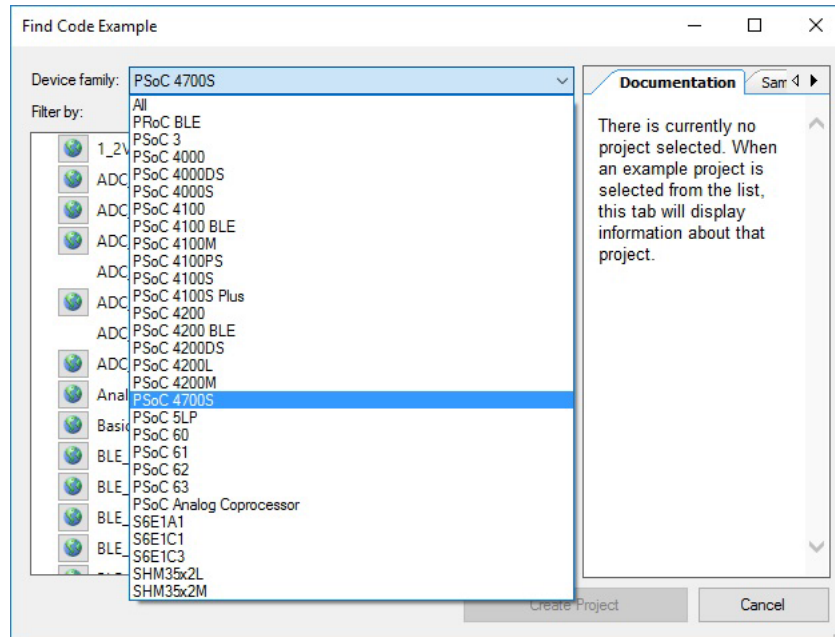

- You can select the *CE222867\_MagSense\_With\_Feedback\_LEDs* project and see how to use it with the CY8CKIT-148 kit.
- Select the *CE222867\_MagSense\_With\_Feedback\_LEDs* project and click **Create Project** as shown in [Figure 4-9](#). Save the workspace to a desired location.

**Note:** The code example that appears in PSoC Creator with the installer package is same as the code example which is extracted using these steps.

Figure 4-9. *CE222867\_MagSense\_With\_Feedback\_LEDs* Code Example

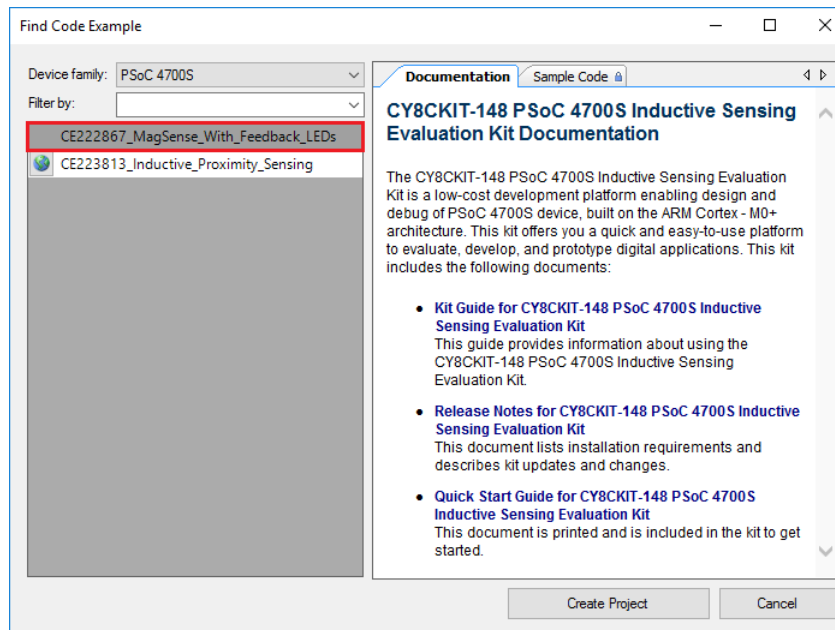

- Open *CE222867\_MagSense\_With\_Feedback\_LEDs.pdf* from the Workspace Explorer to learn more about the code example and its configuration. See [Figure 4-10](#).

Figure 4-10. Project Datasheet: *CE222867\_MagSense\_With\_Feedback\_LEDs*

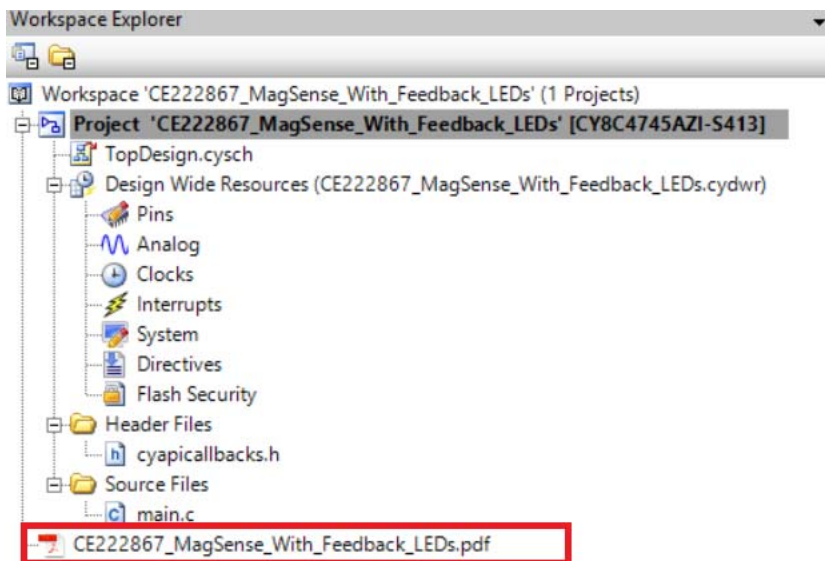

# A. Appendix



## A.1 Board Details

The PSoC 4700S Inductive Sensing Evaluation Kit consists of the following blocks:

- PSoC 4700S device (CY8C4745AZI-S413)
- PSoC 4700S I/O headers/Coil Expansion connectors J4, and J6 (FPC connector)
- Three Inductive Sensing Coil Buttons
- KitProg2 (PSoC 5LP device (CY8C5868LTI-LP039))
- SWD connection header J1
- USB Type-C connector J2
- Seven blue feedback LEDs; LED1, LED2, LED3, LED4, LED5, LED6, LED7
- One amber LED, LED9 (KitProg2 Status)
- One amber LED, LED8 (Power)
- One Push Button SW2 (Reset)
- One Push Button SW1 (KitProg2 Mode)
- Current Measurement Jumper J3

Figure A-1. PSoC 4700S Inductive Sensing Evaluation Kit Pin Details

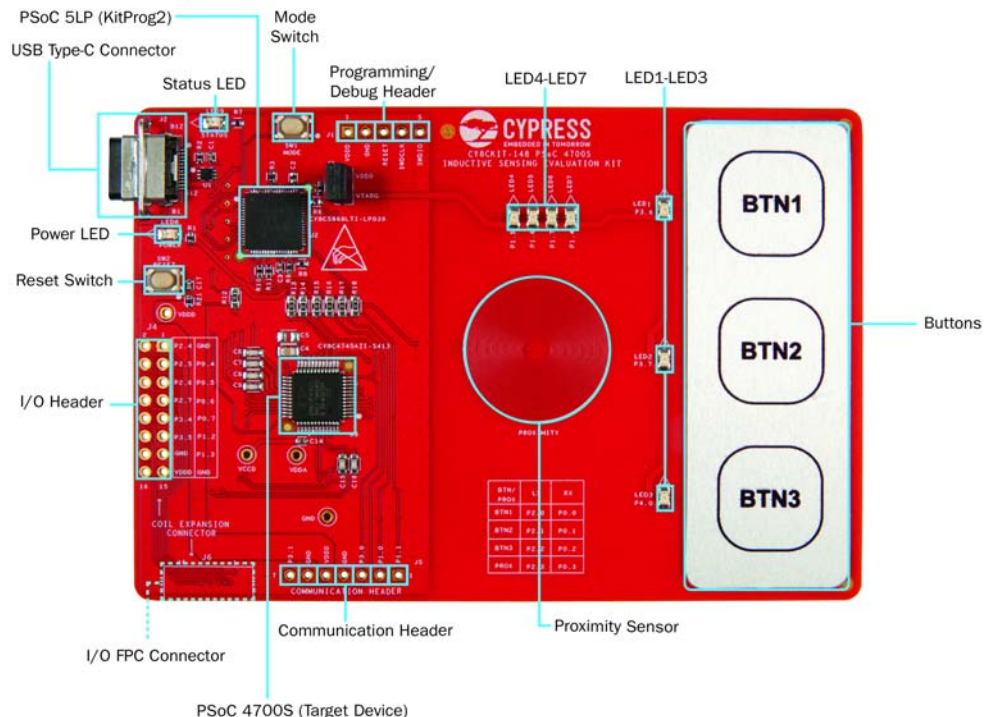

## A.2 Hardware Details

### A.2.1 Target Board

The target board uses the PSoC 4700S device. PSoC 4700S is a scalable and reconfigurable platform architecture for a family of programmable embedded system controllers with M0+ CPU. It combines programmable and reconfigurable digital blocks with flexible automatic routing. The PSoC 4700S device, based on this platform architecture, is a combination of a MCU with digital programmable logic, programmable interconnect, and standard communication and timing peripherals. PSoC 4700S will be fully compatible with members of the PSoC 4 platform for new applications and design needs. The digital subsystems allow flexibility and in-field tuning of the design. For more information, see the [PSoC 4700S webpage](#) and the [PSoC 4700S Datasheet](#).

Figure A-2. Schematic of PSoC 4700S Device (Target)

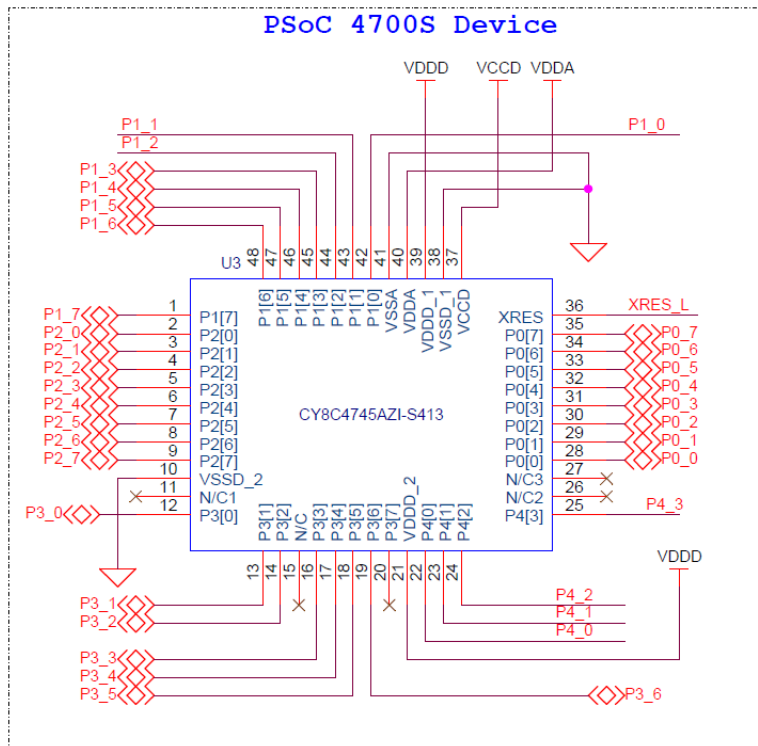

### A.2.2 KitProg2 Board

A PSoC 5LP on the KitProg2 board is used to program and debug the target PSoC 4700S device. The KitProg2 PSoC 5LP connects to the USB port of the PC through the USB Type-C connector and to the SWD interface of the target PSoC 4700S device.

Figure A-3. Schematic of PSoC 5LP (KitProg2)

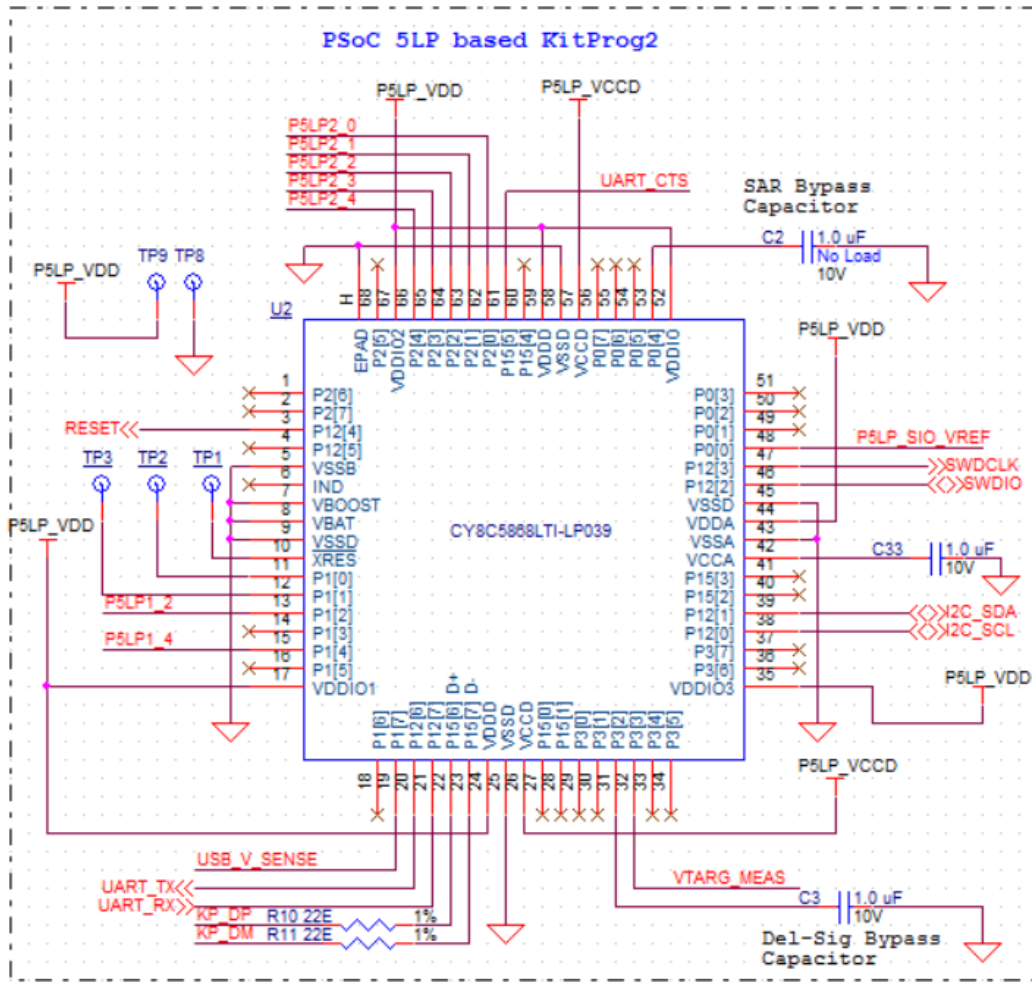

### A.2.3 Power Supply System

The power supply system on this board is dependent on a power source for most applications. You can use the 5 V supply from the USB connection to power the system. This 5 V is dropped to 3.3 V through a voltage regulator which powers the PSoC 4700S device. You can also connect an external power supply to the board for low-voltage applications. However, in this scenario it is recommended not to power the on board regulator using the USB Type C header. Also we recommend to use a low noise power supply using the VDDD testpoints for best experience with MagSense.

**Note:** A noisy power output can cause a reduction in performance of MagSense.

#### A.2.3.1 Measure PSoC 4700S Device Current Consumption

To measure the current consumption of the PSoC 4700S device, remove the jumper at J3 and connect an ammeter to it.

This method can be used either with USB power or with the power supplied to one of the VTARG pins but NOT when supplying power to one of the VDDD pins.

After measuring the current consumption, populate the jumper for normal operations.

**Note:** After removing the jumper, the system may have some leakage current due to the voltage monitoring section of kitprog2. To get rid of the leakage current completely from KitProg2, remove R26.

Figure A-4. Current Measurement

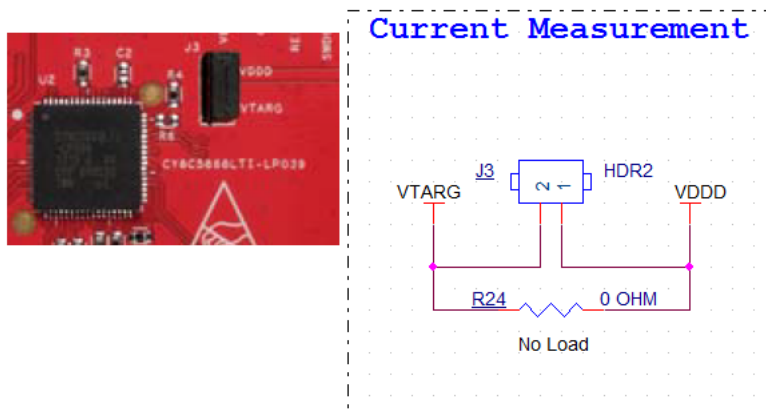

## A.2.4 Header Connections

The PSoC 4700S Inductive Sensing Evaluation Kit supports a number of unpopulated headers on both the Kit-Prog2 and the target PSoC 4700S boards.

### A.2.4.1 *Functionality of J1 Header (Programming/Debug Header)*

Header J1 is the programming header. This header can be used to program the target device using any kind of external programmer like MiniProg3.

Figure A-5. J1 Header



### A.2.4.2 *Functionality of J5 Header (Communication Header)*

These headers provide I2C/ UART communication lines. These can be used to communicate with external systems for general applications as well as debug.

Figure A-6. J5 Header



### A.2.4.3 *Functionality of Connector J2 (USB Type-C Connector)*

This connector on the kit enables you to connect the kit to the PC using USB Type-A to Type-C on J2 (USB Type-C Connector).

Figure A-7. USB Type-C Connector

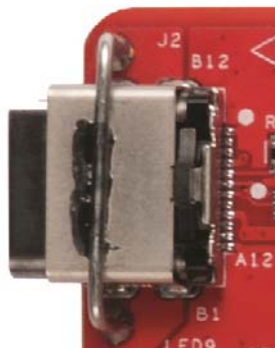



## A.2.5 User and Passive Inputs

### A.2.5.1 Reset Switch

When the Reset button is pressed, the XRES line of the PSoC 4700S device is pulled to ground, which resets the target device.

Figure A-8. Reset (RST) Switch

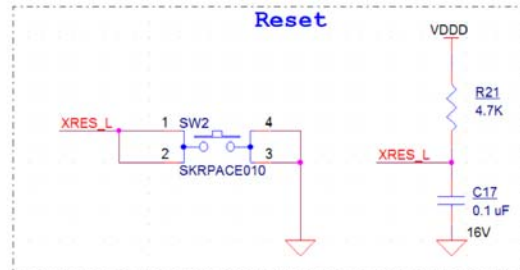

### A.2.5.2 Mode Switch (KitProg2)

The KitProg2 board contains a push button connected to P1.2 of the PSoC 5LP. When this button is pressed, it toggles between KitProg2 mode and CMSIS-DAP Mode. For more details, see the [KitProg2 User Guide](#).

Figure A-9. Mode Switch

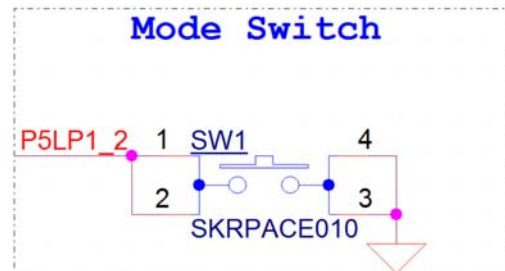



### A.2.5.3 Inductive Sensing Button Coils

Three Inductive Sensing buttons (BTN1, BTN2, and BTN3) are provided onboard to demonstrate the Inductive Sensing button functionality of the PSoC 4700S device.

**Note:** Inductive Sensing button aluminum overlay thickness of 0.5 mm and the adhesive below the aluminium (0.2 mm) is an important parameter for tuning.

Figure A-10. Inductive Sensing Button Coils and Circuit

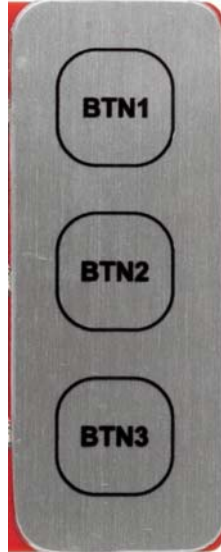

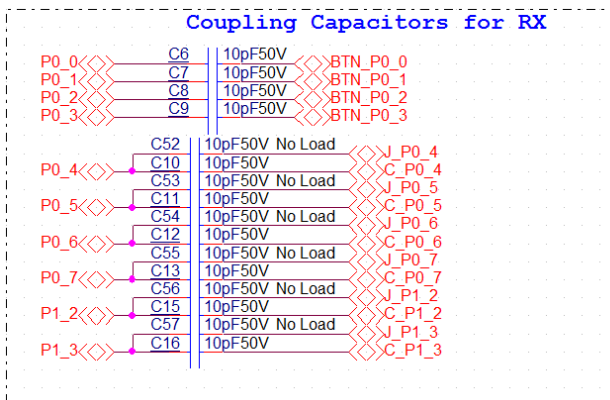
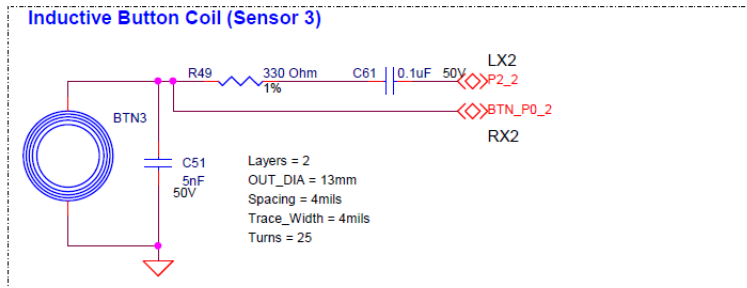
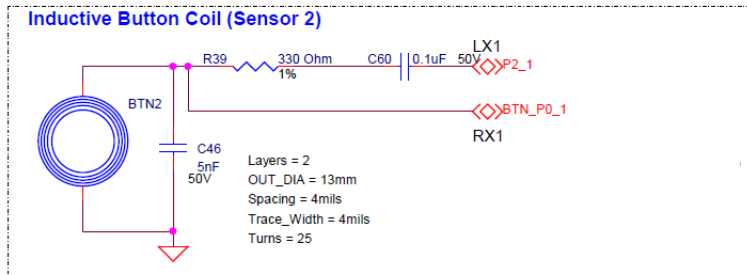
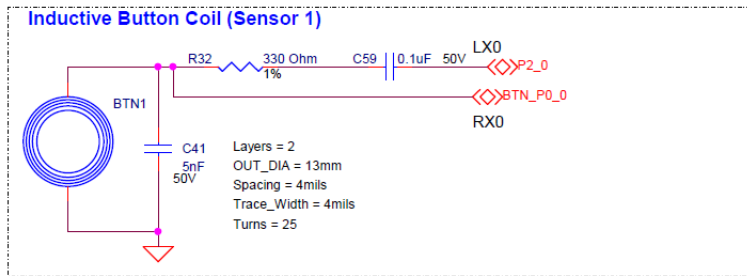

There are four components required in the MagSense configuration:

1. The tank capacitors C41, C46, and C51 are used to determine the resonant frequency of the coil. The tank capacitors are necessary components onboard.
2. The series resistors R32, R39, and R49 are used to increase or decrease the signal.
3. C59, C60, and C61 are series capacitors at the LX lines used to optimize the power consumption at VDD. These capacitors are not necessary, however they can be used for stringent power applications.
4. DC blocking capacitor at the RX pin as shown in [Figure A-10](#). This capacitor should be placed as close as possible to the device.

### Overlay design

Overlay design is a very important parameter for Inductive Sensing applications. Overlay design has three major areas to be decided:

1. Aluminum overlay thickness
2. Polycarbonate adhesive thickness
3. Cutout area of the sensor on the adhesive layer

Figure A-11 shows the mechanical dimension of the overlay and adhesive layer for this kit.

The thickness of overlay is an important parameter to decide the sensitivity of the coil response to MagSense. However, with lower thickness of overlay, the lifetime of the board reduces. 0.5 mm thickness is typically an optimal choice from a button sensitivity and lifetime point of view.

Figure A-11. Mechanical Dimension of the metal overlay

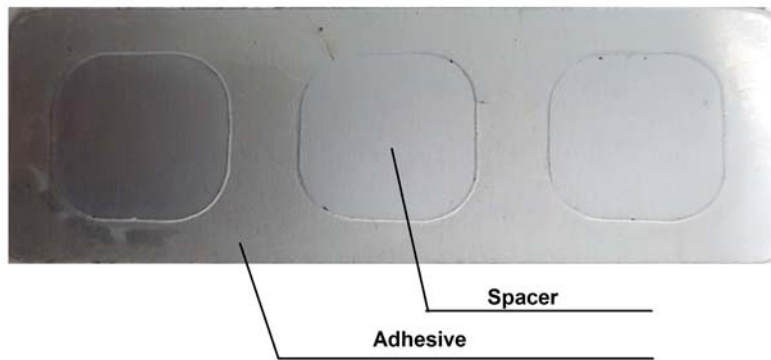
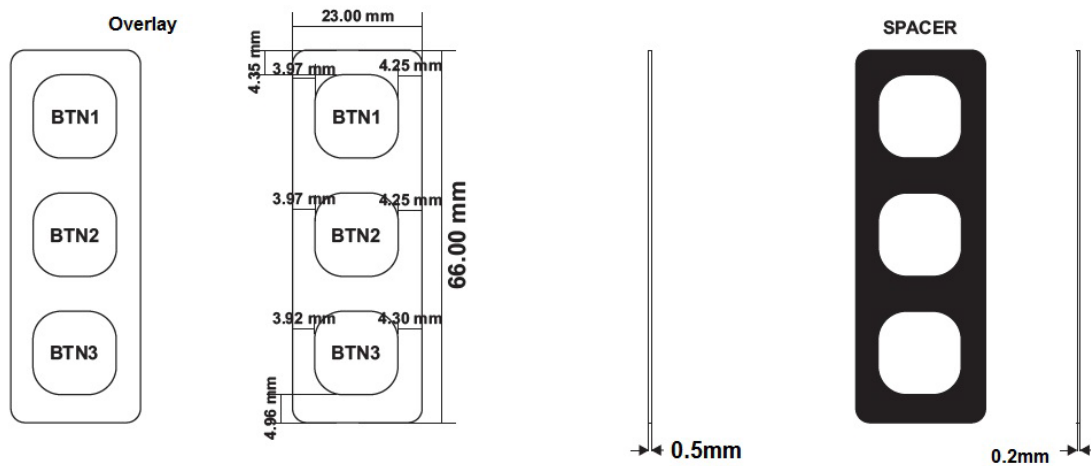

**Caution:** A higher Newton force on the overlay causes deflection throughout the overlay causing false triggering throughout the coils. User is expected to press the buttons slightly enough to get the feedback. Pressing the overlay harder can even deform the overlay.

#### A.2.5.4 Inductive Sensing Proximity Coil

An Inductive Sensing proximity coil is provided onboard to demonstrate the Inductive Sensing proximity functionality of the PSoC 4700S device. To demonstrate this feature, a metal target is provided along with the kit. The proximity sensor is triggered at around 2 cm distance from the coil.

Figure A-12. Proximity Sensor Coil and Circuit

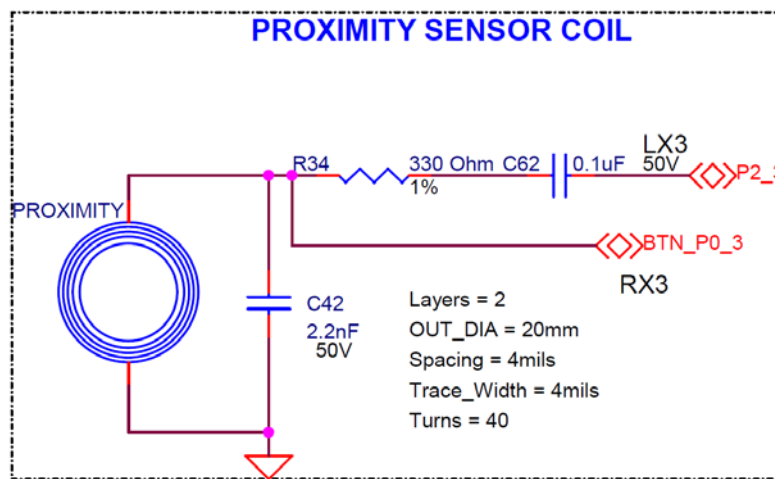
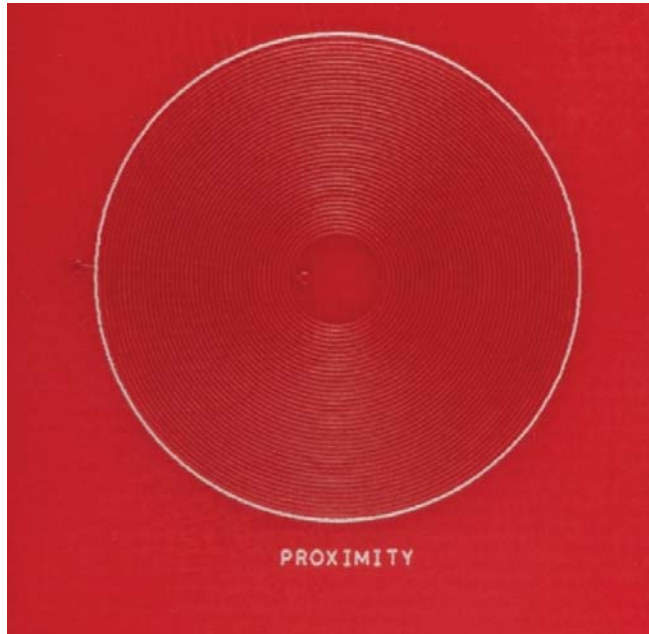
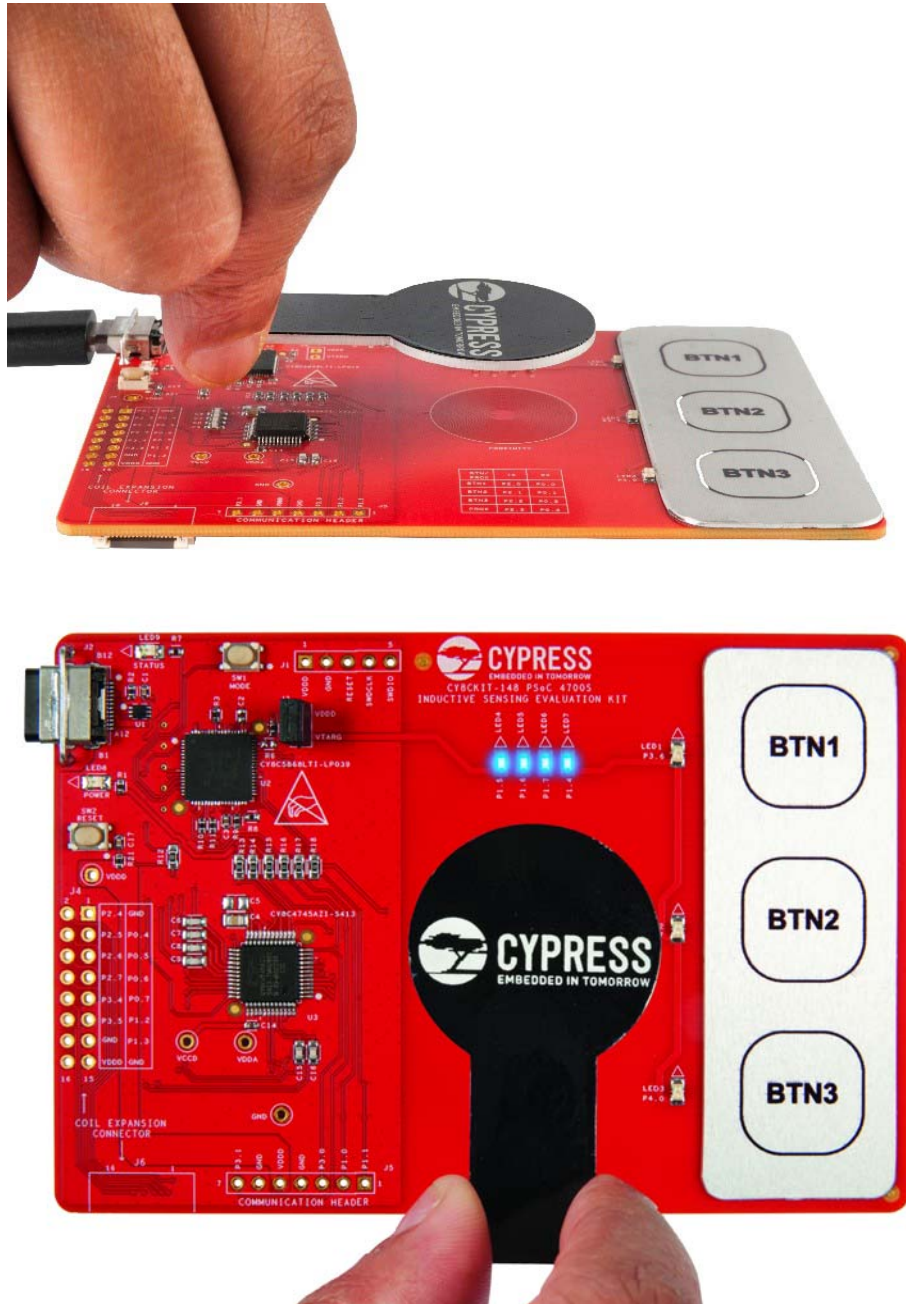

Figure A-13 shows the functionality of the proximity sensor with metal target. These are the two recommended ways of holding the metal target.

**Note:** The resonant frequency of the coil depends on the Inductance as well as the parasitic capacitance. When a user touches the coil with the finger, there is a shift in resonant frequency due to the change in parasitic capacitance. This change results in touch detection. To prevent the touch detection, the sensitivity of the sensor can be reduced by increasing the threshold of the sensor however that may result into lesser range of proximity.

Figure A-13. Proximity Sensor demonstration



**Note:** The features of the components are the same as those described in “Inductive Sensing Button Coils” on page 41.

### A.2.5.5 Functionality of FPC Connector

An FPC Connector is provided onboard. This FPC connector can be used to extend the user design with daughter boards mating with the FPC connector to operate with full functionality. FPC connectors are considered low noise connectors which are good for MagSense functionality.

Figure A-14. FPC Connector

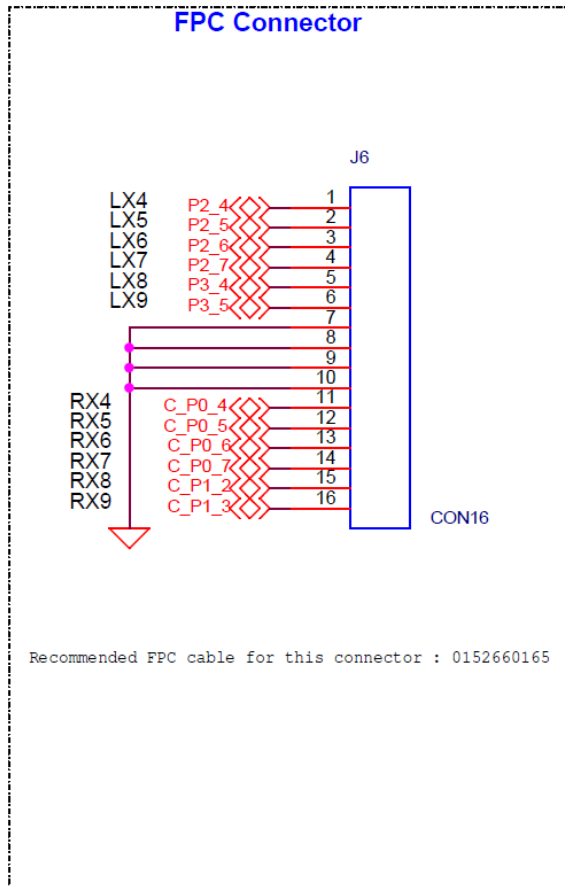
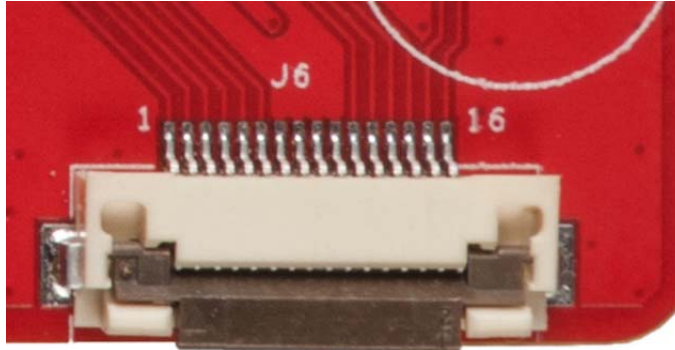

**Note:** To design a board for an FPC connection, CY8CKIT-148 compatible system, all circuitry except for the DC coupling capacitor at the RX line needs to be designed.



### A.2.5.6 Functionality of I/O Header J4

I/O header J4 pins are the multiplexed pins of the FPC connector. To work with the I/O headers, load C52, C53, C54, C55, C56, and C57.

**Note:** To design a board for the J4 connector, CY8CKIT-148 compatible system, all circuitry except for the DC coupling capacitor at the RX line needs to be designed.

Figure A-15. I/O Header

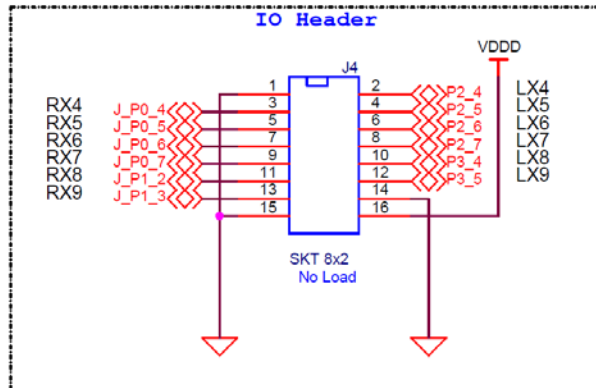

### A.2.5.7 LEDs

The PSoC 4700S Inductive Sensing Evaluation Kit contains nine LEDs:

- The Amber Power LED (LED8): Indicates that the board is powered from the USB Type-C connector. This LED will not glow when the board is powered from VTARG directly.
- The Amber Status LED (LED9): Indicates the KitProg2 status. This LED is connected to **P1[4]** of the KitProg2 PSoC 5LP device.
  - [Table 3-1 on page 23](#) shows the various modes of status LED.
- The blue LEDs (LED1 to LED7): These are the feedback LEDs connected to the target PSoC 4700S device.

**Note:** Feedback LEDs (LED1 to LED7) will not work at 1.8 V, other LEDs may work with very low brightness.

Figure A-16. Power and Status LEDs

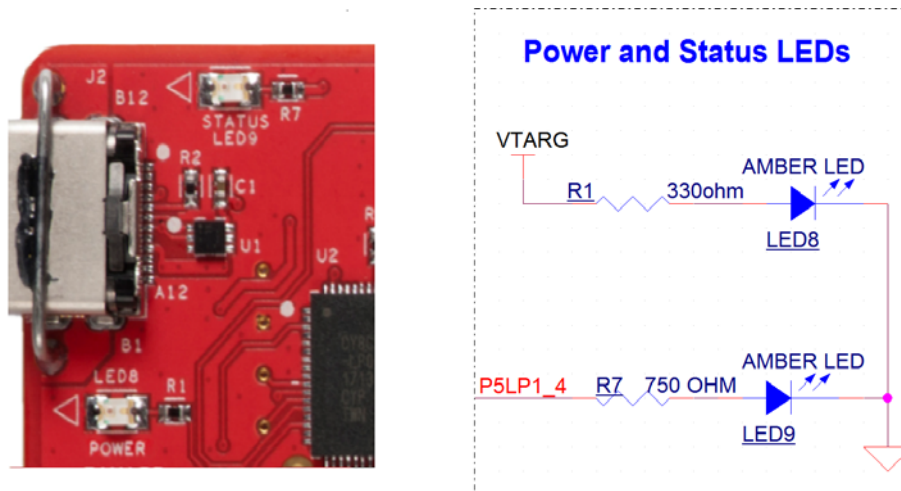
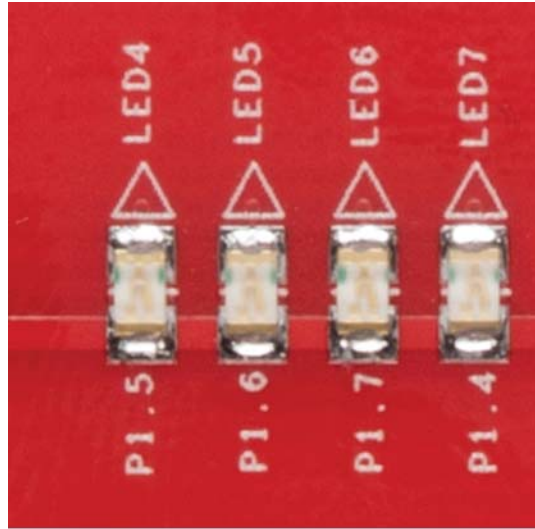
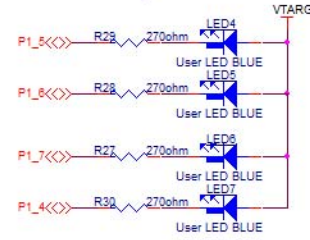

Figure A-17. Proximity and Button Feedback LEDs



### Proximity Feedback LEDs



### Button Feedback LEDs

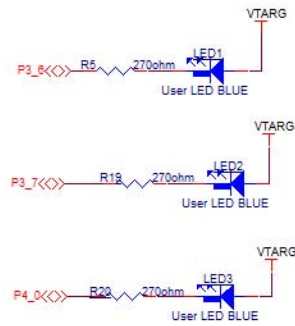



### A.2.5.8 System Capacitors

The CY8CKIT-148 PSoC 4700S Inductive Sensing Evaluation Kit has eight capacitors in addition to the power supply decoupling capacitors:

- One CapSense capacitor (CMOD): Required for CapSense functionality of the PSoC 4700S device (This is No Load).
- Two Inductive Sensing capacitors (CINTA and CINTB): Required for Inductive Sensing functionality of the PSoC 4700S device.

**Note:** These capacitors are also required for Mutual capacitive sensing functionality.

Figure A-18. System Capacitors Circuit Diagram

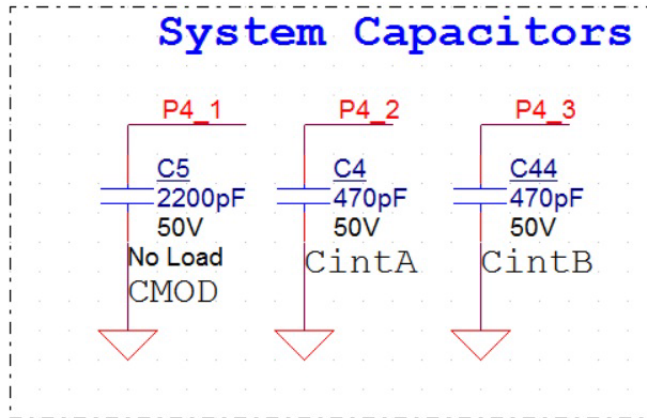

## A.3 PSoC 4700S Inductive Sensing Evaluation Kit Schematics

See the schematic file available in the following path in the kit software installed:

<Install\_Directory>\CY8CKIT-148 PSoC 4700S Inductive Sensing Evaluation Kit\<>version>\Hardware\CY8CKIT-148 Schematic.pdf

## A.4 Bill of Materials

See the BOM file available in the following path in the kit software installed:

<Install\_Directory>\CY8CKIT-148 PSoC 4700S Inductive Sensing Evaluation Kit\<>version>\Hardware\CY8CKIT-148 PCBA BOM.xlsm

# Revision History



## Document Revision History

Document Title: CY8CKIT-148 PSoC® 4700S Inductive Sensing Evaluation Kit Guide				
Document Number: 002-23165				
Revision	ECN#	Issue Date	Origin of Change	Description of Change
**	6177053	06/05/2018	NMIT	New kit guide.
*A	6217423	07/11/2018	NMIT	<p>Updated <a href="#">Introduction</a> chapter on page 7:</p> <p>Updated "Kit Contents" on page 8:</p> <p>Updated <a href="#">Figure 1-1</a>.</p> <p>Updated <a href="#">Software Installation</a> chapter on page 16:</p> <p>Added "Installing PSoC 4700S Device in PSoC Creator" on page 19.</p> <p>Updated "Installing the MagSense Component" on page 20:</p> <p>Updated description.</p> <p>Updated <a href="#">Kit Operation</a> chapter on page 22:</p> <p>Updated "Programming and Debugging the Target PSoC 4700S Device" on page 24:</p> <p>Updated "Programming Using PSoC Creator" on page 24:</p> <p>Updated <a href="#">Figure 3-2</a>.</p> <p>Updated <a href="#">Code Examples</a> chapter on page 28:</p> <p>Updated "Using the Kit Code Examples" on page 28:</p> <p>Updated description.</p> <p>Updated <a href="#">Appendix</a> chapter on page 35:</p> <p>Updated "Board Details" on page 35:</p> <p>Updated <a href="#">Figure A-1</a>.</p> <p>Updated "Hardware Details" on page 36:</p> <p>Updated "User and Passive Inputs" on page 40:</p> <p>Updated "Inductive Sensing Button Coils" on page 41:</p> <p>Updated <a href="#">Figure A-10</a>, and <a href="#">Figure A-11</a>.</p> <p>Updated "Inductive Sensing Proximity Coil" on page 44:</p> <p>Updated <a href="#">Figure A-12</a>, and <a href="#">Figure A-13</a>.</p> <p>Updated "Functionality of FPC Connector" on page 46:</p> <p>Updated <a href="#">Figure A-14</a>.</p> <p>Updated "Functionality of I/O Header J4" on page 47:</p> <p>Updated <a href="#">Figure A-15</a>.</p>

## Document Revision History (*continued*)

Document Title: CY8CKIT-148 PSoC® 4700S Inductive Sensing Evaluation Kit Guide				
Document Number: 002-23165				
Revision	ECN#	Issue Date	Origin of Change	Description of Change
*B	6283203	08/23/2018	NMIT	<p>Updated <a href="#">Introduction chapter on page 7</a>:</p> <p>Updated <a href="#">"PSoC Creator" on page 9</a>:</p> <p>Updated <a href="#">"PSoC Creator Code Examples" on page 10</a>:</p> <p>Updated <a href="#">Figure 1-5</a>.</p> <p>Updated <a href="#">"Component Datasheets" on page 12</a>:</p> <p>Updated <a href="#">Figure 1-6</a>.</p> <p>Updated <a href="#">"Additional Learning Resources" on page 13</a>:</p> <p>Updated description.</p> <p>Updated <a href="#">Software Installation chapter on page 16</a>:</p> <p>Updated <a href="#">"Installing PSoC 4700S Device in PSoC Creator" on page 19</a>:</p> <p>Updated description.</p> <p>Updated <a href="#">"Installing the MagSense Component" on page 20</a>:</p> <p>Updated <a href="#">Figure 2-6</a>.</p> <p>Updated <a href="#">Kit Operation chapter on page 22</a>:</p> <p>Updated <a href="#">"Programming and Debugging the Target PSoC 4700S Device" on page 24</a>:</p> <p>Updated <a href="#">"Programming Using PSoC Creator" on page 24</a>:</p> <p>Updated <a href="#">Figure 3-3</a>.</p> <p>Updated <a href="#">Code Examples chapter on page 28</a>:</p> <p>Updated <a href="#">"Using the Kit Code Examples" on page 28</a>:</p> <p>Updated <a href="#">Figure 4-2, and Figure 4-6</a>.</p> <p>Updated <a href="#">"Using Built-in PSoC Creator Code Examples with the Kit" on page 32</a>:</p> <p>Updated <a href="#">Figure 4-7, Figure 4-9, and Figure 4-10</a>.</p> <p>Updated <a href="#">Appendix chapter on page 35</a>:</p> <p>Updated <a href="#">"Hardware Details" on page 36</a>:</p> <p>Updated <a href="#">"Target Board" on page 36</a>:</p> <p>Updated hyperlinks.</p>