



AEC-Q200

This component was always RoHS compliant from the first date of manufacture.

- **Designed for 950.0 - 960.0 MHz RFID Applications**
- **Optimized for use with the TRC103 Transceiver**
- **Balanced 150 ohm IC Interface**
- **Complies with Directive 2002/95/EC (RoHS)**

RoHS
Compliant

RF3601E

960.0 MHz
SAW Filter

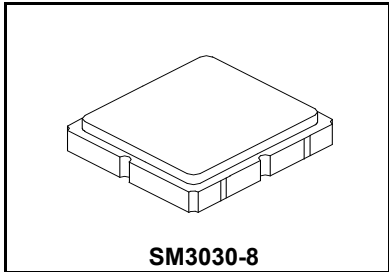

Absolute Maximum Ratings

Rating	Value	Units
Input Power Level	+15	dBm
DC Voltage	±5	V
Operating Temperature Range	-40 to +85	°C
Storage Temperature Range in Tape and Reel	-40 to +85	°C

Electrical Characteristics

Characteristic	Sym	Notes	Min	Typ	Max	Units
Center Frequency	f_c			960.0		MHz
1.5 dB Bandwidth	$BW_{1.5}$			40		MHz
Maximum Insertion Loss, 950.0 to 960.0 MHz	IL_{MAX}			2.1	3.5	dB
Amplitude Ripple, p-p, 950.0 to 960.0 MHz				0.5	1.0	
Rejection Referenced to Insertion Loss at 960.0 MHz:						
710 to 810 MHz			50	53		
810 to 860 MHz			45	47		
860 to 910 MHz			43	45		
1010 to 1060 MHz			35	37		
1060 to 1110 MHz			45	47		
1110 to 1210 MHz			43	45		
Source Impedance	Z_S			50		Ω
Load Impedance	Z_L			200		Ω

Case Style	SM3030-8 3.0 x 3.0 mm Nominal Footprint		
Lid Symbolization (Y=year, WW=week, S=shift) dot=pin 1 indicator	818, <u>YWWS</u>		
Standard Reel Quantity	Reel Size 7 Inch	1000 Pieces/Reel	
	Reel Size 13 Inch	3000 Pieces/Reel	

Electrical Connections

Connection	Terminals
Single-ended Port	6
Balanced Port	1, 3
Case Ground	4, 5, 7, 8
No Connection	2

CAUTION: Electrostatic Sensitive Device. Observe precautions for handling.

NOTES:

1. The design, manufacturing process, and specifications of this device are subject to change.
2. US or International patents may apply.
3. RoHS compliant from the first date of manufacture.

RF3601E-TRC103 Application Circuit

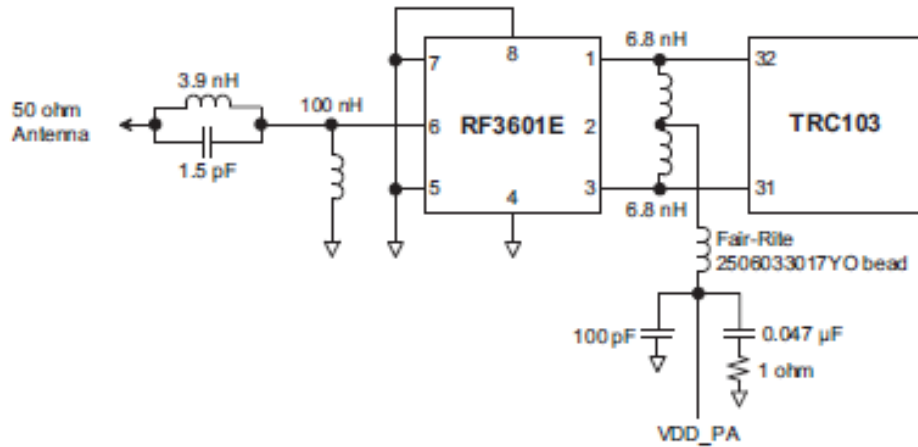

Reference Circuit Diagram Only
 Note: TRC105 has been obsoleted

RF3601E 50 Ohm Tuning Network

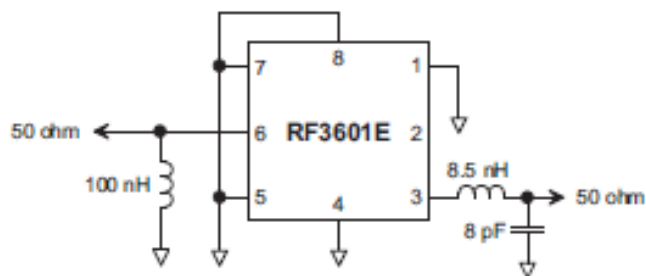

RF3601E Broadband Response, 400 to 2000 MHz

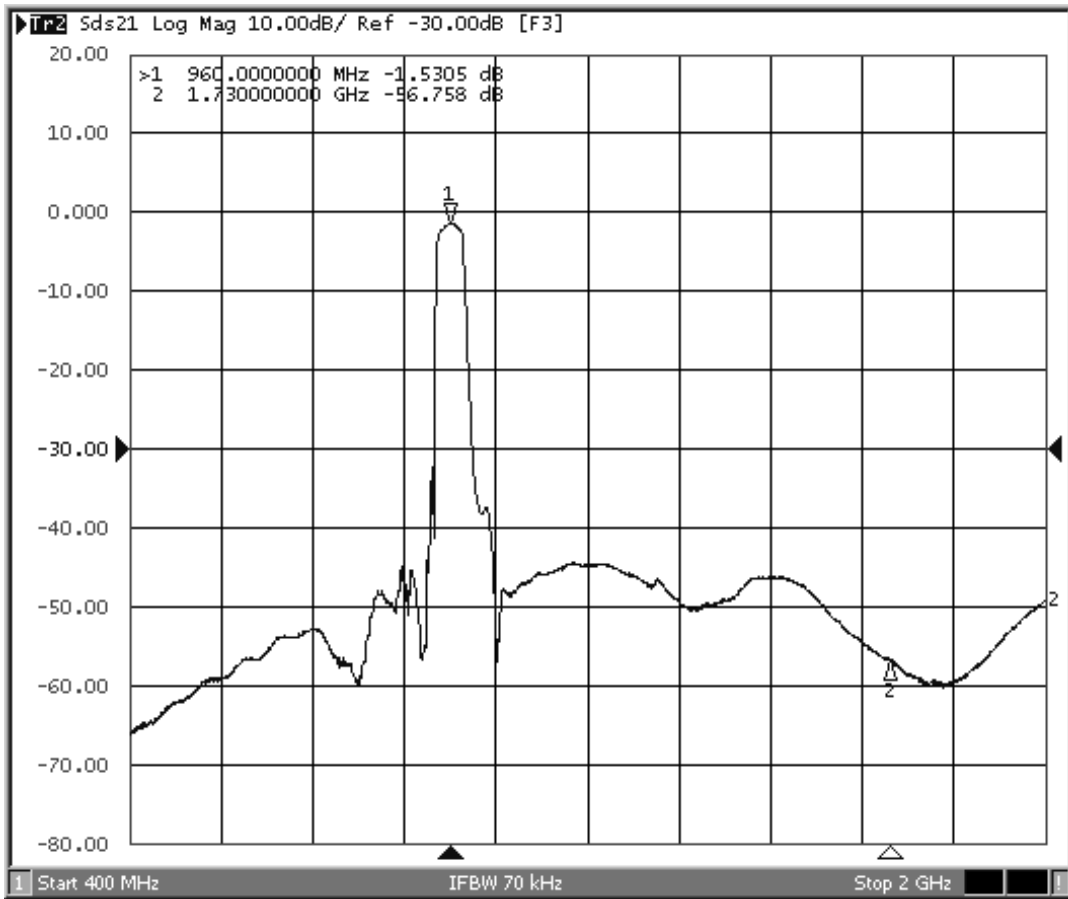

RF3601E Response, 710 to 1210 MHz

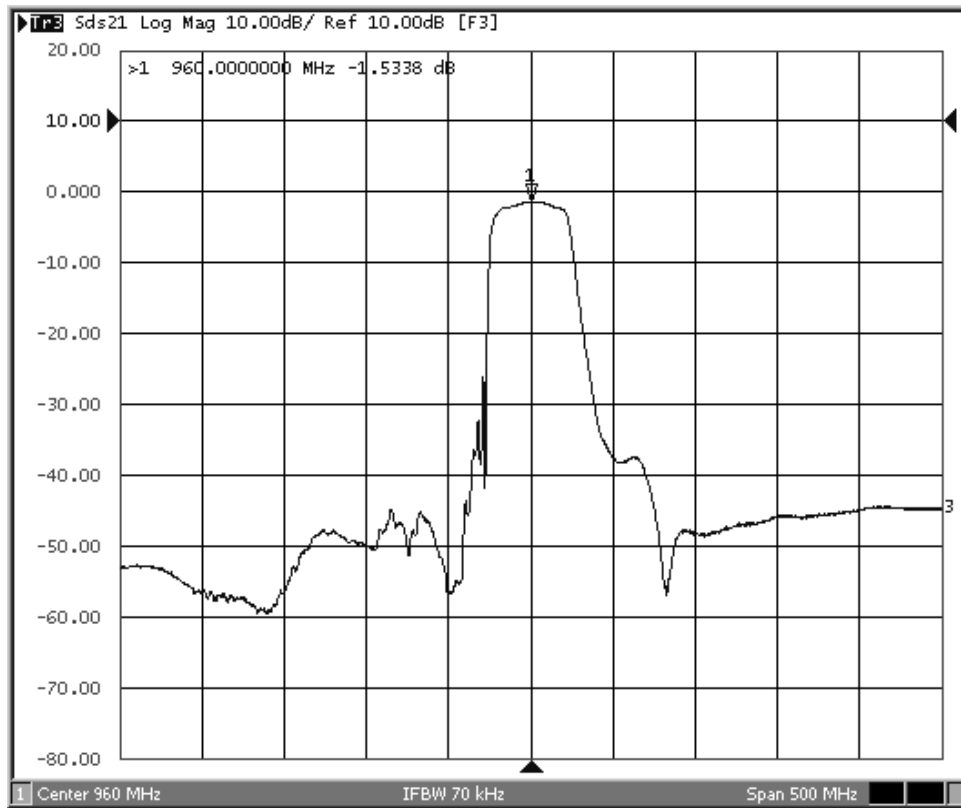

RF3601E Passband Response

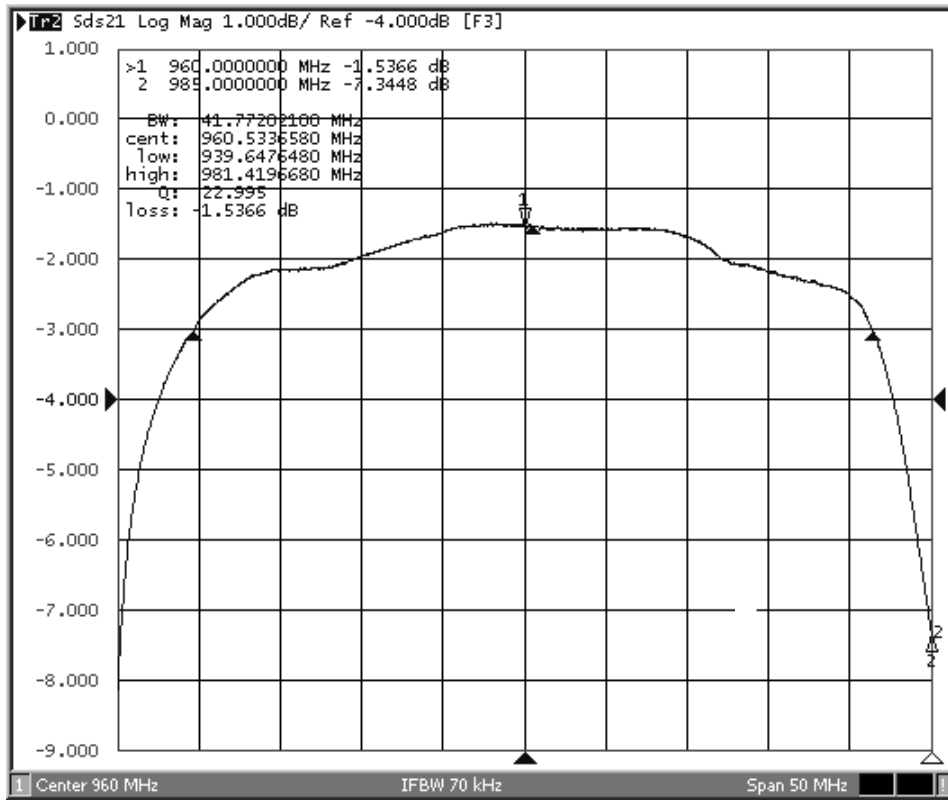

8-Terminal Ceramic Surface-Mount Case 3.0 X 3.0 mm Nominal Footprint

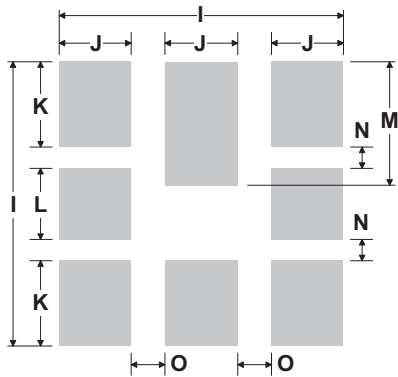
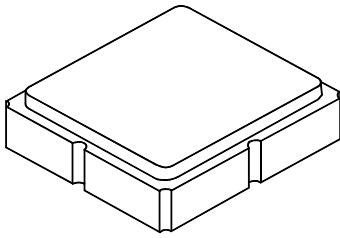

PCB Footprint Top View

Case and PCB Footprint Dimensions

Dimension	mm			Inches		
	Min	Nom	Max	Min	Nom	Max
A	2.87	3.0	3.13	0.113	0.118	0.123
B	2.87	3.0	3.13	0.113	0.118	0.123
C	1.14	1.27	1.40	0.045	0.050	0.055
D	0.79	0.92	1.05	0.031	0.036	0.041
E	0.62	0.75	0.88	0.024	0.029	0.034
F	0.47	0.60	0.73	0.018	0.024	0.029
G	0.47	0.60	0.73	0.018	0.024	0.029
H	1.07	1.20	1.33	0.042	0.047	0.052
I		3.19			0.126	
J		0.81			0.032	
K		0.96			0.038	
L		0.81			0.032	
M		1.39			0.055	
N		0.23			0.009	
O		0.38			0.015	

Case Materials

Materials	
Solder Pad Plating	0.3 to 1.0 μm Gold over 1.27 to 8.89 μm Nickel
Lid Plating	2.0 to 3.0 μm Nickel
Body	Al_2O_3 Ceramic
Pb Free	

TOP VIEW

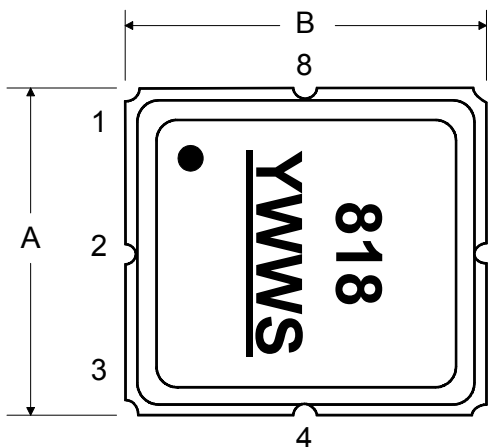

BOTTOM VIEW

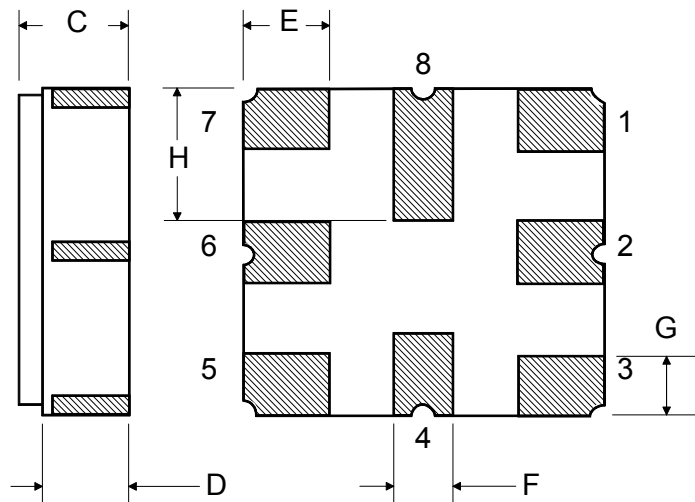

Recommended Reflow Profile

1. Preheating shall be fixed at 150~180°C for 60~90 seconds.
2. Ascending time to preheating temperature 150°C shall be 30 seconds min.
3. Heating shall be fixed at 220°C for 50~80 seconds and at 260°C +0/-5°C peak (10 seconds).
4. Time: 5 times maximum.

