

APPROVED: _____
 DATE: _____ TITLE: _____

Rev	AWO #	Description	Date	Appr
-		RELEASED	11/2/21	
A		UPDATED SPEC.	11/8/21	JJ/RC

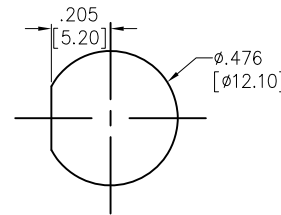

RECOMMENDED
PANEL CUT-OUT

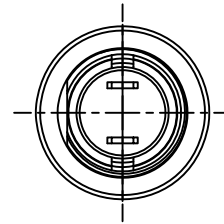
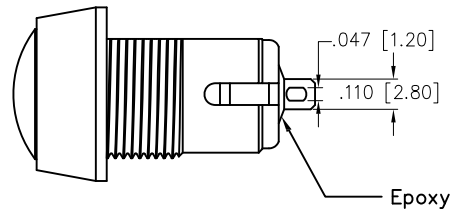
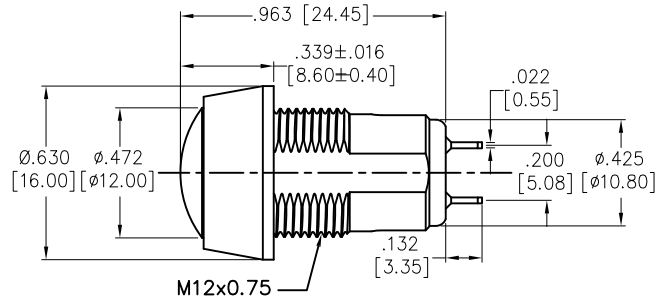
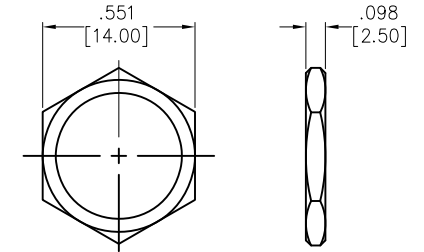

NUT

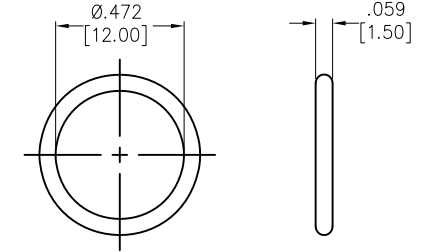

O-RING

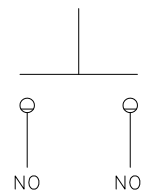

CIRCUIT DIAGRAM
(SPST)

SPECIFICATIONS:

Material:
 Bushing: Aluminum Alloy, Nickel plated
 Bushing Color: Black
 Contact Material: Copper Alloy,
 Plating: Gold over Silver
 Electrical:
 Switch Rating: 100mA @ 24V DC
 2A @ 125V AC
 Contact resistance: 50 mΩ max initial.
 Insulation resistance: 1G ohms min @ 500 VDC
 Dielectric withstanding voltage: 1000 VAC for 1 minute
 Electrical Life: 1,000,000 cycles min.
 Temperature Rating:
 Operating temperature: -30°C to +85°C
 Environmental:

Water proof: IP67
 Lead free, RoHS compliant



UNLESS OTHERWISE SPECIFIED ALL DIMENSIONS
 ARE INCHES [MM]. TOLERANCES: EXCEPT AS NOTED

INCHES		HOLES	
.x	±.10	Ø.x	±.10
.xx	±.020	Ø.xx	±.015
.xxx	±.015	Ø.xxx	±.010



909 Rahway Avenue,
 Union, NJ 07083
 Phone: 908-687-5000
 Fax: 908-687-5710

DRAWN	JJ	11/2/21
CHECKED	RC	11/2/21
APPROVED		

TITLE
**SWITCH, ANTI-VANDAL SEALED, PUSH BUTTON,
 SOLDER SPST, 12mm, MOMENTARY**

THIS DRAWING CONTAINS INFORMATION THAT IS PROPRIETARY
 AND SHOULD NOT BE USED WITHOUT PRIOR WRITTEN
 PERMISSION FROM ADAM TECH

SIZE	PART NO.	REV.
X	SW-PB7-04MB4WARM	A
REF: S00198T	SCALE: NTS	SHEET 1 OF 1