

Data sheet | Item number: 770-263

Socket; 3-pole; Cod. B; 4,00 mm²; light green

www.wago.com/770-263

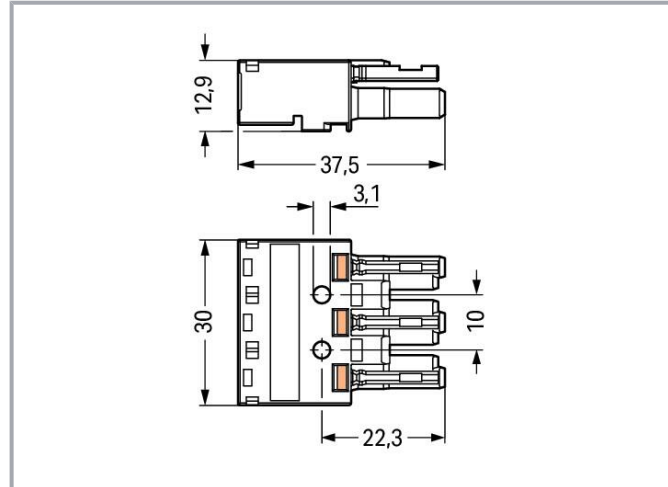
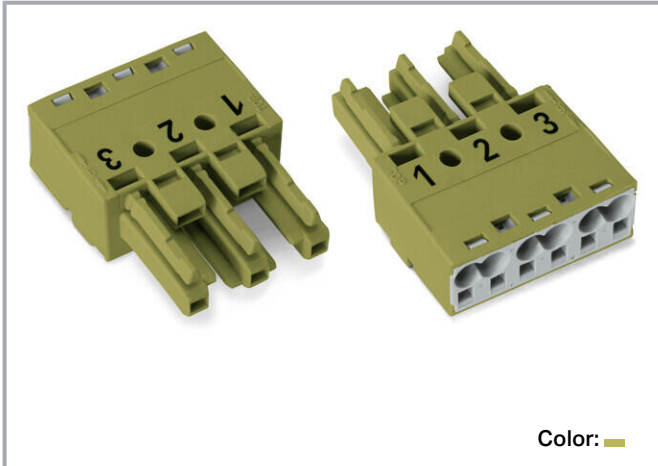

Item description

Female connector/socket *WINSTA*® MIDI with protection type IP20

The *WINSTA*® MIDI female connector/socket 3-pole allows assembly of solid and fine-stranded conductors. Whether on PCBs, in control cabinets or for connecting lights – pluggable installation connectors from WAGO allow you to establish connections according to many different requirements in no time flat. The color coding and mechanical coding of the pluggable installation connector ensure error-free installation of the individual components – including protection against mismatching. The pluggable installation connector offers touch-proof protection with live components in accordance with protection type IP20 (When mated and secured with a strain relief housing: IP2xC (These compact connectors are not designed for use in open, easily accessible areas!)). B coding enables the *WINSTA*® MIDI pluggable installation connectors to be used for application control in automation, mechanical engineering and robotics. The rated current and voltage are important criteria for selecting a pluggable installation connector: They tell us about the product's domains of use. This product has a current rating of 25 A – so it is also suitable for high power loads. Our *WINSTA*® MIDI product line guarantees maximum flexibility for the installation. Through its Push-in CAGE CLAMP® spring pressure connection technology, it ensures error-free, time-saving installation and offers customization for meeting various installation requirements.

Lower costs through fast commissioning and elimination of service expenses – solutions from *WINSTA*® MIDI

The *WINSTA*® Pluggable Connection System allows pluggable electrical installation. This saves time, lowers costs, and reduces the need for servicing. Choose quality and durability – the *WINSTA*® MIDI pluggable installation connector with protection type IP20 from WAGO makes the

Subject to changes. Please also observe the further product documentation!

WAGO GmbH & Co. KG
Hansastr. 27
32423 Minden
Phone: +49571 887-0 | Fax: +49571 887-169
Email: info.de@wago.com | Web: www.wago.com

Do you have any questions about our products?
We are always happy to take your call at +49 (571) 887-44222.



electrical installation of electrical components substantially easier.

- protection against mismatching eliminates errors
- pre-assembled versions
- with B coding for use in automation of processes, such as lighting technology, among other examples
- exact dimensions
- convenient installation and commissioning

Data Notes

Variants: Other pole markings
Other versions (or variants) can be requested from WAGO Sales or configured at <https://configurator.wago.com/>.

Electrical data

Ratings per IEC/EN

Ratings per	IEC/EN 60664-1
Nominal voltage (III/3)	250 V
Rated impulse voltage (III/3)	4 kV
Rated current	25 A
Legend (ratings)	(III / 3) ≙ Overvoltage category III / Pollution degree 3

Ratings per UL 1977

Note for the US market	Some versions may also be used for current interruption in accordance with the UL certificate in select applications with currents below 16 A and voltages up to 600 V. For further information, please contact your local sales office.
Rated voltage (UL 1977)	600 V
Rated current UL 1977	23 A

General

Note on contact resistance	approx. 1 mΩ of contact resistance approx. 0.25 mΩ contact transition plug/socket
----------------------------	--

Subject to changes. Please also observe the further product documentation!



Connection data

Connection points	6
Total number of potentials	3

Connection 1

Connection technology	Push-in CAGE CLAMP®
Actuation type	Operating tool Push-in
Nominal cross-section	4 mm ² / 12 AWG
Solid conductor	0.5 ... 4 mm ² / 20 ... 12 AWG
Solid conductor; push-in termination	1.5 ... 4 mm ² / 16 ... 12 AWG
Stranded conductor	0.5 ... 2.5 mm ² / 20 ... 14 AWG
Fine-stranded conductor	0.5 ... 4 mm ² / 20 ... 12 AWG
Fine-stranded conductor; with insulated ferrule	0.25 ... 1.5 mm ² / 20 ... 16 AWG
Fine-stranded conductor; with uninsulated ferrule	0.25 ... 2.5 mm ² / 20 ... 14 AWG
Fine-stranded conductor; with ferrule; push-in termination	1.5 mm ² / 16 AWG
Strip length	9 mm / 0.35 inches
Pole number	3
Conductor entry direction to mating direction	0°

Physical data

Pin spacing	10 mm / 0.394 inches
Width	30 mm / 1.181 inches
Height	12.9 mm / 0.508 inches
Depth	37.5 mm / 1.476 inches

Mechanical Data

Application	Control technology
Coding	B
Variable coding	Yes
Marking	1 2 3
Potential marking	1 2 3
Mating force of a plug-in connection	approx. 20 ... 70 N (depending on pole number)
Retention force of a plug-in connection	Locked: > 80 N
Unmating force of a plug-in connection	Unlocked: approx. 20 ... 70 N (depending on pole number)

Subject to changes. Please also observe the further product documentation!



Number of mating cycles	200, without resistive load
Protection type	IP20; When mated and secured with a strain relief housing: IP2xC (These compact connectors are not designed for use in open, easily accessible areas!)

Plug-in connection

Contact type (pluggable connector)	Female connector/socket
Connector (connection type)	for conductor
Mismating protection	Yes
Note on mismating protection	All <i>WINSTA</i> [®] components are 100% protected against mismating when: a.) plugging different numbers of poles b.) plugging while rotated 180 c.) plugging while laterally staggered d.) plugging one pole
Locking lever	Can be retrofitted
Locking of plug-in connection	locking lever
Note on locking system	All connectors for mounted installations (snap-in versions for lighting fixtures or devices, all types of PCB and distribution connectors) are factory-equipped with locking levers to ensure plugs and sockets are securely locked. Additional locking levers are only required for flying leads (plug/socket).

Material Data

Note (material data)	Information on material specifications can be found here
Color	light green
Cover color	gray
Material group	I
Insulation material	Polyamide (PA66)
Flammability class per UL94	V0
Clamping spring material	Chrome-nickel spring steel (CrNi)
Contact material	Copper or copper alloy; surface-treated
Contact plating	Tin
Fire load	0.178 MJ
Weight	9.6 g

Subject to changes. Please also observe the further product documentation!

WAGO GmbH & Co. KG
Hansastr. 27
32423 Minden
Phone: +49571 887-0 | Fax: +49571 887-169
Email: info.de@wago.com | Web: www.wago.com

Do you have any questions about our products?
We are always happy to take your call at +49 (571) 887-44222.

Environmental requirements

Processing temperature	-5 ... +40 °C
Continuous operating temperature	-35 ... +85 °C
Note on continuous operating temperature	Insulating parts for temperatures ≤ 105 °C

Commercial data



Product Group	20 (Winsta)
eCl@ss 10.0	27-44-06-05
eCl@ss 9.0	27-44-06-05
ETIM 8.0	EC002560
ETIM 7.0	EC002560
PU (SPU)	100 pcs
Packaging type	box
Country of origin	DE
GTIN	4050821445012
Customs tariff number	85366990990

Environmental Product Compliance

RoHS Compliance Status	Compliant, No Exemption
------------------------	-------------------------

Approvals / Certificates

General approvals

Logo	Approval	Additional Approval Text	Certificate name
	CCA DEKRA Certification B.V.	IEC 61984	NL-32104
	CCA DEKRA Certification B.V.	EN 61984	2173495.01
	cURus Underwriters Laboratories Inc.	UL 1977	E45171

Declarations of conformity and manufacturer's declarations

Logo	Approval	Additional Approval Text	Certificate name
------	----------	--------------------------	------------------

Subject to changes. Please also observe the further product documentation!

WAGO GmbH & Co. KG
 Hansastr. 27
 32423 Minden
 Phone: +49571 887-0 | Fax: +49571 887-169
 Email: info.de@wago.com | Web: www.wago.com

Do you have any questions about our products?
 We are always happy to take your call at +49 (571) 887-44222.



EU-Declaration of Conformity
WAGO GmbH & Co. KG

-

-





UK-Declaration of Conformity
WAGO GmbH & Co. KG

-

-

Approvals for marine applications

Logo	Approval	Additional Approval Text	Certificate name
	ABS American Bureau of Shipping	-	19- HG1868589- PDA
	DNV GL Det Norske Veritas, Germanischer Lloyd	-	TAE00001Z6
	LR Lloyds Register	IEC 61984	LR22429487TA

Counterpart



Item no.770-1612

T-distribution connector; 3-pole; Cod. B; 1 input; 2 outputs; 2 locking levers; light green

www.wago.com/770-1612



Item no.770-1662

h-distribution connector; 3-pole; Cod. B; 1 input; 2 outputs; outputs on one side; 2 locking levers; light green

www.wago.com/770-1662



Item no.770-1712

T-distribution connector; 3-pole; Cod. B; 1 input; 2 outputs; 3 locking levers; for flying leads; light green

www.wago.com/770-1712



Item no.770-1715

3-way distribution connector; 3-pole; Cod. B; 1 input; 3 outputs; light green

www.wago.com/770-1715

Subject to changes. Please also observe the further product documentation!

WAGO GmbH & Co. KG
Hansastr. 27
32423 Minden
Phone: +49571 887-0 | Fax: +49571 887-169
Email: info.de@wago.com | Web: www.wago.com

Do you have any questions about our products?
We are always happy to take your call at +49 (571) 887-44222.



Item no. 770-1762

h-distribution connector; 3-pole; Cod. B; 1 input; 2 outputs; outputs on one side; 3 locking levers; for flying leads; light green

www.wago.com/770-1762



Item no. 770-273

Plug; 3-pole; Cod. B; 4,00 mm²; light green

www.wago.com/770-273



Item no. 770-773

Snap-in plug; 3-pole; Cod. B; 4,00 mm²; light green

www.wago.com/770-773



Item no. 770-873

Plug for PCBs; straight; 3-pole; Cod. B; light green

www.wago.com/770-873



Item no. 770-873/011-000

Plug for PCBs; angled; 3-pole; Cod. B; light green

www.wago.com/770-873/011-000



Item no. 771-9993/005-105

pre-assembled interconnecting cable; Eca; Socket/plug; 3-pole; Cod. B; H05VV-F 3 x 1.0 mm²; 1 m; 1,00 mm²; light green

www.wago.com/771-9993/005-105



Item no. 771-9993/205-105

pre-assembled connecting cable; Eca; Plug/open-ended; 3-pole; Cod. B; H05VV-F 3 x 1.0 mm²; 1 m; 1,00 mm²; light green

www.wago.com/771-9993/205-105

Required accessories

Locking levers

Locking system



Item no.: 770-121

Locking lever; for flying leads; for manual operation; white

www.wago.com/770-121



Item no.: 770-131

Locking lever; for flying leads; for tool operation; white

www.wago.com/770-131



Item no.: 770-101

Locking lever; for flying leads; for manual operation; black

www.wago.com/770-101



Item no.: 770-111

Locking lever; for flying leads; for tool operation; black

www.wago.com/770-111

Optional accessories

Tool

Operating tool

Subject to changes. Please also observe the further product documentation!

WAGO GmbH & Co. KG

Hansastr. 27

32423 Minden

Phone: +49571 887-0 | Fax: +49571 887-169

Email: info.de@wago.com | Web: www.wago.com

Do you have any questions about our products?

We are always happy to take your call at +49 (571) 887-44222.



Item no.: 210-719

Operating tool; Blade: 2.5 x 0.4 mm; with a partially insulated shaft

www.wago.com/210-719



Item no.: 770-383

Operating tool; 3-way; green

www.wago.com/770-383

Marking accessories

Marker



Item no.: 770-450/000-002

Marker card; Plastic; yellow

www.wago.com/770-450/000-002



Item no.: 770-450/000-001

Marker card; Plastic; green

www.wago.com/770-450/000-001



Item no.: 770-450/000-005

Marker card; Plastic; red

www.wago.com/770-450/000-005



Item no.: 770-450

Marker card; Plastic; white

www.wago.com/770-450



Item no.: 770-450/000-006

Marker card; Plastic; blue

www.wago.com/770-450/000-006



Item no.: 770-450/000-012

Marker card; Plastic; orange

www.wago.com/770-450/000-012

Mounting

Snap-in frame



Item no.: 770-318

Snap-in frame; 3-pole; 1.0 ... 3.0 mm; black

www.wago.com/770-318



Item no.: 770-338

Snap-in frame; 3-pole; 1.0 ... 3.0 mm; white

www.wago.com/770-338

Cover

Subject to changes. Please also observe the further product documentation!

WAGO GmbH & Co. KG

Hansastr. 27

32423 Minden

Phone: +49571 887-0 | Fax: +49571 887-169

Email: info.de@wago.com | Web: www.wago.com

Do you have any questions about our products?

We are always happy to take your call at +49 (571) 887-44222.

Cover



Item no.: 770-201

Lockout cap; 12-pole, separable; for sockets; Plastic; black

www.wago.com/770-201



Item no.: 770-221

Lockout cap; 12-pole, separable; for sockets; Plastic; white

www.wago.com/770-221

Strain relief

Strain relief housing



Item no.: 770-503

Strain relief housing; 3-pole; for 2 cables; 8.0 ... 11.5 mm; 55 mm; black

www.wago.com/770-503



Item no.: 770-503/023-000

Strain relief housing; 3-pole; for 2 cables; 4.5 ... 8.0 mm; 55 mm; black

www.wago.com/770-503/023-000



Item no.: 770-503/021-000

Strain relief housing; 3-pole; for 1 cable; 9.0 ... 13.0 mm; 71 mm; black

www.wago.com/770-503/021-000



Item no.: 770-503/035-000

Strain relief housing; 3-pole; with locking clip; for 1 cable; 7.0 ... 11.5 mm; 48 mm; black

www.wago.com/770-503/035-000



Item no.: 770-503/038-000

Strain relief housing; 3-pole; with locking clip; for 1 cable; 7.0 ... 11.5 mm; 48 mm; black

www.wago.com/770-503/038-000



Item no.: 770-503/032-000

Strain relief housing; 3-pole; with locking clip; for 2 cables; 8.0 ... 11.5 mm; 55 mm; black

www.wago.com/770-503/032-000



Item no.: 770-513/038-000

Strain relief housing; 3-pole; with locking clip; for 1 cable; 7.0 ... 11.5 mm; 48 mm; white

www.wago.com/770-513/038-000



Item no.: 770-513

Strain relief housing; 3-pole; for 2 cables; 8.0 ... 11.5 mm; 55 mm; white

www.wago.com/770-513



Item no.: 770-513/021-000

Strain relief housing; 3-pole; for 1 cable; 9.0 ... 13.0 mm; 71 mm; white

www.wago.com/770-513/021-000

Subject to changes. Please also observe the further product documentation!

WAGO GmbH & Co. KG

Hansastr. 27

32423 Minden

Phone: +49571 887-0 | Fax: +49571 887-169

Email: info.de@wago.com | Web: www.wago.com

Do you have any questions about our products?

We are always happy to take your call at +49 (571) 887-44222.



Item no.: 770-513/032-000

Strain relief housing; 3-pole; for 2 cables; 8.0 ... 11.5 mm; 55 mm; white

www.wago.com/770-513/032-000



Item no.: 770-513/035-000

Strain relief housing; 3-pole; with locking clip; for 1 cable; 7.0 ... 11.5 mm; 48 mm; white

www.wago.com/770-513/035-000



Item no.: 770-513/023-000

Strain relief housing; 3-pole; for 2 cables; 4.5 ... 8.0 mm; 55 mm; white

www.wago.com/770-513/023-000

Downloads

Documentation

Bid Text

770-263 X81 - Datei	2019 Feb 19	xml 3.0 kB	Download
770-263 doc - Datei	2015 Jun 8	doc 24.6 kB	Download

CAD/CAE-Data

CAD data

2D/3D Models 770-263	URL	Download
----------------------	-----	----------

CAE data

WSCAD Universe 770-263	URL	Download
ZUKEN Portal 770-263	URL	Download

Environmental Product Compliance

Compliance Search

Environmental Product Compliance 770-263 Socket; 3-pole; Cod. B; 4,00 mm ² ; light green	URL	Download
--	-----	----------

Subject to changes. Please also observe the further product documentation!

Installation Notes

Conductor termination

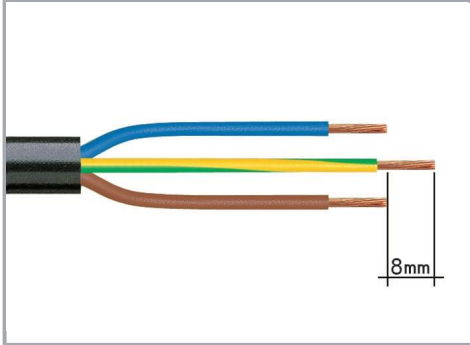

1. Strip length, outer insulation = 35 mm (2-pole), 55 mm (3- to 5-pole)

2. Strip length = 9 mm

3. Extended ground conductor = 8 mm

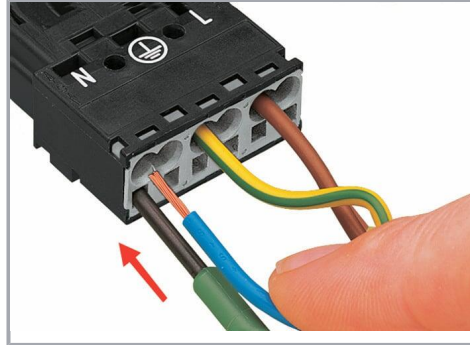

To terminate fine-stranded conductors, open the clamping unit via screwdriver (2.5 mm blade width) and insert a stripped conductor until it hits the backstop.

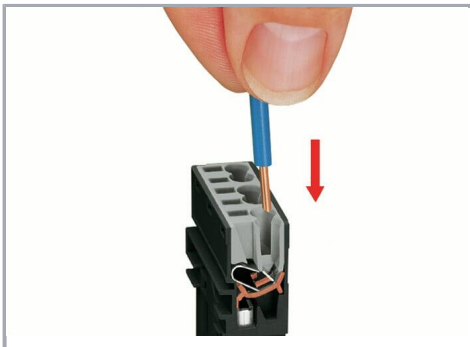

Insert the stripped solid conductor until it hits the backstop.

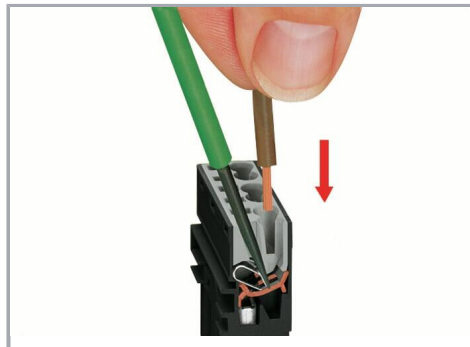

To terminate fine-stranded conductors, open the clamping unit via screwdriver (2.5 mm blade width) and insert a stripped conductor until it hits the backstop.

Conductor removal

Subject to changes. Please also observe the further product documentation!

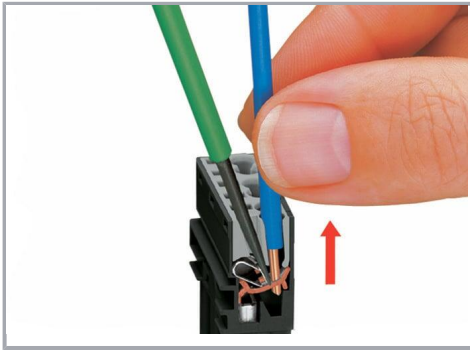

To remove the conductor, actuate the clamp via screwdriver (2.5 mm blade width) and pull out the conductor.

Installation

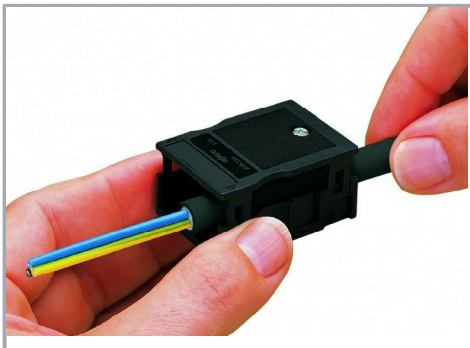

We recommend pulling the pre-latched strain relief housing over the cable prior to termination. However, the strain relief can be mounted at a later time as well.

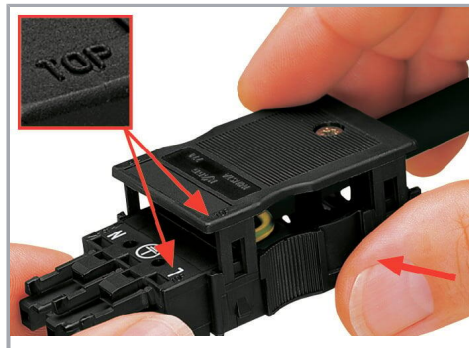

Latch the strain relief housing onto the plug /socket. Note the "TOP" inscription.

Subject to changes. Please also observe the further product documentation!

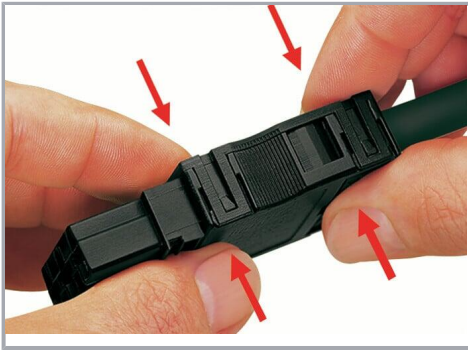

Prepare strain relief housing by snapping together upper and bottom part.



Tighten strain relief screw with screwdriver (2.5 mm blade width).

Coding



Simply cut off the coding pin from the socket.

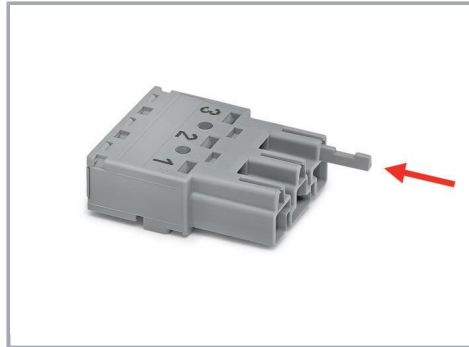

Insert coding pin into plug (break first) until it engages.

Mismatching protection

Subject to changes. Please also observe the further product documentation!

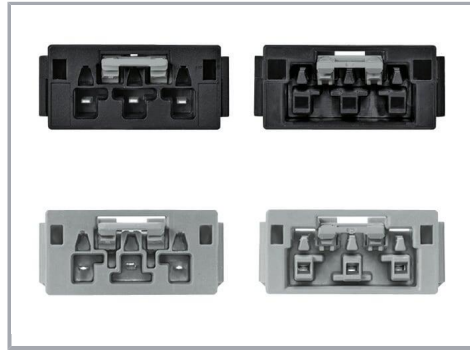
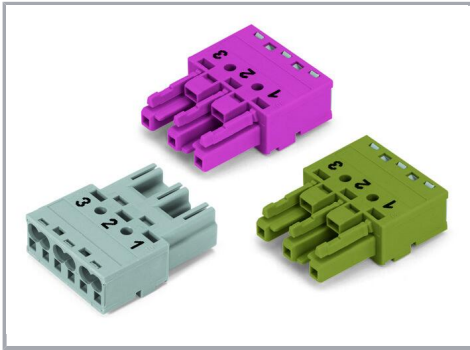

B-coded connectors with different colors can be plugged together.

Important note:

Different colors and/or pole markings are used for circuit identification.

Only connectors of the same color and same pole marking must be plugged together.

B-coded connectors (shown in gray) not only differ in color, but also in their design, making them incompatible with other coded connectors.



Easy circuit identification via different marking and colors

Product family

WINSTA® MIDI

[Show all products from the family](#)

Subject to changes. Please also observe the further product documentation!