

LISA2-M-CLIP

~20° medium beam optimized for CREE XP-E.
6.8 mm high variant with clip installation.

TECHNICAL SPECIFICATIONS:

Dimensions	Ø 9.9 mm
Height	6.8 mm
Fastening	glue, clips
ROHS compliant	yes ⓘ



MATERIAL SPECIFICATIONS:

Component	Type	Material	Colour	Finish
LISA2-M	Single lens	PMMA	clear	
LISA2-HLD-CLIP16-XP	Holder	PC	black	

ORDERING INFORMATION:

Component	Type	Qty in box	MOQ	MPQ	Box weight (kg)
FP13030_LISA2-M-CLIP	Single lens	2000		100	1.4
» Box size:					

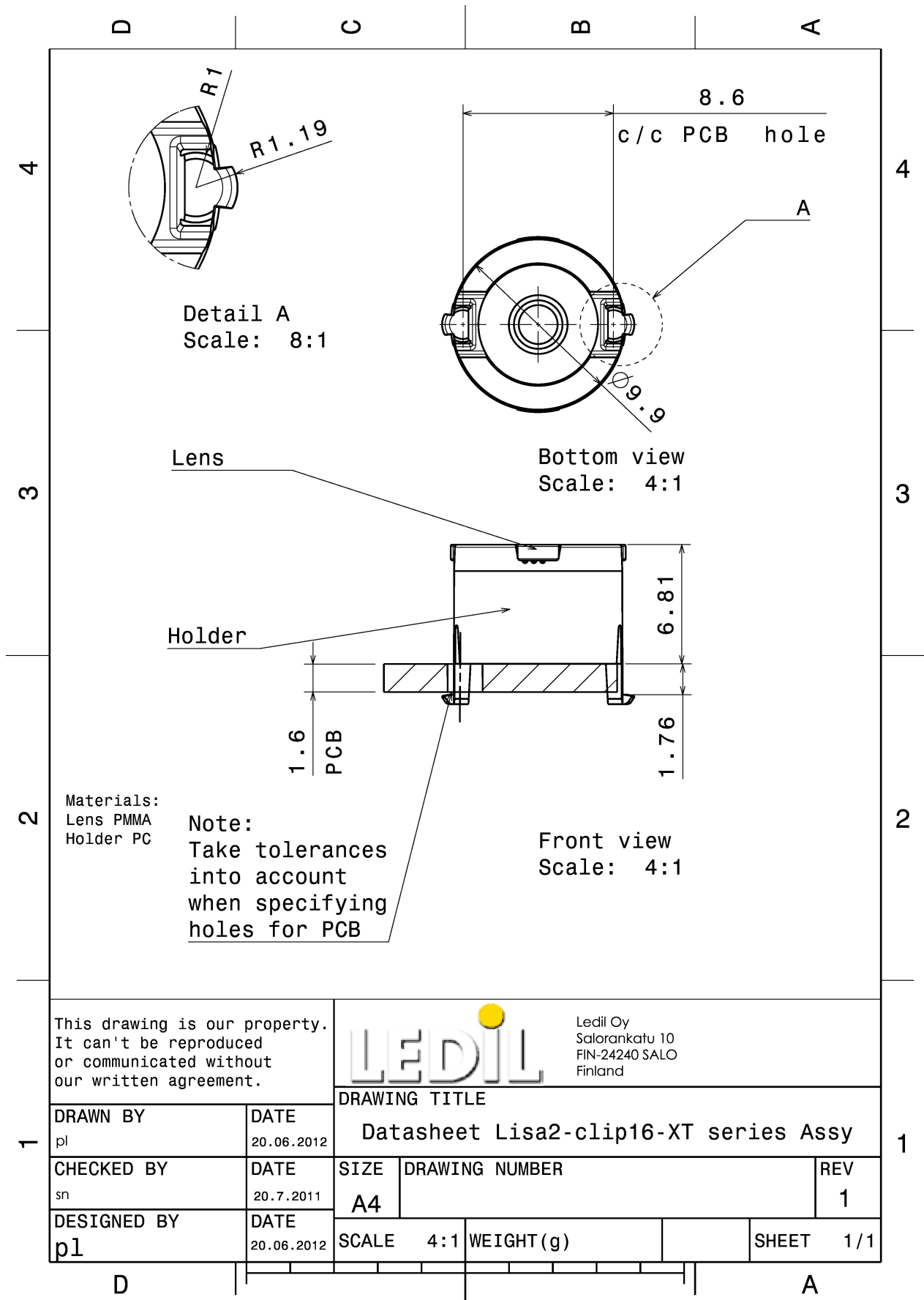

This drawing is our property. It can't be reproduced or communicated without our written agreement.



Ledil Oy
Salorankatu 10
FIN-24240 SALO
Finland

DRAWING TITLE

DRAWN BY pl		DATE 20.06.2012		Datasheet Lisa2-clip16-XT series Assy			
CHECKED BY sn		DATE 20.7.2011		SIZE A4	DRAWING NUMBER		REV 1
DESIGNED BY pl		DATE 20.06.2012		SCALE 4:1	WEIGHT (g)	SHEET 1/1	

See also our general installation guide: www.ledil.com/installation_guide

PHOTOMETRIC DATA (MEASURED):



LED XP-G2
 FWHM / FWTM 25.0° / 47.0°
 Efficiency 89 %
 Peak intensity 3.5 cd/m
 LEDs/each optic 1
 Light colour White
 Required components:

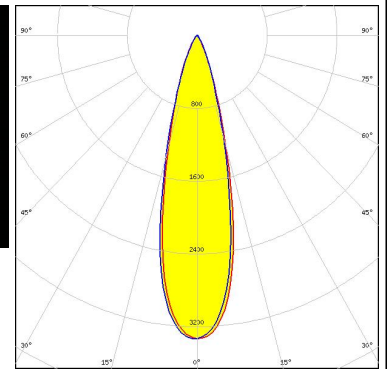

LED XP-G3
 FWHM / FWTM 29.0° / 60.0°
 Efficiency 85 %
 Peak intensity 2.4 cd/m
 LEDs/each optic 1
 Light colour White
 Required components:

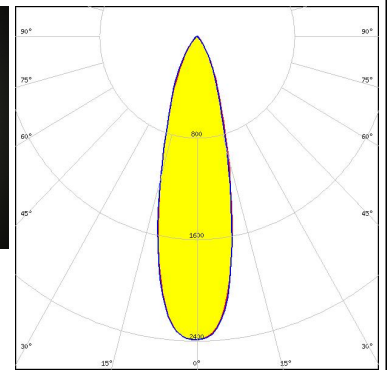
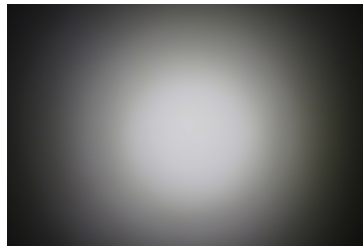

LED XT-E
 FWHM / FWTM 26.0° / 49.0°
 Efficiency 89 %
 Peak intensity 3.3 cd/m
 LEDs/each optic 1
 Light colour White
 Required components:

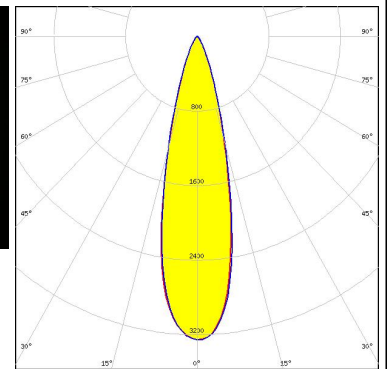

LED LUXEON T
 FWHM / FWTM 28.0° / 54.0°
 Efficiency 87 %
 Peak intensity 2.7 cd/m
 LEDs/each optic 1
 Light colour White
 Required components:

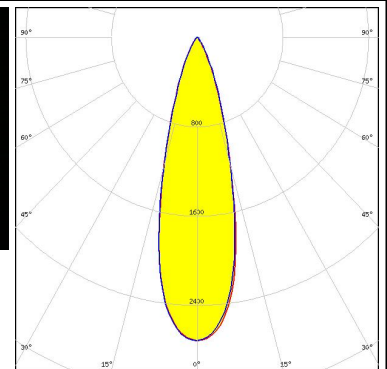
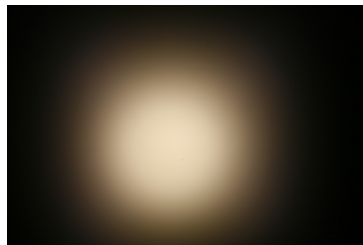

PHOTOMETRIC DATA (MEASURED):

LUMILEDS

LED LUXEON TX
 FWHM / FWTM 26.0° / 51.0°
 Efficiency 88 %
 Peak intensity 3.4 cd/m
 LEDs/each optic 1
 Light colour White
 Required components:

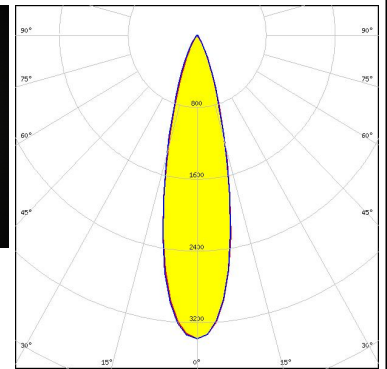
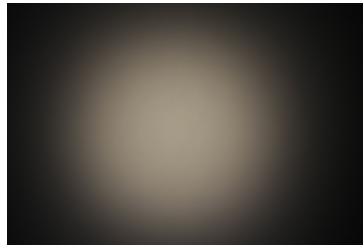

NICHIA

LED NCSxx19B
 FWHM / FWTM 23.0° / 46.0°
 Efficiency 85 %
 Peak intensity 4.1 cd/m
 LEDs/each optic 1
 Light colour White
 Required components:

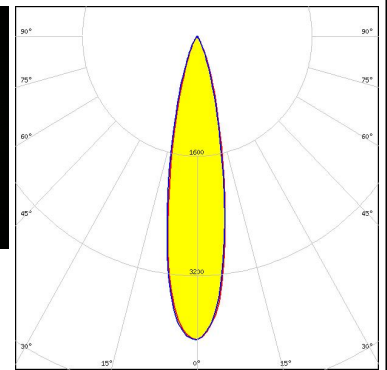

NICHIA

LED NVSxx19B/NVSxx19C
 FWHM / FWTM 27.0° / 56.0°
 Efficiency 86 %
 Peak intensity 2.6 cd/m
 LEDs/each optic 1
 Light colour White
 Required components:

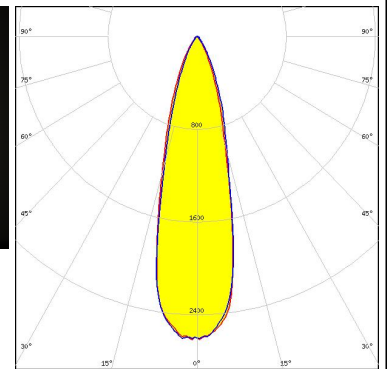
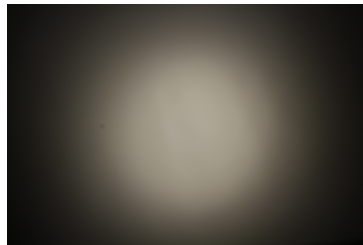

OSRAM

Opto Semiconductors

LED OSLON Square EC
 FWHM / FWTM 26.0° / 49.0°
 Efficiency 85 %
 Peak intensity 3.4 cd/m
 LEDs/each optic 1
 Light colour White
 Required components:

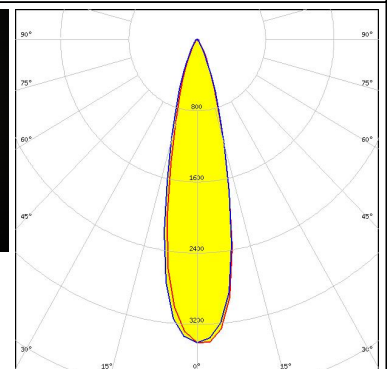
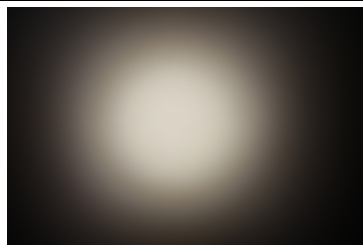

PHOTOMETRIC DATA (MEASURED):

OSRAM Opto Semiconductors

LED SFH 4715S
FWHM / FWTM 22.0° / 48.0°
Efficiency %
LEDs/each optic 1
Light colour White
Required components:

OSRAM Opto Semiconductors

LED SFH 4725S
FWHM / FWTM 23.0° / 46.0°
Efficiency %
LEDs/each optic 1
Light colour White
Required components:

SAMSUNG

LED LH351Z
FWHM / FWTM 26.0° / 50.0°
Efficiency 87 %
Peak intensity 3.5 cd/lm
LEDs/each optic 1
Light colour White
Required components:

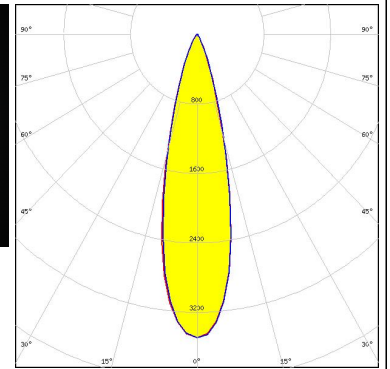
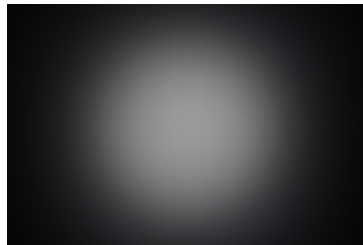

PHOTOMETRIC DATA (SIMULATED):

<p>LUMILEDS</p> <p>LED: LUXEON H50-2</p> <p>FWHM / FWTM: 24.0° / 52.0°</p> <p>Efficiency: 89 %</p> <p>Peak intensity: 3.1 cd/lm</p> <p>LEDs/each optic: 1</p> <p>Light colour: White</p> <p>Required components:</p>	
<p>LUMILEDS</p> <p>LED: LUXEON IR Compact</p> <p>FWHM / FWTM: 14.0° / 29.0°</p> <p>Efficiency: 82 %</p> <p>LEDs/each optic: 1</p> <p>Light colour: White</p> <p>Required components:</p>	
<p>OSRAM Opto Semiconductors</p> <p>LED: OSOLON Square CSSRM2/CSSRM3</p> <p>FWHM / FWTM: 21.0° / 44.0°</p> <p>Efficiency: 91 %</p> <p>Peak intensity: 4.4 cd/lm</p> <p>LEDs/each optic: 1</p> <p>Light colour: White</p> <p>Required components:</p>	
<p>OSRAM Opto Semiconductors</p> <p>LED: SFH 4770S</p> <p>FWHM / FWTM: 17.0° / 39.0°</p> <p>Efficiency: 91 %</p> <p>Peak intensity: 5.9 cd/lm</p> <p>LEDs/each optic: 1</p> <p>Light colour: White</p> <p>Required components:</p>	

PHOTOMETRIC DATA (SIMULATED):

SAMSUNG

LED LH351B
 FWHM / FWTM 27.0° / 54.0°
 Efficiency 89 %
 Peak intensity 2.8 cd/lm
 LEDs/each optic 1
 Light colour White
 Required components:

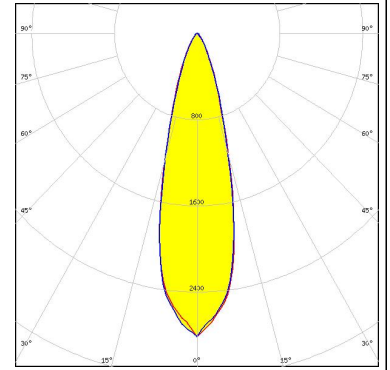

SEOUL SEMICONDUCTOR

LED Z8Y22P
 FWHM / FWTM 25.0° / 56.0°
 Efficiency 84 %
 Peak intensity 2.7 cd/lm
 LEDs/each optic 1
 Light colour White
 Required components:

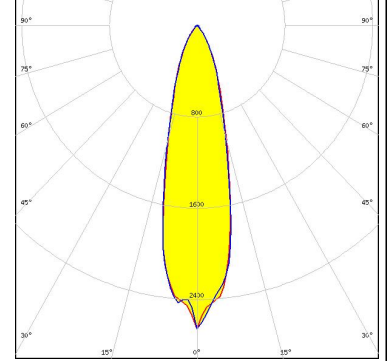

GENERAL INFORMATION:

NOTE: The typical beam angle will be changed by different color, chip size and chip position tolerance. The typical total beam angle is the full angle measured where the luminous intensity is half of the peak value.

MATERIALS:

As part of our continuous research and improvement processes, and to ensure the best possible quality and availability of our products, LEDiL reserves the right to change material grades without notice.

PRODUCT DATA USER AGREEMENT AND DISCLAIMER:

The measured data in the provided downloadable LEDiL Product Datasheets and Mechanical 2D-Drawings is rounded and provided as reference for planning. LEDiL Oy's optical specifications have been verified by conducting performance testing of the products in accordance with the company's quality system. The reported data are averaged results of multiple measurements with typical variation. LEDiL Oy reserves the right to without prior notification make changes and improvements to its products.

LEDiL Oy assumes neither warranty, nor guarantee nor any other liability of any kind for the contents and correctness of the provided data. The provided data has been generated with highest diligence but the provided data may in reality not represent the complete possible variation range of all intrinsic parameters. Therefore, in certain cases a deviation from the provided data could occur.

LEDiL Oy reserves the right to undertake technical changes of its products without further notification which could lead to changes in the provided data. LEDiL Oy assumes no liability of any kind for the possible deviation from any provided data or any other damage resulting from the usage of the provided data.

The user agrees to this disclaimer and user agreement with the download or usage of the provided files.

LEDiL Oy

Joensuunkatu 13
FI-24240 SALO
Finland

LEDiL Inc.

228 West Page Street
Suite D
Sycamore IL 60178
USA

Ledil Optics Technology (Shenzhen) Co., Ltd.

405 , Block B
Casic Motor Building
Shenzhen 518057
P.R.CHINA

Local sales and technical support

[www.ledil.com/
where_to_buy](http://www.ledil.com/where_to_buy)

Shipping locations

Salo, Finland
Hong Kong, China

Distribution Partners

[www.ledil.com/
where_to_buy](http://www.ledil.com/where_to_buy)