

Solid-state Timer H3FA

CSM_H3FA_DS_E_8_2

Please read and understand this catalog before purchasing the products. Please consult OMRON representative if you have any questions or comments. Refer to *Safety Precautions* on page 10.

DIP Model Timer for PC Board Use Provides Contact and Solid-state Output



- Four time ranges are selectable.
Models suffixed -□A□: 1 s, 10 s, 1 min, 10 min.
Models suffixed -□B□: 6 s, 60 s, 6 min, 60 min.
- Timer can be cleaned while mounted on a PC Board with the sealing tape affixed.
- Twenty-four-pin IC socket can be used for mounting the Timer.
- Mountable on a 1-inch pitch rack.
(H 19.5 × W 36.9 × D 17.75 mm)

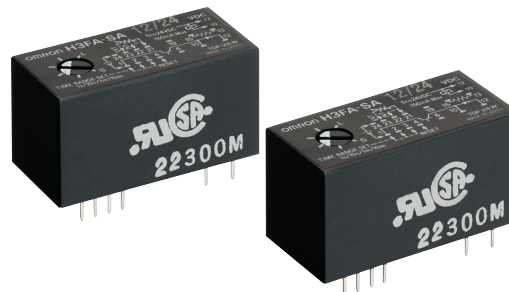

For the most recent information on models that have been certified for safety standards, refer to your OMRON website.

Model Number Structure

Note: This model number legend includes combinations that are not available. Before ordering, please check the *List of Models* on page 2 for availability.

H3FA- □ □ □ □
1 2 3 4

1. Time-limit contact

- None: Contact outputs (SPST-NO + SPST-NC)
- S: Solid-state outputs

2. Time range

- A: 1 s to 10 min
- B: 6 s to 60 min

3. Operation/resetting system

- None: Time-limit operation/power-OFF resetting and external resetting, Integrating operation/power-OFF resetting and external resetting
- U: Instantaneous operation, time-limit resetting/external resetting

4. Supply voltage

For contact output models

- 5DC: 5 V DC
- 6DC: 6 V DC
- 12DC: 12 V DC
- 24DC: 24 V DC

For solid-state output models

- 5/6DC: 5/6 V DC
- 12/24DC: 12/24 V DC

Ordering Information

List of Models

Item	Model	H3FA-A	H3FA-B	H3FA-SA	H3FA-SB	H3FA-AU	H3FA-BU	H3FA-SAU	H3FA-SBU
Operation/resetting system (See note.)		Time-limit operation/power-OFF resetting and external resetting, Integration operation/power-OFF resetting and external resetting				Instantaneous operation, time-limit resetting/external resetting			
Time-limit contact		Contact output (SPST-NO + SPST-NC)		Solid-state output		Contact output (SPST-NO + SPST-NC)		Solid-state output	
Instantaneous contact		---							
Mounting method		Surface mounting (with IC socket or direct mounting on PC Board)							
Time range		1 s to 10 min	6 s to 60 min	1 s to 10 min	6 s to 60 min	1 s to 10 min	6 s to 60 min	1 s to 10 min	6 s to 60 min
Supply voltage	5 V DC	H3FA-A 5DC	H3FA-B 5DC	---	---	H3FA-AU 5DC	H3FA-BU 5DC	---	---
	6 V DC	H3FA-A 6DC	H3FA-B 6DC	---	---	H3FA-AU 6DC	---	---	---
	12 V DC	H3FA-A 12DC	H3FA-B 12DC	---	---	H3FA-AU 12DC	H3FA-BU 12DC	---	---
	24 V DC	H3FA-A 24DC	H3FA-B 24DC	---	---	H3FA-AU 24DC	H3FA-BU 24DC	---	---
	5/6 V DC	---	---	H3FA-SA 5/6DC	H3FA-SB 5/6DC	---	---	H3FA-SAU 5/6DC	H3FA-SBU 5/6DC
	12/24 V DC	---	---	H3FA-SA 12/24DC	H3FA-SB 12/24DC	---	---	H3FA-SAU 12/24DC	H3FA-SBU 12/24DC

Note: The desired operation/resetting system is selected by short-circuiting and opening the specified terminals.

Specifications

Time Ranges

Model	Rated time	Time setting range
H3FA-A	1 s	0.1 to 1 s
H3FA-AU	10 s	1 to 10 s
H3FA-SA	1 min	0.1 to 1 min
H3FA-SAU	10 min	1 to 10 min
H3FA-B	6 s	0.6 to 6 s
H3FA-BU	60 s	6 to 60 s
H3FA-SB	6 min	0.6 to 6 min
H3FA-SBU	60 min	6 to 60 min

- Note:**
- The above timing ranges apply when the internal variable resistor of H3FA is used.
 - The external variable resistor may also be used by opening the terminal connected to the internal variable resistor.
 - Wire the appropriate terminal to select a time setting range. Refer to *Rated Time and Terminal Connections* on page 4 for details.

■ Ratings

Item	H3FA-A/ H3FA-B H3FA-AU/ H3FA-BU	H3FA-SA/ H3FA-SB H3FA-SAU/ H3FA-SBU
Rated supply voltage	5 V DC, 6V DC, 12V DC, 24 V DC (See note 1.)	5/6 V DC (See note 1.) 12/24 V DC (See notes 1 and 2.)
Operating voltage range	5 V DC: 90% to 110% of rated supply voltage 6, 12, 24 V DC: 85% to 110% of rated supply voltage	
Power consumption	5, 6 V DC: approx. 230 mW 12 V DC: approx. 270 mW 24 V DC: approx. 330 mW	5/6 V DC: approx. 80 mW 12 V DC: approx. 100 mW 24 V DC: approx. 240 mW
Control outputs	Contact output: SPST-NO + SPST-NC, 3 A at 250 V AC with resistive load, Minimum applied load: 10 mA at 5 V DC (Failure level: P, reference value)	Solid-state output: 150 mA max. at 30 V DC Residual voltage: 1.0 V max.
Ambient temperature	Operating: -10°C to 55°C (with no icing) Storage: -25°C to 65°C (with no icing)	
Ambient humidity	35% to 85%	

Note: 1. Permissible ripple: 20% max. (3% max. at 5, 6 V DC-operated models)

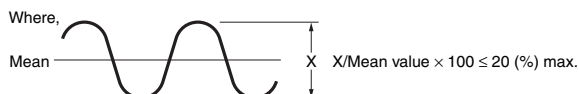

2. Supply voltage can be selected by short-circuiting (12 V DC) or opening (24 V DC) the specified terminals.

■ Characteristics

Accuracy of operating time	±0.5% FS max. (See notes 1 and 3.)
Setting error	0 to 30 % FS max. (at 20°C , at rated voltage)
Reset time	10 ms max.
Influence of voltage	±1% FS max. (2% FS max. for 5, 6, 5/6 V DC-operated models)
Influence of temperature	±5% FS max. (See note 1.)
Insulation resistance	100 MΩ min. (at 500 V DC)
Dielectric strength	1,500 V AC, 50/60 Hz for 1 min (between control output and operating circuit) (See note 2.) 1,000 V AC, 50/60 Hz for 1 min (between contacts not located next to each other) (See note 2.)
Vibration resistance	Destruction: 10 to 55 Hz with 0.375-mm single amplitude in 3 directions for 2 hour each Malfunction: 10 to 55 Hz with 0.25-mm single amplitude in 3 directions for 10 minutes each
Shock resistance	Destruction: 1,000 m/s ² 3 times each in 6 directions on 3 axes Malfunction: 100 m/s ² 3 times each in 6 directions on 3 axes
Life expectancy	Mechanical: 10,000,000 operations min. (under no load at 1,800 operations/h) (See note 2.) Electrical: 100,000 operations min. (3 A at 250 V AC, resistive load at 1,800 operations/h) (See note 2.)
Approved safety standards	UL508, CSA C22.2 No.14
Weight	Contact output models: approx. 15 g Solid-state output models: approx. 10 g

Note: 1. Add or subtract 10 ms to the ratings when using a timer with a rated time of 1 s.

2. Applicable to contact output models.

3. This value assumes that the adjustment on the H3FA is used. (It does not apply if an externally connected resistor is used. For details, refer to *External Resistors and Operating Time (Reference Value)* on page 8 for details.)

■ Life-test Curve (Reference Values)

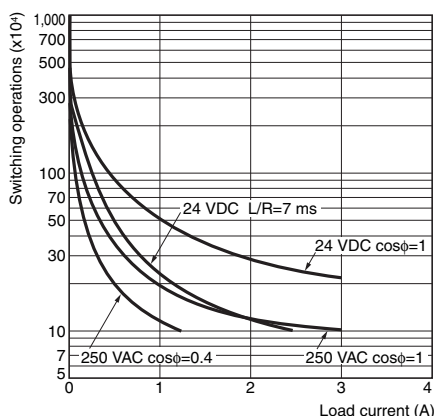

■ Inrush Currents (Reference Values)

Voltage	Applied voltage	Inrush current (peak value)	Time (See note.)
24 VDC	26.4 VDC	1.8 A	0.01 ms
12 VDC	13.2 VDC	1.5 A	0.01 ms
6 VDC	6.6 VDC	1.1 A	0.05 ms
5 VDC	5.5 VDC	1.1 A	0.05 ms

Note: The time of the inrush current is measured in the range shown in the following waveform.

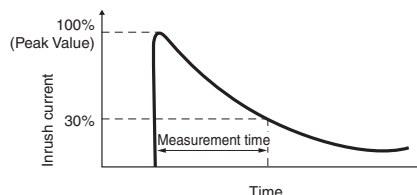

Connections

Block Diagrams

Note: All diagrams are views from the top.

H3FA-A, H3FA-B, H3FA-SA, H3FA-SB

When the input voltage is applied, the CR oscillator circuit in the Timer starts to oscillate via the power supply circuit, the counter circuit counts up to the preset setting, and an output signal is produced. A transistor amplifies this signal to drive the load.

The voltage across the H3FA-SA and -SB (solid-state output loads) is the load input voltage minus the residual voltage when the transistor turns ON.

Contact Output

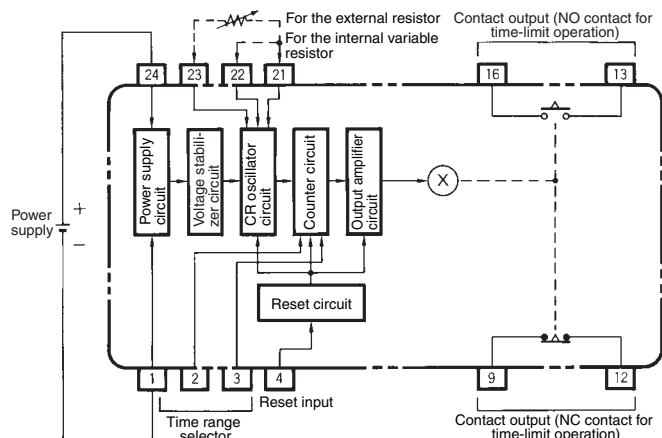

Solid-state Output

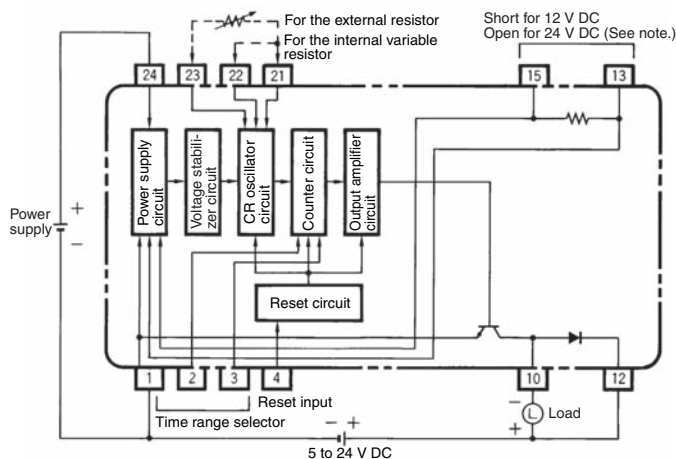

10: Solid-state output terminal
12: Terminal for the internal load surge absorbing diode
Note: When using 12/24 V DC-operated models.

H3FA-AU, H3FA-BU, H3FA-SAU, H3FA-SBU

Contact Output

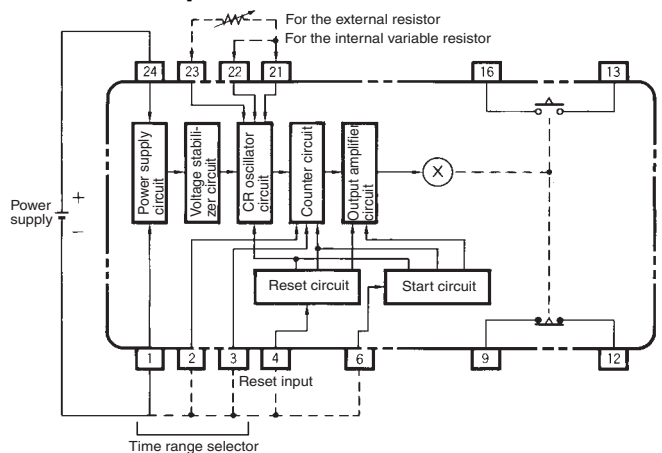

Solid-state Output

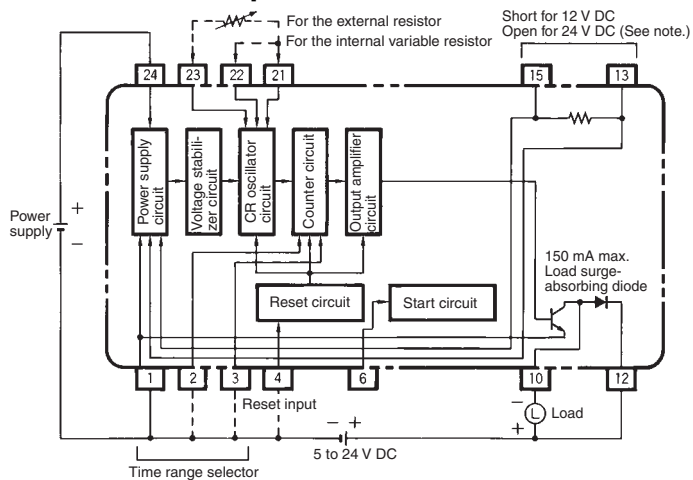

Note: When using a 12/24 V DC-operated model.

Rated Time and Terminal Connections

Model	Terminal connection			
H3FA-A/-SA/-AU/-SAU	1 s	10 s	1 min	10 min
H3FA-B/-SB/-BU/-SBU	6 s	60 s	6 min	60 min

Note: 1. Short-circuit terminals 21 and 22 when using the internal variable resistor of H3FA.
2. An external resistor can also be used by opening terminals 21 and 22. When using an external resistor (1 MΩ for H3FA-A/-SA, 3 MΩ for H3FA-B/-SB), connect it between terminals 21 and 23.

Operation

■ Timing Charts and External Connections

Wire the inputs so that the time range selector (terminals 2 and 3), reset input (terminal 4), and start input (terminal 6) are either connected or not connected to power supply terminal 1. Do not wire the terminals so that an external voltage is applied (*1) to these input terminals or so that the negative side of the power supply is connected to these input terminals but not connected to power supply terminal 1 (*2). No isolation is provided, so if voltage is applied to these terminals, unwanted current paths will be created and destroy the internal circuits.

Voltage Applied to Terminals Other than Power Supply Terminal 1 (*1)

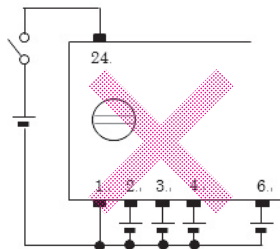

Input Terminals 2, 3, 4, and 6 Connected to the Negative Side of the Power Supply without Being Connected to Power Supply Terminal 1 (*2)

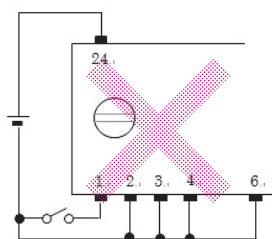

Recommended Wiring

Connection or No Connection to Power Supply Terminal 1

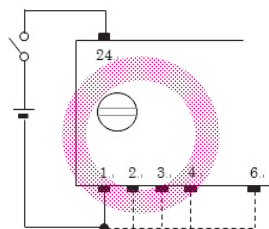

H3FA-A, H3FA-B, H3FA-SA, H3FA-SB

Standard Operation (ON-delay operation)

When the power is turned ON and the set time has elapsed, an output is produced. (Power turns ON when power terminals 1 and 24 are shorted or when terminals 13 and 15 are shorted when using a 12/24 V DC-operated model with a 12 V DC power supply.)

When connecting an external resistor to the Timer, connect it between terminals 21 and 23, and open terminals 21 and 22. Refer to *External Resistors and Operating Time (Reference Value)* on page 8. When operating with an external reset input, short terminals 1 and 4. The Timer will start operating even if reset terminals 1 and 4 are open when the power is turned ON.

In this case, the current flow is approximately 0.1 mA. If a contact is used for control, use a contact with high contact reliability. If a transistor is used for control, use an I_{CEO} of 10 μ A and a V_{CE} (sat) of 0.5 V or less.

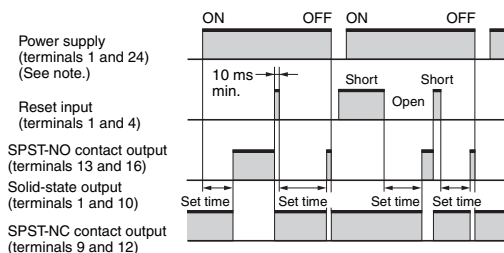

Note: When using a 12/24 V DC-operated model with a 12 V DC power supply, short terminals 13 and 15.

Contact Output (Top View)

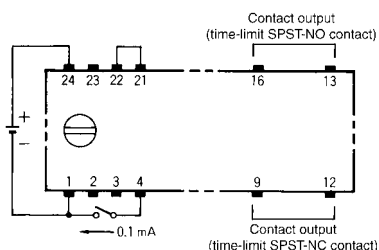

Solid-state Output (Top View)

When using the 12/24 V DC-operated model with a 24 V DC power supply, open terminals 13 and 15.

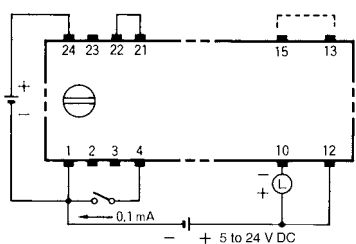

Integration Operation

By opening the terminals connected to the internal variable resistor, Timer operation can be interrupted to enable the Timer to perform time integration operations. Interrupt Timer operation by opening terminals 21 and 22 when using the internal variable resistor or terminals 21 and 23 when using the external resistor. Timer operation can be resumed by reconnecting the terminals.

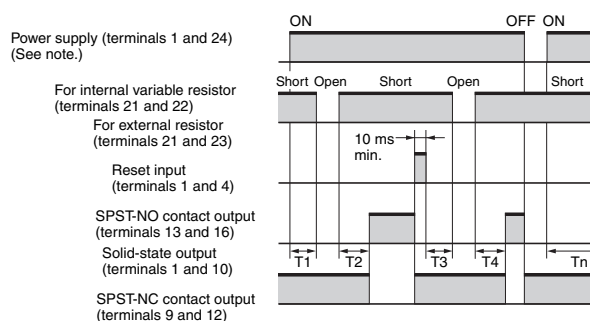

- Note: 1.** Control output is provided when the set time has elapsed ($T_1 + T_2$ or $T_3 + T_4$).
- 2.** When using a 12/24 V DC-operated model with a 12 V DC power supply, short terminals 13 and 15.

Contact Output (Top View)

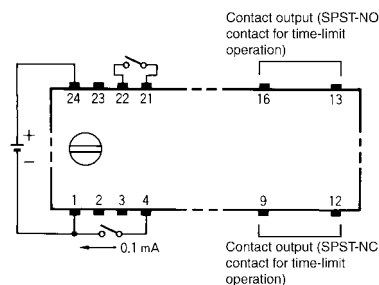

Solid-state Output (Top View)

When using the 12/24 V DC-operated model with a 24 V DC power supply, open terminals 13 and 15.

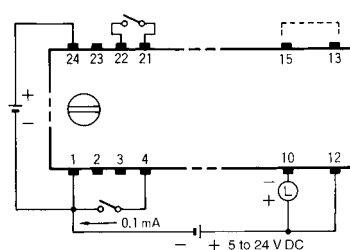

H3FA-AU, H3FA-BU, H3FA-SAU, H3FA-SBU

One-shot Output Operation

Turn ON the power and apply a start input (short terminals 6 and 1). (Power turns ON when power terminals 1 and 24 are shorted or when terminals 13 and 15 are shorted when using a 12/24 V DC-operated model with a 12 V DC power supply.) An output is produced immediately and is reset when the set time has elapsed.

If the reset input is applied (short terminals 4 and 1) with no start input (open terminals 6 and 1) while the Timer is operating, the Timer stops operating and the output is reset.

When operating with an external start or reset input, the current flow from terminal 6 to terminal 1 (start input) or from terminal 4 to terminal 1 (reset input) is approximately 0.1 mA. A highly reliable contact is therefore recommended for the start and reset inputs.

Use an I_{CEO} of 10 μ A and a V_{CE} (sat) of 0.5 V or less for transistor control. When connecting an external resistor to the Timer, connect it between terminals 21 and 23, and open terminals 21 and 22.

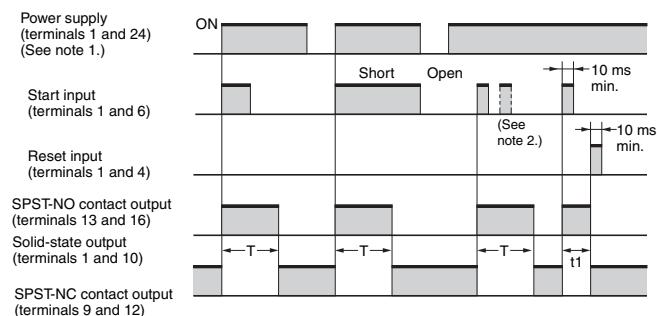

- Note: 1.** When using a 12/24 V DC-operated model with a 12 V DC power supply, short terminals 13 and 15.
2. The start input is disabled during the time limit.
3. T denotes the set time. $t_1 < T$

Contact Output (Top view)

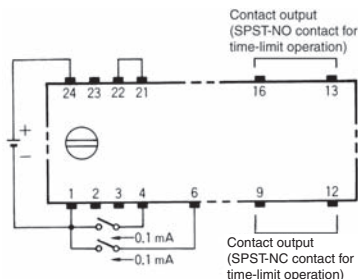

Solid-state Output (Top View)

When using the 12/24 V DC-operated model with a 24 V DC power supply, open terminals 13 and 15.

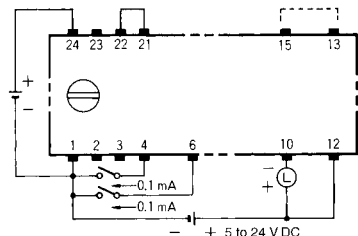

OFF-delay Operation

Turn ON the power and apply a start input (short terminals 6 and 1). (Power turns ON when power terminals 1 and 24 are shorted or when terminals 13 and 15 are shorted when using a 12/24 V DC-operated model with a 12 V DC power supply.) An output is produced immediately. If the start input is applied constantly, however, the reset input can be applied until the set time elapses to stop time-limit operation. (An output is produced when the start input is applied even when the constant reset input is ON prior to the start input.)

The time-limit operation starts when the reset input terminals are opened, and the output is reset when the set time has elapsed. When operating with an external start or reset input, the current flow is approximately 0.1 mA. A highly reliable contact is therefore recommended for the start and reset inputs. Use an I_{CEO} of 10 μ A and a V_{CE} (sat) of 0.5 V or less for transistor control.

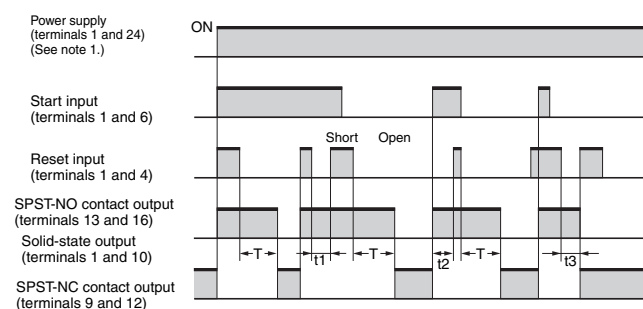

- Note: 1.** When using a 12/24 V DC-operated model with a 12 V DC power supply, short terminals 13 and 15.
2. T denotes the set time. $t_1, t_2,$ and $t_3 < T$

Contact Output (Top view)

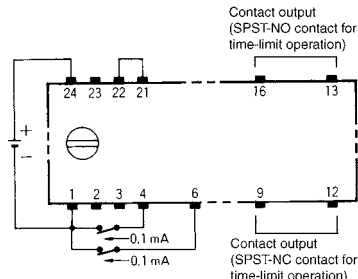

Solid-state Output (Top View)

When using the 12/24 V DC-operated model with a 24 V DC power supply, open terminals 13 and 15.

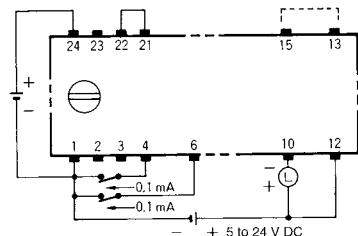

External Resistors and Operating Time (Reference Value)

Refer to the following characteristics diagrams when using an external resistor.

- Use an external resistor rated at about 0.1 W/1 MΩ for H3FA-A, -SA, -AU, and -SAU or 0.1 W/3 MΩ for H3FA-B, -SB, -BU, and -SBU.
- Do not run the leads parallel to power lines and implement other required measures against external noise. Do not use leads that are longer than 30 cm.
- The diagrams on the right show typical data. Setting differences exist for individual products. If accuracy is required, use a variable resistor and adjust the time. (If the leads are too long, the time will vary somewhat and variations in the operating time will increase.)

H3FA-A/-SA/-AU/-SAU

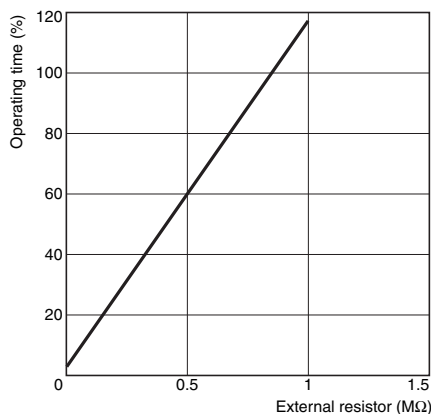

H3FA-B/-SB/-BU/-SBU

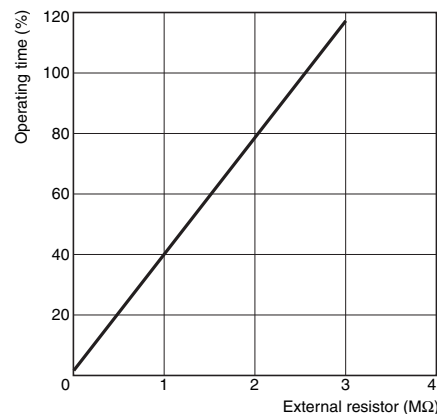

Extending the Reset Time

DIP Timers have a shorter reset time than that of conventional timers for use in solid-state circuit applications. To extend the reset time to that of conventional timers, i.e., about 100 ms, during operation, connect the Timer to a capacitor from the table as shown in the following diagram. The reset time after the set time has elapsed will vary with the load relay, so select an appropriate capacitor for the load relay.

Rated voltage	Capacitor capacity
12 V DC	10 μF, 25 V
24 V DC	4.7 μF, 50 V
5 and 6 V DC	22 μF, 16 V

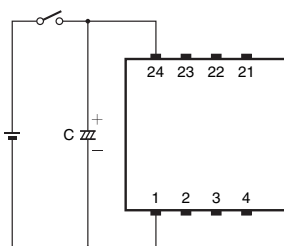

Dimensions

Note: All units are in millimeters unless otherwise indicated.

H3FA-A, H3FA-B, H3FA-SA, H3FA-SB

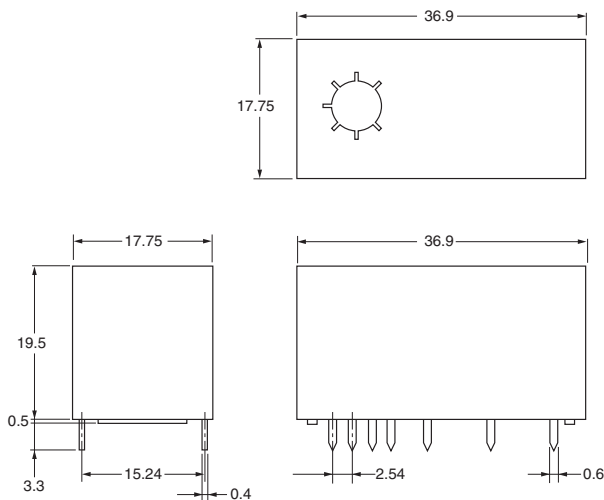
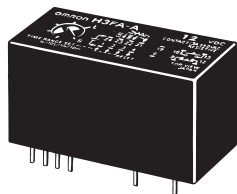

Mounting holes (Top view)

H3FA-A/-B

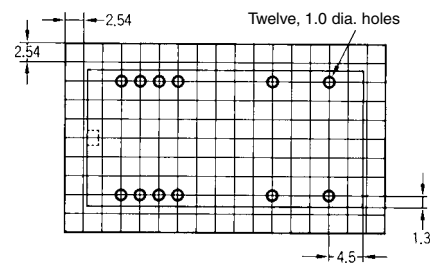

H3FA-SA/-SB

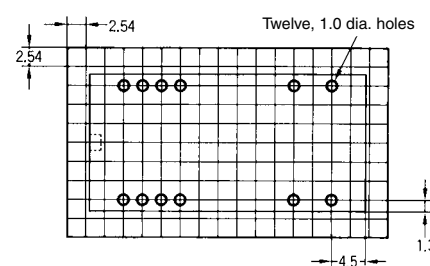

H3FA-AU, H3FA-BU, H3FA-SAU, H3FA-SBU

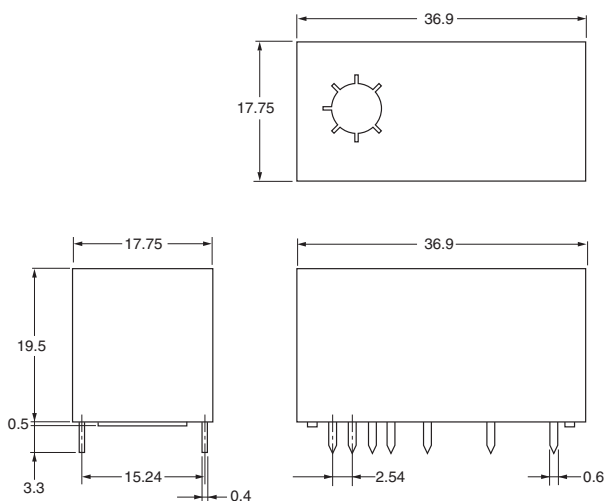
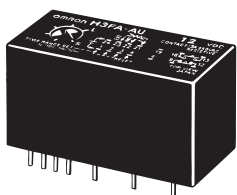

Mounting holes (Top View)

H3FA-AU/-BU

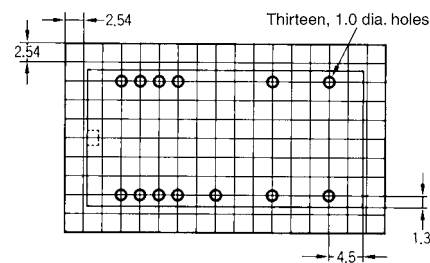

H3FA-SAU/-SBU

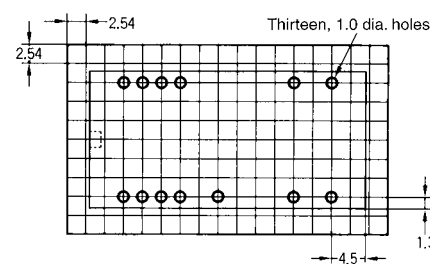

H3FA-□U trimmer hole position

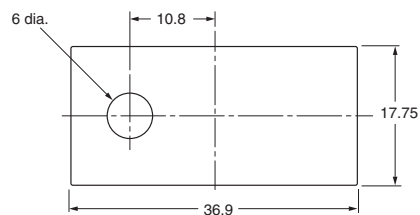

Safety Precautions

■ Precautions for Safe Use

Observe the following items to ensure the safe use of this product.

Environmental Precautions

- Store the H3FA within the specified ratings. If the H3FA has been stored at a temperature of -10°C or lower, let it stand for 3 hours or longer at room temperature before turning ON the power supply.
- Use the H3FA within the specified ratings for operating temperature and humidity.
- Do not operate the H3FA in locations subject to sudden or extreme changes in temperature, or locations where high humidity may result in condensation.
- Do not use the H3FA in locations subject to vibrations or shock. Extended use in such locations may result in damage due to stress.
- Do not use the H3FA in locations subject to excessive dust, corrosive gas, or direct sunlight.

Usage Precautions

- Install a switch or circuit breaker that allows the operator to immediately turn OFF the power, and label it to clearly indicate its function.
- Be sure to wire the terminals correctly.
- Internal elements may be destroyed if a voltage outside the rated voltage is applied.
- Maintain voltage fluctuations in the power supply within the specified range.

■ Precautions for Correct Use

- (After washing) Remove the sealing tape (*) before using.
- Do not use excessive force to turn the time setting knob. Otherwise, it may be damaged.
- When more precise operating time settings are required, measure the operating time prior to use and adjust the time setting knob accordingly.
- Be very careful when handling terminal leads.
- Do not touch terminals with hands or objects that may be statically charged from mounting, transport, or other activities. Otherwise, the terminals may be damaged. Discharge static prior to handling the Timers by touching a grounded object or by using another method.
- Refer to the following diagram for the set values for various operating times.

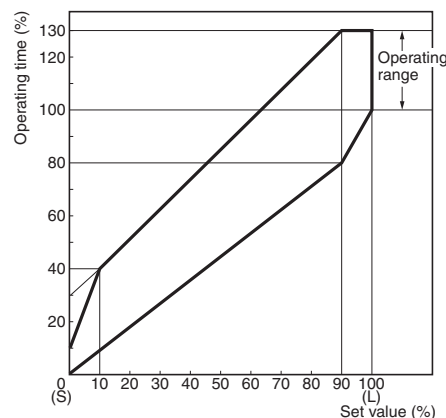

- When cleaning the timer, confirm that the sealing tape (*) is securely in place. Do not clean without this sealing tape affixed. Use alcohol type (IPA, ethanol) solvent, which are less chemically reactive. Note that use of other solvents may damage the materials used for the Timer. Clean the Timer in less than 2 minutes. The cleaning solution must be 50°C or less. The tails of the connecting leads are solder-plated with consideration given to temperature at the time of soldering. When soldering the leads, keep the temperature at $260^{\circ}\text{C} \pm 5^{\circ}\text{C}$ and complete soldering within 10 s. Do not use ultrasonic cleaning..

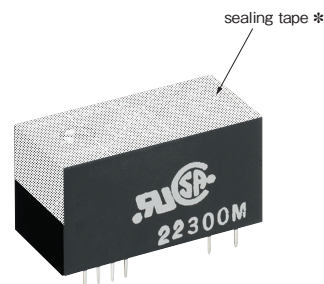

ALL DIMENSIONS SHOWN ARE IN MILLIMETERS.

To convert millimeters into inches, multiply by 0.03937. To convert grams into ounces, multiply by 0.03527.

In the interest of product improvement, specifications are subject to change without notice.

Terms and Conditions Agreement

Read and understand this catalog.

Please read and understand this catalog before purchasing the products. Please consult your OMRON representative if you have any questions or comments.

Warranties.

(a) Exclusive Warranty. Omron's exclusive warranty is that the Products will be free from defects in materials and workmanship for a period of twelve months from the date of sale by Omron (or such other period expressed in writing by Omron). Omron disclaims all other warranties, express or implied.

(b) Limitations. OMRON MAKES NO WARRANTY OR REPRESENTATION, EXPRESS OR IMPLIED, ABOUT NON-INFRINGEMENT, MERCHANTABILITY OR FITNESS FOR A PARTICULAR PURPOSE OF THE PRODUCTS. BUYER ACKNOWLEDGES THAT IT ALONE HAS DETERMINED THAT THE PRODUCTS WILL SUITABLY MEET THE REQUIREMENTS OF THEIR INTENDED USE.

Omron further disclaims all warranties and responsibility of any type for claims or expenses based on infringement by the Products or otherwise of any intellectual property right. (c) Buyer Remedy. Omron's sole obligation hereunder shall be, at Omron's election, to (i) replace (in the form originally shipped with Buyer responsible for labor charges for removal or replacement thereof) the non-complying Product, (ii) repair the non-complying Product, or (iii) repay or credit Buyer an amount equal to the purchase price of the non-complying Product; provided that in no event shall Omron be responsible for warranty, repair, indemnity or any other claims or expenses regarding the Products unless Omron's analysis confirms that the Products were properly handled, stored, installed and maintained and not subject to contamination, abuse, misuse or inappropriate modification. Return of any Products by Buyer must be approved in writing by Omron before shipment. Omron Companies shall not be liable for the suitability or unsuitability or the results from the use of Products in combination with any electrical or electronic components, circuits, system assemblies or any other materials or substances or environments. Any advice, recommendations or information given orally or in writing, are not to be construed as an amendment or addition to the above warranty.

See <http://www.omron.com/global/> or contact your Omron representative for published information.

Limitation on Liability: Etc.

OMRON COMPANIES SHALL NOT BE LIABLE FOR SPECIAL, INDIRECT, INCIDENTAL, OR CONSEQUENTIAL DAMAGES, LOSS OF PROFITS OR PRODUCTION OR COMMERCIAL LOSS IN ANY WAY CONNECTED WITH THE PRODUCTS, WHETHER SUCH CLAIM IS BASED IN CONTRACT, WARRANTY, NEGLIGENCE OR STRICT LIABILITY.

Further, in no event shall liability of Omron Companies exceed the individual price of the Product on which liability is asserted.

Suitability of Use.

Omron Companies shall not be responsible for conformity with any standards, codes or regulations which apply to the combination of the Product in the Buyer's application or use of the Product. At Buyer's request, Omron will provide applicable third party certification documents identifying ratings and limitations of use which apply to the Product. This information by itself is not sufficient for a complete determination of the suitability of the Product in combination with the end product, machine, system, or other application or use. Buyer shall be solely responsible for determining appropriateness of the particular Product with respect to Buyer's application, product or system. Buyer shall take application responsibility in all cases.

NEVER USE THE PRODUCT FOR AN APPLICATION INVOLVING SERIOUS RISK TO LIFE OR PROPERTY OR IN LARGE QUANTITIES WITHOUT ENSURING THAT THE SYSTEM AS A WHOLE HAS BEEN DESIGNED TO ADDRESS THE RISKS, AND THAT THE OMRON PRODUCT(S) IS PROPERLY RATED AND INSTALLED FOR THE INTENDED USE WITHIN THE OVERALL EQUIPMENT OR SYSTEM.

Programmable Products.

Omron Companies shall not be responsible for the user's programming of a programmable Product, or any consequence thereof.

Performance Data.

Data presented in Omron Company websites, catalogs and other materials is provided as a guide for the user in determining suitability and does not constitute a warranty. It may represent the result of Omron's test conditions, and the user must correlate it to actual application requirements. Actual performance is subject to the Omron's Warranty and Limitations of Liability.

Change in Specifications.

Product specifications and accessories may be changed at any time based on improvements and other reasons. It is our practice to change part numbers when published ratings or features are changed, or when significant construction changes are made. However, some specifications of the Product may be changed without any notice. When in doubt, special part numbers may be assigned to fix or establish key specifications for your application. Please consult with your Omron's representative at any time to confirm actual specifications of purchased Product.

Errors and Omissions.

Information presented by Omron Companies has been checked and is believed to be accurate; however, no responsibility is assumed for clerical, typographical or proofreading errors or omissions.