

JNP-SFP-25G-LR-CW-55-C

Juniper Networks® Compatible TAA 25GBase-CWDM SFP28 Transceiver (SMF, 1550nm, 10km, LC, DOM)

Features:

- Up to 25.78Gbps bi-directional data links
- Electrical interface specifications per SFF-8431
- Built-in dual CDR with bypass function
- SFP28 MSA package with duplex LC connector
- CWDM-rated EML Transmitter and APD Receiver
- Up to 10km on 9/125um SMF
- Single +3.3V power supply
- Operating temperature: 0 to 70 Celsius
- SFF-8432 and SFF-8472 Compliance
- 1.8W maximum power consumption
- Class 1 Laser Safety Certified
- RoHS compliant and lead-free



Applications:

- 25x Gigabit Ethernet over CWDM
- Access, Metro and Enterprise
- Mobile Fronthaul CPRI/OBSAI

Product Description

This Juniper Networks® SFP28 transceiver provides 25GBase-CWDM throughput up to 10km over single-mode fiber (SMF) using a wavelength of 1550nm via an LC connector. It is guaranteed to be 100% compatible with the equivalent Juniper Networks® transceiver. This easy to install, hot swappable transceiver has been programmed, uniquely serialized and data-traffic and application tested to ensure that it will initialize and perform identically. Digital optical monitoring (DOM) support is also present to allow access to real-time operating parameters. This transceiver is Trade Agreements Act (TAA) compliant. We stand behind the quality of our products and proudly offer a limited lifetime warranty.

ProLabs' transceivers are RoHS compliant and lead-free.

TAA refers to the Trade Agreements Act (19 U.S.C. & 2501-2581), which is intended to foster fair and open international trade. TAA requires that the U.S. Government may acquire only "U.S. – made or designated country end products."



Regulatory Compliance

- ESD to the Electrical PINs: compatible with MIL-STD-883E Method 3015.4.
- ESD to the LC Receptacle: compatible with IEC 61000-4-3.
- EMI/EMC: compatible with FCC Part 15 Subpart B Rules, EN55022:2010.
- Laser Eye Safety: compatible with FDA 21CFR, EN60950-1& EN (IEC) 60825-1, 2.
- RoHS: compliant with EU RoHS 2.0 directive 2015/863/EU.

CWDM Available Wavelengths

Wavelengths	Min.	Typ.	Max.
47	1464.5	1471	1477.5
49	1484.5	1491	1497.5
51	1504.5	1511	1517.5
53	1524.5	1531	1537.5
55	1544.5	1551	1557.5

Absolute Maximum Ratings

Parameter	Symbol	Min.	Typ.	Max.	Unit	Notes
Maximum Supply Voltage	Vcc	-0.5		4.0	V	
Storage Temperature	Tstg	-40		85	°C	
Operating Case Temperature	Tc	0	25	70	°C	
Relative Humidity	RH	5		95	%	
Data Rate			24.33 25.78		Gbps	
Bit Error Rate	BER			5×10^{-5}		1
Supported Link Length on 9/125µm SMF @ 25.78Gbps	L		10		km	2

Notes:

1. Tested with a PRBS 2³¹-1 test pattern for 25.78Gbps operation.
2. Distances are based on FC-PI-6 Rev. 3.1 and IEEE 802.3 standards.

Electrical Characteristics

Parameter		Symbol	Min.	Typ.	Max.	Unit	Notes
Power Supply Voltage		V _{CC}	3.135	3.3	3.465	V	
Power Supply Current		I _{CC}			545	mA	
Power Dissipation		P _D			1800	mW	
Transmitter							
Differential Input Impedance		Z _{IN}		100		Ω	
Differential Data Input Swing		V _{IN,pp}	180		700	mVp-p	
Tx_Fault	Transmitter Fault	V _{OH}	2.0		Host_Vcc	V	
	Normal Operation	V _{OL}	0		0.8	V	
Tx_Disable	Transmitter Disable	V _{IH}	2.0		Host_Vcc	V	
	Transmitter Enable	V _{IL}	0		0.8	V	
Receiver							
Differential Output Impedance		Z _{OUT}		100		Ω	
Differential Data Output Swing		V _{OUT,pp}	300		850	mVp-p	1
Data Output Rise Time/Fall Time		T _r /T _f	15			ps	2
Rx_LOS	Loss of Signal (LOS)	V _{OH}	2.0		Host_Vcc	V	3
	Normal Operation	V _{OL}	0		0.8	V	3

Notes:

1. Internally AC coupled but requires an external 100Ω differential load termination.
2. 20–80 %.
3. LOS is an open collector output. Should be pulled up with 4.7kΩ on the host board.

Optical Characteristics

Parameter	Symbol	Min.	Typ.	Max.	Unit	Notes
Transmitter						
Launch Optical Power	P _o	0		5	dBm	1
Extinction Ratio	ER	4.5			dB	
Center Wavelength Range	λ _C	1464.5		1557.5	nm	
Transmitter and Dispersion Penalty	TDP			4	dB	
Spectral Width	Δλ			1	nm	2
Optical Return Loss Tolerance	ORLT			21	dB	
Pout @Tx_Disable Asserted	P _{off}			-30	dBm	
Receiver						
Center Wavelength	λ _C	1460		1620	nm	
Receiver Sensitivity (Avg)	S			-19	dBm	1
Receiver Overload	P _{max}	-4			dBm	
Optical Return Loss	ORL	26			dB	
LOS De-Assert	LOSD			-19	dBm	
LOS Assert	LOSA	-35			dBm	
LOS Hysteresis		0.5			dB	

Notes:

1. Class 1 Laser Safety per FDA/CDRH and EN (IEC) 60825 regulations.
2. 20dB spectral width.
3. Measured with PRBS 2³¹-1 at 5×10⁻⁵ BER.

Pin Descriptions

Pin	Symbol	Name/Descriptions	Ref.
1	VeeT	Transmitter Ground (Common with Receiver Ground).	1
2	Tx_Fault	Transmitter Fault. LVTTTL-O.	2
3	Tx_Disable	Transmitter Disable. Laser output disabled on “high” or “open.” LVTTTL-I.	3
4	SDA	2-Wire Serial Interface Data. Same as MOD-DEF2 in INF-8074i. LVTTTL-I/O.	
5	SCL	2-Wire Serial Interface Data. Same as MOD-DEF2 in INF-8074i. LVTTTL-I.	
6	MOD_ABS	Module Absent. Connect to VeeT or VeeR in the module.	4
7	RS0	Rate Select 0. Not used.	5
8	LOS	Loss of Signal Indication. Logic 0 indicates normal operation. LVTTTL-O.	2
9	RS1	Rate Select 1. Not used.	5
10	VeeR	Receiver Ground (Common with Transmitter Ground).	1
11	VeeR	Receiver Ground (Common with Transmitter Ground).	1
12	RD-	Receiver Inverted Data Out. AC Coupled. CML-O.	
13	RD+	Receiver Non-Inverted Data Out. AC Coupled. CML-O.	
14	VeeR	Receiver Ground (Common with Transmitter Ground).	1
15	VccR	Receiver Power Supply.	
16	VccT	Transmitter Power Supply.	
17	VeeT	Transmitter Ground (Common with Receiver Ground).	1
18	TD+	Transmitter Non-Inverted Data In. AC Coupled. CML-I.	
19	TD-	Transmitter Inverted Data In. AC Coupled. CML-O.	
20	VeeT	Transmitter Ground (Common with Receiver Ground).	1

Notes:

1. The module signal ground contacts, VeeR and VeeT, should be isolated from the module case.
2. This contact is an open collector/drain output and should be pulled up to the Host_Vcc with the resistor in the range 4.7kΩ-10kΩ. Pull-ups can be connected to one or several power supplies; however, the host board design shall ensure that no module contract has voltage exceeding module VccT/R+0.5V.
3. Tx_Disable is an input contact with a 4.7kΩ-10kΩ pull-up resistor to the VccT inside the module.
4. MOD_ABS is connected to the VeeT or VeeR in the SFP+ module. The host may pull the contract up to Host_Vcc with a resistor in the range from 4.7kΩ-10kΩ. MOD_ABS is asserted “high” when the SFP+ module is physically absent from a host slot.
5. Internally pulled down per SFF-8431.



Pin-Out of Connector Block on the Host Board

Recommended Host Board Power Supply Filter Network

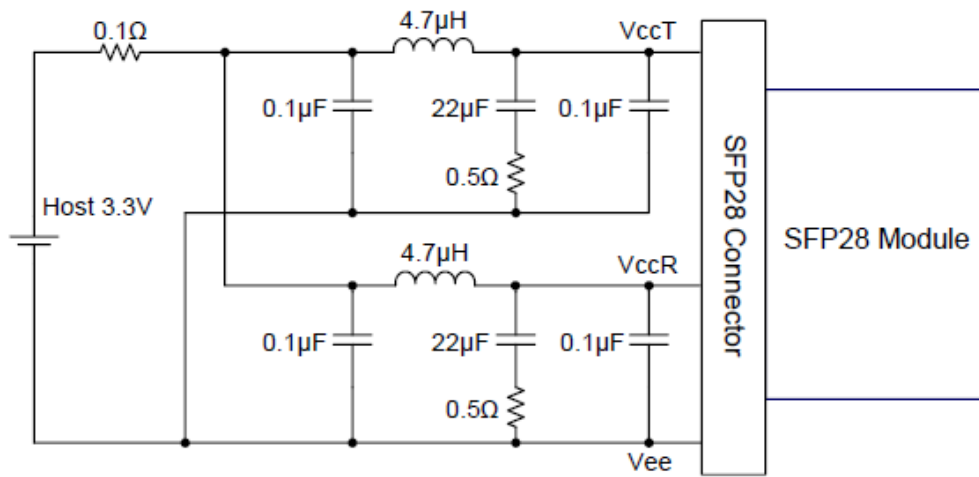

Recommended Application Interface Block Diagram

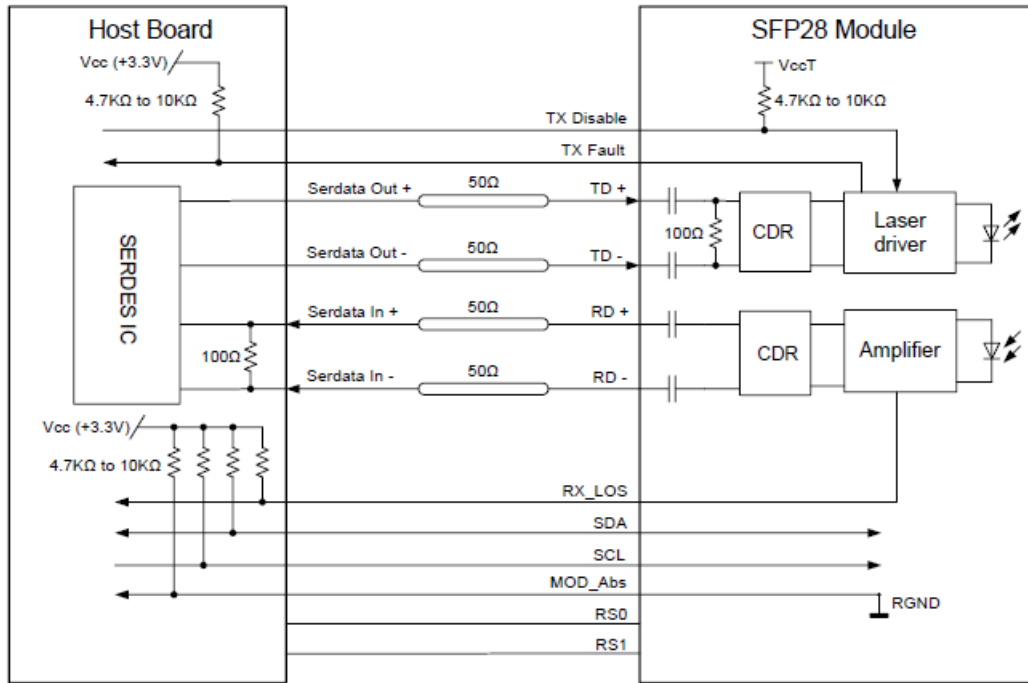

Mechanical Specifications

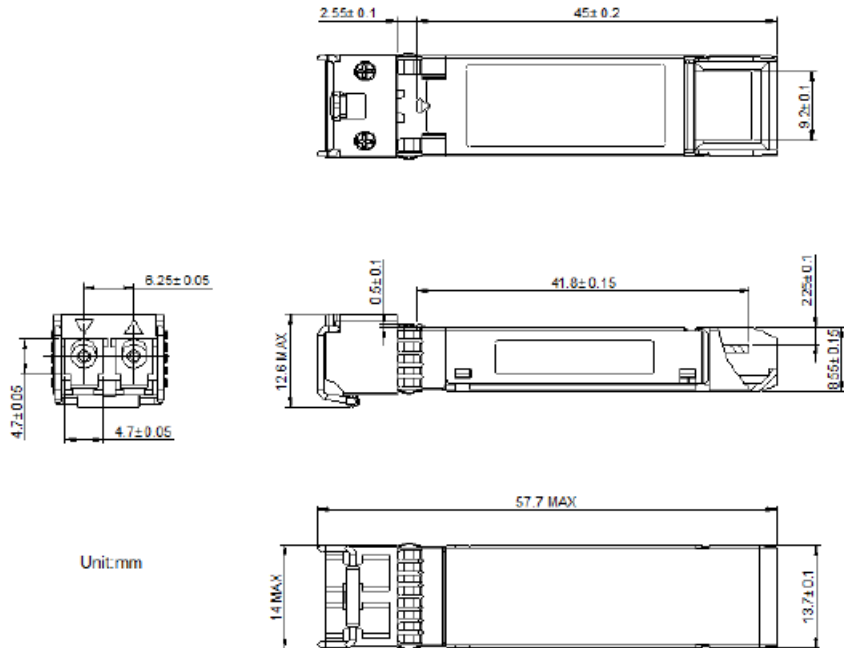

About ProLabs

Our experience comes as standard; for over 15 years ProLabs has delivered optical connectivity solutions that give our customers freedom and choice through our ability to provide seamless interoperability. At the heart of our company is the ability to provide state-of-the-art optical transport and connectivity solutions that are compatible with over 90 optical switching and transport platforms.

Complete Portfolio of Network Solutions

ProLabs is focused on innovations in optical transport and connectivity. The combination of our knowledge of optics and networking equipment enables ProLabs to be your single source for optical transport and connectivity solutions from 100Mb to 400G while providing innovative solutions that increase network efficiency. We provide the optical connectivity expertise that is compatible with and enhances your switching and transport equipment.

Trusted Partner

Customer service is our number one value. ProLabs has invested in people, labs and manufacturing capacity to ensure that you get immediate answers to your questions and compatible product when needed. With Engineering and Manufacturing offices in the U.K. and U.S. augmented by field offices throughout the U.S., U.K. and Asia, ProLabs is able to be our customers best advocate 24 hours a day.

Contact Information

ProLabs US

Email: sales@prolabs.com

Telephone: 952-852-0252

ProLabs UK

Email: salessupport@prolabs.com

Telephone: +44 1285 719 600