

N-Channel Enhancement Mode Power MOSFET

Features

- 40V,5A
 $R_{DS(ON)} < 40m\Omega @ V_{GS}=10V$ TYP:30m Ω
 $R_{DS(ON)} < 60m\Omega @ V_{GS}=4.5V$ TYP:40m Ω
- Lead free and Green Device Available
- Excellent RDS(ON) and Low Gate Charge
- Lead free product Fast switching speed

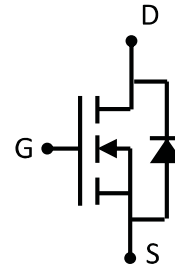

Schematic diagram

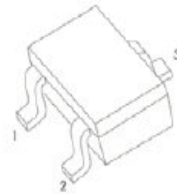

SOT-23

Applications

- Load Switch
- PWM Application
- Power management
- Halogen-free

Package Marking and Ordering Information

Device Marking	Device	Device Package	Reel Size	Tape width	Quantity (PCS)
5040	RM5N40S2	SOT-23	-	-	3000

ABSOLUTE MAXIMUM RATINGS ($T_a=25^\circ\text{C}$ unless otherwise noted)

Parameter	Symbol	Value	Unit
Drain-Source Voltage	V_{DS}	40	V
Gate-Source Voltage	V_{GS}	± 20	V
Continuous Drain Current ($T_a = 25^\circ\text{C}$)	I_D	5	A
Continuous Drain Current ($T_a = 100^\circ\text{C}$)	I_D	3	A
Pulsed Drain Current ⁽¹⁾	I_{DM}	20	A
Power Dissipation ($T_a = 25^\circ\text{C}$)	P_D	1.6	W
Junction Temperature	T_J	150	$^\circ\text{C}$
Storage Temperature	T_{STG}	-40~ +150	$^\circ\text{C}$

MOSFET ELECTRICAL CHARACTERISTICS($T_a=25^{\circ}\text{C}$ unless otherwise noted)

Parameter	Symbol	Test Condition	Min	Type	Max	Unit
Static Characteristics						
Drain-source breakdown voltage	$V_{(BR)DSS}$	$V_{GS} = 0V, I_D = 250\mu A$	40	-	-	V
Zero gate voltage drain current	I_{DSS}	$V_{DS} = 40V, V_{GS} = 0V, T_J = 25^{\circ}\text{C}$	-	-	1	μA
Gate-body leakage current	I_{GSS}	$V_{GS} = \pm 20V, V_{DS} = 0V$	-	-	± 100	nA
Gate threshold voltage	$V_{GS(th)}$	$V_{DS} = V_{GS}, I_D = 250\mu A$	1.0	1.5	2.2	V
Drain-source on-resistance ⁽²⁾	$R_{DS(on)}$	$V_{GS} = 10V, I_D = 4A$	-	30	40	m Ω
		$V_{GS} = 4.5V, I_D = 3A$		40	60	
Dynamic characteristics						
Input Capacitance	C_{iss}	$V_{DS} = 20V, V_{GS} = 0V, f = 1.0\text{MHz}$	-	435	-	pF
Output Capacitance	C_{oss}		-	58	-	
Reverse Transfer Capacitance	C_{rss}		-	35	-	
Switching characteristics						
Turn-on delay time	$t_{d(on)}$	$V_{DD} = 20V, I_D = 4A, R_L = 1\Omega, R_G = 3\Omega$ $V_{GS} = 10V$	-	10	-	ns
Turn-on rise time	t_r		-	8	-	
Turn-off delay time	$t_{d(off)}$		-	29	-	
Turn-off fall time	t_f		-	12	-	
Total Gate Charge	Q_g	$V_{DS} = 20V, I_D = 3A,$ $V_{GS} = 10V$	-	11	-	nC
Gate-Source Charge	Q_{gs}		-	2	-	
Gate-Drain Charge	Q_{gd}		-	2.5	-	
Source-Drain Diode characteristics						
Diode Forward voltage	V_{SD}	$T_J = 25^{\circ}\text{C}, V_{GS} = 0V, I_S = 5A$	-	-	1.2	V
Diode Forward current	I_S	$T_C = 25^{\circ}\text{C}$	-	-	5	A
Body Diode Reverse Recovery Time	t_{rr}	$T_J = 25^{\circ}\text{C}, I_F = 5A, di/dt = 100A/\mu s$		20		ns
Body Diode Reverse Recovery Charge	Q_{rr}	$T_J = 25^{\circ}\text{C}, I_F = 5A, di/dt = 100A/\mu s$		11		uc

Notes: 1. Repetitive Rating: Pulse Width Limited by Maximum Junction Temperature

2. Pulse Test: Pulse Width $\leq 300\mu s$, Duty Cycle $\leq 0.5\%$

RATING AND CHARACTERISTICS CURVES (RM5N40S2)

Figure 1: Output Characteristics

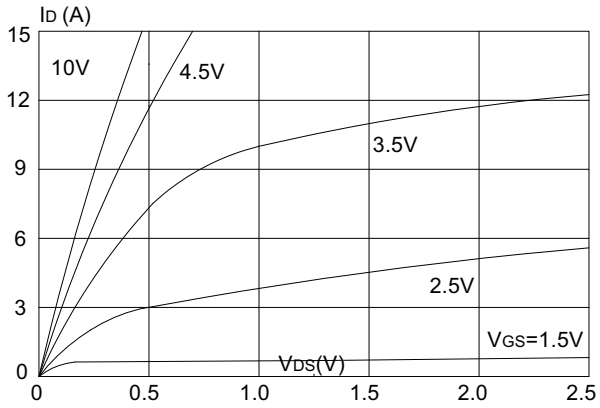

Figure 2: Typical Transfer Characteristics

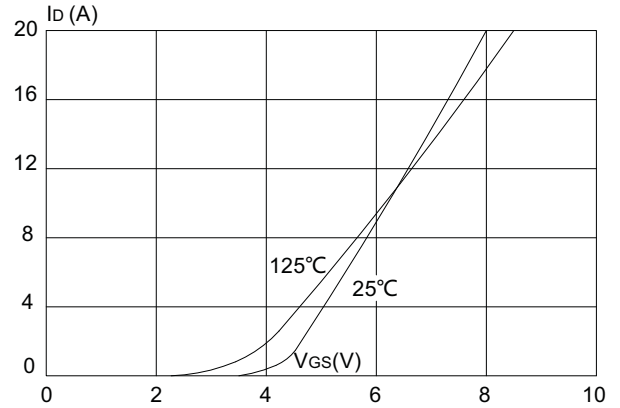

Figure 3: On-resistance vs. Drain Current

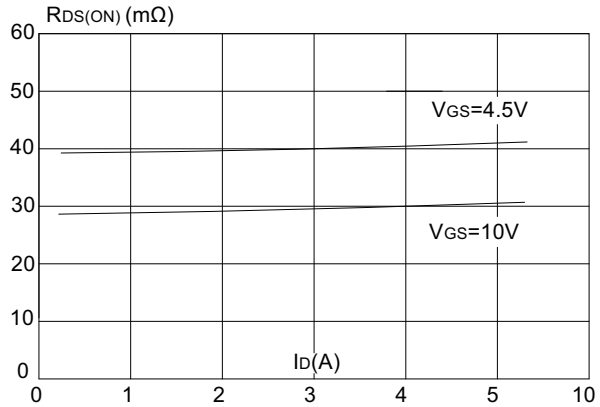

Figure 4: Body Diode Characteristics

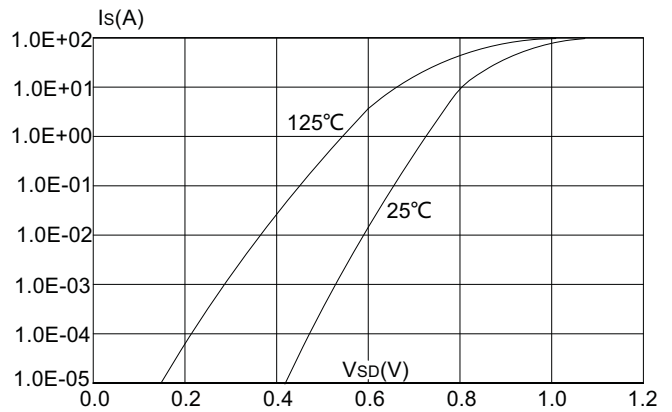

Figure 5: Gate Charge Characteristics

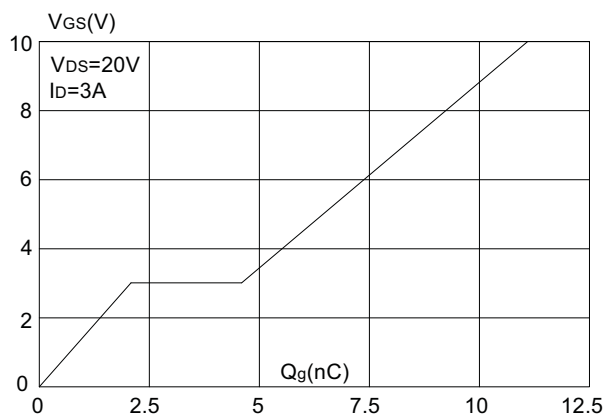
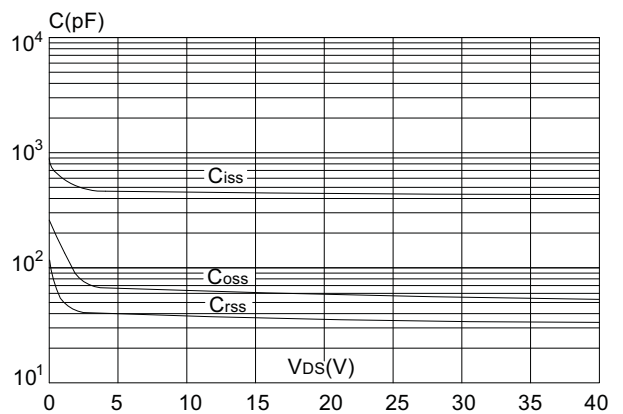

Figure 6: Capacitance Characteristics



RATING AND CHARACTERISTICS CURVES (RM5N40S2)

Figure 7: Normalized Breakdown Voltage vs. Junction Temperature

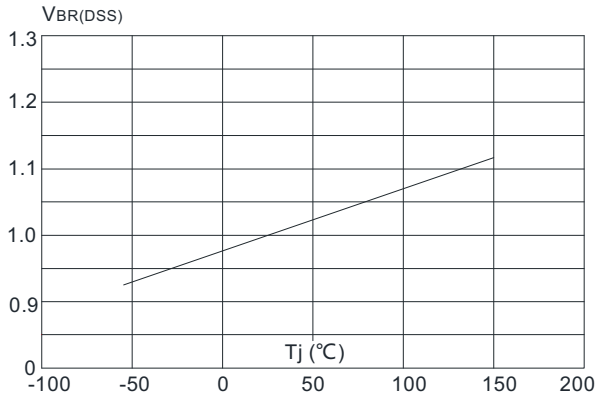

Figure 8: Normalized on Resistance vs. Junction Temperature

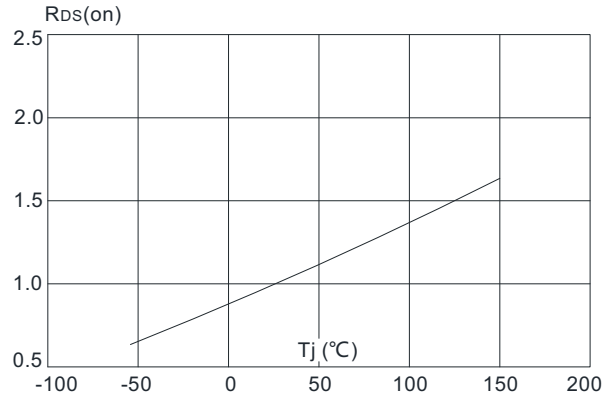

Figure 9: Maximum Safe Operating Area

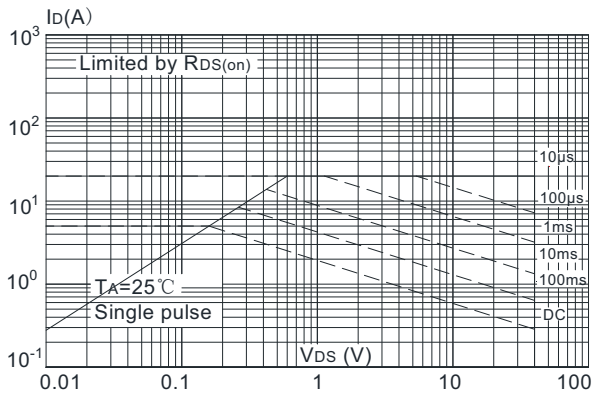

Figure 10: Maximum Continuous Drain Current vs. Ambient Temperature

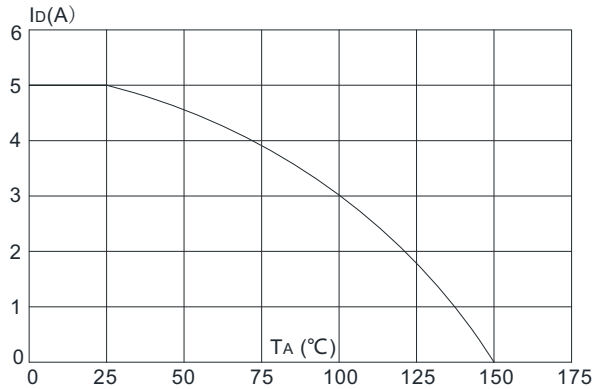
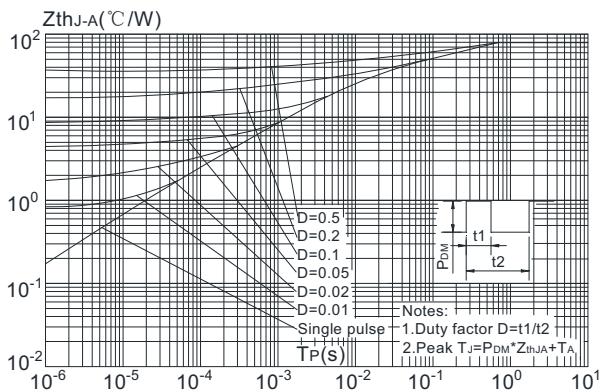

Figure.11: Maximum Effective Transient Thermal Impedance, Junction-to-Ambient



Test Circuit

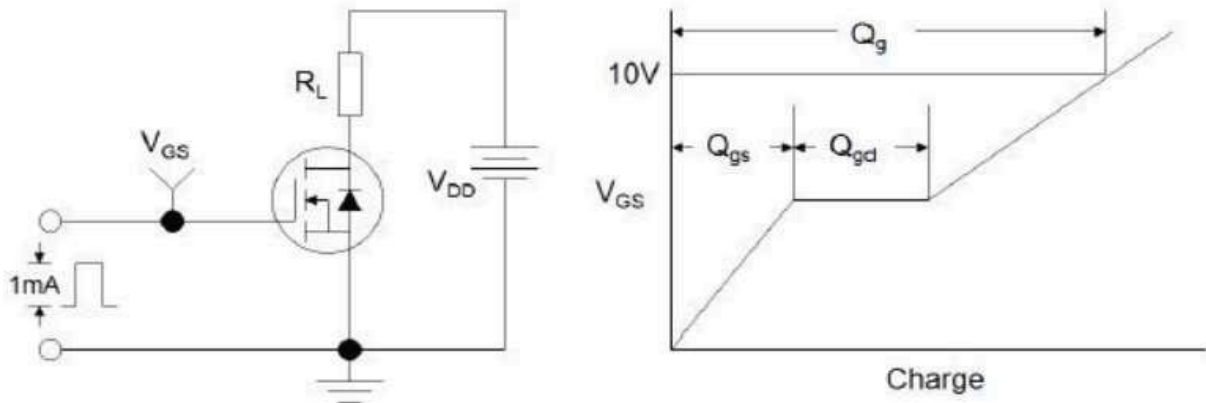

Figure 1: Gate Charge Test Circuit & Waveform

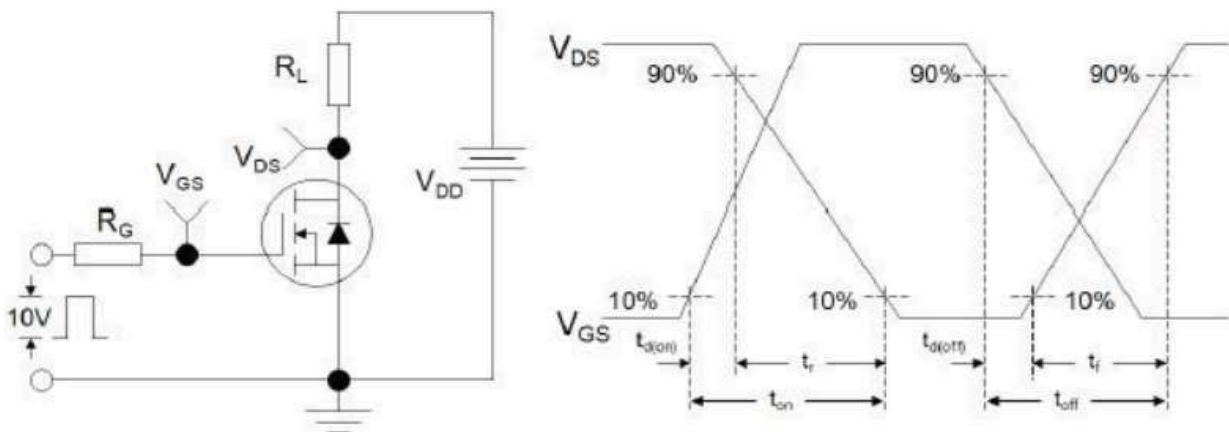

Figure 2: Resistive Switching Test Circuit & Waveforms

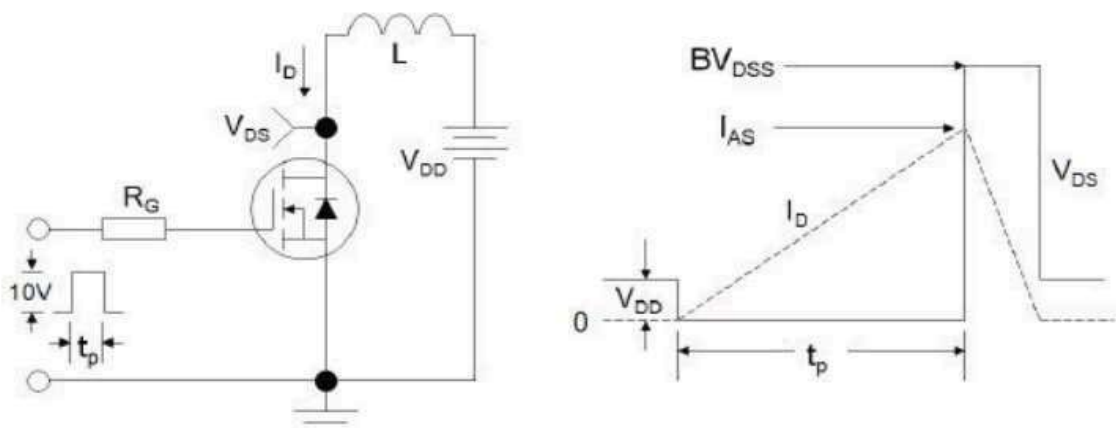
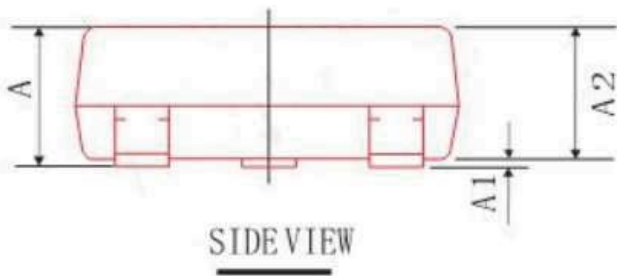
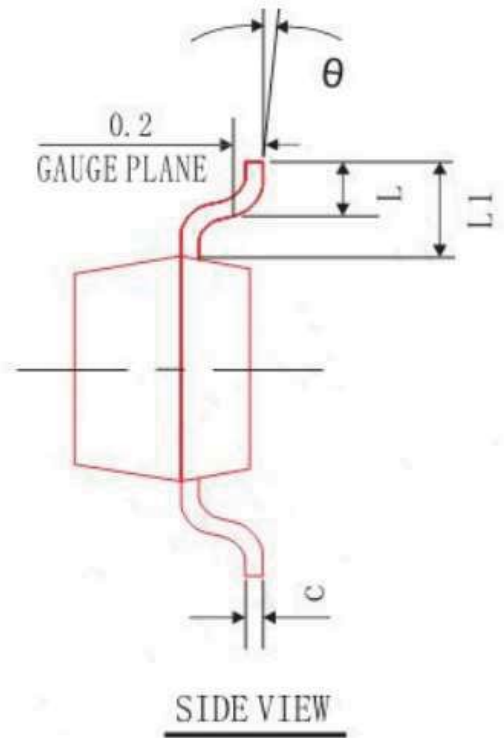
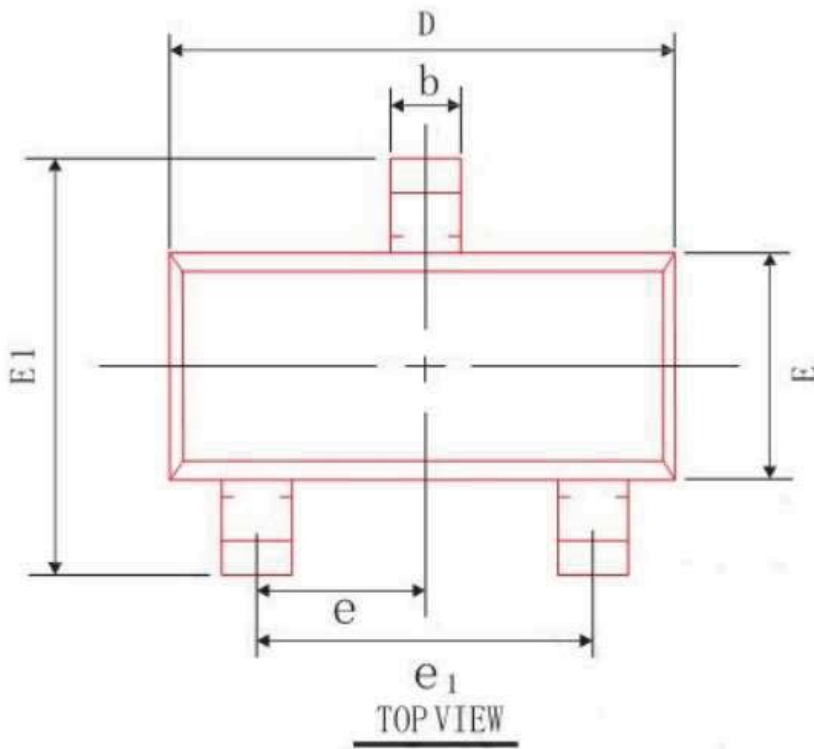

Figure 3: Unclamped Inductive Switching Test Circuit & Waveforms

Package Mechanical Data-SOT-23



SYMBOL	MIN	NOM	MAX
A	0.90	1.05	1.20
A1	0.00	0.05	0.10
A2	0.90	1.00	1.10
b	0.30	0.40	0.50
c	0.08	0.10	0.15
D	2.80	2.90	3.00
E	1.20	1.30	1.40
E1	2.30	2.40	2.50
L	0.30	0.40	0.50
θ	0°	5°	10°
L1	0.55 REF		
e	0.95 BSC		
e_1	1.90 REF		

DISCLAIMER NOTICE

Rectron Inc reserves the right to make changes without notice to any product specification herein, to make corrections, modifications, enhancements or other changes. Rectron Inc or anyone on its behalf assumes no responsibility or liability for any errors or inaccuracies. Data sheet specifications and its information contained are intended to provide a product description only. "Typical" parameters which may be included on RECTRON data sheets and/ or specifications can and do vary in different applications and actual performance may vary over time. Rectron Inc does not assume any liability arising out of the application or use of any product or circuit.

Rectron products are not designed, intended or authorized for use in medical, life-saving implant or other applications intended for life-sustaining or other related applications where a failure or malfunction of component or circuitry may directly or indirectly cause injury or threaten a life without expressed written approval of Rectron Inc. Customers using or selling Rectron components for use in such applications do so at their own risk and shall agree to fully indemnify Rectron Inc and its subsidiaries harmless against all claims, damages and expenditures.