

REVISIONS				
ZONE	REV	DESCRIPTION	DATE	APPROVED

no	Item	material	quantity
1	PCB	FR-4	1
2	Frame	SPCC	1
3	Magnet	Ø12.5x1.5-N38	1
4	Plate	SPCC	1
5	Voice Coil	PL13.3-2.4-7.4	1
6	Diaphragm	PET	1
7	Gasket	black paper	1
8	Silk Screen	black cloth	1

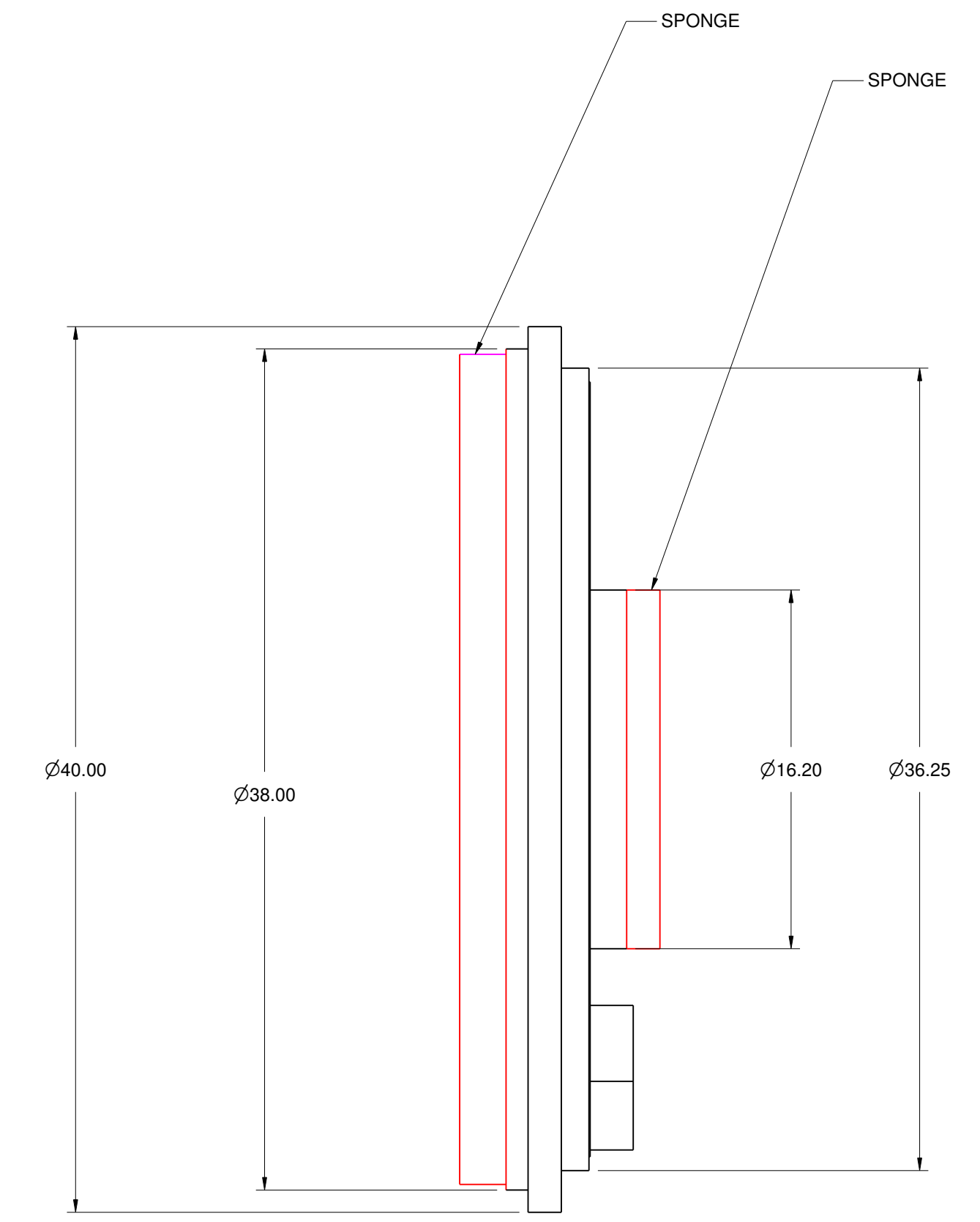
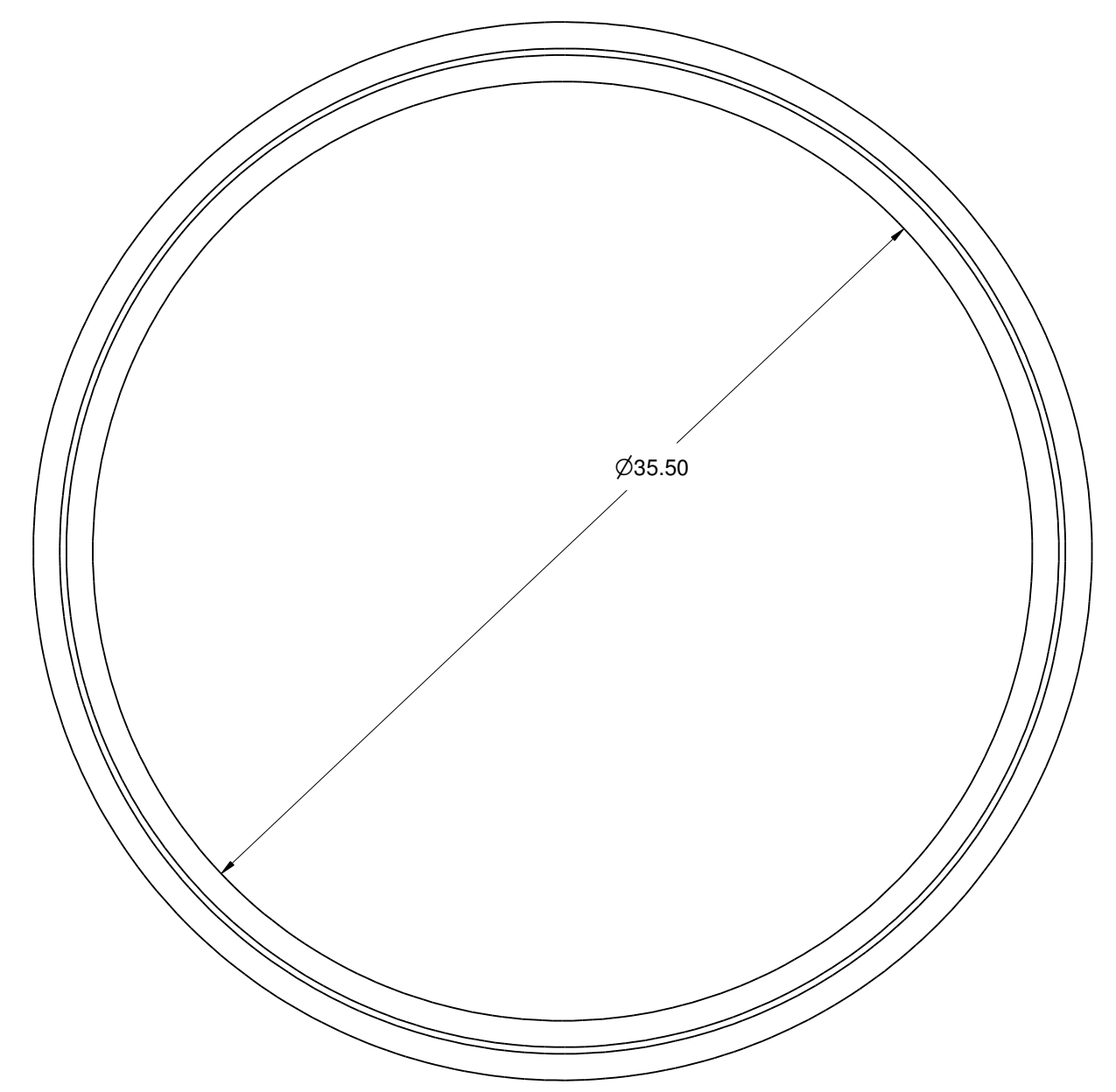
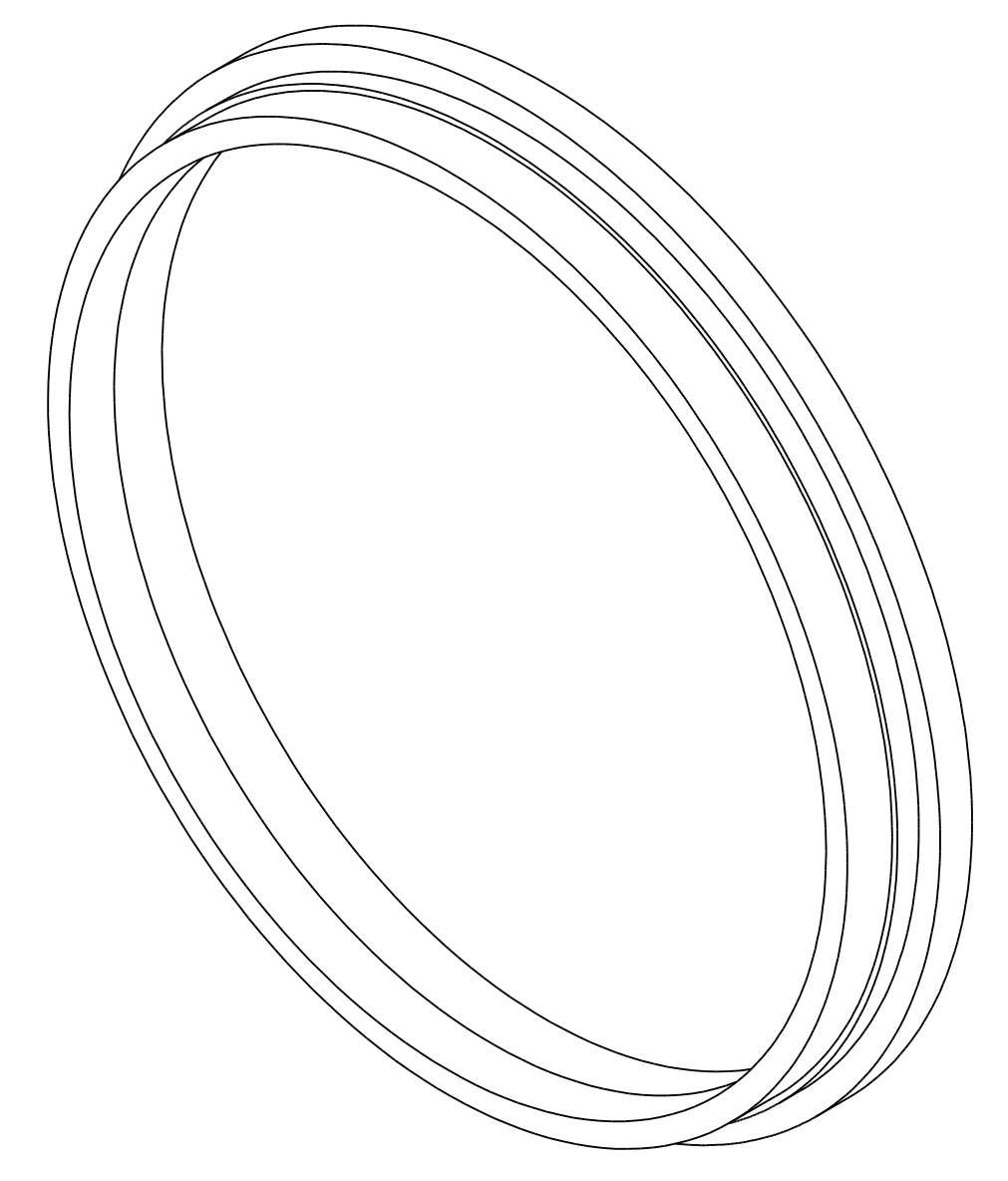
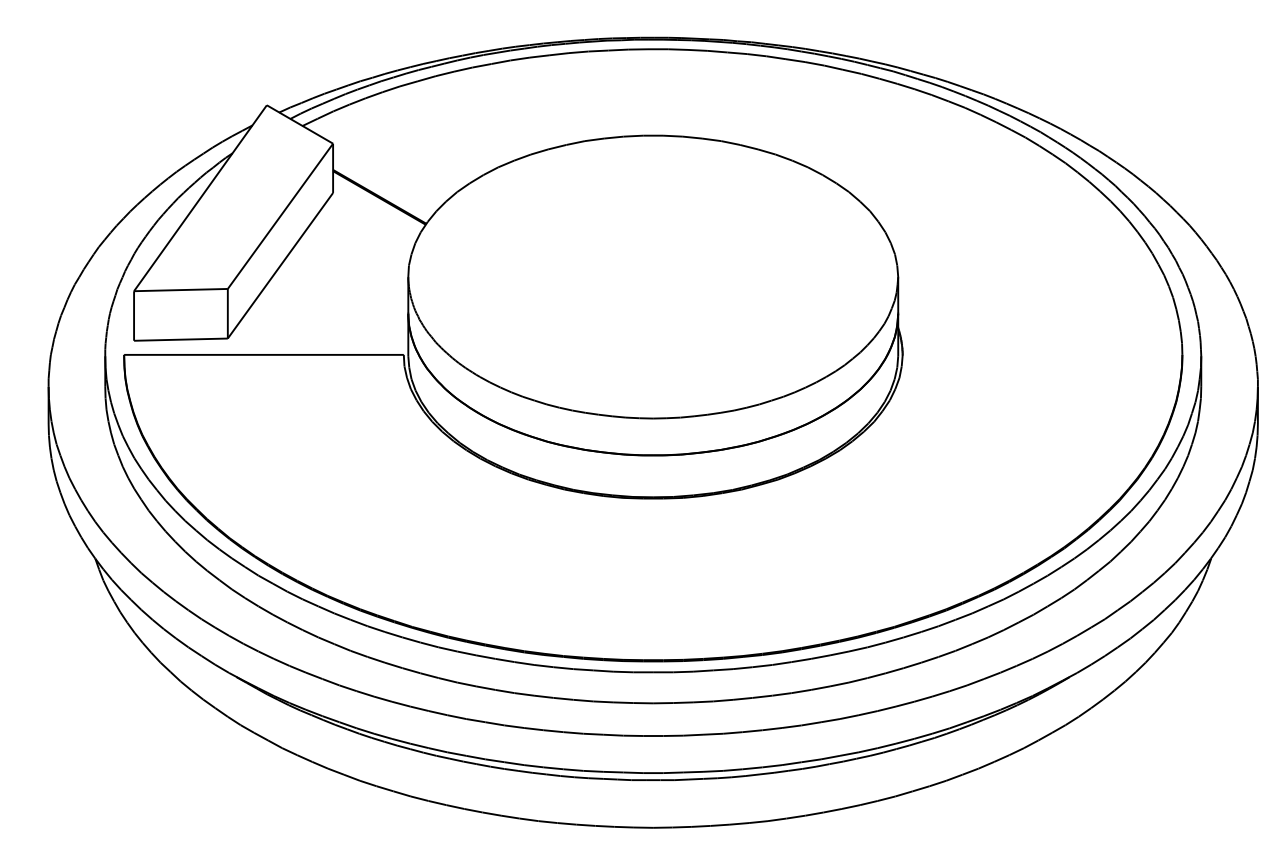
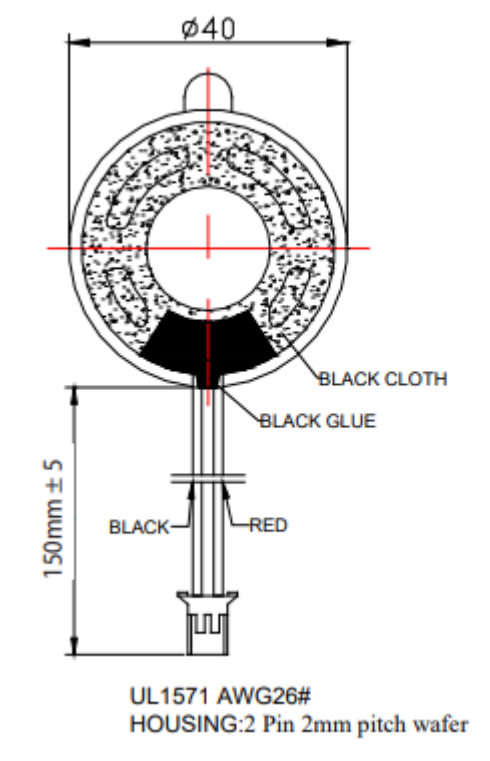
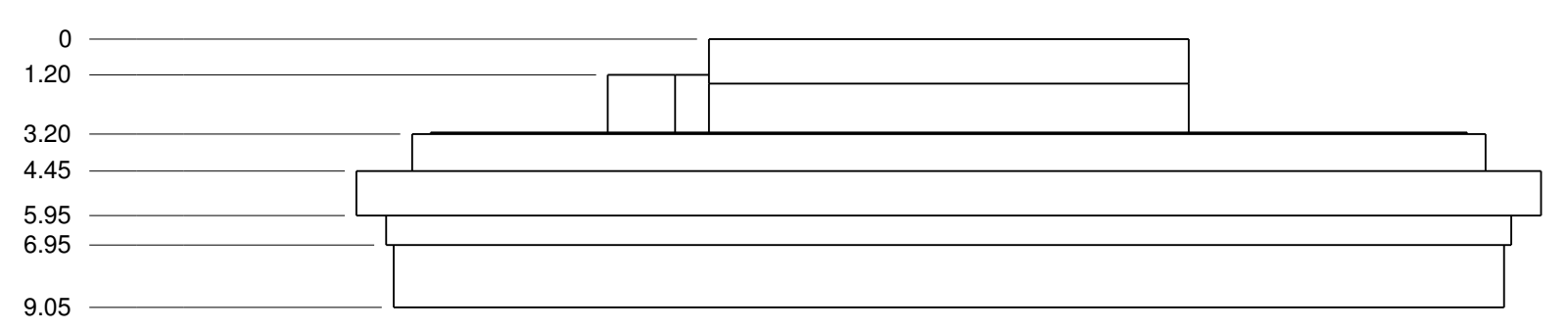
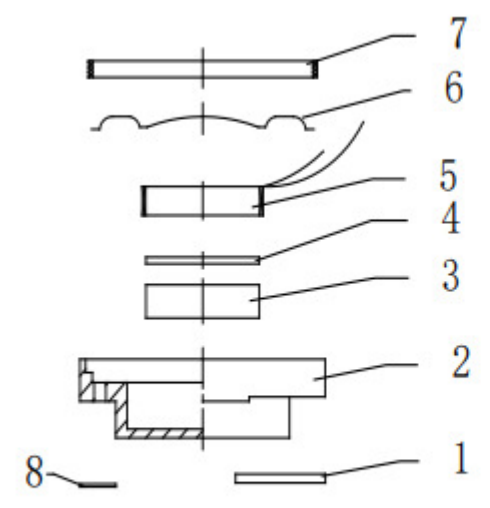

SIZE	FSCM NO.	DWG NO.	REV
D		SP-4005-1	
SCALE	1:1	SHEET	1 OF 1