

Mounting Option

07-M3-0.5 Metric Threaded Inserts

Contact Detail

560-Extender Board Bend (Code 523 Contacts)

.100 [2.54] Contact Spacing x .200 [5.08] Row Spacing

THIS IS A C.A.D. GENERATED DRAWING
DO NOT MAKE MANUAL REVISIONS TO MASTER.



ISSUE NUMBER

ORIGINAL

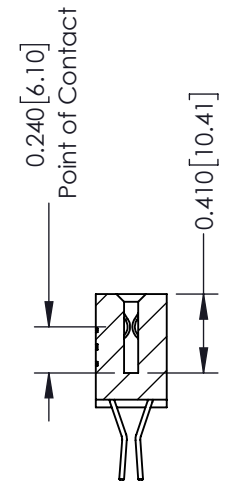
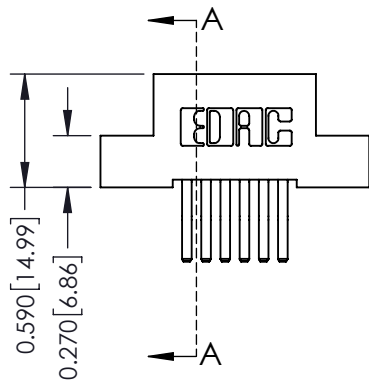
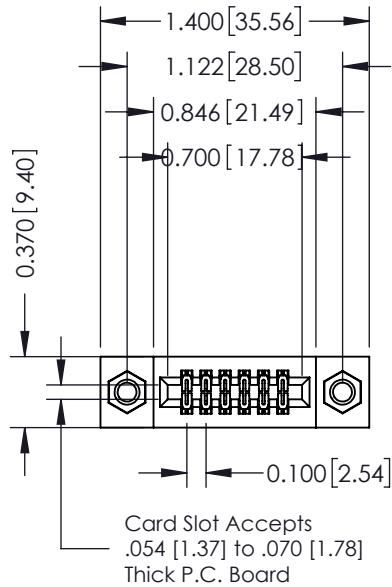

SECTION A-A

See Accompanying Pages for:

- Contact Bend Details
- Mounting Options

342 / 392 Card Edge Connector

Part Number: 392-012-560-207

ACAD REFERENCE NO. 342 ENG MASTER

DRAWN: J.LEE DATE: OCT. 06/09

CHECKED: DATE:

SCALE: NTS SHEET 1 OF 3

DRAWING NUMBER ISSUE

342 Assembly

1



EDAC INC
TORONTO, ONTARIO
CANADA

YOUR CONNECTION TO QUALITY & SERVICE

THESE DRAWINGS AND SPECIFICATIONS ARE THE PROPERTY OF EDAC INC. AND SHALL NOT BE REPRODUCED, OR COPIED OR USED AS THE BASIS FOR THE MANUFACTURE OR SALE OF APPARATUS WITHOUT WRITTEN PERMISSION.



555 Contact Code



556 Contact Code



558 Contact Code



559 Contact Code



560 Contact Code

342 / 392 Series Card Edge Connector
Contact Bend Detail

ACAD REFERENCE NO. 342 ENG MASTER

DRAWN: J.LEE DATE: OCT. 06/09

CHECKED: DATE:

SCALE: NTS SHEET 2 OF 3

DRAWING NUMBER ISSUE

342 Assembly

1



EDAC INC
TORONTO, ONTARIO
CANADA

YOUR CONNECTION TO QUALITY & SERVICE

THESE DRAWINGS AND SPECIFICATIONS
ARE THE PROPERTY OF EDAC INC. AND
SHALL NOT BE REPRODUCED, OR COPIED
OR USED AS THE BASIS FOR THE
MANUFACTURE OR SALE OF APPARATUS
WITHOUT WRITTEN PERMISSION.

THIS IS A C.A.D. GENERATED DRAWING
DO NOT MAKE MANUAL REVISIONS TO MASTER.



ISSUE NUMBER

ORIGINAL



Code x01

Code x02

Code x03

Code x04

Code x07

Code x08

Code x12

342 / 392 Card Edge Connector Mounting Options



EDAC INC
TORONTO, ONTARIO
CANADA

YOUR CONNECTION TO QUALITY & SERVICE

THESE DRAWINGS AND SPECIFICATIONS
ARE THE PROPERTY OF EDAC INC. AND
SHALL NOT BE REPRODUCED, OR COPIED
OR USED AS THE BASIS FOR THE
MANUFACTURE OR SALE OF APPARATUS
WITHOUT WRITTEN PERMISSION.

ACAD REFERENCE NO. 342 ENG MASTER

DRAWN: J.LEE DATE: OCT. 06/09

CHECKED: DATE:

SCALE: NTS SHEET 3 OF 3

DRAWING NUMBER ISSUE

342 Assembly

1