

# CGH21120F

120 W, 1.8 - 2.3 GHz, GaN HEMT  
for WCDMA, LTE, WiMAX

## Description

WolfSpeed's CGH21120F is a gallium nitride (GaN) high electron mobility transistor (HEMT) designed specifically for high efficiency, high gain and wide bandwidth capabilities, which makes the CGH21120F ideal for 1.8-2.3 GHz WCDMA and LTE amplifier applications. The transistor is supplied in a ceramic/metal flange package.

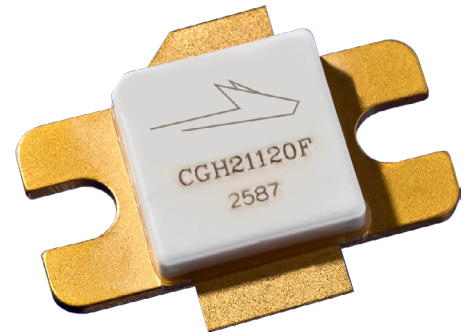

Package Type: 440162  
PN: CGH21120F

## Typical Performance Over 2.0-2.3 GHz ( $T_c = 25^\circ\text{C}$ ) of Demonstration Amplifier

Parameter	2.0 GHz	2.1 GHz	2.2 GHz	2.3 GHz	Unit
Gain @ 43 dBm	14.0	15.0	15.0	14.5	dB
ACLR @ 43 dBm	-36.5	-36.0	-34.0	-33.5	dBc
Drain Efficiency @ 43 dBm	33.5	34.5	36.5	40.0	%

Notes:

<sup>1</sup> Measured in the CGH21120F-AMP amplifier circuit, under WCDMA 3GPP test model 1, 64 DPCH, 67% clipping, PAR = 8.81 dB @ 0.01 % Probability on CCDF.

## Features

- 1.8 - 2.3 GHz Operation
- 15 dB Gain
- -35 dBc ACLR at 20 W  $P_{AVE}$
- 35% Efficiency at 20 W  $P_{AVE}$
- High Degree of DPD Correction can be Applied

 Large Signal Models Available for ADS and MWO





## Absolute Maximum Ratings (not simultaneous) at 25°C Case Temperature

Parameter	Symbol	Rating	Units	Conditions
Drain-Source Voltage	$V_{DSS}$	120	V	25°C
Gate-to-Source Voltage	$V_{GS}$	-10, +2		
Power Dissipation	$P_{DISS}$	56	W	
Storage Temperature	$T_{STG}$	-65, +150	°C	
Operating Junction Temperature	$T_J$	225		
Maximum Forward Gate Current	$I_{GMAX}$	30	mA	25°C
Maximum Drain Current <sup>1</sup>	$I_{DMAX}$	12	A	
Soldering Temperature <sup>2</sup>	$T_S$	245	°C	
Screw Torque	$\tau$	40	in-oz	
Thermal Resistance, Junction to Case <sup>3</sup>	$R_{\theta JC}$	1.5	°C/W	85°C
Case Operating Temperature <sup>3</sup>	$T_C$	-40, +150	°C	

### Notes:

<sup>1</sup> Current limit for long term, reliable operation

<sup>2</sup> Refer to the Application Note on soldering at [wolfspeed.com/rf/document-library](http://wolfspeed.com/rf/document-library)

<sup>3</sup> Measured for the CGH21120F at  $P_{DISS} = 56$  W

## Electrical Characteristics ( $T_C = 25^\circ\text{C}$ )

Characteristics	Symbol	Min.	Typ.	Max.	Units	Conditions
<b>DC Characteristics</b>						
Gate Threshold Voltage	$V_{GS(th)}$	-3.8	-3.0	-2.3	$V_{DC}$	$V_{DS} = 10$ V, $I_D = 28.8$ mA
Gate Quiescent Voltage	$V_{GS(Q)}$	—	-2.7	—		$V_{DS} = 28$ V, $I_D = 0.5$ A
Saturated Drain Current	$I_{DS}$	23.2	28.0	—	A	$V_{DS} = 6.0$ V, $V_{GS} = 2.0$ V
Drain-Source Breakdown Voltage	$V_{BR}$	84	—	—	$V_{DC}$	$V_{GS} = -8$ V, $I_D = 28.8$ mA
<b>RF Characteristics (<math>T_C = 25^\circ\text{C}</math>, <math>F_0 = 2.15</math> GHz unless otherwise noted)</b>						
Saturated Output Power <sup>2, 3, 4</sup>	$P_{SAT}$	—	110	—	W	$V_{DD} = 28$ V, $I_{DQ} = 0.5$ A
Pulsed Drain Efficiency <sup>2</sup>	$\eta$	—	70	—	%	$V_{DD} = 28$ V, $I_{DQ} = 0.5$ A, $P_{OUT} = P_{SAT}$
Modulated Gain <sup>5</sup>	$G_{SS}$	13.5	15	—	dB	$V_{DD} = 28$ V, $I_{DQ} = 0.5$ A, $P_{OUT} = 43$ dBm
WCDMA Linearity <sup>5</sup>	ACLR	—	-35	-30	dBc	
Modulated Drain Efficiency <sup>5</sup>	$\eta$	29	35	—	%	
Output Mismatch Stress	VSWR	—	—	10 : 1	$\Psi$	No damage at all phase angles, $V_{DD} = 28$ V, $I_{DQ} = 0.5$ A, $P_{OUT} = 20$ W CW
<b>Dynamic Characteristics</b>						
Input Capacitance <sup>6</sup>	$C_{GS}$	—	66	—	pF	$V_{DS} = 28$ V, $V_{GS} = -8$ V, $f = 1$ MHz
Output Capacitance <sup>6</sup>	$C_{DS}$	—	12	—		
Feedback Capacitance	$C_{GD}$	—	1.6	—		

### Notes:

<sup>1</sup> Measured on wafer prior to packaging

<sup>2</sup> Pulse Width = 40 $\mu$ s, Duty Cycle = 5%

<sup>3</sup>  $P_{SAT}$  is defined as  $I_G = 10$  mA peak

<sup>4</sup> Measured in CGH21120F-AMP

<sup>5</sup> Single Carrier WCDMA, 3GPP Test Model 1, 64 DPCH, 67 % Clipping, PAR = 8.81 dB @ 0.01 % Probability on CCDF

<sup>6</sup> Includes package and internal matching components



Typical Performance

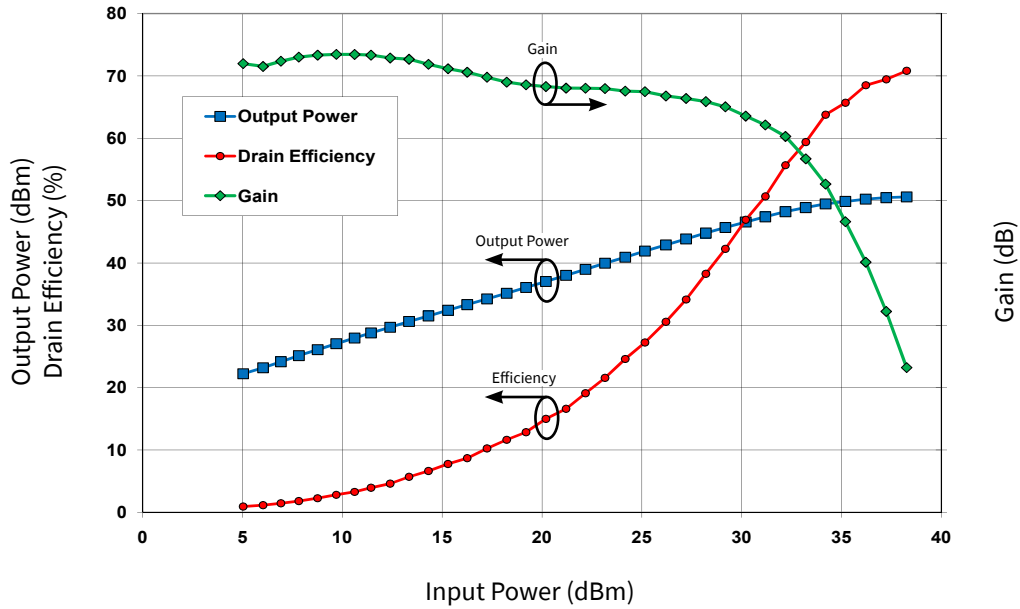

**Figure 1.** Typical Pulsed Characteristics Output Power, Drain Efficiency, and Gain vs Input Power measured in CGH21120F-AMP Amplifier Circuit  
 $V_{DS} = 28\text{ V}$ ,  $I_{DS} = 0.5\text{ A}$ , Freq = 2.15 MHz, Pulse Width = 40 $\mu\text{s}$ , Duty Cycle = 5%

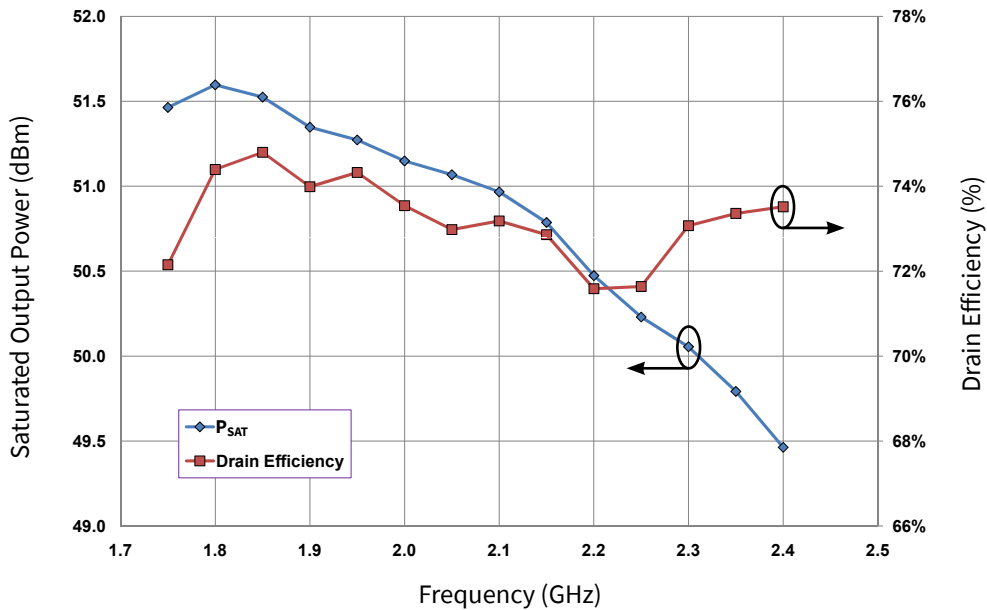

**Figure 2.** Typical Pulsed Saturated Power vs Frequency measured in CGH21120F-AMP Amplifier Circuit  
 $V_{DS} = 28\text{ V}$ ,  $I_{DS} = 0.5\text{ A}$ ,  $P_{SAT} = 10\text{ mA}$   $I_{GS}$  Peak, Pulse Width = 40 $\mu\text{s}$ , Duty Cycle = 5 %

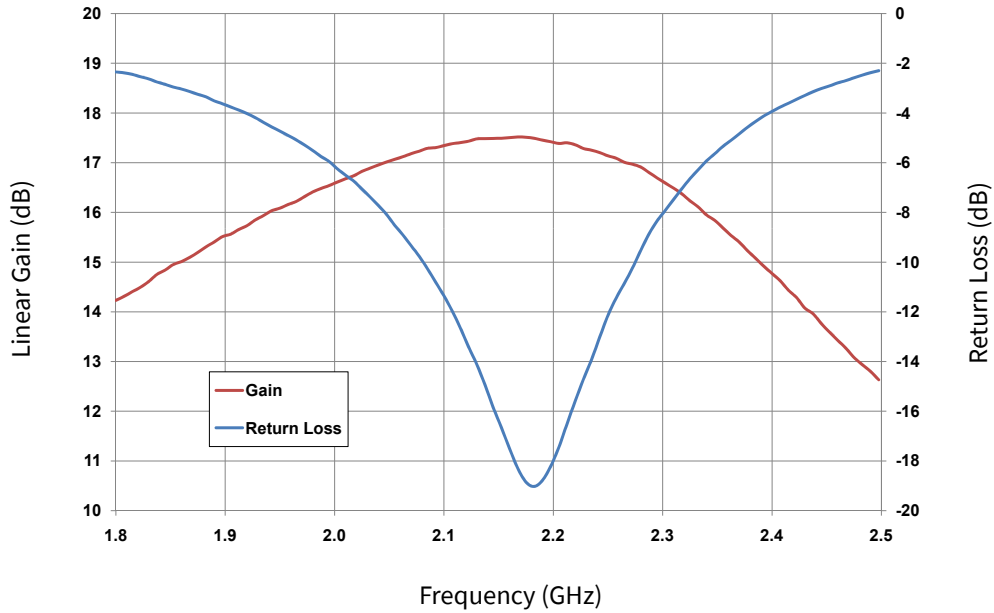

**Figure 3.** Typical Small Signal Gain and Return Loss vs Frequency measured in CGH21120F-AMP Amplifier Circuit  
 $V_{DS} = 28\text{ V}, I_{DS} = 0.5\text{ A}$

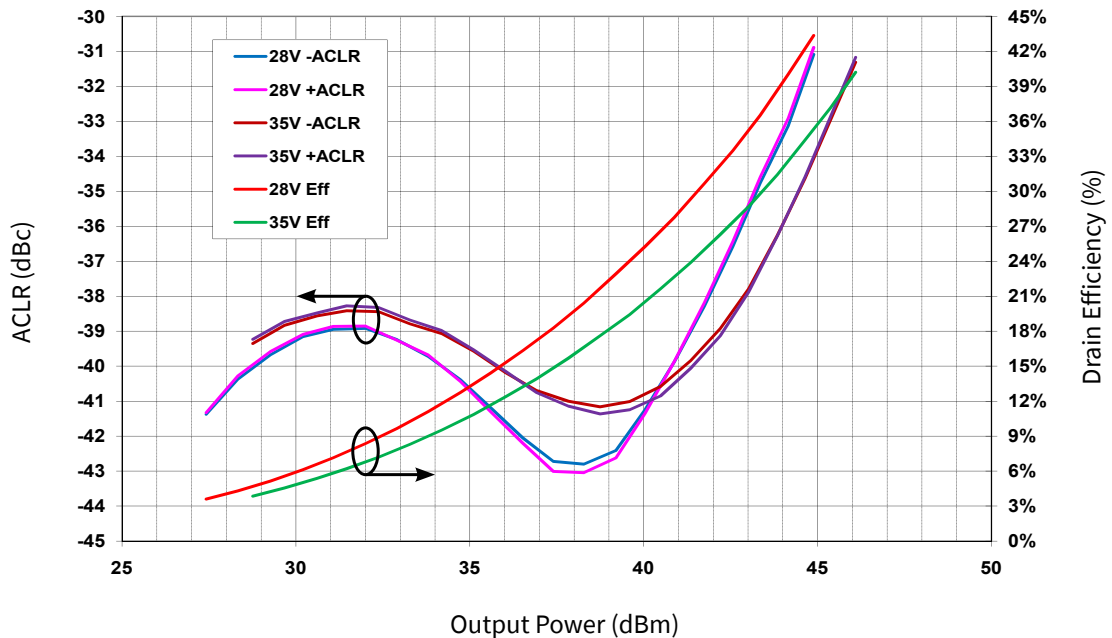

**Figure 4.** Typical WCDMA Characteristics ACLR and Drain Efficiency vs Output Power measured in CGH21120F-AMP Amplifier Circuit  
 3GPP Test Model 1, 64 DPCH, 67% Clipping, 8.81 dB PAR @ 0.01%  
 $V_{DS} = 28\text{ V}$  and  $35\text{ V}, I_{DS} = 0.5\text{ A}, \text{Frequency} = 2.15\text{ GHz}$

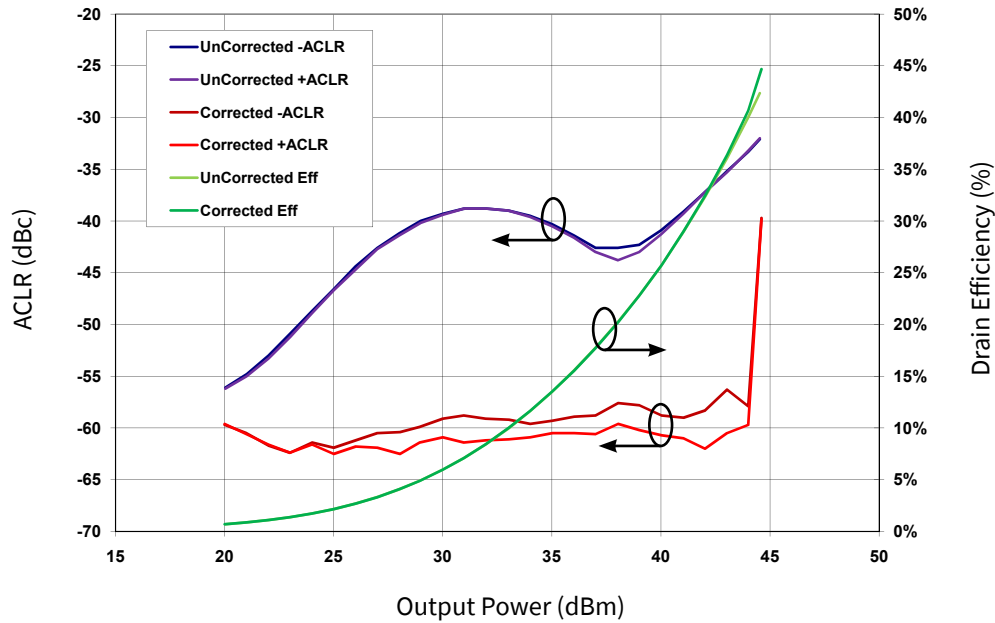

**Figure 5.** WCDMA Characteristics with and without DPD Correction ACLR and Drain Efficiency vs Output Power measured in CGH21120F-AMP Amplifier Circuit Single Channel WCDMA 6.5 dB PAR with CFR  $V_{DS} = 28\text{ V}$ ,  $I_{DS} = 0.5\text{ A}$ , Frequency = 2.14 GHz

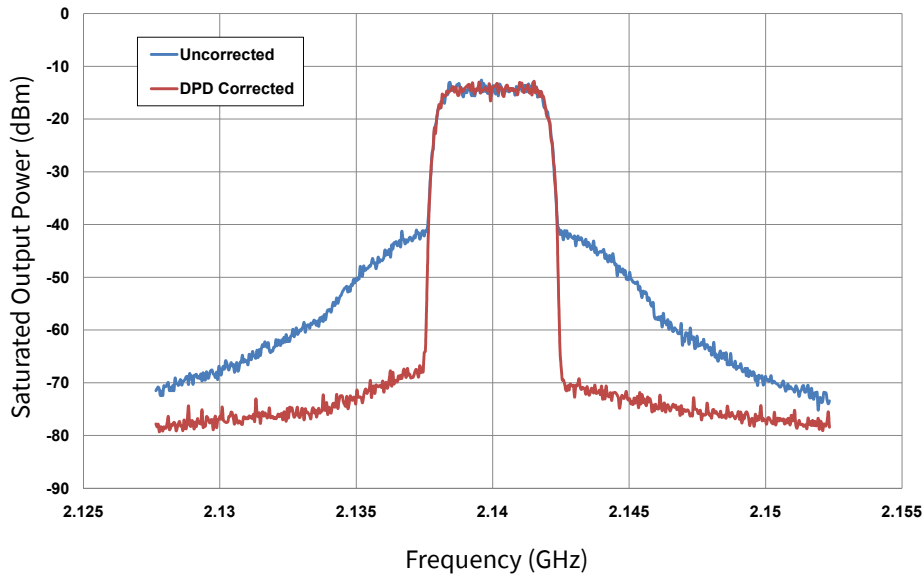

**Figure 6.** WCDMA Linearity with DPD Linearizer measured in CGH21120F-AMP Amplifier Circuit Single Channel WCDMA 6.5 dB PAR with CFR  $V_{DS} = 28\text{ V}$ ,  $I_{DS} = 0.5\text{ A}$ ,  $P_{OUT} = 44\text{ dBm}$ , Efficiency = 40%

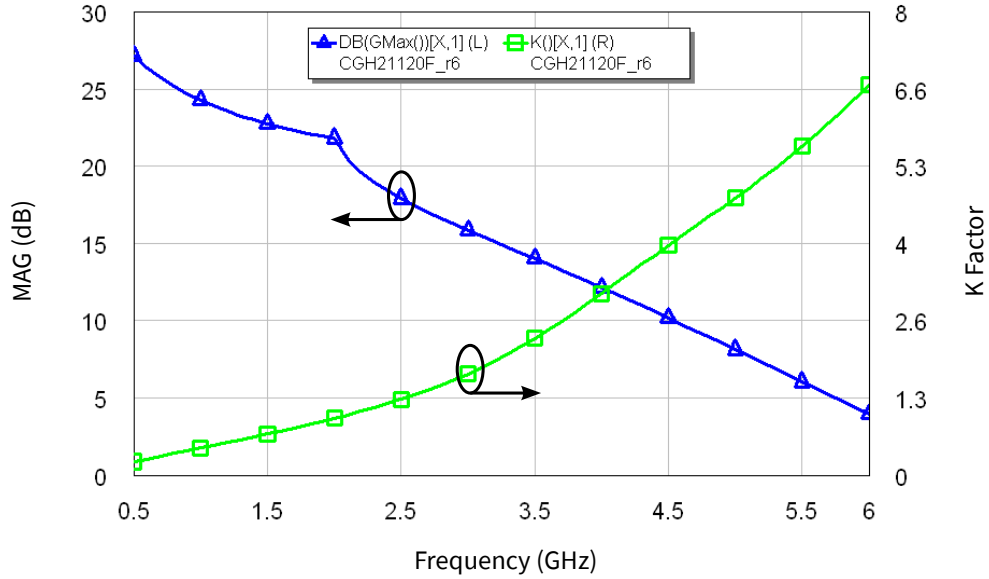

**Figure 7.** Simulated Maximum Available Gain and K Factor of the CGH21120F  
 $V_{DD} = 28\text{ V}$ ,  $I_{DQ} = 500\text{ mA}$

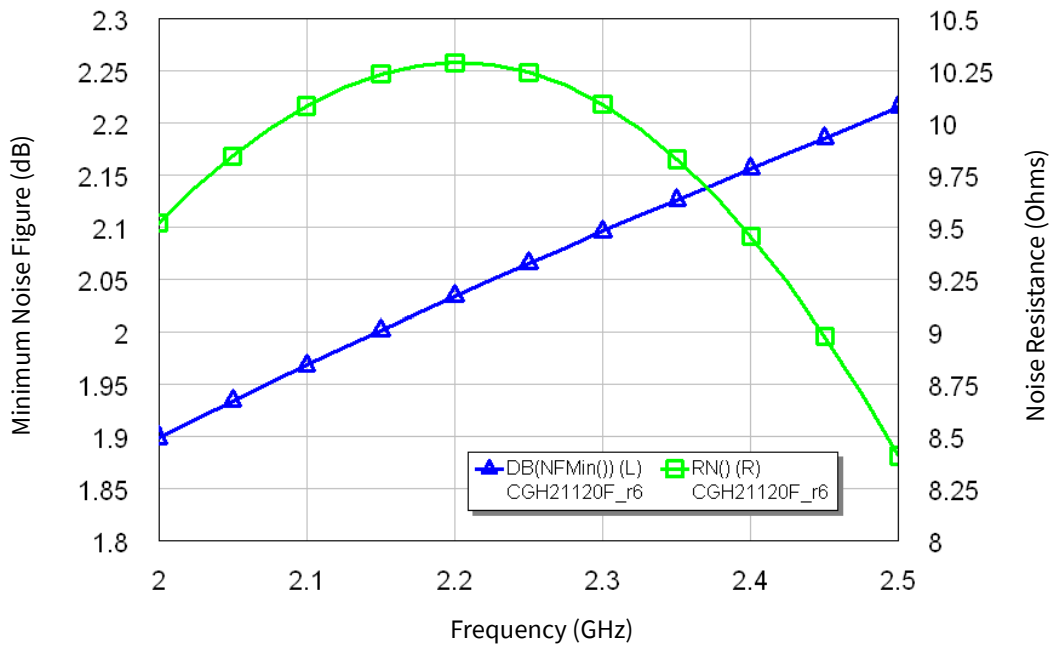
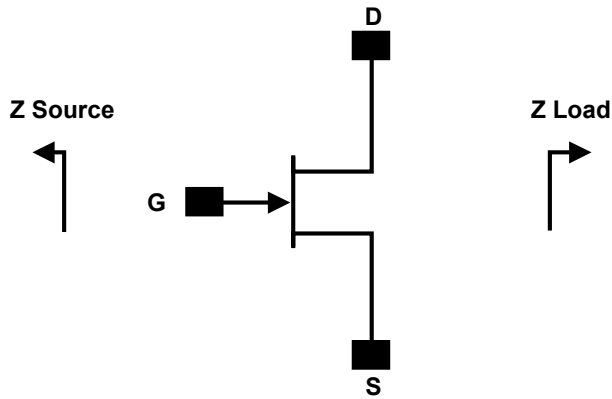

**Figure 8.** Simulated Minimum Noise Figure and Noise Resistance vs Frequency of the CGH21120F  
 $V_{DD} = 28\text{ V}$ ,  $I_{DQ} = 500\text{ mA}$

### Electrostatic Discharge (ESD) Classifications

Parameter	Symbol	Class	Test Methodology
Human Body Model	HBM	1A (> 250 V)	JEDEC JESD22 A114-D
Charge Device Model	CDM	II (200 < 500 V)	JEDEC JESD22 C101-C

### Source and Load Impedances



Frequency (MHz)	Z Source	Z Load
2000	18.17 - j15.4	3.43 - j0.24
2050	16.88 - j16.5	3.44 - j0.18
2100	15.31 - j17.44	3.43 - j0.15
2150	13.53 - j18.07	3.42 - j0.12
2200	11.63 - j18.35	3.37 - j0.10
2250	9.76 - j18.23	3.31 - j0.08
2300	8.00 - j17.78	3.22 - j0.06

Notes:

<sup>1</sup>  $V_{DD} = 28\text{ V}$ ,  $I_{DQ} = 0.5\text{ A}$  in the 440162 package

<sup>2</sup> Impedances are extracted from CGH21120F-AMP demonstration circuit and are not source and load pull data derived from transistor

### CGH21120F Power Dissipation De-rating Curve

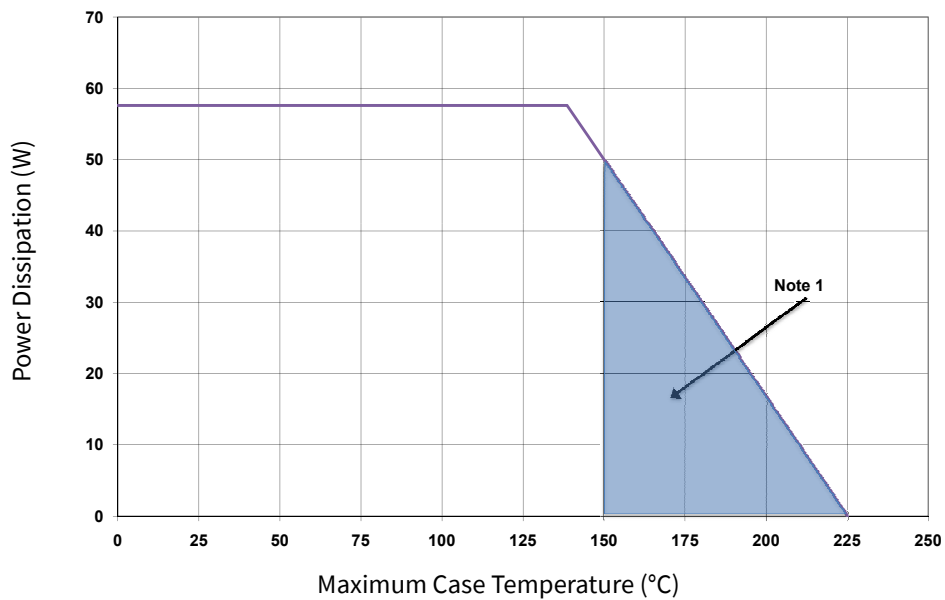

Note:

<sup>1</sup> Area exceeds Maximum Case Operating Temperature (See Page 2)



## CGH21120F-AMP Demonstration Amplifier Circuit Bill of Materials

Designator	Description	Qty
R1	RES, 1/16W, 0603, 1%, 10 OHMS	1
R2	RES, 1/16W, 0603, 1%, 5.1 OHMS	1
C1, C3, C8	CAP, 10pF, +/-5%, ATC600S	3
C2	CAP, 27pF, +/-5%, ATC600S	1
C5, C10	CAP, 470pF, +/-5%, 100V, 0603	2
C6, C11, C18	CAP, 33000pF, 0805, 100V, X7R	3
C7	CAP, 10μF, 16V, TANTALUM	1
C9	CAP, 82pF, +/-5%, ATC600S	1
C12	CAP 100μF, 160V, ELECTROLYTIC	1
C13	CAP, 24pF, +/-5%, ATC600F	1
C14	CAP 8.2pF, +/-0.25 ATC600S	1
C15, C19	CAP, 1.0μF, +/-10%, 1210, 100V, X7R	2
C20	CAP, 33μF, +/-20%, G CASE	1
J1, J2	CONN, N-Type, Female, 0.500 SMA Flange	2
J3	CONN, Header, RT> PLZ, 0.1 CEN, LK, 9 POS	1
—	PCB, RO4350, Er = 3.48, h = 20 mil	1
—	CGH21120F	1

## CGH21120F-AMP Demonstration Amplifier Circuit

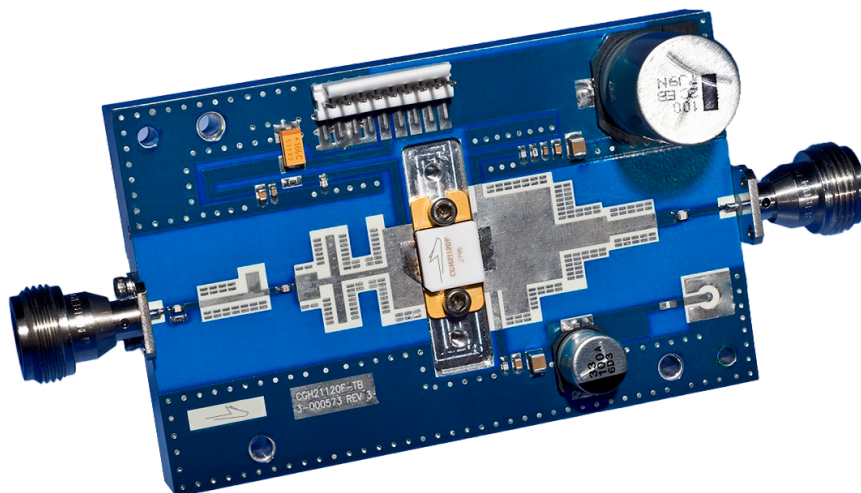





### CGH21120F-AMP Demonstration Amplifier Circuit Schematic

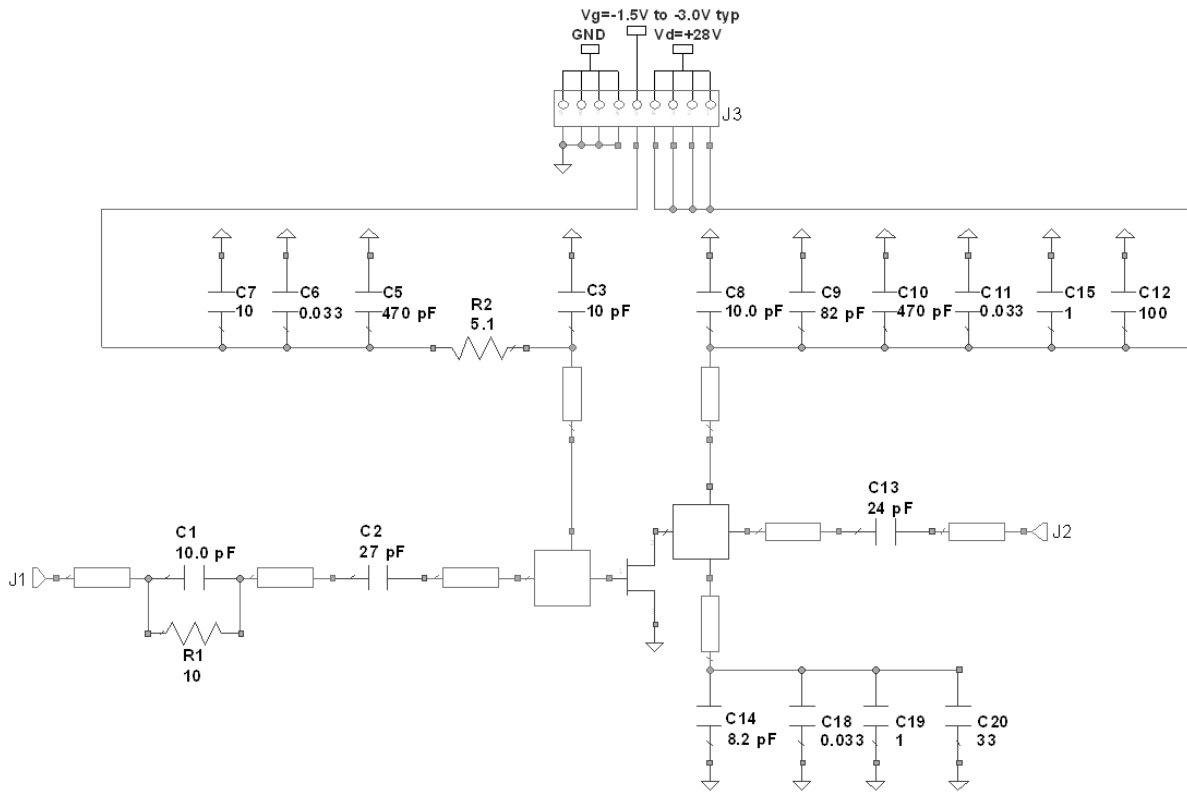

### CGH21120F-AMP Demonstration Amplifier Circuit Outline

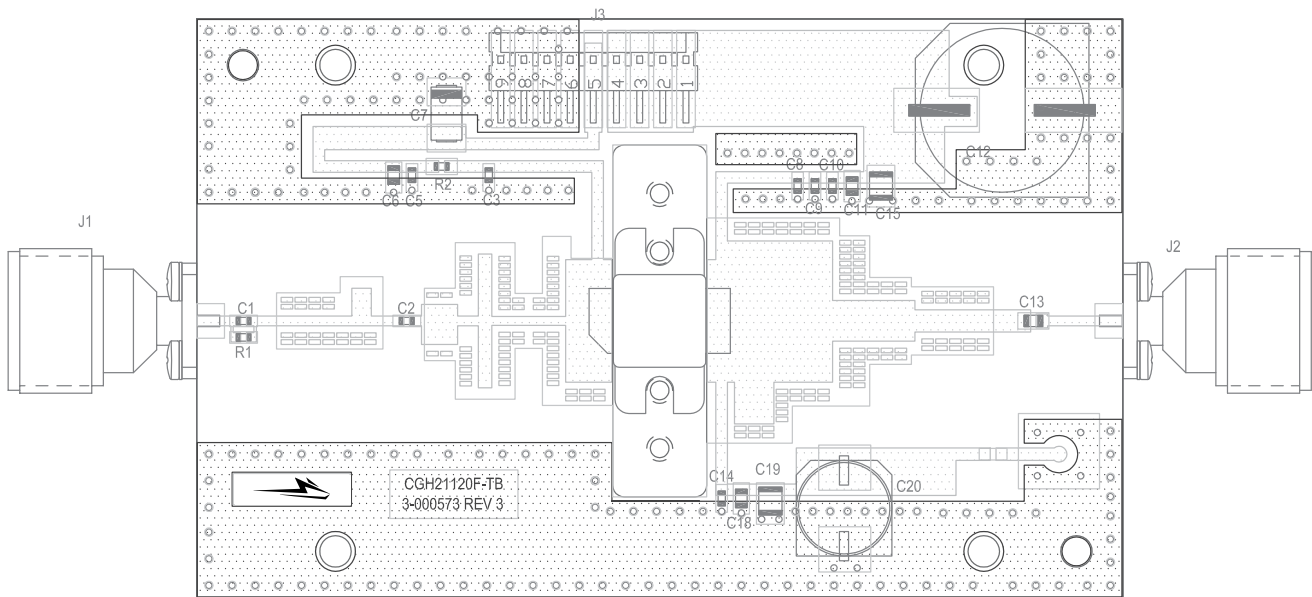



**Typical Package S-Parameters for CGH21120F**  
 (Small Signal,  $V_{DS} = 28\text{ V}$ ,  $I_{DQ} = 0.5\text{ A}$ , angle in degrees)

Frequency	Mag S11	Ang S11	Mag S21	Ang S21	Mag S12	Ang S12	Mag S22	Ang S22
500 MHz	0.961	179.86	3.67	68.26	0.007	-16.54	0.722	-173.72
600 MHz	0.960	178.22	3.09	63.27	0.007	-20.46	0.732	-173.18
700 MHz	0.959	176.75	2.69	58.41	0.007	-24.23	0.744	-172.73
800 MHz	0.957	175.36	2.40	53.65	0.007	-27.89	0.755	-172.37
900 MHz	0.955	173.99	2.19	48.94	0.007	-31.47	0.768	-172.12
1.0 GHz	0.952	172.61	2.03	44.26	0.008	-35.01	0.780	-171.96
1.1 GHz	0.949	171.20	1.91	39.56	0.008	-38.53	0.792	-171.88
1.2 GHz	0.944	169.72	1.82	34.81	0.008	-42.08	0.805	-171.88
1.3 GHz	0.938	168.15	1.77	29.95	0.008	-45.70	0.817	-171.94
1.4 GHz	0.930	166.46	1.74	24.91	0.009	-49.47	0.829	-172.06
1.5 GHz	0.920	164.63	1.73	19.59	0.009	-53.47	0.842	-172.23
1.6 GHz	0.907	162.63	1.75	13.89	0.010	-57.82	0.854	-172.45
1.7 GHz	0.889	160.43	1.80	7.63	0.011	-62.66	0.868	-172.72
1.8 GHz	0.863	158.03	1.87	0.61	0.011	-68.22	0.882	-173.07
1.9 GHz	0.828	155.48	1.97	-7.46	0.013	-74.76	0.897	-173.54
2.0 GHz	0.780	153.01	2.10	-16.94	0.014	-82.64	0.914	-174.18
2.1 GHz	0.715	151.22	2.24	-28.22	0.015	-92.25	0.932	-175.11
2.2 GHz	0.637	151.48	2.36	-41.58	0.017	-103.85	0.948	-176.42
2.3 GHz	0.566	155.82	2.42	-56.84	0.017	-117.27	0.958	-178.09
2.4 GHz	0.541	164.16	2.38	-73.11	0.017	-131.60	0.958	-179.89
2.5 GHz	0.577	171.39	2.22	-88.96	0.017	-145.40	0.949	178.57
2.6 GHz	0.643	173.87	2.01	-103.24	0.015	-157.52	0.935	177.50
2.7 GHz	0.708	172.59	1.79	-115.54	0.014	-167.55	0.922	176.84
2.8 GHz	0.760	169.28	1.60	-126.07	0.013	-175.66	0.912	176.44
2.9 GHz	0.796	164.87	1.44	-135.23	0.012	177.73	0.905	176.14
3.0 GHz	0.821	159.63	1.32	-143.50	0.011	172.16	0.900	175.88
3.2 GHz	0.843	146.16	1.17	-158.98	0.010	162.55	0.894	175.28
3.4 GHz	0.835	125.42	1.13	-175.91	0.010	152.13	0.891	174.54
3.6 GHz	0.799	88.32	1.17	161.01	0.011	136.18	0.888	173.59
3.8 GHz	0.786	21.79	1.15	126.34	0.011	109.17	0.886	172.34
4.0 GHz	0.879	-50.56	0.84	87.99	0.008	78.81	0.879	170.82
4.2 GHz	0.951	-93.77	0.52	61.47	0.006	60.37	0.869	169.25
4.4 GHz	0.979	-116.72	0.33	44.97	0.004	51.78	0.856	167.49
4.6 GHz	0.990	-130.14	0.22	33.45	0.003	47.74	0.840	165.43
4.8 GHz	0.994	-138.83	0.16	24.22	0.002	45.41	0.819	162.96
5.0 GHz	0.997	-144.91	0.12	15.93	0.002	43.34	0.789	159.95
5.2 GHz	0.998	-149.42	0.10	7.73	0.002	40.67	0.746	156.25
5.4 GHz	0.998	-152.92	0.08	-1.09	0.002	36.72	0.683	151.66
5.6 GHz	0.999	-155.72	0.07	-11.28	0.002	30.81	0.589	146.08
5.8 GHz	0.999	-158.03	0.06	-23.63	0.002	22.20	0.449	140.15
6.0 GHz	0.999	-159.97	0.05	-38.80	0.002	10.30	0.254	139.99

To download the s-parameters in s2p format, go to the [CGH21120F Product page](#) and click on the documentation tab.



**Product Dimensions CGH21120F (Package Type — 440162)**

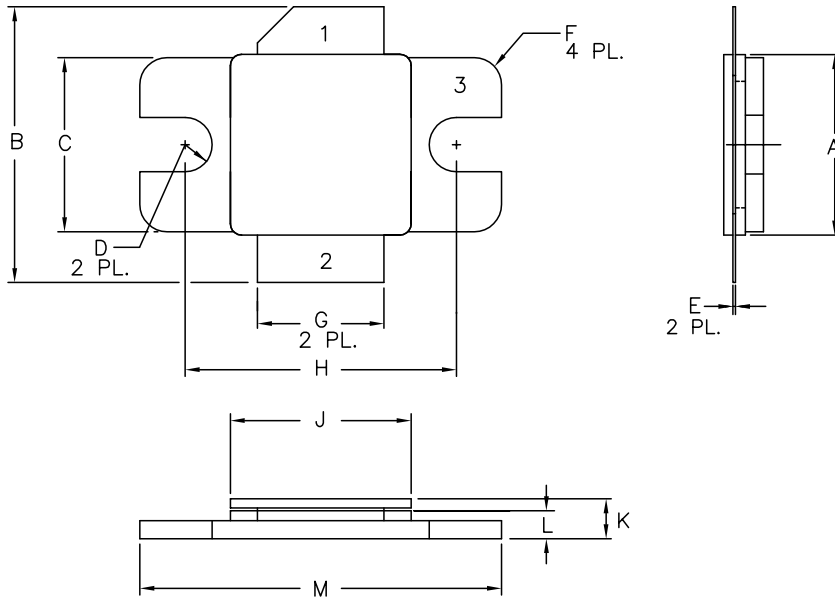

NOTES:

1. DIMENSIONING AND TOLERANCING PER ANSI Y14.5M, 1982.
2. CONTROLLING DIMENSION: INCH.
3. ADHESIVE FROM LID MAY EXTEND A MAXIMUM OF 0.020" BEYOND EDGE OF LID.
4. LID MAY BE MISALIGNED TO THE BODY OF THE PACKAGE BY A MAXIMUM OF 0.008" IN ANY DIRECTION.

DIM	INCHES		MILLIMETERS	
	MIN	MAX	MIN	MAX
A	.395	.405	10.03	10.29
B	.580	.620	14.73	15.75
C	.380	.390	9.65	9.91
D	.055	.065	1.40	1.65
E	.004	.006	0.10	0.15
F	.055	.065	1.40	1.65
G	.275	.285	6.99	7.24
H	.595	.605	15.11	15.37
J	.395	.405	10.03	10.29
K	.129	.149	3.28	3.78
L	.053	.067	1.35	1.70
M	.795	.805	20.19	20.45

- PIN 1. GATE  
 PIN 2. DRAIN  
 PIN 3. SOURCE



## Part Number System

### CGH21120F

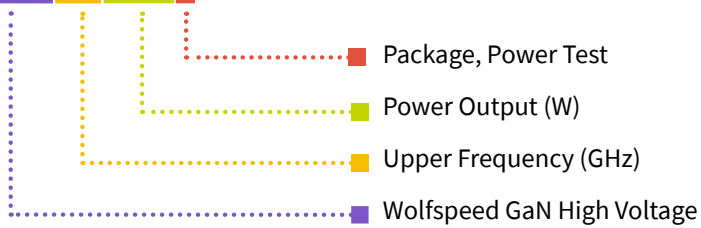

**Table 1.**

Parameter	Value	Units
Upper Frequency <sup>1</sup>	2.3	GHz
Power Output	120	W
Package	Flanged	—

Note:

<sup>1</sup> Alpha characters used in frequency code indicate a value greater than 9.9 GHz. See Table 2 for value.

**Table 2.**

Character Code	Code Value
A	0
B	1
C	2
D	3
E	4
F	5
G	6
H	7
J	8
K	9
Examples:	1A = 10.0 GHz 2H = 27.0 GHz

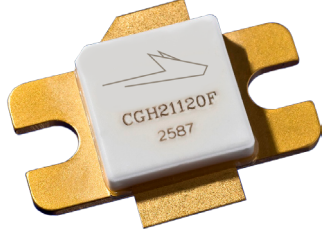
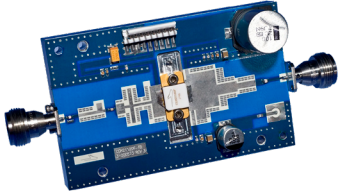

## Product Ordering Information

Order Number	Description	Unit of Measure	Image
CGH21120F	GaN HEMT	Each	
CGH21120F-AMP	Test board with GaN HEMT installed	Each	

**For more information, please contact:**

4600 Silicon Drive  
Durham, NC 27703 USA  
Tel: +1.919.313.5300  
[www.wolfspeed.com/RF](http://www.wolfspeed.com/RF)

Sales Contact  
[RFSales@wolfspeed.com](mailto:RFSales@wolfspeed.com)

RF Product Marketing Contact  
[RFMarketing@wolfspeed.com](mailto:RFMarketing@wolfspeed.com)

## Notes & Disclaimer

---

Specifications are subject to change without notice. “Typical” parameters are the average values expected by Wolfspeed in large quantities and are provided for information purposes only. Wolfspeed products are not warranted or authorized for use as critical components in medical, life-saving, or life-sustaining applications, or other applications where a failure would reasonably be expected to cause severe personal injury or death. No responsibility is assumed by Wolfspeed for any infringement of patents or other rights of third parties which may result from use of the information contained herein. No license is granted by implication or otherwise under any patent or patent rights of Wolfspeed.

© 2008-2022 Wolfspeed, Inc. All rights reserved. Wolfspeed® and the Wolfstreak logo are registered trademarks and the Wolfspeed logo is a trademark of Wolfspeed, Inc.  
PATENT: <https://www.wolfspeed.com/legal/patents>

*The information in this document is subject to change without notice.*