

SUMMARY

Wires

Low voltage 12



Image is for illustrative purpose only

Series	2P
Termination type	Female solder
IP rating	50
AWG wire size	30.00 - 22.00
Cable Ø	3.20 - 9.20 mm
Status	active
Matching parts	CAB.M12.GLA.C72GZ

Download

[Request a quote](#)

[Catalog](#)

TECHNICAL DETAILS

Mechanics

Shell Style/Model	CK*: Fixed receptacle with two nuts (back panel mounting)
Keying	3 keys (alpha=0, gamma=60; Plug: male contacts; Receptacle: female contacts)
Housing Material	PSU (Polysulfone), gray
Weight	5.66 g

Performance

Configuration	2P.M12 : 12 Low V.
Insulator	L: PEEK for solder contacts
Rated Current	7 Amps

Specifications

Contact Type: Solder
Contact Dia.: 0.7 mm (0.027in)
Bucket Dia.: 0.8 mm (0.031in)
Test voltage (kV rms) Contact-contact: 1.25
Air clearance min.: 0.85 mm
Creepage distance min.: 0.85 mm

Others

LEMO products and services are provided "as is". LEMO makes no warranties or representations with regard to LEMO product & services or use of them, express, implied or statutory, including for accuracy, completeness, or security. The user is fully responsible for his products and applications using LEMO components.

Endurance (Shell): >1000 mating cycles
 F ret (min): 150 N
 F ret (max): 250 N
 Steam sterilization: 20 times

DRAWINGS

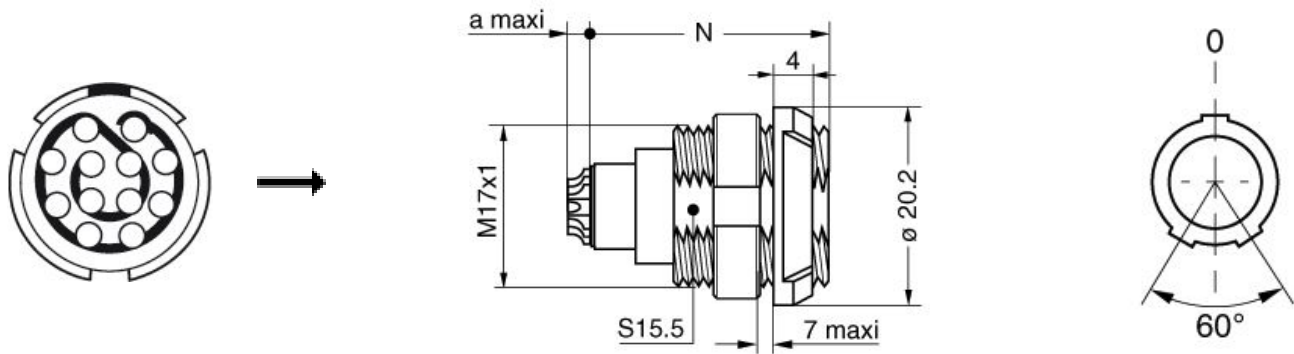

Dimensions

	A	N	a
mm.	20.2	23.8	3.4-4.9
in.	0,80	0,94	0,13







RECOMMENDED BY LEMO

Tools

Cables

CMN.12.T22.070QGZE	TPR (medical)	Grey	
CMN.12.T28.054PGZE		Grey	
CMN.12.T28.054PNZE			
112240	PTFE	White	

LEMO products and services are provided "as is". LEMO makes no warranties or representations with regard to LEMO product & services or use of them, express, implied or statutory, including for accuracy, completeness, or security. The user is fully responsible for his products and applications using LEMO components.

112260	PTFE	White	
112280	PVC	Black	
12050	PVC	Black	
124080	PVC	Grey	
124084	PVC	Black	
212220	PVC	Black	
212240	PVC	Black	
212250	PVC	Grey	
212260	PVC	Black	

LEMO products and services are provided "as is". LEMO makes no warranties or representations with regard to LEMO product & services or use of them, express, implied or statutory, including for accuracy, completeness, or security. The user is fully responsible for his products and applications using LEMO components.