

INTERVOX Speakers from International ©

215 McCormick Drive, Bohemia, NY 11716 (631)952-9595 Fax: (631) 952-9597 e-mail: oemsales@icc107.com

Code No. G50

1.	MODEL:	SR80X14VNS
2	Dimension & Weight	Outer Diameter 20X35 mm
		Baffle Opening 19X34 mm
		Height Refer to drawing Weight 4.2 Grams
3	Magnet	Materials Rare Earth Size ϕ 9.5 × 1.5 mm
4.	Nominal Impedance	8 $\Omega \pm 15\%$, At 1500 Hz.
5.	Power Rating	Normal 1.0 Watts Maximum 2.0 Watts Sine Wave.
		Normal Watts Maximum Watts Square Wave.
6.	Resonant Frequency	560 $\pm 20\%$ Hz.
7.	Output Sound Pressure Level (S.P.L.)	82 ± 3 db/ 1.0 Watt • 0.5 Meter
		Average at 800, 1000, 1200, 1500 Hz.
8.	Frequency Range	350 ~ 4000 Hz. Average SPL – 10 db.
9.	Distortion	5 % Maximum At 1000 Hz. 1.0 W.
10	Abnormal Sound test	Must be Normal Tested By 2.83 Volts. Sine Wave.
11	Load Test	White Noise 2.83 Volts. (RMS.) 96 Hours.
12	Polarity	Diaphragm shall move Forward while Apply a Positive DC Signal to the "+" or "Marked" Terminal.
Above Measuring condition under temperature: 15~35°C R.H. 25 ~75%. According to standard GB/T9396-1996		
Mechanical and vibration test		
13	High Temperature	+ 85 ± 2 °C Humidity Random for 96 Hours. (GB2423.2-81)
14	Low Temperature	- 40 ± 2 °C Humidity Random for 96 Hours. (GB2423.1-81)
15	Humidity	+ 40 ± 2 °C Relative Humidity (RH) 90 ~ 95 % 48 Hours.
16	Vibration	Frequency 30 ± 15 Hz, Amplitude 1.5 mm for 3 Hours. (GB11606.8-89)
17	Drop test	75 CM free falling on Concrete floor, 10 times. (GB2423. 8-81)
After test leave speakers at room temperature for 1 hour, SPL shall not deviate by ± 3 db from pre-test		
18	Temperature Cycle test	- 40 ~ + 85 °C 4 Cycles Temperature tests. (GB5170.18-87)
After test leave speakers at room temperature for 1 hour, SPL shall not deviate by ± 3 db from pre-test Measurement, and meet above spec. item 6. 7. 8. 9. 10.		
Please refer to next pages for more detailed testing method.		

Test method and User precaution.

1. Characteristics measured according to standard GB/T 9396-1996
 - 1.1 Except other specified, measuring are under Temperature 15~35°C R.H. 25 ~75%
 - 1.2 Judgement condition Temperature 20 ±2 R.H. 63~67%
 - 1.3 Product shelf life is valid for 12 months only.
2. Output Sound Pressure Level (S.P.L.) and distortion testing setup

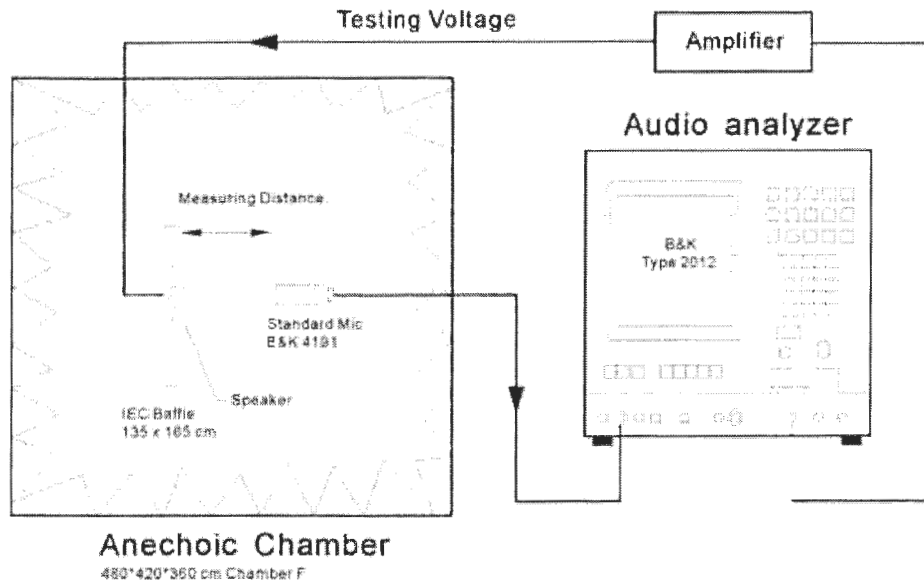

3. Environment & Mechanical test:

3.1. High Temperature: GB2423.2-81

After exposure the speaker in the + 85 ± 2 °C chamber for 96 hours, then leave the speaker at room temperature for 1 hour, the SPL should not deviate by ± 3 db, and resonant frequency should not deviate by ± 50 Hz, compare with pre-test measurement.

3.2. Low Temperature: GB2423.1-81

After exposure the speaker in the -40 ± 2 °C chamber for 96 hours, then leave the speaker at room temperature for 1 hour, the SPL should not deviate by ± 3 db, and resonant frequency should not deviate by ± 50 Hz, compare with pre-test measurement.

Temperature cycle: GB5170.18-87

After exposure the speaker in the chamber, temperature cycle setting as below shows, SPL should not deviate by ± 3 db, and resonant frequency should not deviate by ± 80 Hz, compare with pre-test measurement.

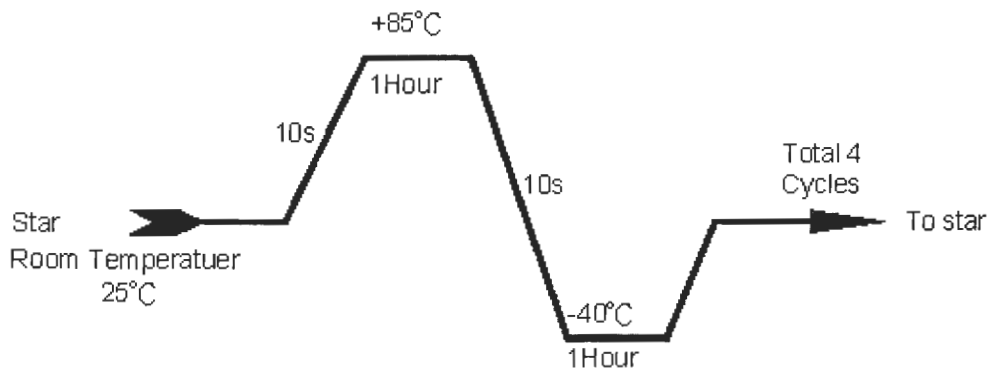

3.4. Humidity: GB5170.18-87

After exposure the speaker in the $+ 40 \pm 2$ °C, relative humidity 90% ~ 95% chamber for 48 hours, then leave the speaker at room temperature for 6 hours, the SPL should not deviate by ± 3 db, and resonant frequency should not deviate by ± 50 Hz, compare with pre-test measurement.

3.5. Vibration: GB11606.8-89

Frequency 30 ± 15 Hz, Amplitude 1.5 mm for 3 Hours. After test, SPL shall not deviate by ± 3 db from pre-test measurement.

3.6. Load test: GB/T 9396-1996

Speaker should not fail after apply 20 ~ 20K Hz white noise rated power input (RMS), 96 hours. After test, SPL shall not deviate by ± 3 db from pre-test measurement.

3.7. Drop test: GB2423. 8-81

75 cm free falling on concrete floor, 10 times. After test, SPL shall not deviate by ± 3 db from pre-test measurement.

4. Mounting precaution

In order to keep speaker work normally, there shall leave enough free space for diaphragm moving, minimum distance required is marked in speaker mechanical drawing.

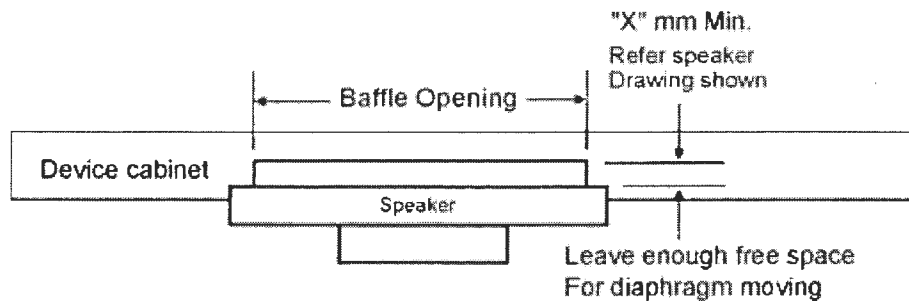

5. Measuring & standard referenced

Abstract from GB/T 9396-1996 and IEC 268-5:1989 methods of measurement for main characteristics of loud speakers

5.1. Rated sine voltage.

It is stipulated by manufacturer, sine signal voltage that make speaker work continuously in rated frequency range, but the speaker wouldn't be damaged heartily or mechanically. The persist time of the voltage is 1 hour.

5.2. The rated sine power.

The rated sine power is corresponding with the rated sine voltage, its definition is U_s^2/R , U_s indicates the maximum sin voltage, R indicates the rated impedance.

5.3. The rated noise power.

The rated noise power is corresponding with the rated noise voltage, its definition is U_n^2/R , U_n indicates the rated noise voltage, R indicates the rated impedance.

INTERVOX Speakers from International ©

SR80X14VNS VOL:2.83V(1W) DIS:0.5M

Magn dB re 20.0 uPa.

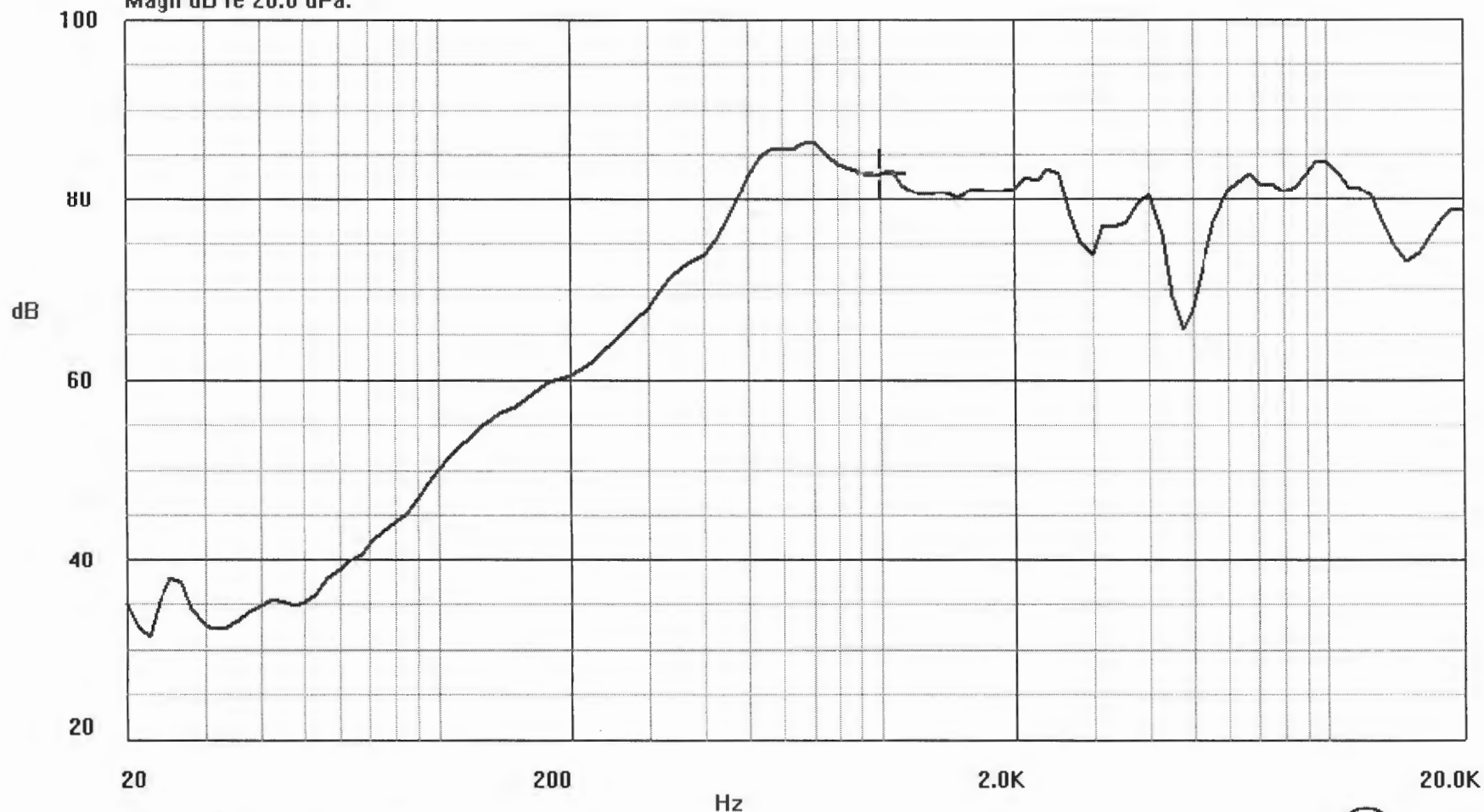

Current Curve: 0 X: 1000 Hz Y: 82.90 dB

Time[Y/M/D H:M:S]: 2005/12/ 8 7:17:22



MOUNTING NOTICE

AT LEAST
0.8mm
FOR
DIAPHRAM
MOVING

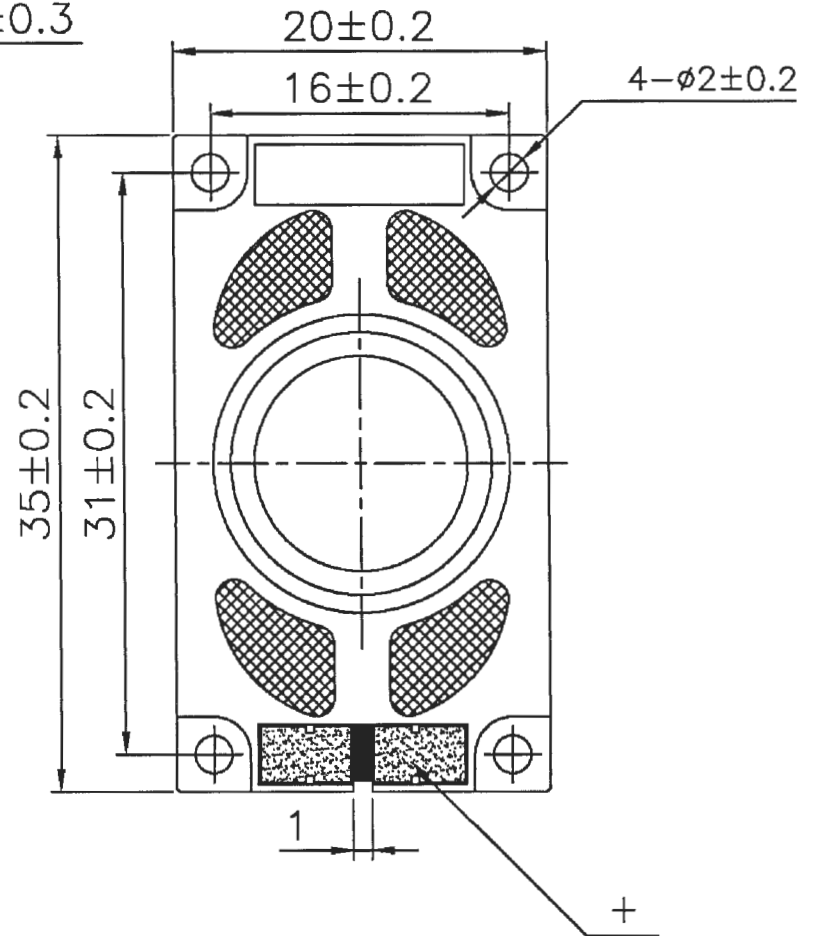
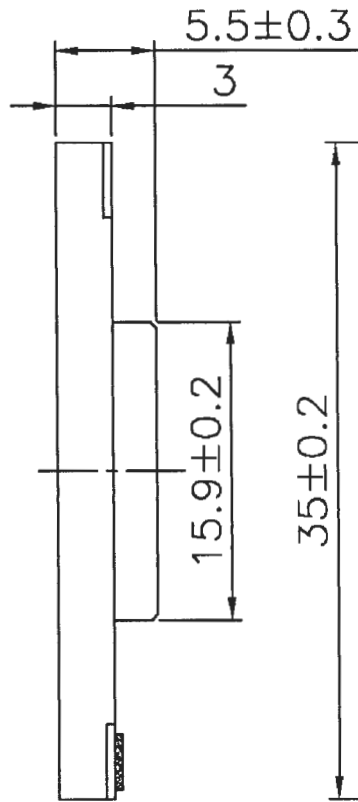
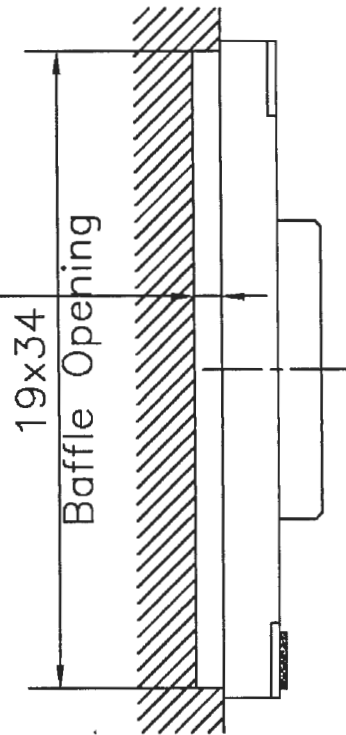

V1.0		06.08.24		DESCRIPTION	
VERSION	DATE				
Unit: mm	Scale:	Appr.:			
Tol.: 其餘±1/2IT13		CHK.:	Dwg.:		

INTERNATIONAL COMPONENTS CORPORATION
215 McCormick Drive, Bohemia, NY 11716
Tel: (631) 952-9595 Fax: (631) 952-9597

Title: **SR80X14VNS**