

2 CKT SMT HEADER
POLARIZATION OPTION A
TIN P/N: 34912-8020
GOLD P/N: 34912-6020

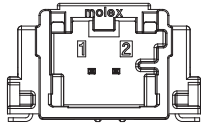

2 CKT SMT HEADER
POLARIZATION OPTION B
TIN P/N: 34912-8021
GOLD P/N: 34912-6021

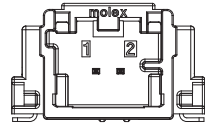

2 CKT SMT HEADER
POLARIZATION OPTION C
TIN P/N: 34912-8022
GOLD P/N: 34912-6022

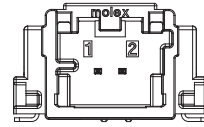

2 CKT SMT HEADER
POLARIZATION OPTION D
TIN P/N: 34912-8023
GOLD P/N: 34912-6023

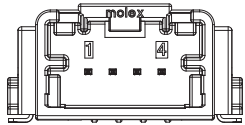

4 CKT SMT HEADER
POLARIZATION OPTION A
TIN P/N: 34912-8040
GOLD P/N: 34912-6040

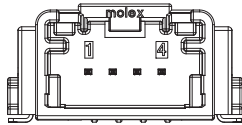

4 CKT SMT HEADER
POLARIZATION OPTION B
TIN P/N: 34912-8041
GOLD P/N: 34912-6041

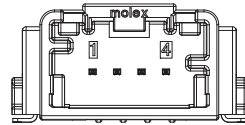

4 CKT SMT HEADER
POLARIZATION OPTION C
TIN P/N: 34912-8042
GOLD P/N: 34912-6042

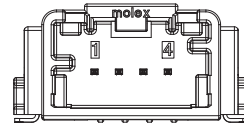

4 CKT SMT HEADER
POLARIZATION OPTION D
TIN P/N: 34912-8043
GOLD P/N: 34912-6043

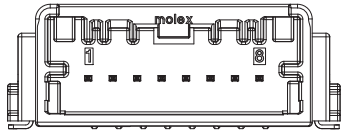

8 CKT SMT HEADER
POLARIZATION OPTION A
TIN P/N: 34912-8080
GOLD P/N: 34912-6080

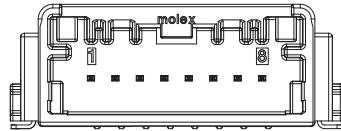

8 CKT SMT HEADER
POLARIZATION OPTION B
TIN P/N: 34912-8081
GOLD P/N: 34912-6081

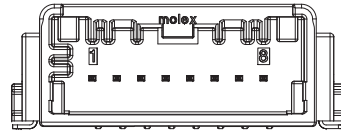

8 CKT SMT HEADER
POLARIZATION OPTION C
TIN P/N: 34912-8082
GOLD P/N: 34912-6082

NOTES: VALID UNLESS OTHERWISE SPECIFIED

1. GENERAL:
 - a. APPLICATION SPECIFICATION SEE: AS-34791-020
 - b. PRODUCT SPECIFICATION SEE: PS-34791-020
 - c. PACKAGING SPECIFICATION PER MOLEX DRAWING: SEE CHART
 - d. SOLDERABILITY PER SMES-152
 - e. PARTS MUST BE IN COMPLIANCE TO MOLEX CHEMICAL SUBSTANCES FOR PRODUCTS AND PACKAGING SPECIFICATION: QEHS-699000-300
 - f. DATA MUST BE SUBMITTED UNDER THE MOLEX PART NUMBER TO IMDS (COMPANY ID# 13255)
 - g. FLAMMABILITY REQUIREMENT: PER ISO3795 OR GM3191
 - h. VISUAL DEFECTS SHALL MEET COSMETIC STANDARD PS-45499-002 (Class B)
 2. DESIGN - MATERIALS:
 - a. SHROUD (PLASTIC HOUSING): SPS 30% GF, 20% REGRIND MAX BY WEIGHT
 - b. BLADES:
 - BASE METAL: C260 BRASS
 - PLATING REQUIREMENTS:
 - TIN OVER NICKEL:
 - UNDERPLATING: OVERALL NICKEL
 - OVERPLATING: OVERALL TIN
 - GOLD:
 - UNDERPLATING: OVERALL NICKEL
 - OVERPLATING: CONTACT AREA: GOLD
 - GRIP AREA: TIN
3. DESIGN - GEOMETRY:
 - a. THIS IS A 100% CAD GENERATED PART. THE CAD MATHEMATICAL DATA IS THE MASTER FOR THIS PART. FOR DIMENSIONAL OR ANY INFORMATION NOT SHOWN ON THIS DRAWING, ANALYZE THE CAD MODEL.
 - b. GEOMETRIC DIMENSIONS AND TOLERANCES PER ASME Y14.5M - 2009
 - c. GENERAL TOLERANCES: SEE TITLE BLOCK
 - d. EDGES AND UNDIMENSIONED DETAILS PER ISO13715
 - e. CORNERS SHOWN AS SHARP TO BE R 0.1 MAX
 - f. LETTERING SHALL BE BELOW SURROUNDING SURFACE OF PART. THIS INCLUDES RECYCLING CODE, PLANT AND CAVITY ID, VENDOR ID, AND CIRCUIT ID.
 - g. TRACEABILITY TO BE MARKED IN AREA SHOWN. MARK IS CODED AS FOLLOWS:
 - ROW 1 (XXXXX): MOLEX SINGLE ROW SMT HEADER SERIES NUMBER (34912)
 - ROW 2 (HHDDYY):
 - 1ST & 2ND DIGITS: HOUR OF ASSEMBLY (24 HOUR CLOCK)
 - (EXAMPLE: 15:00 -> '15; 7:00 -> '07)
 - 3RD THRU 5TH DIGITS: JULIAN DATE (EXAMPLE: FEBRUARY 3RD -> '034')
 - 6TH & 7TH DIGITS: LAST 2 DIGITS OF CALENDAR YEAR (EXAMPLE: 2013 -> '13)

INSPECTION BALLOON NUMBER LOG	
PER DRAWING REVISION: M1	
LAST BALLOON USED: 16	
ADDED BALLOON NUMBERS:	
M2	NX REMASTERING
REV	DESCRIPTION
REMOVED BALLOON NUMBERS:	

QUALITY SYMBOLS	THIS DRAWING CONTAINS INFORMATION THAT IS PROPRIETARY TO MOLEX ELECTRONIC TECHNOLOGIES, LLC AND SHOULD NOT BE USED WITHOUT WRITTEN PERMISSION		DIMENSION UNITS		SCALE	molex
	GENERAL TOLERANCES (UNLESS SPECIFIED)	MM ONLY	DATE	5:1		
▽ = 0	2017/07/24	2017/07/27	DRWN BY	DATE	MYOUNG01	2012/05/23
▽ = 0	ANGULAR TOL ± 1.0 °		CHK'D BY	DATE		
▽ = 0	4 PLACES ±		APPR BY	DATE	SMARCEAU	2012/06/01
▽ = 0	3 PLACES ±		DRAWING SIZE	THIRD ANGLE PROJECTION	D	
▽ = 0	2 PLACES ± 0.1		SERIES	MATERIAL NUMBER	CUSTOMER	
▽ = 0	1 PLACE ± 0.2		34912	SEE TABLE	GENERAL MARKET	
▽ = 0	0 PLACES ±		DOCUMENT NUMBER	DOC TYPE	DOC PART	SHEET NUMBER
□ = 0	DRAFT WHERE APPLICABLE MUST REMAIN WITHIN DIMENSIONS		SD-34912-001	PSD	000	1 OF 5
■ = 0						
▽ = 0						

RELEASE STATUS	RELEASE DATE

2 CKT SMT HEADER

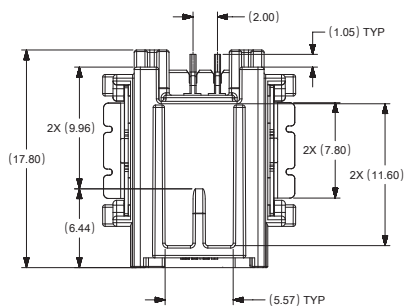

4 CKT SMT HEADER

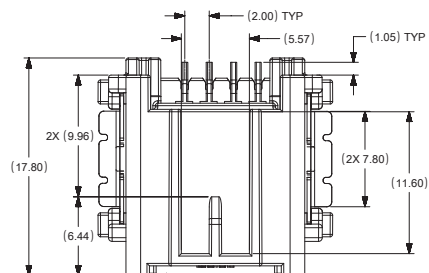

8 CKT SMT HEADER

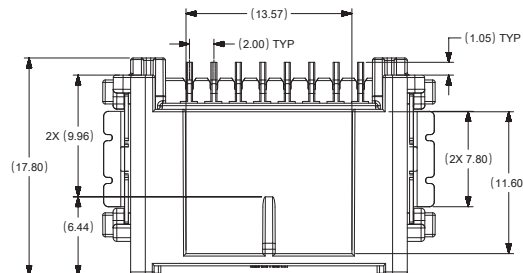

HEADER TO PCB FLUSH MOUNT

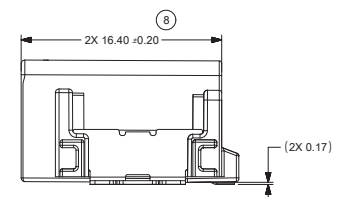
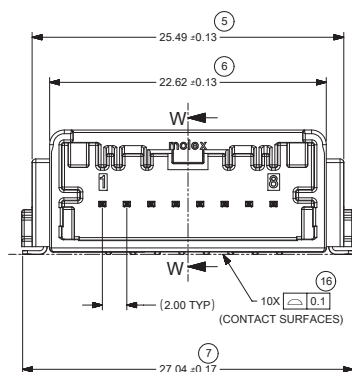
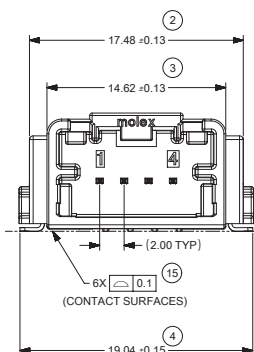
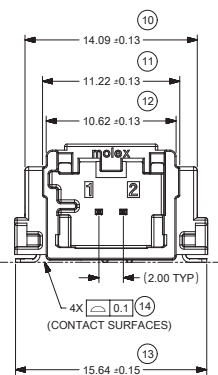
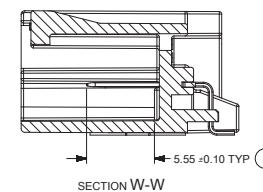

QUALITY SYMBOLS □ = 0 ▽ = 0 ▽ = 0 ▽ = 0 ▽ = 0 ▽ = 0 □ = 0 ■ = 0 ▽ = 0	THIS DRAWING CONTAINS INFORMATION THAT IS PROPRIETARY TO MOLEX ELECTRONIC TECHNOLOGIES, LLC AND SHOULD NOT BE USED WITHOUT WRITTEN PERMISSION	EC NO: 119768 DRWN: SMARCEAU DATE: 2012/05/23	GENERAL TOLERANCES (UNLESS SPECIFIED) MM ONLY SCALE: 5:1	
		DRWN BY: MYOUNG01 DATE: 2012/05/23	SERIES: 34912 MATERIAL NUMBER: SEE TABLE CUSTOMER: GENERAL MARKET	
ANGULAR TOL ± 1.0 ° 4 PLACES ± 3 PLACES ± 2 PLACES ± 0.1 1 PLACE ± 0.2 0 PLACES ±	APPR BY: SMARCEAU DATE: 2012/06/01	PRODUCT CUSTOMER DRAWING	DOCUMENT NUMBER: SD-34912-001 DOC TYPE: PSD DOC PART: 000 SHEET NUMBER: 2 OF 5	2, 4, 8 CKT MINI 50 SMT ASSEMBLY SALES DRAWING
DRAFT WHERE APPLICABLE MUST REMAIN WITHIN DIMENSIONS	DRAWING SIZE: D THIRD ANGLE PROJECTION	RELEASE STATUS: [] RELEASE DATE: []		

RELEASE STATUS	RELEASE DATE

MINI 50 SMT SINGLE ROW ASSEMBLIES

GOLD:

MATERIAL NUMBER TUBE PACKAGING PK-31301-688	MATERIAL NUMBER TAPE AND REEL PACKAGING PK-31301-786	TOOLED	CONFIGURATION	CIRCUIT	POL	COLOR	BLADE PLATING	MATING COMPONENT	
								UN-BRIDGED	BRIDGED
N/A	34912-6020	NO	MOLEX	2	A	BLACK	GOLD		34791-0020
N/A	34912-6021	NO	MOLEX	2	B	GREY	GOLD		34791-0021
N/A	34912-6022	NO	MOLEX	2	C	DARK GRAY	GOLD		34791-0022
N/A	34912-6023	NO	MOLEX	2	D	GREEN	GOLD		34791-0023
34912-7040	34912-6040	NO	USCAR	4	A	BLACK	GOLD	34791-0040	34791-0140
34912-7041	34912-6041	NO	USCAR	4	B	GREY	GOLD	34791-0041	34791-0141
34912-7042	34912-6042	NO	USCAR	4	C	DARK GRAY	GOLD	34791-0042	34791-0142
34912-7043	34912-6043	NO	USCAR	4	D	GREEN	GOLD	34791-0043	34791-0143
34912-7080	34912-6080	NO	USCAR	8	A	BLACK	GOLD	34791-0080	34791-0180
34912-7081	34912-6081	NO	USCAR	8	B	GREY	GOLD	34791-0081	34791-0181
34912-7082	34912-6082	NO	USCAR	8	C	DARK GRAY	GOLD	34791-0082	34791-0182

TIN:

MATERIAL NUMBER TUBE PACKAGING PK-31301-688	MATERIAL NUMBER TAPE AND REEL PACKAGING PK-31301-786	CONFIGURATION	CIRCUIT	POL	COLOR	BLADE PLATING	MATING COMPONENT	
							UN-BRIDGED	BRIDGED
N/A	34912-8020	MOLEX	2	A	BLACK	TIN OVER NICKEL		34791-0020
N/A	34912-8021	MOLEX	2	B	GREY	TIN OVER NICKEL		34791-0021
N/A	34912-8022	MOLEX	2	C	DARK GRAY	TIN OVER NICKEL		34791-0022
N/A	34912-8023	MOLEX	2	D	GREEN	TIN OVER NICKEL		34791-0023
34912-9040	34912-8040	USCAR	4	A	BLACK	TIN OVER NICKEL	34791-0040	34791-0140
34912-9041	34912-8041	USCAR	4	B	GREY	TIN OVER NICKEL	34791-0041	34791-0141
34912-9042	34912-8042	USCAR	4	C	DARK GRAY	TIN OVER NICKEL	34791-0042	34791-0142
34912-9043	34912-8043	USCAR	4	D	GREEN	TIN OVER NICKEL	34791-0043	34791-0143
34912-9080	34912-8080	USCAR	8	A	BLACK	TIN OVER NICKEL	34791-0080	34791-0180
34912-9081	34912-8081	USCAR	8	B	GREY	TIN OVER NICKEL	34791-0081	34791-0181
34912-9082	34912-8082	USCAR	8	C	DARK GRAY	TIN OVER NICKEL	34791-0082	34791-0182

QUALITY SYMBOLS 	THIS DRAWING CONTAINS INFORMATION THAT IS PROPRIETARY TO MOLEX ELECTRONIC TECHNOLOGIES, LLC AND SHOULD NOT BE USED WITHOUT WRITTEN PERMISSION		DIMENSION UNITS MM ONLY	SCALE 10:1		
	GENERAL TOLERANCES (UNLESS SPECIFIED)	DRAWN BY MYOUNG01	DATE 2012/05/23	2, 4, 8 CKT MINI 50 SMT ASSEMBLY SALES DRAWING		
	ANGULAR TOL ± 1.0 °	CHECK'D BY	DATE	PRODUCT CUSTOMER DRAWING		
	4 PLACES ± 3 PLACES ± 2 PLACES ± 0.1 1 PLACE ± 0.2 0 PLACES ±	APPR BY SMARCEAU	DATE 2012/06/01	SERIES 34912		MATERIAL NUMBER SEE TABLE
DRAFT WHERE APPLICABLE MUST REMAIN WITHIN DIMENSIONS	DRAWING SIZE D	THIRD ANGLE PROJECTION	DOCUMENT NUMBER SD-34912-001	DOC TYPE PSD	SHEET NUMBER 5 OF 5	

RELEASE STATUS	RELEASE DATE