



TAOGLAS®



Datasheet

Steedan

Part No:
MA351.A.BI.001

Description:

Steedan 2-in-1 Magnetic Mount Combination Antenna with
2*5G/4G MIMO

Features:

Low Profile Magnetic Mount Enclosure

2* 5G/4G MIMO 600-6000MHz

IP65 Rated, Ruggedized PC/ABS Enclosure

LTE: 3m TGC200 Cable and SMA(M)ST Connector

Dimensions: 250 x 144.3 x 52.8mm

RoHS & Reach Compliant

1. Introduction	3
2. Specifications	4
3. Antenna Characteristics	7
4. Radiation Patterns	12
5. Mechanical Drawing	33
6. Packaging	34
7. Application Note	35
<hr/>	
Changelog	44

Taoglas makes no warranties based on the accuracy or completeness of the contents of this document and reserves the right to make changes to specifications and product descriptions at any time without notice. Taoglas reserves all rights to this document and the information contained herein. Reproduction, use or disclosure to third parties without express permission is strictly prohibited.



1. Introduction



The Taoglas Steedan MA351 is a 2-in-1 next-generation low profile magnetic mount antenna for vehicle, outdoor building and heavy equipment roof applications. It has a fully IP65 rated waterproof robust ABS enclosure and base. This is an ideal external combination antenna solution that is used where drilling a hole through the roof of a vehicle or a metal panel is not feasible. It can be mounted on steel surfaces and its ultra-strong neodymium magnets. A soft foam cushion on the base protects the mounting surface during installation and removal. Only 52.8mm high it mounts discretely to the target application out of sight of most onlookers.

This outstanding antenna delivers powerful MIMO antenna technology 5G/4G. The 3 internal antennas have superior isolation. The 5G/4G antennas also include backward compatibility to work at most worldwide 3G and 2G bands.

Typical Applications:

- Next Generation OEM Automotive Connectivity
- Multimedia, Navigation and Telematics Systems
- V2V, V2X and Fleet Management Applications
- First Net Responder Routers

The MA351 is ideal for applications that require highly sophisticated antennas for real-time streaming applications that demand high-speed video uplink and downlink into the cabin of the vehicle. These challenges are resolved by the highly efficient, high gain MIMO antennas, with high isolation, all of which is necessary to achieve the required signal to noise ratio and throughput.

The MA351 can also be customized for your particular wireless application and frequency band, subject to NRE and MOQ. There are 2x 3000mm low loss TGC-200 cables, terminating in SMA(M) connectors for 5G/4G MIMO. There is a 3000mm RG-174 cable for GNSS terminating in an SMA(M) connector. All cable lengths and connector types are customizable, for further information contact your regional Taoglas customer support team.

2. Specifications

5G/4G MIMO Free Space Electrical

Band	Frequency (MHz)		Efficiency (%)	Average Gain (dB)	Peak Gain (dBi)	Impedance	Max Input Power	Polarization	Radiation Pattern
5G NR/4G Band 71	617~698	MIMO 1	34.1	-4.7	1.1	50 Ω	10W	Linear	Omni-Directional
		MIMO 2	21.6	-6.7	0.1				
4G/3G Band 12,13,14,17,28,29	698~824	MIMO 1	32.8	-4.8	3				
		MIMO 2	47.1	-3.3	3.5				
4G/3G/NB-IoT/Cat M Band 5,8,18,19,20,26,27	824~960	MIMO 1	39.7	-4	4.2				
		MIMO 2	53.2	-2.7	4				
5G NR/4G Band 21,32,74,75,76	1427~1518	MIMO 1	43.2	-3.7	3.1				
		MIMO 2	54.1	-2.7	3.6				
4G/3G Band 1,2,3,4,9,23,25,35,39,66	1710~2200	MIMO 1	46.8	-3.3	5.5				
		MIMO 2	38.5	-4.1	5				
4G/3G Band 7,38,40,41	2300~2690	MIMO 1	41.7	-3.8	4.9				
		MIMO 2	39.5	-4	5.7				
5G NR Band 22,42,48,77,78,79	3300~5000	MIMO 1	46	-3.4	3.9				
		MIMO 2	46.4	-3.3	4.8				
LTE5200/ Wi-Fi 5800	5150~5925	MIMO 1	23.9	-6.2	1.6				
		MIMO 2	26	-5.8	1.7				

5G/4G MIMO 30*30cm Ground Plane Electrical

Band	Frequency (MHz)		Efficiency (%)	Average Gain (dB)	Peak Gain (dBi)	Impedance	Max Input Power	Polarization	Radiation Pattern
5G NR/4G Band 71	617~698	MIMO 1	33.6	-4.7	1.6	50 Ω	10W	Linear	Omni-Directional
		MIMO 2	22.3	-6.5	-1.6				
4G/3G Band 12,13,14,17,28,29	698~824	MIMO 1	35.3	-4.5	2.3				
		MIMO 2	21.5	-6.7	2.1				
4G/3G/NB-IoT/Cat M Band 5,8,18,19,20,26,27	824~960	MIMO 1	44.8	-3.5	5				
		MIMO 2	34.8	-4.6	4				
5G NR/4G Band 21,32,74,75,76	1427~1518	MIMO 1	26.8	-5.7	3.4				
		MIMO 2	40	-4	5.1				
4G/3G Band 1,2,3,4,9,23,25,35,39,66	1710~2200	MIMO 1	41.8	-3.8	6.6				
		MIMO 2	37.9	-4.2	6				
4G/3G Band 7,38,40,41	2300~2690	MIMO 1	37.9	-4.2	5.9				
		MIMO 2	40.5	-3.9	6.9				
5G NR Band 22,42,48,77,78,79	3300~5000	MIMO 1	44.9	-3.5	5.4				
		MIMO 2	48.1	-3.2	5.9				
LTE5200/ Wi-Fi 5800	5150~5925	MIMO 1	21	-6.8	3				
		MIMO 2	23.5	-6.3	3.3				

Mechanical	
Dimensions	250 x 144.3 x 52.8mm
Weight	550 g
Material	PC+ABS
Connector	LTE: SMA(M)
Cable	LTE MIMO: 3000mm TGC200
Sealant	Rubber Stopper
Environmental	
Protection	IP65
Corrosion	5% NaCl for 96hrs - Nickel plated steel base and thread
Temperature Range	-40°C to +85°C
Thermal Shock	100 cycles -40°C to +85°C
Humidity	Non-condensing 65°C 95% RH
Shock (Drop Test)	1m drop on concrete 6 axes
Cable Pull	8 Kgf

5G/4G Bands			
Band Number	5GNR / FR1 / LTE / LTE-Advanced / WCDMA / HSPA / HSPA+ / TD-SCDMA		
	Uplink	Downlink	Covered
1	UL: 1920 to 1980	DL: 2110 to 2170	✓
2	UL: 1850 to 1910	DL: 1930 to 1990	✓
3	UL: 1710 to 1785	DL: 1805 to 1880	✓
4	UL: 1710 to 1755	DL: 2110 to 2155	✓
5	UL: 824 to 849	DL: 869 to 894	✓
7	UL: 2500 to 2570	DL: 2620 to 2690	✓
8	UL: 880 to 915	DL: 925 to 960	✓
9	UL: 1749.9 to 1784.9	DL: 1844.9 to 1879.9	✓
11	UL: 1427.9 to 1447.9	DL: 1475.9 to 1495.9	✓
12	UL: 699 to 716	DL: 729 to 746	✓
13	UL: 777 to 787	DL: 746 to 756	✓
14	UL: 788 to 798	DL: 758 to 768	✓
17	UL: 704 to 716	DL: 734 to 746	✓
18	UL: 815 to 830	DL: 860 to 875	✓
19	UL: 830 to 845	DL: 875 to 890	✓
20	UL: 832 to 862	DL: 791 to 821	✓
21	UL: 1447.9 to 1462.9	DL: 1495.9 to 1510.9	✓
22	UL: 3410 to 3490	DL: 3510 to 3590	✓
23	UL: 2000 to 2020	DL: 2180 to 2200	✓
24	UL: 1625.5 to 1660.5	DL: 1525 to 1559	✓
25	UL: 1850 to 1915	DL: 1930 to 1995	✓
26	UL: 814 to 849	DL: 859 to 894	✓
27	UL: 807 to 824	DL: 852 to 869	✓
28	UL: 703 to 748	DL: 758 to 803	✓
29	UL: -	DL: 717 to 728	✓
30	UL: 2305 to 2315	DL: 2350 to 2360	✓
31	UL: 452.5 to 457.5	DL: 462.5 to 467.5	✗
32	UL: -	DL: 1452 - 1496	✓
35		1850 to 1910	✓
38		2570 to 2620	✓
39		1880 to 1920	✓
40		2300 to 2400	✓
41		2496 to 2690	✓
42		3400 to 3600	✓
43		3600 to 3800	✓
48		3550 to 3700	✓
66	UL: 1710-1780	DL: 2110-2200	✓
71		617 to 698	✓
74/75/76		1427 to 1518	✓
78		3300 to 3800	✓
79		4400 to 5000	✓
126		410 to 430	✗

3. Antenna Characteristics

3.1 Return Loss – 5G/4G MIMO Free Space

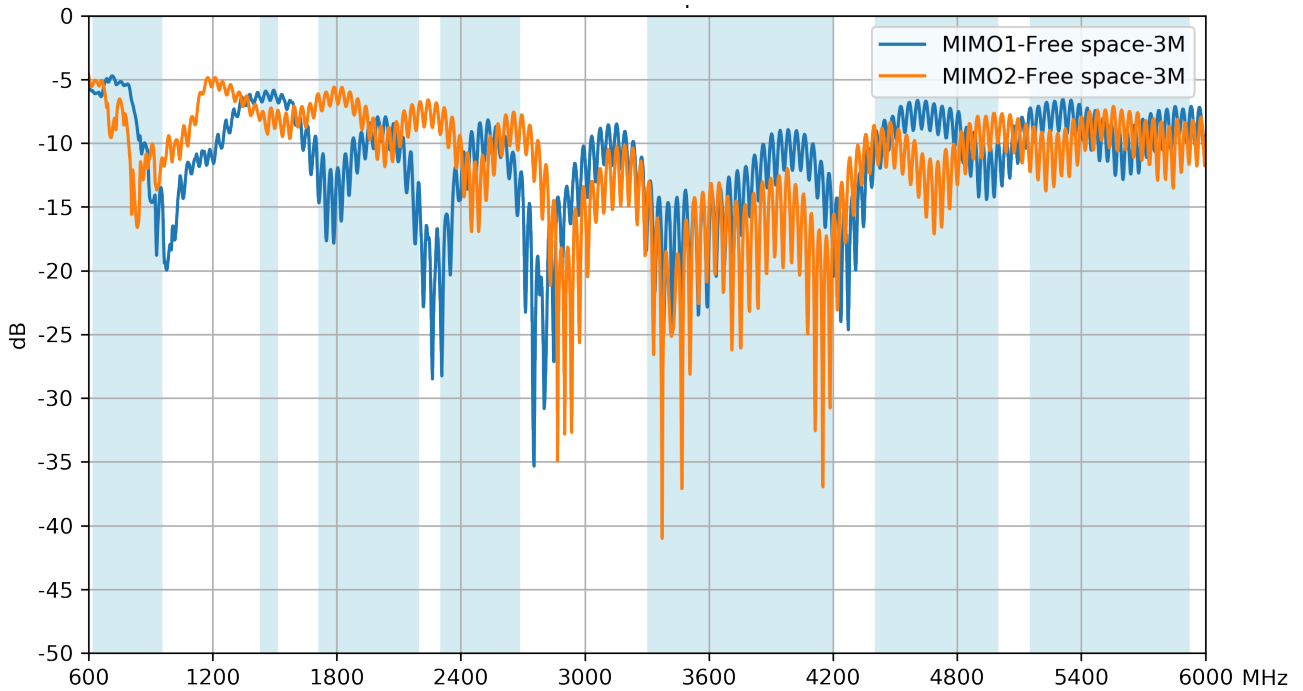

3.2 Return Loss – 5G/4G MIMO 30*30cm Ground Plane

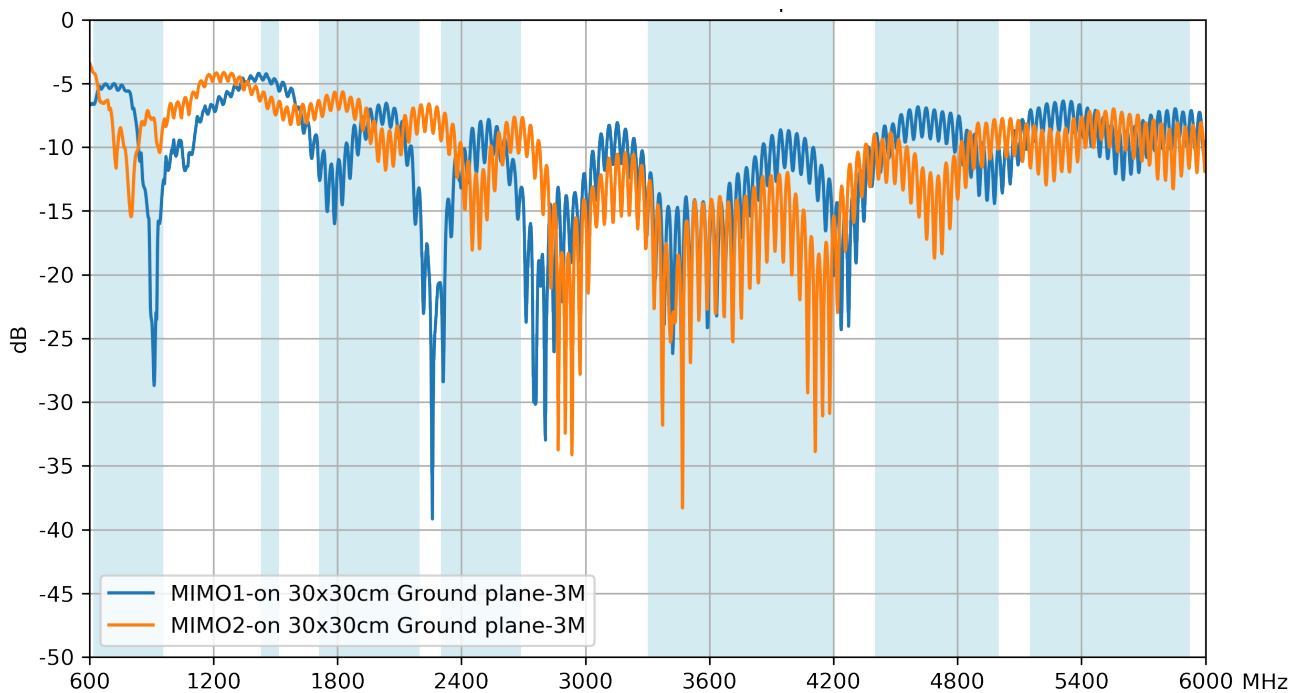

3.3 Isolation

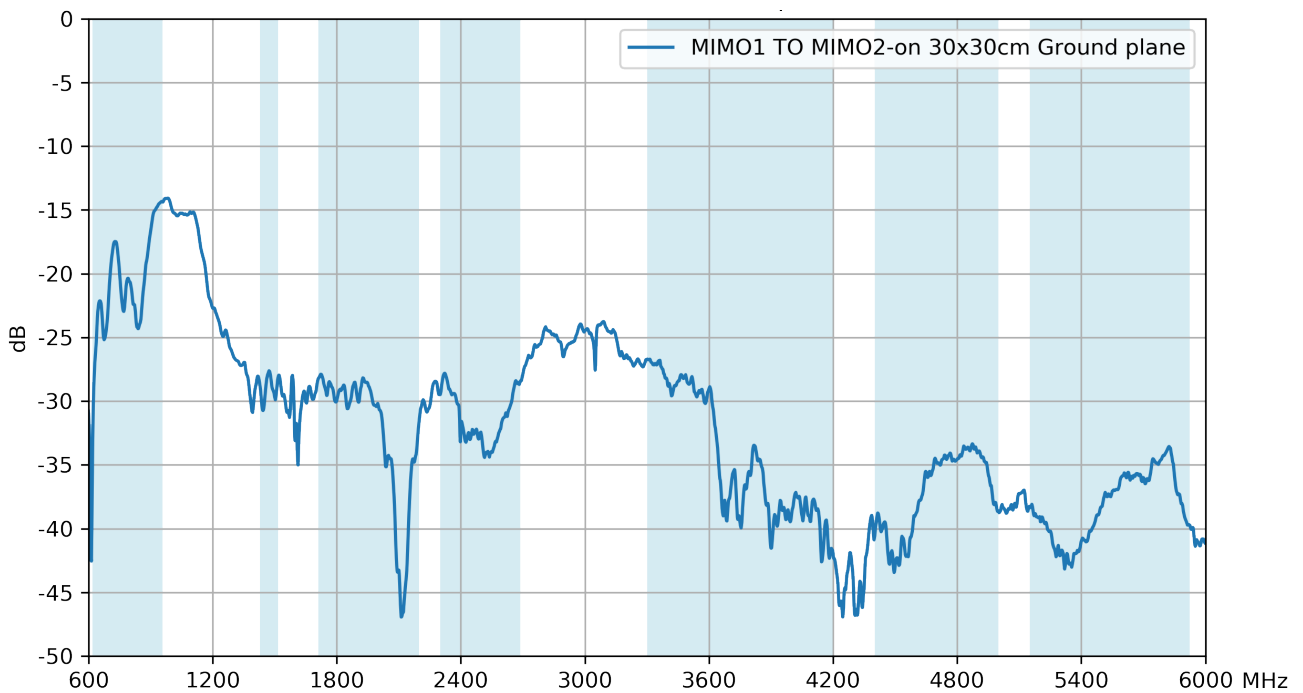

3.4 Efficiency – 5G/4G MIMO Free Space

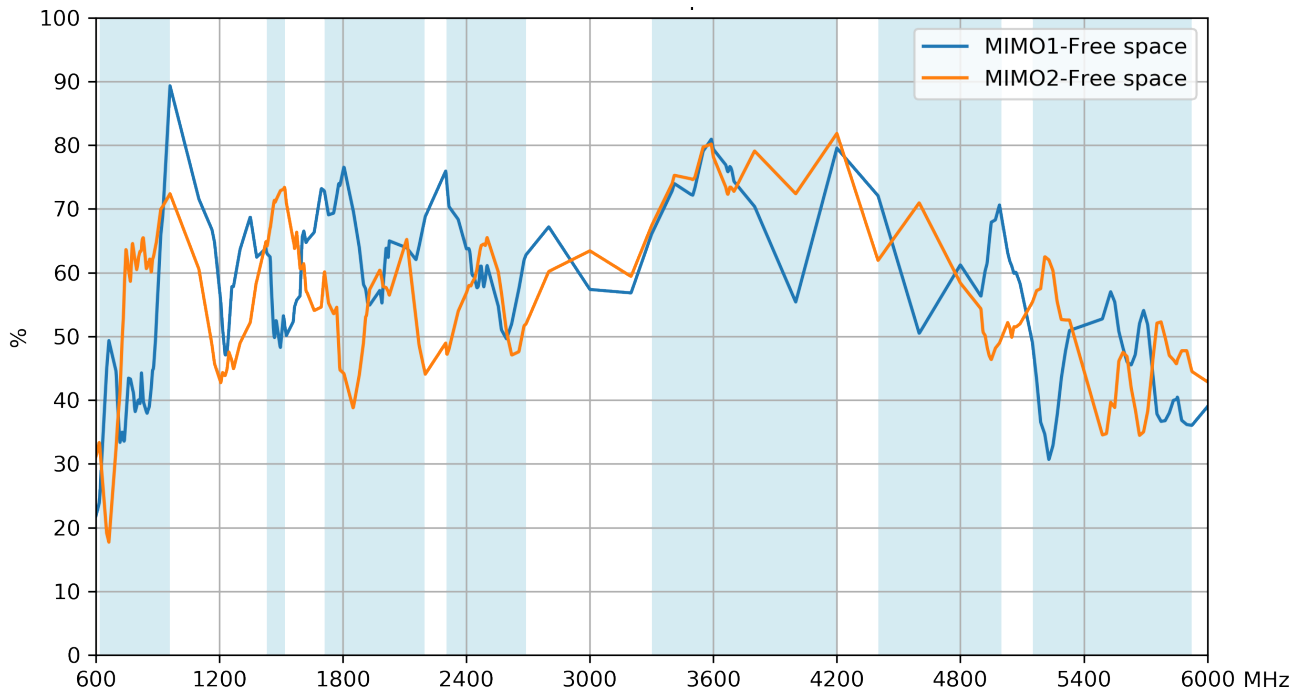

3.5 Efficiency – 5G/4G MIMO 30*30cm Ground Plane

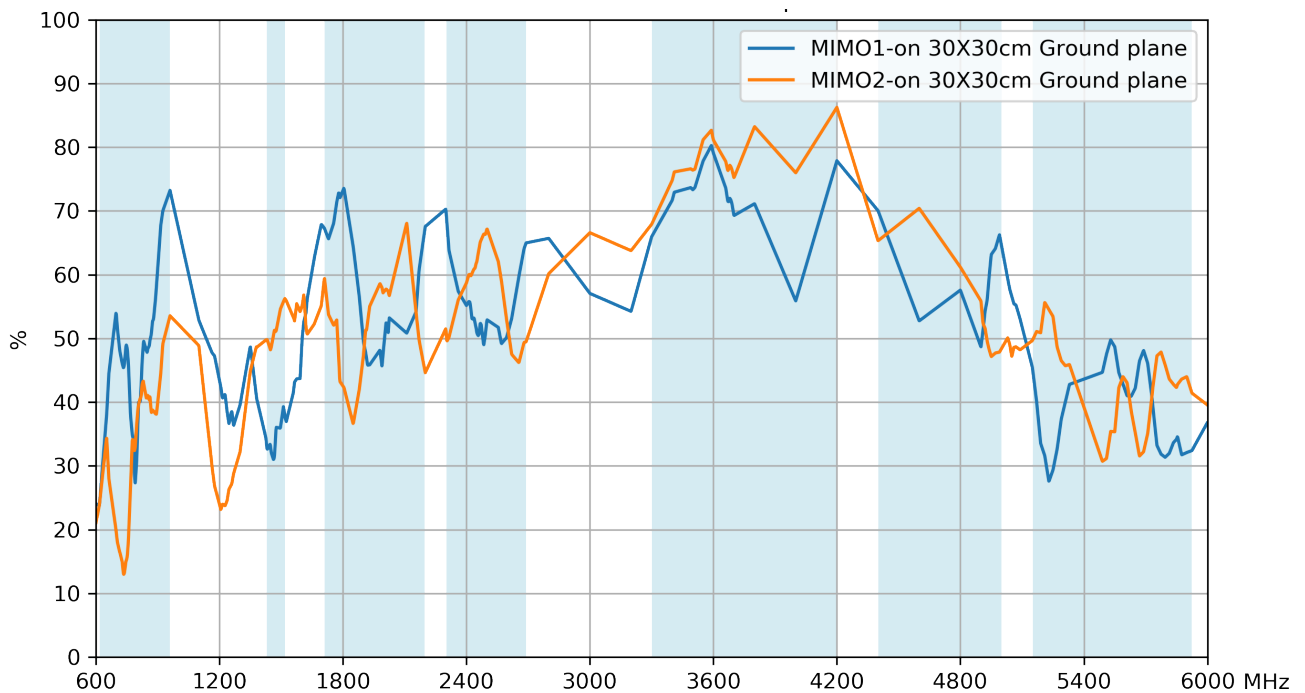

3.6 Average Gain – 5G/4G MIMO Free Space

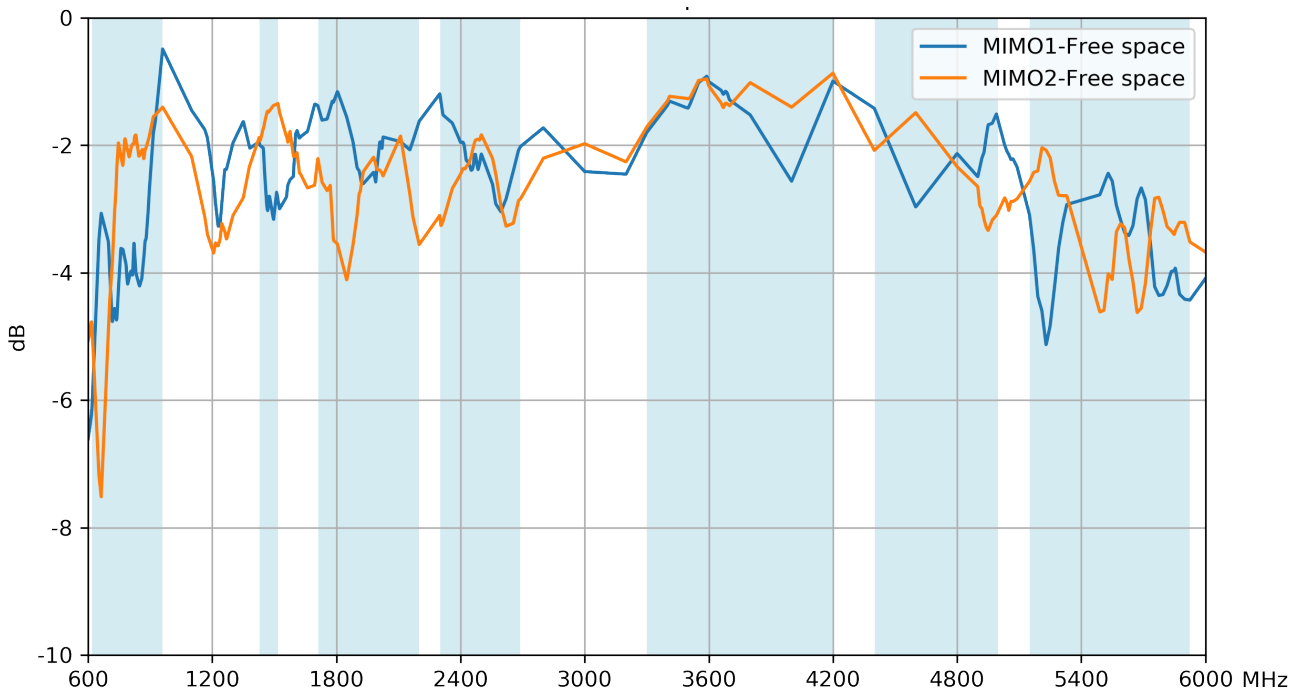

3.7 Average Gain – 5G/4G MIMO 30*30cm Ground Plane

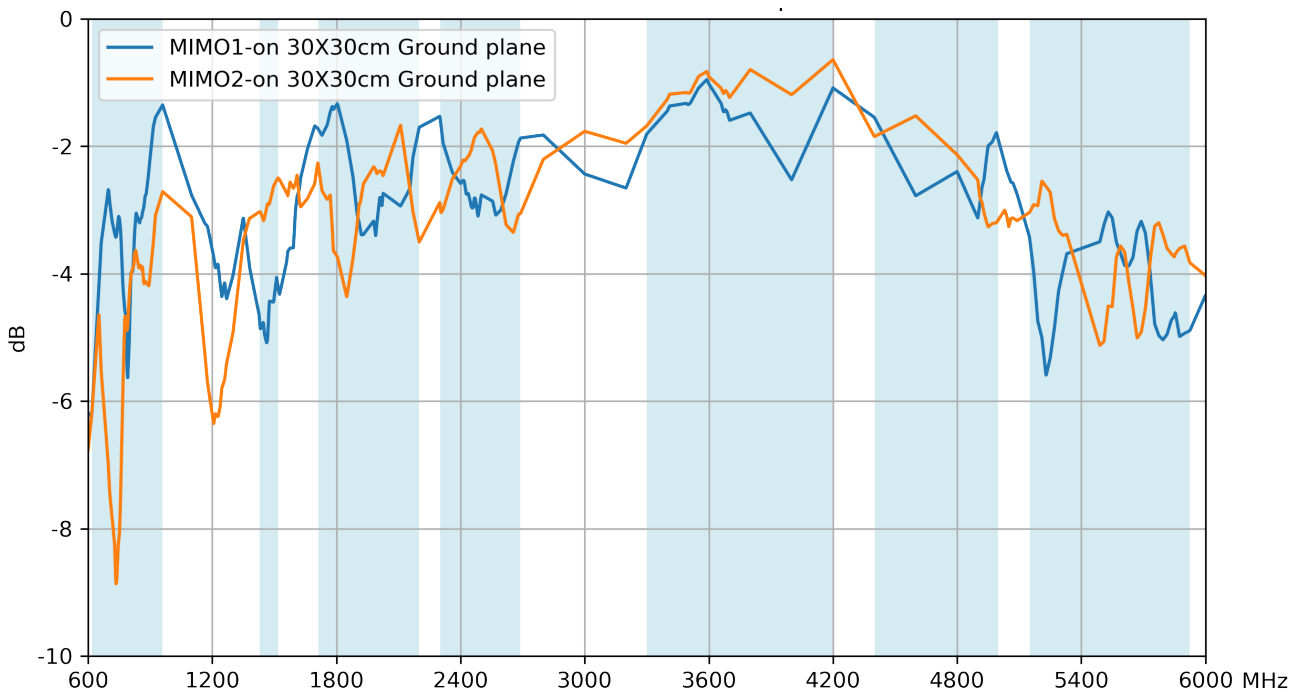

3.8 Peak Gain – 5G/4G MIMO Free Space

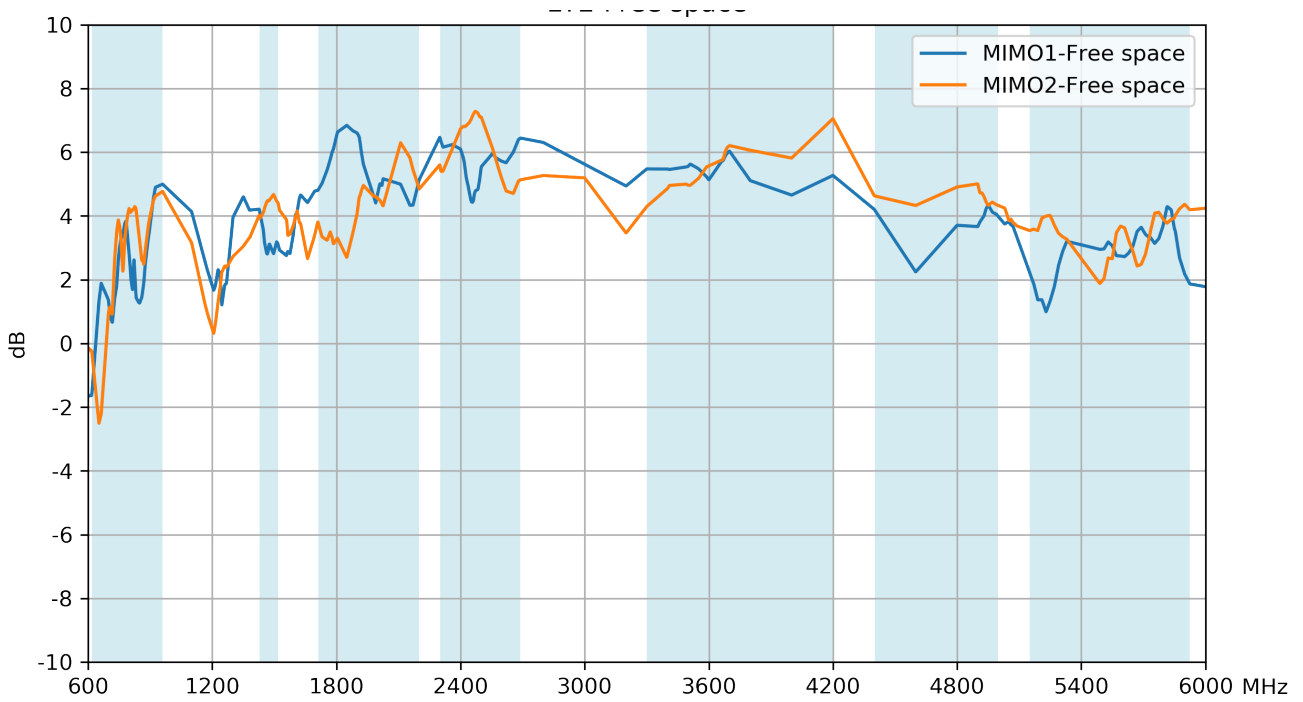

3.9 Peak Gain – 5G/4G MIMO 30*30cm Ground Plane

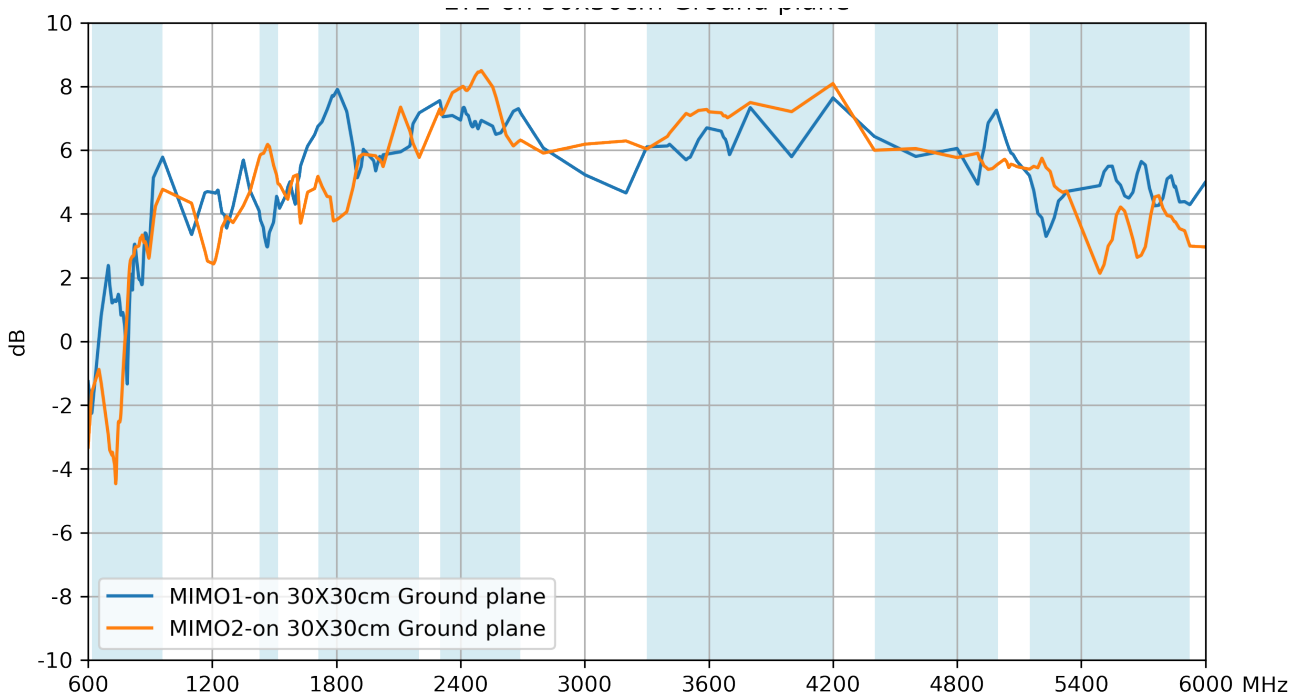

4. Radiation Patterns

4.1 Test Setup – 30*30cm Ground Plane

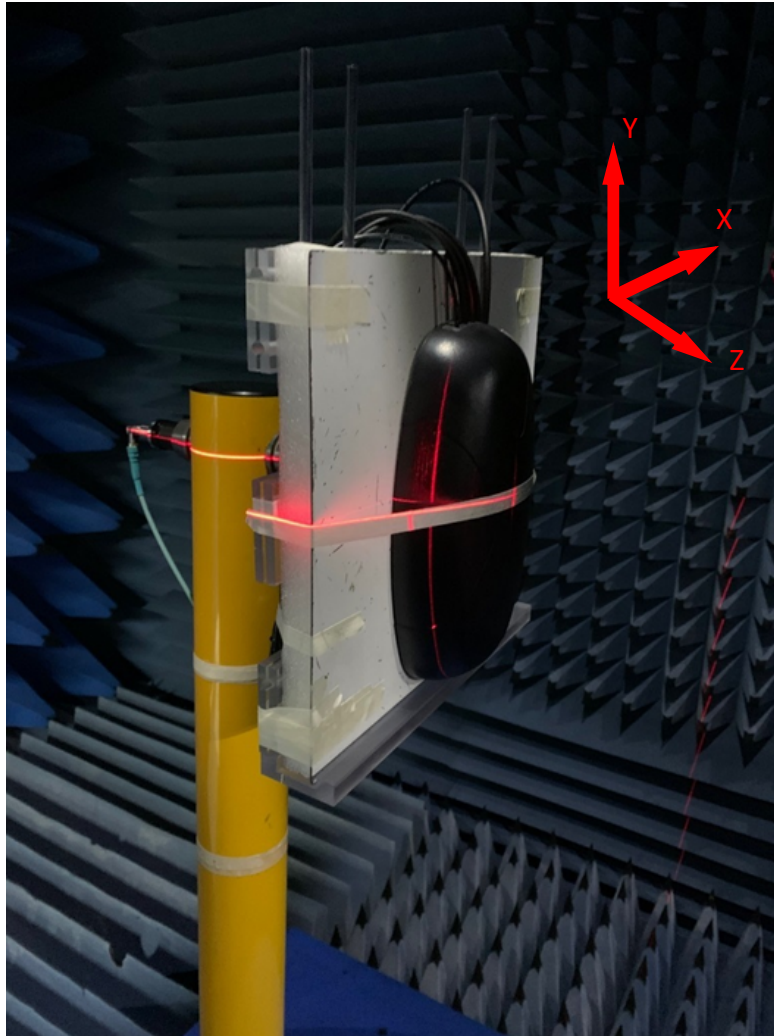

4.2 5G/4G MIMO 1 3D and 2D Radiation Patterns – 30*30cm Ground Plane

652MHz

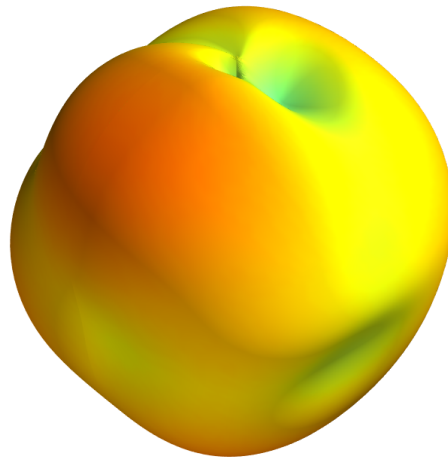

XY Plane

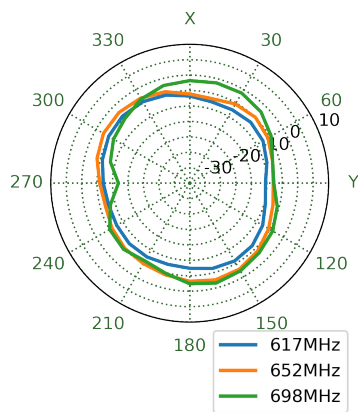

XZ Plane

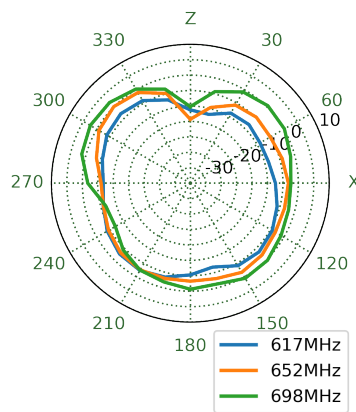

YZ Plane

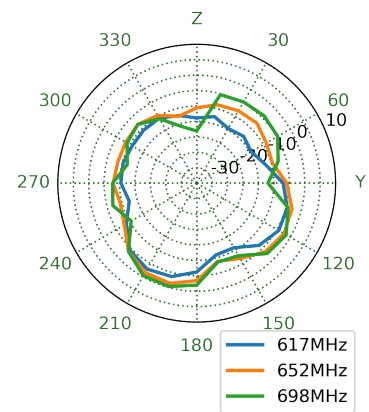

751MHz

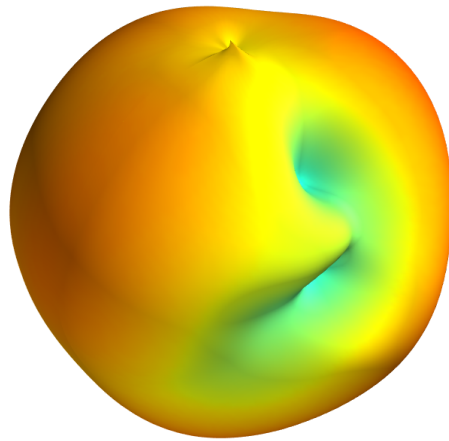

XY Plane

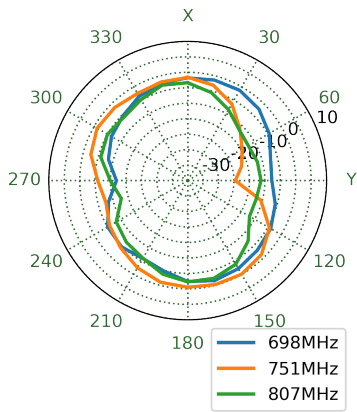

XZ Plane

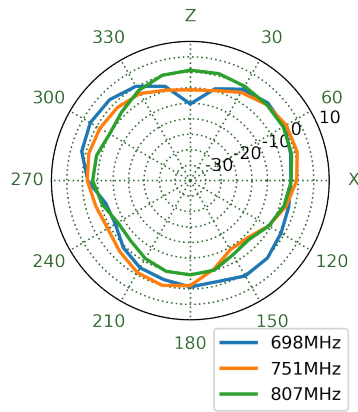

YZ Plane

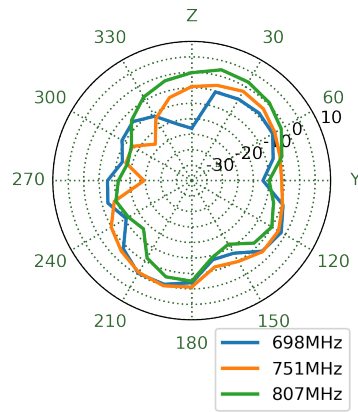

890MHz

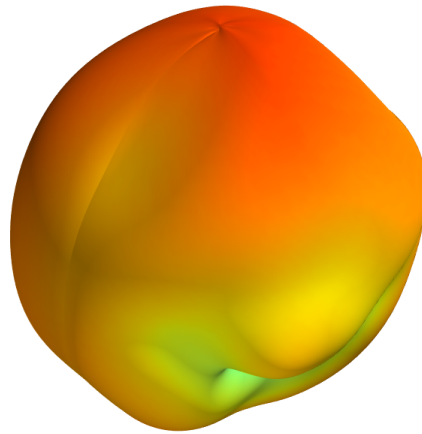

XY Plane

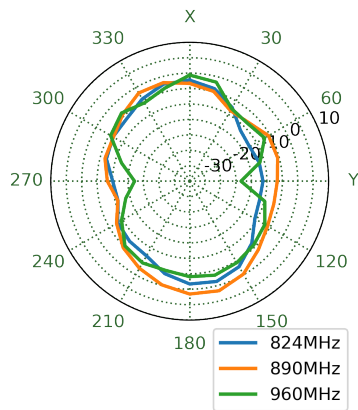

XZ Plane

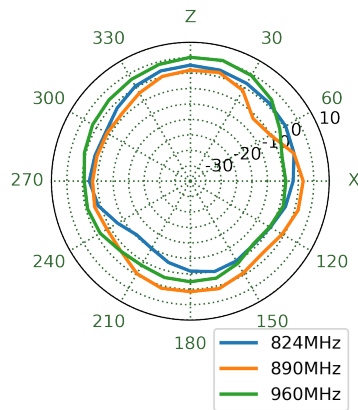

YZ Plane

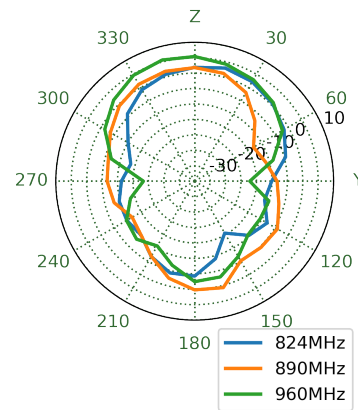

1470MHz

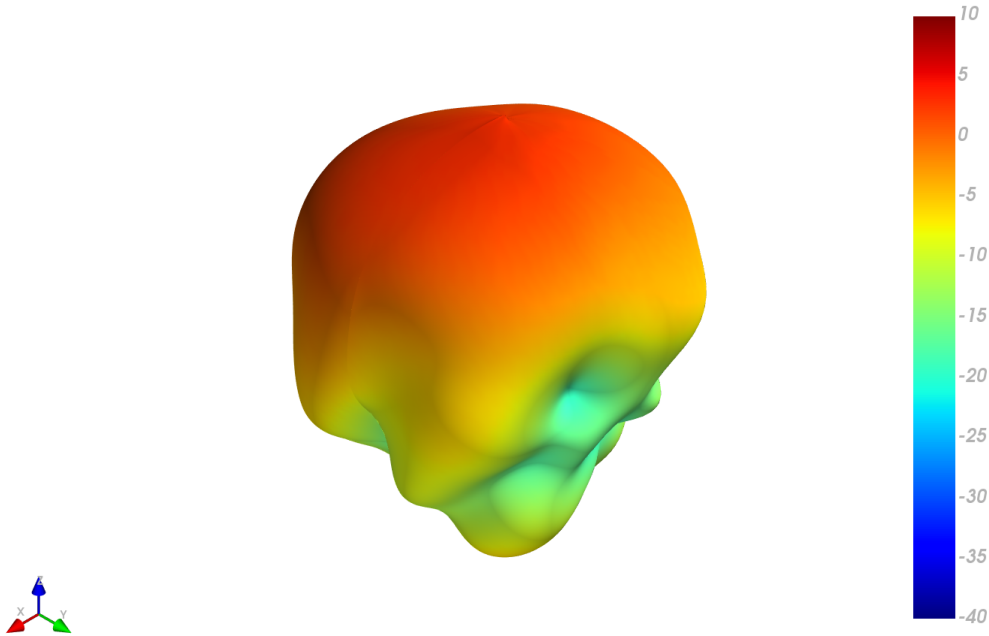

XY Plane

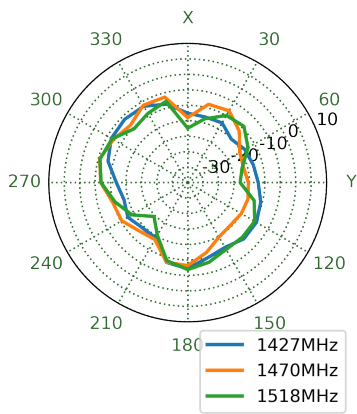

XZ Plane

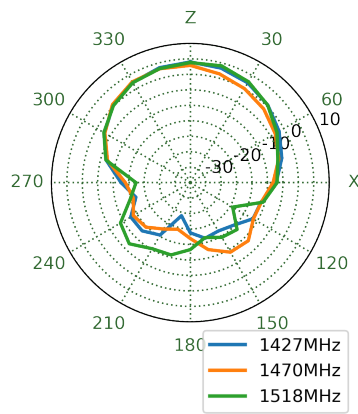

YZ Plane

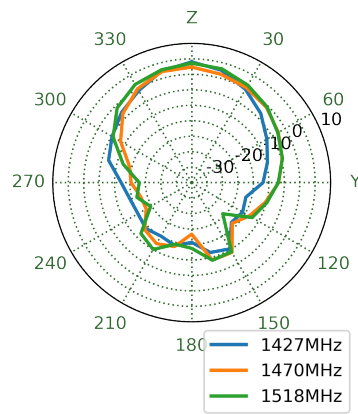

1805MHz

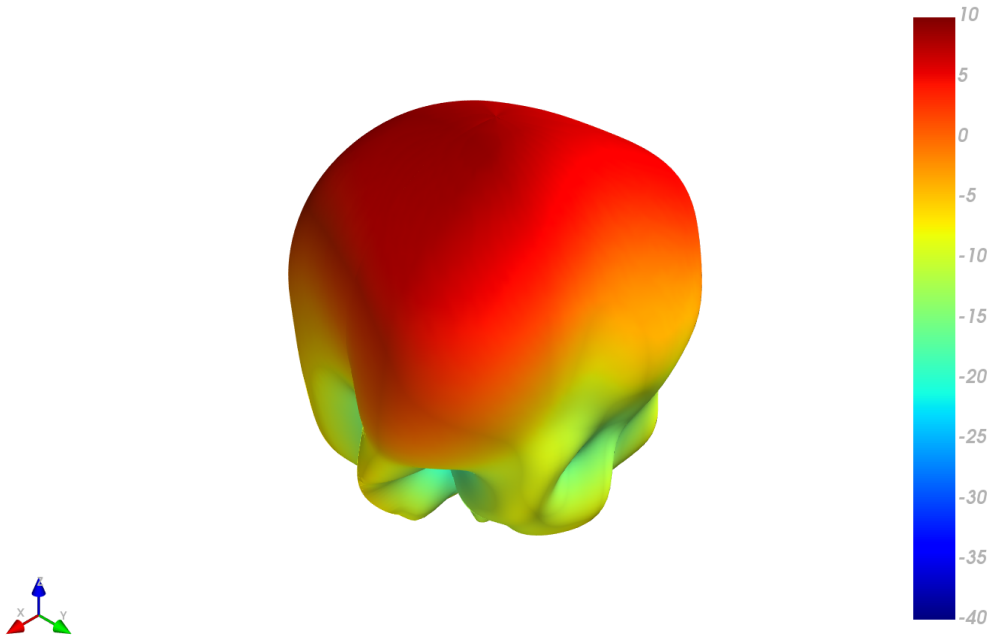

XY Plane

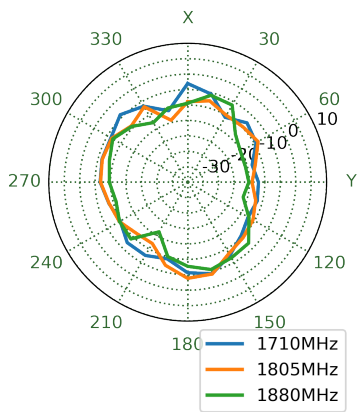

XZ Plane

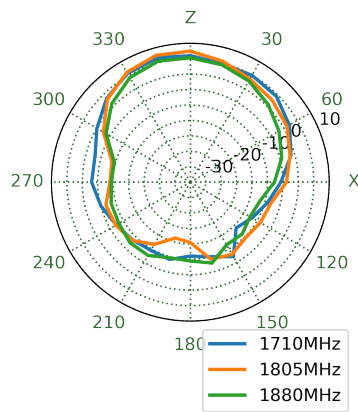

YZ Plane

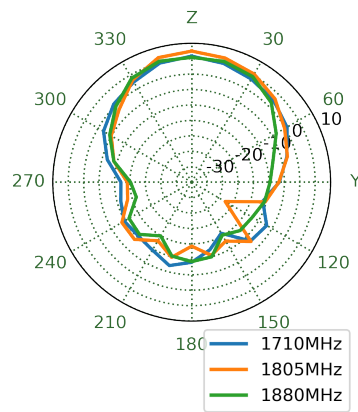

1920MHz

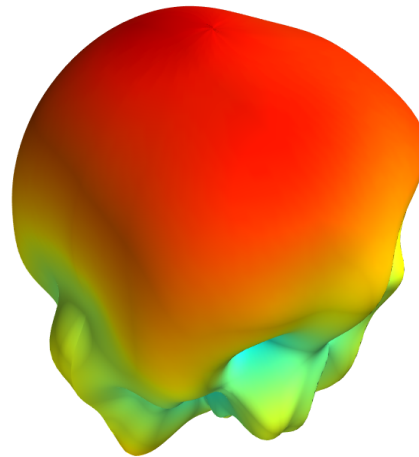

XY Plane

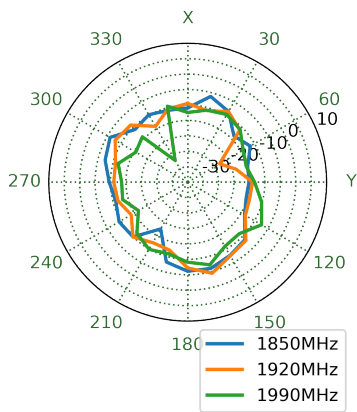

XZ Plane

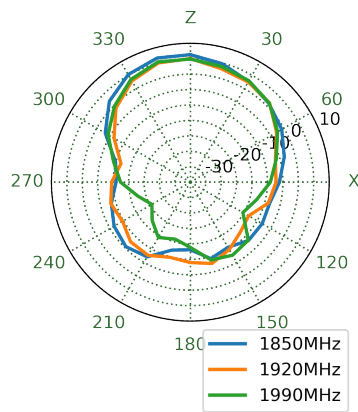

YZ Plane

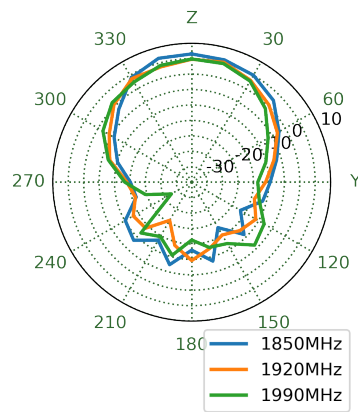

1990MHz

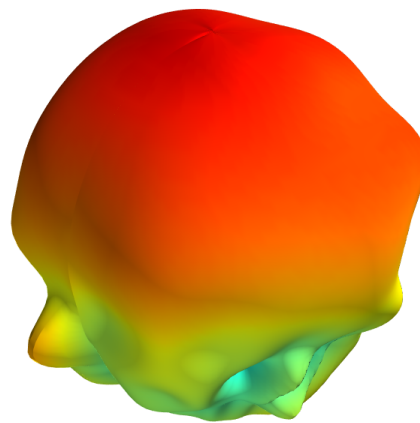

XY Plane

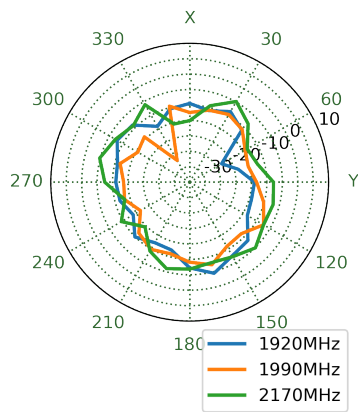

XZ Plane

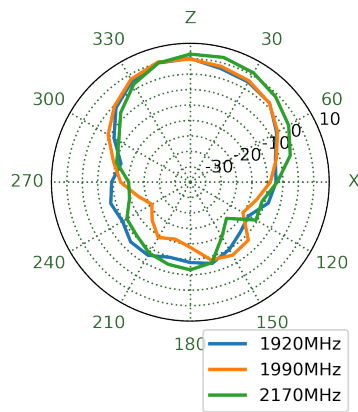

YZ Plane

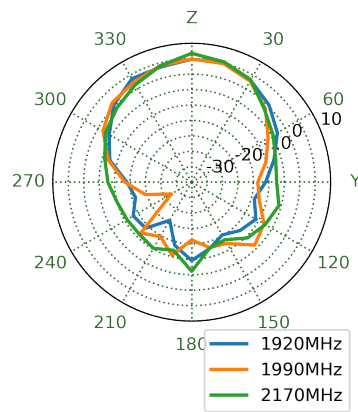

2595MHz

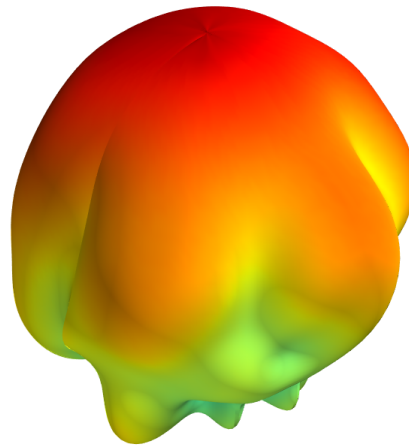

XY Plane

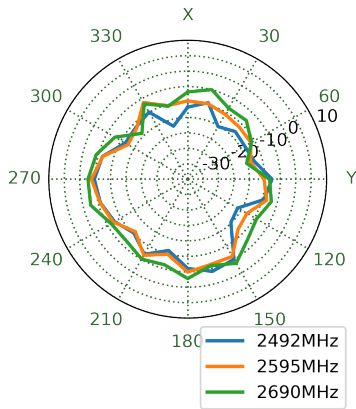

XZ Plane

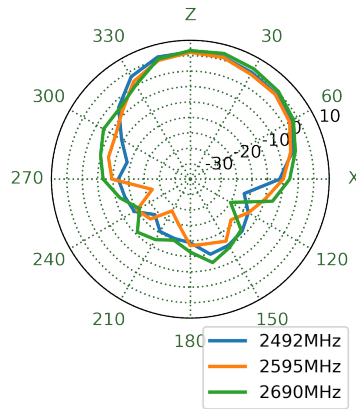

YZ Plane

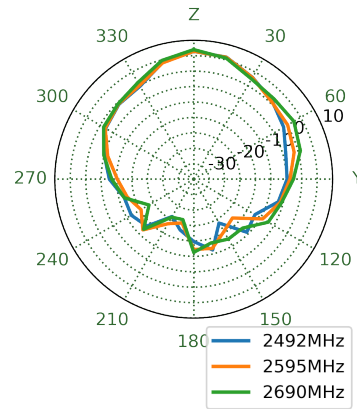

3550MHz

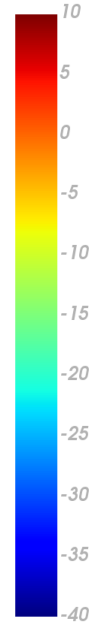
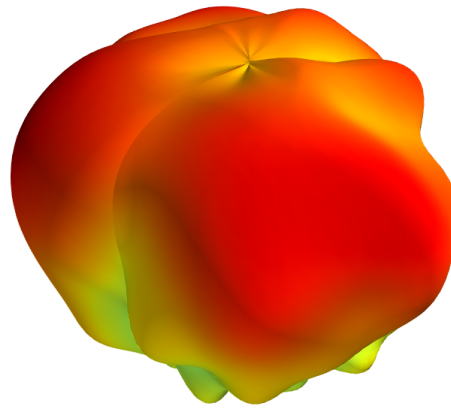

XY Plane

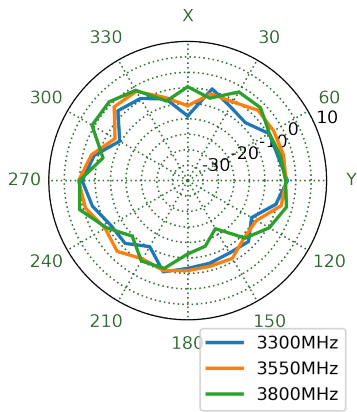

XZ Plane

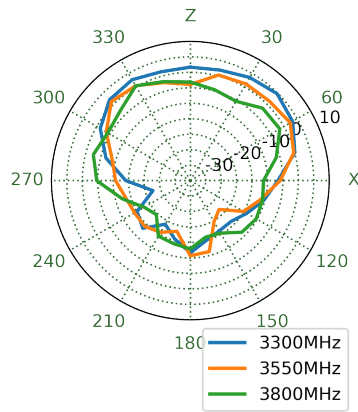

YZ Plane

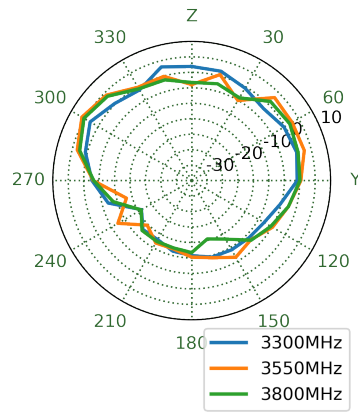

5530MHz

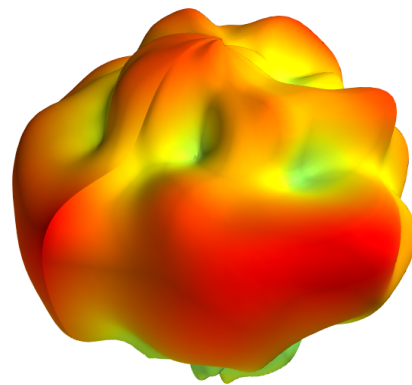

XY Plane

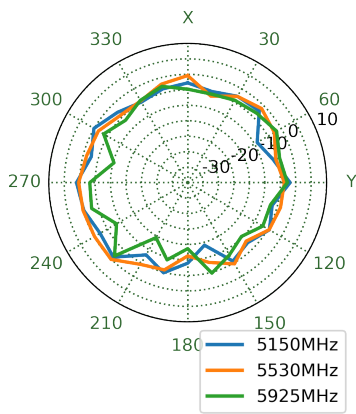

XZ Plane

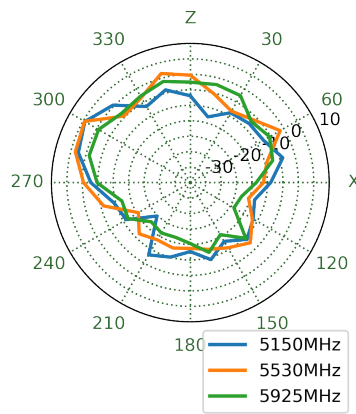

YZ Plane

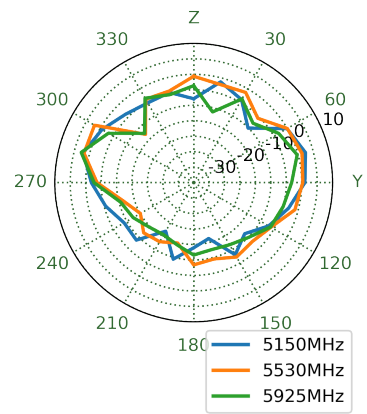

4.3 5G/4G MIMO 2 3D and 2D Radiation Patterns – 30*30cm Ground Plane

652MHz

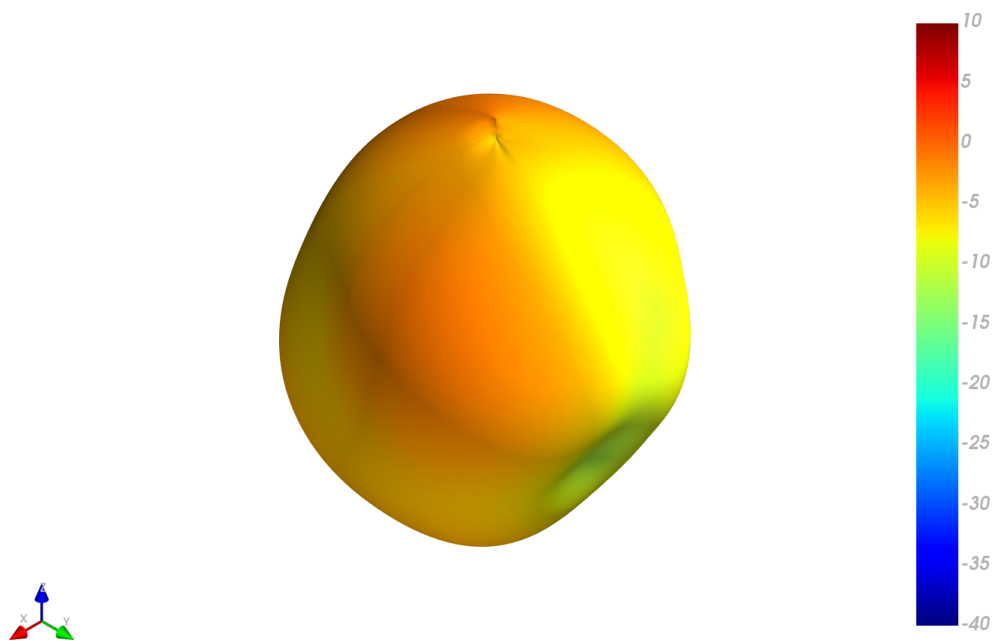

XY Plane

XZ Plane

YZ Plane

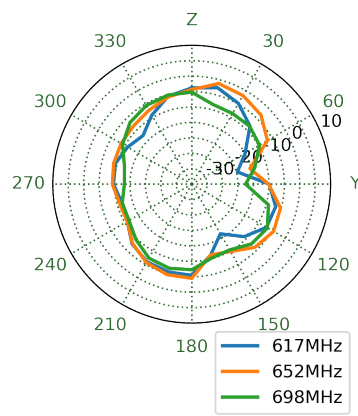
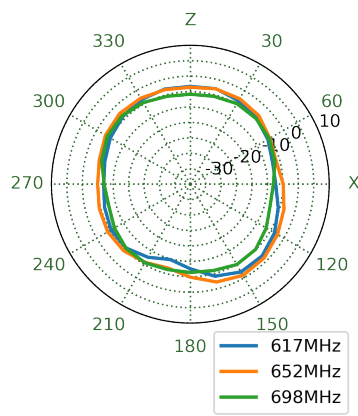
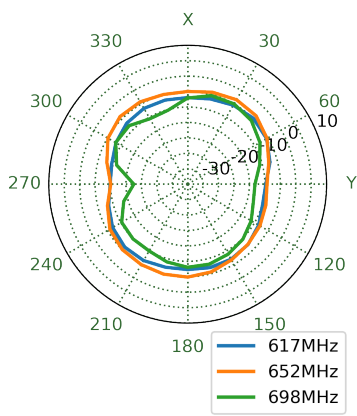

751MHz

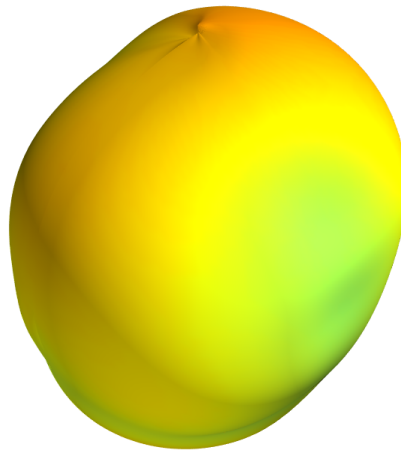

XY Plane

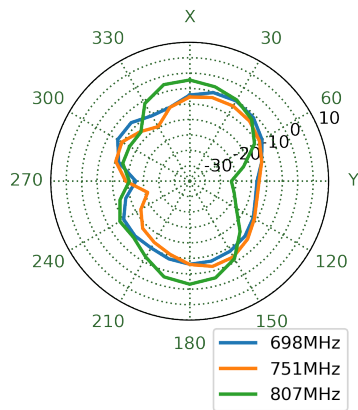

XZ Plane

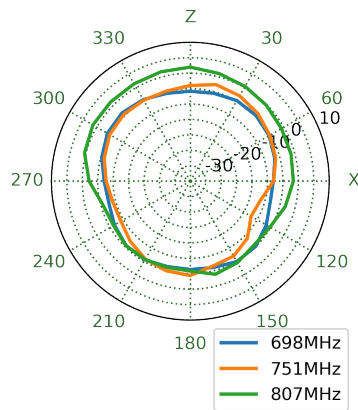

YZ Plane

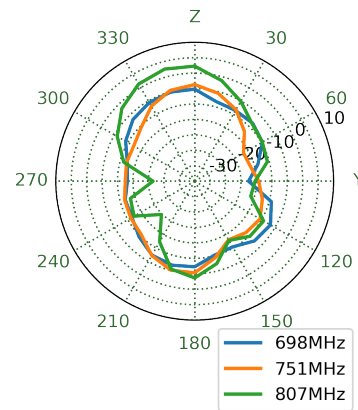

890MHz

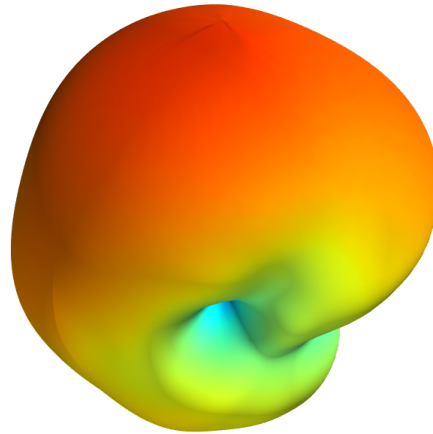

XY Plane

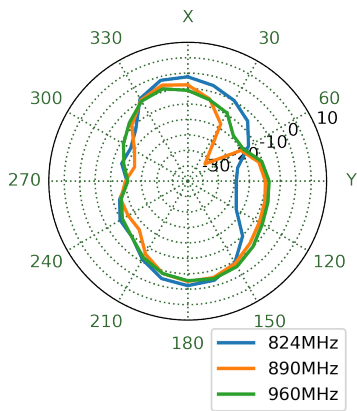

XZ Plane

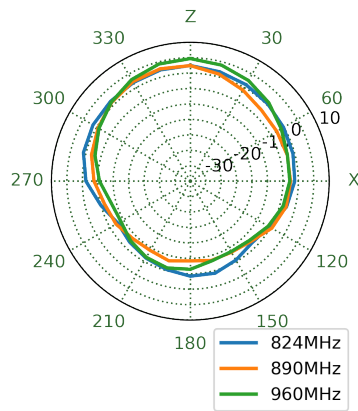

YZ Plane

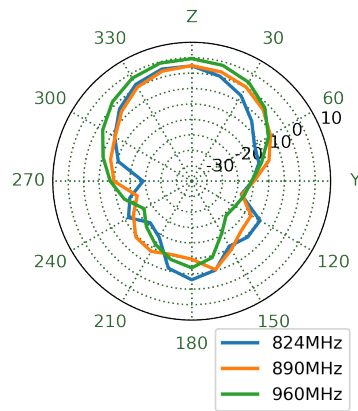

1470MHz

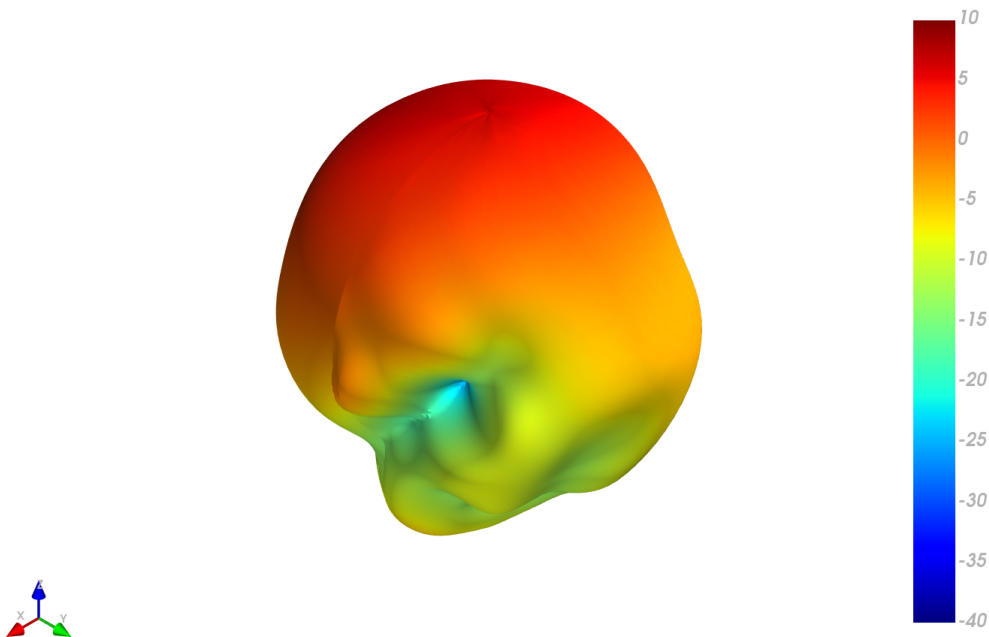

XY Plane

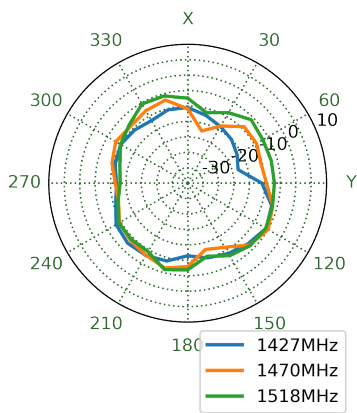

XZ Plane

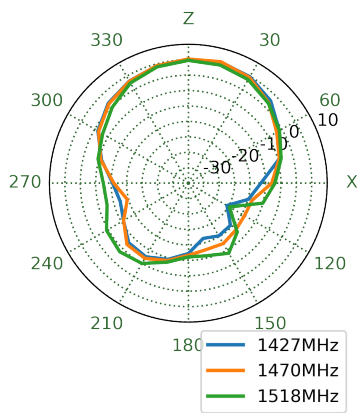

YZ Plane

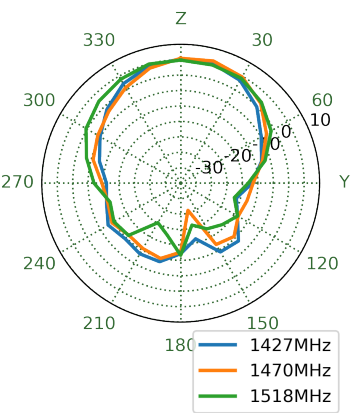

1805MHz

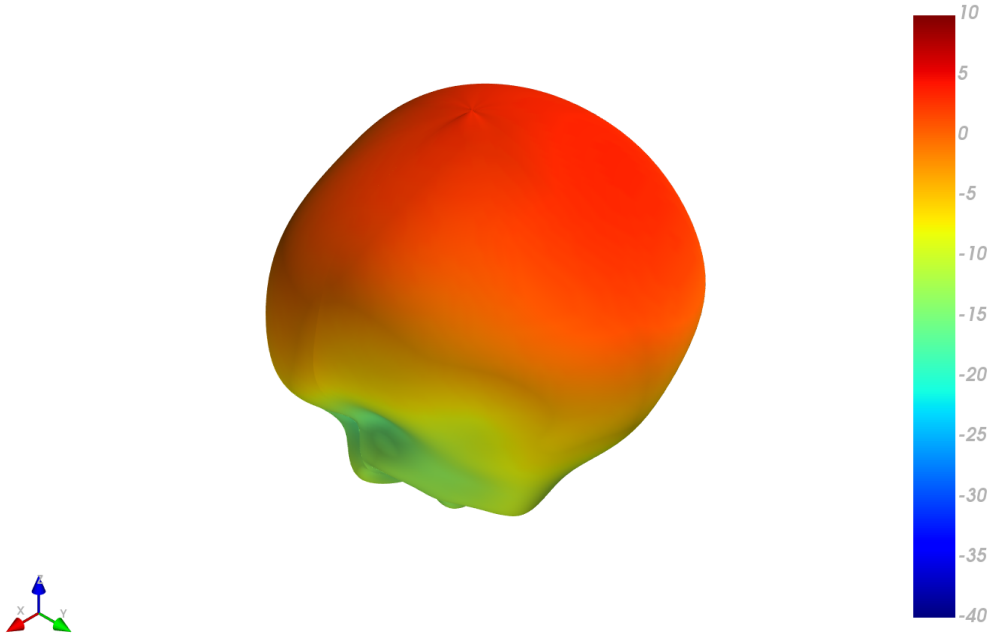

XY Plane

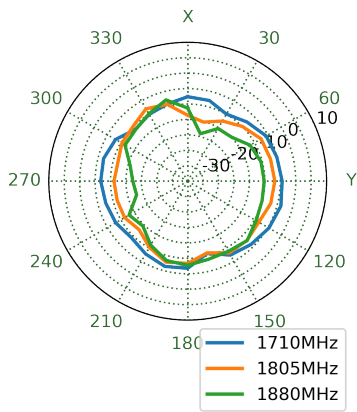

XZ Plane

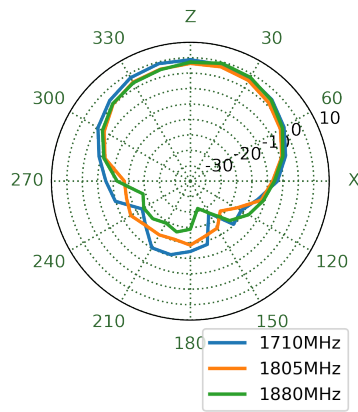

YZ Plane

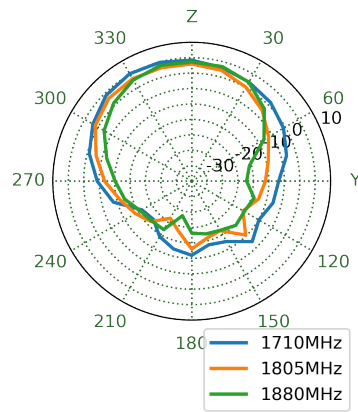

1920MHz

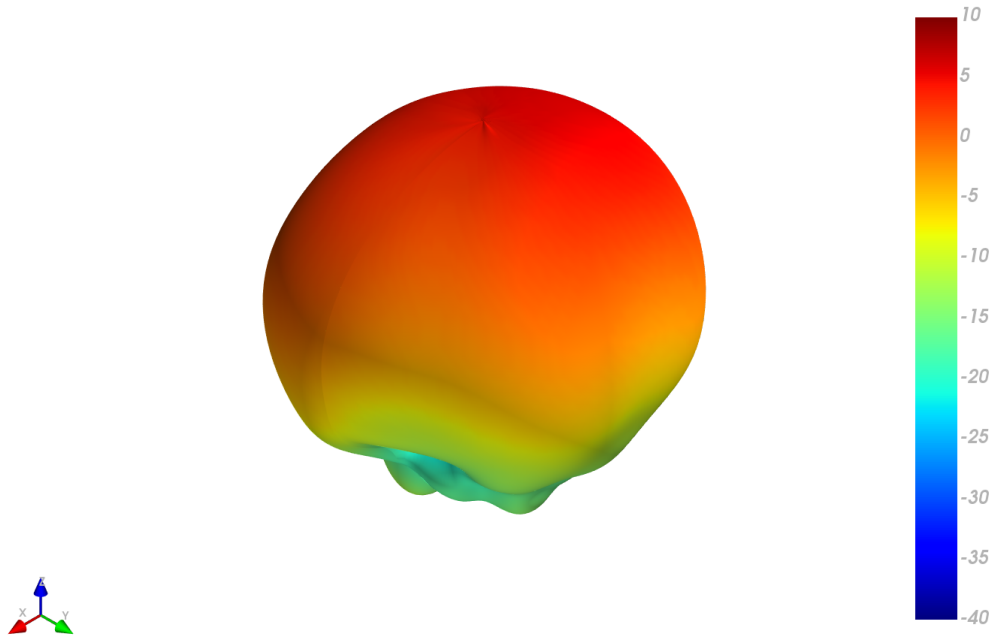

XY Plane

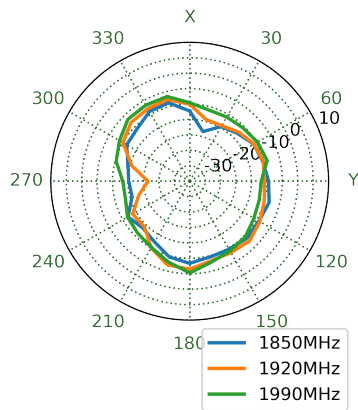

XZ Plane

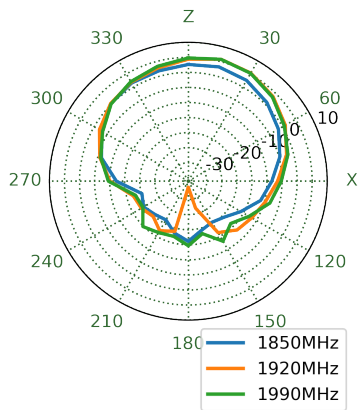

YZ Plane

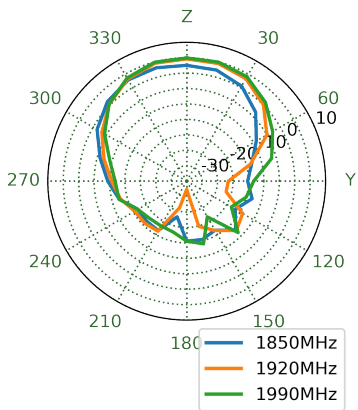

1990MHz

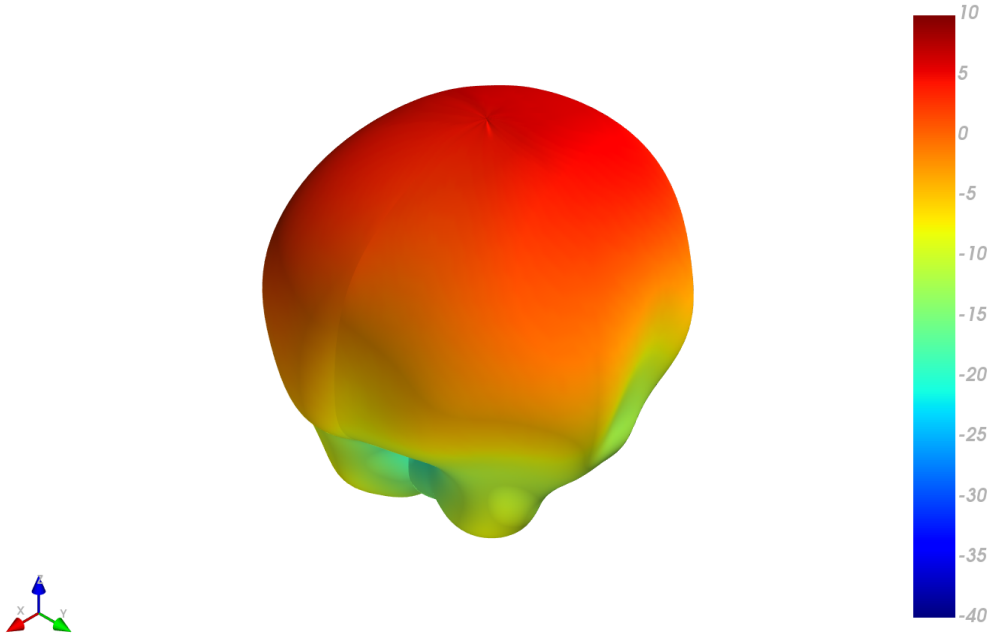

XY Plane

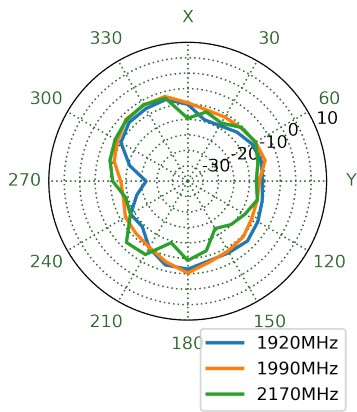

XZ Plane

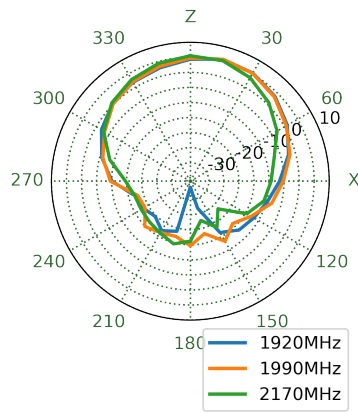

YZ Plane

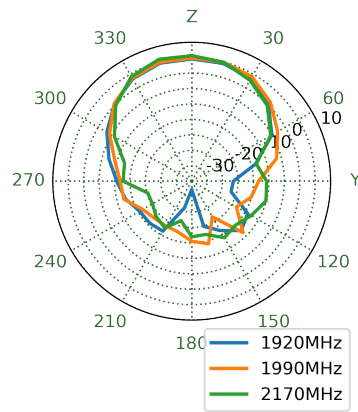

2595MHz

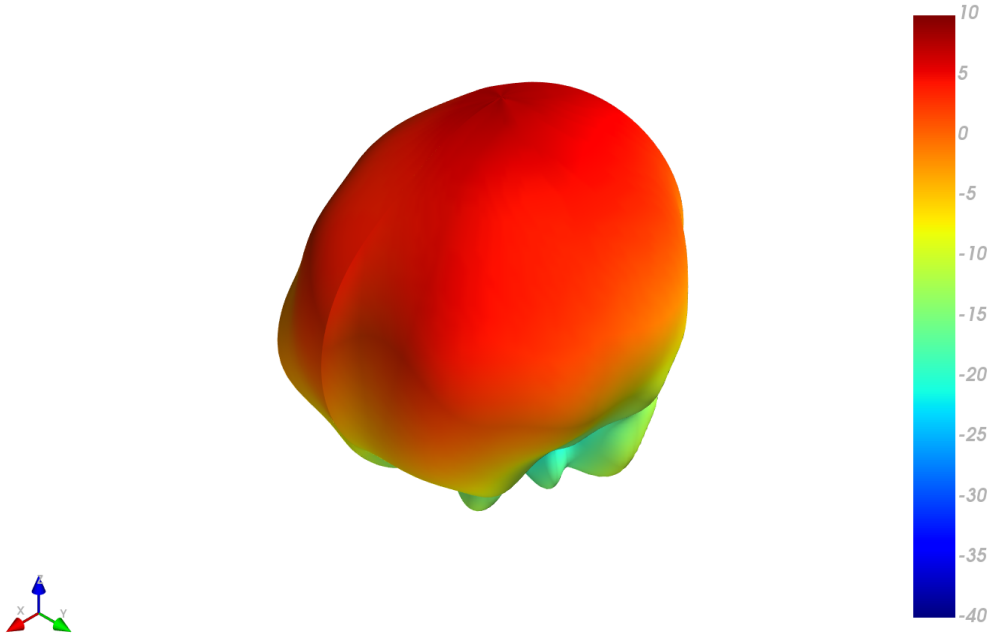

XY Plane

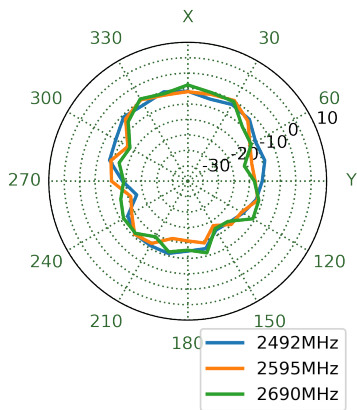

XZ Plane

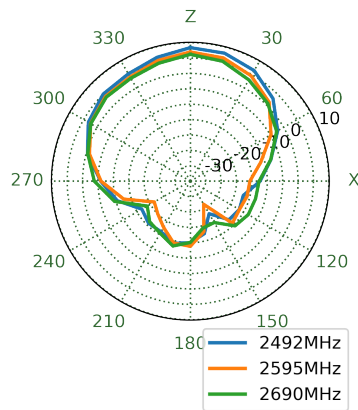

YZ Plane

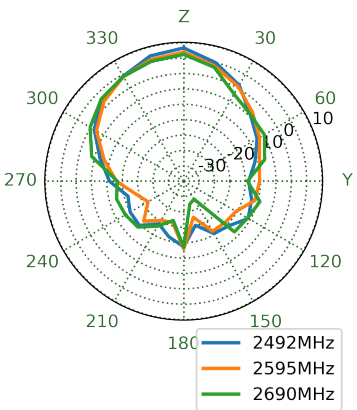

3550MHz

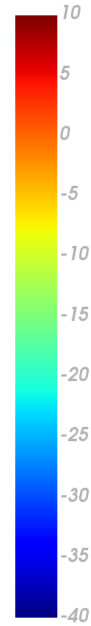
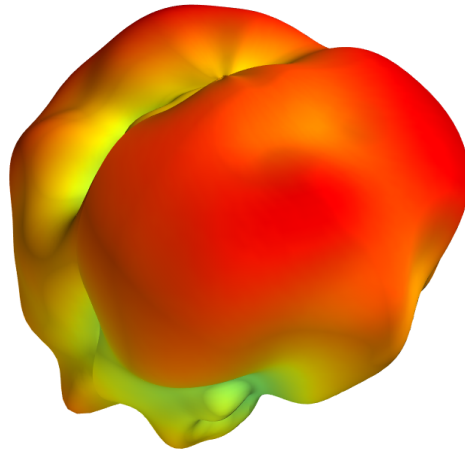

XY Plane

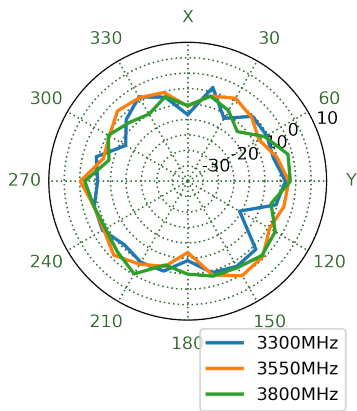

XZ Plane

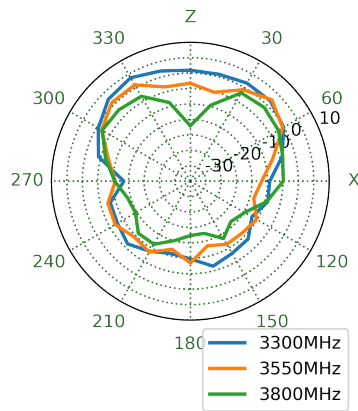

YZ Plane

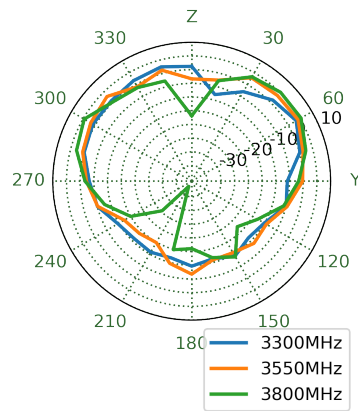

5530MHz

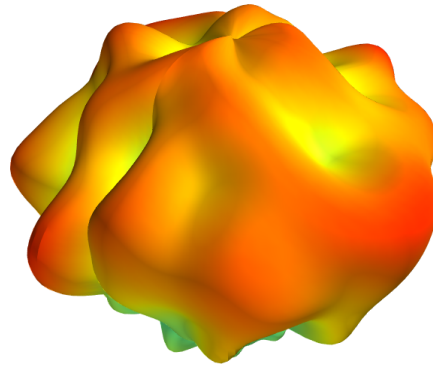

XY Plane

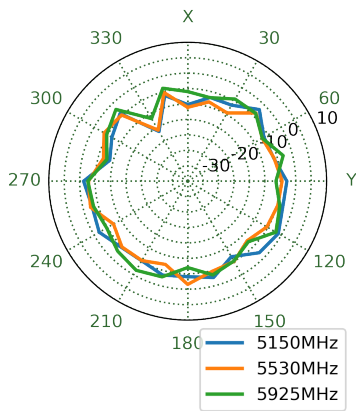

XZ Plane

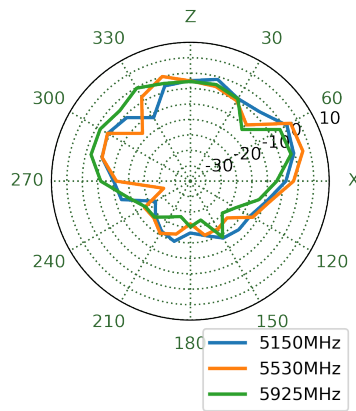

YZ Plane

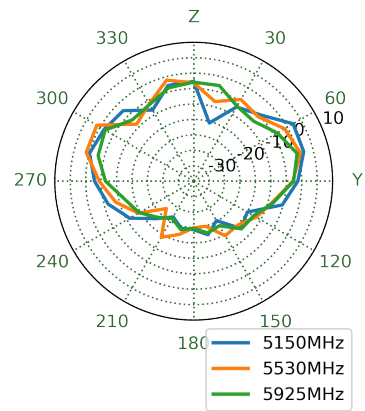

5. Mechanical Drawing (Units: mm)

ISO NO.: EDW-20-8-0551

STATE: Release

NOTES: 1. All material must be RoHS compliant.

REV.	DESCRIPTION	ENG.	APPROVED	DATE
	Initial Design	Ruby	Clark	2020/06/23
	Modify the drawing	Aron Yan	Aaron	2021/07/15

Front View

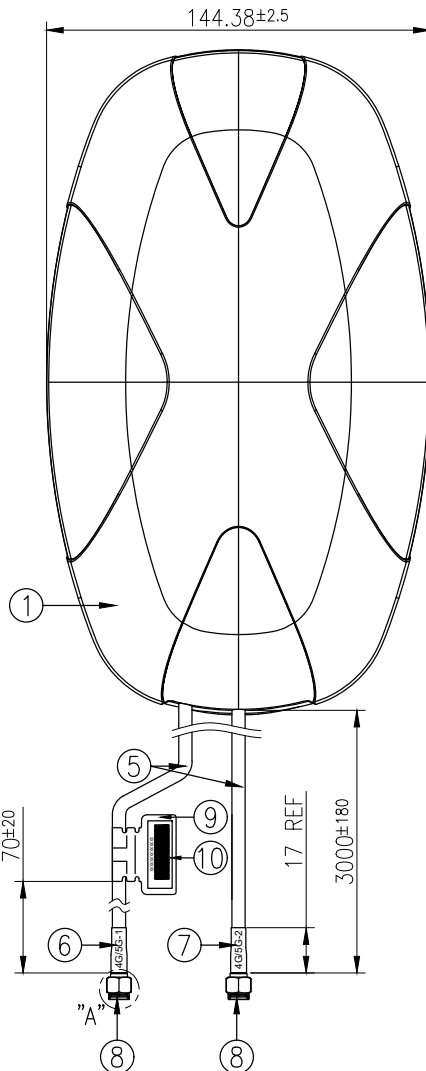

Side View

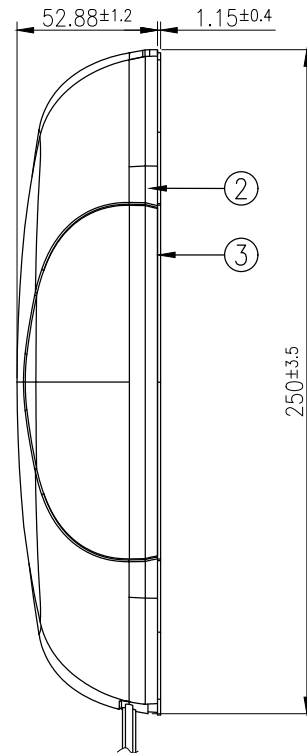

Bottom View

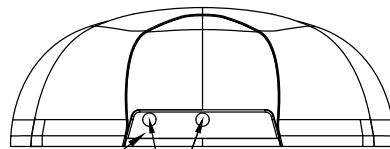

4

Cable

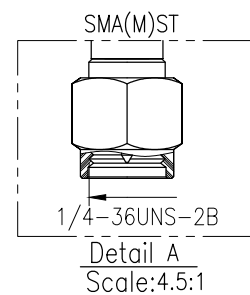

Name	Material	Finish	QTY
1 Steeden_Housing_Top	ABS+PC/PC345	Black	1
2 Steeden_Housing_Bottom	ABS+PC/PC345	Black	1
3 Closed Cell Foam	3M CR4305	Black	1
4 Rubber	TPE	Black	1
5 TGC200 Coaxial Cable	PE	Black	2
6 Heat Shrink Tube (4G/5G-1)	PE	Red Tube/White Text	1
7 Heat Shrink Tube (4G/5G-2)	PE	Red Tube/White Text	1
8 SMA(M)ST for TGC200	Brass	Au Plated	2
9 Empty Label	PEPA	White	1
10 Barcode Label	PET	White	1

APPROVED BY: Clark	TW Design Centre <small>This drawing and its inherent design concepts are property of Taoglas. Not to be copied or given to third parties without the written consent of Taoglas.</small>
CHECK BY: Aaron	
DRAWN BY: Ruby	
DATE: 2020/06/23	TITLE : 2in1 Steeden Magnet Mount 3m 5G/4G(1&2) TGC-200 SMA(M)
UNLESS OTHERWISE SPECIFIED TOLERANCES ON: XX±0.5 X±0.3 X±0.2 .XX±0.1 .XXX±0.05	PART NO. : MA351.A.BI.001
THIRD ANGLE PROJECTION	UNIT: mm SCALE: 1:2.5 PAGES: 1/1 REV. D02

6. Packaging

1pc MA351.A.LBI.001 per PE Bag
 PE Bag Dimensions - 300*150mm
 Weight - 0.55Kg

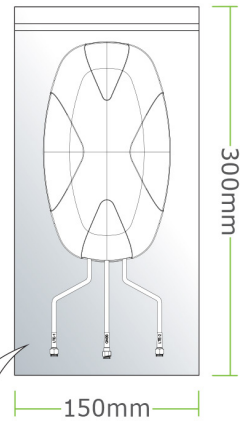

12 PE Bags per Carton
 Box Dimensions - 549*520*370mm
 Weight - 6.6Kg

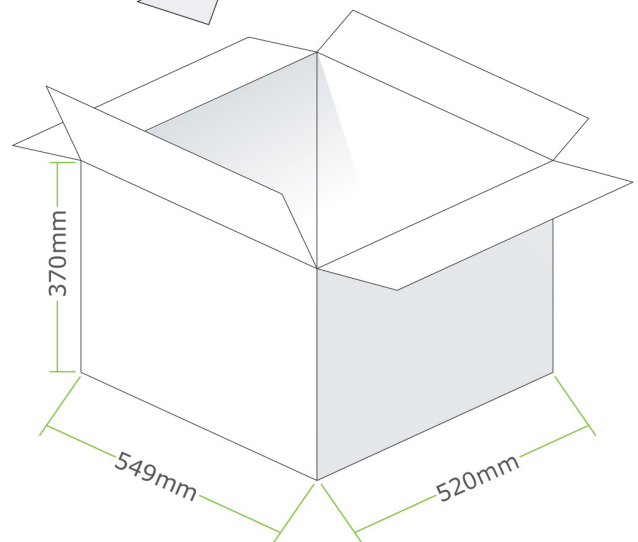

7. Application Note

The MA351's performance can be affected by the cable length chosen by a customer, below is the 5G/4G MIMO performance over different cable lengths.

8.1 Return Loss – 5G/4G MIMO 1 & 2

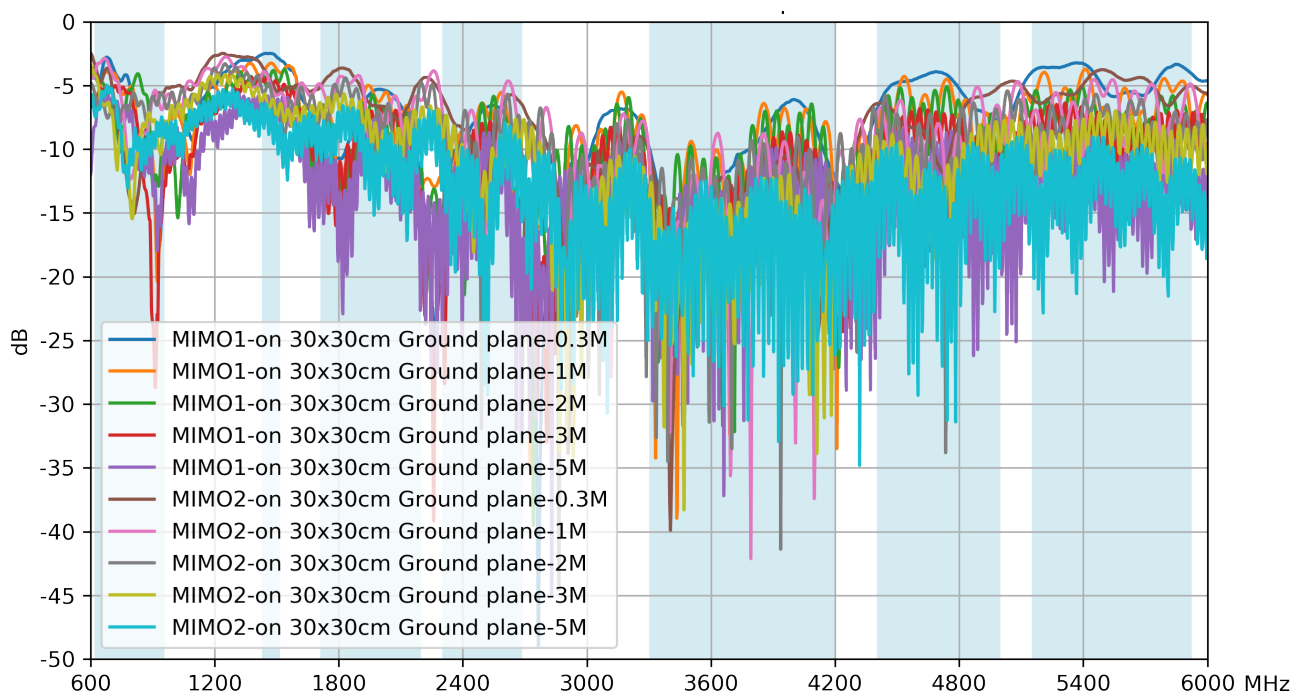
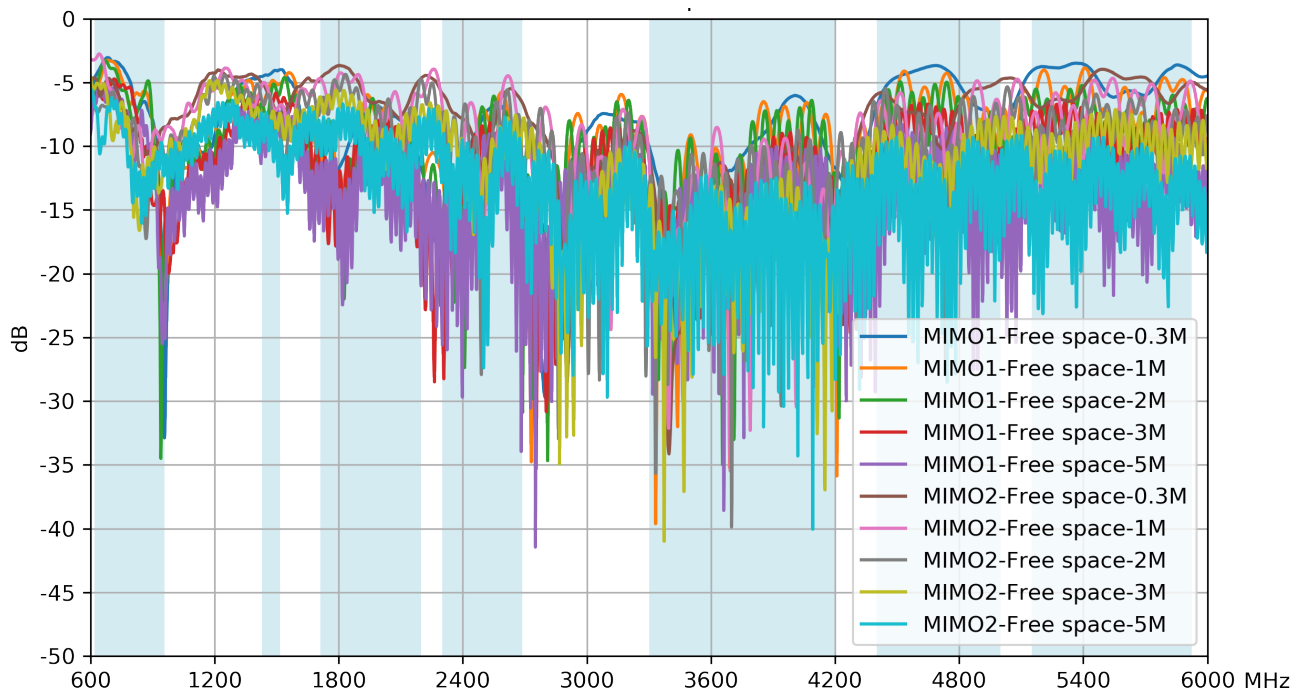

8.2 Efficiency – 5G/4G MIMO 1

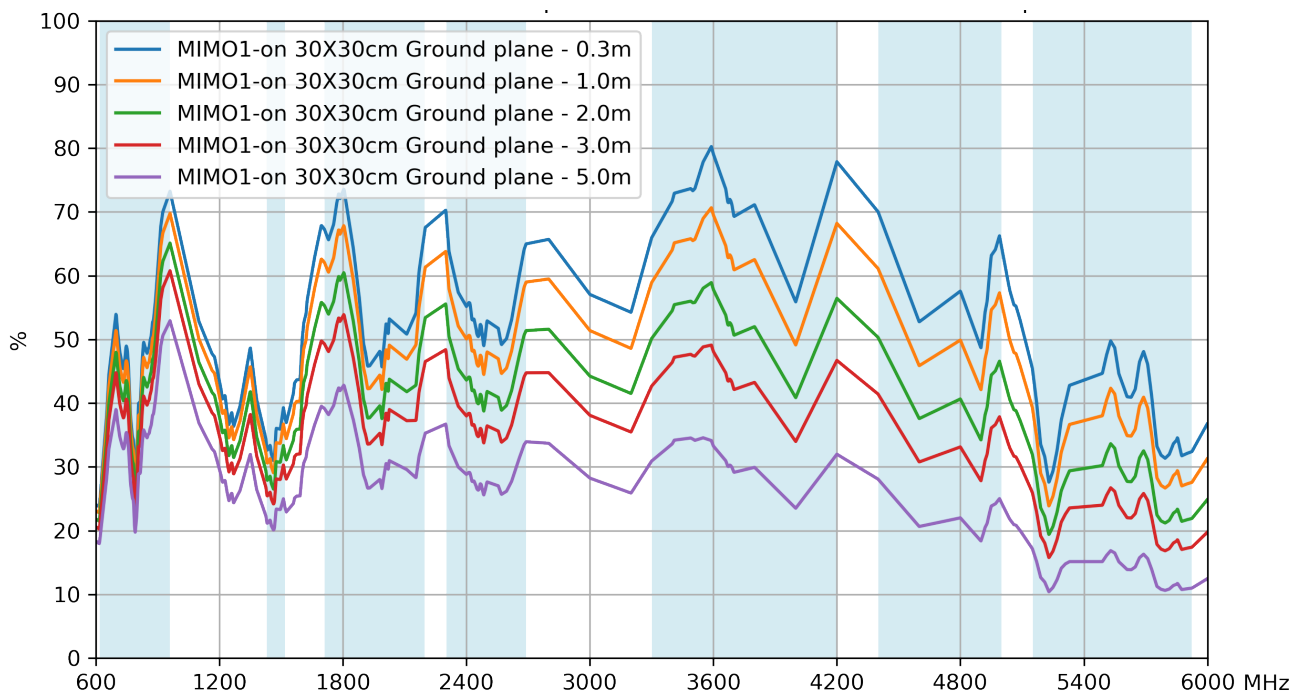
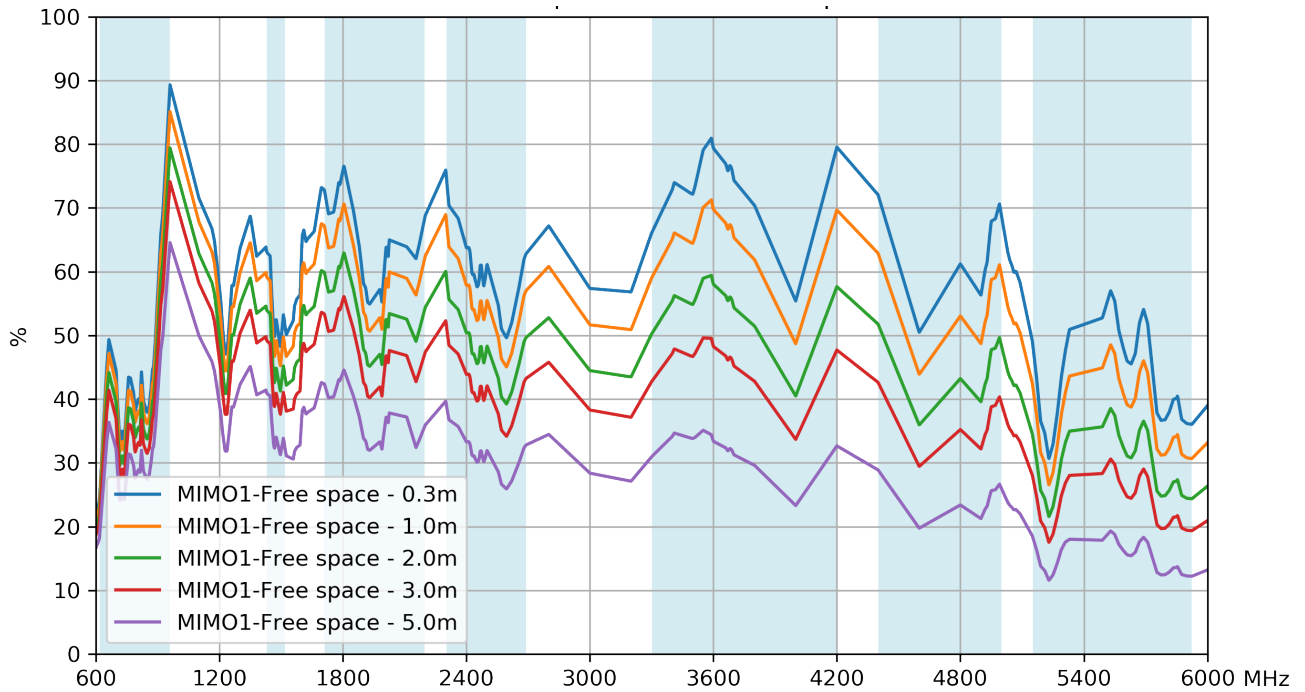

8.3 Efficiency – 5G/4G MIMO 2

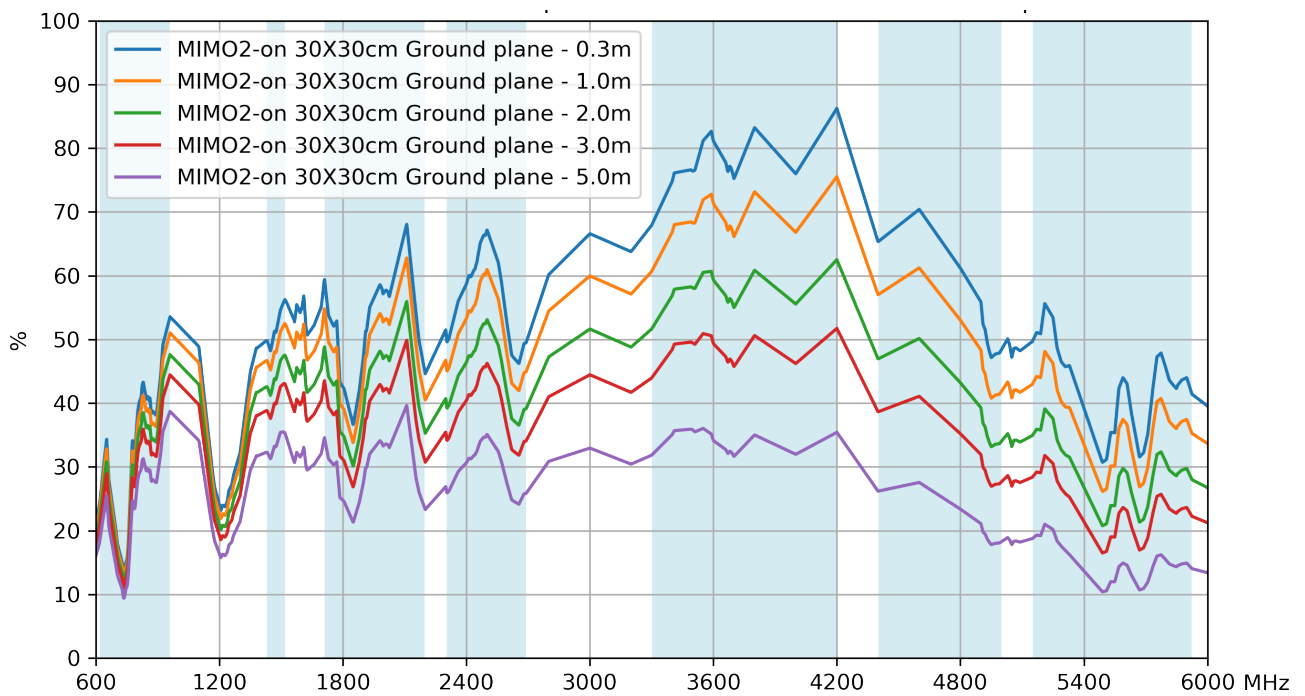
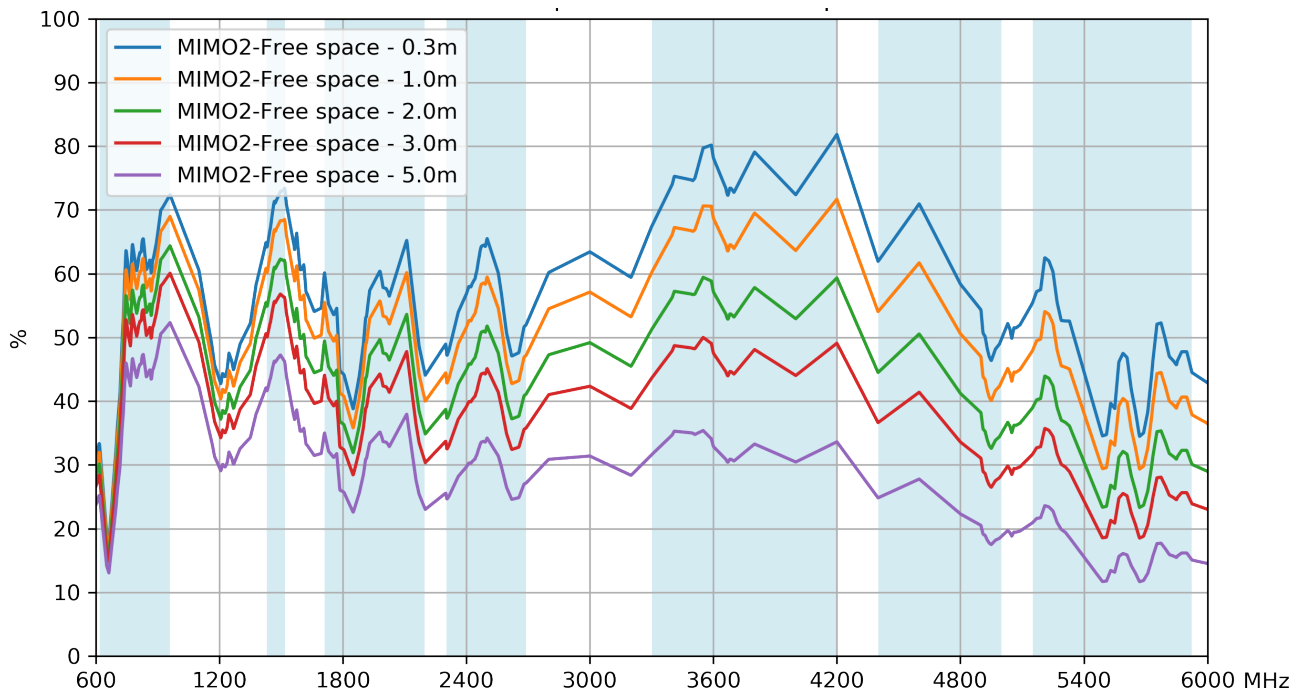

8.4 Average Gain – 5G/4G MIMO 1

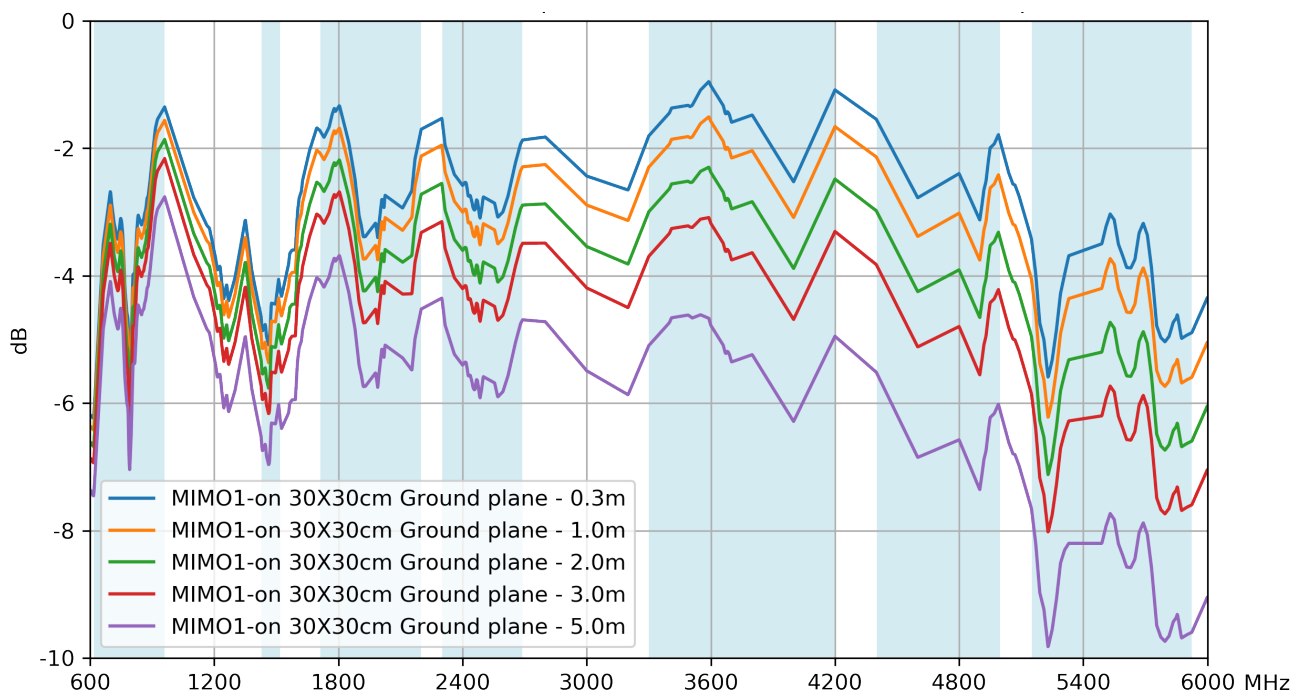
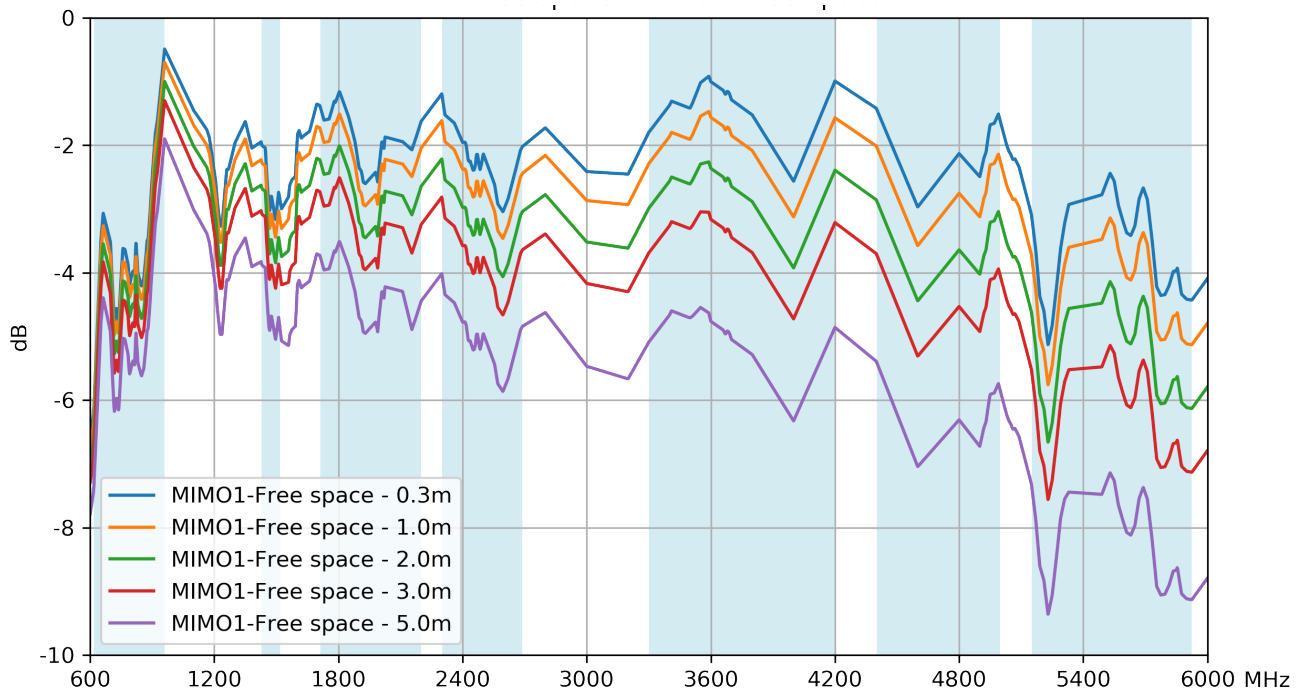

8.5 Average Gain – 5G/4G MIMO 2

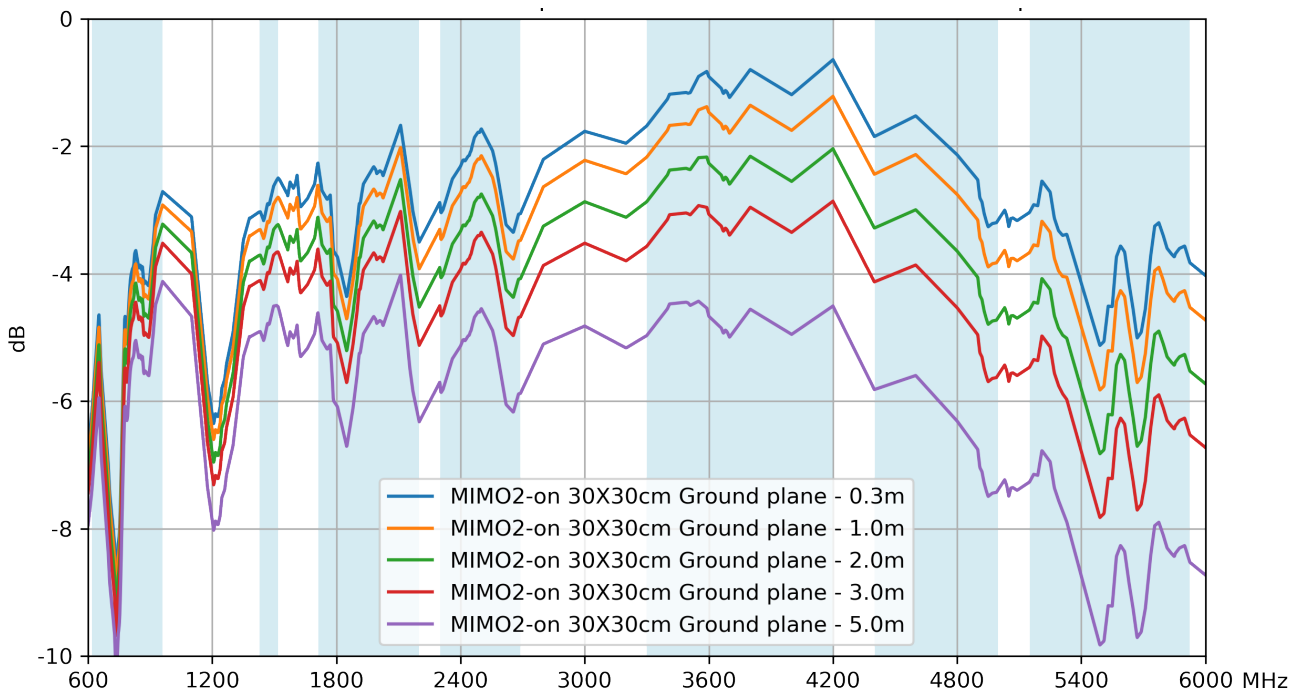
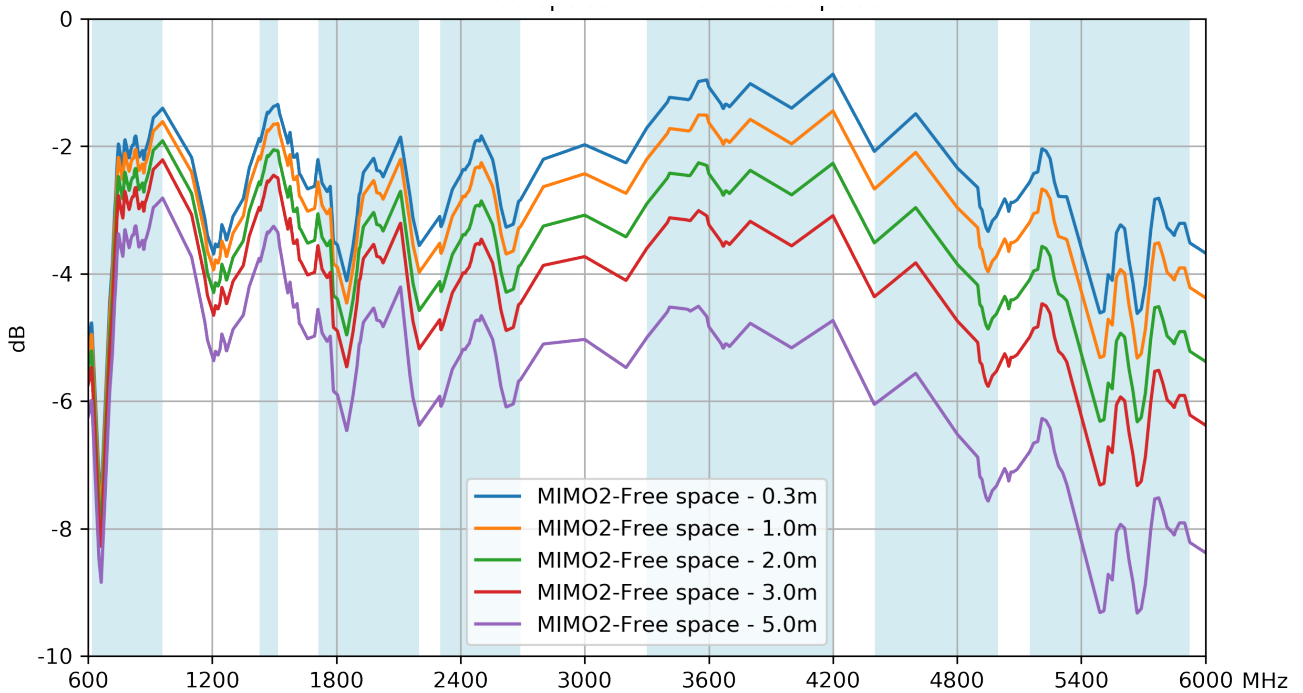

8.6 Peak Gain – 5G/4G MIMO 1

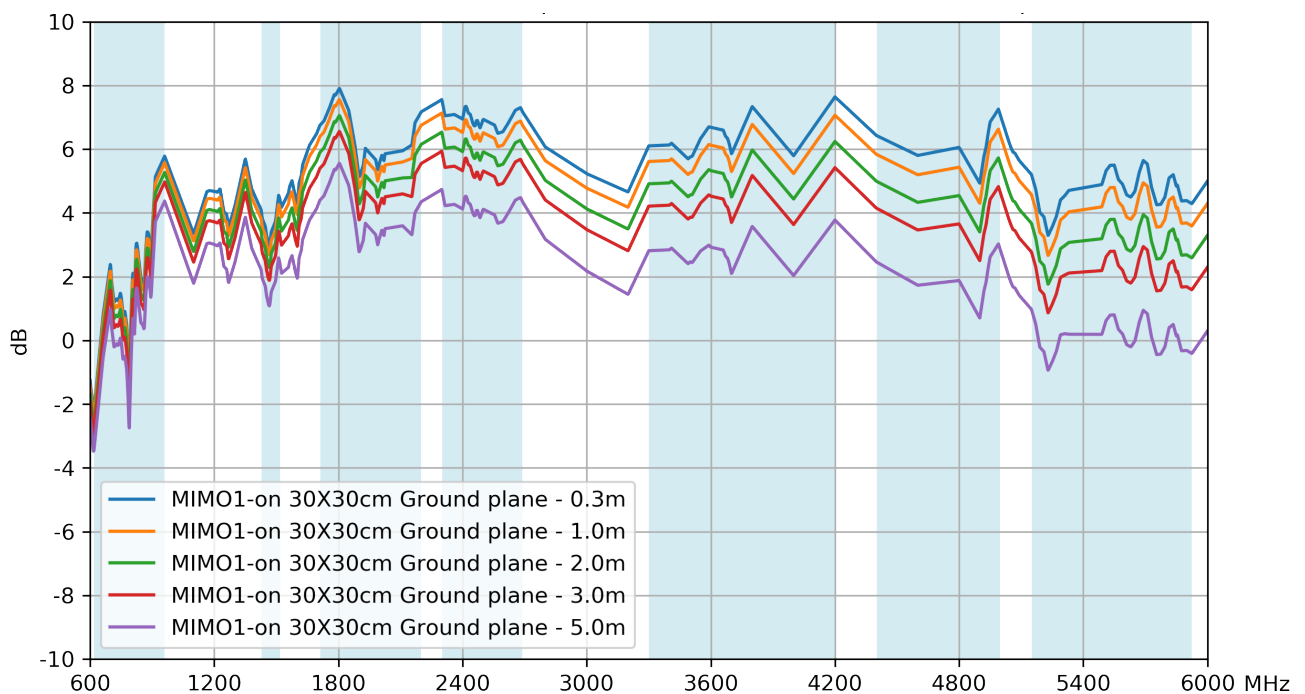
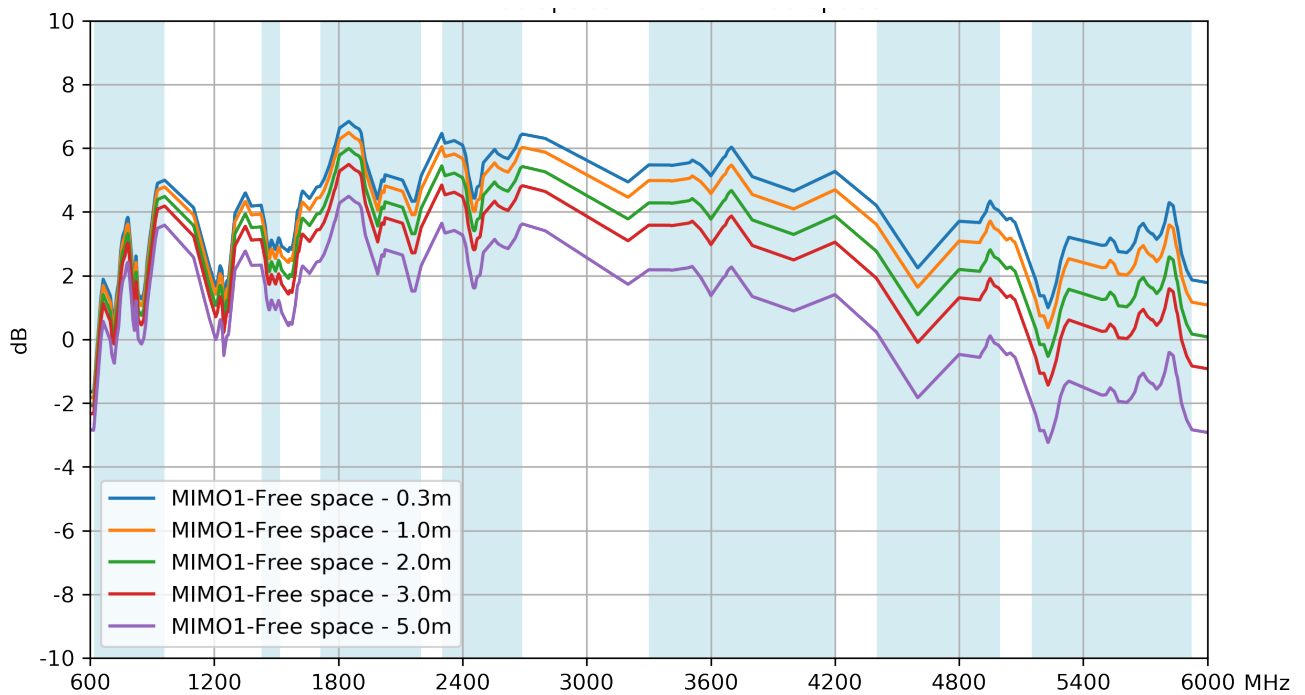

8.7 Peak Gain – 5G/4G MIMO 2

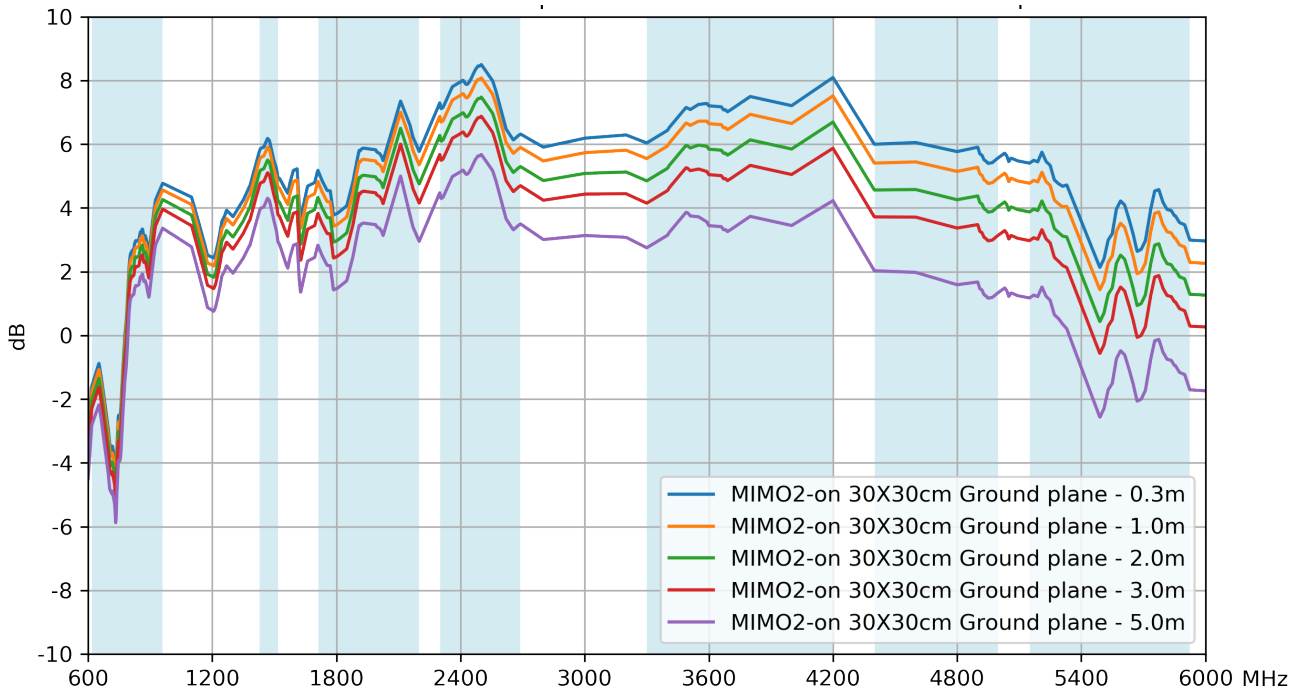
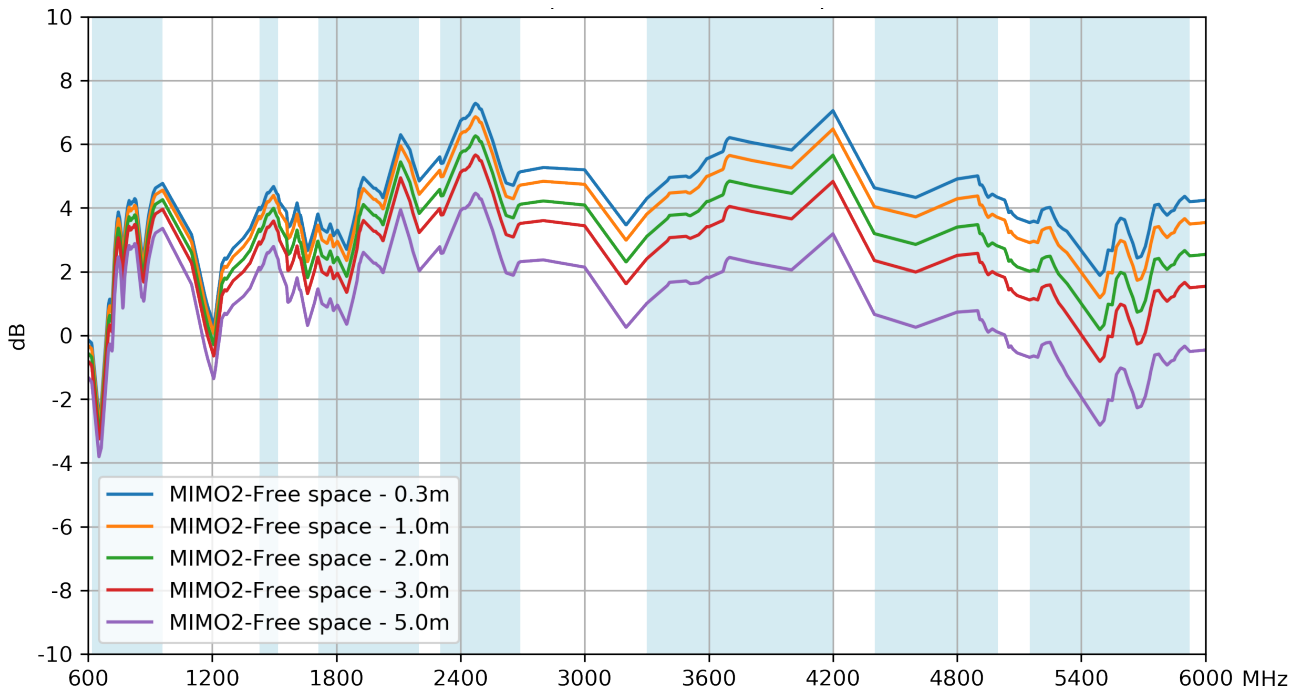

8.8 Comparison Table

5G/4G Antenna Free space											
Frequency (MHz)	5G NR Band 71	LTE700	GSM800 900	5G NR Band 1500	5G NR N66	LTE2600	5G NR N77	5G NR N78	5G NR N79	LTE5200	
	617-698	698-824	824-960	1427-1518	1710-2200	2300-2690	3300-4200	3300-3800	4400-5000	5150-5925	
Efficiency (%)											
MIMO1- Free space	0.3m	40.7	39.5	47.8	55.5	64.3	60.6	74.2	74.9	62.9	43.8
	1.0m	38.9	37.7	45.6	52.0	59.2	55.0	65.5	66.2	54.5	37.5
	2.0m	36.4	35.2	42.5	47.4	52.6	47.9	54.9	55.6	44.4	29.9
	3.0m	34.1	32.8	39.7	43.2	46.8	41.7	46.0	46.6	36.1	23.9
	5.0m	30.0	28.6	34.6	35.8	37.0	31.7	32.3	32.8	24.0	15.3
MIMO2- Free space	0.3m	25.7	56.7	64.2	69.7	52.9	57.4	74.8	74.6	53.2	47.5
	1.0m	24.6	54.0	61.1	65.3	48.7	52.1	66.1	65.9	46.1	40.6
	2.0m	23.1	50.4	57.0	59.4	43.3	45.4	55.4	55.3	37.6	32.5
	3.0m	21.6	47.1	53.2	54.1	38.5	39.5	46.4	46.4	30.6	26.0
	5.0m	19.0	41.0	46.4	44.9	30.4	30.0	32.6	32.6	20.3	16.7
Average Gain (dB)											
MIMO1- Free space	0.3m	-3.91	-4.03	-3.20	-2.56	-1.92	-2.17	-1.30	-1.25	-2.01	-3.58
	1.0m	-4.11	-4.24	-3.41	-2.84	-2.27	-2.59	-1.83	-1.79	-2.64	-4.26
	2.0m	-4.39	-4.54	-3.71	-3.24	-2.79	-3.19	-2.60	-2.55	-3.53	-5.24
	3.0m	-4.67	-4.84	-4.01	-3.65	-3.30	-3.79	-3.37	-3.32	-4.42	-6.21
	5.0m	-5.23	-5.44	-4.61	-4.46	-4.32	-4.99	-4.91	-4.84	-6.20	-8.16
MIMO2- Free space	0.3m	-5.90	-2.46	-1.93	-1.57	-2.76	-2.41	-1.26	-1.28	-2.74	-3.23
	1.0m	-6.09	-2.67	-2.14	-1.85	-3.12	-2.83	-1.80	-1.81	-3.36	-3.91
	2.0m	-6.37	-2.97	-2.44	-2.26	-3.63	-3.43	-2.57	-2.57	-4.25	-4.88
	3.0m	-6.65	-3.27	-2.74	-2.66	-4.14	-4.03	-3.33	-3.34	-5.14	-5.84
	5.0m	-7.21	-3.87	-3.34	-3.47	-5.16	-5.23	-4.87	-4.86	-6.92	-7.78
Peak Gain (dBi)											
MIMO1- Free space	0.3m	1.89	3.84	5.00	4.21	6.84	6.48	6.03	6.03	4.35	4.30
	1.0m	1.69	3.63	4.79	3.93	6.49	6.06	5.47	5.47	3.72	3.60
	2.0m	1.41	3.33	4.49	3.53	5.99	5.46	4.67	4.67	2.82	2.60
	3.0m	1.12	3.03	4.19	3.13	5.49	4.86	3.87	3.87	1.92	1.60
	5.0m	0.56	2.43	3.59	2.33	4.49	3.66	2.29	2.29	0.23	-0.40
MIMO2- Free space	0.3m	0.94	4.30	4.77	4.68	6.30	7.28	7.05	6.21	5.01	4.37
	1.0m	0.73	4.09	4.56	4.40	5.95	6.86	6.48	5.65	4.38	3.67
	2.0m	0.43	3.79	4.26	4.00	5.45	6.26	5.65	4.85	3.48	2.67
	3.0m	0.13	3.49	3.96	3.60	4.95	5.66	4.83	4.05	2.58	1.67
	5.0m	-0.47	2.89	3.36	2.80	3.95	4.46	3.19	2.45	0.78	-0.21

5G/4G Antenna on 30x30 cm Ground plane											
Frequency (MHz)	5G NR Band 71	LTE700	GSM800 900	5G NR Band 1500	5G NR N66	LTE2600	5G NR N77	5G NR N78	5G NR N79	LTE5200	
	617-698	698-824	824-960	1427-1518	1710-2200	2300-2690	3300-4200	3300-3800	4400-5000	5150-5925	
Efficiency (%)											
MIMO1-on 30X30cm Ground plane	0.3m	40.1	42.5	54.0	34.5	57.4	55.0	72.3	72.9	58.5	38.5
	1.0m	38.3	40.5	51.5	32.3	52.9	49.9	63.9	64.5	50.7	32.9
	2.0m	35.9	37.8	48.0	29.4	47.0	43.5	53.5	54.1	41.3	26.3
	3.0m	33.6	35.3	44.8	26.8	41.8	37.9	44.9	45.4	33.7	21.0
	5.0m	29.5	30.7	39.0	22.2	33.0	28.7	31.5	31.9	22.3	13.4
MIMO2-on 30X30cm Ground plane	0.3m	26.5	25.9	41.9	51.5	52.0	58.9	77.6	77.2	54.3	43.0
	1.0m	25.4	24.7	39.9	48.2	47.9	53.4	68.6	68.3	47.0	36.8
	2.0m	23.8	23.1	37.3	43.9	42.6	46.5	57.4	57.3	38.3	29.4
	3.0m	22.3	21.5	34.8	40.0	37.9	40.5	48.1	48.0	31.2	23.5
	5.0m	19.6	18.7	30.3	33.2	29.9	30.7	33.8	33.8	20.8	15.1
Average Gain (dB)											
MIMO1-on 30X30cm Ground plane	0.3m	-3.97	-3.72	-2.67	-4.63	-2.41	-2.60	-1.41	-1.37	-2.33	-4.14
	1.0m	-4.16	-3.93	-2.88	-4.91	-2.77	-3.02	-1.95	-1.91	-2.95	-4.82
	2.0m	-4.45	-4.23	-3.18	-5.32	-3.28	-3.62	-2.71	-2.67	-3.84	-5.80
	3.0m	-4.73	-4.53	-3.48	-5.72	-3.79	-4.22	-3.48	-3.43	-4.73	-6.77
	5.0m	-5.30	-5.13	-4.08	-6.53	-4.82	-5.42	-5.01	-4.96	-6.51	-8.72
MIMO2-on 30X30cm Ground plane	0.3m	-5.76	-5.86	-3.78	-2.88	-2.84	-2.30	-1.10	-1.12	-2.65	-3.67
	1.0m	-5.96	-6.07	-3.99	-3.17	-3.19	-2.72	-1.64	-1.66	-3.27	-4.35
	2.0m	-6.24	-6.37	-4.29	-3.57	-3.71	-3.32	-2.41	-2.42	-4.16	-5.31
	3.0m	-6.51	-6.67	-4.59	-3.98	-4.22	-3.92	-3.18	-3.19	-5.05	-6.28
	5.0m	-7.07	-7.27	-5.19	-4.79	-5.24	-5.12	-4.71	-4.71	-6.83	-8.21
Peak Gain (dBi)											
MIMO1-on 30X30cm Ground plane	0.3m	2.42	3.09	5.78	4.56	7.91	7.56	7.64	7.34	7.26	5.65
	1.0m	2.21	2.88	5.57	4.27	7.56	7.14	7.07	6.78	6.63	4.95
	2.0m	1.91	2.58	5.27	3.85	7.06	6.54	6.24	5.98	5.73	3.95
	3.0m	1.61	2.28	4.97	3.43	6.56	5.94	5.42	5.18	4.83	2.95
	5.0m	1.01	1.68	4.37	2.60	5.56	4.74	3.78	3.58	3.03	0.97
MIMO2-on 30X30cm Ground plane	0.3m	-0.87	2.88	4.77	6.19	7.35	8.50	8.09	7.50	6.05	5.75
	1.0m	-1.07	2.67	4.56	5.91	7.00	8.08	7.52	6.94	5.44	5.12
	2.0m	-1.34	2.37	4.26	5.51	6.50	7.48	6.69	6.14	4.58	4.22
	3.0m	-1.62	2.07	3.96	5.11	6.00	6.88	5.87	5.34	3.72	3.32
	5.0m	-2.17	1.47	3.36	4.31	5.00	5.68	4.23	3.86	2.03	1.52

Changelog for the datasheet

SPE-20-8-077 – MA351.A.BI.001

Revision: B (Current Release)

Date:	2021-01-28
Notes:	Replaced MA351 drawing
Author:	Erik Landi

Previous Revisions

Revision: A (Original First Release)

Date:	2020-07-02
Notes:	
Author:	Jack Conroy



TAOGLAS®

www.taoglas.com

