

APPROVED: _____
 DATE: _____ TITLE: _____

Rev	AWO #	Description	Date	Appr
-		RELEASED	2/20/21	

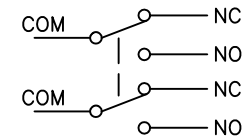

CIRCUIT DIAGRAM
 (DPDT) ON-MOMENTARY

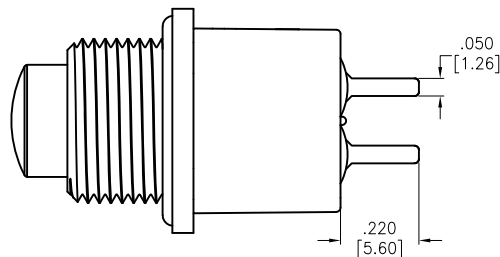
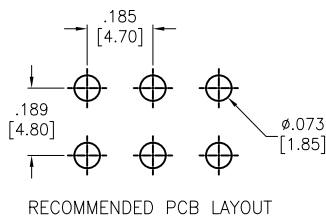
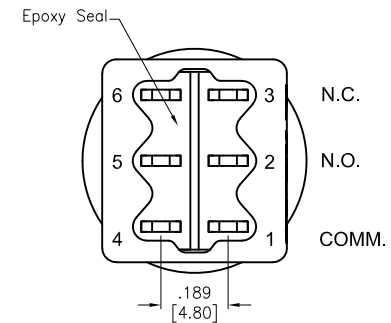
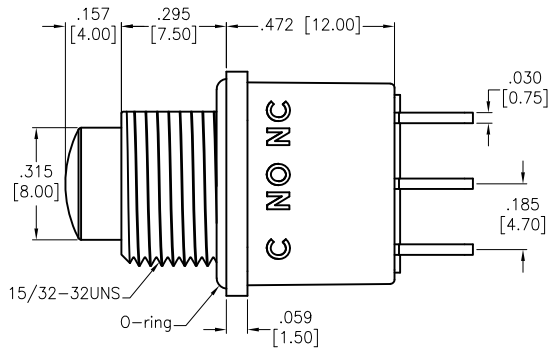
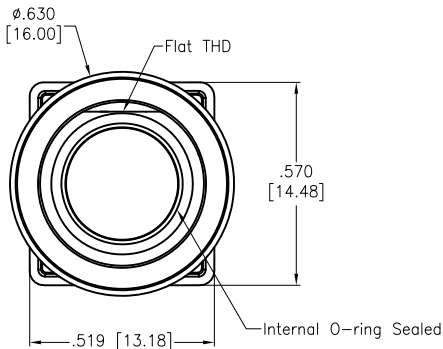
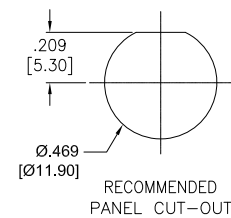
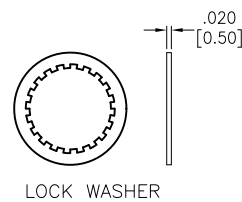
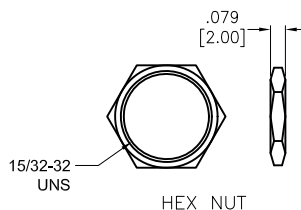

SPECIFICATIONS:

Material:
 Movable Contact: Copper Alloy, Silver Plated
 Terminal: Copper Alloy, Silver Plated
 Bushing&Plunger: Brass, Nickel Plated, Color: Black
Electrical:
 Voltage rating: 120VAC or 38VDC
 Current rating: 1 Amps
 Contact resistance: 10 mΩ max
 Insulation resistance: 1,000 Mohms min
 Dielectric withstanding voltage: 1,500V RMS @Sea level
Mechanical:
 Waterproof: IP68
 Temperature Rating:
 Operating temperature: -30°C to +85°C
 Environmental:
 Lead free, RoHS compliant



UNLESS OTHERWISE SPECIFIED ALL DIMENSIONS ARE INCHES [MM] TOLERANCES: EXCEPT AS NOTED			
INCHES		HOLES	
.X	± .10	Ø.X	± .10
.XX	± .020	Ø.XX	± .015
.XXX	± .015	Ø.XXX	± .010
APPROVALS		DATE	
DRAWN	LH	2/20/21	
CHECKED	AC	2/20/21	
APPROVED			

ADAM TECH 909 Rahway Avenue,
 Union, NJ 07083
 Phone: 908-687-5000
 Fax: 908-687-5710

TITLE
**SEALED PUSHBUTTON SWITCH, WATERPROOF-IP68
 DPDT, ON-MOMENTARY, SILVER PLATED, PCB TYPE**

SIZE X	PART NO. SW-PB10-DBB2QE-4	REV. -
REF: S00198T	SCALE: NTS	SHEET 1 OF 1