

M12U 4 POLE MALE

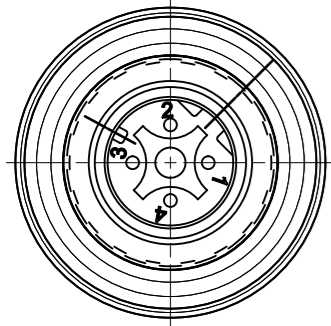

VIEW FROM THE FRONT SIDE

PIN	WIRE COLOR
1	YE
2	WH
3	OR
4	BU

SHIELD CONNECTED TO COUPLING NUTS

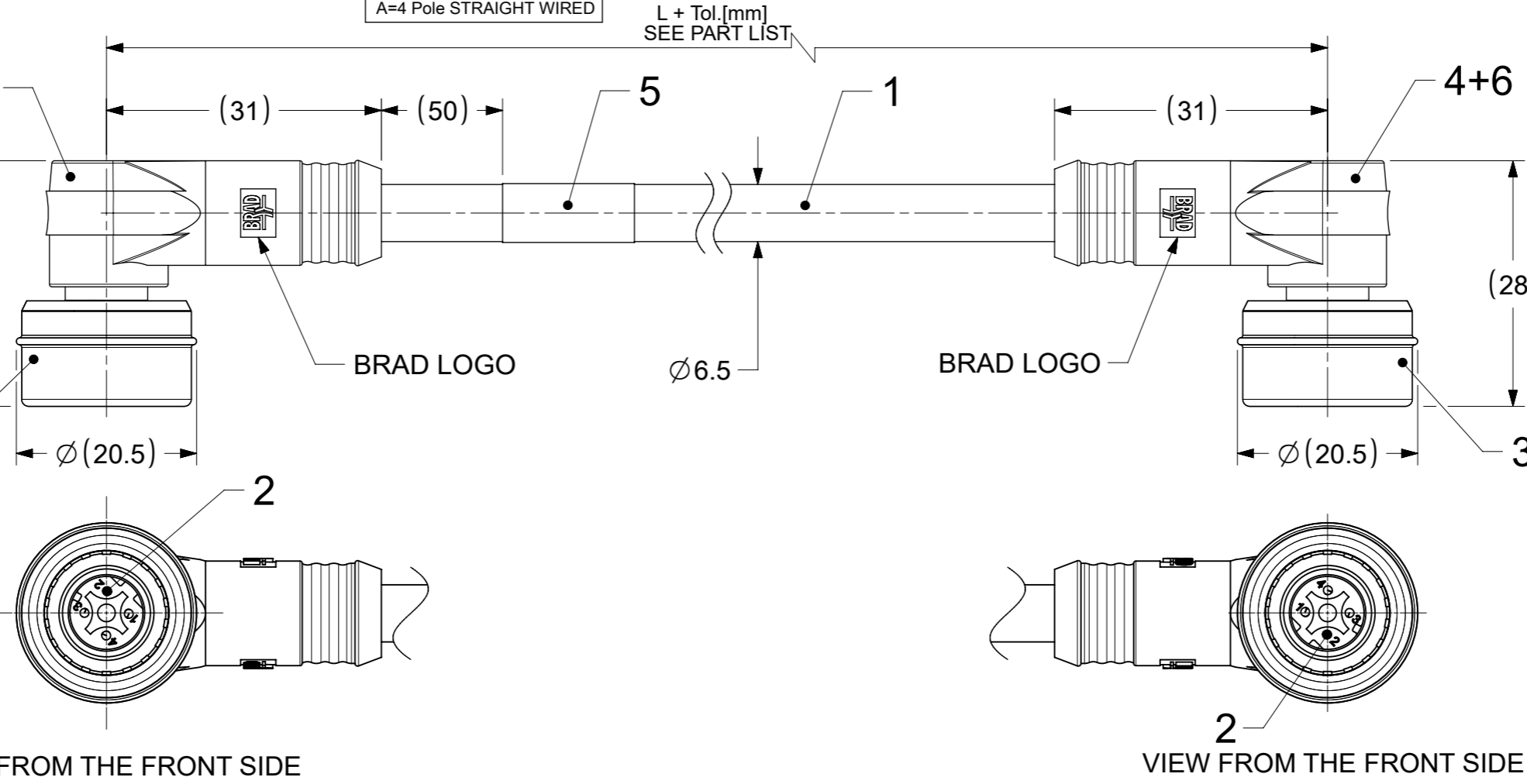

VIEW FROM THE FRONT SIDE

M12U 4 POLE MALE

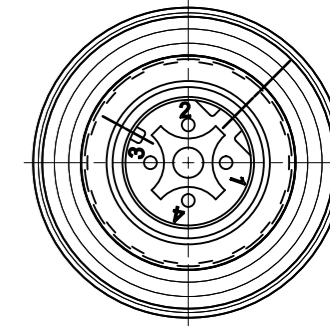

VIEW FROM THE FRONT SIDE

PIN	WIRE COLOR
1	YE
2	WH
3	OR
4	BU

SHIELD CONNECTED TO COUPLING NUTS

PART No. MATRIX

E W W A 0 6 3 1 0 M X X X

E=ETHERNET

HEADS:
W=M12 4-Pole Ultra Lock
D-Coding
W=M12 4-Pole Ultra Lock
D-Coding

HEADS STYLE:
063=MALE RA / MALE RA

UNITS:
M = METER
T=10x METER

LENGTH EXAMPLES:
005=0.5
010=1
150=15

WIRING TYPE:
A=4 Pole STRAIGHT WIRED

CABLE TYPE

L + Tol. [mm]
SEE PART LIST

PART LIST

MOLEX PN	ENGINEERING No	L+Tol. [mm]
1201080106	EWWA06310M010	1000 +56
1201080107	EWWA06310M020	2000 +89
1201080108	EWWA06310M050	5000+165
1201080109	EWWA06310M100	10000+317
1201080110	EWWA06310M150	15000+610

BOM

ITEM	QTY.	DESCRIPTION	MATERIAL	FINISH/COLOR
6	2	SHIELD CLOSURE CAP-90	BRASS	Ni-PLATED
5	1	LABEL	VINYL	YELLOW
4	-	MOULDING MATERIAL	TPU	BLACK
3	2	ULTRALOCK MALE ASSEMBLY	-	-
2	8	CONTACT MALE	BRASS	Au OVER Ni
1	-	ETHERNET CABLE-CAT5eES	PUR	GREEN

DOCUMENT STATUS	P1	RELEASE DATE	2022/04/22	06:35:59
-----------------	----	--------------	------------	----------

NOTES :

ACC. TO CAT5e ETHERNET STD.
MAX. VOLTAGE : 30V
MAX. CURRENT : 1.5A
IP RATING : IP67
TEMPERATURE RANGE : -20°C TO +75°C

FUNCTIONAL SYMBOLS	THIS DRAWING CONTAINS INFORMATION THAT IS PROPRIETARY TO MOLEX ELECTRONIC TECHNOLOGIES, LLC AND SHOULD NOT BE USED WITHOUT WRITTEN PERMISSION	CURRENT REV DESC:		molex																										
	<table border="1"> <tr> <th>FUNCTIONAL SYMBOLS</th> <th>DIMENSION UNITS</th> <th>SCALE</th> </tr> <tr> <td>$\nabla_A = 0$</td> <td>mm</td> <td>3:2</td> </tr> <tr> <td>$\nabla_E = 0$</td> <td colspan="2">GENERAL TOLERANCES (UNLESS SPECIFIED)</td> </tr> <tr> <td>$\nabla_V = 0$</td> <td colspan="2">ANGULAR TOL ± 1.0°</td> </tr> <tr> <td></td> <td>4 PLACES</td> <td>±</td> </tr> <tr> <td></td> <td>3 PLACES</td> <td>±</td> </tr> <tr> <td></td> <td>2 PLACES</td> <td>± 0.05</td> </tr> <tr> <td></td> <td>1 PLACE</td> <td>± 0.3</td> </tr> <tr> <td></td> <td>0 PLACES</td> <td>± 0.5</td> </tr> </table>	FUNCTIONAL SYMBOLS	DIMENSION UNITS		SCALE	$\nabla_A = 0$	mm	3:2	$\nabla_E = 0$	GENERAL TOLERANCES (UNLESS SPECIFIED)		$\nabla_V = 0$	ANGULAR TOL ± 1.0°			4 PLACES	±		3 PLACES	±		2 PLACES	± 0.05		1 PLACE	± 0.3		0 PLACES	± 0.5	EC NO: 703538 DRWN: SSM 2022/03/29 CHK'D: RSILLER 2022/04/22 APPR: RSILLER 2022/04/22 INITIAL REVISION: DRWN: SSM 2022/03/29 APPR: RSILLER 2022/04/22
FUNCTIONAL SYMBOLS	DIMENSION UNITS	SCALE																												
$\nabla_A = 0$	mm	3:2																												
$\nabla_E = 0$	GENERAL TOLERANCES (UNLESS SPECIFIED)																													
$\nabla_V = 0$	ANGULAR TOL ± 1.0°																													
	4 PLACES	±																												
	3 PLACES	±																												
	2 PLACES	± 0.05																												
	1 PLACE	± 0.3																												
	0 PLACES	± 0.5																												
DIVISIONAL SYMBOLS	DRAFT WHERE APPLICABLE MUST REMAIN WITHIN DIMENSIONS THIRD ANGLE PROJECTION 	DRAWING	SERIES	DOCUMENT NUMBER 1201080106	DOC TYPE PSD	DOC PART 000	REVISION A	MATERIAL NUMBER SEE PART LIST	CUSTOMER GENERAL MARKET	SHEET NUMBER 1 OF 1																				

6

5

4

3

2

1

PART NUMBER	ENGINEERING NO.	LENGTH ± TOLERANCE
1201080106	EWWA06310M010	3' 3" +2.19"/-0" [1M +55.6/-0 mm]
1201080108	EWWA06310M050	16' 4" +6.5"/-0" [5M +165.0/-0 mm]

AUX VIEW
SCALE 1:4

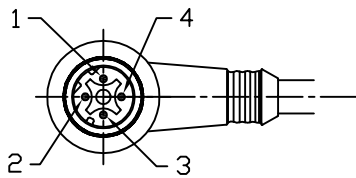
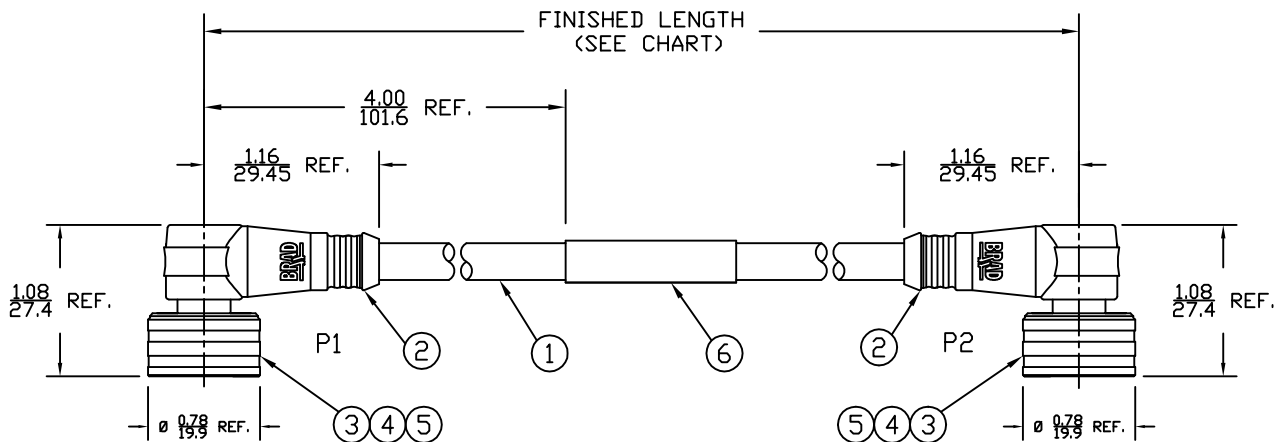
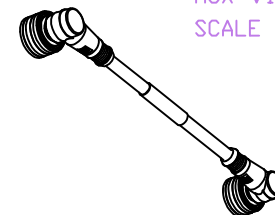

MALE- FACE VIEW

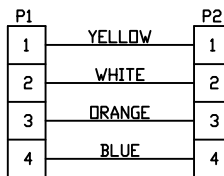

WIRING DIAGRAM

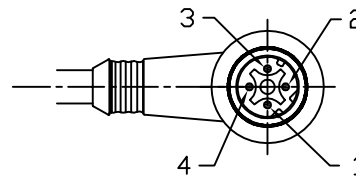

MALE- FACE VIEW

NOTES:

- 1) MATERIAL: SEE TABLE
- 2) FINISHES: SEE TABLE
- 3) CABLE: #22/4 SHIELDED PUR
- 4) ELECTRICAL DATA:
ACCORDING TO CAT5e ETHERNET STANDARD
MAX. VOLTAGE: 30V
MAX. CURRENT 1.5A
- 5) ENVIRONMENTAL:
PROTECTION IP67
TEMPERATURE RANGE: -20°C TO 75°C
- 6) WRAP LABEL IS MARKED WITH P/N, DATE CODE,
VOLTAGE & AMPERAGE.
- 7) ASSEMBLY IS RoHS COMPLIANT.

ITEM	QTY.	DESCRIPTION	MATERIAL	FINISH
6	1	LABEL	PLASTIC FILM	BLACK/YELLOW
5	2	INSERT	PUR	BLACK
4	8	PIN CONTACT	COPPER ALLOY	GOLD PLATED
3	2	M12 ULTRA-LOCK HEAD ASSY	BRASS	NICKEL
2	2	OVERMOLD	PUR	BLACK
1	1	ETHERNET CABLE-CAT5E	PUR JACKET	TEAL

SD RELEASE
EC NO: WELU2010-0005
7/9/09
DRWN: VOU
CHKD: BWOODMAN
APPR: JFMURPHY 2009/07/20

QUALITY SYMBOLS
▽=0
▽C=0

	GENERAL TOLERANCES (UNLESS SPECIFIED)	
	mm	INCH
4 PLACES	±----	±----
3 PLACES	±----	±.005
2 PLACES	±----	±.010
1 PLACE	±----	±.020
ANGULAR ± 1/2°		
DRAFT WHERE APPLICABLE MUST REMAIN WITHIN DIMENSIONS		

DIMENSION STYLE		SCALE	DESIGN UNITS	THIRD ANGLE PROJECTION
IN/MM		3:4	INCH	
DRAWN BY	DATE	TITLE		
VOU	2009/07/07	M12 ULCK CABLE ASSY 4P M/MP 90/90 D-CODE #22/4 SHIELDED PUR		
CHECKED BY	DATE	MOLEX INCORPORATED		
BWOODMAN	2009/07/31	DOCUMENT NO. SD-120108-012		
APPROVED BY	DATE	SHEET NO. 1 OF 1		
---	---	THIS DRAWING CONTAINS INFORMATION THAT IS PROPRIETARY TO MOLEX INCORPORATED AND SHOULD NOT BE USED WITHOUT WRITTEN PERMISSION		
MATERIAL NO.	SEE CHART			
SIZE A				

6

5

4

3

2

1

E

E

D

D

C

C

B

B

A

A